

# ***XTOOL***

## **User Manual**

### **PS70PRO Smart Diagnosis System**



Shenzhen Xtooltech Intelligent Co., LTD

Please read this user manual carefully before using the PS70PRO Smart Diagnosis System. When reading the manual, please pay attention to the words “Note” or “Caution”, and read them carefully for appropriate operation.

## TRADEMARKS

**XTOOL** is a registered trademark of Shenzhen Xtooltech Intelligent CO., LTD.

In countries where the trademarks, service marks, domain names, logos, and the name of the company are not registered, XTOOL claims that it still reserves the ownership of the unregistered trademarks, service marks, domain names, logos, and the company name. All other marks for the other products and the company's name mentioned in the manual still belong to the original registered company.

You may not use the trademarks, service marks, domain names, logo, and company name of XTOOL or other companies mentioned without written permission from the trademark holder.

XTOOL reserves the right to the final interpretation of this manual content.

# COPYRIGHT

Without the written consent of Shenzhen Xtooltech Intelligent Co., Ltd., any company or individual shall not copy or backup this operation manual in any form (electronic, mechanical, photocopying, recording, or other forms).

# DECLARATION

This manual is designed for the usage of the PS70PRO Smart Diagnosis System and provides operating instructions and product descriptions for users of the PS70PRO Smart Diagnostic system.

No part of this manual can be reproduced, stored in a retrieval system, or transmitted, in any form or by any means (electronic, mechanical, photocopying, recording, or otherwise), without the prior written permission of XTOOL.

Use the device only as described in this manual. XTOOL is not responsible for any consequences of violating the laws and regulations caused by using the product or its data information. XTOOL shall not be liable for any incidental or consequential damages or for any economic consequential damages arising from the accidents of individual users and the third parties, misuse or abuse of the device, unauthorized change or repair of the device, or the failure made by the user not to use

the product according to the manual.

The configuration, function, appearance and UI of this product involved in the user manual will continue to be optimized, and the manual may not be updated in time. Please refer to the actual product if there is any difference. The final interpretation right belongs to Shenzhen Xtooltech Intelligent Co., Ltd.

## **OPERATION INSTRUCTIONS**

For safe operation, please follow the instructions below:

- Keep the device away from heat or fumes when you use it.
- If the vehicle battery contains acid, please keep your hands and skin or fire sources away from the battery during testing.
- The exhaust gas of the vehicle contains harmful chemicals, please ensure adequate ventilation.
- Do not touch the cooling system components or exhaust manifolds when the engine is running due to the high temperatures reached.
- Make sure the car is securely parked, Neutral is selected or the selector is at P or N position to prevent the vehicle from moving when the engine starts.
- Make sure the (DLC) diagnostic link connector is functioning properly before starting the test to avoid damage to the Diagnostic Computer.

- Do not switch off the power or unplug the connectors during testing, otherwise, you may damage the ECU and/or the Diagnostic Computer.

## **CAUTIONS!**

- Avoid shaking or dismantling the unit as it may damage the internal components.
- Do not use hard or sharp objects to touch the LCD screen;
- Do not use excessive force;
- Do not expose the screen to strong sunlight for a long period.
- Please keep it away from water, moisture, high temperature, or very low temperature.
- If necessary, calibrate the screen before testing to ensure the accuracy of LCD performance.
- Keep the main unit away from strong magnetic fields.

## **AFTERSALES-SERVICES**

E-Mail: [aftersales-services@xtooltech.com](mailto:aftersales-services@xtooltech.com)

Tel: +86 755 21670995 or +86 755 86267858 (China)

Official Website: [www.xtooltech.com](http://www.xtooltech.com)

# Content

|                                |     |
|--------------------------------|-----|
| TRADEMARKS.....                | I   |
| COPYRIGHT.....                 | II  |
| DECLARATION.....               | II  |
| OPERATION INSTRUCTIONS.....    | III |
| CAUTIONS!.....                 | IV  |
| AFTERSALES-SERVICES.....       | IV  |
| CONTENT.....                   | I   |
| 1 GENERAL INTRODUCTION.....    | 1   |
| Tablet.....                    | 1   |
| Front View of Tablet.....      | 2   |
| Back View of Tablet.....       | 2   |
| Host Ports.....                | 3   |
| Technical Specifications.....  | 4   |
| Package Kit.....               | 5   |
| Main Unit.....                 | 5   |
| Other Accessories.....         | 5   |
| 2 GETTING STARTED.....         | 6   |
| Activation.....                | 6   |
| Main Interface.....            | 9   |
| Operation system.....          | 9   |
| Diagnosis system entrance..... | 11  |
| Function Buttons.....          | 13  |
| Navigation Buttons.....        | 14  |
| Notification Bar.....          | 15  |

|                           |    |
|---------------------------|----|
| 3 UPDATE.....             | 16 |
| 4 DIAGNOSIS.....          | 18 |
| Vehicle Connection.....   | 18 |
| Diagnosis.....            | 19 |
| Vehicle Selection.....    | 20 |
| Basic functions.....      | 21 |
| 5 SPECIAL FUNCTIONS.....  | 28 |
| 5.1 OIL RESET.....        | 29 |
| 5.2 EPB.....              | 31 |
| 5.3 SAS.....              | 33 |
| 5.4 DPF.....              | 36 |
| 5.5 BMS RESET.....        | 41 |
| 5.6 THROTTLE.....         | 44 |
| 5.7 INJECTOR CODING.....  | 46 |
| 5.8 GEARBOX MATCH.....    | 49 |
| 5.9 GEAR LEARNING.....    | 50 |
| 6 SETTINGS.....           | 52 |
| Language.....             | 52 |
| Units.....                | 54 |
| My Workshop Info.....     | 55 |
| Firmware Information..... | 56 |
| About.....                | 57 |
| 7 REPORT.....             | 58 |
| Report.....               | 58 |
| Replay.....               | 60 |

|  |    |
|--|----|
| File Manager.....  | 61 |
| 8 REMOTE ASSISTANCE.....                                 | 62 |
| 9 FACTORY RESET.....                                     | 65 |
| 10 FAQ.....  | 71 |
| Q1: Failed to generate diagnosis report.....             | 71 |
| Q2: How to print diagnosis report.....                   | 73 |
| Q3: Failed to extract files.....                         | 73 |
| Q4: Mailbox supported.....                               | 74 |
| Q5: How to make an appointment for remote support.....   | 74 |
| Q6: How to generate and upload diagnostic log files..... | 74 |
| Q7: How to switch the language to non-English.....       | 74 |
| Q8: Failed to diagnose vehicle.....                      | 75 |
| Q9: Failed to activate or register.....                  | 75 |
| Q10: Failed to turn on when charging.....                | 75 |
| Q11: Failed to open the diagnosis app.....               | 76 |
| Q12: Failed update APP.....                              | 76 |



# 1 GENERAL INTRODUCTION

The XTOOL PS70PRO smart diagnostic system is an advanced flatbed scanning tool based on the Android operating system. It supports multi-language switching and is suitable for different countries and regions. The advantage of this obd2 scanner is not only its comprehensive functions, including complete system diagnosis, all obd2 functions, various reset functions (IMMO / EEPROM adapter / EPB (Electronic Parking Brake) reset / oil light reset / SAS (Steering Angle Sensors) reset / TPS (Throttle Position Sensor) matching / Injector coding / ABS (Anti-block system) bleed / gearbox matching / gear learning / electronic pump actuation / disable transport mode / SRS (Supplemental Restrgint System) reset / exhaust post-processing / BMS matching / air suspension / cylinder / TPMS reset / tire refit / headlight adjustment / windows Initialization/seat matching/DIY mode) can also achieve faster and more accurate diagnosis.

## TABLET

The main unit of the PS70PRO is the tablet, which has a built-in VCI module, which can be directly connected to the tablet and the car with the main test line, without the need to connect to an external VCI box via Bluetooth.

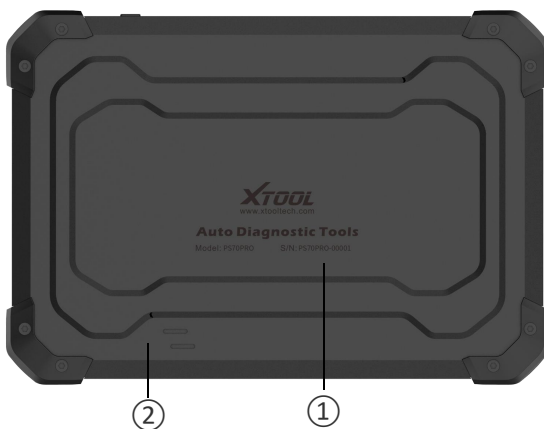
## ***FRONT VIEW OF TABLET***



*Fig 1-1 Sample of Tablet Front View*

The front of the main unit is a touchable display screen, you can use your fingers to operate on the screen to complete the car diagnosis.

## ***BACK VIEW OF TABLET***

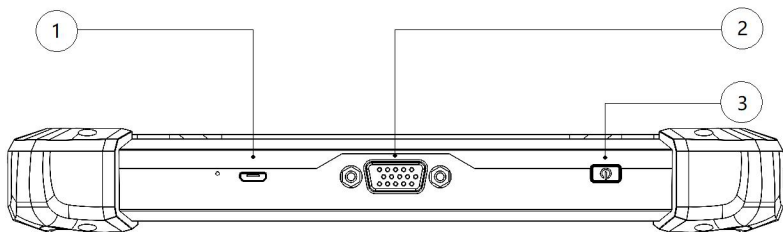


*Fig 1-2 Sample of Tablet Back View*

The product model and S/N are laser-engraved on the back of the display tablet, and the small hole at the bottom is the Loudspeaker.

- ① **Nameplate:** Display basic information such as S/N and model etc.
- ② **Loudspeaker:** external sound can be played, supporting the playback of music, etc.

## ***HOST PORTS***



*Fig 1-3 Sample of Host Ports on Tablet*

- ① **Micro USB:** Battery charge or data synchronization with PC or DC.
- ② **DB15 Port:** This port is used to connect to the main test cable.
- ③ **Power Button:** Long press to power on or off. In the power-on state, short press the button to make the device enter the sleep mode.

# TECHNICAL SPECIFICATIONS

*Table 1-1 Specification*

| Item                         | Description   |
|------------------------------|---|
| <b>Operating System</b>      | Android   |
| <b>Processor</b>             | Quad-core 1.6GHz Processor  |
| <b>Memory</b>                | 32GB  |
| <b>Display</b>               | 7.0-inch touch screen with 1024×600 resolution                        |
| <b>Connectivity</b>          | <ul style="list-style-type: none"><li>● USB</li><li>● Wi-Fi</li></ul> |
| <b>Sensors</b>               | Gravity sensor, light sensor  |
| <b>Auto Input/Output</b>     | Microphone, speaker   |
| <b>Power and Battery</b>     | 4000mAh, 3.7V lithium-polymer battery                                 |
| <b>Power Voltage</b>         | 5V  |
| <b>Power Consumption</b>     | 8W  |
| <b>Operating Temperature</b> | -10~50°C (14~122°F)   |
| <b>Storage Temperature</b>   | -20~60°C (-4~140°F)   |
| <b>Humidity</b>              | <90%  |
| <b>Dimension (L*W*H)</b>     | 218*150*29mm  |

# PACKAGE KIT

## ***MAIN UNIT***

- **Tablet 1 pcs**

## ***OTHER ACCESSORIES***

- **OBD II -16 Connector (1 pcs)**

\* Used to connect the main cable and the car.

- **Main Test Cable (1 pcs)**

\*The main cable is used to connect the Tablet to the connector.

- **USB Cable (1 pcs)**

\*Connect the table to the PC or DC power adapter.

- **Power Adapters**

- a) DC5V 2A charger 1pcs
- b) AC Charger Adapter 1 pcs (EU Standard)
- c) AC Charger Adapter 1 pcs (US Standard)

\*Used to connect a USB cable to an external DC power port for charging.

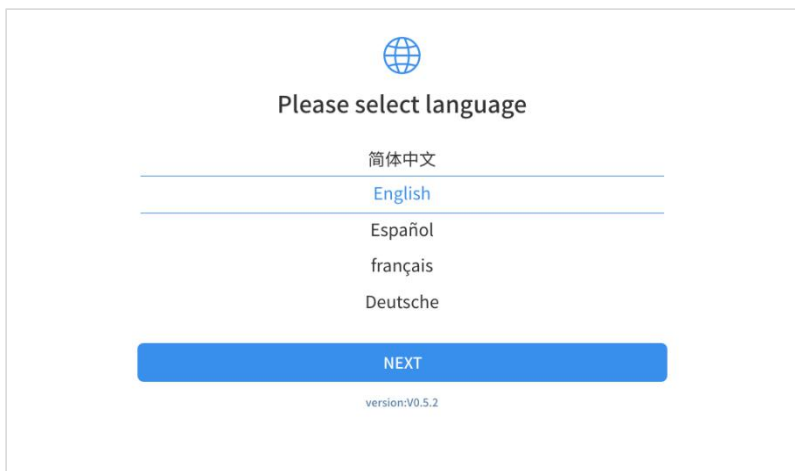
- **User Manual(1 pcs)**

\*Tool operation instructions.

# 2 GETTING STARTED

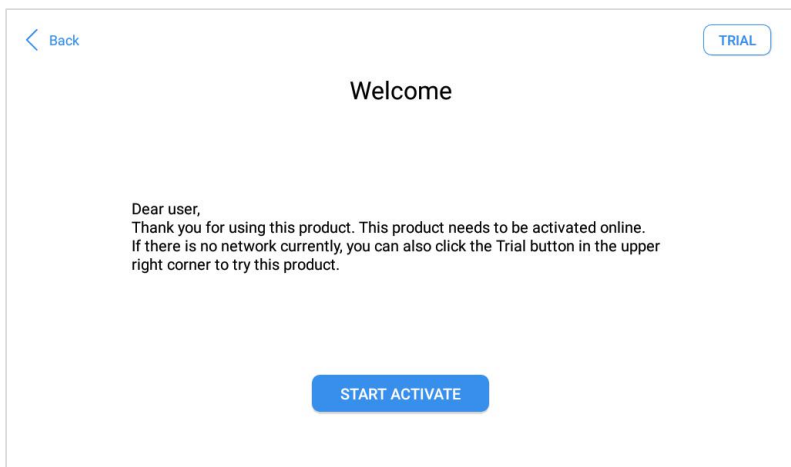
## ACTIVATION

After first-time users press and hold the power button to turn on the system, the system will automatically enter the guide process and request to select the language for the operating system.



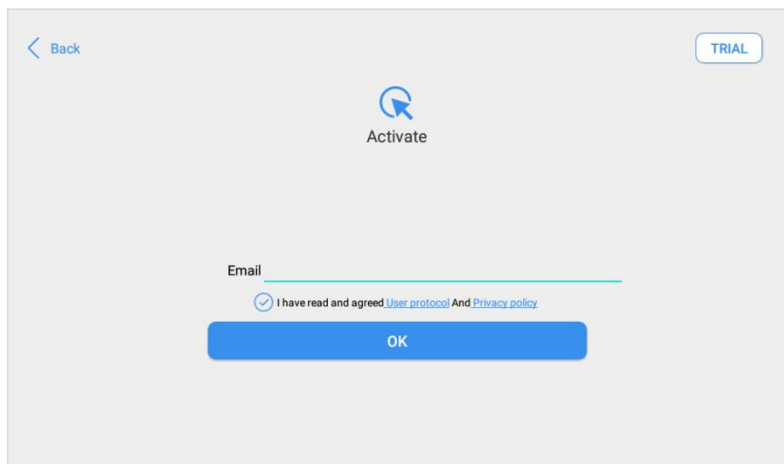
*Fig 2-1 Select Language before Activation*

After setting the system language, you will enter the activation page, as shown in the figure below. You can also click the "Trial" button in the upper right corner to try it out before activation.



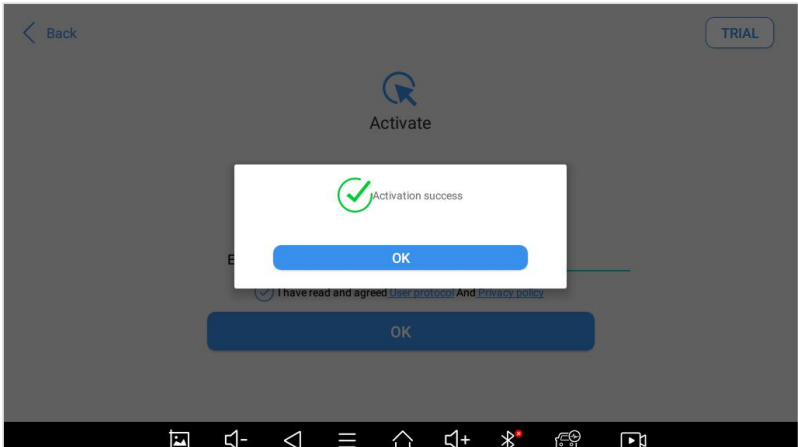
*Fig 2-2 Sample of Start Activate*

Click **Start Activate** to enter the activation page, as shown below:



*Fig 2-3 Input your Email Address in the Field*

A pop-up window showing **Activation Success** indicates that you have completed the first boot setup, click **OK** to enter the diagnostic system and start using the device.



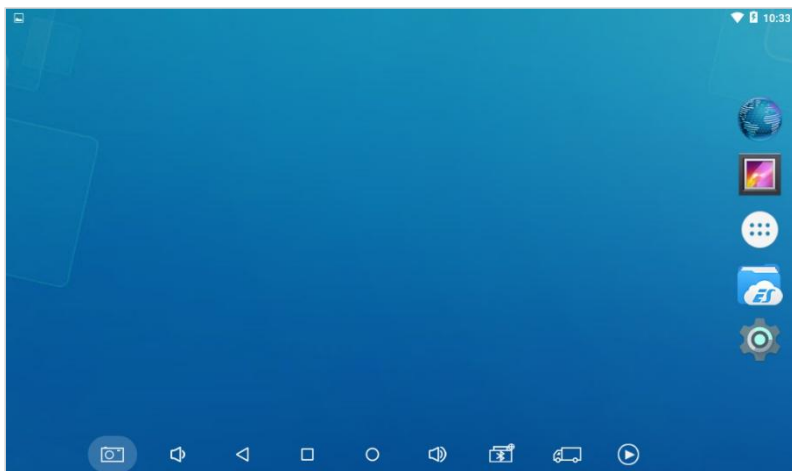
*Fig 2-4 Sample of Activation Success*



# MAIN INTERFACE

## ***OPERATION SYSTEM***






As shown in the figure below, this interface is the main page of the operating system of the device. You can also return to this interface at any time by clicking 【○】 on the bottom navigation bar.



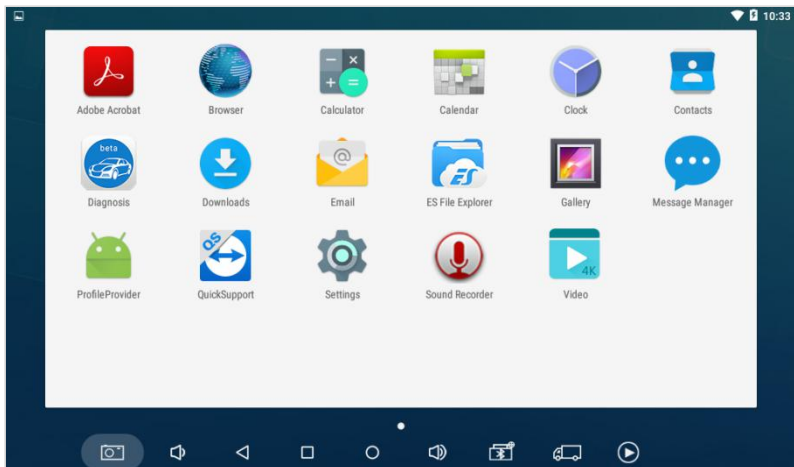
*Fig 2-5 Sample of Main Page*

The icons on the right, from top to bottom, are browser, photo album, application square, file manager, system settings, as shown below:

Table 2-1

| Items   | Descriptions                |
|---|-----------------------------|
|  | Browser                     |
|  | Album                       |
|  | Application Square          |
|  | File Explorer               |
|  | Settings for Android System |

- a) **Browser:** Click on the browser icon to enter the browser to view the official website of XTOOL or search for other information.
- b) **Gallery:** Click the **Gallery** icon to enter the album to quickly view the pictures or screenshots stored in the device. You can select the picture you need, click the share button on the upper right, and send the picture to your mobile phone or PC via Bluetooth or USB connection
- c) **Application Square:** This function is suitable for power balance after replacing and repairing the cylinder. You can remove or add apps here.



*Fig 2-6 Sample of Application Square*

d) **ES File Explorer:**

You can manage APP, music, files, pictures, etc. in the device in this function, and you can also use Local/Home/Cleaner to clean up files.

***DIAGNOSIS SYSTEM ENTRANCE***

Once activated, you will automatically enter the diagnostic system with the following main screen. Tap on the diagnosis application button on the menu, the main interface will be shown as below:











*Fig 2-7 Sample of Smart Diagnosis System Homepage*

The main interface is mainly composed of **Function Buttons** and **Navigation Buttons**. The touch screen navigation is menu-driven, and you can quickly access functions by clicking on the option title and answering the dialogue window. A detailed description of the menu structure can be found in the next section **Function Buttons**.

## ***FUNCTION BUTTONS***

The following table briefly describes each function button










*Table 2-2*

| <b>Item</b>   | <b>Description</b>  |
|---|---|
|    | Quickly access to the vehicle system to identify the vehicle VIN code   |
|    | Enter to select a vehicle   |
|    | Includes special functions for car diagnosis  |
|    | You can view the vehicle diagnostic report  |
|    | In case of failure, you can control the diagnostic equipment remotely   |
|    | Users can upgrade the available software with one click   |
|  | Users can set the language, unit, Bluetooth, repair shop information, also can view information about this software |
|  | Users can view more extended functions  |

## **NAVIGATION BUTTONS**

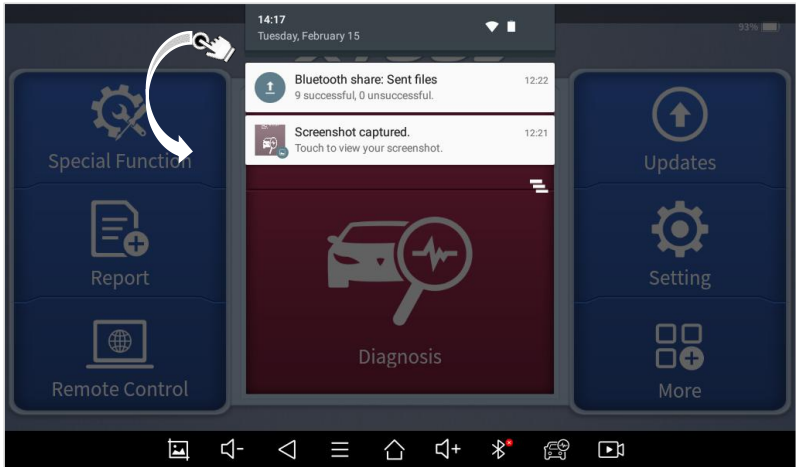
Instructions for operating the navigation bar buttons at the bottom of the screen, as described in the table below:

*Table 2-3*

| <b>Items</b>  | <b>Descriptions</b>   |
|---|---|
|    | Back to the previous interface                                  |
|    | Back to the main interface of the Android system                |
|    | Shows recently used applications                                |
|    | Press for screenshot  |
|    | Increase volume   |
|    | Display bluetooth statu   |
|  | Decrease volume   |
|  | Click here to return to the diagnostic vehicle models interface |
|  | Screen recorder   |

## ***NOTIFICATION BAR***

Slide down to open the notification bar. Users can adjust the brightness of the screen when they need it, and you can also connect Wi-Fi and so on.



*Fig 2-8 Sample of NOTIFICATION BAR*

# 3 UPDATE

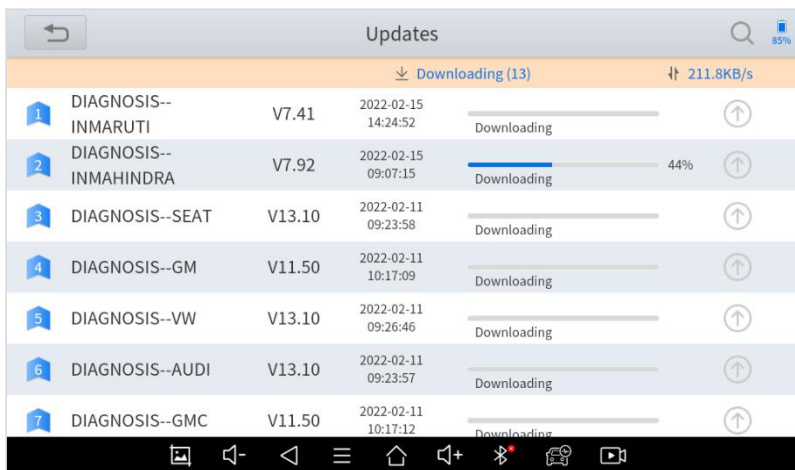
After activating the device, please update the software in "Update" first. The device will pull all currently supported software packages, and you can download them as needed. ALL software updates directly via the Internet. To access the update application, open the diagnosis application and click UPDATE, shown as below:



*Fig 3-1 Sample of Update*

When downloading software, the page will display the number of software being downloaded and the current network speed above the software list, as followed





*Fig 3-2 Sample of Updating*

**\*Xtool Devices support bilingual upgrades, usually English and the local language. To switch other languages, please contact your dealer.**

# 4 DIAGNOSIS

The diagnostic application can read ECU information, read and clear DTC and check live data and freeze frames. The diagnosis application can access the electronic control unit (ECU) of various vehicle control systems, including the engine, transmission, anti-lock braking system (ABS), airbag system (SRS), and perform kinds of actuation tests.

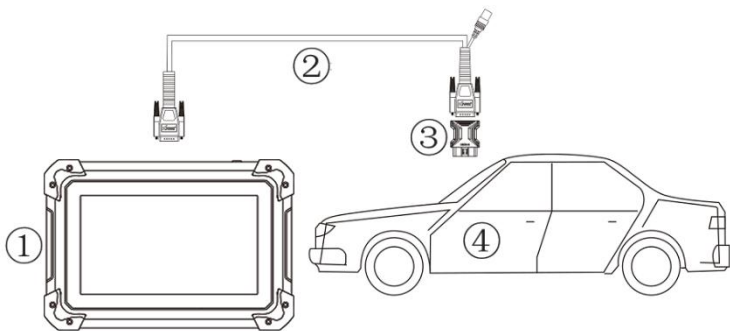
## VEHICLE CONNECTION

The diagnosis operation needs to connect the PS70PRO smart diagnosis system to a vehicle first so that the tablet can establish correct vehicle communication. Please perform the following steps:

- 1 Turn on the tablet;
- 2 Connect cables and tablet in the following order: ①→②→③→④;
- 3 Switch on the ignition and tap on the diagnosis application to test vehicles.

Since the display panel and the VCI box are integrated, to communicate with the vehicle, the OBD II -16 connector must be connected to the main test cable, and the vehicle data connector should be inserted into the DLC usually located under the vehicle dashboard.

The connection method is shown in the figure below:



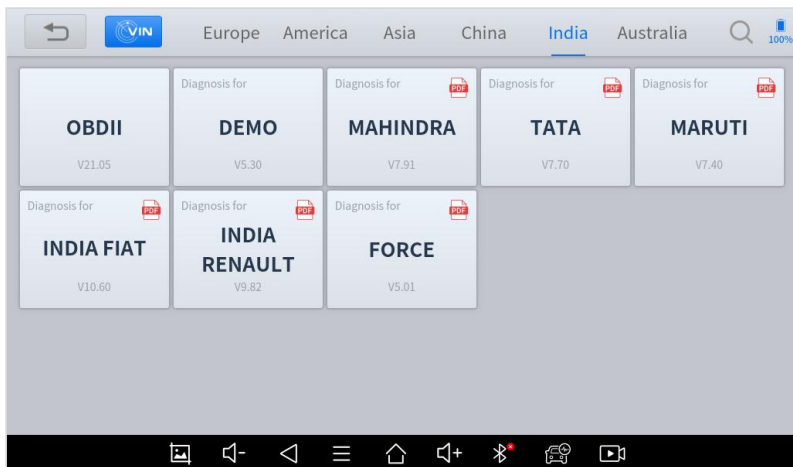
*Fig 4-1 Sample of How to Connect Vehicle & Device*

- ① Tablet
- ② Main Test Cable
- ③ OBDII-16 Connector
- ④ Vehicle

**\*Caution:** Please make sure all the cables are connected tightly; The vehicle's DLC is not always located under the dash; for the location of the DLC, please refer to the vehicle's user manual.

## DIAGNOSIS

After the tablet device is properly connected to the vehicle, the system can begin vehicle diagnosis. You can select the vehicle model that needs to be diagnosed according to the area, as shown below:



*Fig 4-2 Sample of Europe Vehicles*

**\*Note:** OBD II supports reading the common fault codes in the engine; DEMO, a demonstration program. Click this button to experience and learn the operation process of the diagnostic function.

## ***VEHICLE SELECTION***

PS70PRO Smart Diagnosis System supports 2 ways to access the vehicle diagnosis system.

You can select "**Automatic Detection**" or "**Manual Selection**" to enter the diagnosis system. Automatic detection will automatically identify the vehicle's VIN code, and then read the information of your target diagnostic object. If you choose "manual selection", then you can start the diagnosis by selecting the vehicle brand, year, and model of the vehicle.

Enter "manual selection", you can also diagnose the car according to the system according to your needs after selecting the model.

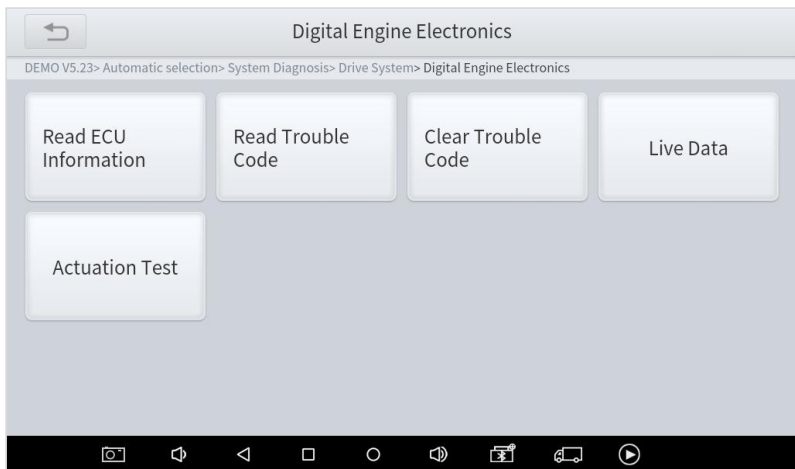


*Fig 4-3 Sample of Diagnosis Methods*

## ***BASIC FUNCTIONS***

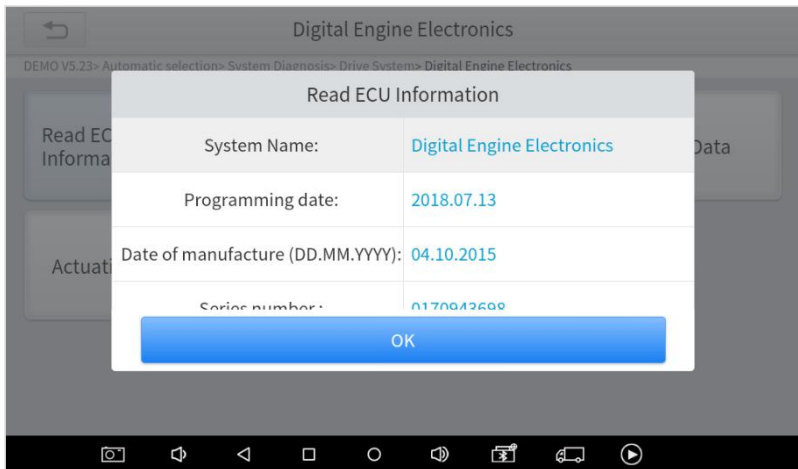
The diagnosis system supports 5 basic diagnosis functions, as follows:

- **Read ECU**
- **Read /Clear DTCs**
- **Read Live Data**
- **Actuation Test**
- **Freeze Frame**



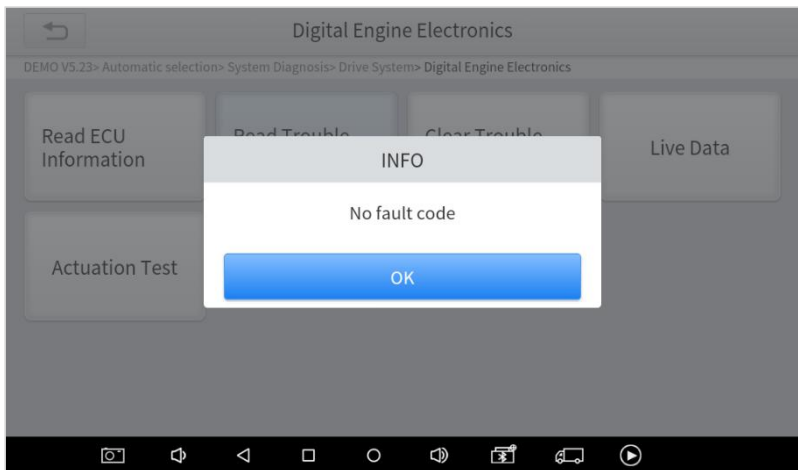
*Fig 4-4 Sample of Basic Functions*

**Read ECU Information:** This function is to read ECU version information, which is the equivalent of "**System Identification**" or "**System information**" in some electronic control systems, all mean to read ECU related software and hardware versions, models, and production date of diesel engine, part number, etc. It is convenient for us to make a record in the maintenance process, and it also makes data feedback and management easier.



*Fig 4-5 Sample of ECU Info*

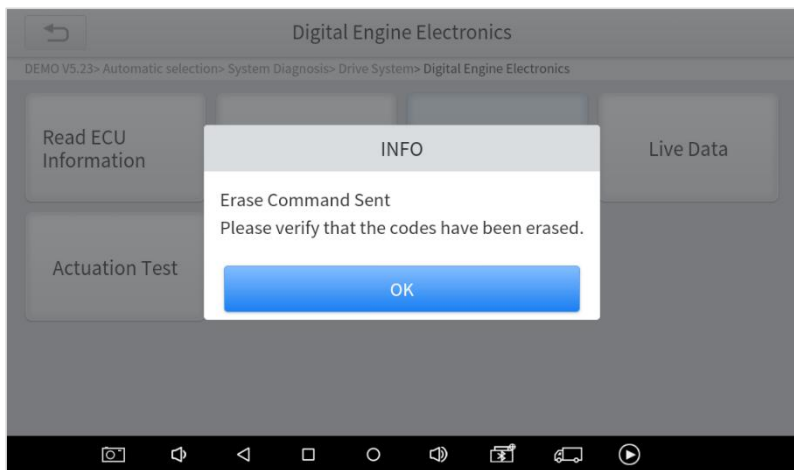
**Read Trouble Code:** Read trouble codes stored in ECU.



*Fig 4-6 Sample of reading Codes*

**\*Tip:** In the process of diagnosis, if the device shows “**System is OK**” or “**No Trouble Code**”, it means there is no related trouble code stored in ECU or some troubles are not under the control of ECU, most of these troubles are mechanical system troubles or executive circuit troubles, it is also possible that signal of the sensor may bias within limits, which can be judged in Live Data.

**Clear Trouble Code:** It allows to clear current and historical trouble codes memory in ECU, under the premise that all the troubles are eliminated.



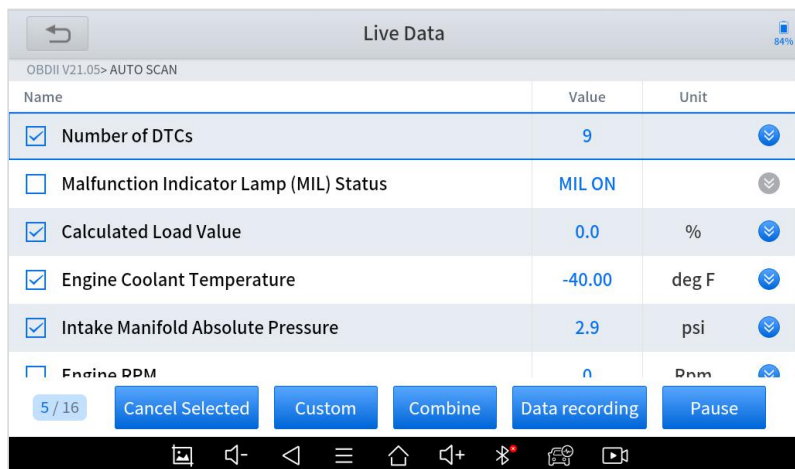
*Fig 4-7 Sample of Clear Codes*

The trouble codes can't be erased without eliminating all the troubles, which will cause the diagnostic tool to always read the trouble code because the code will always be saved in ECU.



Suggestion: users should better not clear trouble codes, we need to record the trouble details after reading the code, which is provided as a reference for maintenance. After dealing with troubles, there will be no trouble code when we re-read.

**Read Live Data:** that is to read the parameters of running engine, such as oil pressure, temperature, engine speed, fuel oil temperature, coolant temperature, intake air temperature, etc. Based on these parameters, we can judge directly where the problem lies, which helps to narrow the scope of maintenance. For some vehicles, during their actual operation, the problems such as performance characteristics offset, sensitivity reduction, can be judged in live data.



| Name  | Value  | Unit  |
|---|--------|-------|
| <input checked="" type="checkbox"/> Number of DTCs                    | 9      |       |
| <input type="checkbox"/> Malfunction Indicator Lamp (MIL) Status      | MIL ON |       |
| <input checked="" type="checkbox"/> Calculated Load Value             | 0.0    | %     |
| <input checked="" type="checkbox"/> Engine Coolant Temperature        | -40.00 | deg F |
| <input checked="" type="checkbox"/> Intake Manifold Absolute Pressure | 2.9    | psi   |
| <input type="checkbox"/> Engine RPM                                   | 0      | Rpm   |

Fig 4-8 Sample of Live Data

**【Combine】** supports merging multiple line graphs  
\*Select up to 5 curves at a time

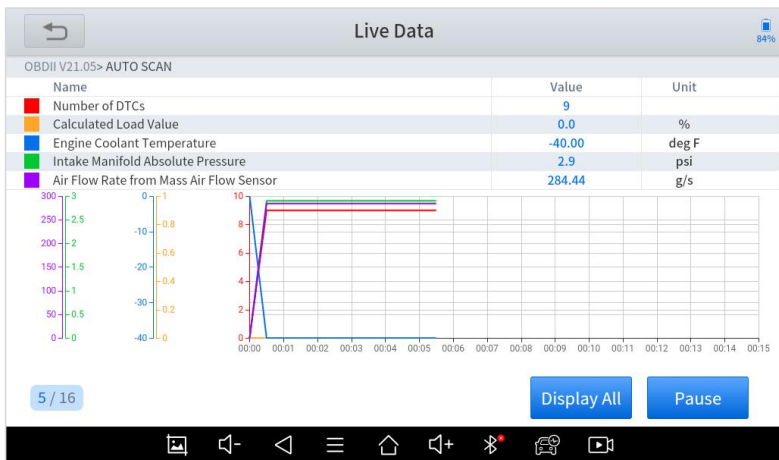


Fig 4-9 Sample of Multi-line Chart

In the process of diagnosis, if the device shows “**System is OK**” or “**No Trouble Code**”, it means there is no related trouble code stored in ECU or some troubles are not under the control of ECU, most of these troubles are mechanical system troubles or executive circuit troubles, it is also possible that signal of the sensor may bias within limits, which can be judged in Live Data.

**Actuation Test:** Actuation test, also known as bidirectional control, is a generic term used to describe sending and receiving information between one device and another. This function is used mainly to judge whether these actuating components of the engine are working properly.

The vehicle engineers responsible for designing computer control systems programmed them so a scan tool could request information or command a module to perform specific tests and functions. Some manufacturers refer to bidirectional controls as functional tests, actuator tests, inspection tests, system tests, or the like. Reinitialization and reprogramming also can be included in the list of bidirectional controls.

This function allows the device to send information to and receive information from, vehicle control modules. For example, in the case of OBD II generic information Mode 1 (which relates to data parameters), the scan tool user initiates a request for information from the powertrain control module (PCM), and the PCM responds by sending the information back to the scan tool for display. Most enhanced scan tools also can actuate relays, injectors, and coils, perform system tests, etc. Users could check the individual part to see what is working properly by actuation test.

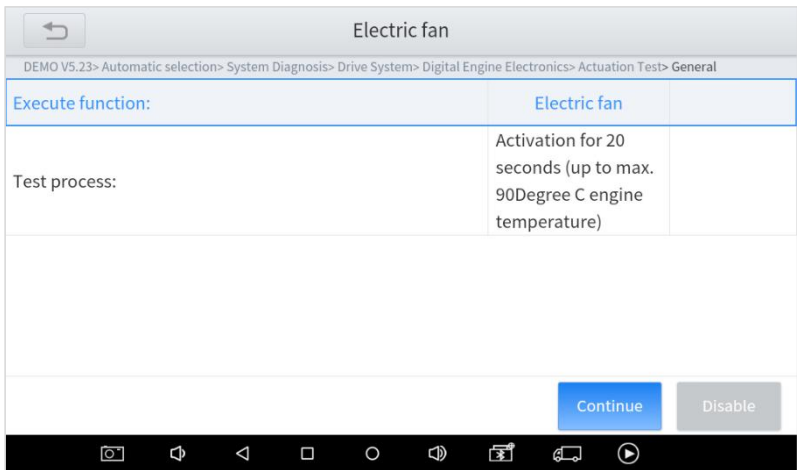


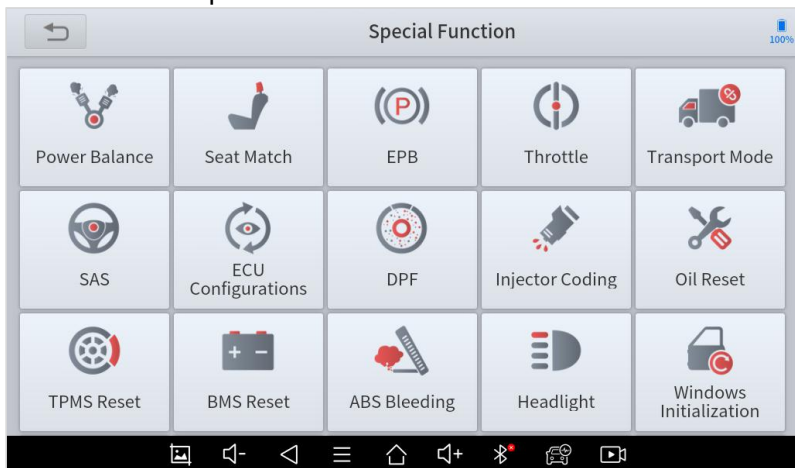
Fig 4-10 click on Continue to complete the test

**Freeze Frame:** When the signal of the sensor is abnormal, the ECU will save the data at that moment of failure to form a freeze-frame. It is usually used to analyze the reasons that may lead to car failures.

The living data items supported by vehicles of different brands are not the same, so the freeze frames displayed when diagnosing vehicles of different brands may also be different. Some vehicles may not have the option of a freeze-frame which means that the model does not support this function.

# 5 SPECIAL FUNCTIONS

The PS70PRO Smart Diagnosis System supports 23 commonly used special reset functions, allowing you to quickly access your vehicle system for various scheduled services, maintenance, and reset performance, eliminating the need to reset after resolving common problems. This user manual lists some of the commonly used special reset services for your reference. The special functions interface is shown as below:



*Fig 5-1 Sample of Special Functions*

## **Note**

All special functions supported by PS70PRO are subject to the actual special functions displayed on the device. Due to the limitation of screenshots, the special functions shown in this picture are not complete.

## 5.1 OIL RESET

Reset the Engine Oil Life System, which calculates the optimum oil life change interval based on the vehicle's driving conditions and climate. The oil life reminder must be reset each time the oil is changed so that the system can calculate when the next oil change is required.

This function can be performed in the following cases:

- If the service lamp is on, you must provide service for the car. After service, you need to reset the driving mileage or driving time so that the service lamp turns off and the system enables the new service cycle.
- After changing engine oil or electric appliances that monitor oil life, you need to reset the service lamp.

***The operation guidelines of the Oil Reset function are shown as below:***

1. Enter the **Oil Reset** menu and choose relevant models according to the vehicle being tested.
2. Follow the instructions displayed and press **OK** after completing the instructions shown.

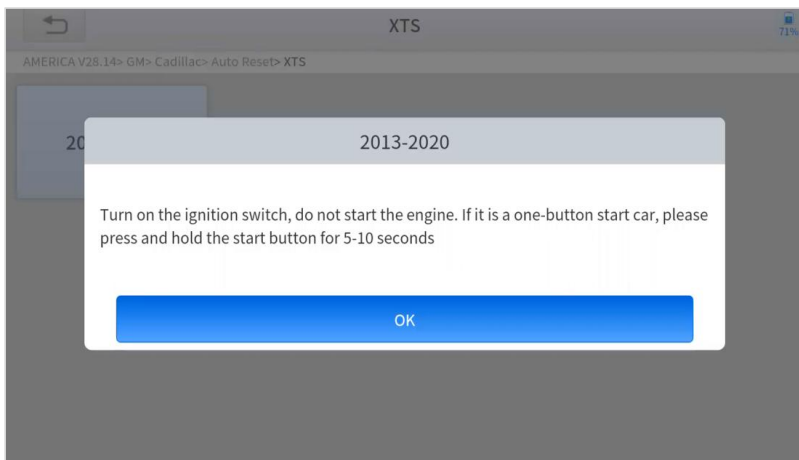


Figure 5-2 Sample of oil reset function (screen 1)

3. Enter **Maintenance mileage reset** menu.
4. Input reasonable value of mileage and press **OK**.

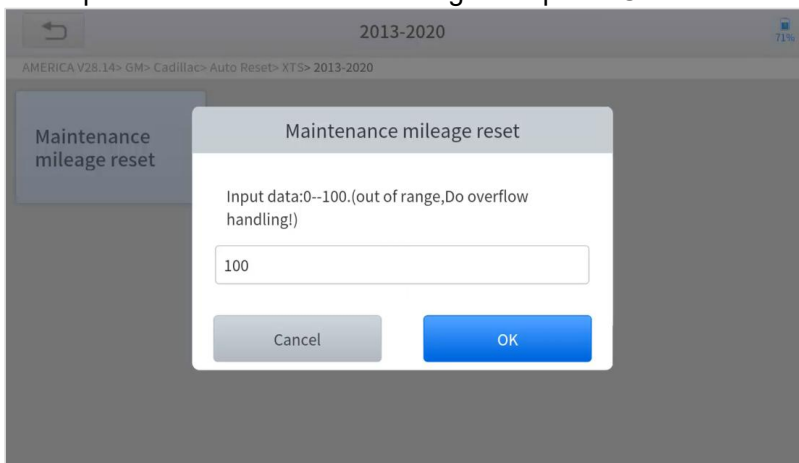


Figure 5-3 Sample of oil reset function (screen 2)

5. Message of '**Reset success**' displayed when Oil Reset function has successfully performed.

## 5.2 EPB

Electronic Parking Brake (EPB) System reset is a popular special function. You can use this function to reset the electronic parking brake system and brake pads, which also supports the brake pad replacement (retraction, release of the brake pump), G-sensor, and body angle calibration. This function has multiple uses and can safely and effectively maintain the electronic brake system. These applications include deactivating and activating brake control systems, assisting in controlling brake fluid, opening and closing brake pads, setting brakes after replacing brake discs or brake pads, etc.

1. If the brake pad wears the brake pad sense line, the brake pad sense line will send a signal to the onboard tablet asking for replacing the brake pad. After replacing the brake pad, you must reset the brake pad. Otherwise, the car alarms.
2. Reset must be performed in the following cases:
  - The brake pad and brake pad wear sensor are replaced.
  - The brake pad indicator lamp is on.
  - The brake pad sensor circuit is short, which is recovered.
  - The servo motor is replaced.

***The operation guidelines of the EPB function are shown as below:***

1. Enter the **EPB** menu and choose relevant models according to the vehicle being tested.
2. Follow the instructions displayed and press **YES** after completing the instructions shown.

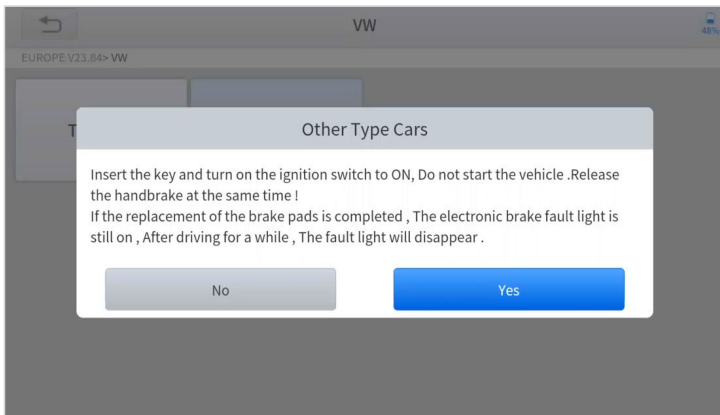


Figure 5-4 Sample of EPB function (screen 1)

3. Enter the **Enter maintenance mode** menu and release the handbrake brake. And press **OK** after completing the instructions shown.

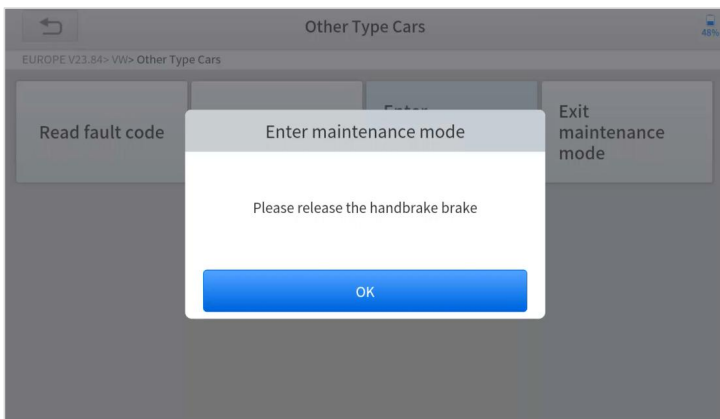


Figure 5-5 Sample of EPB function (screen 2)

4. Wait until the message of **'Successful operation'** pops up. And press **OK** to exit the menu.
5. Enter the **Exit maintenance mode** menu and wait until the message of **"Successful operation"** pops up.



## 5.3 SAS

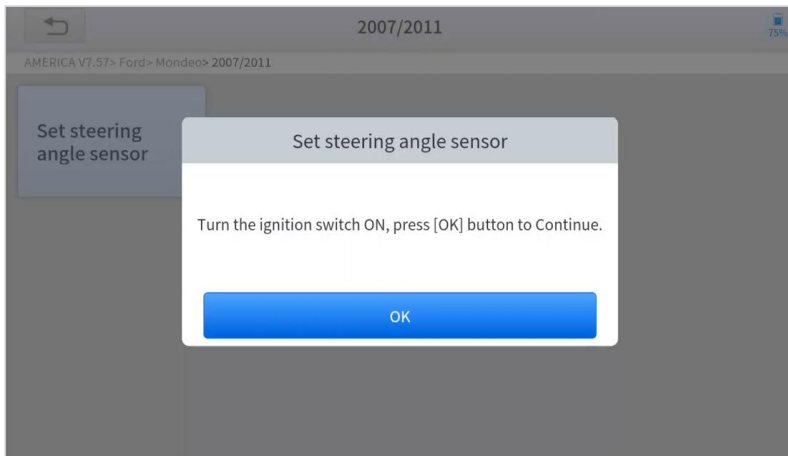
Steering Angle Sensors (SAS) System Calibration permanently stores the current steering wheel position as the straight-ahead position in the SAS EEPROM. Therefore, the front wheels and the steering wheel must be set exactly to the straight-ahead position before calibration. In addition, the VIN is also read from the instrument cluster and stored permanently in the SAS EEPROM. On successful completion of calibration, the SAS fault codes will be automatically cleared.

To reset the steering angle, you need to first find the relative zero point position for the car to drive in a straight line. Taking this position as a reference, the ECU can calculate the accurate angle for left and right steering.

After replacing the steering angle position sensor, replacing steering mechanical parts (such as steering gearbox, steering column, end tie rod, steering knuckle), performing four-wheel alignment, or recovering the car body, you must reset the steering angle.

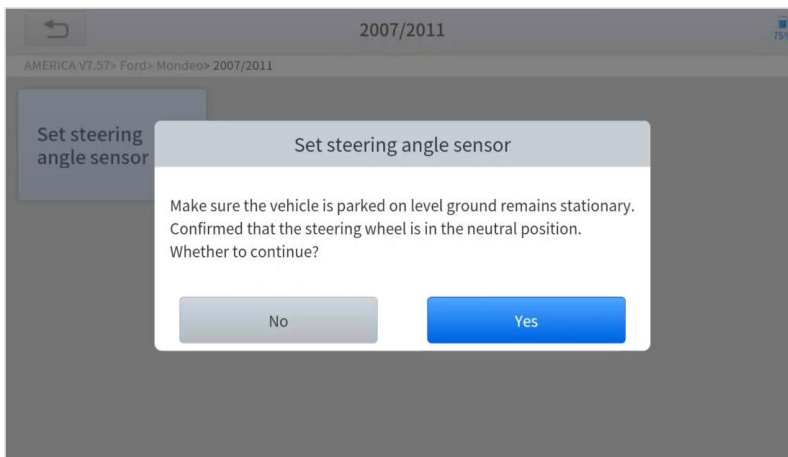
***The operation guidelines of the SAS function are shown as below:***

1. Enter the **SAS** menu and choose relevant models according to the vehicle being tested.
2. Enter the **Set steering angle sensor** menu and follow the instructions displayed.



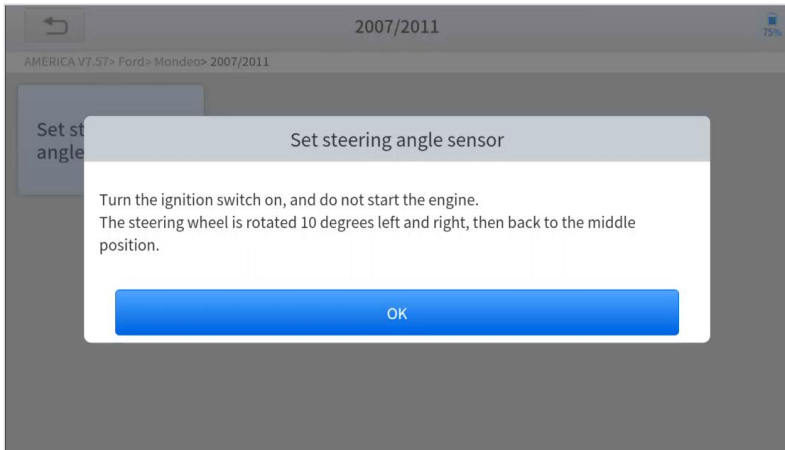
*Figure 5-6 Sample of SAS function (screen 1)*

3. Wait until the following instruction is displayed and press **Yes** after completing the instructions shown.



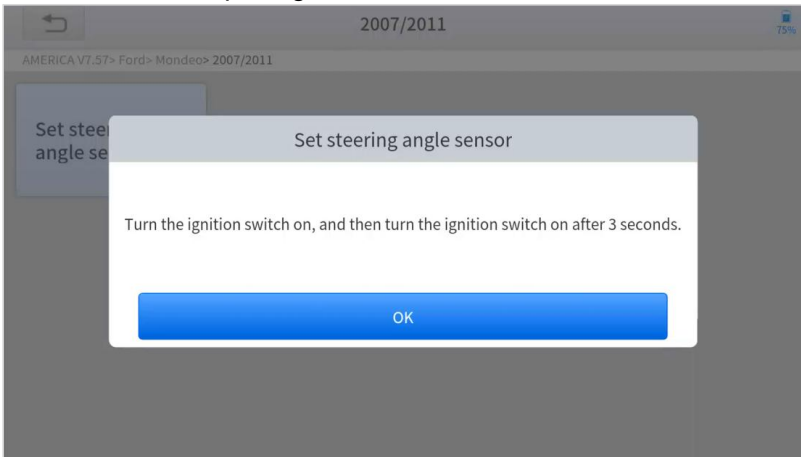
*Figure 5-7 Sample of SAS function (screen 2)*

4. Follow the instructions displayed and press **OK** after completing the instructions shown.



*Figure 5-8 Sample of SAS function (screen 3)*

5. Wait until the following instruction is displayed and press **OK** after completing the instructions shown.



*Figure 5-9 Sample of SAS function (screen 4)*

6. Message of **'Function execution is completed'** displayed when SAS function has successfully performed.

## 5.4 DPF

The Diesel Particle Filter (DPF) function manages DPF regeneration, DPF component replacement teach-in, and DPF teach-in after replacing the engine control module (ECM).

The ECM monitors driving style and selects a suitable time to employ regeneration. Vehicles driven a lot at idling speed and low load will attempt to regenerate earlier than vehicles driven more with higher load and speed. For regeneration to take place, a prolonged high exhaust temperature must be obtained. In the event of the car being driven in such ways that regeneration is not possible, i.e., frequent short journeys, a diagnostic trouble code will eventually be registered in addition to the DPF light and "Check Engine" indicators displaying. A service regeneration can be requested in the workshop using the diagnostic tool.

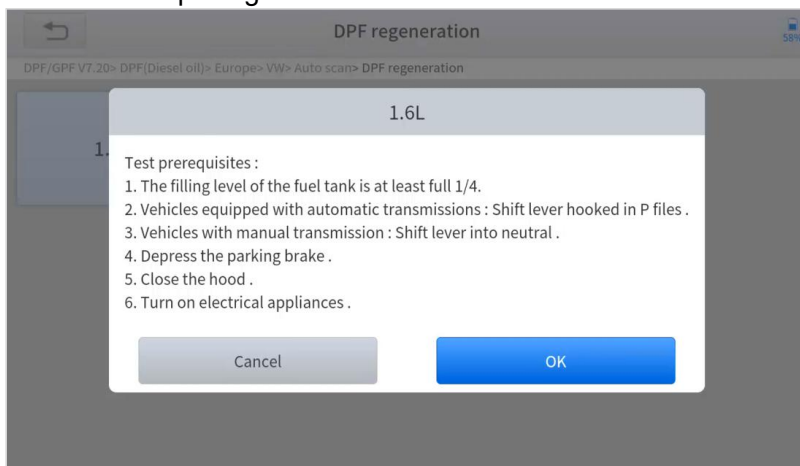
DPF regeneration is used to clear PM (Particulate Matter) from the DPF filter through continuous combustion oxidation mode (such as high-temperature heating combustion, fuel additive or catalyst reduce PM ignition combustion) to stabilize the filter performance.

DPF regeneration may be performed in the following cases:

- The exhaust back pressure sensor is replaced.
- The PM trap is removed or replaced.
- The fuel additive nozzle is removed or replaced.
- The catalytic oxidizer is removed or replaced.
- The DPF regeneration MIL is on and maintenance is performed.
- The DPF regeneration control module is replaced.

**The operation guidelines of the DPF function are shown as below:**

1. Enter the **DPF** menu and choose relevant models according to the vehicle being tested.
2. Enter the **DPF regeneration** menu.
3. Read carefully and complete the **requisites** listed before performing the DPF regeneration function. And press **OK** after completing the instructions shown.



*Figure 5-10 Sample of DPF function (screen 1)*

4. Read the fuel tank level and make sure that it fulfills the requirement displayed.
5. Read the carbon deposit load.
6. Choose the drive to warm up and follow the instructions listed below. And press OK after completing the instructions shown.

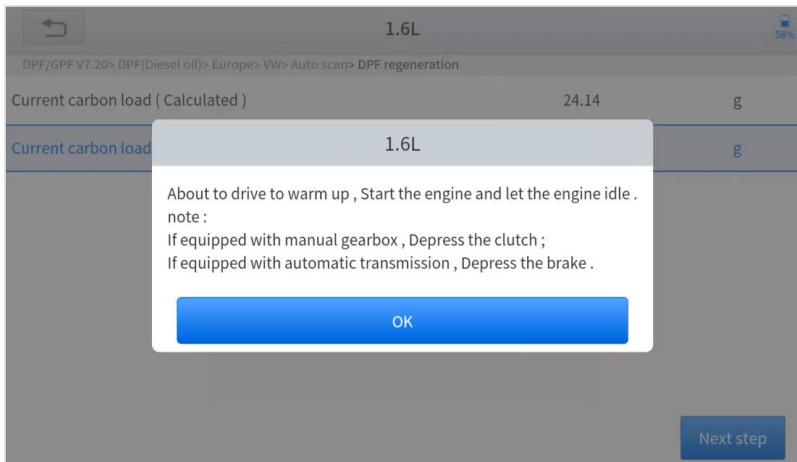


Figure 5-11 Sample of DPF function (screen 2)

7. Read the note carefully and follow the instructions shown on the screen. And press **OK** after completing the instructions shown.

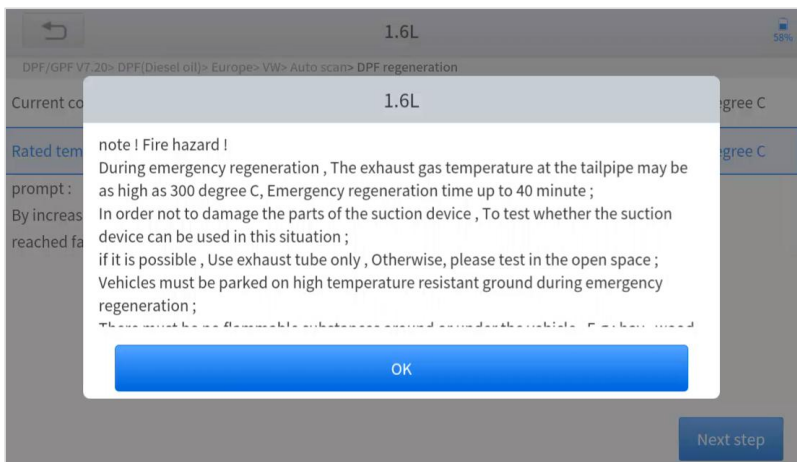


Figure 5-12 Sample of DPF function (screen 3)

8. Follow the instructions displayed and press **OK** after completing the instructions shown. Please pay attention to the Note.

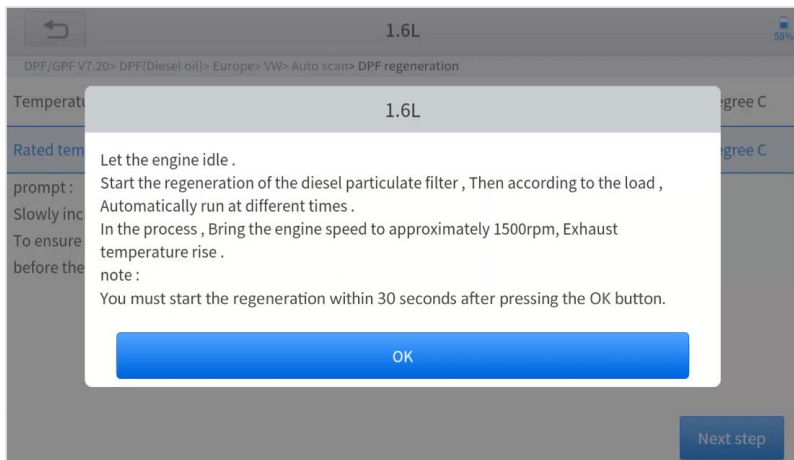


Figure 5-13 Sample of DPF function (screen 4)

9. Press the **OK** button to start the regeneration.

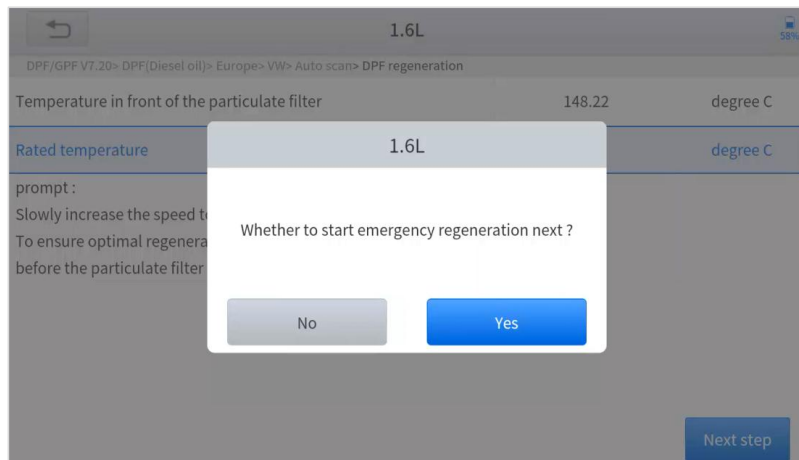


Figure 5-14 Sample of DPF function (screen 5)

10. Wait for the value of carbon deposit to decrease until a message of 'Emergency regeneration has been **completed**' pops up, this process may take up to 40 minutes.

| 1.6L  |              |          |
|---|--------------|----------|
| DPF/GPF V7.20> DPF(Diesel oil)> Europe> VW> Auto scan> DPF regeneration |              |          |
| Regeneration duration   | 0.00         | min      |
| <b>Carbon deposit</b>   | <b>22.78</b> | <b>g</b> |
| Rotating speed  | 781          | rpm      |
| Waste temperature upstream of turbocharger                              | 143.41       | degree C |
| Upstream of particulate filter  | 143.21       | degree C |
| Downstream of particulate filter  | 112.38       | degree C |
| <b>Next step</b>  |              |          |

Figure 5-15 Sample of DPF function (screen 5)

11. Wait for **2 minutes** to let the particulate filter cool down.

| 1.6L   |             |          |
|--|-------------|----------|
| DPF/GPF V7.20> DPF(Diesel oil)> Europe> VW> Auto scan> DPF regeneration            |             |          |
| Current carbon load ( Calculated )   | 24.14       | g        |
| <b>Current carbon load ( Measurements )</b>  | <b>1.32</b> | <b>g</b> |
| Let the engine run at idle again 2 Minutes to cool down the hot particulate filter | 120         | s        |
| <b>drop out</b>  |             |          |

Figure 5-16 Sample of DPF function (screen 6)

12. Press **drop out** to exit the DPF function.



## 5.5 BMS RESET

The Battery Management System (BMS) allows the scan tool to evaluate the battery charge state, monitor the close-circuit current, register the battery replacement, and activate the rest state of the vehicle.

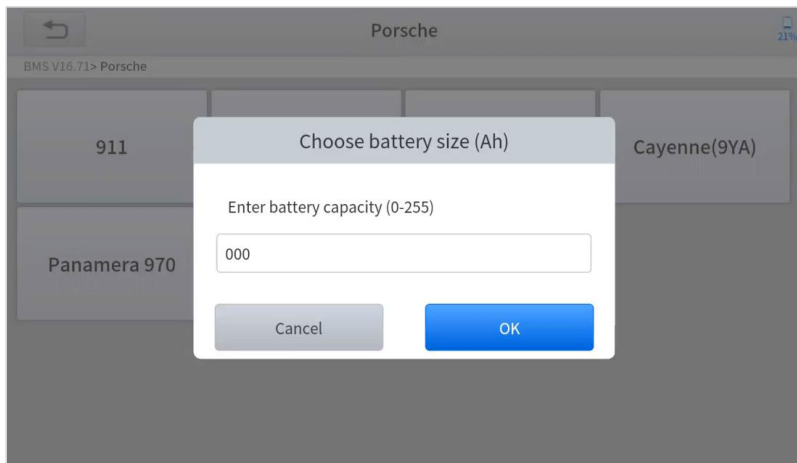
This function enables you to perform a resetting operation on the monitoring unit of the vehicle battery, in which the original low battery fault information will be cleared and battery matching will be done.

Battery matching must be performed in the following cases:

- The main battery is replaced. Battery matching must be performed to clear original low battery information and prevent the related control module from detecting false information. If the related control module detects false information, it will invalidate some electric auxiliary functions, such as automatic start & stop function, sunroof without one-key trigger function, power window without automatic function.
- Battery matching is performed to re-match the control module and motoring sensor to detect battery power usage more accurately, which can avoid an error message displayed on the instrument cluster.

***The operation guidelines of the BMS Reset function are shown as below:***

1. Enter the **BMS Reset** menu and choose relevant models according to the vehicle being tested.
2. Turn on the ignition switch.
3. Press **OK** to continue the BMS function.
4. Enter **battery capacity** (within the given range) and press **OK** after the input.



*Figure 5-17 Sample of BMS function (screen 1)*

5. Enter the **battery manufacturer** and press **OK** after the input.

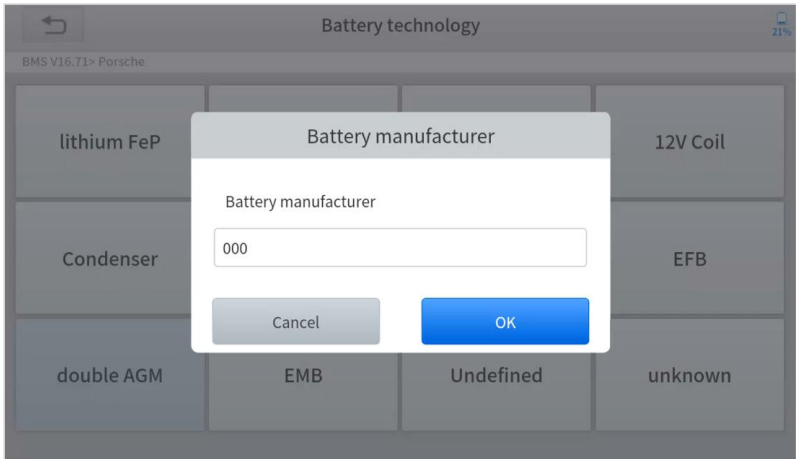


Figure 5-18 Sample of BMS function (screen 2)

6. Enter the **10-digit battery serial number** and press **OK** after the input.

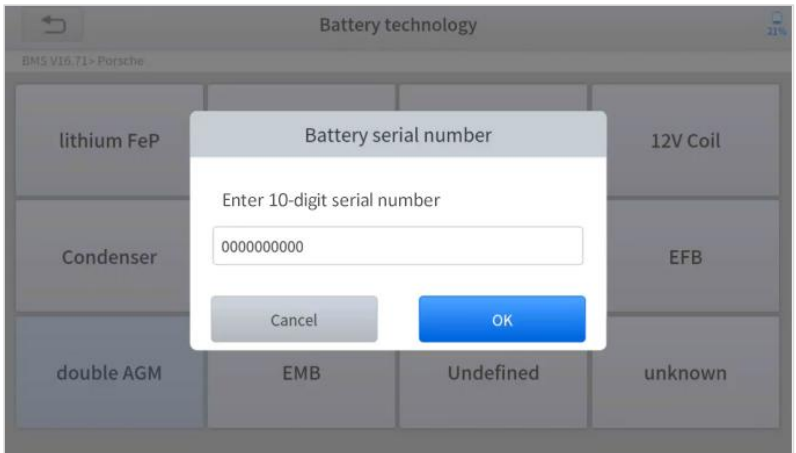


Figure 5-19 Sample of BMS function (screen 3)

## 5.6 THROTTLE

Throttle Position Sensor (TPS) Match, this function enables you to make initial settings to throttle actuators and returns the “learned” values stored on ECU to the default state. Doing so can accurately control the actions of regulating throttle (or idle engine) to adjust the amount of air intake.

***The operation guidelines of the Throttle function are shown as below:***

1. Enter the **Throttle** menu and choose relevant models according to the vehicle being tested.
2. Enter the **Auto Recognition** menu and turn on the ignition switch.
3. Read carefully and complete the **requisites** listed before performing the throttle regeneration function. And press **OK** after completing the instructions shown.

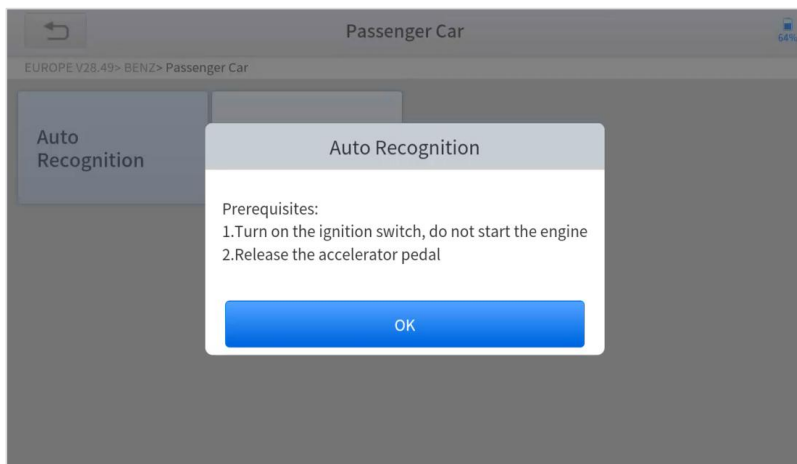
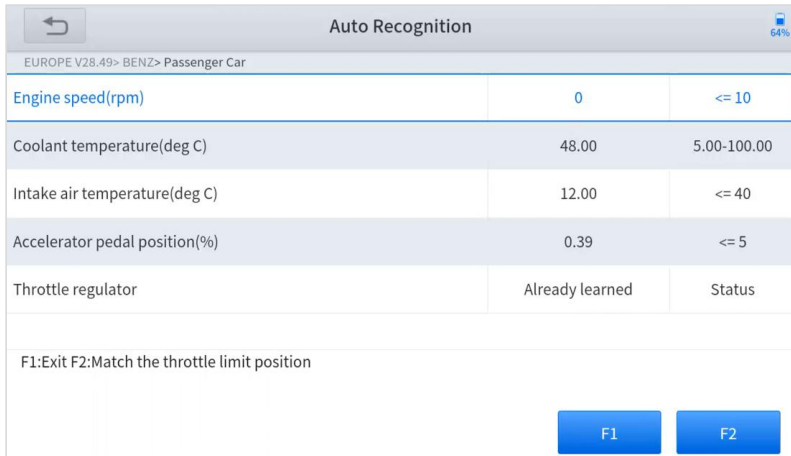


Figure 5-20 Sample of throttle function (screen 1)

4. Wait until all the parameters are read and displayed.



| Auto Recognition                             |                 |             |
|--|-----------------|-------------|
| EUROPE V28.49> BENZ> Passenger Car           |                 |             |
| Engine speed(rpm)                            | 0               | <= 10       |
| Coolant temperature(deg C)                   | 48.00           | 5.00-100.00 |
| Intake air temperature(deg C)                | 12.00           | <= 40       |
| Accelerator pedal position(%)                | 0.39            | <= 5        |
| Throttle regulator                           | Already learned | Status      |
| F1:Exit F2:Match the throttle limit position |                 |             |
|  |                 | F1 F2       |

Figure 5-21 Sample of throttle function (screen 2)

5. Press the **F2** button and wait until a message of '**Match successfully**' pops up.

## 5.7 INJECTOR CODING

This function can write the identification code of the fuel injector into the ECU so that the ECU can recognize and work normally. Write actual injector code or rewrite code in the ECU to the injector code of the corresponding cylinder for controlling accurately and correcting cylinder injection quantity.

After the ECU or injector is replaced, the injector code of each cylinder must be confirmed or re-coded so that the cylinder can better identify injectors to accurately control fuel injection.

*① In general cases, there is no need to do the coding matching function after cleaning.*

*① The identification of the fuel injector includes its working accuracy value and type value. When replacing it, you need to find the corresponding model for replacement.*

*① At present, mainstream cars support injector coding functions.*

***The operation guidelines of the Injector Coding function are shown as below:***

1. Enter the **Injector coding** menu and choose relevant chassis models according to the vehicle being tested.
2. Enter the **Fuel injection nozzle injection volume adjustment** menu.
3. Read the note displayed carefully and press **OK** after the reading.

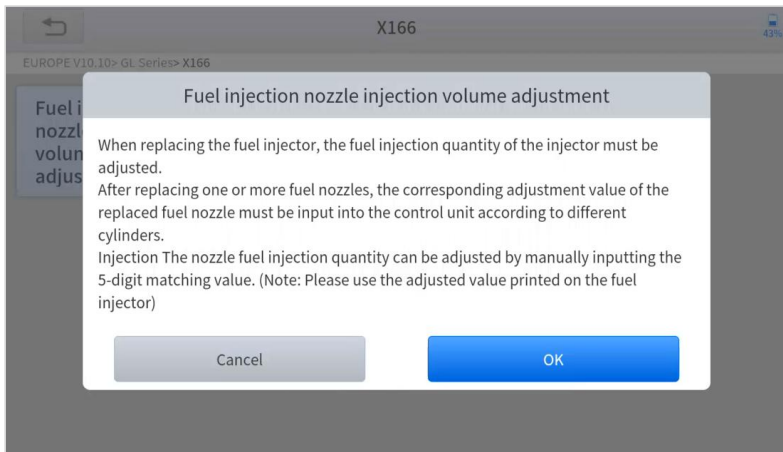


Figure 5-22 Sample of injector coding function (screen 1)

4. Read and confirm the value stored in the cylinders.

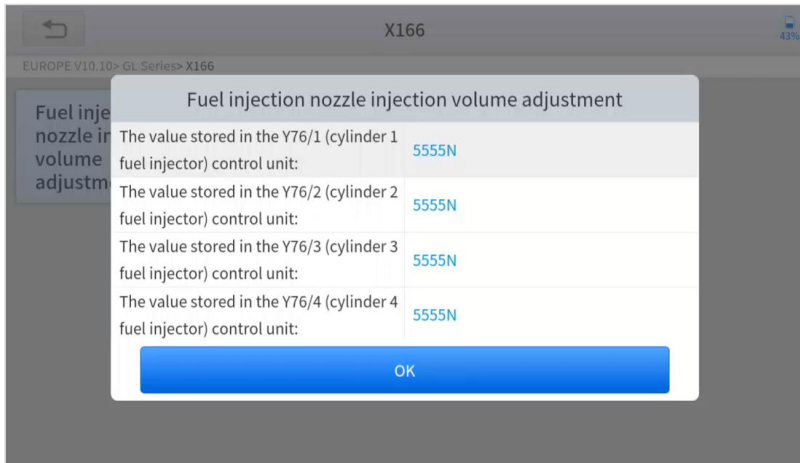


Figure 5-23 Sample of injector coding function (screen 2)

5. Enter the **Change the value of cylinder** menu of the replaced injector(s), enter the **new 5-digit value**, and then press **OK**.

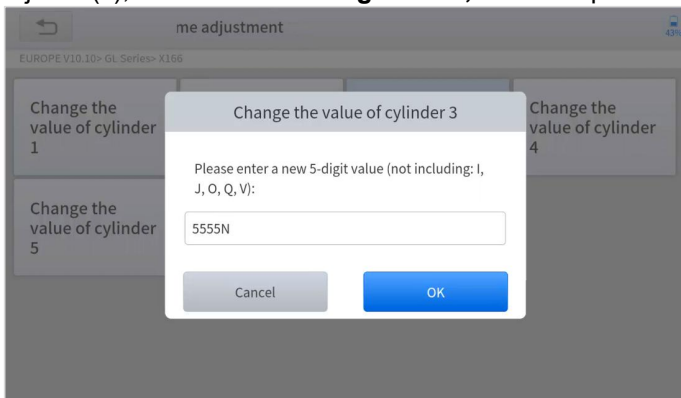


Figure 5-24 Sample of injector coding function (screen 3)

6. Wait until the message '**Write successfully**' pops up.
7. Turn off the ignition switch.
8. Wait until the message asked you to turn on the ignition switch.
9. Re-enter the **Fuel injection nozzle injection volume adjustment** menu to check whether the new value(s) are shown.

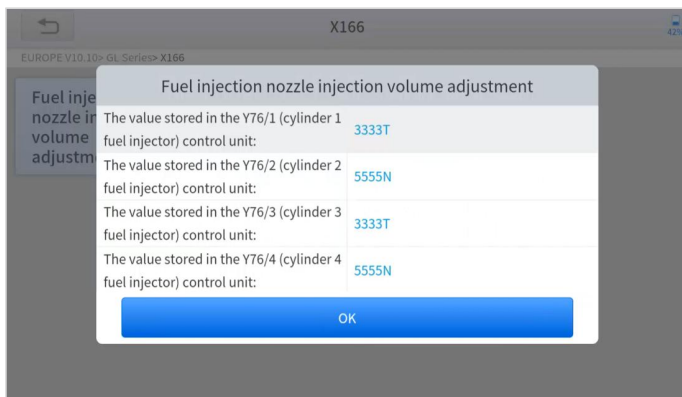


Figure 5-25 Sample of injector coding function (screen 4)



## 5.8 GEARBOX MATCH

After changing the gearbox or changing the gearbox ECU, you need to use the gearbox matching function to re-match the engine and the gearbox.

*ⓘ Before resetting the gearbox, please check the gearbox control unit to ensure that there is no fault code. If there is a fault code, the gearbox memory function cannot be reset. Please road test after reset.*

**The operation guidelines of the Gearbox Matching function are shown as below:**

1. Enter the **Gearbox matching** menu and choose relevant models according to the vehicle being tested.
2. Enter the **Reset adaptive value** menu.
3. Turn on the ignition without starting the engine.
4. Read the note and press **OK** to continue the Gearbox Matching function.

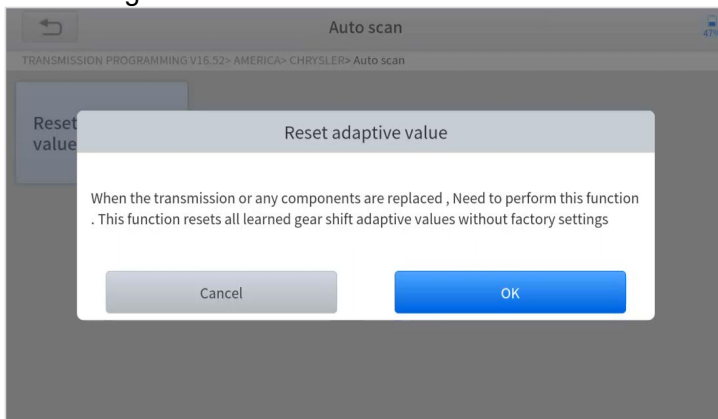


Figure 5-26 Sample of gearbox matching function (screen 1)

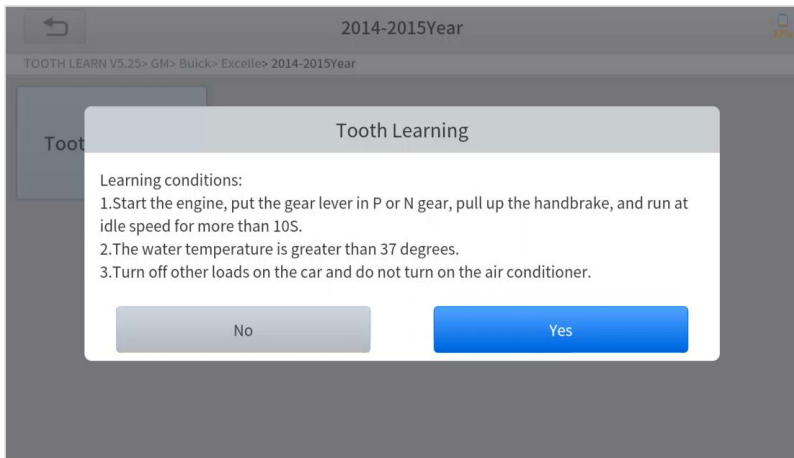
5. Wait until the message '**Successful operation**' pops up.

## 5.9 GEAR LEARNING

The crankshaft position sensor learns crankshaft tooth machining tolerance and saves to the tablet to more accurately diagnose engine misfires. If gear learning is not performed for a car equipped with a Delphi engine, the MIL turns on after the engine is started. The diagnostic device detects the DTC P1336 'Gear not learned'. In this case, you must use the diagnostic device to perform gear learning for the car. After gear learning is successful, the MIL turns off. This function can complete the self-learning of the gearbox and improve the quality of shifting. After the engine ECU, crankshaft position sensor, or crankshaft flywheel is replaced, or the DTC 'gear not learned' is present, gear learning must be performed.

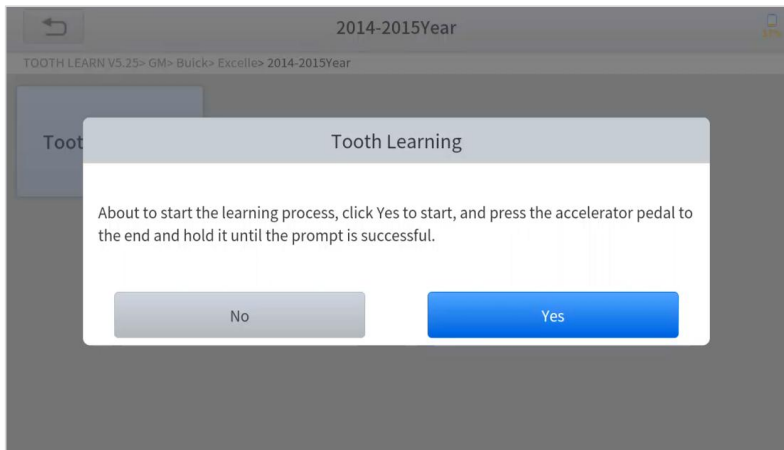
***The operation guidelines of the Gear learning function are shown as below:***

1. Enter the **Gear learning** menu and choose relevant models according to the vehicle being tested.
2. Turn on the ignition switch to start the vehicle.
3. Enter the **Tooth Learning** menu.
4. Read carefully and complete the **requisites** listed before performing the gear learning function. And press **OK** after completing the instructions shown



*Figure 5-27 Sample of gear learning function (screen 1)*

5. Read the instructions displayed and press **Yes** to start the learning process.



*Figure 5-28 Sample of gear learning function (screen 2)*

6. **Press the accelerator pedal** down and hold it until a message of 'The **learning is successful**, please release the accelerator pedal.' pops up.
7. Release the accelerator pedal and press **OK** to exit the gear learning function.

## 6 SETTINGS

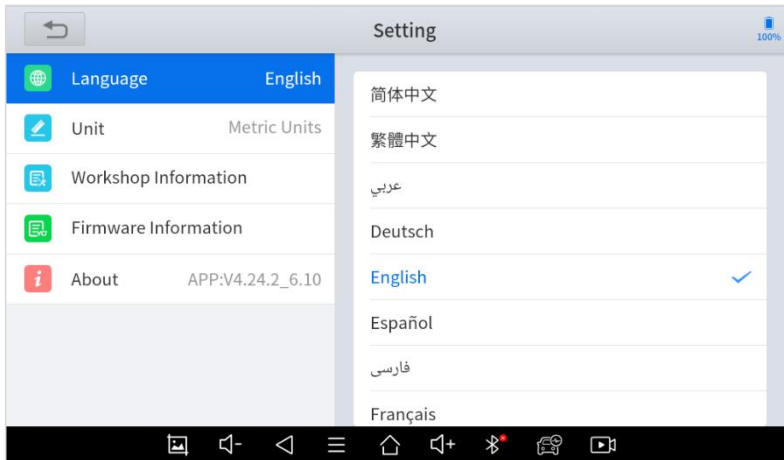
Click the Settings button to adjust the default settings and view information about the PS70PRO Smart Diagnosis System. There are seven options available in the system settings:

- **Language**
- **Units**
- **My Workshop Info**
- **VCI Info**
- **About**

### LANGUAGE

The languages supported by this device are listed in **Settings**. In areas outside the English area, the default language is English and the local official language. Users can switch between English and local official languages on the device by themselves. If you need to switch other languages, please contact the dealer to unbind the current language configuration and rebind it to the language configuration you need to switch.

After the configuration is successfully changed, you can switch the target language.



*Fig 6-1 Sample of Language Settings*

① This will only change the language of the APP. If you want to change the system language, please go to Android Settings.

■ **How to change the language of your software?**

- **Step1:** Contact your dealer and leave a message about the language you need and the S/N of your device, The technician will modify the language configuration for you in the background.
- **Step2: Settings->Language->Choose language**
- **Step3: OS Settings->Language & input->Choose Language**

Note: The types and quantities of languages supported are subject to the actual language types displayed on the device

- **Step4:** Back to **Updates** to pull all packages again

## UNITS

You can switch the unit used by the system. PS70PRO Smart Diagnosis System provides you with **Metric**, **Imperial**, and **U.S. units**. You can directly click on the unit you need, after the switch is successful, a blue checkmark will be displayed behind the unit's name.

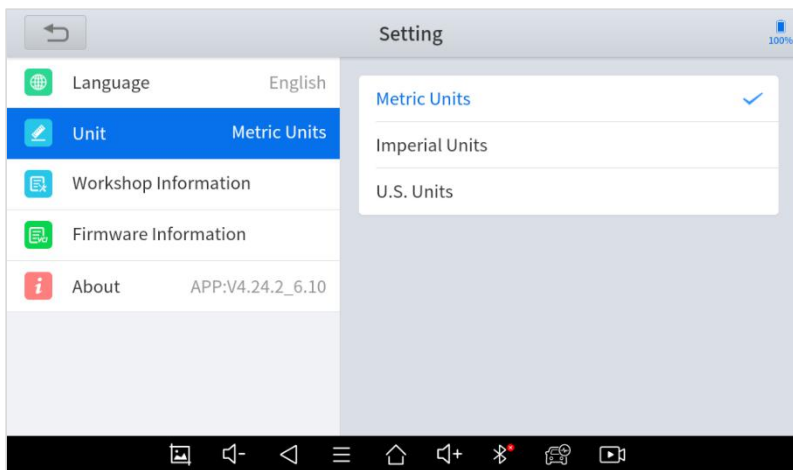
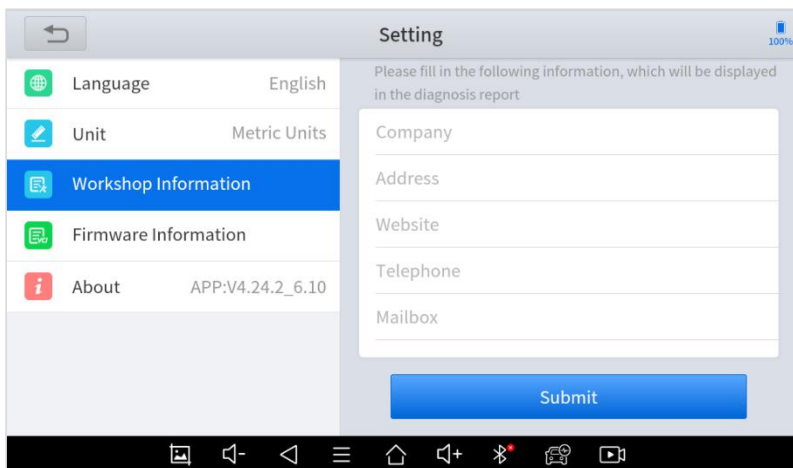


Fig 6-2 Sample of Unit Settings

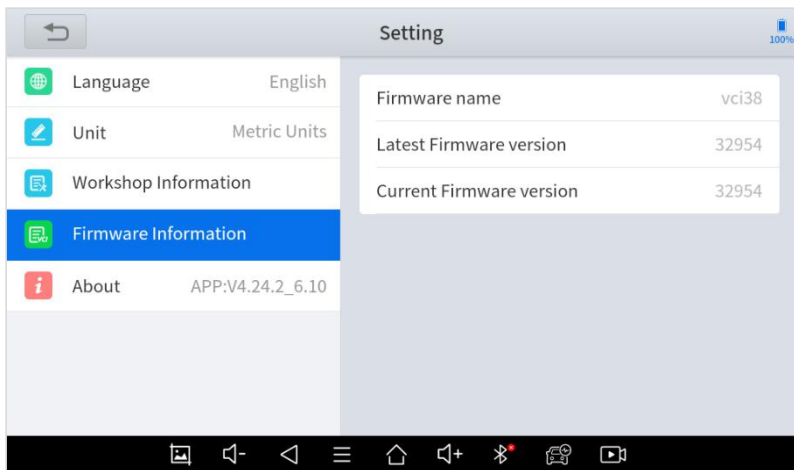
## MY WORKSHOP INFO

Click on **My Workshop Information**, you can input your workshop information here. As shown in the figure below, you just need to fill in the valid information in the corresponding column and click "**SUBMIT**". And then it will show your workshop information in the report when you generate a diagnostic report, including your company name, address, website, telephone, and mailbox.



*Fig 6-3 Sample of Workshop Information Settings*

# FIRMWARE INFORMATION



*Fig 6-4 Sample of Firmware Information*

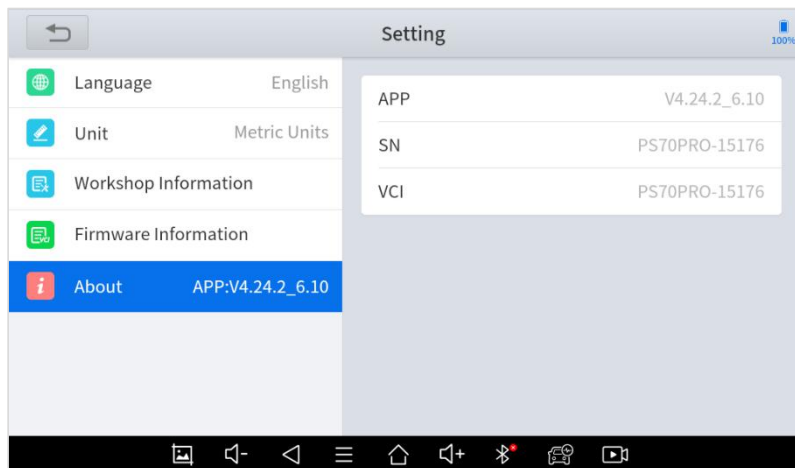
You can view the firmware information here, including the firmware name, the latest firmware version, the currently used firmware version, and the firmware type.

① The diagnosis tablet supports automatic firmware update, please make sure that the device is connected to the network when you enter the diagnostic software and the firmware will be automatically updated to the latest version.



# ABOUT

Tap on **ABOUT**, you can check the serial number and APP version on here.



*Fig 6-5 Sample of About*

# 7 REPORT

Diagnostic Report is used for viewing and printing the saved files, such as Live Data, Trouble Codes, or pictures generated in the process of diagnosis, users also can view a record of which cars have been previously tested. It includes 3 parts:

- **Report**
- **Replay**
- **File Management**



*Fig 7-1 Sample of Report Function*

## REPORT

This feature provides a history of diagnostic reports, where you can view and delete the vehicle's diagnostic reports according to your needs.



Fig 7-2 Sample of Report Records

When you open the report, located in the header of the table is the studio information you filled in advance in the system setup, then the information of the vehicle, as shown as below:

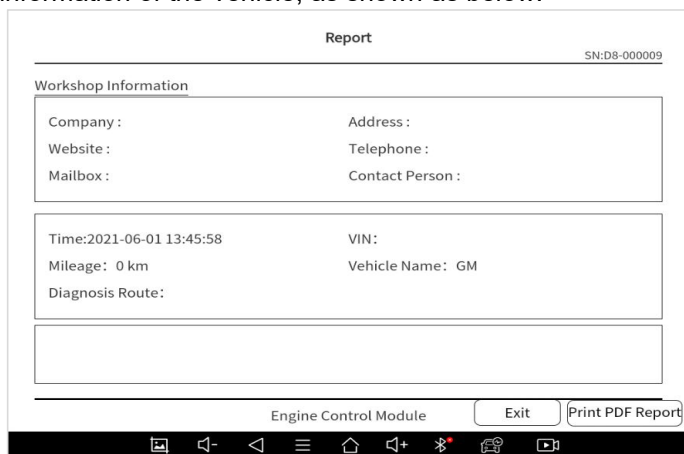


Fig 7-3 Sample of Report

## ■ Print PDF Report

As you can see, you also could click " **Print PDF Report** " at the bottom right corner to output the pdf report. If you need to close the report, you could tap on the button "Exit".

Please follow the below steps to print your report ▼

**Step 1:** Install an APP that can drive your target printer. Add the printer and input the IP address of the printer in the APP, or you can contact your dealer for help.

① PS70PRO Smart Diagnosis System doesn't provide the printer driver software, please install a third part App on the tablet if you need the print your diagnosis report.

**Step 2:** Back to the Android main menu, go to Settings -> Printing-> Turn the printer on.

**Step 3:** Report-> Choose report-> Print PDF Report-> Print

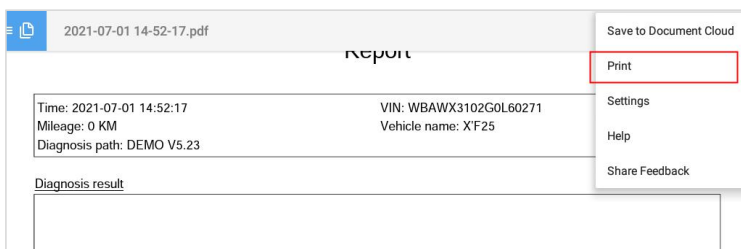


Fig 7-4 Click to Print

**Step 4:** Click the top-left corner of the screen and choose the printer you added before. Then click the button on the right to print.

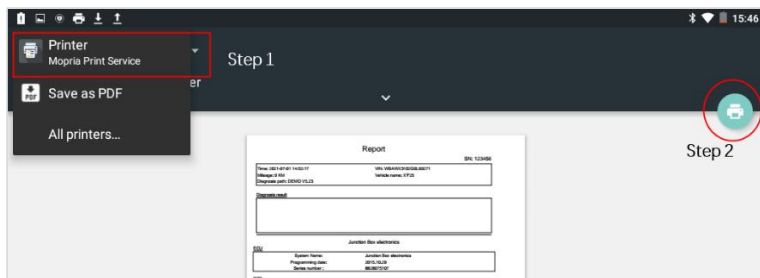
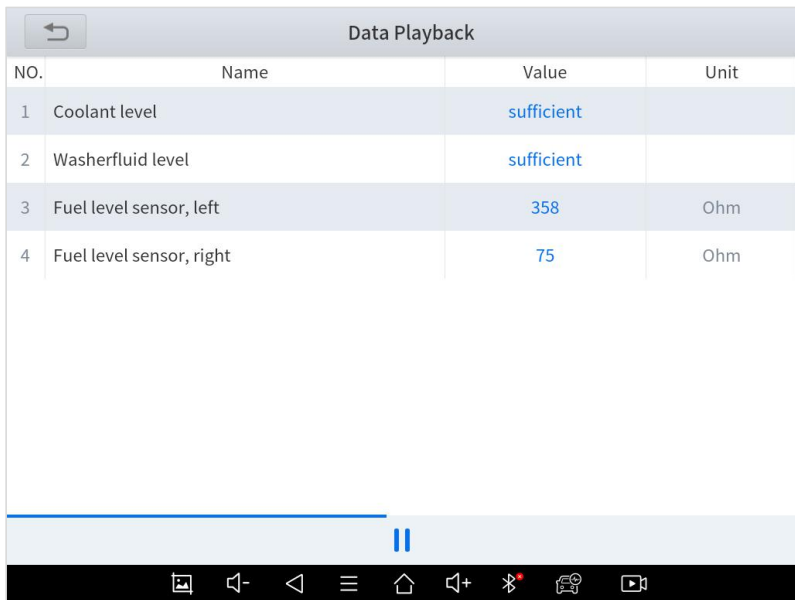


Fig 7-5 Choose the printer

## REPLAY

This function allows you to replay the living data recorded during the diagnosis process.

Before replaying the living data, please make sure you have recorded the live data during the diagnosis



| NO. | Name                     | Value      | Unit |
|-----|--------------------------|------------|------|
| 1   | Coolant level            | sufficient |      |
| 2   | Washerfluid level        | sufficient |      |
| 3   | Fuel level sensor, left  | 358        | Ohm  |
| 4   | Fuel level sensor, right | 75         | Ohm  |

*Fig 7-6 Sample of Live Data Replay*

## FILE MANAGER

This function allows you to check and delete files on the device. Please use this function under the guidance of professionals. Ordinary users are not recommended to use it by themselves, as it may cause software missing or malfunctioning.

## 8 REMOTE ASSISTANCE

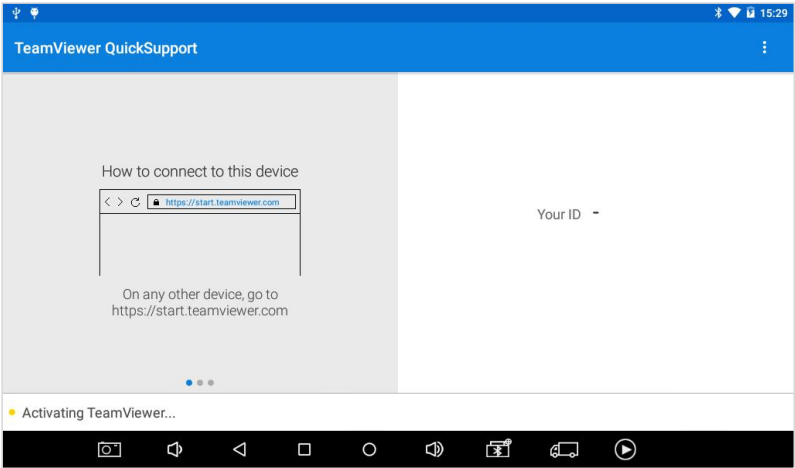
Tap on "**Remote**" to start the TeamViewer quick support program, which is a simple, fast, and secure remote-control screen. You can use this application to enable them to control your tablet on a PC through the TeamViewer software, thereby obtaining temporary remote support from XTOOL's technical support center.

Computers and mobile devices running TeamViewer are identified by a globally unique ID. When the remote application is started for the first time, the ID will be automatically generated according to the hardware characteristics and will not be changed in the future. This TeamViewer ID can individually access all TeamViewer clients.

Before launching the remote desktop application, make sure that the tablet is connected to the Internet so that you can access the tablet to receive remote support from a third party. If you encounter problems and are not able to solve them, you could open this application and ask for remote assistance.

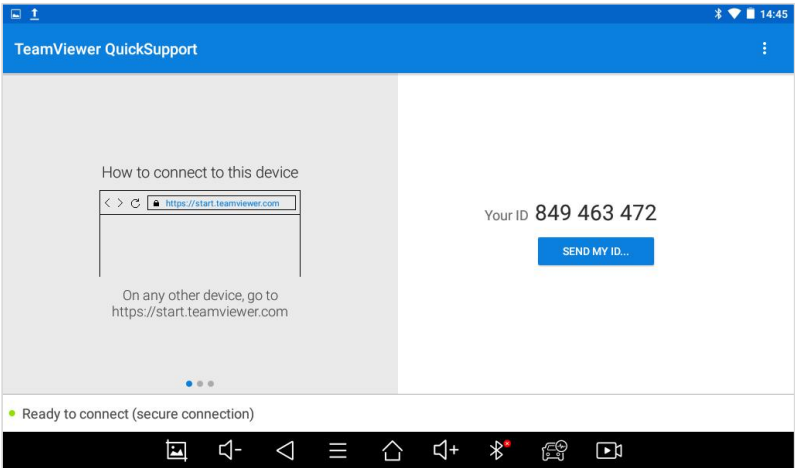
To obtain remote support from your partners or XTOOL After-service Center:

1. Turn on the power of the tablet.



*Fig 8-1 Sample of Team Viewer Starting*

2. Click **Remote** in the diagnosis application. The TeamViewer screen is displayed, and the device ID will be generated.



*Fig 8-2 Sample of Team Viewer ID*

3. Your partner must install the remote-control software on his/her computer by downloading the full version of the TeamViewer program (<http://www.teamviewer.com>) online, and then start the software on his/her computer at the same time, to provide support and remote control of the tablet.
4. Provide your ID to the partner or XTOOL technician, and then wait for him/her to send you a remote-control request.
5. A pop-up window will be displayed, asking you to confirm to allow the remote-control program to control your device.
6. Click Allow to accept, or click Reject to reject.

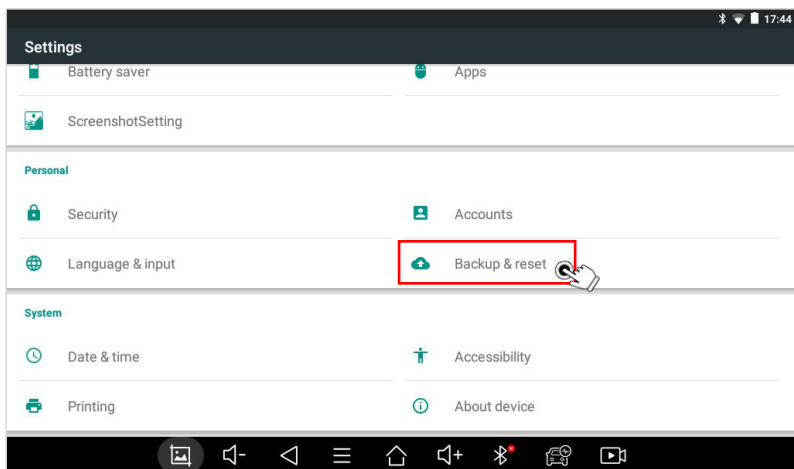


# 9 FACTORY RESET

Once the device is restored to factory settings, historical data cannot be restored. Please use this function under the guidance of professional technicians. Xtooltech is not responsible for all economic losses caused by restoring factory settings, please use this function with caution.

Here are the steps to restore factory settings

## Step 1 Clicking *Settings*



*Fig 9-1 Sample of FACTORY RESET (Screen 1)*

## Step 2 Click on *Factory Data Reset*

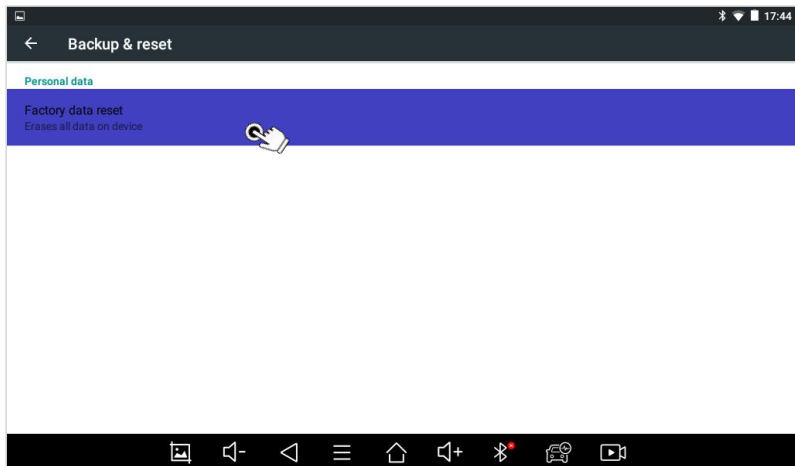


Fig 9-2 Sample of **FACTORY RESET** (Screen 2)

## Step 3 Click on *Reset Device*

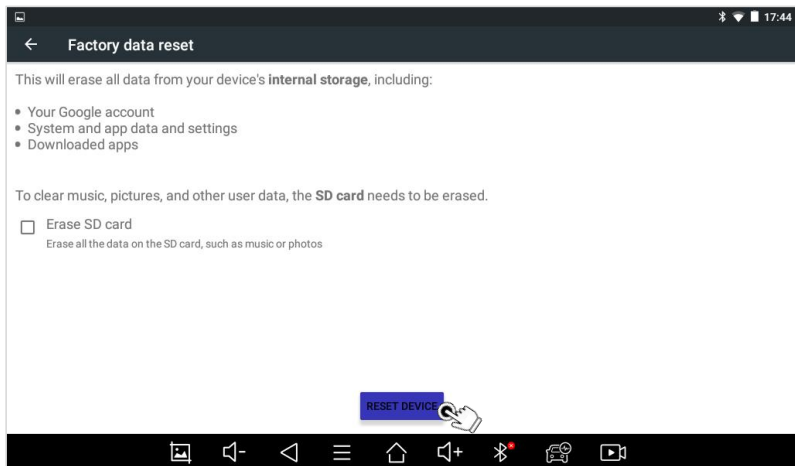
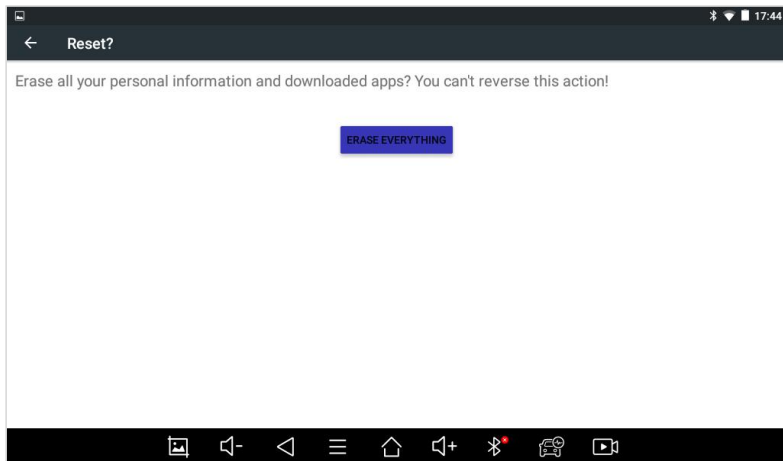


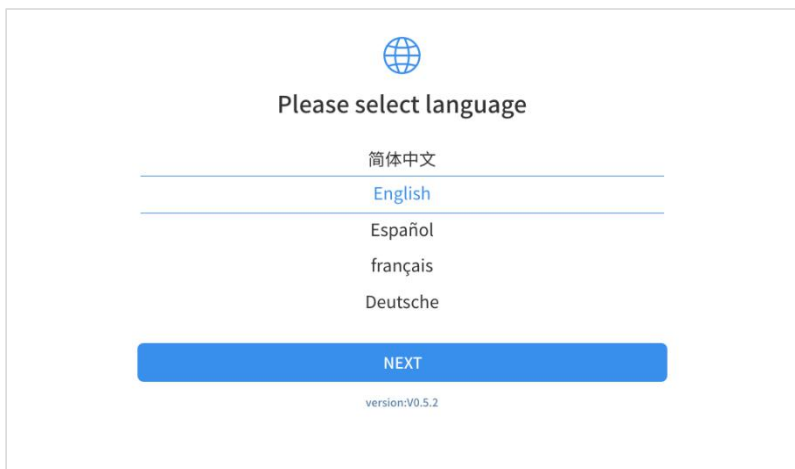
Fig 9-3 Sample of **FACTORY RESET** (Screen 3)

## Step 4 Click on *ERASE EVERYTHING*



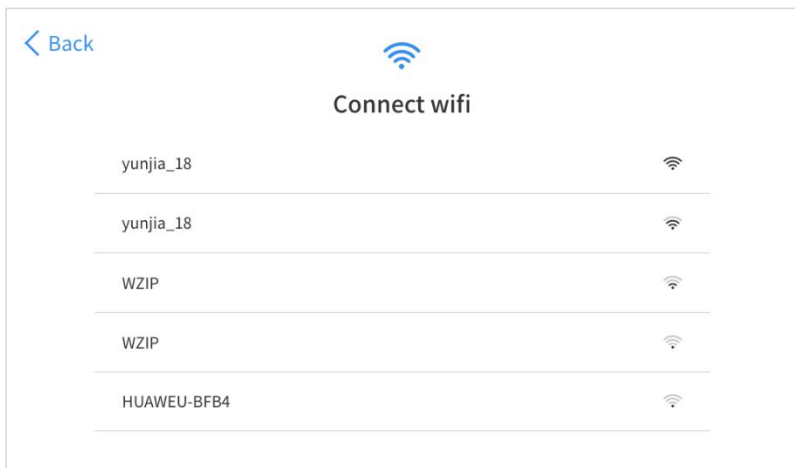
*Fig 9-4 Sample of FACTORY RESET (Screen 4)*

After you complete the above operations, the device will automatically restart and enter the factory mode to pull the new software. Please keep the network stable and follow the instructions on the page. You can select the language in the following interface.



*Fig 9-5 Sample of Select Language*

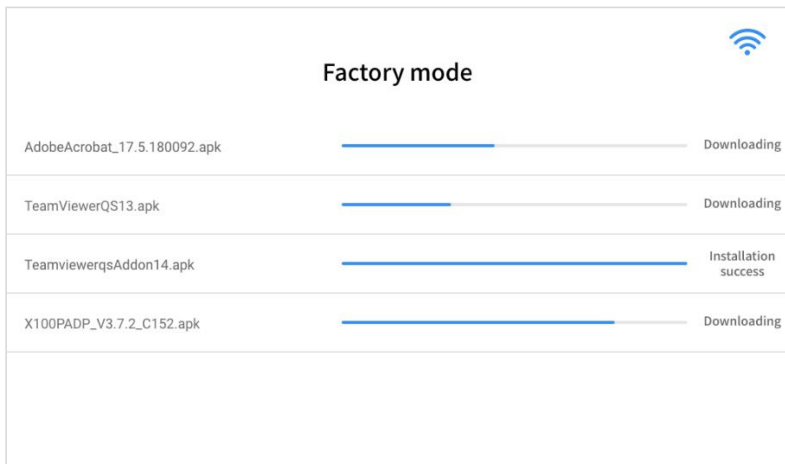
After selecting the system language, click **Next** to enter the Wi-Fi connection page, as shown below:



*Fig 9-6 Sample of Wi-Fi Connection*

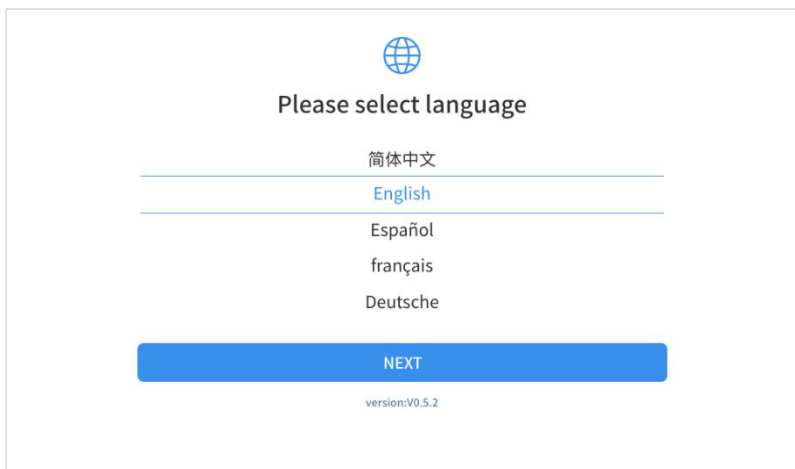
Select a network to connect to on the Wi-Fi connection page.

After successful network connection, the automatic system will jump to **Factory mode** to download the software :



*Fig 9-7 Sample of Factory Mode*

Once the software has been downloaded, the tablet will automatically reboot and request the system language selection again.



*Fig 9-8 Sample of Language Selection*

Since restoring the factory settings will erase the user information on your device, you need to enter the email again to

### **Note**

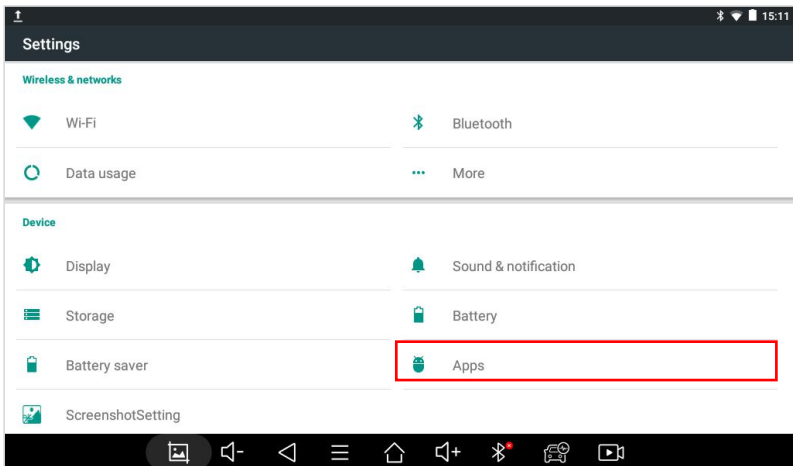
Once the device is reset to factory settings, historical data cannot be recovered. Please use this feature with caution. In addition, if you restore factory settings after the expiration date, Xtooltech is not responsible for restoring historical data for you. It is recommended to use this function under the guidance of a technician.

activate your device

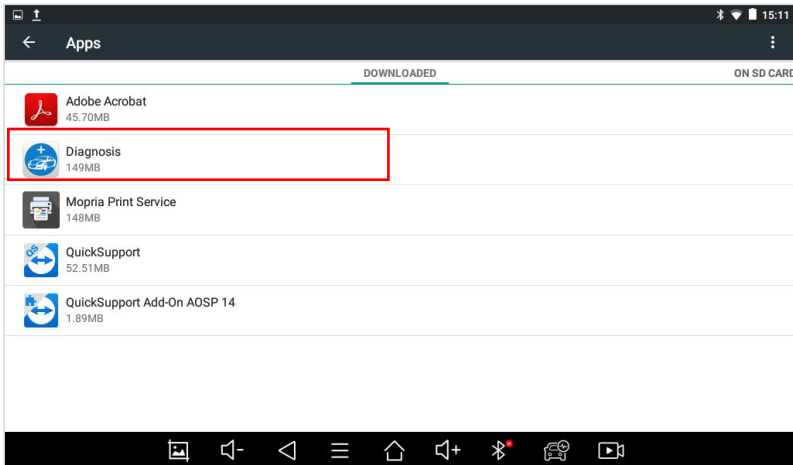
# 10 FAQ

## Q1: FAILED TO GENERATE DIAGNOSIS REPORT

1. Currently only perform diagnostic functions, that is, read ECU information, read code and clear code, live data, freeze frame, which can trigger a diagnostic report. Other functions, such as immobilization and maintenance services will not be displayed in the report.
2. After entering the diagnosis menu, you need to perform one specific function before the system can generate a diagnosis report normally.
3. After the diagnosis is completed, you need to step back to the previous menu step by step to generate the diagnosis report successfully. If the APP is killed directly, the report cannot be triggered.
4. If the report still cannot be generated after troubleshooting according to the above prompts, please try to exit the APP, enter the system settings, and then choose to clear the APP cache.
  - Enter the path: Setting>>Apps>>Diagnosis>>Clear Cache
  - Sample as follows:

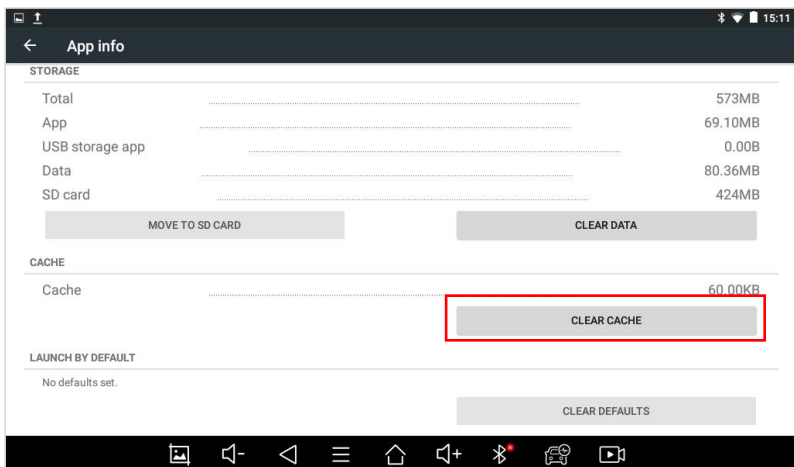


*Fig 10-1 Sample of How to Clear APP Cache (Screen 1)*



*Fig 10-2 Sample of How to Clear APP Cache (Screen 2)*





*Fig 10-3 Sample of How to Clear APP Cache (Screen 3)*

## **Q2: HOW TO PRINT DIAGNOSIS REPORT**

The XTOOL device is compatible with third-party print drivers. You can download the printer driver you need in the browser that comes with the tablet to install it, and then set your printer in the OS settings. After the setting is completed, you can print it in the **Report**.

## **Q3: FAILED TO EXTRACT FILES**

Since the XTOOL tablet is equipped with an Android system, you have to confirm the system type of receiver.

**For Android:** supports transferring files via Bluetooth, USB cable, etc.;

**For IOS:** only supports transferring files through a wired connection (Bluetooth connection is not available).

#### **Q4: MAILBOX SUPPORTED**

The diagnosis tablet supports various mailboxes, including Hotmail, Outlook, Yahoo, Gmail, etc. When you set up the email, please make sure that the email client configuration address you entered is correct.

#### **Q5: HOW TO MAKE AN APPOINTMENT FOR REMOTE SUPPORT**

Please contact your dealer, or send an email to our technical support center. (Email address: supporting@xtooltech.com) And our technical support team will confirm the time of remote support with you.

#### **Q6: HOW TO GENERATE AND UPLOAD DIAGNOSTIC LOG FILES**

The PS70PRO tablet will automatically generate and store the diagnostic logs. When the device is connected to the Internet, it will automatically upload all the stored diagnostic logs to the backend system.

#### **Q7: HOW TO SWITCH THE LANGUAGE TO NON-ENGLISH**

1. Contact your dealer and leave a message about the language you need and the S/N of your device, The technician will modify the language configuration for you in the backend system.
2. **Settings->Language->**Choose language
3. Back to **Updates** to update all the software again

## **Q8: FAILED TO DIAGNOSE VEHICLE**

1. Contact your dealer to confirm whether the vehicle model is supported by the scan tool you owned.
2. Check whether the vehicle is properly connected (e.g. whether the ignition is ON, and the diagnosis of some vehicles need to turn on the engine), If your tablet is equipped with a VCI box, please check the status of the VCI box indicator.
3. Confirm whether you have entered the correct diagnosis menu.
4. Confirm whether the **AUTO-SCAN** function can assist you to enter the correct diagnosis menu, or whether the **OBDII** function works.
5. Check whether the software is the latest version, if not, please update to the latest version first.

## **Q9: FAILED TO ACTIVATE OR REGISTER**

- For 'Activation Failed'

Generally caused by network instability, please switch to a more stable network and try to activate again.

- For 'Registration Failed'

Generally, it is caused by the connection timeout or the sending timeout, please check whether you have blocked the outgoing network traffic to non-US regions like China. We recommend that you unblock and try to register again.

## **Q10: FAILED TO TURN ON WHEN CHARGING**

In the charging state, you need to first press the power button to light up the screen (showing the charging status). Then press

and hold the power button for 4-5 seconds until the boot animation is shown on screen.

### **Q11: FAILED TO OPEN THE DIAGNOSIS APP**

The tablet has to connect to the network every 30 days, otherwise, the diagnosis app will be locked and disabled until the device is connected to the network.

### **Q12: FAILED UPDATE APP**

1. The update progress is stuck

It is recommended to cancel the update and download it again after changing the network

2. There is no download option after the download process is completed

It is recommended to change the network, and the APP upgrade prompt will reappear when the network is stable. If the upgrade still fails, please contact the tech support team: [supporting@xtooltech.com](mailto:supporting@xtooltech.com)

## **Shenzhen Xtooltech Intelligent Co., Ltd**

Company address: 17&18/F, Building A2, Creativity City, Liuxian  
Avenue, Nanshan District, Shenzhen, China

Factory address: 2/F, Building 12, Tangtou Third Industrial Zone,  
Shiyan Street, Baoan District, Shenzhen, China

Service-Hotline: 0086-755-21670995/86267858

Email: [marketing@xtooltech.com](mailto:marketing@xtooltech.com)

Fax: 0755-83461644

Website: [www.xtooltech.com](http://www.xtooltech.com)

## **FCC Statement**

This device complies with part 15 of the FCC rules. Operation is subject to the following two conditions: (1) this device may not cause harmful interference, and (2) this device must accept any interference received, including interference that may cause undesired operation.

Changes or modifications not expressly approved by the party responsible for compliance could void the user's authority to operate the equipment.

NOTE: This equipment has been tested and found to comply with the limits for a Class B digital device, pursuant to part 15 of the FCC Rules. These limits are designed to provide reasonable protection against harmful interference in a residential installation. This equipment generates uses and can radiate radio frequency energy and, if not installed and used in accordance with the instructions, may cause harmful interference to radio communications. However, there is no guarantee that interference will not occur in a particular installation. If this equipment does cause harmful interference to radio or television reception, which can be determined by turning the equipment off and on, the user is encouraged to try to correct the interference by one or more of the following measures:

- Reorient or relocate the receiving antenna.
- Increase the separation between the equipment and receiver.
- Connect the equipment into an outlet on a circuit different from that to which the receiver is connected.
- Consult the dealer or an experienced radio/TV technician for help.

## **Specific Absorption Rate (SAR) information:**

This device meets the government's requirements for exposure to radio waves. The guidelines are based on standards that were developed by independent scientific organizations through periodic and thorough evaluation of scientific studies. The standards include a substantial safety margin designed to assure the safety of all persons regardless of age or health. FCC RF Exposure Information and Statement the SAR limit of USA (FCC) is 1.6 W/kg averaged over one gram of tissue. Device types: This device has also been tested against this SAR limit. This device was tested for typical body-worn operations with the back of the tablet kept 0mm from the body. To maintain compliance with FCC RF exposure requirements, use accessories that maintain an 0mm separation distance between the user's body and the back of the tablet. The use of belt clips, holsters and similar accessories should not contain metallic components in its assembly. The use of accessories that do not satisfy these requirements may not comply with FCC RF exposure requirements, and should be avoided.