

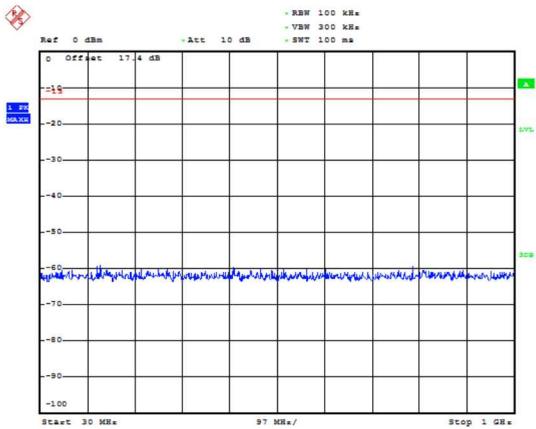

LTE Band 25 1.4MHz CH-High 30MHz~1GHz



Date: 8.DEC.2018 10:52:08

LTE Band 25 3MHz CH-Low 30MHz~1GHz

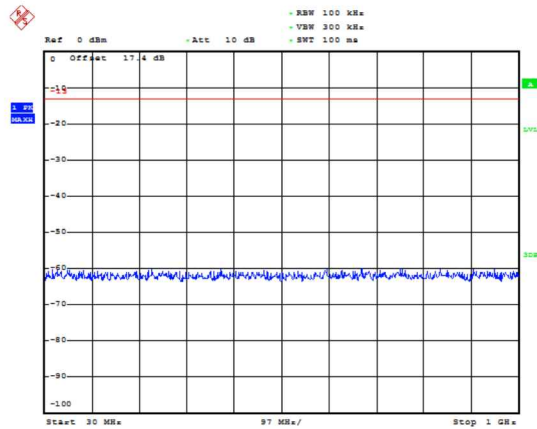

Date: 8.DEC.2018 10:53:21

LTE Band 25 1.4MHz CH-High 1GHz~3GHz

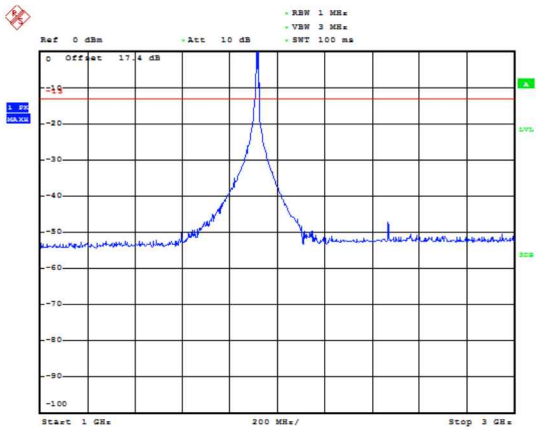

Date: 8.DEC.2018 10:51:51

LTE Band 25 3MHz CH-Low 1GHz~3GHz

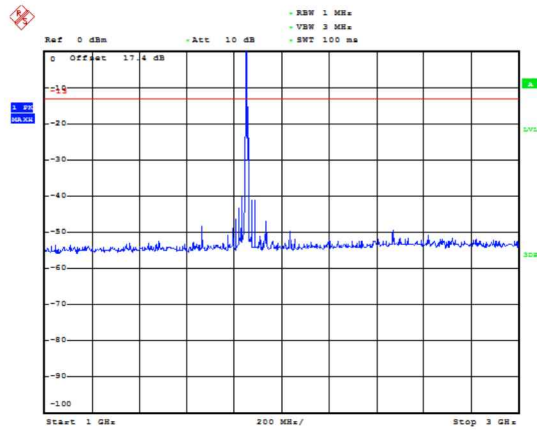

Date: 8.DEC.2018 10:53:39

LTE Band 25 1.4MHz CH-High 3GHz~20GHz

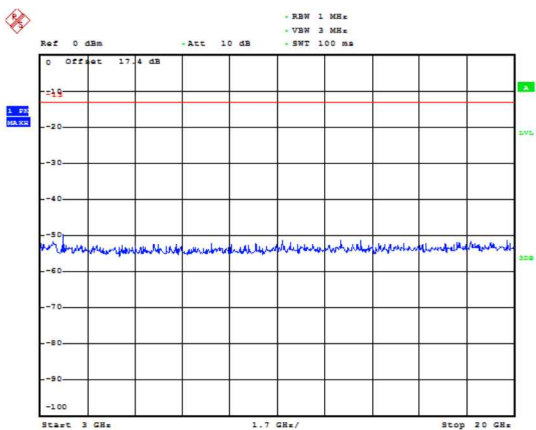

Date: 8.DEC.2018 10:50:28

LTE Band 25 3MHz CH-Low 3GHz~20GHz

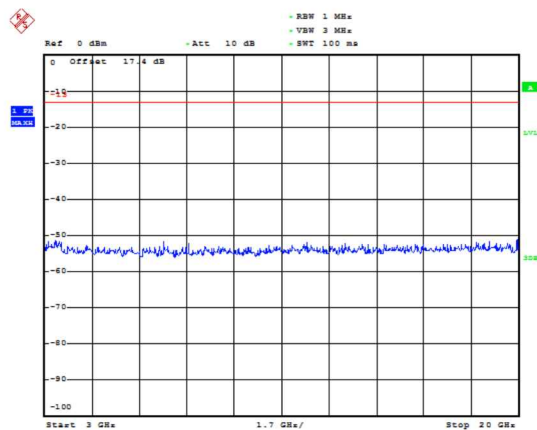

Date: 8.DEC.2018 10:53:54



LTE Band 25 3MHz CH-Middle 30MHz~1GHz

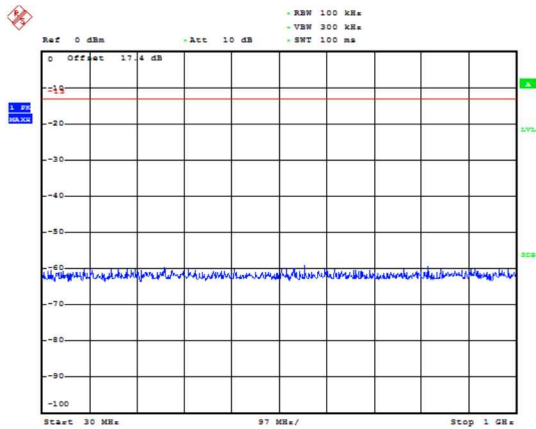

Date: 8.DEC.2018 10:56:14

LTE Band 25 3MHz CH-High 30MHz~1GHz

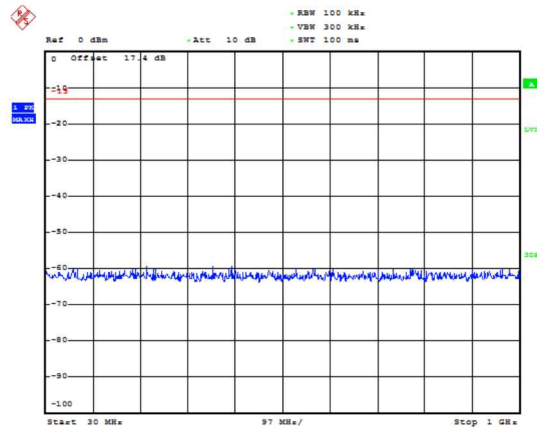

Date: 8.DEC.2018 10:56:50

LTE Band 25 3MHz CH-Middle 1GHz~3GHz

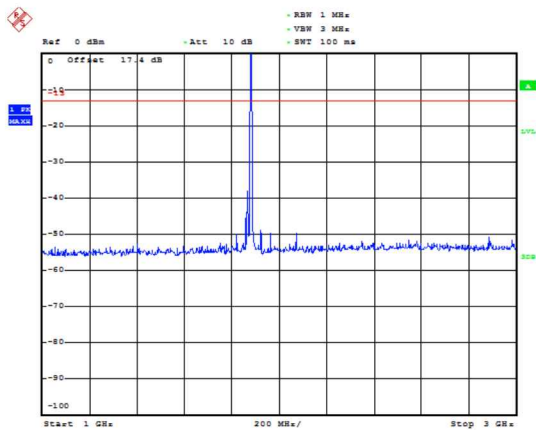

Date: 8.DEC.2018 10:56:10

LTE Band 25 3MHz CH-High 1GHz~3GHz

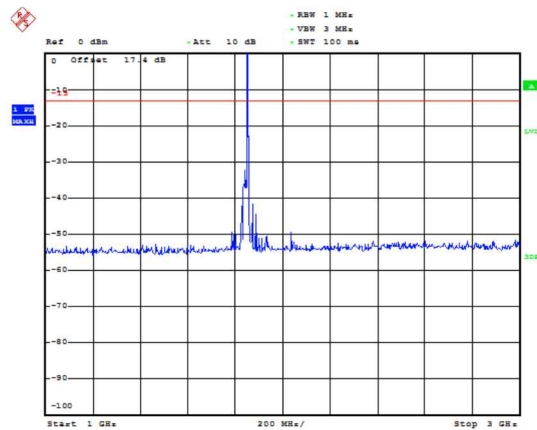

Date: 8.DEC.2018 10:56:38

LTE Band 25 3MHz CH-Middle 3GHz~20GHz

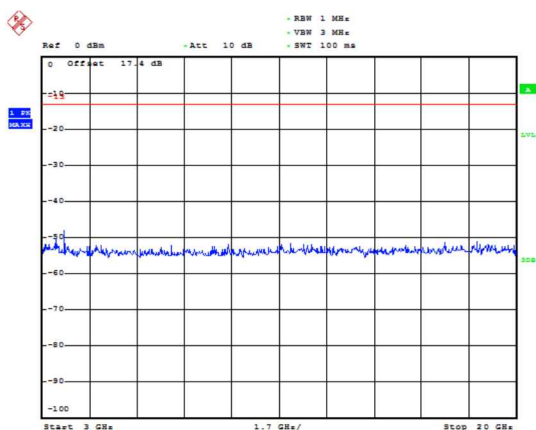

Date: 8.DEC.2018 10:56:07

LTE Band 25 3MHz CH-High 3GHz~20GHz

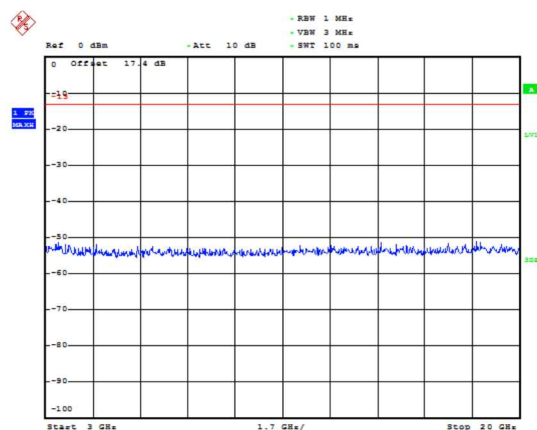

Date: 8.DEC.2018 10:56:21



LTE Band 25 5MHz CH-Low 30MHz~1GHz

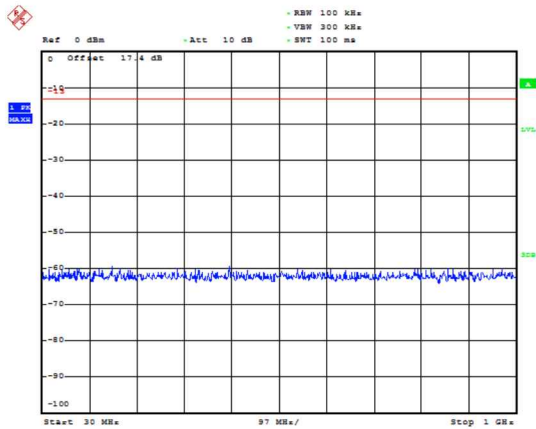

Date: 8.DEC.2018 10:56:24

LTE Band 25 5MHz CH-Middle 30MHz~1GHz

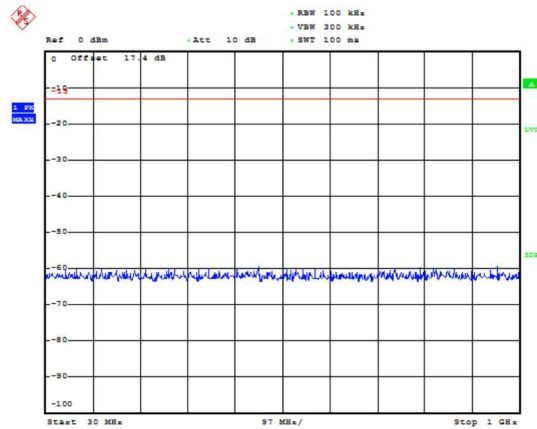

Date: 8.DEC.2018 10:56:22

LTE Band 25 5MHz CH-Low 1GHz~3GHz

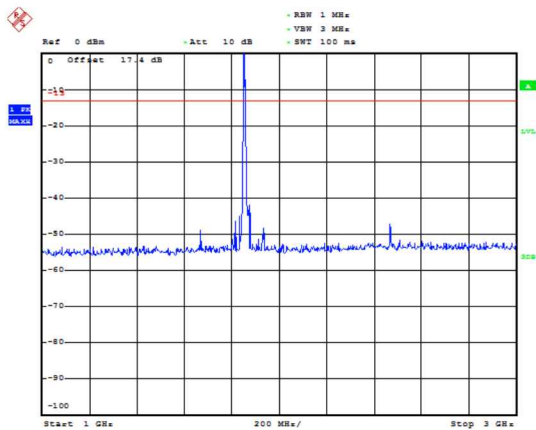

Date: 8.DEC.2018 10:56:52

LTE Band 25 5MHz CH-Middle 1GHz~3GHz

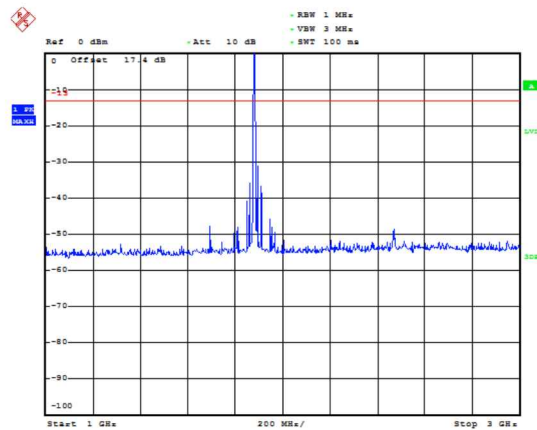

Date: 8.DEC.2018 10:44:21

LTE Band 25 5MHz CH-Low 3GHz~20GHz

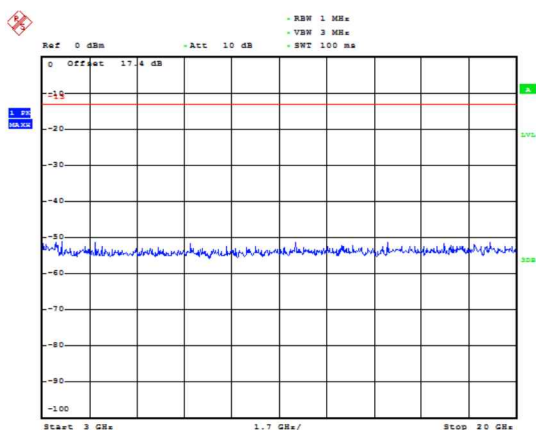

Date: 8.DEC.2018 10:57:07

LTE Band 25 5MHz CH-Middle 3GHz~20GHz

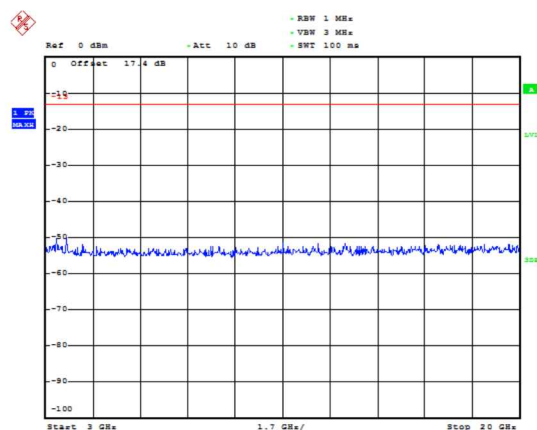

Date: 8.DEC.2018 10:47:54



LTE Band 25 5MHz CH-High 30MHz~1GHz

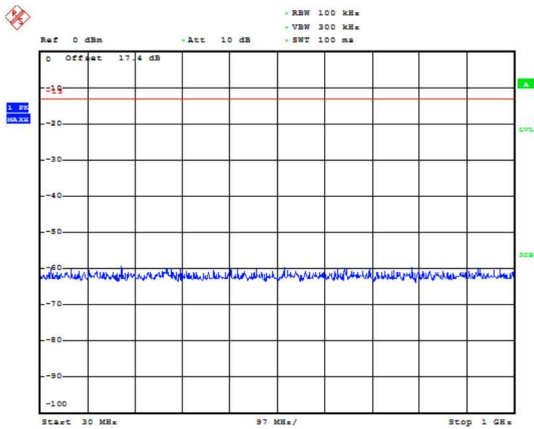

Date: 8.DEC.2018 10:59:30

LTE Band 25 10MHz CH-Low 30MHz~1GHz

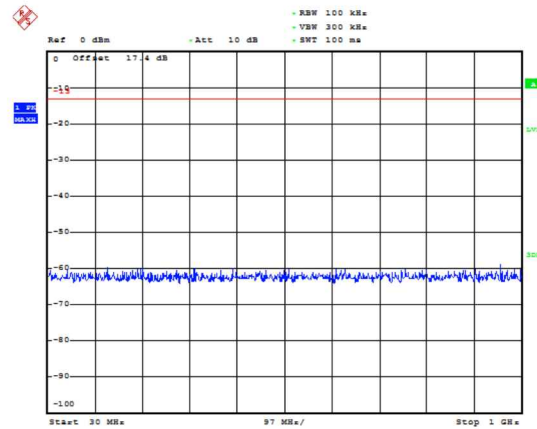

Date: 8.DEC.2018 11:00:06

LTE Band 25 5MHz CH-High 1GHz~3GHz

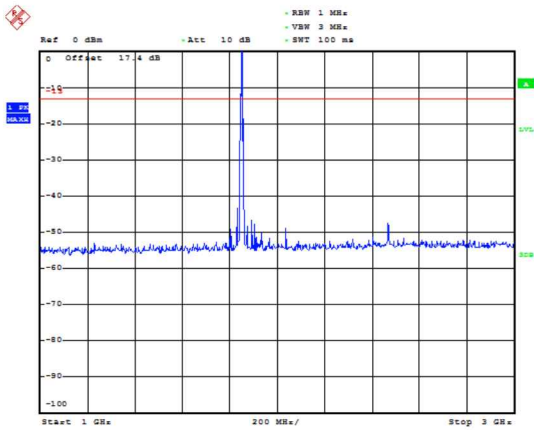

Date: 8.DEC.2018 10:58:20

LTE Band 25 10MHz CH-Low 1GHz~3GHz

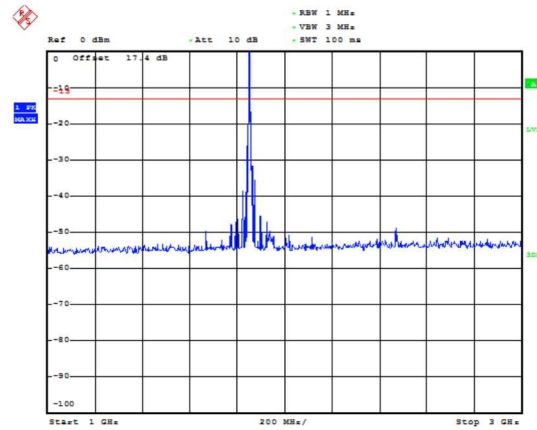

Date: 8.DEC.2018 11:00:20

LTE Band 25 5MHz CH-High 3GHz~20GHz

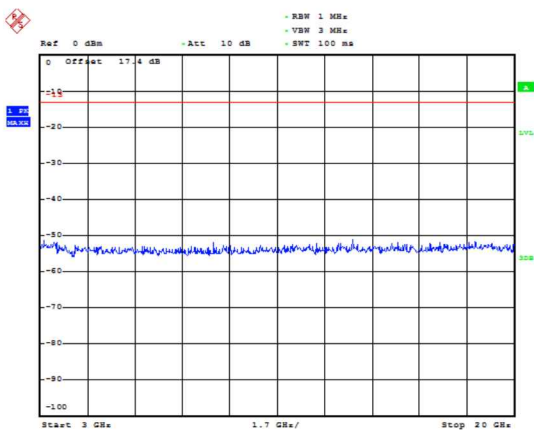

Date: 8.DEC.2018 10:58:05

LTE Band 25 10MHz CH-Low 3GHz~20GHz

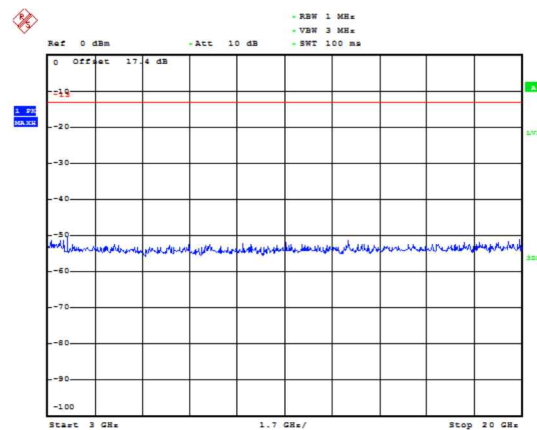

Date: 8.DEC.2018 11:00:32



LTE Band 25 10MHz CH-Middle 30MHz~1GHz

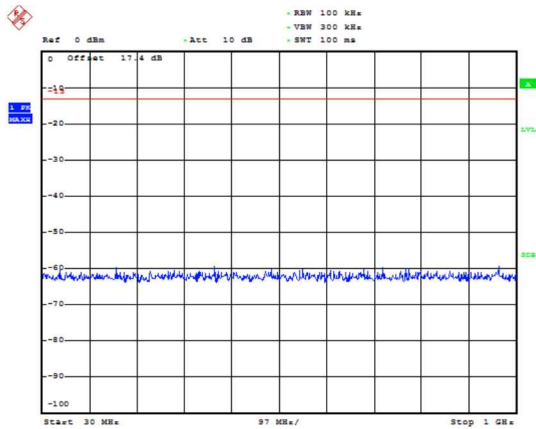

Date: 8.DEC.2018 10:26:55

LTE Band 25 10MHz CH-High 30MHz~1GHz

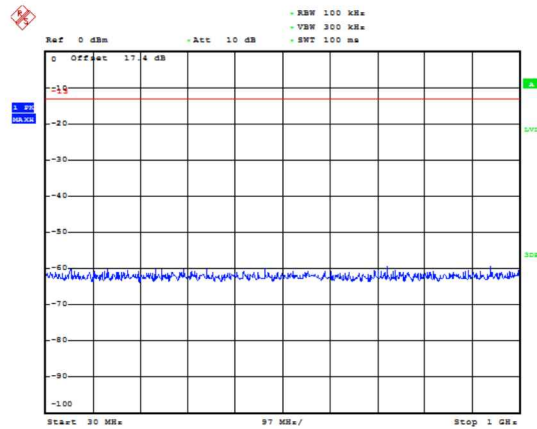

Date: 8.DEC.2018 11:01:51

LTE Band 25 10MHz CH-Middle 1GHz~3GHz

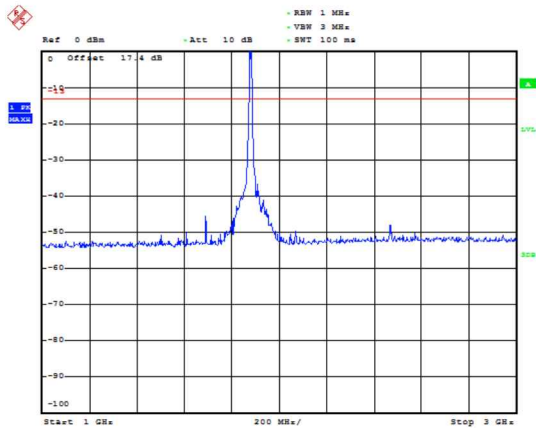

Date: 8.DEC.2018 10:45:56

LTE Band 25 10MHz CH-High 1GHz~3GHz

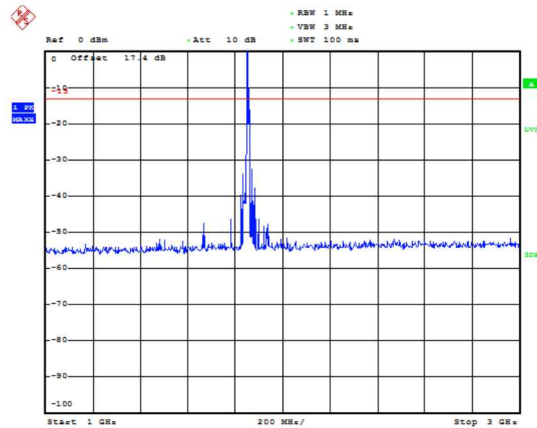

Date: 8.DEC.2018 11:01:16

LTE Band 25 10MHz CH-Middle 3GHz~20GHz

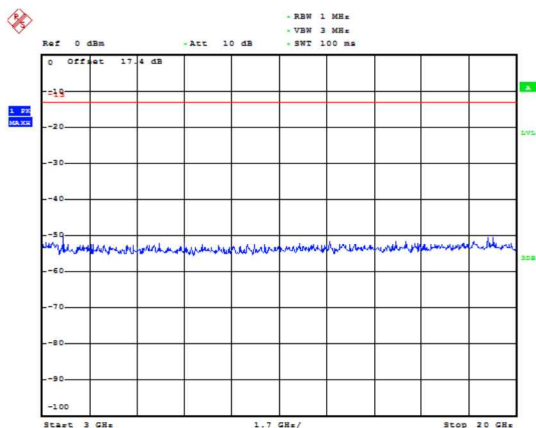

Date: 8.DEC.2018 10:47:09

LTE Band 25 10MHz CH-High 3GHz~20GHz

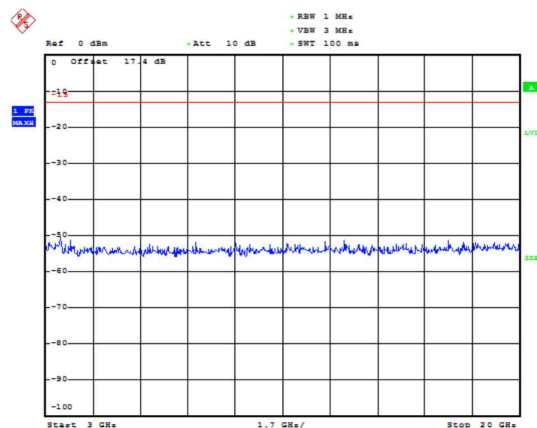

Date: 8.DEC.2018 11:01:02



LTE Band 25 15MHz CH-Low 30MHz~1GHz

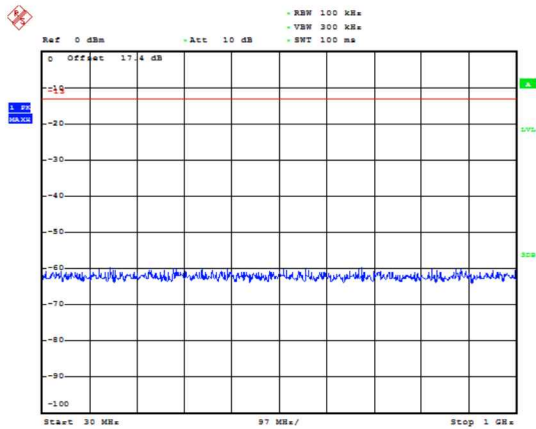

Date: 8.DEC.2018 11:02:42

LTE Band 25 15MHz CH-Middle 30MHz~1GHz

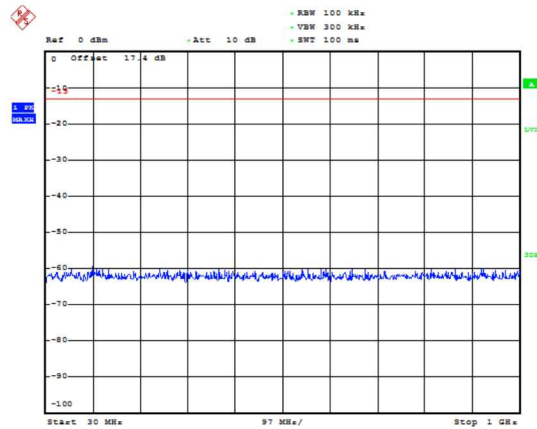

Date: 8.DEC.2018 10:57:08

LTE Band 25 15MHz CH-Low 1GHz~3GHz

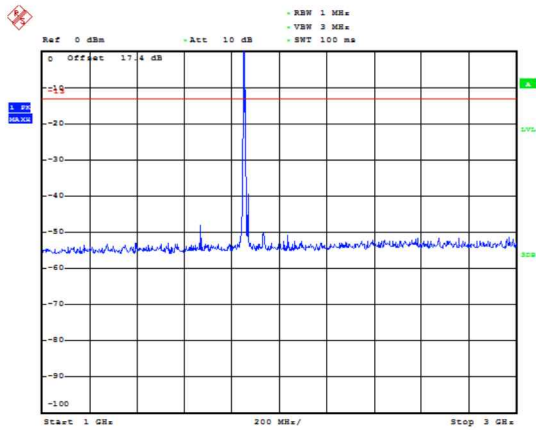

Date: 8.DEC.2018 11:03:07

LTE Band 25 15MHz CH-Middle 1GHz~3GHz

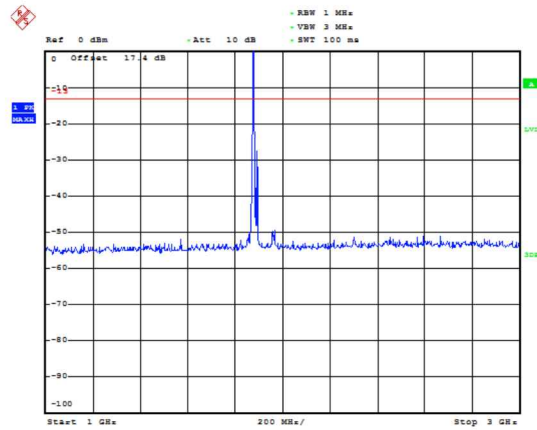

Date: 8.DEC.2018 10:46:11

LTE Band 25 15MHz CH-Low 3GHz~20GHz

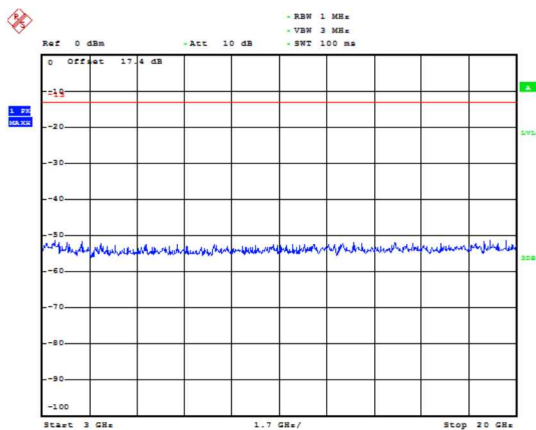

Date: 8.DEC.2018 11:03:19

LTE Band 25 15MHz CH-Middle 3GHz~20GHz

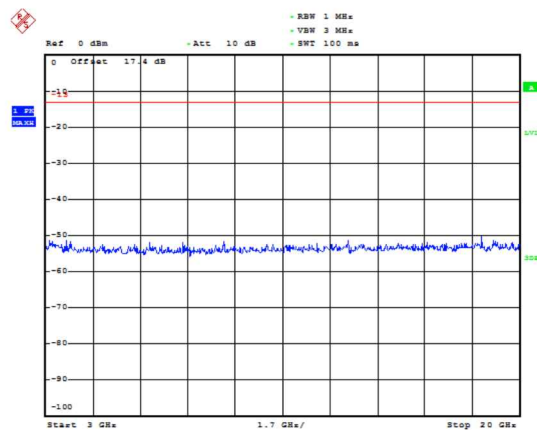

Date: 8.DEC.2018 10:46:49



LTE Band 25 15MHz CH-High 30MHz~1GHz

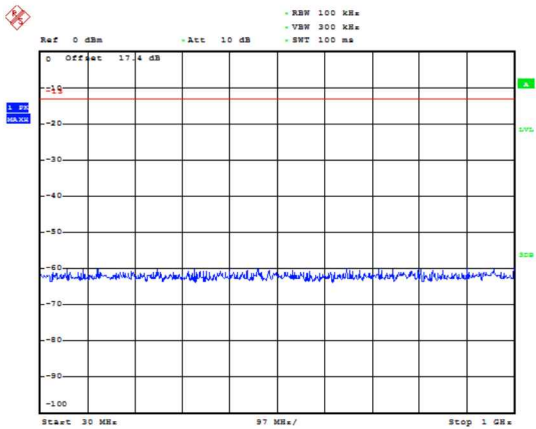

Date: 8.DEC.2018 11:06:20

LTE Band 25 20MHz CH-Low 30MHz~1GHz

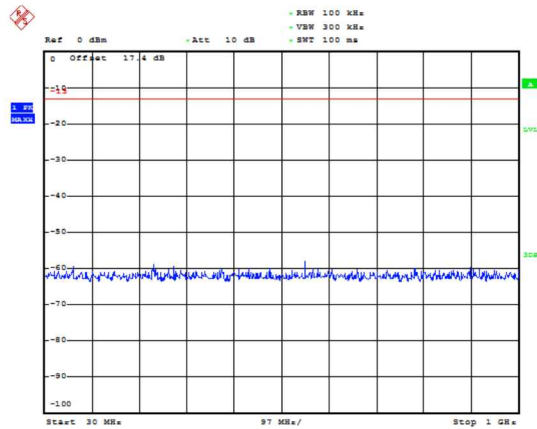

Date: 8.DEC.2018 11:06:14

LTE Band 25 15MHz CH-High 1GHz~3GHz

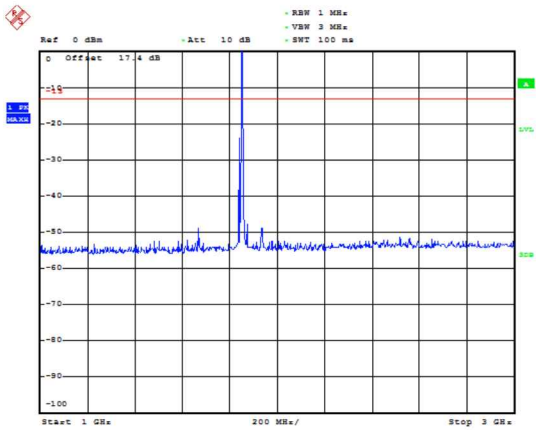

Date: 8.DEC.2018 11:09:59

LTE Band 25 20MHz CH-Low 1GHz~3GHz

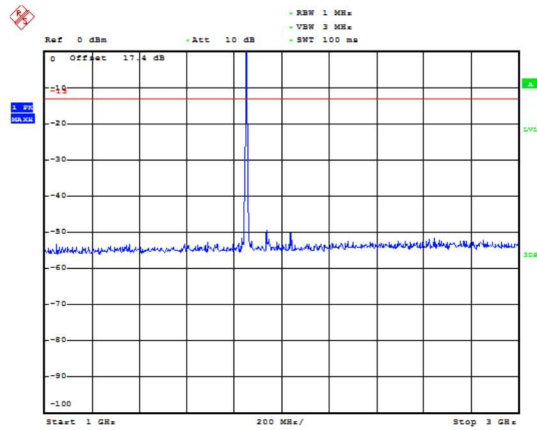

Date: 8.DEC.2018 11:06:36

LTE Band 25 15MHz CH-High 3GHz~20GHz

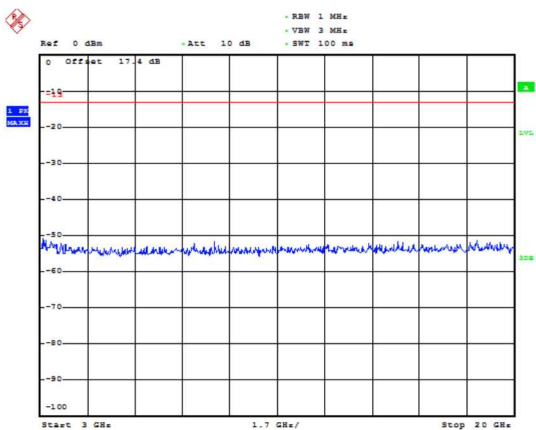

Date: 8.DEC.2018 11:09:46

LTE Band 25 20MHz CH-Low 3GHz~20GHz

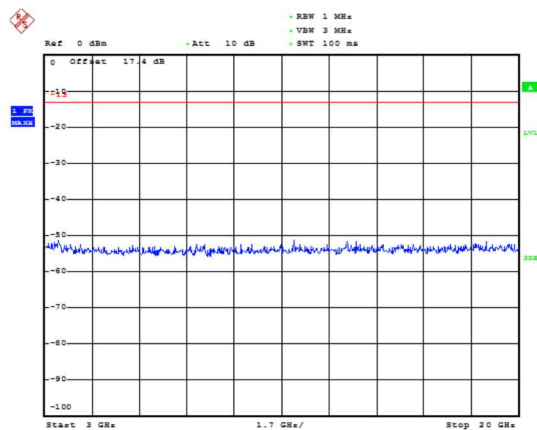

Date: 8.DEC.2018 11:06:46



LTE Band 25 20MHz CH-Middle 30MHz~1GHz

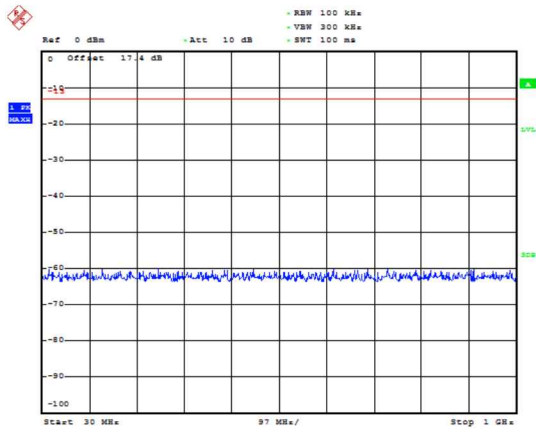

Date: 8.DEC.2018 10:27:22

LTE Band 25 20MHz CH-High 30MHz~1GHz

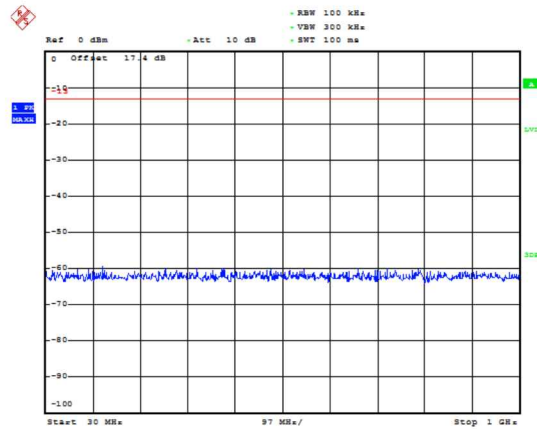

Date: 8.DEC.2018 11:07:52

LTE Band 25 20MHz CH-Middle 1GHz~3GHz

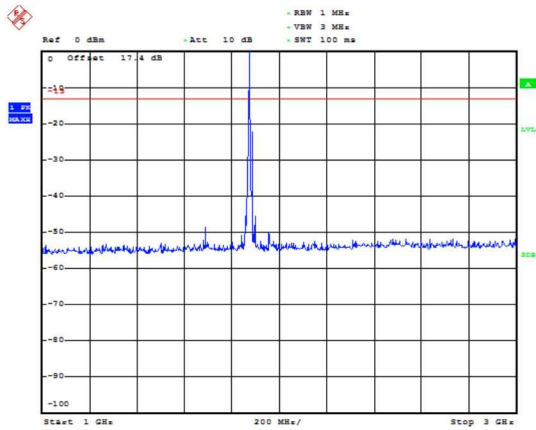

Date: 8.DEC.2018 10:27:57

LTE Band 25 20MHz CH-High 1GHz~3GHz

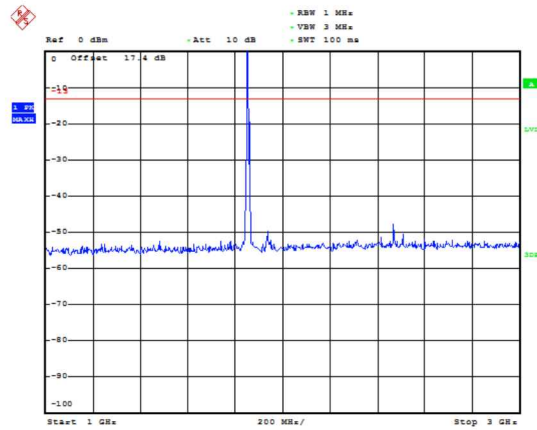

Date: 8.DEC.2018 11:07:26

LTE Band 25 20MHz CH-Middle 3GHz~20GHz

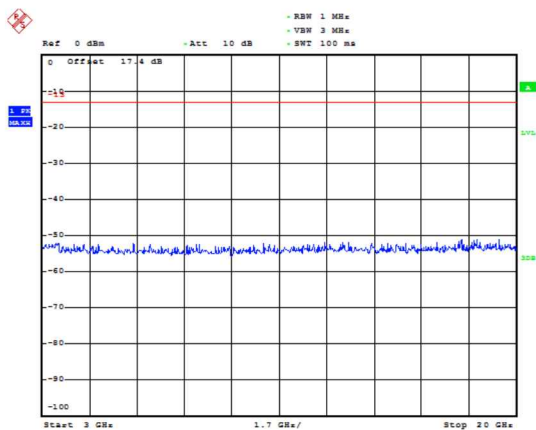

Date: 8.DEC.2018 10:47:23

LTE Band 25 20MHz CH-High 3GHz~20GHz

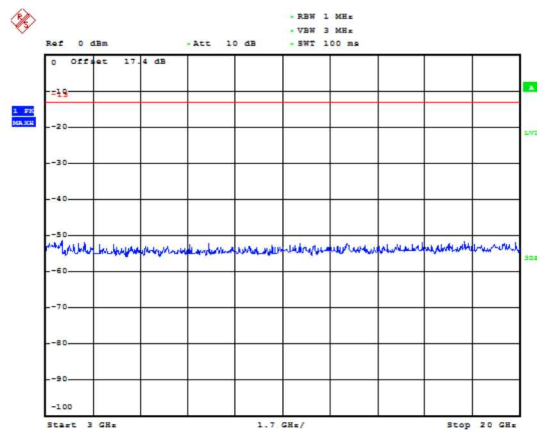

Date: 8.DEC.2018 11:07:16

5.8. Radiates Spurious Emission

Ambient condition

| Temperature | Relative humidity | Pressure |
|-------------|-------------------|----------|
| 23°C ~25°C | 45%~50% | 101.5kPa |

Method of Measurement

1. The testing follows FCC KDB 971168 v03r01 Section 5.8 and ANSI C63.26 (2015).
2. Below 1GHz: The EUT is placed on a turntable 0.8 meters above the ground in the chamber, 3 meter away from the antenna. The maximal emission value is acquired by adjusting the antenna height, polarisation and turntable azimuth. Normally, the height range of antenna is 1 m to 4 m, the azimuth range of turntable is 0° to 360°, and the receive antenna has two polarizations Vertical (V) and Horizontal (H). Above 1GHz: (Note: the FCC's permission to use 1.5m as an alternative per TCBC Conf call of Dec. 2, 2014.) The EUT is placed on a turntable 1.5 meters above the ground in the chamber, 3 meter away from the antenna. The maximal emission value is acquired by adjusting the antenna height, polarisation and turntable azimuth. Normally, the height range of antenna is 1 m to 4 m, the azimuth range of turntable is 0° to 360°, and the receive antenna has two polarizations Vertical (V) and Horizontal (H).
3. A loop antenna, A log-periodic antenna or horn antenna shall be substituted in place of the EUT. The log-periodic antenna will be driven by a signal generator and the level will be adjusted till the same power value on the spectrum analyzer or receiver. The level of the spurious emissions can be calculated through the level of the signal generator, cable loss, the gain of the substitution antenna and the reading of the spectrum analyzer or receiver.
4. The EUT is then put into continuously transmitting mode at its maximum power level during the test. Set Test Receiver or Spectrum RBW=200Hz,VBW=600Hz for 9kHz150kHz , RBW=10kHz, VBW=30kHz 150kHz-30MHz , RBW=100kHz,VBW=300kHz for 30MHz to 1GHz and RBW=1MHz, VBW=3MHz for above 1GHz, And the maximum value of the receiver should be recorded as (Pr).
5. The EUT shall be replaced by a substitution antenna. In the chamber, an substitution antenna for the frequency band of interest is placed at the reference point of the chamber. An RF Signal source for the frequency band of interest is connected to the substitution antenna with a cable that has been constructed to not interfere with the radiation pattern of the antenna. A power (PMea) is applied to the input of the substitution antenna, and adjust the level of the signal generator output until the value of the receiver reach the previously recorded (Pr). The power of signal source (PMea) is recorded. The test should be performed by rotating the test item and adjusting the receiving antenna polarization.
6. A amplifier should be connected to the Signal Source output port. And the cable should be connect between the Amplifier and the Substitution Antenna. The cable loss (Pcl) ,the Substitution Antenna Gain (Ga) and the Amplifier Gain (PAg) should be recorded after test.
7. The measurement results are obtained as described below:
$$\text{Power(EIRP)} = \text{PMea} - \text{PAg} - \text{Pcl} + \text{Ga}$$

The measurement results are amend as described below:
$$\text{Power(EIRP)} = \text{PMea} - \text{Pcl} + \text{Ga}$$
8. This value is EIRP since the measurement is calibrated using an antenna of known gain (2.15 dBi)

and known input power. ERP can be calculated from EIRP by subtracting the gain of the dipole, $ERP = EIRP - 2.15\text{dBi}$.

The modulation mode and RB allocation refer to section 5.1, using the maximum output power configuration.

Test setup

9KHz ~ 30MHz

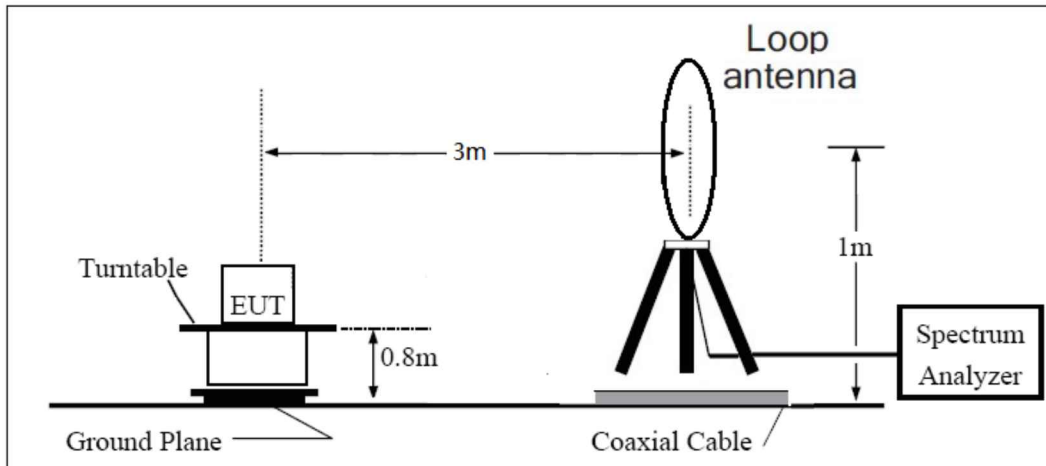

30MHz ~ 1GHz

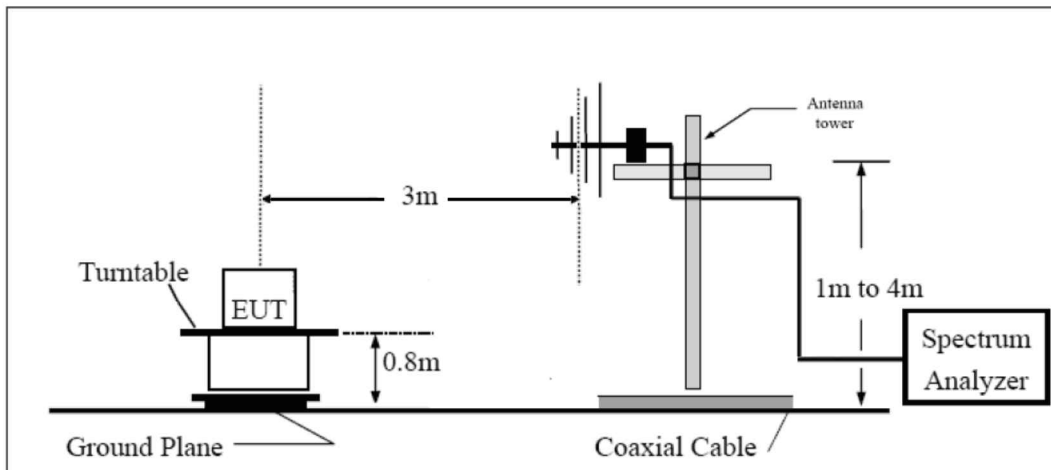

Above 1GHz

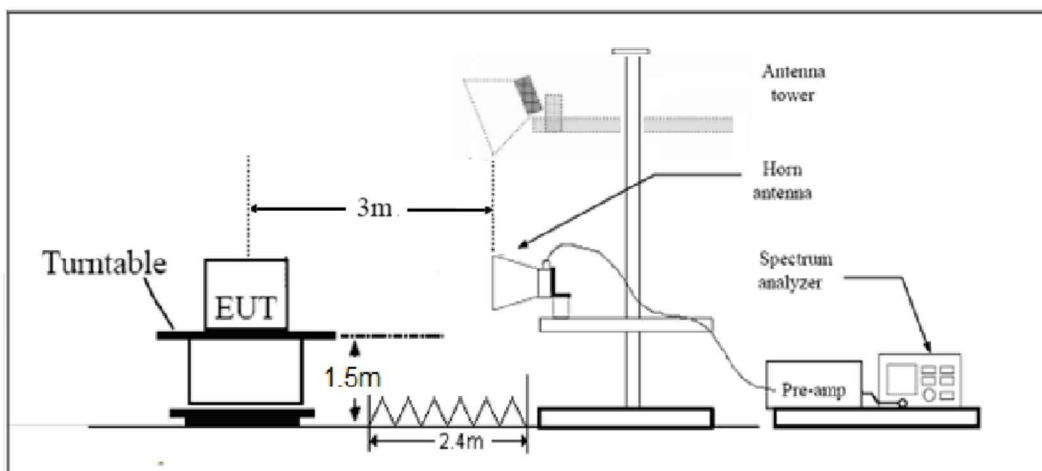



Note: Area side: 2.4mX3.6m

Limits

Rule Part 24.238(a) specifies that “on any frequency outside a licensee's frequency block, the power of any emission shall be attenuated below the transmitter power (P) by at least $43 + 10 \log_{10}(P)$ dB.”

| | |
|-------|---------|
| Limit | -13 dBm |
|-------|---------|

Measurement Uncertainty

The assessed measurement uncertainty to ensure 95% confidence level for the normal distribution is with the coverage factor $k = 1.96$, $U = 3.55$ dB.

Test Result

Sweep the whole frequency band through the range from 9kHz to the 10th harmonic of the carrier, the emissions below the noise floor will not be recorded in the report.

GSM 1900 CH-Low

| Harmonic | Frequency (MHz) | SG (dBm) | Cable Loss (dB) | Gain (dBi) | Antenna Polarization | EIRP Level (dBm) | Limit (dBm) | Margin (dB) | Azimuth (deg) |
|----------|-----------------|----------|-----------------|------------|----------------------|------------------|-------------|-------------|---------------|
| 2 | 3700 | -53.75 | 5.1 | 11.05 | vertical | -47.8 | -13.0 | 34.8 | 135 |
| 3 | 5551 | -53.93 | 5.42 | 12.65 | vertical | -46.7 | -13.0 | 33.7 | 45 |
| 4 | 7401 | -49.75 | 6.7 | 13.85 | vertical | -42.6 | -13.0 | 29.6 | 180 |
| 5 | 9251 | -48.94 | 7.01 | 14.75 | vertical | -41.2 | -13.0 | 28.2 | 270 |
| 6 | 11101 | -46.07 | 7.48 | 15.95 | vertical | -37.6 | -13.0 | 24.6 | 135 |
| 7 | 12951 | -45.64 | 7.51 | 16.55 | vertical | -36.6 | -13.0 | 23.6 | 45 |
| 8 | 14802 | -43.31 | 8.24 | 15.35 | vertical | -36.2 | -13.0 | 23.2 | 270 |
| 9 | 16652 | -40.64 | 8.41 | 14.95 | vertical | -34.1 | -13.0 | 21.1 | 180 |
| 10 | 18502 | -40.31 | 8.54 | 15.45 | vertical | -33.4 | -13.0 | 20.4 | 270 |

Note: 1.The other Spurious RF Radiated emissions level is no more than noise floor.
2.The worst emission was found in the antenna is vertical position.

GSM 1900 CH-Middle

| Harmonic | Frequency (MHz) | SG (dBm) | Cable Loss (dB) | Gain (dBi) | Antenna Polarization | EIRP Level (dBm) | Limit (dBm) | Margin (dB) | Azimuth (deg) |
|----------|-----------------|----------|-----------------|------------|----------------------|------------------|-------------|-------------|---------------|
| 2 | 3760 | -53.25 | 5.1 | 11.05 | vertical | -47.3 | -13.0 | 34.3 | 135 |
| 3 | 5640 | -53.43 | 5.42 | 12.65 | vertical | -46.2 | -13.0 | 33.2 | 45 |
| 4 | 7520 | -49.25 | 6.7 | 13.85 | vertical | -42.1 | -13.0 | 29.1 | 180 |
| 5 | 9400 | -47.94 | 7.01 | 14.75 | vertical | -40.2 | -13.0 | 27.2 | 270 |
| 6 | 11280 | -45.47 | 7.48 | 15.95 | vertical | -37.0 | -13.0 | 24.0 | 135 |
| 7 | 13160 | -45.34 | 7.51 | 16.55 | vertical | -36.3 | -13.0 | 23.3 | 45 |
| 8 | 15040 | -43.11 | 8.24 | 15.35 | vertical | -36.0 | -13.0 | 23.0 | 270 |
| 9 | 16920 | -40.64 | 8.41 | 14.95 | vertical | -34.1 | -13.0 | 21.1 | 180 |
| 10 | 18800 | -40.21 | 8.54 | 15.45 | vertical | -33.3 | -13.0 | 20.3 | 270 |

Note: 1.The other Spurious RF Radiated emissions level is no more than noise floor.
2. The worst emission was found in the antenna is vertical position.

GSM 1900 CH-High

| Harmonic | Frequency (MHz) | SG (dBm) | Cable Loss (dB) | Gain (dBi) | Antenna Polarization | EIRP Level (dBm) | Limit (dBm) | Margin (dB) | Azimuth (deg) |
|----------|-----------------|----------|-----------------|------------|----------------------|------------------|-------------|-------------|---------------|
| 2 | 3819 | -53.15 | 5.1 | 11.05 | vertical | -47.2 | -13.0 | 34.2 | 135 |
| 3 | 5730 | -52.43 | 5.42 | 12.65 | vertical | -45.2 | -13.0 | 32.2 | 45 |
| 4 | 7639 | -49.25 | 6.7 | 13.85 | vertical | -42.1 | -13.0 | 29.1 | 180 |
| 5 | 9549 | -47.94 | 7.01 | 14.75 | vertical | -40.2 | -13.0 | 27.2 | 270 |
| 6 | 11459 | -45.47 | 7.48 | 15.95 | vertical | -37.0 | -13.0 | 24.0 | 135 |
| 7 | 13369 | -45.24 | 7.51 | 16.55 | vertical | -36.2 | -13.0 | 23.2 | 45 |
| 8 | 15278 | -42.81 | 8.24 | 15.35 | vertical | -35.7 | -13.0 | 22.7 | 180 |
| 9 | 17188 | -40.64 | 8.41 | 14.95 | vertical | -34.1 | -13.0 | 21.1 | 225 |
| 10 | 19098 | -40.61 | 8.54 | 15.45 | vertical | -33.7 | -13.0 | 20.7 | 135 |

Note: 1.The other Spurious RF Radiated emissions level is no more than noise floor.
 2. The worst emission was found in the antenna is vertical position.

LTE Band 2 20MHz CH-Low

| Harmonic | Frequency (MHz) | SG (dBm) | Cable Loss (dB) | Gain (dBi) | Antenna Polarization | EIRP Level (dBm) | Limit (dBm) | Margin (dB) | Azimuth (deg) |
|----------|-----------------|----------|-----------------|------------|----------------------|------------------|-------------|-------------|---------------|
| 2 | 3720.0 | -55.25 | 5.10 | 11.05 | vertical | -49.3 | -13.0 | 36.3 | 90 |
| 3 | 5580.0 | -56.03 | 5.42 | 12.65 | vertical | -48.8 | -13.0 | 35.8 | 225 |
| 4 | 7440.0 | -48.15 | 6.70 | 13.85 | vertical | -41.0 | -13.0 | 28.0 | 45 |
| 5 | 9300.0 | -46.44 | 7.01 | 14.75 | vertical | -38.7 | -13.0 | 25.7 | 135 |
| 6 | 11160.0 | -46.57 | 7.48 | 15.95 | vertical | -38.1 | -13.0 | 25.1 | 45 |
| 7 | 13020.0 | -45.14 | 7.51 | 16.55 | vertical | -36.1 | -13.0 | 23.1 | 90 |
| 8 | 14880.0 | -41.11 | 8.24 | 15.35 | vertical | -34.0 | -13.0 | 21.0 | 225 |
| 9 | 16740.0 | -41.94 | 8.41 | 14.95 | vertical | -35.4 | -13.0 | 22.4 | 45 |
| 10 | 18600.0 | -41.41 | 8.54 | 15.45 | vertical | -34.5 | -13.0 | 21.5 | 90 |

Note: 1.The other Spurious RF Radiated emissions level is no more than noise floor.
 2.The worst emission was found in the antenna is vertical position.

LTE Band 2 20MHz CH-Middle

| Harmonic | Frequency (MHz) | SG (dBm) | Cable Loss (dB) | Gain (dBi) | Antenna Polarization | EIRP Level (dBm) | Limit (dBm) | Margin (dB) | Azimuth (deg) |
|----------|-----------------|----------|-----------------|------------|----------------------|------------------|-------------|-------------|---------------|
| 2 | 3760.0 | -55.25 | 5.10 | 11.05 | vertical | -49.3 | -13.0 | 36.3 | 135 |
| 3 | 5640.0 | -55.43 | 5.42 | 12.65 | vertical | -48.2 | -13.0 | 35.2 | 270 |
| 4 | 7520.0 | -49.85 | 6.70 | 13.85 | vertical | -42.7 | -13.0 | 29.7 | 225 |
| 5 | 9400.0 | -48.74 | 7.01 | 14.75 | vertical | -41.0 | -13.0 | 28.0 | 225 |
| 6 | 11280.0 | -46.17 | 7.48 | 15.95 | vertical | -37.7 | -13.0 | 24.7 | 135 |
| 7 | 13160.0 | -46.24 | 7.51 | 16.55 | vertical | -37.2 | -13.0 | 24.2 | 90 |
| 8 | 15040.0 | -42.31 | 8.24 | 15.35 | vertical | -35.2 | -13.0 | 22.2 | 225 |
| 9 | 16920.0 | -40.24 | 8.41 | 14.95 | vertical | -33.7 | -13.0 | 20.7 | 45 |
| 10 | 18800.0 | -40.21 | 8.54 | 15.45 | vertical | -33.3 | -13.0 | 20.3 | 135 |

Note: 1.The other Spurious RF Radiated emissions level is no more than noise floor.
 2.The worst emission was found in the antenna is vertical position.

LTE Band 2 20MHz CH-High

| Harmonic | Frequency (MHz) | SG (dBm) | Cable Loss (dB) | Gain (dBi) | Antenna Polarization | EIRP Level (dBm) | Limit (dBm) | Margin (dB) | Azimuth (deg) |
|----------|-----------------|----------|-----------------|------------|----------------------|------------------|-------------|-------------|---------------|
| 2 | 3800.0 | -55.15 | 5.10 | 11.05 | vertical | -49.2 | -13.0 | 36.2 | 45 |
| 3 | 5700.0 | -55.93 | 5.42 | 12.65 | vertical | -48.7 | -13.0 | 35.7 | 180 |
| 4 | 7600.0 | -48.45 | 6.70 | 13.85 | vertical | -41.3 | -13.0 | 28.3 | 225 |
| 5 | 9500.0 | -49.24 | 7.01 | 14.75 | vertical | -41.5 | -13.0 | 28.5 | 135 |
| 6 | 11400.0 | -44.47 | 7.48 | 15.95 | vertical | -36.0 | -13.0 | 23.0 | 225 |
| 7 | 13300.0 | -46.04 | 7.51 | 16.55 | vertical | -37.0 | -13.0 | 24.0 | 90 |
| 8 | 15200.0 | -44.11 | 8.24 | 15.35 | vertical | -37.0 | -13.0 | 24.0 | 90 |
| 9 | 17100.0 | -41.54 | 8.41 | 14.95 | vertical | -35.0 | -13.0 | 22.0 | 45 |
| 10 | 19000.0 | -40.81 | 8.54 | 15.45 | vertical | -33.9 | -13.0 | 20.9 | 180 |

Note: 1.The other Spurious RF Radiated emissions level is no more than noise floor.
 2.The worst emission was found in the antenna is vertical position.



LTE Band 25 20MHz CH-Low

| Harmonic | Frequency (MHz) | SG (dBm) | Cable Loss (dB) | Gain (dBi) | Antenna Polarization | EIRP Level (dBm) | Limit (dBm) | Margin (dB) | Azimuth (deg) |
|----------|-----------------|----------|-----------------|------------|----------------------|------------------|-------------|-------------|---------------|
| 2 | 3765.0 | -55.15 | 5.10 | 11.05 | Horizontal | -49.20 | -13.00 | 36.20 | 315 |
| 3 | 5647.5 | -60.94 | 5.42 | 12.65 | Horizontal | -53.71 | -13.00 | 40.71 | 45 |
| 4 | 7530.0 | -56.73 | 6.70 | 13.85 | Horizontal | -49.58 | -13.00 | 36.58 | 90 |
| 5 | 9412.5 | -55.94 | 7.01 | 14.75 | Horizontal | -48.20 | -13.00 | 35.20 | 270 |
| 6 | 11295.0 | -54.45 | 7.48 | 15.95 | Horizontal | -45.98 | -13.00 | 32.98 | 225 |
| 7 | 13177.5 | -55.27 | 7.51 | 16.55 | Horizontal | -46.23 | -13.00 | 33.23 | 135 |
| 8 | 15060.0 | -52.91 | 8.24 | 15.35 | Horizontal | -45.80 | -13.00 | 32.80 | 90 |
| 9 | 16942.5 | -50.31 | 8.41 | 14.95 | Horizontal | -43.77 | -13.00 | 30.77 | 45 |
| 10 | 18825.0 | - | - | - | - | - | - | - | - |

Note: 1. The other Spurious RF Radiated emissions level is no more than noise floor.
2. The worst emission was found in the antenna is Horizontal position.

LTE Band 25 20MHz CH-Middle

| Harmonic | Frequency (MHz) | SG (dBm) | Cable Loss (dB) | Gain (dBi) | Antenna Polarization | EIRP Level (dBm) | Limit (dBm) | Margin (dB) | Azimuth (deg) |
|----------|-----------------|----------|-----------------|------------|----------------------|------------------|-------------|-------------|---------------|
| 2 | 3720.0 | -50.91 | 5.10 | 11.05 | Horizontal | -44.96 | -13.00 | 31.96 | 270 |
| 3 | 5580.0 | -61.43 | 5.42 | 12.65 | Horizontal | -54.20 | -13.00 | 41.20 | 135 |
| 4 | 7440.0 | -56.15 | 6.70 | 13.85 | Horizontal | -49.00 | -13.00 | 36.00 | 45 |
| 5 | 9300.0 | -56.13 | 7.01 | 14.75 | Horizontal | -48.39 | -13.00 | 35.39 | 90 |
| 6 | 11160.0 | -54.31 | 7.48 | 15.95 | Horizontal | -45.84 | -13.00 | 32.84 | 225 |
| 7 | 13020.0 | -54.86 | 7.51 | 16.55 | Horizontal | -45.82 | -13.00 | 32.82 | 0 |
| 8 | 14880.0 | -51.57 | 8.24 | 15.35 | Horizontal | -44.46 | -13.00 | 31.46 | 45 |
| 9 | 16740.0 | -50.81 | 8.41 | 14.95 | Horizontal | -44.27 | -13.00 | 31.27 | 135 |
| 10 | 18600.0 | - | - | - | - | - | - | - | - |

Note: 1. The other Spurious RF Radiated emissions level is no more than noise floor.
2. The worst emission was found in the antenna is Horizontal position.



LTE Band 25 20MHz CH-High

| Harmonic | Frequency (MHz) | SG (dBm) | Cable Loss (dB) | Gain (dBi) | Antenna Polarization | EIRP Level (dBm) | Limit (dBm) | Margin (dB) | Azimuth (deg) |
|----------|-----------------|----------|-----------------|------------|----------------------|------------------|-------------|-------------|---------------|
| 2 | 3810.0 | -52.37 | 5.10 | 11.05 | Horizontal | -46.42 | -13.00 | 33.42 | 45 |
| 3 | 5715.0 | -61.11 | 5.42 | 12.65 | Horizontal | -53.88 | -13.00 | 40.88 | 135 |
| 4 | 7620.0 | -56.40 | 6.70 | 13.85 | Horizontal | -49.25 | -13.00 | 36.25 | 90 |
| 5 | 9525.0 | -56.03 | 7.01 | 14.75 | Horizontal | -48.29 | -13.00 | 35.29 | 225 |
| 6 | 11430.0 | -53.86 | 7.48 | 15.95 | Horizontal | -45.39 | -13.00 | 32.39 | 45 |
| 7 | 13335.0 | -53.87 | 7.51 | 16.55 | Horizontal | -44.83 | -13.00 | 31.83 | 90 |
| 8 | 15240.0 | -53.62 | 8.24 | 15.35 | Horizontal | -46.51 | -13.00 | 33.51 | 135 |
| 9 | 17145.0 | -50.64 | 8.41 | 14.95 | Horizontal | -44.10 | -13.00 | 31.10 | 315 |
| 10 | 19050.0 | - | - | - | - | - | - | - | - |

Note: 1. The other Spurious RF Radiated emissions level is no more than noise floor.

2. The worst emission was found in the antenna is Horizontal position.