

FCC Report (Bluetooth)

Product Name : ACTIVE WEATHERIZED OUTDOOR
SPEAKERS

Trade mark : ULTRA PERFORMANCE, SONTAX,
MAGNUM, Bridgeland, Ridgeline, Steel Core

Model No. : 301-8775

FCC ID : 2AVZD-MND3018775

Report Number : BLA-EMC-202003-A24-01

Date of sample receipt : March 19, 2020

Date of Test : March 19, 2020–March 27, 2019

Date of Issue : March 30, 2020

Test standard : FCC CFR Title 47 Part 15 Subpart C Section
15.247

Test result : PASS

Prepared for:

Zhejiang Focus-On Import & Export Co., Ltd
40F Intime Centre, 1600 Kijiguan Street Binjiang, Hangzhou, Zhejiang,
China

Prepared by:

BlueAsia of Technical Services(Shenzhen) Co., Ltd.
IOT Test Centre of BlueAsia
No. 448 Bulong Road, Bantian Street, Longgang District, Shenzhen,
China

TEL: +86-755-28682673

FAX: +86-755-28682673

Compiled by:

Jason

Review by:

Brand - Wei

Approved by:

Jmen li

Date: March 30, 2020



2 Version

Version No.	Date	Description
00	March 30, 2020	Original

BlueAsia

3 Contents

	Page
1 COVER PAGE	1
2 VERSION	2
3 CONTENTS	3
4 TEST SUMMARY	4
5 GENERAL INFORMATION	5
5.1 GENERAL DESCRIPTION OF EUT	5
5.2 TEST MODE	7
5.3 TEST FACILITY.....	7
5.4 TEST LOCATION.....	7
5.5 OTHER INFORMATION REQUESTED BY THE CUSTOMER.....	7
5.6 DESCRIPTION OF SUPPORT UNITS.....	7
6 TEST INSTRUMENTS LIST	8
7 TEST RESULTS AND MEASUREMENT DATA	10
7.1 ANTENNA REQUIREMENT	10
7.2 CONDUCTED EMISSIONS	11
7.3 CONDUCTED PEAK OUTPUT POWER.....	14
7.4 20DB EMISSION BANDWIDTH.....	17
7.5 CARRIER FREQUENCIES SEPARATION.....	20
7.6 HOPPING CHANNEL NUMBER	23
7.7 DWELL TIME.....	24
7.8 PSEUDORANDOM FREQUENCY HOPPING SEQUENCE	26
7.9 BAND EDGE.....	27
7.9.1 <i>Conducted Emission Method</i>	27
7.9.2 <i>Radiated Emission Method</i>	30
7.10 SPURIOUS EMISSION	32
7.10.1 <i>Conducted Emission Method</i>	32
7.10.2 <i>Radiated Emission Method</i>	34
8 TEST SETUP PHOTO	41
9 EUT CONSTRUCTIONAL DETAILS.....	43

4 Test Summary

Test Item	Section in CFR 47	Result
Antenna Requirement	15.203/15.247 (c)	Pass
AC Power Line Conducted Emission	15.207	Pass
Conducted Peak Output Power	15.247 (b)(1)	Pass
20dB Occupied Bandwidth	15.247 (a)(1)	Pass
Carrier Frequencies Separation	15.247 (a)(1)	Pass
Hopping Channel Number	15.247 (a)(1)	Pass
Dwell Time	15.247 (a)(1)	Pass
Pseudorandom Frequency Hopping Sequence	15.247(b)(4)	Pass
Radiated Emission	15.205/15.209	Pass
Band Edge	15.247(d)	Pass

Pass: The EUT complies with the essential requirements in the standard.

Remark: Test according ANSI C63.10:2013

Measurement Uncertainty

Test Item	Frequency Range	Measurement Uncertainty	Notes
Radiated Emission	9kHz ~ 30MHz	± 4.34dB	(1)
Radiated Emission	30MHz ~ 1000MHz	± 4.24dB	(1)
Radiated Emission	1GHz ~ 26.5GHz	± 4.68dB	(1)
AC Power Line Conducted Emission	0.15MHz ~ 30MHz	± 3.45dB	(1)

Note (1): The measurement uncertainty is for coverage factor of k=2 and a level of confidence of 95%.

5 General Information

5.1 General Description of EUT

Product Name:	ACTIVE WEATHERIZED OUTDOOR SPEAKERS
Model No.:	301-8775
Test Model No.:	301-8775
<i>Remark: All above models are identical in the same PCB layout, interior structure and electrical circuits. The differences are model name for commercial purpose.</i>	
Serial No.:	N/A
Sample(s) Status	Engineer sample
Hardware:	V1.0
Software:	V1.0
Operation Frequency:	2402MHz-2480MHz
Channel numbers:	79
Channel separation:	1MHz
Modulation type:	GFSK, $\pi/4$ -DQPSK
Antenna Type:	PCB Antenna
Antenna gain:	0.0dBi
Power supply:	DC 12V
AC adapter	Model:ACT-120020 Input:AC100-240V, 50/60Hz Output:DC12V,2A
Remark:The Antenna Gain is supplied by the customer.BlueAsia is not responsible for this data	

Operation Frequency each of channel							
Channel	Frequency	Channel	Frequency	Channel	Frequency	Channel	Frequency
1	2402MHz	21	2422MHz	41	2442MHz	61	2462MHz
2	2403MHz	22	2423MHz	42	2443MHz	62	2463MHz
3	2404MHz	23	2424MHz	43	2444MHz	63	2464MHz
4	2405MHz	24	2425MHz	44	2445MHz	64	2465MHz
5	2406MHz	25	2426MHz	45	2446MHz	65	2466MHz
6	2407MHz	26	2427MHz	46	2447MHz	66	2467MHz
7	2408MHz	27	2428MHz	47	2448MHz	67	2468MHz
8	2409MHz	28	2429MHz	48	2449MHz	68	2469MHz
9	2410MHz	29	2430MHz	49	2450MHz	69	2470MHz
10	2411MHz	30	2431MHz	50	2451MHz	70	2471MHz
11	2412MHz	31	2432MHz	51	2452MHz	71	2472MHz
12	2413MHz	32	2433MHz	52	2453MHz	72	2473MHz
13	2414MHz	33	2434MHz	53	2454MHz	73	2474MHz
14	2415MHz	34	2435MHz	54	2455MHz	74	2475MHz
15	2416MHz	35	2436MHz	55	2456MHz	75	2476MHz
16	2417MHz	36	2437MHz	56	2457MHz	76	2477MHz
17	2418MHz	37	2438MHz	57	2458MHz	77	2478MHz
18	2419MHz	38	2439MHz	58	2459MHz	78	2479MHz
19	2420MHz	39	2440MHz	59	2460MHz	79	2480MHz
20	2421MHz	40	2441MHz	60	2461MHz		

Note:

In section 15.31(m), regards to the operating frequency range over 10 MHz, the Lowest frequency, the middle frequency, and the highest frequency of channel were selected to perform the test, and the selected channel see below:

Channel	Frequency
The lowest channel	2402MHz
The middle channel	2441MHz
The Highest channel	2480MHz

5.2 Test mode

Transmitting mode	Keep the EUT in continuously transmitting mode with modulation. (hopping or no hopping mode)
<p><i>Remark: During the test, the test voltage was tuned from 85% to 115% of the nominal rated supply voltage, and found that the worst case was under the nominal rated supply condition. So the report just shows that condition's data.</i></p> <p><i>Full battery is used during all test except ac conducted emission, DH1, DH3, DH5 all have been tested, during the test, GFSK, Pi/4QPSK, 8-DPSK modulation were all pre-scanned only worse case is reported.</i></p>	

5.3 Test Facility

<p>The test facility is recognized, certified, or accredited by the following organizations:</p> <ul style="list-style-type: none"> ● FCC — Designation No.: CN1252 <i>BlueAsia of Technical Services(Shenzhen) Co., Ltd</i> has been registered and fully described in a report filed with the (FCC) Federal Communications Commission. The acceptance letter from the FCC is maintained in files. Designation CN1252. ● ISED — CAB identifier No.: CN0028 <i>BlueAsia of Technical Services(Shenzhen) Co., Ltd</i> has been registered by Certification and Engineering Bureau of ISED for radio equipment testing with CAB identifier CN0028

5.4 Test Location

All tests were performed at:
<p><i>All tests were performed at:</i> <i>BlueAsia of Technical Services(Shenzhen) Co., Ltd.</i> <i>IOT Test Centre of BlueAsia</i> <i>No. 448 Bulong Road, Bantian Street, Longgang District, Shenzhen, China</i> <i>Telephone: TEL: +86-755-28682673 FAX: +86-755-28682673</i> <i>No tests were sub-contracted.</i></p>

5.5 Other Information Requested by the Customer

None.

5.6 Description of Support Units

Manufacturer	Description	Model	Serial Number
Lenovo	Notebook computer	E470C	PF-10FB5C
/	/	/	/

6 Test Instruments list

Radiated Emission:						
Item	Test Equipment	Manufacturer	Model No.	Serial No.	Cal.Date (mm-dd-yy)	Cal.Due date (mm-dd-yy)
1	3m SAC	SKET	9m*6 m*6m	966	06-10-2018	06-09-2023
2	Broadband Antenna	SCHWARZBECK	VULB9168	00836 P:00227	07-14-2019	07-13-2020
3	Horn Antenna	SCHWARZBECK	9120D	01892 P:00331	07-14-2019	07-13-2020
4	EMI Test Software	EZ	EZ	N/A	N/A	N/A
5	Pre-amplifier	SKET	N/A	N/A	07-19-2019	07-18-2020
6	Spectrum analyzer	Rohde & Schwarz	FSP40	100817	05-24-2019	05-23-2020
7	EMI Test Receiver	Rohde & Schwarz	ESR7	101199	03-21-2019	03-20-2020
8	Controller	SKET	N/A	N/A	N/A	N/A
9	Vector Signal Generator	Agilent	E4438C	MY45092582	05-24-2019	05-23-2020
10	Signal Generator	Agilent	E8257D	MY44320250	05-24-2019	05-23-2020
11	Coaxial Cable	BlueAsia	BLA-XC-02	N/A	N/A	N/A
12	Coaxial Cable	BlueAsia	BLA-XC-03	N/A	N/A	N/A
13	Coaxial Cable	BlueAsia	BLA-XC-01	N/A	N/A	N/A

Conducted Emission						
Item	Test Equipment	Manufacturer	Model No.	Serial No.	Cal.Date (mm-dd-yy)	Cal.Due date (mm-dd-yy)
1	EMI Test Receiver	Rohde & Schwarz	ESPI3	101082	06-10-2019	06-09-2020
2	LISN	CHASE	MN2050D	1447	12-18-2019	12-17-2020
3	LISN	Rohde & Schwarz	ENV216	3560.6550.15	07-19-2019	07-18-2020
4	EMI Test Software	EZ	EZ	N/A	N/A	N/A
5	Temperature Humidity Chamber	Mingle	TH101B	N/A	07-19-2019	07-18-2020
6	Coaxial Cable	BlueAsia	BLA-XC-05	N/A	N/A	N/A

RF Conducted Test:						
Item	Test Equipment	Manufacturer	Model No.	Serial No.	Cal.Date (mm-dd-yy)	Cal.Due date (mm-dd-yy)
1	Spectrum Analyzer	Agilent	N9030A	MY50510123	05-24-2019	05-23-2020
2	Spectrum analyzer	Rohde & Schwarz	FSP40	100817	05-24-2019	05-23-2020
3	Vector Signal Generator	Agilent	E4438C	MY45092582	05-24-2019	05-23-2020
4	Signal Generator	Agilent	E8257D	MY44320250	05-24-2019	05-23-2020
5	Power Sensor	D.A.R.E	RPR3006W	17100015SNO27	05-24-2019	05-23-2020
6	Power Sensor	D.A.R.E	RPR3006W	17100015SNO28	05-24-2019	05-23-2020
7	DC Power Supply	LODESTAR	LP305DE	N/A	07-19-2019	07-18-2020
8	Temperature Humidity Chamber	Mingle	TH101B	N/A	07-19-2019	07-18-2020

7 Test results and Measurement Data

7.1 Antenna requirement

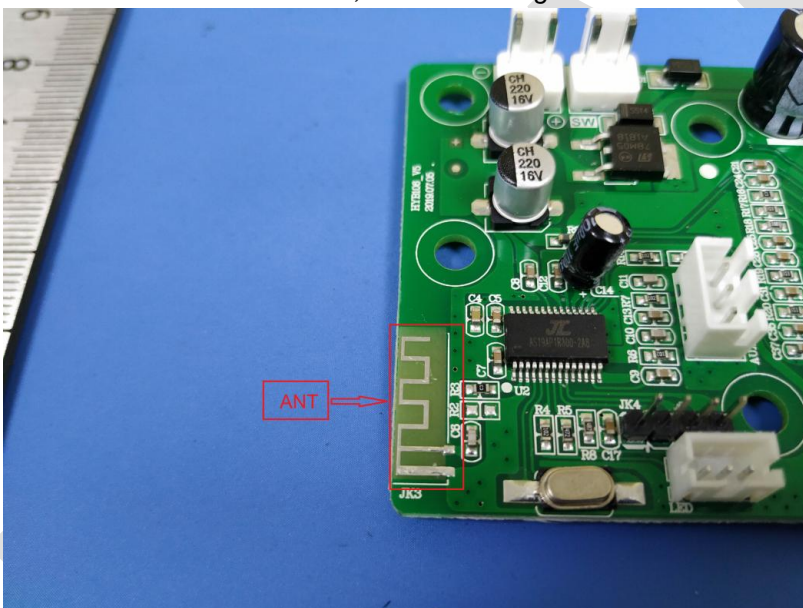
Standard requirement:	FCC Part15 C Section 15.203 /247(c)
<p>15.203 requirement: An intentional radiator shall be designed to ensure that no antenna other than that furnished by the responsible party shall be used with the device. The use of a permanently attached antenna or of an antenna that uses a unique coupling to the intentional radiator, the manufacturer may design the unit so that a broken antenna can be replaced by the user, but the use of a standard antenna jack or electrical connector is prohibited.</p> <p>15.247(c) (1)(i) requirement: (i) Systems operating in the 2400-2483.5 MHz band that is used exclusively for fixed. Point-to-point operations may employ transmitting antennas with directional gain greater than 6dBi provided the maximum conducted output power of the intentional radiator is reduced by 1 dB for every 3 dB that the directional gain of the antenna exceeds 6dBi.</p>	
E.U.T Antenna:	
<p><i>The antenna is PCB antenna, the best case gain of the antenna is 0.0dBi</i></p> 	

7.2 Conducted Emissions

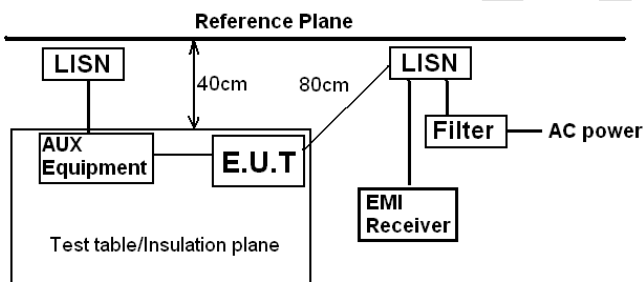
Test Requirement:	FCC Part15 C Section 15.207														
Test Method:	ANSI C63.10:2013														
Test Frequency Range:	150KHz to 30MHz														
Class / Severity:	Class B														
Receiver setup:	RBW=9KHz, VBW=30KHz, Sweep time=auto														
Limit:	<table border="1"> <thead> <tr> <th rowspan="2">Frequency range (MHz)</th> <th colspan="2">Limit (dBuV)</th> </tr> <tr> <th>Quasi-peak</th> <th>Average</th> </tr> </thead> <tbody> <tr> <td>0.15-0.5</td> <td>66 to 56*</td> <td>56 to 46*</td> </tr> <tr> <td>0.5-5</td> <td>56</td> <td>46</td> </tr> <tr> <td>5-30</td> <td>60</td> <td>50</td> </tr> </tbody> </table> <p>* Decreases with the logarithm of the frequency.</p>	Frequency range (MHz)	Limit (dBuV)		Quasi-peak	Average	0.15-0.5	66 to 56*	56 to 46*	0.5-5	56	46	5-30	60	50
Frequency range (MHz)	Limit (dBuV)														
	Quasi-peak	Average													
0.15-0.5	66 to 56*	56 to 46*													
0.5-5	56	46													
5-30	60	50													
Test setup:	 <p><i>Remark</i> E.U.T: Equipment Under Test LISN: Line Impedance Stabilization Network Test table height=0.8m</p>														
Test procedure:	<ol style="list-style-type: none"> 1. The E.U.T and simulators are connected to the main power through a line impedance stabilization network (L.I.S.N.). This provides a 50ohm/50uH coupling impedance for the measuring equipment. 2. The peripheral devices are also connected to the main power through a LISN that provides a 50ohm/50uH coupling impedance with 50ohm termination. (Please refer to the block diagram of the test setup and photographs). 3. Both sides of A.C. line are checked for maximum conducted interference. In order to find the maximum emission, the relative positions of equipment and all of the interface cables must be changed according to ANSI C63.10:2013 on conducted measurement. 														
Test Instruments:	Refer to section 6.0 for details														
Test mode:	Refer to section 5.2 for details														
Test results:	Pass														

Measurement data:

Line:

EUT:	ACTIVE WEATHERIZED OUTDOOR SPEAKERS	Probe:	L1
Model:	301-8775	Power Source:	AC120V/60Hz
Mode:	BT mode	Test by:	Eason
Temp./Hum.(%RH):	26°C/60%RH		

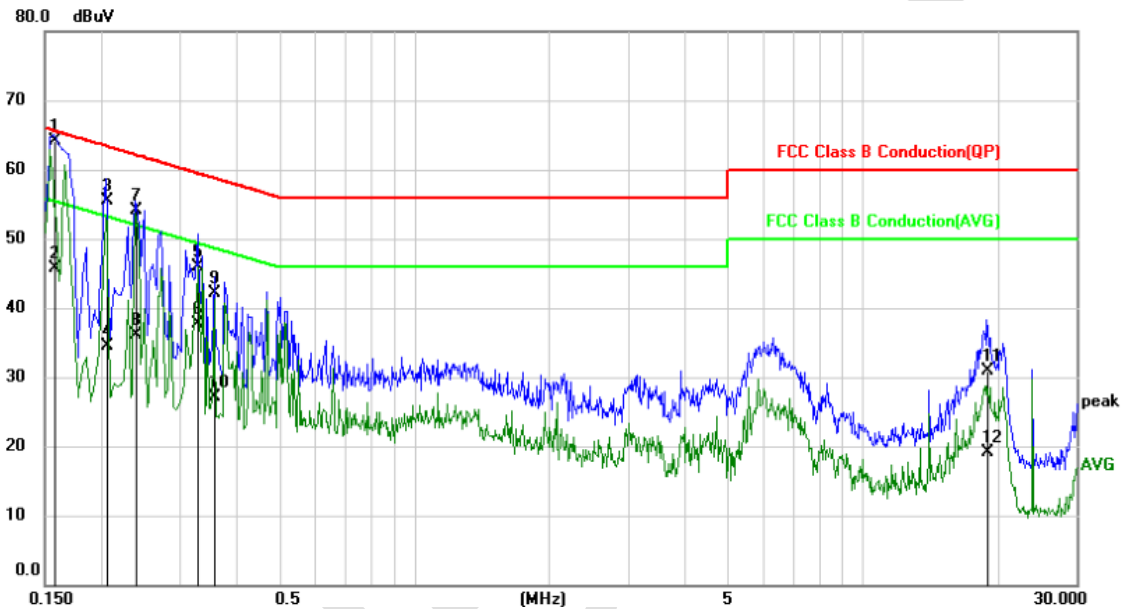

No.	Mk.	Freq. MHz	Reading Level dBuV	Correct Factor dB	Measure- ment dBuV	Limit dBuV	Over dB	Detector
1	*	0.1580	54.17	9.89	64.06	65.57	-1.51	QP
2		0.1580	35.79	9.89	45.68	55.57	-9.89	AVG
3		0.2060	45.72	9.88	55.60	63.37	-7.77	QP
4		0.2060	24.70	9.88	34.58	53.37	-18.79	AVG
5		0.3300	36.02	9.79	45.81	59.45	-13.64	QP
6		0.3300	27.98	9.79	37.77	49.45	-11.68	AVG
7		0.2380	44.08	9.93	54.01	62.17	-8.16	QP
8		0.2380	26.22	9.93	36.15	52.17	-16.02	AVG
9		0.3580	32.32	9.78	42.10	58.77	-16.67	QP
10		0.3580	17.29	9.78	27.07	48.77	-21.70	AVG
11		19.0140	20.92	10.03	30.95	60.00	-29.05	QP
12		19.0140	9.02	10.03	19.05	50.00	-30.95	AVG

Neutral:

EUT:	ACTIVE WEATHERIZED OUTDOOR SPEAKERS	Probe:	N
Model:	301-8775	Power Source:	AC120V/60Hz
Mode:	BT mode	Test by:	Eason
Temp./Hum.(%RH):	26°C/60%RH		

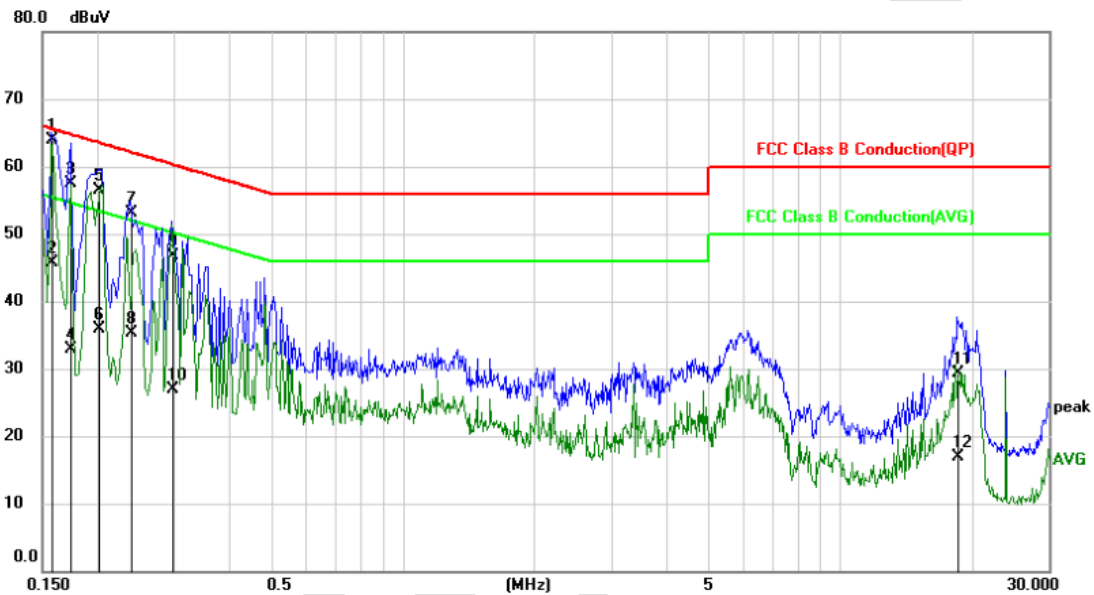

No.	Mk.	Freq.	Reading Level	Correct Factor	Measurement	Limit	Over	Detector
		MHz	dBuV	dB	dBuV	dBuV	dB	
1	*	0.1580	53.97	9.89	63.86	65.57	-1.71	QP
2		0.1580	35.89	9.89	45.78	55.57	-9.79	AVG
3		0.1740	47.55	9.90	57.45	64.77	-7.32	QP
4		0.1740	23.06	9.90	32.96	54.77	-21.81	AVG
5		0.2020	46.65	9.87	56.52	63.53	-7.01	QP
6		0.2020	26.06	9.87	35.93	53.53	-17.60	AVG
7		0.2380	43.10	9.93	53.03	62.17	-9.14	QP
8		0.2380	25.33	9.93	35.26	52.17	-16.91	AVG
9		0.2980	36.88	9.78	46.66	60.30	-13.64	QP
10		0.2980	17.13	9.78	26.91	50.30	-23.39	AVG
11		18.6220	19.22	10.02	29.24	60.00	-30.76	QP
12		18.6220	6.88	10.02	16.90	50.00	-33.10	AVG

Notes:

1. An initial pre-scan was performed on the line and neutral lines with peak detector.
2. Quasi-Peak and Average measurement were performed at the frequencies with maximized peak emission.

BlueAsia of Technical Services(Shenzhen) Co., Ltd.

IOT Test Centre of BlueAsia,

No. 448 Bulong Road, Bantian Street, Longgang District, Shenzhen, China

Telephone: TEL: +86-755-28682673 FAX: +86-755-28682673

3. Final Level =Receiver Read level +Correct Factor
4. Correct Factor = LISN Factor + Cable Loss

7.3 Conducted Peak Output Power

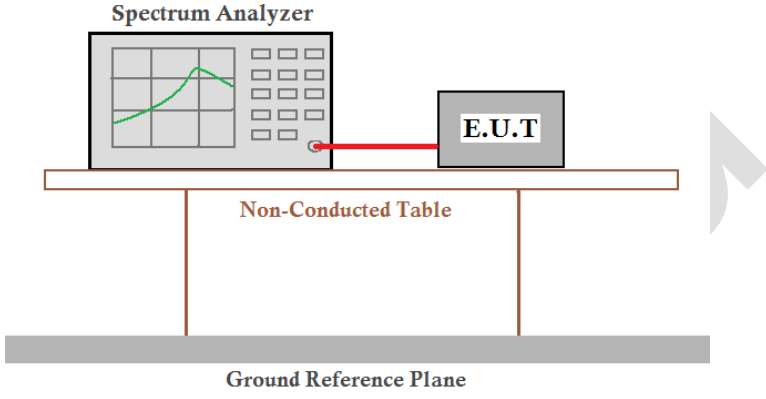
Test Requirement:	FCC Part15 C Section 15.247 (b)(3)
Test Method:	ANSI C63.10:2013
Limit:	30dBm(for GFSK),21dBm(for EDR)
Test setup:	
Test Instruments:	Refer to section 6.0 for details
Test mode:	Refer to section 5.2 for details
Test results:	Pass

Measurement Data

Mode	Test channel	Peak Output Power (dBm)	Limit (dBm)	Result
GFSK	Lowest	-3.47	30.00	Pass
	Middle	-3.45		
	Highest	-4.20		
Pi/4QPSK	Lowest	-2.24	21.00	Pass
	Middle	-2.15		
	Highest	-2.94		

Test plot as follows:

Test mode:	GFSK mode
------------	-----------

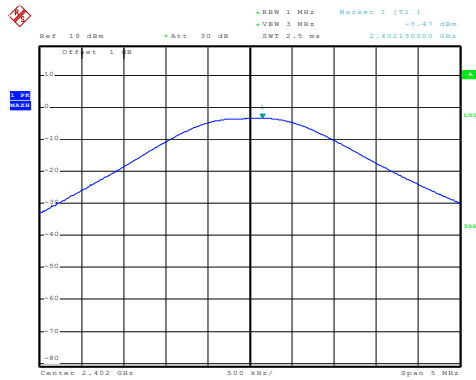

Date: 20.MAR.2020 16:44:15

Lowest channel

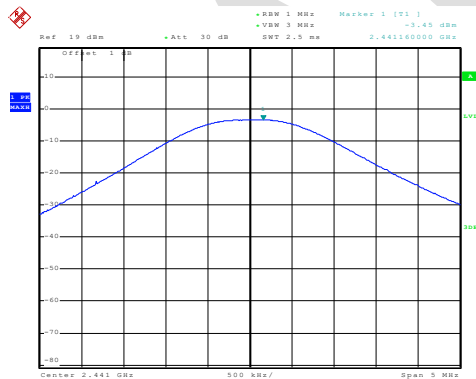

Date: 20.MAR.2020 16:45:55

Middle channel

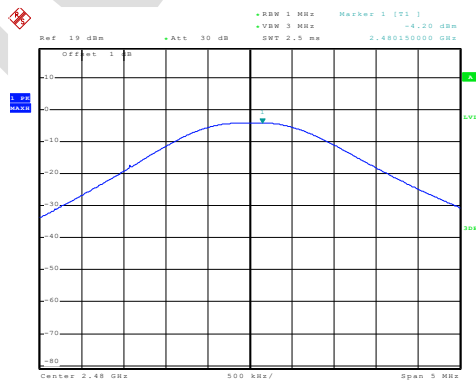

Date: 20.MAR.2020 16:46:30

Highest channel

Test mode:	Pi/4QPSK mode
------------	---------------

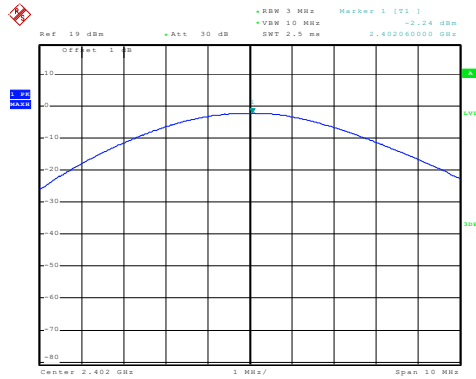

Date: 20.MAR.2020 16:50:04

Lowest channel

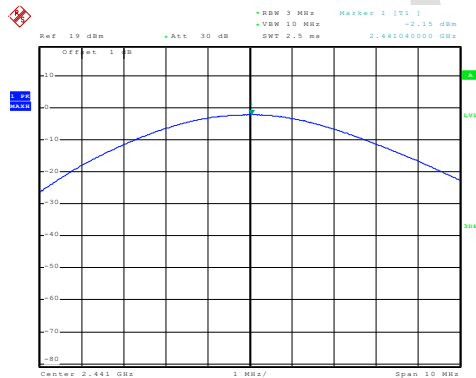

Date: 20.MAR.2020 16:49:14

Middle channel

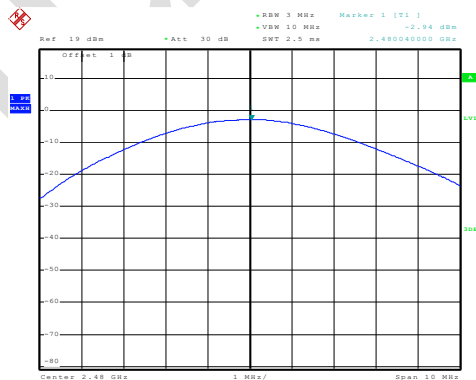

Date: 20.MAR.2020 16:48:35

Highest channel

7.4 20dB Emission Bandwidth

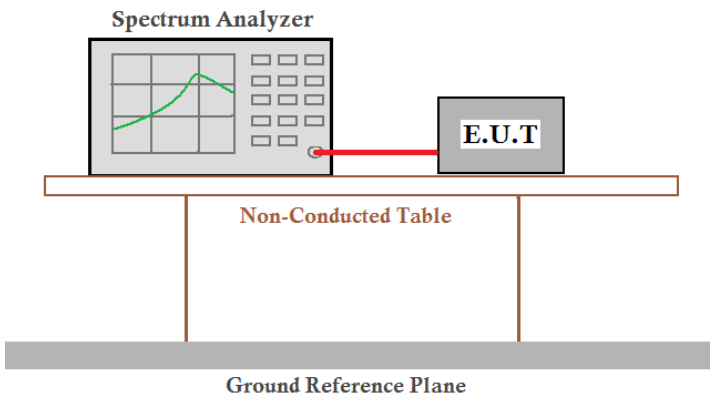
Test Requirement:	FCC Part15 C Section 15.247 (a)(1)
Test Method:	ANSI C63.10:2013
Limit:	N/A
Test setup:	
Test Instruments:	Refer to section 6.0 for details
Test mode:	Refer to section 5.2 for details
Test results:	Pass

Measurement Data

Mode	Test channel	20dB Emission Bandwidth (MHz)	Result
GFSK	Lowest	0.856	Pass
	Middle	0.860	
	Highest	0.844	
Pi/4QPSK	Lowest	1.224	Pass
	Middle	1.224	
	Highest	1.212	

Test plot as follows:

Test mode:	GFSK mode
------------	-----------

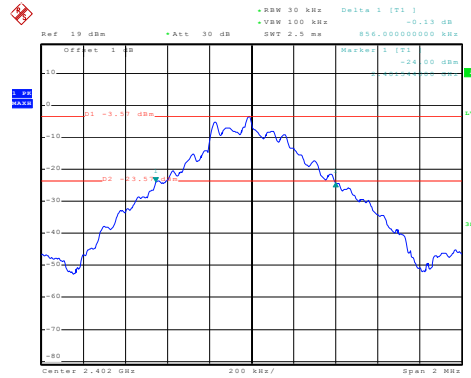

Date: 20.MAR.2020 17:00:47

Lowest channel

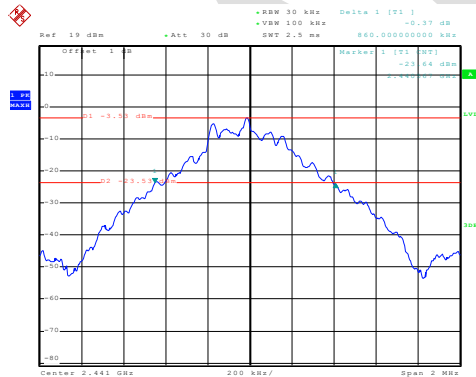

Date: 20.MAR.2020 16:59:13

Middle channel

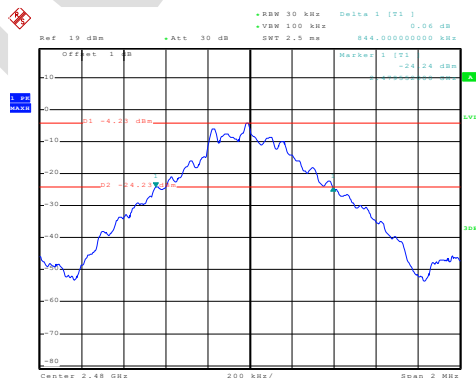

Date: 20.MAR.2020 16:58:11

Highest channel

Test mode: Pi/4QPSK mode

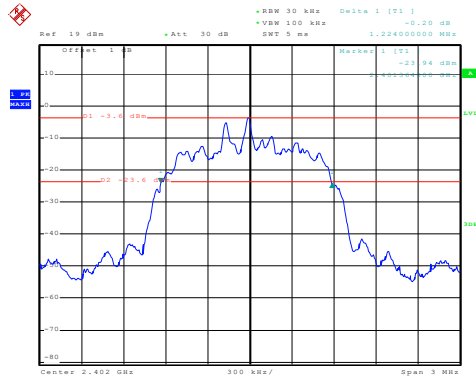

Date: 20.MAR.2020 16:54:42

Lowest channel

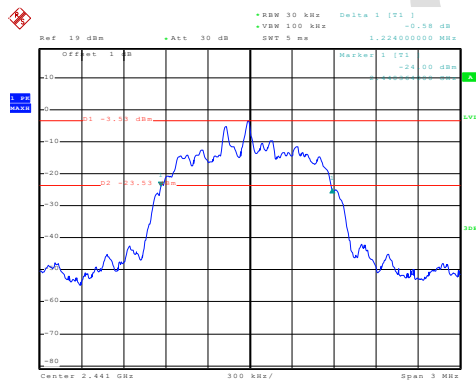

Date: 20.MAR.2020 16:56:10

Middle channel

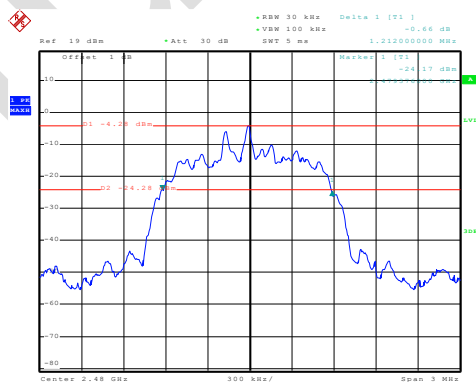

Date: 20.MAR.2020 16:57:09

Highest channel

7.5 Carrier Frequencies Separation

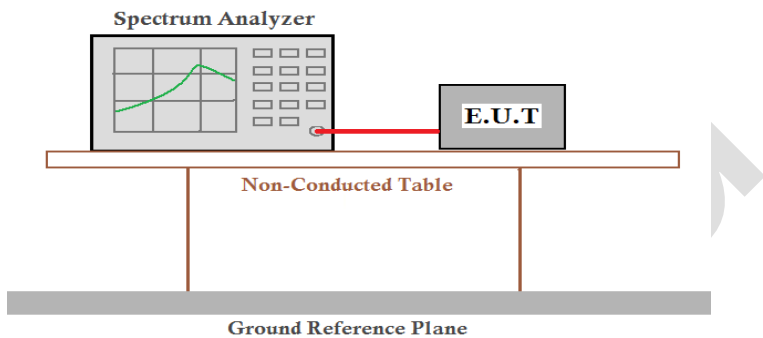
Test Requirement:	FCC Part15 C Section 15.247 (a)(1)
Test Method:	ANSI C63.10:2013
Receiver setup:	RBW=100KHz, VBW=300KHz, detector=Peak
Limit:	GFSK: 20dB bandwidth Pi/4QPSK & 8-DPSK: 0.025MHz or 2/3 of the 20dB bandwidth (whichever is greater)
Test setup:	
Test Instruments:	Refer to section 6.0 for details
Test mode:	Refer to section 5.2 for details
Test results:	Pass

Measurement Data

Mode	Test channel	Carrier Frequencies Separation (kHz)	Limit (kHz)	Result
GFSK	Lowest	1004	860	Pass
	Middle	1004	860	Pass
	Highest	1004	860	Pass
Pi/4QPSK	Lowest	1004	816	Pass
	Middle	1004	816	Pass
	Highest	1004	816	Pass

Note: According to section 7.4

Mode	20dB bandwidth (kHz) (worse case)	Limit (kHz) (Carrier Frequencies Separation)
GFSK	860	860
Pi/4QPSK	1224	816

Test plot as follows:

Modulation mode:	GFSK
------------------	------

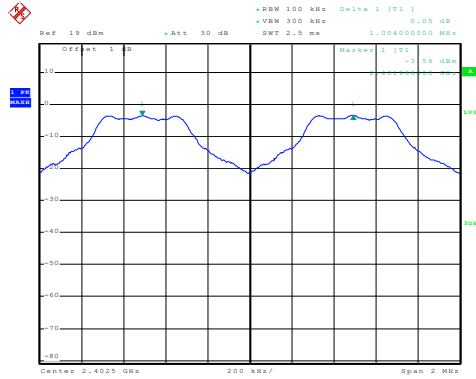

Date: 20.MAR.2020 18:11:53

Lowest channel

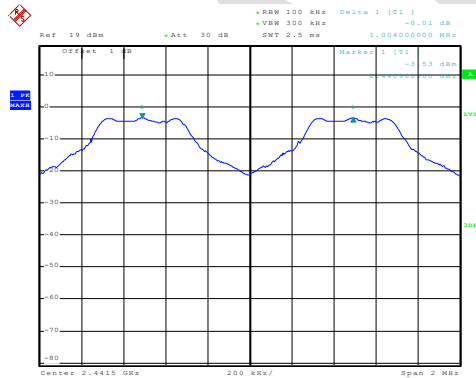

Date: 20.MAR.2020 18:12:48

Middle channel

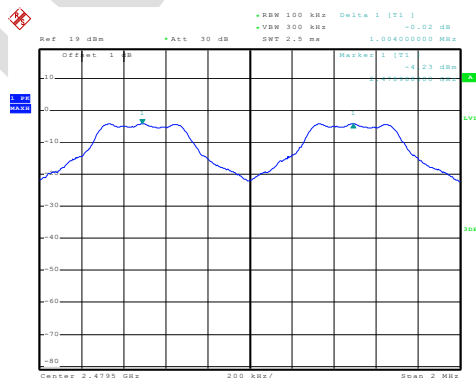

Date: 20.MAR.2020 18:13:57

Highest channel

Test mode: Pi/4QPSK mode

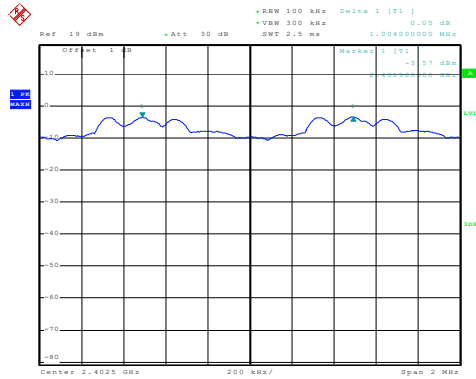

Date: 20.MAR.2020 18:08:38

Lowest channel

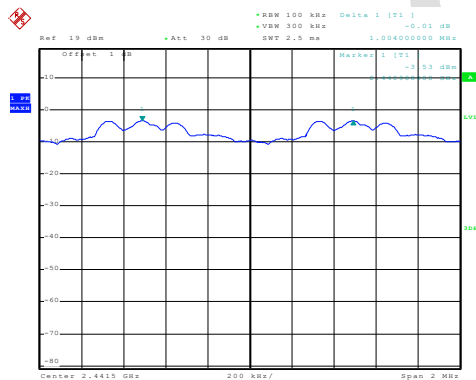

Date: 20.MAR.2020 18:09:37

Middle channel

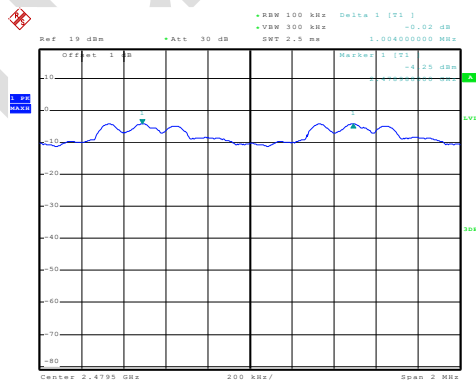

Date: 20.MAR.2020 18:10:33

Highest channel

7.6 Hopping Channel Number

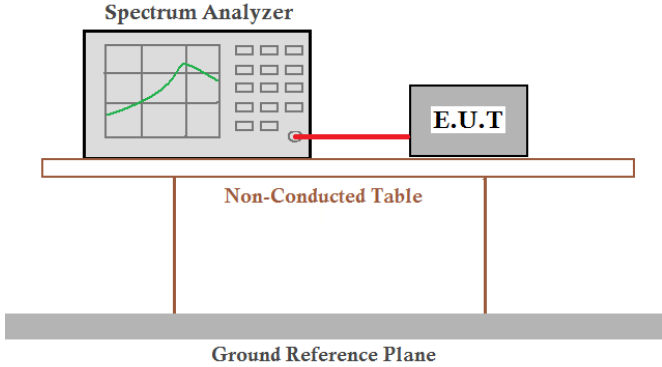
Test Requirement:	FCC Part15 C Section 15.247 (a)(1)
Test Method:	ANSI C63.10:2013
Receiver setup:	RBW=100kHz, VBW=300kHz, Frequency range=2400MHz-2483.5MHz, Detector=Peak
Limit:	15 channels
Test setup:	
Test Instruments:	Refer to section 6.0 for details
Test mode:	Refer to section 5.2 for details
Test results:	Pass

Measurement Data:

Mode	Hopping channel numbers	Limit	Result
GFSK	79	15	Pass
Pi/4QPSK	79	15	Pass

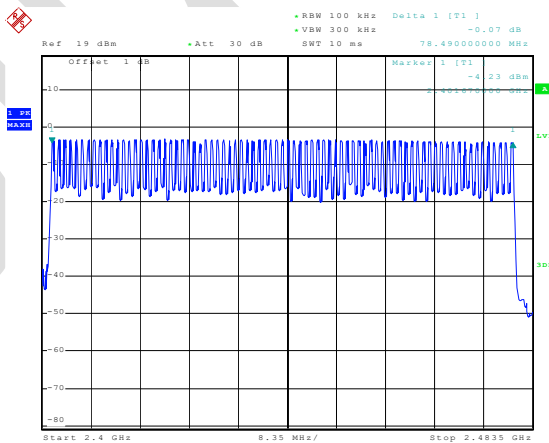

Date: 20.MAR.2020 17:05:20

7.7 Dwell Time

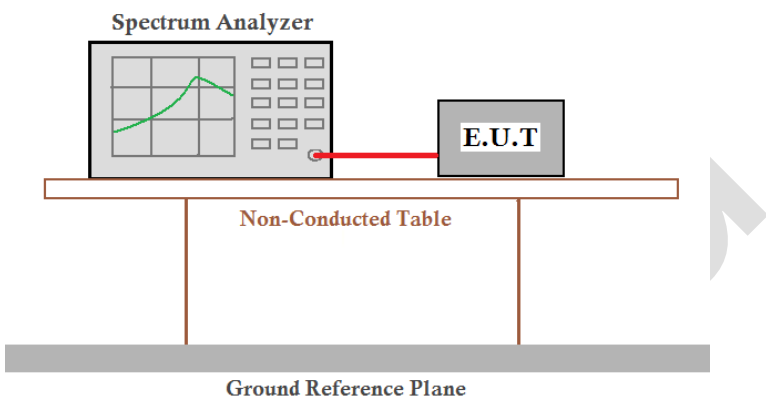
Test Requirement:	FCC Part15 C Section 15.247 (a)(1)
Test Method:	ANSI C63.10:2013
Receiver setup:	RBW=1MHz, VBW=1MHz, Span=0Hz, Detector=Peak
Limit:	0.4 Second
Test setup:	
Test Instruments:	Refer to section 6.0 for details
Test mode:	Refer to section 5.2 for details
Test results:	Pass

Measurement Data

Frequency	Packet	Dwell time(ms)	Limit(ms)	Result
2441MHz	DH1/2-DH1	136.32	400	Pass
2441MHz	DH3/2-DH3	270.72	400	Pass
2441MHz	DH5/2-DH5	314.88	400	Pass

The test period: $T = 0.4 \text{ Second/Channel} \times 79 \text{ Channel} = 31.6 \text{ s}$

Test channel: 2441MHz as blow

DH1/2-DH1 time slot = $0.426(\text{ms}) \times (1600 / (2 \times 79)) \times 31.6 = 136.32\text{ms}$

DH3/2-DH3 time slot = $1.692(\text{ms}) \times (1600 / (4 \times 79)) \times 31.6 = 270.72\text{ms}$

DH5/2-DH5 time slot = $2.952(\text{ms}) \times (1600 / (6 \times 79)) \times 31.6 = 314.88\text{ms}$

Test plot as follows:

Test channel:	2441MHz
---------------	---------

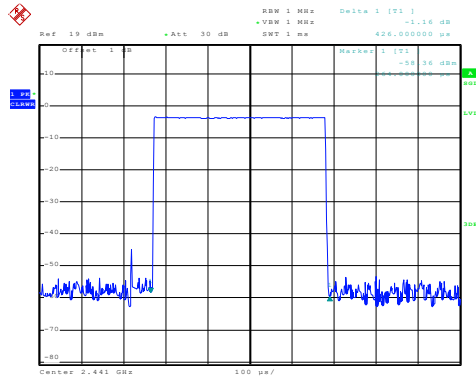

Date: 20.MAR.2020 17:09:16

DH1/2-DH1

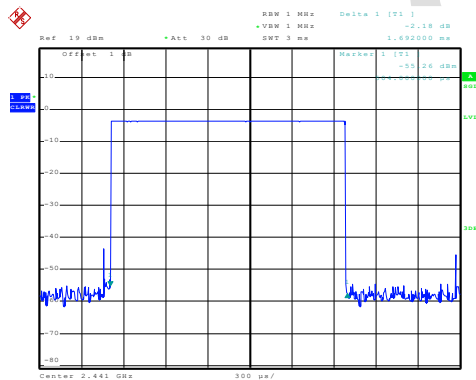

Date: 20.MAR.2020 17:10:38

DH3/2-DH3

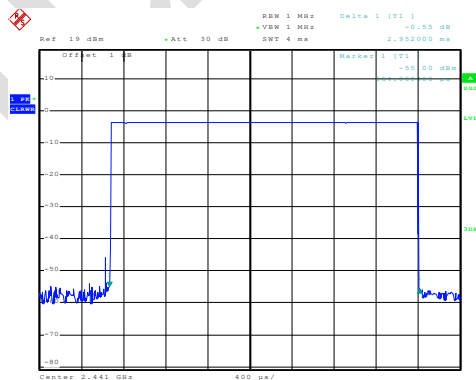

Date: 20.MAR.2020 17:12:29

DH5/2-DH5

7.8 Pseudorandom Frequency Hopping Sequence

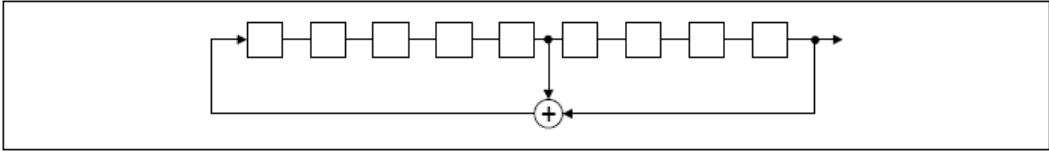
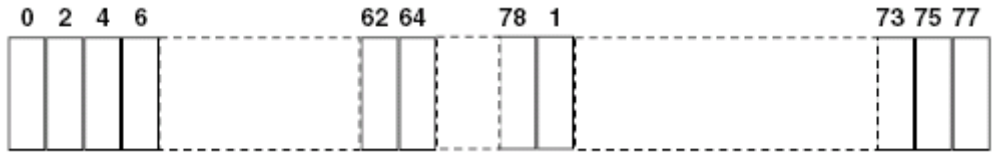
Test Requirement:	FCC Part15 C Section 15.247 (a)(1) requirement:
<p><i>Frequency hopping systems shall have hopping channel carrier frequencies separated by a minimum of 25 kHz or the 20 dB bandwidth of the hopping channel, whichever is greater.</i></p> <p><i>Alternatively. Frequency hopping systems operating in the 2400-2483.5 MHz band may have hopping channel carrier frequencies that are separated by 25 kHz or two-thirds of the 20 dB bandwidth of the hopping channel, whichever is greater, provided the systems operate with an output power no greater than 125 mW. The system shall hop to channel frequencies that are selected at the system hopping rate from a Pseudorandom ordered list of hopping frequencies. Each frequency must be used equally on the average by each transmitter. The system receivers shall have input bandwidths that match the hopping channel bandwidths of their corresponding transmitters and shall shift frequencies in synchronization with the transmitted signals.</i></p>	
EUT Pseudorandom Frequency Hopping Sequence	
<p><i>The pseudorandom sequence may be generated in a nine-stage shift register whose 5th and 9th stage outputs are added in a modulo-two addition stage. And the result is fed back to the input of the first stage. The sequence begins with the first ONE of 9 consecutive ONES; i.e. the shift register is initialized with nine ones.</i></p> <ul style="list-style-type: none"> • Number of shift register stages: 9 • Length of pseudo-random sequence: $2^9 - 1 = 511$ bits • Longest sequence of zeros: 8 (non-inverted signal) <div data-bbox="244 1016 1297 1167" style="border: 1px solid black; padding: 10px; text-align: center;">  </div> <p style="text-align: center;"><i>Linear Feedback Shift Register for Generation of the PRBS sequence</i></p> <p><i>An example of Pseudorandom Frequency Hopping Sequence as follow:</i></p> <div data-bbox="244 1265 1241 1417" style="border: 1px dashed black; padding: 10px; text-align: center;">  </div> <p><i>Each frequency used equally on the average by each transmitter.</i></p> <p><i>The system receivers have input bandwidths that match the hopping channel bandwidths of their corresponding transmitters and shift frequencies in synchronization with the transmitted signals.</i></p>	

7.9 Band Edge

7.9.1 Conducted Emission Method

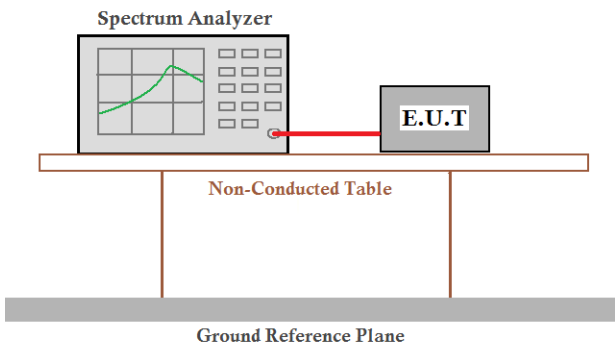
Test Requirement:	FCC Part15 C Section 15.247 (d)
Test Method:	ANSI C63.10:2013
Receiver setup:	RBW=100kHz, VBW=300kHz, Detector=Peak
Limit:	In any 100 kHz bandwidth outside the frequency band in which the spread spectrum intentional radiator is operating, the radio frequency power that is produced by the intentional radiator shall be at least 20 dB below that in the 100 kHz bandwidth within the band that contains the highest level of the desired power, based on either an RF conducted or a radiated measurement.
Test setup:	 <p>The diagram illustrates the test setup. A Spectrum Analyzer is connected to an E.U.T. (Equipment Under Test) via a red cable. Both are placed on a Non-Conducted Table, which is supported by two legs. Below the table is a Ground Reference Plane.</p>
Test Instruments:	Refer to section 6.0 for details
Test mode:	Refer to section 5.2 for details
Test results:	Pass

Test plot as follows:

GFSK Mode:

Test channel:	Lowest channel
---------------	----------------

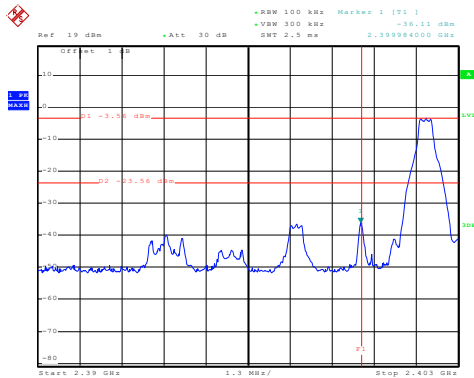

Date: 20.MAR.2020 18:17:20

No-hopping mode

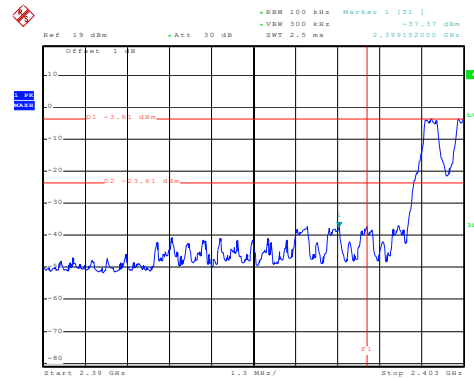

Date: 20.MAR.2020 18:24:58

Hopping mode

Test channel:	Highest channel
---------------	-----------------

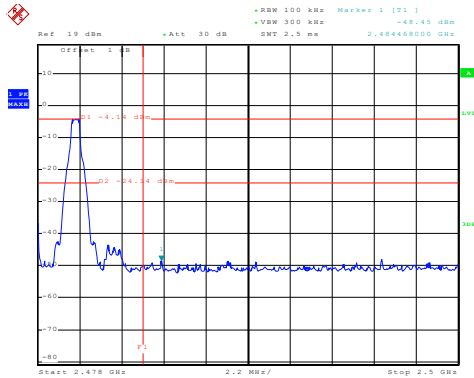

Date: 20.MAR.2020 18:19:04

No-hopping mode

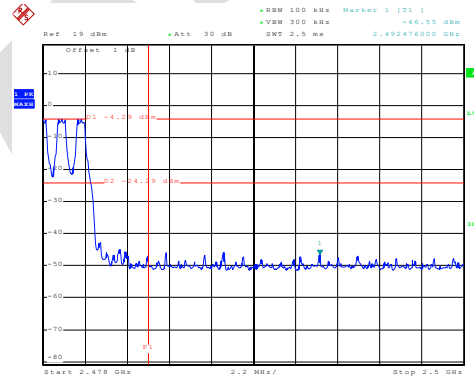

Date: 20.MAR.2020 18:22:53

Hopping mode

Pi/4QPSK Mode:

Test channel:	Lowest channel
---------------	----------------

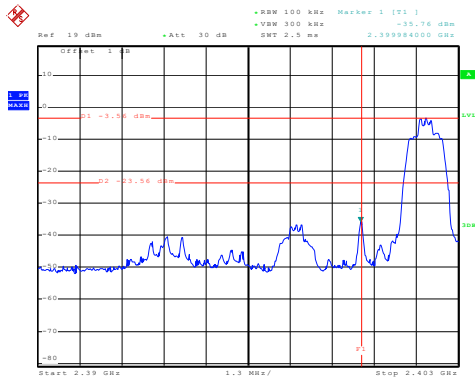

Date: 20.MAR.2020 18:12:20

No-hopping mode

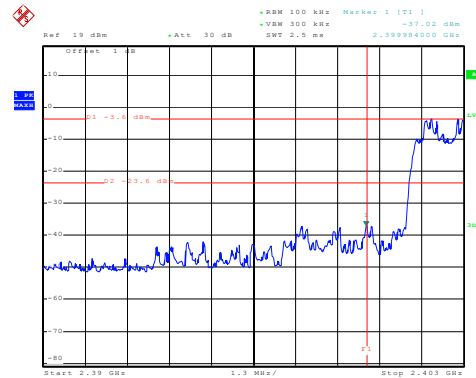

Date: 20.MAR.2020 18:27:15

Hopping mode

Test channel:	Highest channel
---------------	-----------------

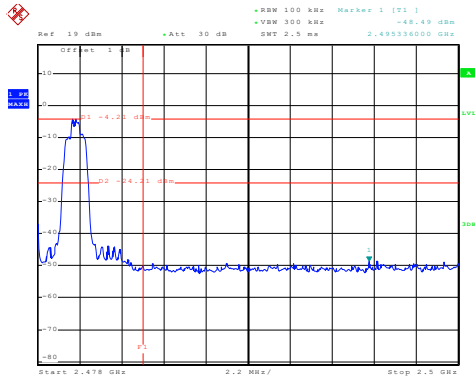

Date: 20.MAR.2020 18:30:04

No-hopping mode

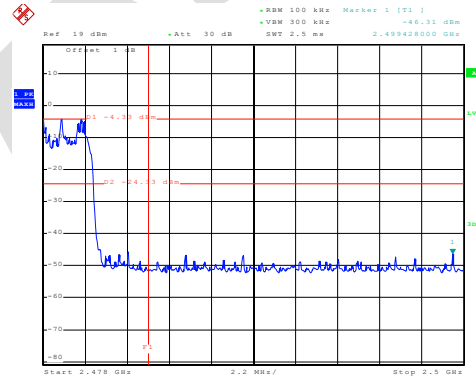

Date: 20.MAR.2020 18:28:44

Hopping mode

7.9.2 Radiated Emission Method

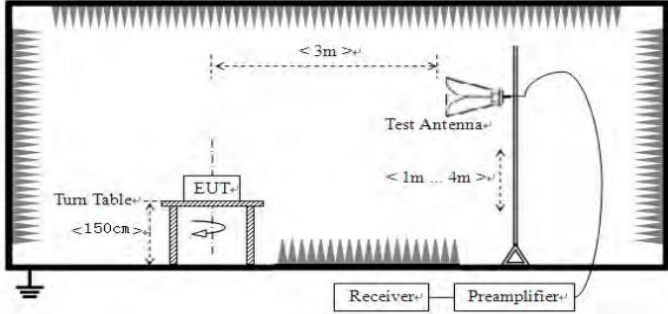
Test Requirement:	FCC Part15 C Section 15.209 and 15.205				
Test Method:	ANSI C63.10:2013				
Test Frequency Range:	All restriction band have been tested, and 2310MHz to 2390MHz, 2483.5MHz to 2500MHz band is the worse case				
Test site:	Measurement Distance: 3m				
Receiver setup:	Frequency	Detector	RBW	VBW	Remark
	Above 1GHz	Peak	1MHz	3MHz	Peak Value
		Peak	1MHz	10Hz	Average Value
Limit:	Frequency		Limit (dBuV/m @3m)		Remark
	Above 1GHz		54.00		Average Value
			74.00		Peak Value
Test setup:					
Test Procedure:	<ol style="list-style-type: none"> 1. The EUT was placed on the top of a rotating table 1.5 meters above the ground at a 3 meter camber. The table was rotated 360 degrees to determine the position of the highest radiation. 2. The EUT was set 3 meters away from the interference-receiving antenna, which was mounted on the top of a variable-height antenna tower. 3. The antenna height is varied from one meter to four meters above the ground to determine the maximum value of the field strength. Both horizontal and vertical polarizations of the antenna are set to make the measurement. 4. For each suspected emission, the EUT was arranged to its worst case and then the antenna was tuned to heights from 1 meter to 4 meters and the rota table was turned from 0 degrees to 360 degrees to find the maximum reading. 5. The test-receiver system was set to Peak Detect Function and Specified Bandwidth with Maximum Hold Mode. 6. If the emission level of the EUT in peak mode was 10dB lower than the limit specified, then testing could be stopped and the peak values of the EUT would be reported. Otherwise the emissions that did not have 10dB margin would be re-tested one by one using peak, quasi-peak or average method as specified and then reported in a data sheet. 				
Test Instruments:	Refer to section 6.0 for details				
Test mode:	Refer to section 5.2 for details				
Test results:	Pass				

Remark:

1. During the test, pre-scan the GFSK, Pi/4QPSK modulation, and found the Pi/4QPSK modulation which it is worse case.

Test channel:	Lowest
---------------	--------

Peak value:

Frequency (MHz)	Read Level (dBuV)	Correct factor (dB/m)	Level (dBuV/m)	Limit Line (dBuV/m)	Over Limit (dB)	Polarization
2310.00	45.24	-4.20	41.04	74.00	-32.96	Horizontal
2390.00	48.25	-3.88	44.37	74.00	-29.63	Horizontal
2310.00	46.64	-4.49	42.15	74.00	-31.85	Vertical
2390.00	48.86	-4.21	44.65	74.00	-29.35	Vertical

Average value:

Frequency (MHz)	Read Level (dBuV)	Correct factor (dB/m)	Level (dBuV/m)	Limit Line (dBuV/m)	Over Limit (dB)	Polarization
2310.00	31.84	-4.20	27.64	54.00	-26.36	Horizontal
2390.00	33.61	-3.88	29.73	54.00	-24.27	Horizontal
2310.00	33.45	-4.49	28.96	54.00	-25.04	Vertical
2390.00	34.66	-4.21	30.45	54.00	-23.55	Vertical

Test channel:	Highest
---------------	---------

Peak value:

Frequency (MHz)	Read Level (dBuV)	Correct factor (dB/m)	Level (dBuV/m)	Limit Line (dBuV/m)	Over Limit (dB)	Polarization
2483.50	51.73	-3.38	48.35	74.00	-25.65	Horizontal
2500.00	54.04	-3.30	50.74	74.00	-23.26	Horizontal
2483.50	46.70	-3.77	42.93	74.00	-31.07	Vertical
2500.00	55.76	-3.70	52.06	74.00	-21.94	Vertical

Average value:

Frequency (MHz)	Read Level (dBuV)	Correct factor (dB/m)	Level (dBuV/m)	Limit Line (dBuV/m)	Over Limit (dB)	Polarization
2483.50	37.05	-3.38	33.67	54.00	-20.33	Horizontal
2500.00	38.49	-3.30	35.19	54.00	-18.81	Horizontal
2483.50	32.74	-3.77	28.97	54.00	-25.03	Vertical
2500.00	41.52	-3.70	37.82	54.00	-16.18	Vertical

Remark:

1. Final Level = Receiver Read level + Correct factor
2. The emission levels of other frequencies are very lower than the limit and not show in test report.
3. Correct factor = Antenna Factor + Cable Loss – Pre-amplifier Factor

7.10 Spurious Emission

7.10.1 Conducted Emission Method

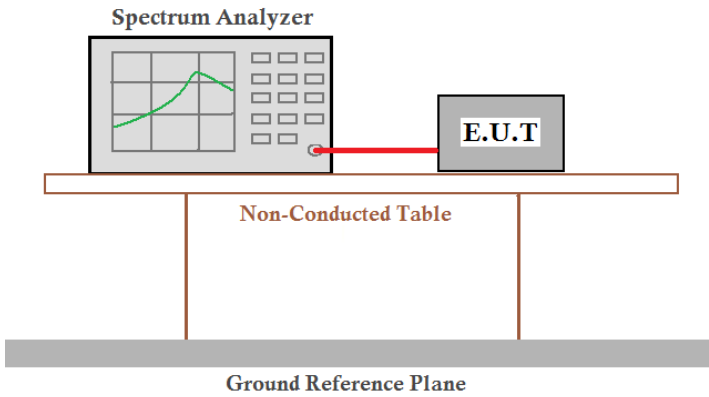
Test Requirement:	FCC Part15 C Section 15.247 (d)
Test Method:	ANSI C63.10:2013
Limit:	In any 100 kHz bandwidth outside the frequency band in which the spread spectrum intentional radiator is operating, the radio frequency power that is produced by the intentional radiator shall be at least 20 dB below that in the 100 kHz bandwidth within the band that contains the highest level of the desired power, based on either an RF conducted or a radiated measurement.
Test setup:	 <p>The diagram illustrates the test setup. A Spectrum Analyzer is connected to an E.U.T. (Equipment Under Test) via a red cable. Both are placed on a Non-Conducted Table, which is supported by a Ground Reference Plane.</p>
Test Instruments:	Refer to section 6.0 for details
Test mode:	Refer to section 5.2 for details
Test results:	Pass

Remark:

During the test, pre-scan the GFSK, Pi/4QPSK modulation, and found the Pi/4QPSK modulation which it is worse case.

Test channel:	Lowest channel
---------------	----------------

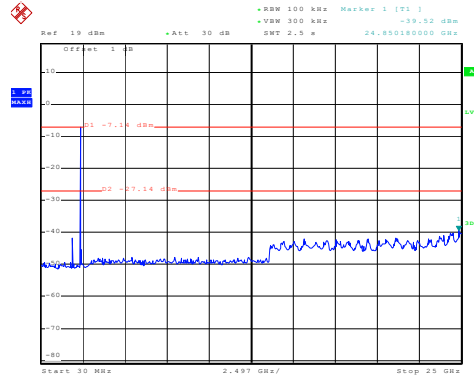

Date: 20.MAR.2020 17:44:09

30MHz~25GHz

Test channel:	Middle channel
---------------	----------------

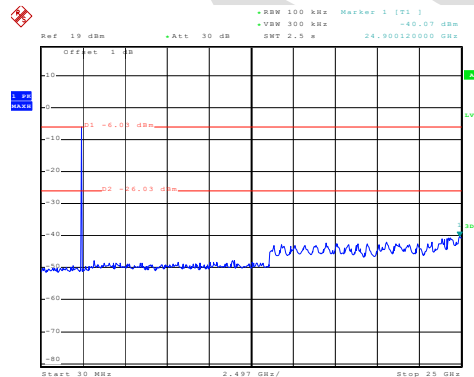

Date: 20.MAR.2020 17:41:31

30MHz~25GHz

Test channel:	Highest channel
---------------	-----------------

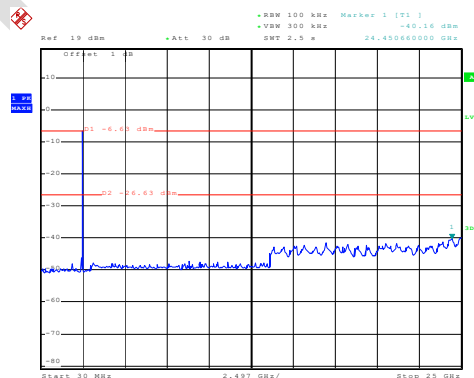

Date: 20.MAR.2020 17:38:49

30MHz~25GHz

7.10.2 Radiated Emission Method

Test Requirement:	FCC Part15 C Section 15.209				
Test Method:	ANSI C63.10:2013				
Test Frequency Range:	9kHz to 25GHz				
Test site:	Measurement Distance: 3m				
Receiver setup:	Frequency	Detector	RBW	VBW	Value
	9KHz-150KHz	Quasi-peak	200Hz	600Hz	Quasi-peak
	150KHz-30MHz	Quasi-peak	9KHz	30KHz	Quasi-peak
	30MHz-1GHz	Quasi-peak	120KHz	300KHz	Quasi-peak
	Above 1GHz	Peak	1MHz	3MHz	Peak
Peak		1MHz	10Hz	Average	
Limit: (Spurious Emissions)	Frequency	Limit (uV/m)	Value	Measurement Distance	
	0.009MHz-0.490MHz	2400/F(KHz)	QP	300m	
	0.490MHz-1.705MHz	24000/F(KHz)	QP	30m	
	1.705MHz-30MHz	30	QP	30m	
	30MHz-88MHz	100	QP	3m	
	88MHz-216MHz	150	QP		
	216MHz-960MHz	200	QP		
	960MHz-1GHz	500	QP		
	Above 1GHz	500	Average		
		5000	Peak		
Limit: (band edge)	Emissions radiated outside of the specified frequency bands, except for harmonics, shall be attenuated by at least 50 dB below the level of the fundamental or to the general radiated emission limits in Section 15.209, whichever is the lesser attenuation.				

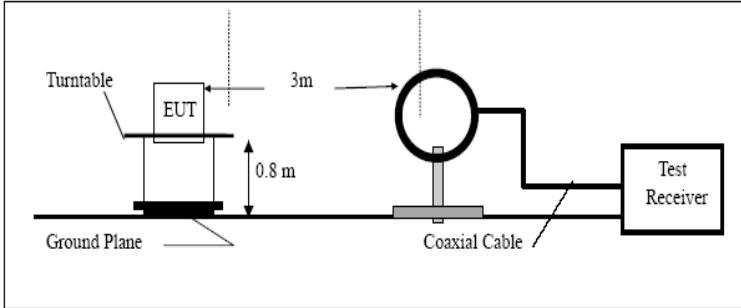
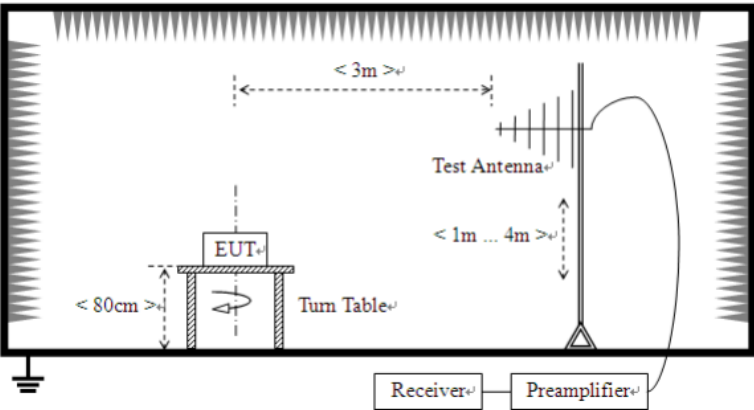
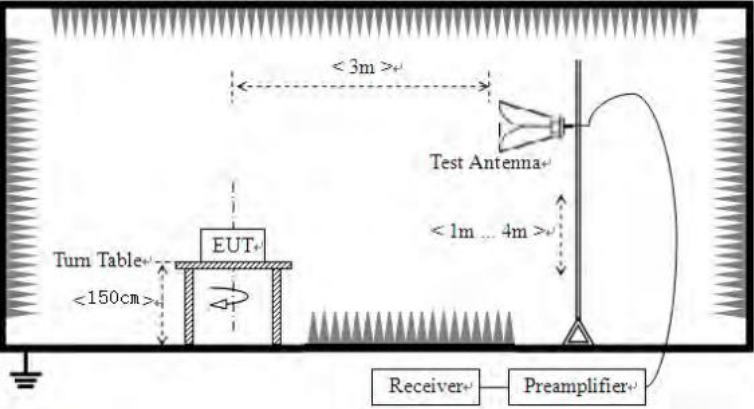
<p>Test setup:</p>	<p>Below 30MHz</p>  <p>Below 1GHz</p>  <p>Above 1GHz</p> 
<p>Test Procedure:</p>	<ol style="list-style-type: none"> 1. The EUT was placed on the top of a rotating table (0.8m for below 1G and 1.5m for above 1G) above the ground at a 3 meter camber. The table was rotated 360 degrees to determine the position of the highest radiation. 2. The EUT was set 3 meters away from the interference-receiving antenna, which was mounted on the top of a variable-height antenna tower.

	<ol style="list-style-type: none"> 3. The antenna height is varied from one meter to four meters above the ground to determine the maximum value of the field strength. Both horizontal and vertical polarizations of the antenna are set to make the measurement. 4. For each suspected emission, the EUT was arranged to its worst case and then the antenna was tuned to heights from 1 meter to 4 meters and the rota table was turned from 0 degrees to 360 degrees to find the maximum reading. 5. The test-receiver system was set to Peak Detect Function and Specified Bandwidth with Maximum Hold Mode. 6. If the emission level of the EUT in peak mode was 10dB lower than the limit specified, then testing could be stopped and the peak values of the EUT would be reported. Otherwise the emissions that did not have 10dB margin would be re-tested one by one using peak, quasi-peak or average method as specified and then reported in a data sheet.
Test Instruments:	Refer to section 6.0 for details
Test mode:	Refer to section 5.2 for details
Test results:	Pass

Measurement data:

Remark:

1. *During the test, pre-scan the GFSK, Pi/4QPSK modulation, and found the Pi/4QPSK modulation which it is worse case.*
2. *Pre-scan all kind of the place mode (X-axis, Y-axis, Z-axis), and found the Y-axis which it is worse case.*

■ **9 kHz ~ 30 MHz**

The low frequency, which started from 9 kHz to 30 MHz, was pre-scanned and the result which was 20 dB lower than the limit line per 15.31(o) was not reported.

■ Below 1GHz

EUT:	ACTIVE WEATHERIZED OUTDOOR SPEAKERS	Polarziation:	Horizontal
Model:	301-8775	Power Source:	AC120V/60Hz
Mode:	BT mode	Test by:	Eason
Temp./Hum.(%RH):	26°C/60%RH		

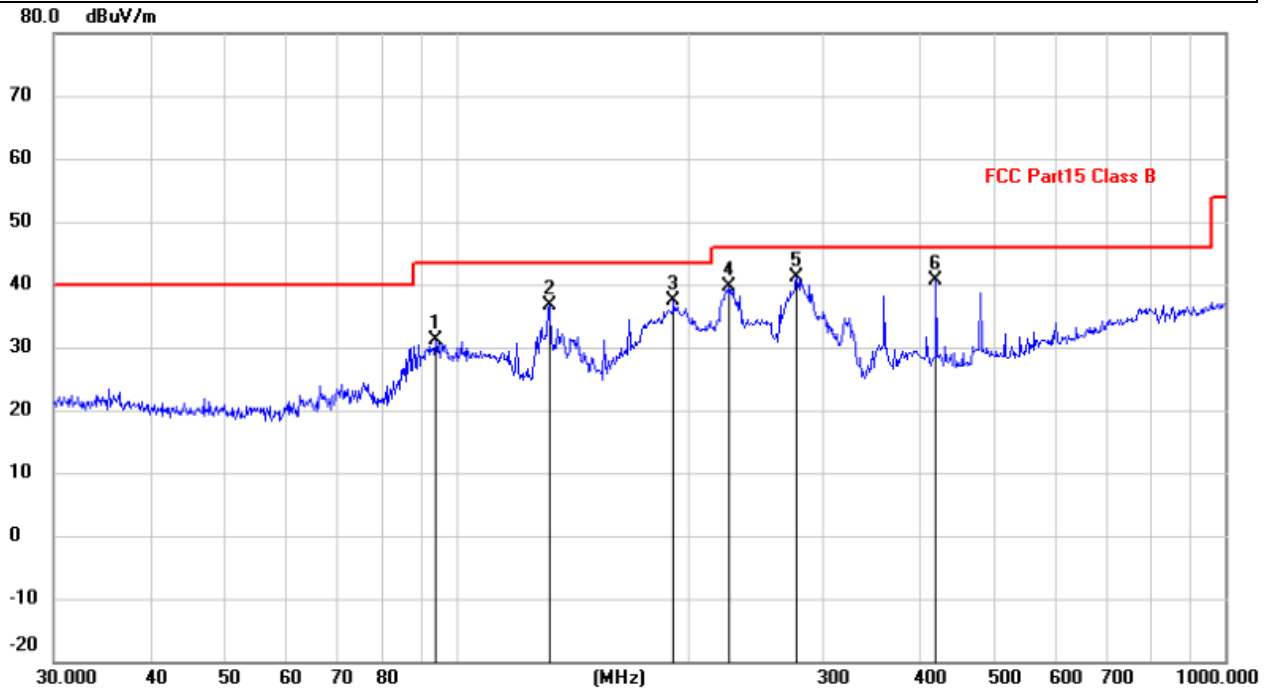

No.	Mk.	Freq. MHz	Reading Level dBuV	Correct Factor dB	Measure- ment dBuV/m	Limit dBuV/m	Over dB	Detector
1		94.0978	21.25	9.92	31.17	43.50	-12.33	QP
2		132.2204	23.64	12.94	36.58	43.50	-6.92	QP
3		191.7450	27.00	10.30	37.30	43.50	-6.20	QP
4		226.8934	27.81	11.94	39.75	46.00	-6.25	QP
5	*	277.0935	27.98	13.12	41.10	46.00	-4.90	QP
6		420.5803	23.40	17.33	40.73	46.00	-5.27	QP

EUT:	ACTIVE WEATHERIZED OUTDOOR SPEAKERS	Polarziation:	Vertical
Model:	301-8775	Power Source:	AC120V/60Hz
Mode:	BT mode	Test by:	Eason
Temp./Hum.(%RH):	26°C/60%RH		

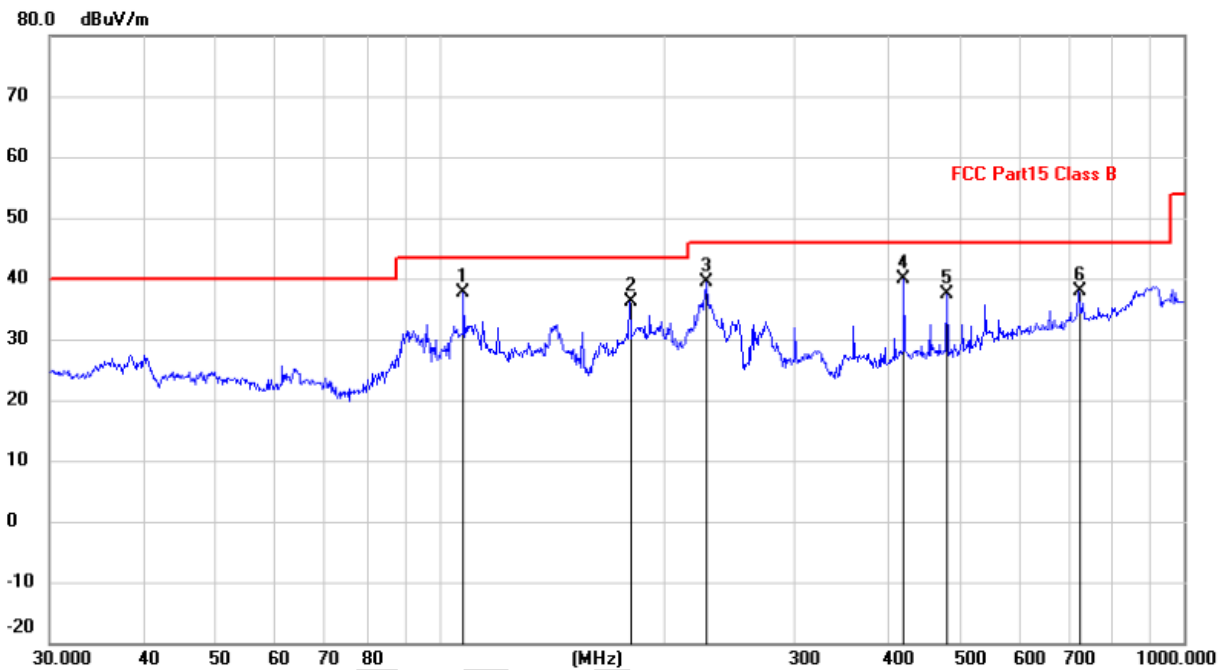

No.	Mk.	Freq. MHz	Reading Level dBuV	Correct Factor dB	Measure- ment dBuV/m	Limit dBuV/m	Over dB	Detector
1	*	107.8876	26.33	11.36	37.69	43.50	-5.81	QP
2		180.0165	25.23	10.92	36.15	43.50	-7.35	QP
3		228.4902	27.21	12.06	39.27	46.00	-6.73	QP
4		420.5803	22.51	17.33	39.84	46.00	-6.16	QP
5		480.5276	18.82	18.46	37.28	46.00	-8.72	QP
6		721.7259	15.00	22.92	37.92	46.00	-8.08	QP

■ Above 1GHz

Test channel:	Lowest
---------------	--------

Peak value:

Frequency (MHz)	Read Level (dBuV)	Correct factor (dB/m)	Level (dBuV/m)	Limit Line (dBuV/m)	Over Limit (dB)	Polarization
4804.00	45.46	2.62	48.08	74.00	-25.92	Vertical
7206.00	45.13	7.58	52.71	74.00	-21.29	Vertical
9608.00	43.29	7.62	50.91	74.00	-23.09	Vertical
12010.00	*			74.00		Vertical
14412.00	*			74.00		Vertical
4804.00	47.35	2.38	49.73	74.00	-24.27	Horizontal
7206.00	45.27	7.58	52.85	74.00	-21.15	Horizontal
9608.00	43.05	7.62	50.67	74.00	-23.33	Horizontal
12010.00	*			74.00		Horizontal
14412.00	*			74.00		Horizontal

Test channel:	Middle
---------------	--------

Peak value:

Frequency (MHz)	Read Level (dBuV)	Correct factor (dB/m)	Level (dBuV/m)	Limit Line (dBuV/m)	Over Limit (dB)	Polarization
4882.00	44.46	0.17	44.63	74.00	-29.37	Vertical
7323.00	43.62	7.60	51.22	74.00	-22.78	Vertical
9764.00	41.15	7.62	48.77	74.00	-25.23	Vertical
12205.00	*			74.00		Vertical
14646.00	*			74.00		Vertical
4882.00	47.01	0.17	47.18	74.00	-26.82	Horizontal
7323.00	44.08	7.60	51.68	74.00	-22.32	Horizontal
9764.00	42.26	7.62	49.88	74.00	-24.12	Horizontal
12205.00	*			74.00		Horizontal
14646.00	*			74.00		Horizontal

Test channel:	Highest
---------------	---------

Peak value:

Frequency (MHz)	Read Level (dBuV)	Correct factor (dB/m)	Level (dBuV/m)	Limit Line (dBuV/m)	Over Limit (dB)	Polarization
4960.00	42.46	1.04	43.50	74.00	-30.50	Vertical
7440.00	42.29	7.55	49.84	74.00	-24.16	Vertical
9920.00	41.03	7.63	48.66	74.00	-25.34	Vertical
12400.00	*			74.00		Vertical
14880.00	*			74.00		Vertical
4960.00	46.77	1.04	47.81	74.00	-26.19	Horizontal
7440.00	43.41	7.55	50.96	74.00	-23.04	Horizontal
9920.00	41.23	7.63	48.86	74.00	-25.14	Horizontal
12400.00	*			74.00		Horizontal
14880.00	*			74.00		Horizontal

Remark:

1. *Final Level = Receiver Read level + Correct factor*
2. *Correct factor = Antenna Factor + Cable Loss – Preamplifier Factor*
3. *“*”*, means this data is the too weak instrument of signal is unable to test.
4. *The emission levels of other frequencies are very lower than the limit and not show in test report.*

8 Test Setup Photo

Radiated Emission

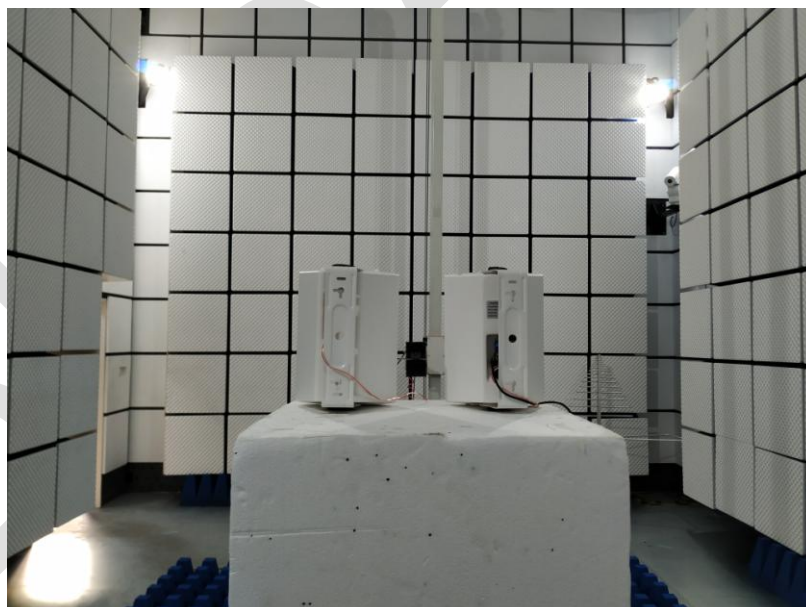

Conducted Emission



9 EUT Constructional Details



BlueAsia of Technical Services(Shenzhen) Co., Ltd.

IOT Test Centre of BlueAsia,

No. 448 Bulong Road, Bantian Street, Longgang District, Shenzhen, China

Telephone: TEL: +86-755-28682673 FAX: +86-755-28682673





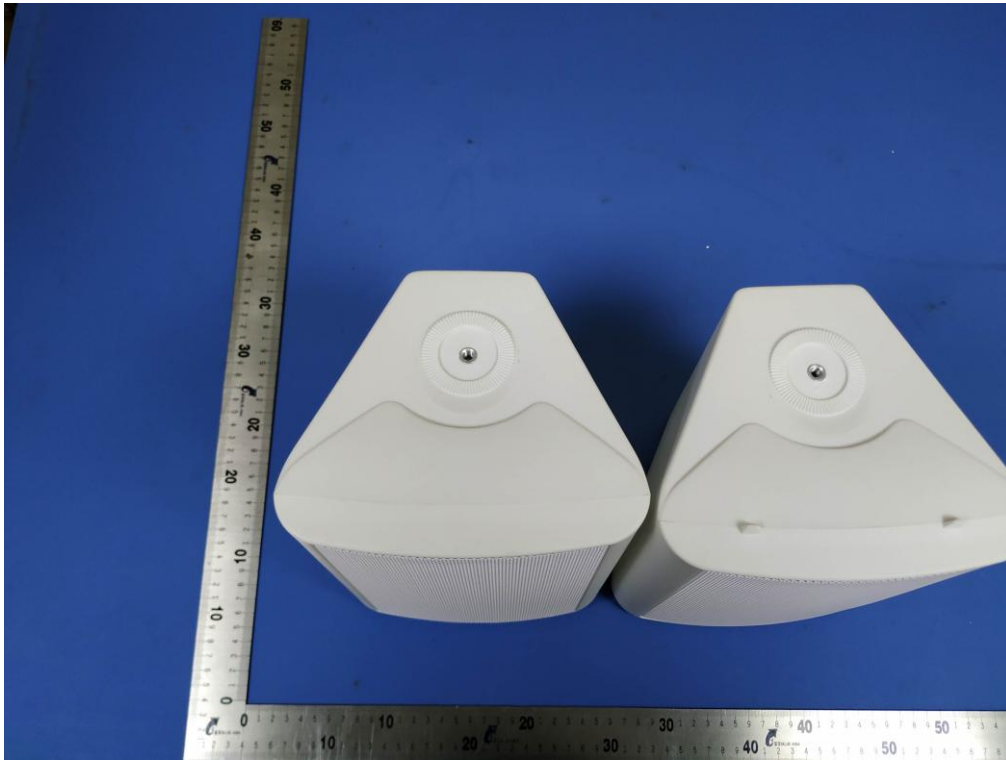



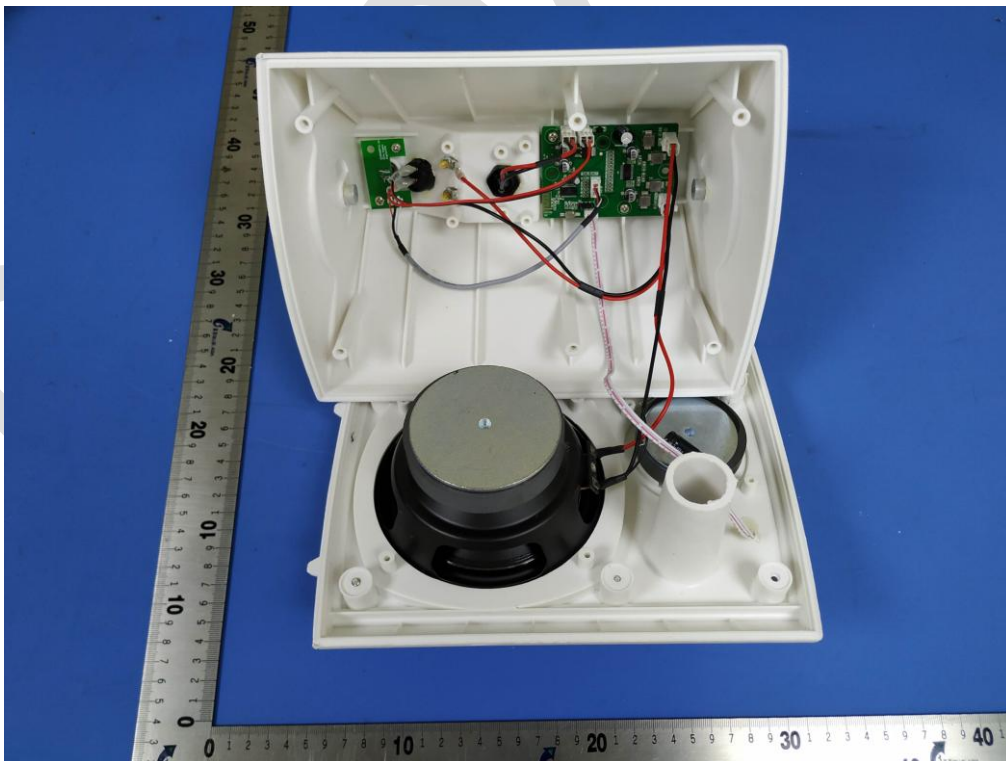

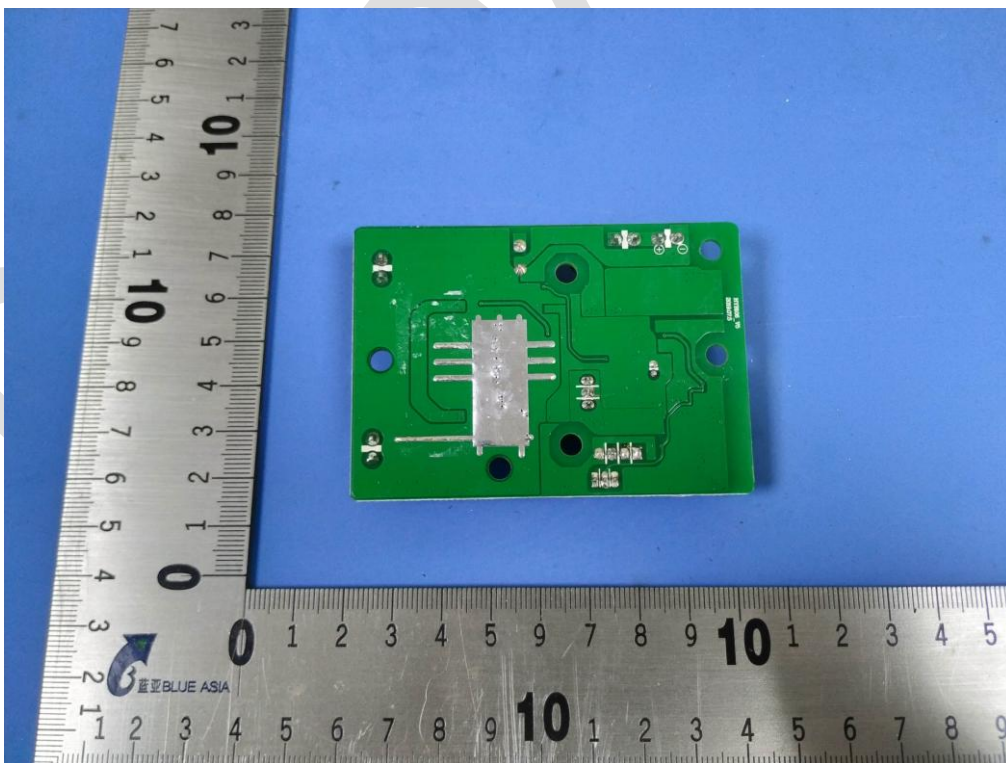
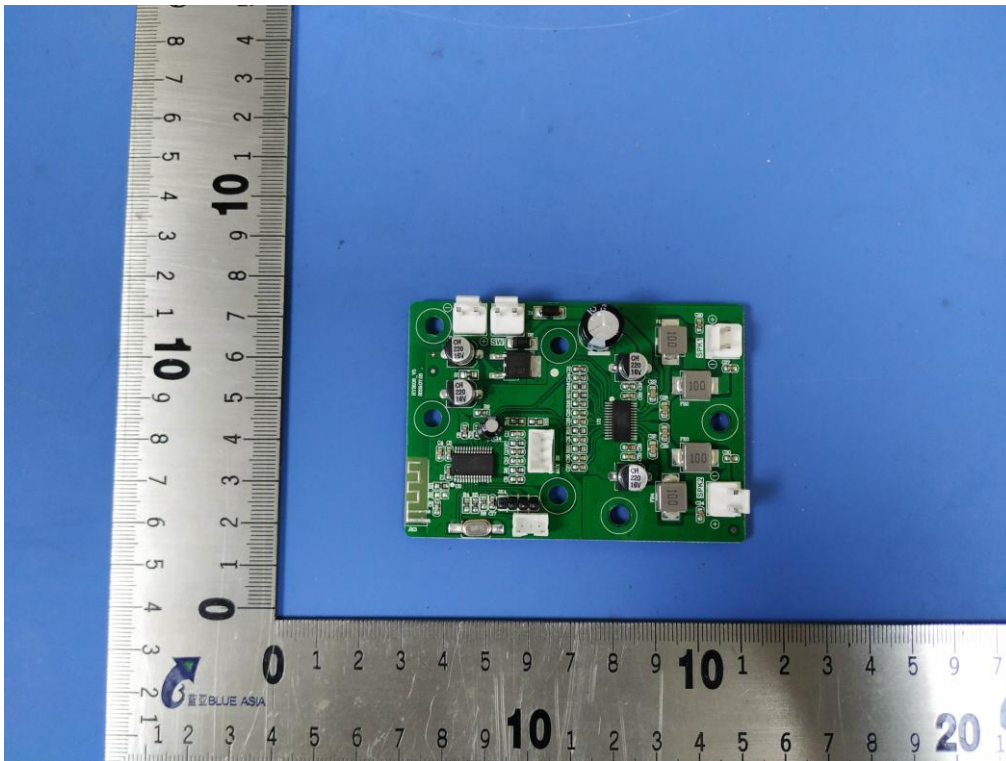

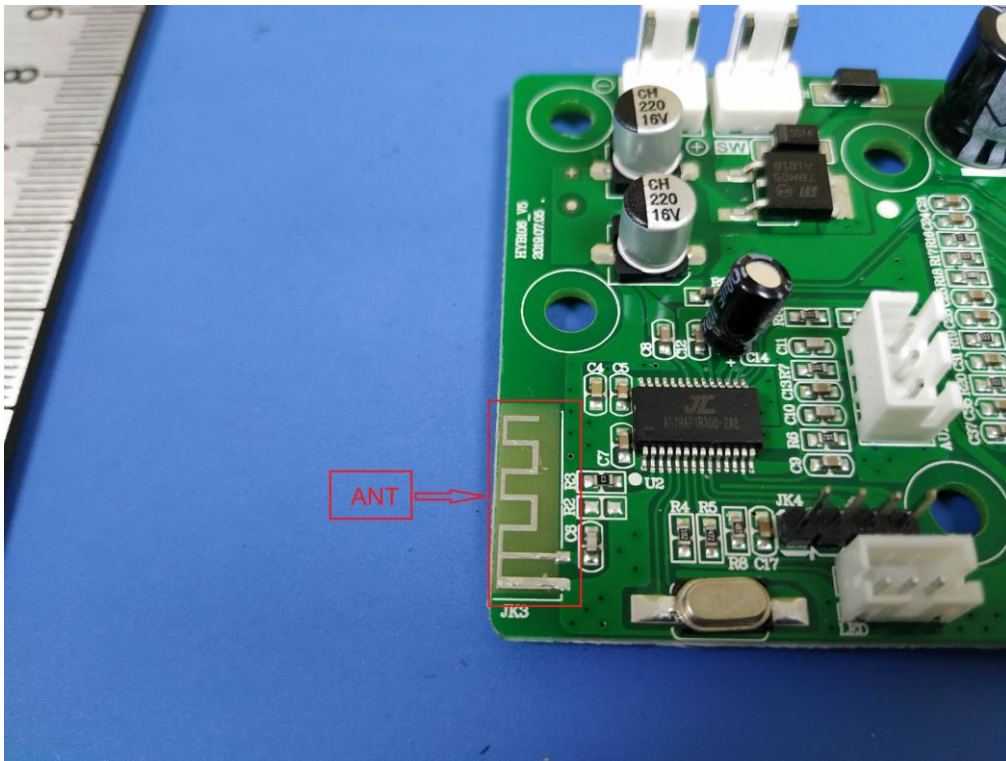

*** End of Report ***

The test report is effective only with both signature and specialized stamp, The result(s) shown in this report refer only to the sample(s) tested. Without written approval of BlueAsia, this report can't be reproduced except in full.

-----End-----