

## For Services and Support



TEL

86-755-21612590  
1-833-629-4832 (North America)



EMAIL

SUPPORT@TOPDON.COM



WEBSITE

WWW.TOPDON.COM



FACEBOOK

@TOPDONOFFICIAL



TWITTER

@TOPDONOFFICIAL



RoHS



FR

PAPIER



# Phoenix XLink

Smart Automotive Diagnostic System

---

**USER MANUAL**



**TOPDON**



# Contents

Welcome .....	3
About.....	3
Package List .....	3
Compatibility .....	3
Notice.....	4
General Information of OBDII (On-Board Diagnostics II).....	4
Diagnostic Trouble Codes (DTCs) .....	4
Product Descriptions .....	5
Preparation & Connection.....	7
Operation Introduction.....	11
Technical Specification.....	36
Warnings.....	37
Cautions.....	37
FAQ.....	38



# Welcome

---

Thank you for purchasing TOPDON's Smart Automotive Diagnostic System Phoenix XLink. Please read and understand this user manual prior to the operation.

## About

---

TOPDON's Phoenix XLink features comprehensive diagnostic capabilities. The accuracy of test readings, expanded vehicle coverage, improved speed and an abundance of user-friendly features make this diagnostic tablet stand out in its class and give mechanics and professionals a great deal of help in their diagnostic work.

## Package List

---

- Phoenix XLink
- OBDI Adapter BOX Transfer Line
- OBDII Extension Cable
- Cigarette Lighter Cable
- Type-C to USB Cable
- Battery Clamps/Cable Set
- Power Adaptor
- User Manual
- Non-Standard OBDII Adapter\*10
- Fuse ( $\phi 5 \times 20\text{mm}$ )\*4
- Fuse ( $\phi 6 \times 30\text{mm}$ )\*2
- Ethernet Cable

## Compatibility

---

TOPDON's Phoenix XLink is compatible with the following protocols:

- ISO 9142-2
- ISO 14230-2
- ISO 15765-4
- K/L-Line
- SAE-J1850 VPW
- SAE-J1850 PWM
- CAN ISO 11898
- Highspeed
- Middlespeed
- CAN FD Protocol
- Lowspeed and Singlewire CAN
- GM UART
- UART Echo Byte Protocol
- Honda Diag-H Protocol
- TP 2.0
- TP 1.6
- SAE J1939
- SAE J1708
- Fault-Tolerant CAN
- And More

# Notice

---

Phoenix XLink may automatically reset while being disturbed by strong static electricity. THIS IS A NORMAL REACTION.

This user manual is subject to change without written notice.

Read the instructions carefully before operating and use the unit properly according to the guide. Failure to do so may cause damage and/or personal injury, and will void the product warranty.

## General Information of OBDII (On-Board Diagnostics II)

---

The OBDII system is designed to monitor emission control systems and key engine components by performing either continuous or periodic tests of specific components and vehicle conditions, which will offer three pieces of valuable information:

- Whether the Malfunction Indicator Light (MIL) is commanded "on" or "off."
- Which, if any, Diagnostic Trouble Codes (DTCs) are stored.
- Readiness Monitor status.

## Diagnostic Trouble Codes (DTCs)

---

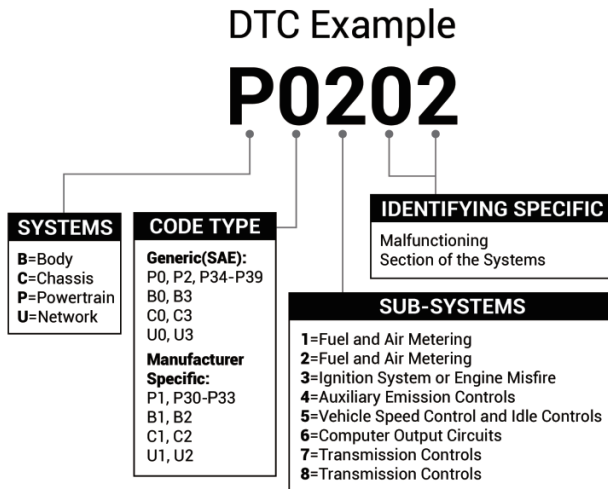

# Product Descriptions

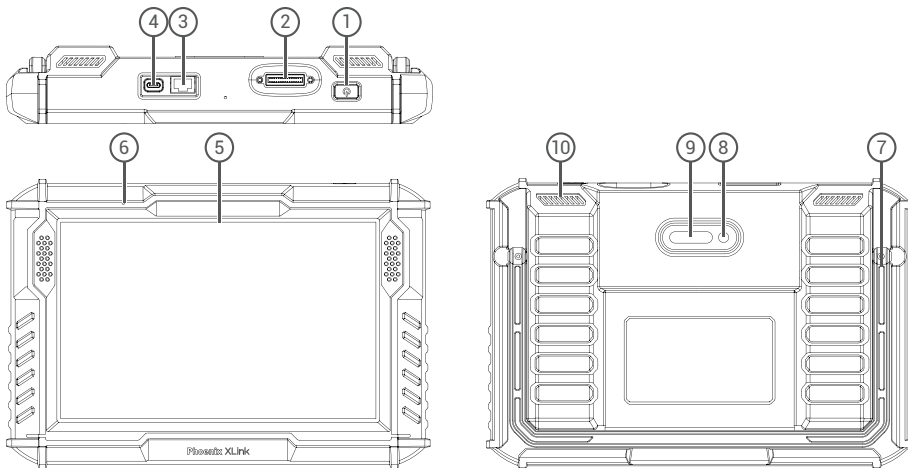

NO.	Name	Descriptions
1	Power Button	<ul style="list-style-type: none"> <li>• Hold the button for 3 seconds to turn the tablet on or off.</li> <li>• Hold the button for 2 seconds for a forced shutdown.</li> <li>• Press the button to wake up the screen or turn off the screen.</li> </ul>
2	Diagnosis interface	Plug in the diagnostic cable whose OBD 16-bin connector is linked the DLC of the vehicle.
3	Ethernet interface	Through this interface, the device can be connected to Ethernet
4	Type C Charging Slot	For charging the tablet.
5	10" Touchable Screen	Show test results.
6	Microphone	Sound input for acquisition and noise reduction.
7	Adjustable Stand	Keep the tablet standing at the desk, or hang the tablet on the steering wheel.
8	Rear Camera	Snapshot the view in front of the screen.
9	LED Lamp	Fill light for photographing.
10	Loudspeaker	Convert an audio signal into a corresponding sound.



# Preparation & Connection

---

1. Turn the ignition off.

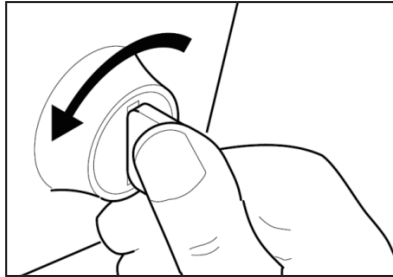

2. Locate the vehicle's DLC port.

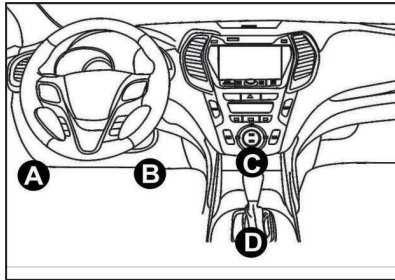

3. Plug the TOPDON Phoenix XLink into the vehicle's DLC port.

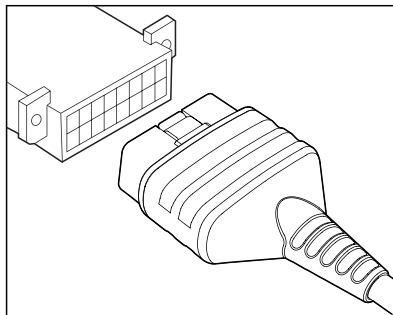

- Turn the ignition on. The engine does not need to be running.
- Hold the power button for 3 seconds to turn the tablet on. (The tablet must be charged.) The tablet will start initializing and enter the following interface:



Note: Do not connect or disconnect any test equipment with the ignition on or engine running.

#### 6. Language Setting

Select operating language in the following interface:

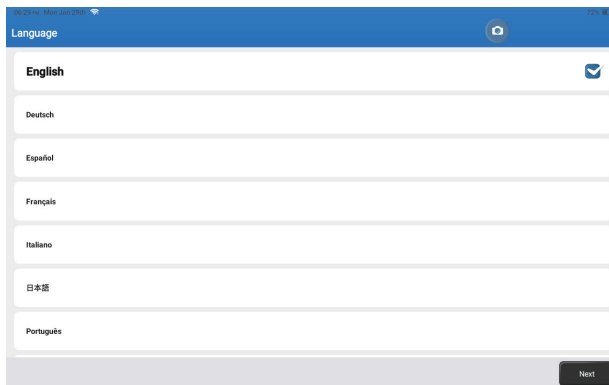

## 7. Connect Wi-Fi

The system will automatically search all available Wi-Fi networks. Select the Wi-Fi network you want to connect to.

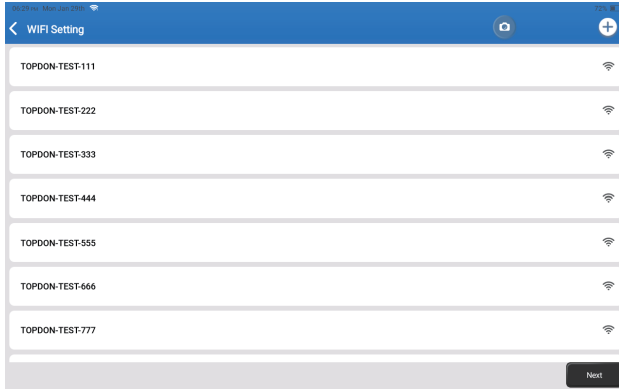

## 8. Choose Time Zone

Choose the time zone of your current location. The system will automatically configure the time.

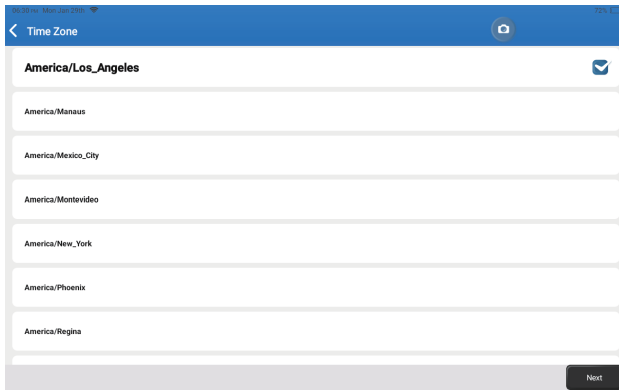

## 9. User Agreement

Please read all the terms and conditions of the user agreement carefully. Select “Agree with above terms.”

Tap “Next” to log in.

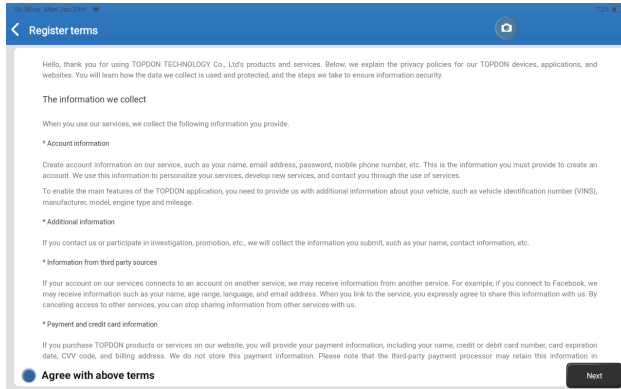

The following page will appear:



## 10. Activate

Please enter your email and tap the CAPTCHA button to obtain the Validation Code. After entering the Validation Code, tap the OK button.

# Operation Introduction

TOPDON's Pheonix XLink features an array of practical functions, including Scan, AutoScan, Services, ADAS, Module, Update, Support, Library, History, Feedback and User Info.



TOPDON's Pheonix XLink supports AutoScan and Scan covering OBDII diagnosis, full system diagnosis for most modern vehicle models worldwide.

## 1. AutoScan (Intelligent Diagnosis)

Plug the Pheonix XLink into the vehicle's DLC port.

Tap "AutoScan" on the Home Menu after connecting to the vehicle.

The tool will start the AutoScan procedure, and automatically read the vehicle's VIN information, as shown below:

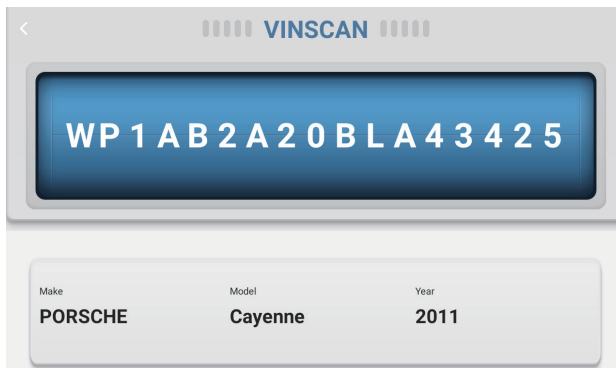

Note: If the AutoScan can not identify the vehicle, please try to reconnect to the network. Not all cars support the AutoScan function due to auto manufacturers settings.

## 2. Scan(Manual Diagnosis)

If Pheonix XLink fails to get access to the vehicle VIN data automatically, tap "Scan" on the Home Menu. The following page will appear:

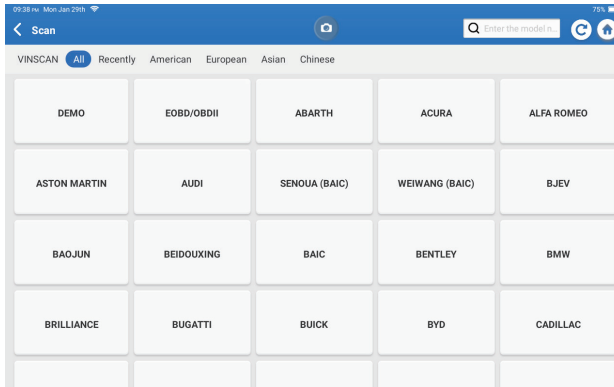

There are two ways to get access to vehicle diagnostic functions.

### 2.1 The first way is using "VINSCAN."

Tap "VINSCAN." The following page will appear:

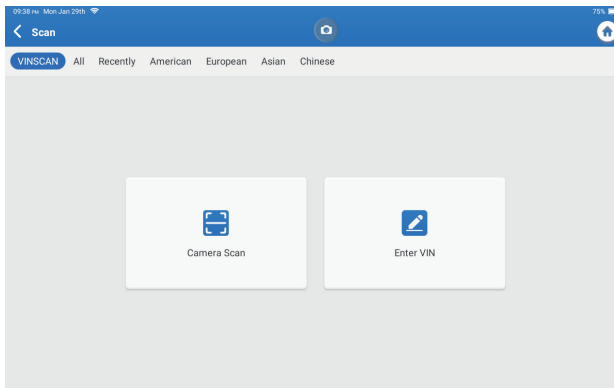

2.1.1 Tap "Camera Scan." The following page will appear:

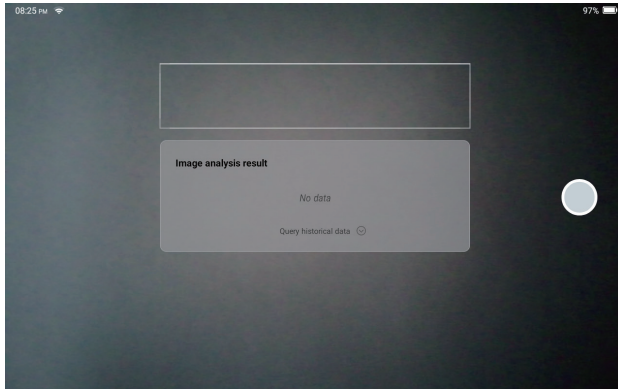

After scanning, the following page will appear:

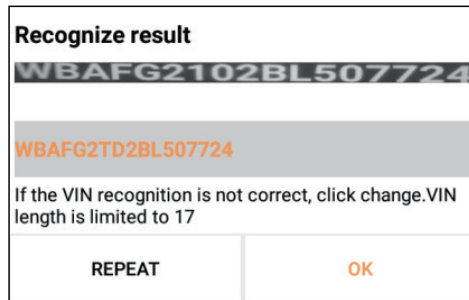

Note: the VIN code in yellow can be modified if it isn't correct.

If the VIN barcode cannot be recognized, please tap  to manually input the VIN.

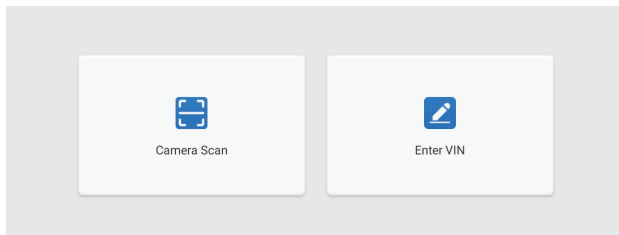

2.1.2 After selecting "🔗," the following page will appear:

You will need to input the vehicle's VIN manually.

Note: VIN characters need to be capital letters A through Z and numbers 1 through 0. However, the letters I, O, and Q won't be used in order to avoid misreading. No symbols or spaces are allowed in the VIN.

## 2.2 The second way is manually selecting the vehicle's make, model, and year.

Tap a corresponding diagnostic software logo on the following page:



Select "Demo" as an example and the following page will appear:

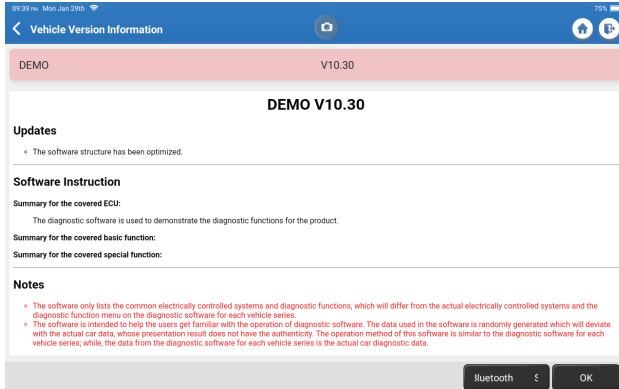

Tap "OK." Select "Demo" from the pop-up Notes. Then select a vehicle make. The tablet will automatically navigate to the Show Menu:

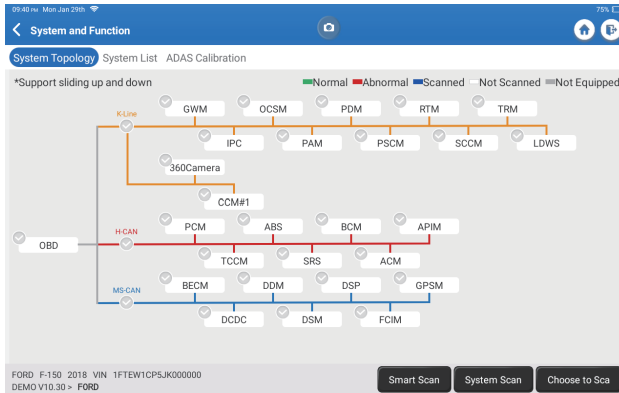

The interface has two display modes, one of system topology and one of system list, both with the same functions. Select the display mode according to personal preference.

## 2.2.1 Smart Scan

This function is used to quickly detect vehicles and view vehicle health reports (this item will only be displayed if the vehicle's model diagnosis software supports this function).

Tap "Smart Scan," the system starts to scan fault codes in each system and displays specific scan results.

The systems with DTC(s) will be shown in red, with the specific definition(s).

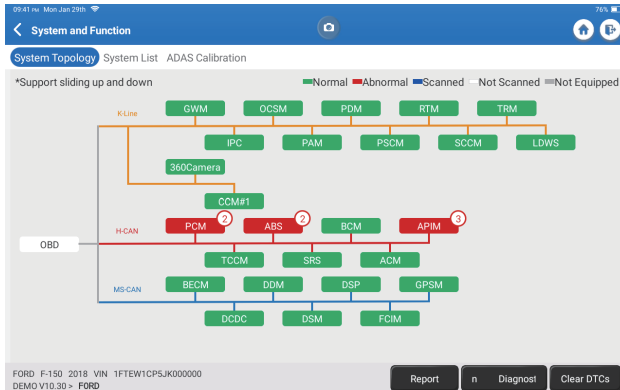

\*Explanation of terms:

- Report: Save the current diagnosis result as a diagnosis report.
- Diagnostic Plan: Display all current Diagnostic Trouble Codes and descriptions.
- Clear DTCs: Clear all Diagnostic Trouble Codes with one simple touch.

## 2.2.2 System Scan

This function will scan all systems of the vehicle.

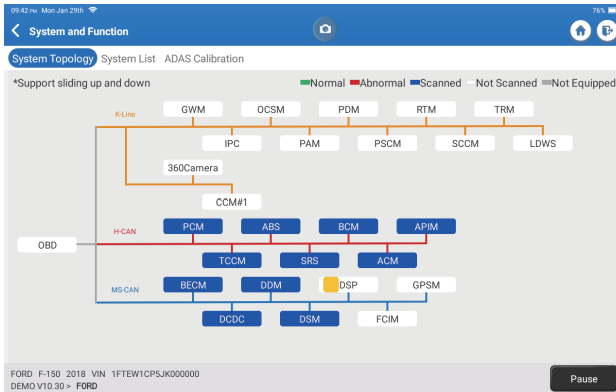

## 2.2.3 Choose to Scan

Scan the manually selected vehicle electronic control system. As an example, tap "PCM," then tap "Choose to Scan" to scan the system. Tap "PCM" and tap "Enter." The following page will appear.

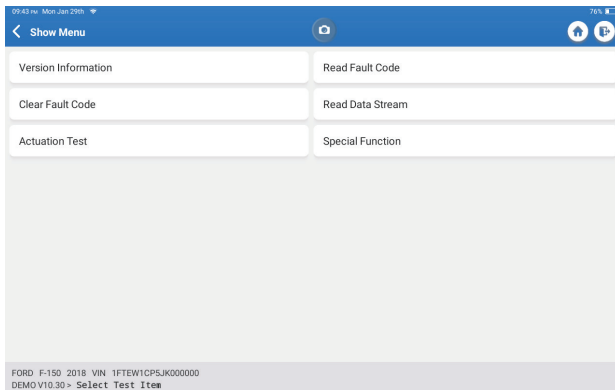

Note: This function will be available only if the diagnostic software supports it.

### A. Version Information

This function reads the current version information of ECU.

## B. Diagnostic Trouble Code

This function can read the Diagnostic Trouble Codes (DTCs) in the ECU memory, helping quickly identify the cause of the vehicle breakdown.

Tap "Read Fault Code." The screen will display diagnostic results.

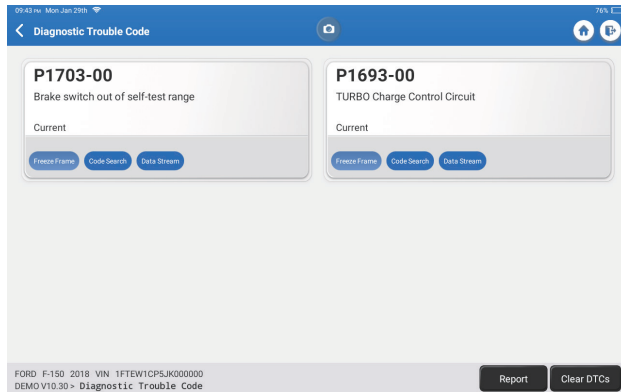

\*Explanation of terms:

- Freeze Frame: Take a snapshot of specific data streams for verification when the DTC occurs.
- Code Search: Query DTC information through Google Chrome.
- Data Stream: Return to the data stream page.
- Report: Save the current diagnosis result as a diagnosis report.

## C. Clear Fault Code

This function can clear the DTC from the ECU memory of the tested system.

## D. Read Data Stream

This function can read and display real-time data and parameters.

Tap "Read Data Stream." The following page will appear:

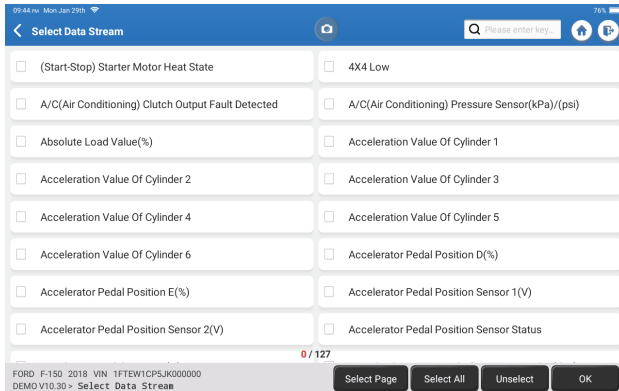

Select the data stream and tap "OK":

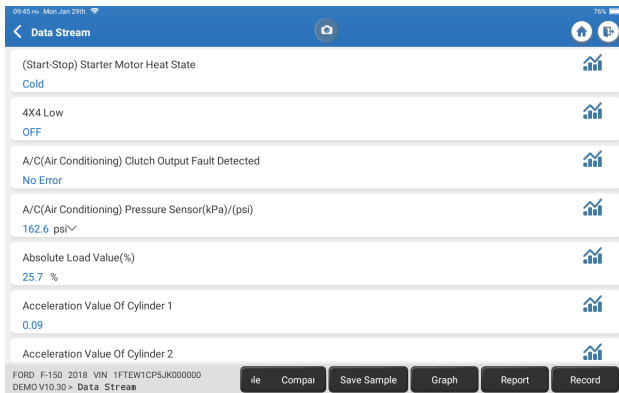



The system can display data streams in three modes:

- 1) Value (default): Shows parameters with numbers and lists.
- 2) Graph: Displays parameters as wave patterns.
- 3) Combine: Both Values and Graphs can be merged for easier comparisons.

\*Explanation of terms:

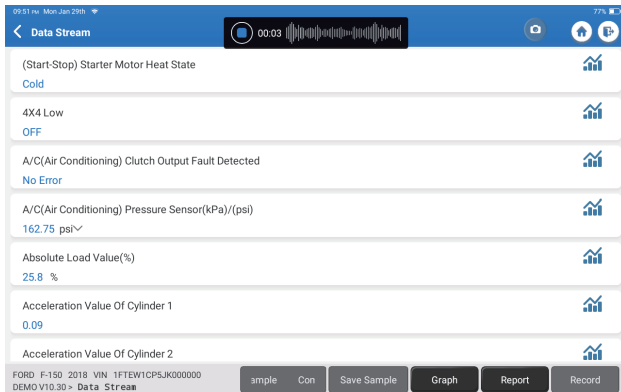
- Save Sample: You can save the current Data Stream as a Sample when the vehicle is running normally and use this Sample Data Stream for future comparison and analysis. Tap "Save Sample" to start recording the sample data stream. The following page will appear:



Once the recording process is complete, tap “  ” to end the recording. The following page will appear:

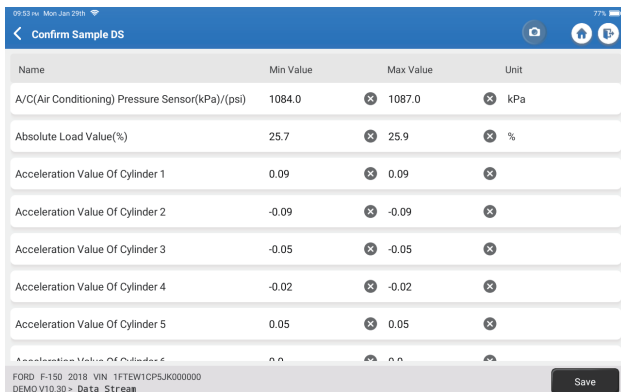

You can change the Min or Max value and tap “Save” to save it as a Data Stream Sample. All Data Stream Sample files are stored in “User Info -> Data Stream Sample.”

- Compare Sample: Tap “Compare Sample” to select the saved Data Stream Sample files. The following page will appear:

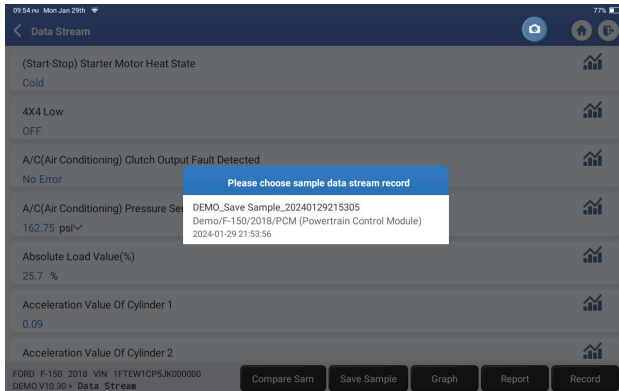

Select the file you need. The following page will appear:

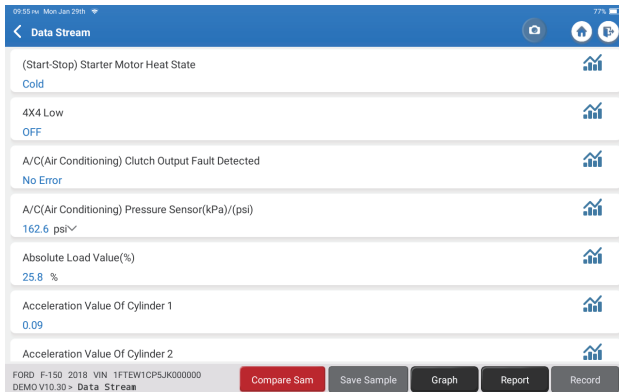

The Standard Range column will show the corresponding Data Stream Sample values for your comparison and analysis.

- Graph: To have the selected data streams (max 12 items) displayed in waveform. Tap "Graph." The following page will appear:





Tap "<" on the right side of the screen. The following page will appear:



Tap "Value" to view the data displayed in values.

Tap "Combine" to merge graphs for easier comparisons (A maximum of 4 values can be merged).

You can select specific data stream options to be viewed on the left.  
Note: A maximum of 12 data streams can be displayed in this module.

- Report: To save the current data stream.
- Record: To record the diagnostic data for further analysis.
-  : To view single data stream displayed in waveform. Tap "". The following page will appear:



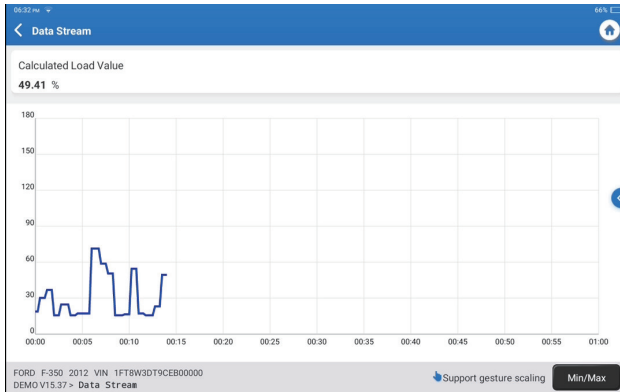

Tap “Min/Max” to define the maximum/minimum values. Once the value goes beyond the specified values, the data will be shown in red.  
Tap “<” on the right side of the screen. The following page will appear:

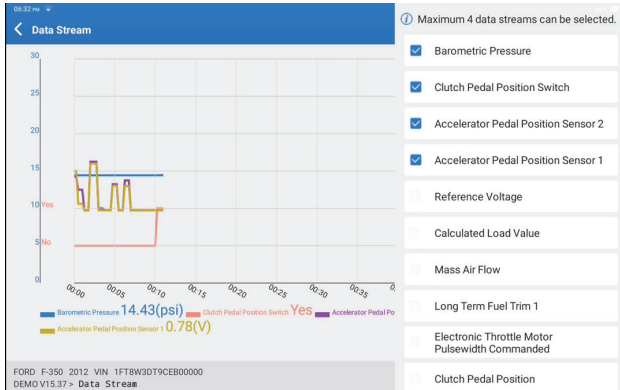

You can select specific data stream options to view in the chart.  
Note: A maximum of 4 data streams can be displayed in this module.

### E. Actuation Test

This option is used to access vehicle-specific subsystem and component tests. Available tests vary by vehicle manufacturer, year, and model.

## F. Special function

This option offers coding, reset, relearn, and more service functions, to help vehicles get back to functional status after repair or replacement. Available tests vary by vehicle manufacturer, year, and model.

### 2.2.4 ADAS Calibration

Tap “ADAS Calibration,” and the screen will enter the selection interface.

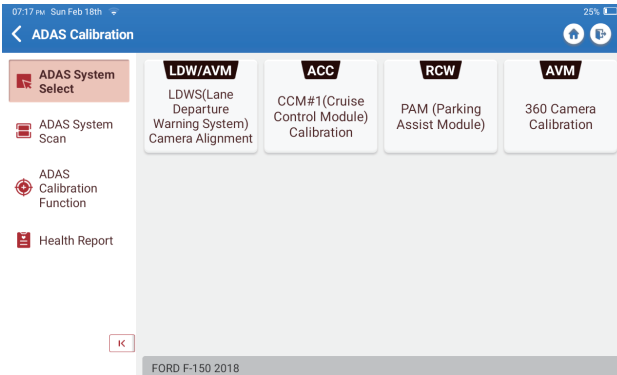

## 3. Services

TOPDON Phoenix XLink is equipped with beneficial maintenance services for technicians and mechanics working in the automotive repair industry.

### 3.1 OIL (Maintenance Light Reset)

This function enables you to reset the oil service lamp for the engine oil life system, which calculates an optimal oil life change interval depending on the vehicle driving conditions and weather events.

Use cases:

- If the service lamp is on, run car diagnostics first for troubleshooting. After that, reset the driving mileage or driving time to turn off the service lamp and enable a new driving cycle.
- If you have changed the engine oil or electric appliances that monitor oil life, you need to reset the service lamp.

### 3.2 ETS (Throttle Matching)

This function initializes the throttle actuator and returns the ECU's learning value to its initial state. This allows more accurate control of the throttle (or idle motor) movement to regulate the air intake.

Use cases:

- After replacing the electronic control unit, the relevant characteristics of the throttle operation have not been stored in the electronic control unit.
- After the electric control unit is powered off, the memory of the electric control unit is lost.
- After replacing the throttle assembly, you need to match the throttle.
- After replacing or disassembling the intake port, the idle speed controlled by the coordination between the electronic control unit and the throttle body has been affected.
- The intake volume and the idle control behavior have changed while staying at the same throttle opening position, although the idle throttle potentiometer behavior hasn't changed.

### **3.3 SAS (Steering Angle Reset)**

This function can reset the steering angle to zero to keep the car running straight. It generally needs to be performed after replacing the steering angle position sensor, or after replacing the mechanical parts of the steering system (such as steering gear, steering column, tie rod ball head, steering knuckle), or after completing the four-wheel positioning, body repair, etc.

### **3.4 BMS (Battery Matching)**

This function can reset the monitoring unit of the car battery, by clearing the original breakdown information about the lack of battery power to rematch the battery.

Use cases:

- Replacement of the main battery needs to utilize battery matching to clear the former information about the lack of power, thus avoiding false information detected by the relevant control module which may cause the failure of some electronic auxiliary functions. For example, the vehicle automatically stops. The sunroof won't work with one key. Electric windows don't open and close automatically.
- The battery monitoring sensor uses the battery matching function to re-match the control module with the monitoring sensor, so as to detect the use of the battery power more accurately and avoid receiving wrong information from instrument prompts which will cause false alarms.

### **3.5 BLEEDING (ABS Bleeding)**

This function enables you to perform tests to check the operating conditions of the Anti-lock Braking System (ABS).

Use cases:

- When the ABS lines contain air.
- When the ABS computer, ABS pump, brake master cylinder, brake cylinder, brake line, or brake fluid is replaced.

### 3.6 BRAKE (Electronic Parking Brake Reset)

This function helps you to replace and reset the brake pads.

Use cases:

- The brake pads and brake pad wear sensor are replaced.
- The brake pads indicator lamp is on.
- The brake pads sensor circuit is short, which is recovered.
- The servo motor is replaced.

### 3.7 DPF (DPF Regeneration)

This function can help remove particulate matter from the trap by using combustion oxidation methods to keep the trap performance stable.

Use cases:

- The exhaust back pressure sensor is replaced.
- Disassembly or replacement of the particle trap.
- Removal or replacement of fuel additive nozzles.
- Removal or replacement of catalytic oxidizer.
- The DPF regeneration fault lamp remains lit and matched after maintenance.
- The DPF regeneration control module is repaired or replaced.

### 3.8 GEAR (Tooth Learning)

This function can perform tooth learning for the car to turn off the MIL.

Use cases:

- After the engine ECU, the crankshaft position sensor or crankshaft flywheel is replaced.
- There is a DTC of 'tooth not learned.'

### 3.9 IMMO (Anti-theft Matching)

This function can match the anti-theft key after replacing the ignition key, ignition switch, instrument cluster, engine control unit (ECU), body control module (BCM), and remote control battery.

### 3.10 INJEC (Injector Coding)

This function can write actual injector code or rewrite code in the ECU for the injector code of the corresponding cylinder to more accurately control or correct cylinder injection quantity.

It needs to be performed after the ECU or injector is replaced.

### 3.11 TPMS (Tire Pressure Reset)

This function can reset the tire pressure and turn off the tire pressure fault indicator when the car tire pressure fault indicator light is on.

### **3.12 SUS (Suspension Level Calibration)**

This function is required to calibrate the level of the vehicle when the level sensor or control module in the air suspension system is replaced or when the level of the vehicle is incorrect.

### **3.13 AFS (Adaptive Front-Lighting System Reset)**

This function enables you to initialize the adaptive headlamp system.

### **3.14 GEARBOX (A/T Learning)**

This function helps complete the gearbox self-learning to improve gear shifting quality. It needs to be performed when the gearbox is disassembled or repaired (after the car battery is disconnected), which may lead to shift delay or shock problems.

### **3.15 SUN (Sunroof Initialization)**

This function can turn the sunroof lock off, auto-close in case of rain, set the memory function of sliding/tilting sunroof, set outside temperature threshold, etc.

### **3.16 EGR (EGR Adaption)**

This function can learn the EGR (Exhaust Gas Recirculation) valve after it is cleaned or replaced.

### **3.17 ODO (ODO Reset)**

This function can copy and write the value of kilometers in the chip of the odometer so that the odometer shows the actual mileage.

It needs to be performed when the mileage is incorrect due to a damaged vehicle speed sensor or odometer failure.

### **3.18 AIRBAG (Airbag Reset)**

This function resets the airbag data to clear the airbag collision fault indicator, so that the airbag computer in the vehicle can run normally.

It needs to be performed when the airbag deploys, the corresponding fault code of the collision data appears, the airbag indicator lights up, and the fault code cannot be cleared.

### **3.19 TRANSPORT (Transport Mode)**

This function can deactivate the transport mode so that the vehicle can function normally.

It needs to be performed when the following functions are disabled in order to reduce the power consumption: limiting the vehicle speed, not waking up the door opening network, disabling the remote control key, etc.

### **3.20 A/F (A/F Reset)**

This function can set or learn Air/Fuel ratio parameters.

### **3.21 STOP/START (Stop/Start Reset)**

This function can open or close the automatic start-stop function by setting the hidden function in ECU (provided that the vehicle has a corresponding hidden function supported by hardware).

### **3.22 NOX (NOx Sensor Reset)**

This function can reset the catalytic converter learned value stored in the engine ECU. It needs to be performed when the NOx fault is re-initialized and the NOx catalytic converter is replaced.

### **3.23 ADBLUE (Diesel Engine Exhaust Gas Filter)**

After the diesel exhaust treatment fluid (car urea) is replaced or filled up, urea reset operation is required.

### **3.24 SEATS (Seat Calibration)**

This function can match the seats that are replaced and repaired with memory function.

### **3.25 COOLANT (Coolant Bleeding)**

This function can activate the electronic water pump before venting the cooling system.

### **3.26 TYRE (Tire Reset)**

This function can set the size parameters of the modified or replaced tire.

### **3.27 WINDOWS (Windows Calibration)**

This feature can perform door window matching to recover ECU initial memory and recover the automatic ascending and descending function of power window.

### **3.28 LANGUAGE (Language Change)**

This function can change the system language of the vehicle central control panel.

### **3.29 CLUTCH MATCHING**

This function can change the clutch pedal position or switch learning. After ECU replacement, gearbox replacement/removal, or clutch replacement, this function learns the contacts and positions where the clutch starts to transmit engine torque. Suitable for adaptive clutches. Confirm the behavior of the clutch corresponding to the position where the accelerator is lightly depressed when the vehicle is started. If smooth, the contact point is correct. If the engine revs too high when the clutch starts to deliver engine torque, or if there is a hard jerk, the contact point is incorrect. This condition requires operation of the clutch matching function.

### **3.30 AC System Relearn/Initialization**

If the ECU or actuator of the vehicle air conditioner is replaced, or the memory of the ECU memory is lost, air conditioner initialization learning is needed.

### **3.31 Engine Power Balance Monitoring**

At the power stroke of each cylinder, power balance monitors crankshaft acceleration, thus determining the relative power provided by each cylinder.

### **3.32 Gas Particulate Filter Regeneration**

After long-term use of the particle catcher, fuel consumption can be increased, engine output power can be decreased, then in this case, the GPF needs to be replaced or regenerated.

### **3.33 High Voltage Battery Diagnostics**

For diagnosis and state information detection on high-voltage accumulator.

### **3.34 Intelligent Cruise Control System**

For replacement of intelligent cruise control system of vehicle and matching after repairing.

### **3.34 Motor Angle Calibration**

There is a deviation between the rotor position detected by the angle position sensor of the motor and the actual rotor magnetic field position, so it is necessary to calibrate the motor angle.

### **3.35 IMMO PROG (Optional)**

Anti-theft editor supports vehicle key chip read and write, EEPROM chip read and write, MCU chip read and write, engine ECU and transmission ECU EEPROM and FLASH read and write.

### **3.36 CODAGE ECU**

After performing the encoding function of some systems, the control unit needs to be reset. Sometimes bad driving habit data can also be eliminated by resetting the ECU.

The ECU reset service can command the ECU to perform self-reset through diagnostic commands. There are many forms of reset, which are distinguished according to the sub-function parameters. The ECU may also be hard factory reset by disconnecting the battery.

### **3.37 FRM MATCHING**

The foot space module is referred to as FRM. It is composed of a circuit module with a CPU. Its main function is to control the doors, windows, headlights and communication

system of the vehicle. After matching, it is used to clear the short circuit fault of the light.

Damage to the FRM module can occur when replacing the battery, if the start switch is not turned off, if the battery terminal is grounded, or other non-professional battery operations occur. The general result is that the CPU data on the circuit board is lost, and control of things such as light, doors, and windows fails. If the data is lost, the same set of data needs to be rewritten to repair it.

### **3.38 GATEWAY MODULE DATA CALIBRATION**

The gateway control unit needs to be calibrated after replacing to repair inconsistencies, such as VIN.

A "gateway" is designed between the two independent buses of the power system CAN and the body system CAN to recognize the resource sharing between each CAN and feed back the information of each data bus back to the instrument panel.

### **3.39 RAINFALL LIGHT SENSOR**

The rain sensor is used to adjust the automatic wiper frequency and the light sensor adjusts the light intensity of the automatic headlights according to the ambient light and darkness. This function can adjust the initial parameters.

### **3.40 TURBOCHARGING MATCHING**

Use this function for learning after replacement of the booster system components or after resetting turbocharger learning value.

The parameters that affect the engine boost mainly include the air flow of the engine, the boost pressure ratio, the efficiency of the compressor, and the temperature of the engine exhaust gas. When replacing parts such as the turbine, its initial value must be reset, and if fine-tuning is required, some settings may be adjusted through this function.

## **4. ADAS**

The Advanced Driver Assistance System (ADAS) is an electronic component in vehicles that includes a variety of vehicle safety functions such as automatic emergency braking (AEB), lane departure warning (LDW), lane keeping assistance, blind spot elimination, night vision cameras, and self-adaptive lighting. For this function, it is necessary to use the ADAS calibration device and activate ADAS software.



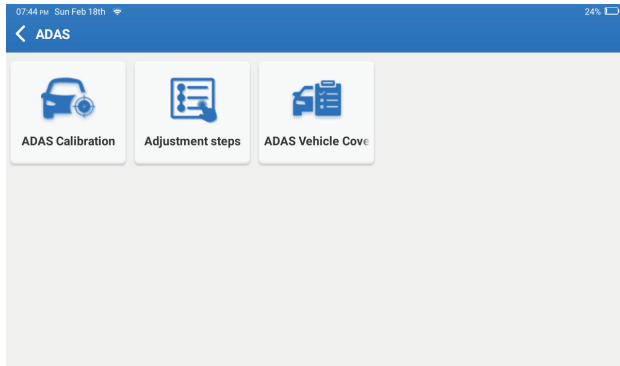

Notes: ADAS function requires additional hardware (optional), which needs to be purchased.

## 5. Module

This module displays extended functions that can be used with external devices.

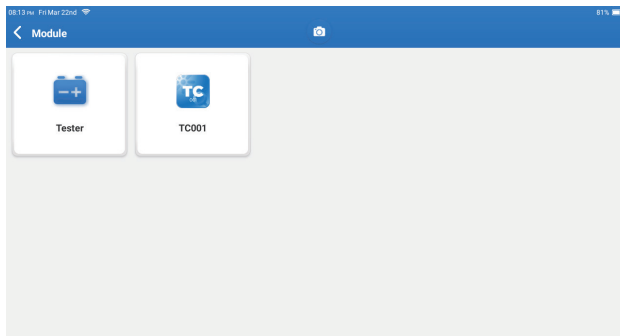

Notes: These functions require additional hardware (optional), which needs to be purchased.

## 6. Update

This module allows you to update the diagnostic software & App to the latest version. Tap "Update" on the Home Menu. The following page will appear:

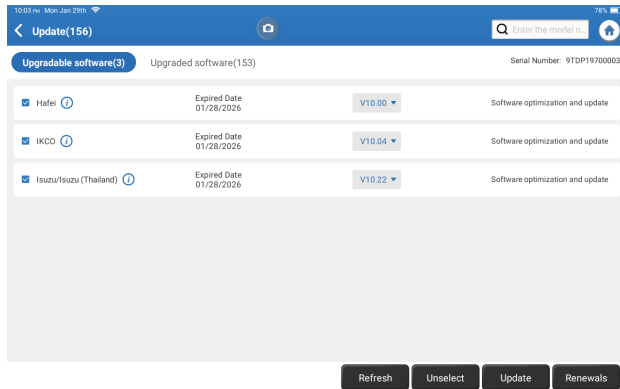

Tap "Update" to upgrade the selected software.

## 7. Support

In this function, you can request remote assistance through third-party software. By sending your device ID number to the remote technician or after-sales personnel, you can authorize the other party to remotely operate the Phoenix XLink device, to guide you through the problems encountered in the process of using the device.

## 8. Library

Tap "Library" on the Home Menu. The following page will appear:

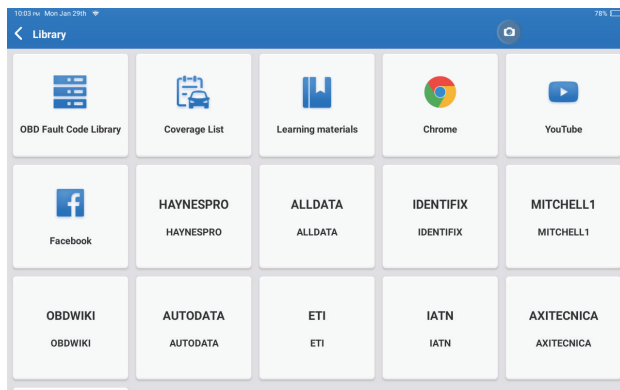

- 8.1 OBD Fault Code Library: To view the definition of DTCs (Diagnostic Trouble Codes).
- 8.2 Coverage List: To view the supported functions and car systems after selecting the vehicle make.
- 8.3 Learning Materials: To view the playback of operating functions on specific vehicle models.

## 9. History

This module can record and establish the file of the diagnosed vehicles, including all diagnostic-related data such as diagnostic reports, data stream records, and screenshots.

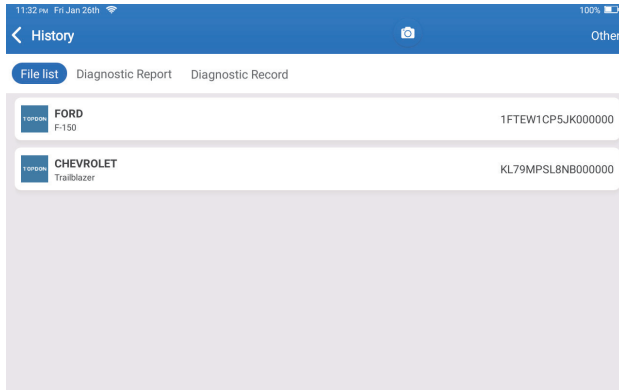

## 10. Feedback

If you encounter any unsolved problems in the diagnostic process, you can send the last 20 test records to us by using the "Feedback" feature for timely technical EN assistance. Tap "Feedback" on the Home Menu. The following page will appear:

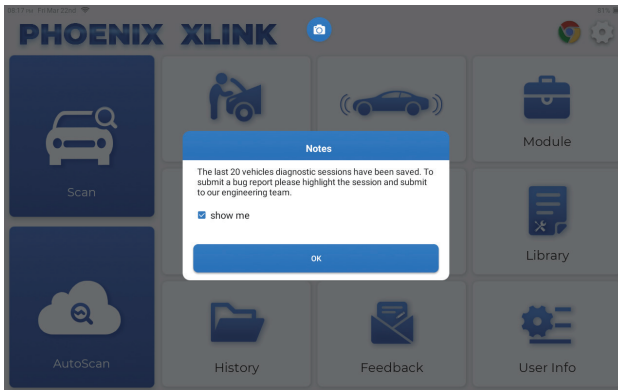

Tap “OK” to enter the vehicle diagnostic feedback selection menu.

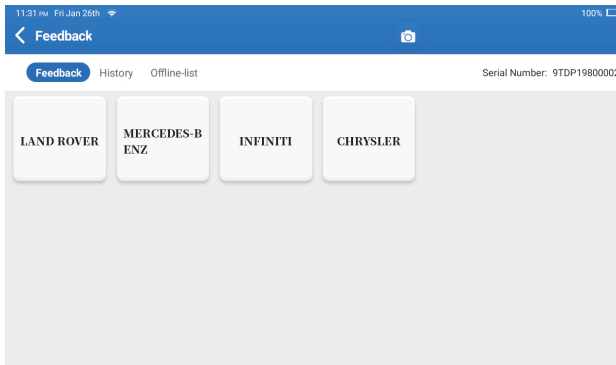

\*Explanation of terms:

- Feedback: To show the tested vehicle model list.
- History: To view all diagnostic feedback and check the processes.
- Offline-list: To display all diagnostic feedback logs which have not been submitted successfully yet due to the network failure. The failed logs will be re-uploaded automatically once the tablet gets a stable network signal.

Our technical support will handle your feedback as quickly as possible.

## 11. User Info

You can modify or add related information in this module or adjust settings.

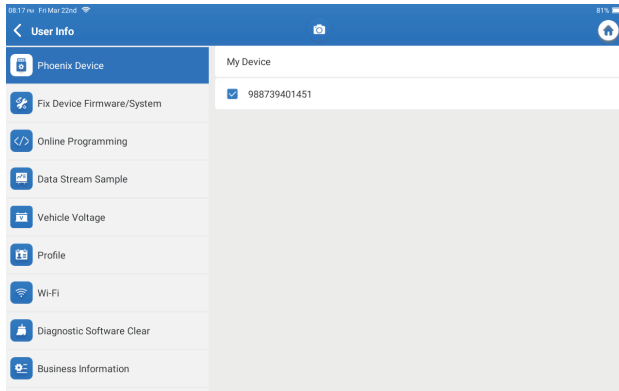

### 11.1 Phoenix Device

This option allows you to choose the suitable Device if there are several Device registered on the tablet.

### 11.2 Fix MDCI Firmware/System

This option can repair the MDCI firmware. Please don't power off or switch interfaces during this process.

### 11.3 Data Stream Sample

This option manages the recorded data stream sample files.

### 11.4 Vehicle Voltage

Vehicle voltage testing through OBD II interface.

### 11.5 Profile

Sets and manages personal information.

### 11.6 Wi-Fi

This option sets up Wi-Fi networks to be connected.

### 11.7 Diagnostic Software Clear

This option can clear unused diagnostic software and free up the storage space.

### **11.8 Business Information**

This option can add information about the workshop which will be displayed in the diagnostic report.

### **11.9 Customer Management**

This option manages the information and data of clients.

### **11.10 Photo Album**

This module saves the screenshots.

### **11.11 Screen Recorder**

This module saves the screen recordings.

### **11.12 Upload Log**

When you encounter problems during use, you can use this function to upload APP logs and we will help you solve the problem.

### **11.13 Settings**

This option adjusts settings including Units, Time System, Diagnostic Software Auto Update, Language, Time Zone, Renewals, Clear Cache, USB Connection Mode, and Restore Factory Settings.

# Technical Specification

---

Operating System: Android 10.0

Screen: 10" Touchable; 1280 \* 800

Memory: 4G

Storage: 128G

Battery Capacity: 12,000mAh/3.8V

Camera: Rear 13.0MP

Network: Wi-Fi, WLAN 802.11b/g/n

Bluetooth: Bluetooth 5.0

Working Temperature: 32°F~122°F (0°C~50°C)

Storage Temperature: -4°F~140°F (-20°C~60°C)

Dimensions: 11.46\*7.83\*1.97 inches (291\*199\*50 mm)

Weight: 62.1 oz(1760.0 g)

## Warnings

---

- ✔ Always perform automotive testing in a safe environment.
- ✔ DO NOT smoke near the vehicle during testing.
- ✔ DO NOT place the diagnostic tool near the engine or exhaust pipe to avoid damage from high temperatures.
- ✔ DO NOT wear loose clothing or jewelry when working on an engine.
- ✔ DO NOT connect or disconnect any test equipment while the ignition is on or the engine is running.
- ✔ DO NOT disassemble the Phoenix XLink.
- ✔ Engine parts will become hot when the engine is running. To prevent severe burns, avoid contact with hot engine parts.
- ✔ When an engine is running, it produces carbon monoxide, a toxic and poisonous gas. Operate the vehicle ONLY in a well-ventilated area.
- ✔ Wear safety eye protection that meets ANSI standards.

## Cautions

---

- ✔ Please ensure that the vehicle battery is fully charged, and the scanner is firmly connected to the vehicle DLC to avoid erroneous data generated by the scanner and diagnostic systems.
- ✔ Please do not use the diagnostic tool while driving.
- ✔ Keep clothing, hair, hands, tools, test equipment, etc. away from all moving or hot engine parts.
- ✔ Keep the scanner dry, clean, free from oil, water, or grease. Use a mild detergent on a clean cloth to clean the outside of the scan tool when necessary.
- ✔ Keep the scanner out of the reach of children.



# FAQ

---

Q: The tablet cannot be turned on after being fully charged.

A:

Possible Cause	Solution
The tablet has been standby for too long, and the battery drains.	Charge it for over 2 hours before turning it on.
Problem of the Charger.	Please contact the dealer or TOPDON after-sale service for timely support.

Q: Why can't I register?

A:

Possible Cause	Solution
The tablet isn't connected to a network.	Make sure the network is stable.
There is no verification code in the email box.	Check if the email address is valid and resend the code.
Server problem.	Server maintenance. Please try again later.

Q: Why cannot login?

A:

Possible Cause	Solution
The equipment is not connected with the network	Make sure that the equipment is connected with the network normally
The user name or password is incorrect	Make sure the user name and password input is correct; Contact the TOPDON customer service or regional sales to find back the user name and password
Server problem	The server is maintained, please try later

Q: Why cannot the product be activated?

A:

Possible Cause	Solution
The equipment is not connected with the network	Make sure that the equipment is connected with the network normally
Serial number and activation code input is incorrect	Make sure the serial number and activation code input is correct. (the serial number consists of 12 digits, and the activation code consists of 8 digits)
Activation code is valid	Contact TOPDON after-sales service to get support.
It prompts the setting is omitted	Contact TOPDON after-sales service to get support.

Q: Software upgrading failure.

A:

Possible Cause	Solution
The equipment is not connected with the network	Make sure that the equipment is connected with the network normally
Problems of server	The server is maintained, please try later

Q: The diagnosis line is not powered on when connected to the vehicle.

A:

Possible Cause	Solution
The diagnosis line is insufficient in contact	Please replug the diagnosis line
Vehicle diagnosis seat lines are not in good contact	Please check whether the diagnosis pin is normal
The battery itself of the vehicle is under power	Please replace the accumulator

**Q:** Can I use other chargers to charge the tablet?

**A:** No, please use the original charger provided by TOPDON.

Any damage and economic loss caused by using the improper battery charger will not be our responsibility.

**Q:** How to save the battery power?

**A:** Please switch off the screen while the tablet is idle, or set a short standby time, or reduce the brightness of the screen.

**Q:** Are there non-standard OBDII adapters in the box?

**A:** Yes.

**Q:** Communication error with vehicle ECU?

**A:** Please confirm the following cases:

- Whether the ignition switch is ON.

Or, send your vehicle's year, make, model, and VIN data to us via the "Feedback" feature for timely technical assistance.

**Q:** Failed to get access to the vehicle's ECU system?

**A:** Please confirm the following cases:

- Whether the system is available in the vehicle.
- Whether the is correctly connected.
- Whether the ignition switch is ON.

**Q:** Error of the diagnostic software.

**A:** Please operate as follows:

- Tap "Feedback" to send specific problems to us for technical support.
- Tap the vehicle software icon, and hold it to uninstall the corresponding software, and then enter the upgrade center to download and install the new version.

# WARRANTY

## TOPDON's One Year Limited Warranty

TOPDON warrants to its original purchaser that the company's products will be free from defects in material and workmanship for 12 months from the date of purchase (Warranty Period).

For the defects reported during the Warranty Period, TOPDON will either repair or replace the defective part or product according to its technical support analysis and confirmation.

TOPDON shall not be liable for any incidental or consequential damages arising from the device's use, misuse, or mounting.

If there is any conflict between the TOPDON warranty policy and local laws, the local laws shall prevail.

This limited warranty is void under the following conditions:

- Misused, disassembled, altered or repaired by unauthorized stores or technicians.
- Careless handling and operation's violation.

Notice: All information in this manual is based on the latest information available at the time of publication and no warranty can be made for its accuracy or completeness. TOPDON reserves the right to make changes at any time without notice.

## FCC Statement

Any changes or modifications not expressly approved by the party responsible for compliance could void the user's authority to operate the equipment.

This device complies with Part 15 of the FCC Rules. Operation is subject to the following two conditions:

- (1) this device may not cause harmful interference, and
- (2) this device must accept any interference received, including interference that may cause undesired operation.

Note: This equipment has been tested and found to comply with the limits for a Class B digital device, pursuant to Part 15 of the FCC Rules. These limits are designed to provide reasonable protection against harmful interference in a residential installation. This equipment generates, uses, and can radiate radio frequency energy, and if not installed and used in accordance with the instructions, may cause harmful interference to radio communications. However, there is no guarantee that interference will not occur in a particular installation. If this equipment does cause harmful interference to radio or television reception, which can be determined by turning the equipment off and on, the user is encouraged to try to correct the interference by one or more of the following measures:

- Reorient or relocate the receiving antenna.
- Increase the separation between the equipment and receiver.
- Connect the equipment into an outlet on a circuit different from that to which the receiver is connected.
- Consult the dealer or an experienced radio/TV technician for help.

## SAR Statement

Your Smart Automotive Diagnostic System is a radio transmitter and receiver. It is designed and manufactured not to exceed the emission limits for exposure to radio frequency (RF) energy set by the Federal Communications Commission of the U.S. Government. These limits are part of comprehensive guidelines and establish permitted levels of RF energy for the general population. The guidelines are based on standards that were developed by independent scientific organizations through periodic and thorough evaluation of scientific studies. The standards include a substantial safety margin designed to assure the safety of all persons, regardless of age and health. The exposure standard for Smart Automotive Diagnostic System employs a unit of measurement known as the Specific Absorption Rate, or SAR. The SAR limit set by the FCC is 1.6 W/kg. \* Tests for SAR are conducted with the Smart Automotive Diagnostic System transmitting at its highest certified power level in all tested frequency bands. Although the SAR is determined at the highest certified power level, the actual SAR level of the Smart Automotive Diagnostic System while operating can be well below the maximum value. This is because the Smart Automotive Diagnostic System is designed to operate at multiple power levels so as to use only the power required to reach the network. In general, the closer you are to a wireless base station antenna, the lower the power output. Before a model is available

for sale to the public, it must be tested and certified to the FCC that it does not exceed the limit established by the government adopted requirement for safe exposure. The tests are performed in positions and locations (e.g., at the ear and worn on the body) as required by the FCC for each model. The highest SAR value for this Smart Automotive Diagnostic System when worn on the body, as described in this user guide, is 0.65W/Kg (Body-worn measurements differ among models, depending upon available accessories and FCC requirements). While there may be differences between the SAR levels of various Smart Automotive Diagnostic System and at various positions, they all meet the government requirement for safe exposure. The FCC has granted an Equipment Authorization for this model with all reported SAR levels evaluated as in compliance with the FCC RF exposure guidelines. SAR information on this Smart Automotive Diagnostic System is on file with the FCC and can be found under the Display Grant section of <http://www.fcc.gov/oet/fccid> after searching on FCC ID: 2AVYW-REMOTE Additional information on Specific Absorption Rates (SAR) can be found on the Cellular Telecommunications Industry Association (CTIA) web-site at <http://www.wow-com.com>. \* In the United States and Canada, the SAR limit for mobile phones used by the public is 1.6 watts/kg (W/kg) averaged over one gram of tissue. The standard incorporates a substantial margin of safety to give additional protection for the public and to account for any variations in measurements. The SAR test distance is 0mm.