

Phoenix Plus 2 英文说明书（英文）印刷要求说明

1、材质及幅面尺寸: 内页80g书写纸；封面/封底157g双铜纸过哑膜

副面尺寸: 150（宽）*172（高）mm；封面/封底幅面尺寸与正文幅面尺寸相同；

2、颜色：黑白

3、装订方式：骑马钉

For Services and Support



TEL

86-755-21612590
1-833-629-4832 (North America)



EMAIL

SUPPORT@TOPDON.COM



WEBSITE

WWW.TOPDON.COM



FACEBOOK

@TOPDONOFFICIAL



TWITTER

@TOPDONOFFICIAL



RoHS



Phoenix Plus 2

Smart Automotive Diagnostic System

USER MANUAL



TOPDON

Contents

Welcome	3
About.....	3
Package List	3
Compatibility	3
Notice.....	4
General Information of OBDII (On-Board Diagnostics II).....	4
Diagnostic Trouble Codes (DTCs)	4
Product Descriptions	5
Preparation & Connection.....	7
Operation Introduction.....	11
Technical Specification.....	36
Warnings.....	37
Cautions.....	37
FAQ.....	38

Welcome

Thank you for purchasing TOPDON's Smart Automotive Diagnostic System Phoenix Plus 2. Please read and understand this user manual prior to the operation.

About

TOPDON's Phoenix Plus 2 features comprehensive diagnostic capabilities. The accuracy of test readings, expanded vehicle coverage, improved speed and an abundance of user-friendly nature make this diagnostic tablet stand out in its class and give mechanics and professionals a great deal of help in their diagnostic work.

Package List

- Phoenix Plus 2
- Phoenix MDCI
- OBDI Adapter BOX Transfer Line
- OBDII Extension Cable
- Cigarette Lighter Cable
- Type-C to USB Cable
- Battery Clamps/Cable Set
- Power Adaptor
- User Manual
- Non-Standard OBDII Adapter*10
- Fuse ($\varphi 5 \times 20\text{mm}$)*4
- Fuse ($\varphi 6 \times 30\text{mm}$)*2

Compatibility

TOPDON's Phoenix Plus 2 is compatible with the following protocols:

- ISO 9142-2
- ISO 14230-2
- ISO 15765-4
- K/L-Line
- SAE-J1850 VPW
- SAE-J1850 PWM
- CAN ISO 11898
- Highspeed
- Middlespeed
- CAN FD Protocol
- Lowspeed and Singlewire CAN
- GM UART
- UART Echo Byte Protocol
- Honda Diag-H Protocol
- TP 2.0
- TP 1.6
- SAE J1939
- SAE J1708
- Fault-Tolerant CAN
- And More

Notice

Phoenix Plus 2 may automatically reset while being disturbed by strong static electricity. THIS IS A NORMAL REACTION.

This user manual is subject to change without written notice.

Read the instruction carefully and use the unit properly before operating. Failure to do so may cause damage and/or personal injury, which will void the product warranty.

General Information of OBDII (On-Board Diagnostics II)

The OBDII system is designed to monitor emission control systems and key engine components by performing either continuous or periodic tests of specific components and vehicle conditions, which will offer three pieces of such valuable information:

- Whether the Malfunction Indicator Light (MIL) is commanded "on" or "off";
- Which, if any, Diagnostic Trouble Codes (DTCs) are stored;
- Readiness Monitor status.

Diagnostic Trouble Codes (DTCs)

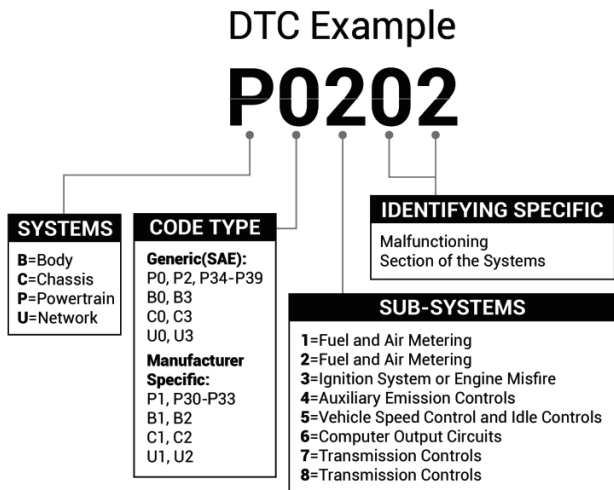

Product Descriptions

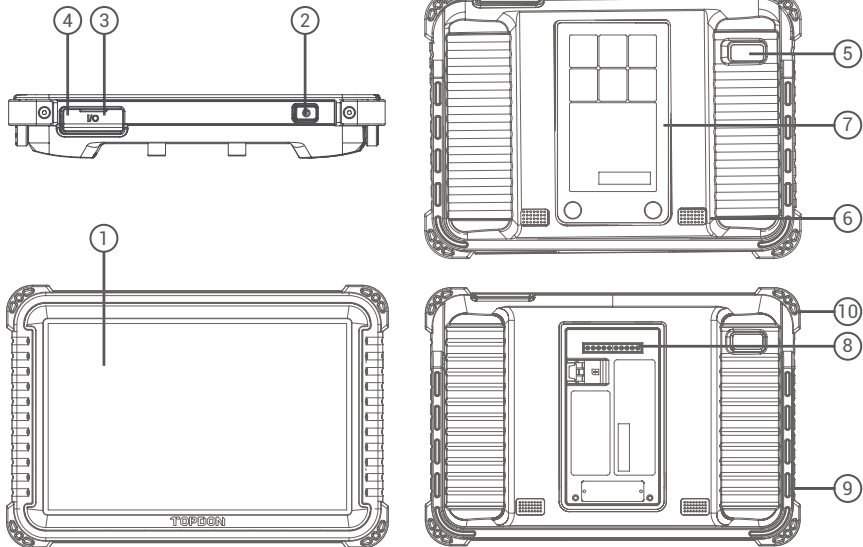

NO.	Name	Descriptions
1	10" Touchable Screen	Show test results.
2	Power Button	<ul style="list-style-type: none"> • Hold the button for 3 seconds to turn the tablet on, or off. • Hold the button for 2 seconds for a forced shutdown. • Press the button to wake up the screen or turn off the screen.
3	USB Port	Can be used to charge 5V electronic devices.
4	Type C Charging Slot	For charging the tablet.
5	Rear Camera	Snapshot the view ahead of the screen.
6	Loudspeaker	Convert an audio signal into a corresponding sound.

7	Backplane	Remove and install added modules on the backend.
8	Pin	Used for communication between the function module and the tablet.
9	Adjustable Stand	Keep the tablet standing at the desk, or use it to hang the tablet on the steering wheel.
10	Rubber Corner Protections	Secure the tablet from shock and accidental dropping.

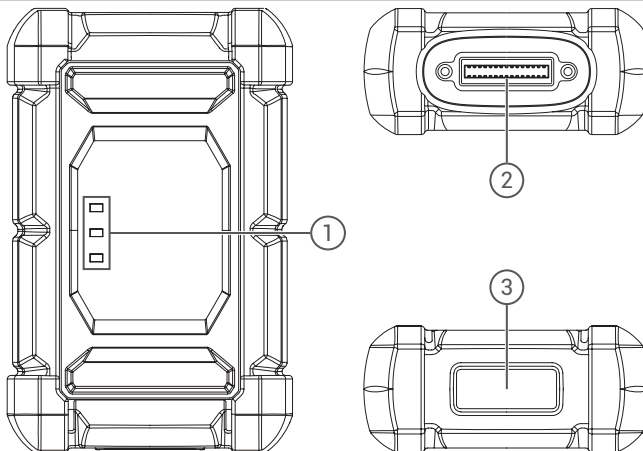

NO.	Name	Descriptions
1	Indicator light	<p>Three LED indicators are provided on each side, and the prompts are as follows:</p> <ul style="list-style-type: none"> • Power: Red light indicates power on. • Vehicle: Green flashing means it is communicating with the vehicle. • I/O: Purple solid light means the USB is connected to the host.
2	DB30 diagnostic port	Plug in the diagnostic cable whose OBD 16-pin connector is linked to the DLC of the vehicle.
3	Type-C port	Type-C port is designed for building stable communication while ECU Programming or IMMO Key Programming.

Preparation & Connection

1. Turn the ignition off.

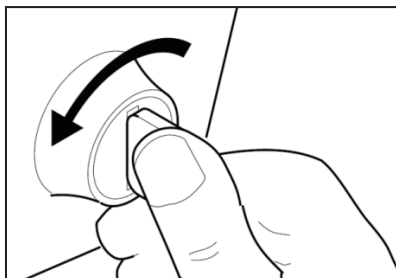

2. Locate the vehicle's DLC port.

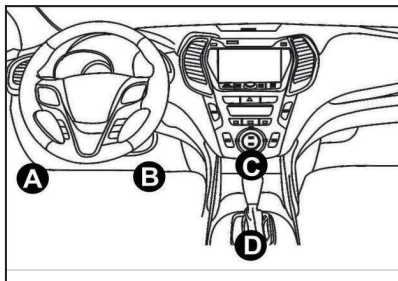

3. Plug the TOPDON Phoenix MDCI dongle into the vehicle's DLC port.

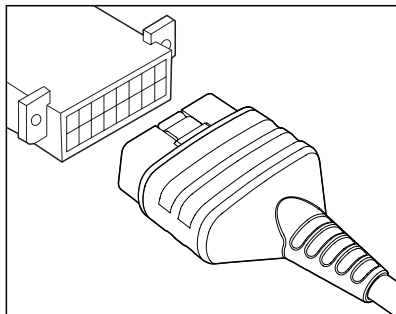

4. Turn the ignition on. The engine can be off or running.
5. Hold the power button for 3 seconds to turn the tablet on. (The tablet must be charged.)
The tablet will start initializing and enter the following interface:

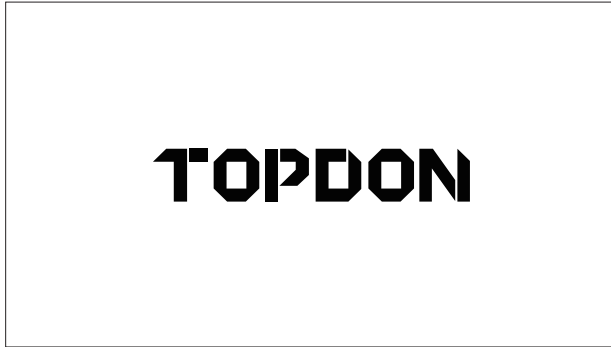

Note: Don't connect or disconnect any test equipment with the ignition on or engine running.

6. Language Setting

Select operating language in the following interface:

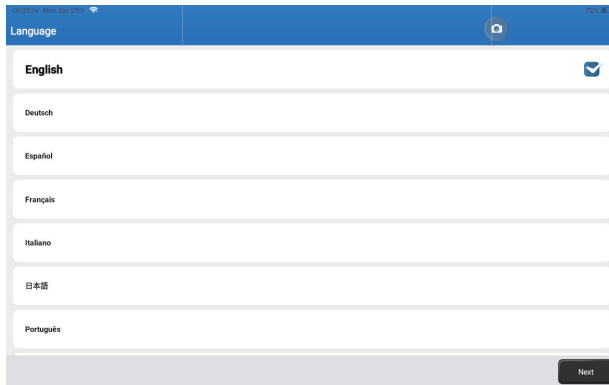

7. Connect Wi-Fi

The system will automatically search all available Wi-Fi networks. Please connect to the trusted Wi-Fi accounts.

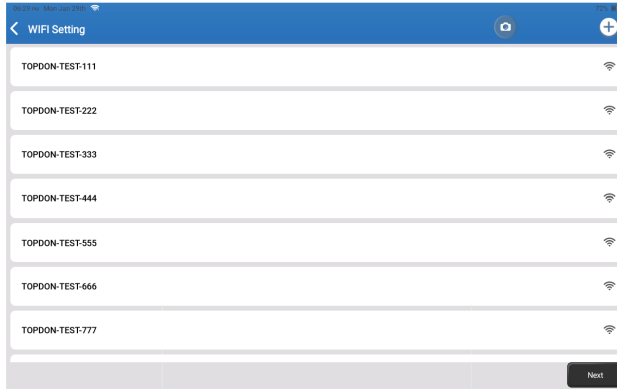

8. Choose Time Zone

Choose the time zone of your current location. The system will automatically configure the time.

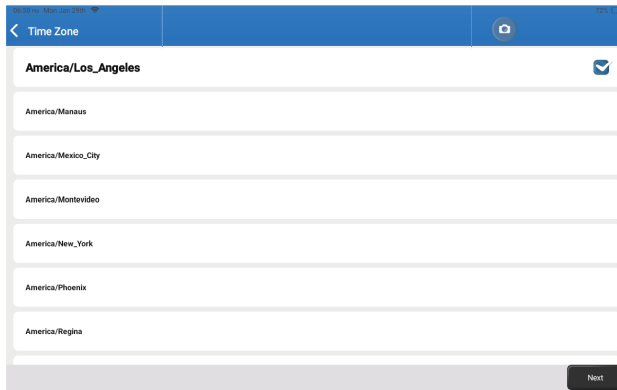

9. User Agreement

Please read all the terms and conditions of the user agreement carefully. Select “Agree with above terms”.

Tap “Next” to log in.

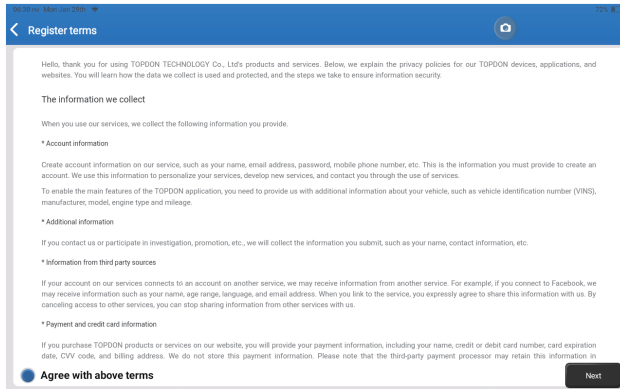

The following page will appear:

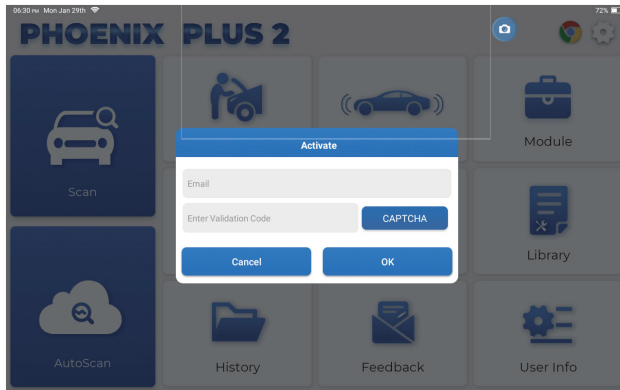

10. Activate

Please enter your email and tap the CAPTCHA button to obtain the Validation Code. After entering the Validation Code, tap the OK button and get started with Phoenix Plus 2.

Operation Introduction

TOPDON's Phoenix Plus 2 features an array of practical functions, including Scan, AutoScan, Services, ADAS, Module, Update, Support, Library, History, Feedback and User Info.



TOPDON's Phoenix Plus 2 supports AutoScan and Scan covering OBDII diagnosis, full system diagnosis for most modern vehicle models worldwide.

1. AutoScan (Intelligent Diagnosis)

Plug the Phoenix MDCI dongle into the vehicle's DLC port.

Tap "AutoScan" on the Home Menu after connecting to the vehicle.

The tool will start the AutoScan procedure, and automatically read the vehicle's VIN information, as shown below:

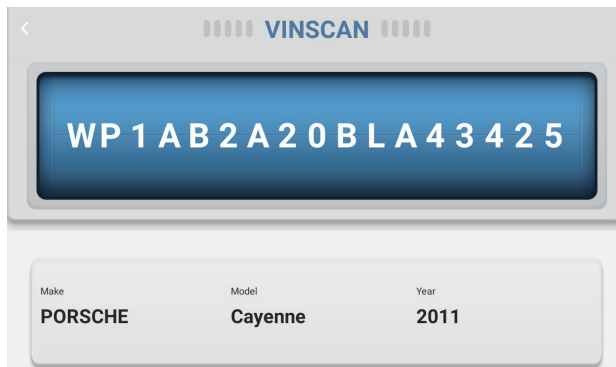

Note: If the AutoScan can not identify the vehicle, please try to connect to the network. Not all cars support the AutoScan function due to auto manufacturers' settings.

2. Scan(Manual Diagnosis)

If Phoenix Plus 2 fails to get access to the vehicle VIN data automatically, tap "Scan" on the Home Menu. The following page will appear:

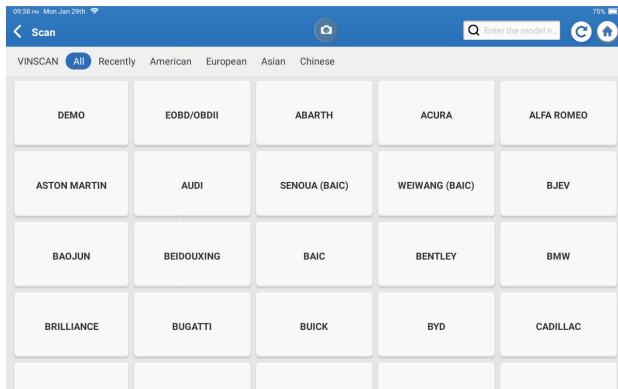

There are two ways in this module to get access to vehicle diagnostic functions.

2.1 The first way is using "VINSCAN".

Tap "VINSCAN". The following page will appear:

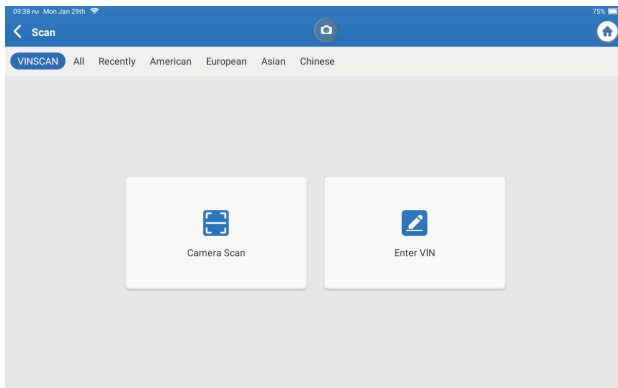

2.1.1 Tap "Camera Scan". The following page will appear

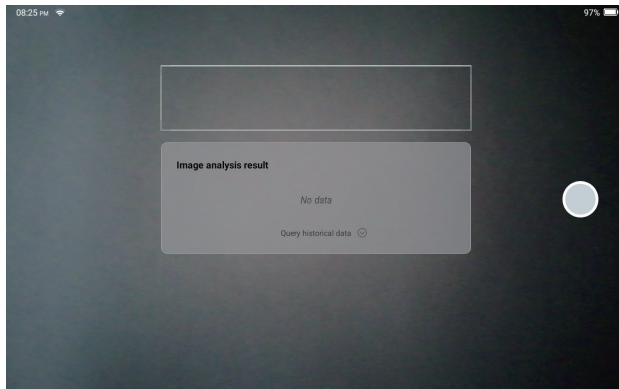

If the VIN barcode cannot be recognized, please tap  to manually input the VIN.

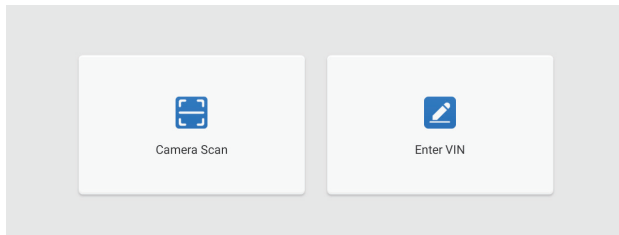

After scanning, the following page will appear:

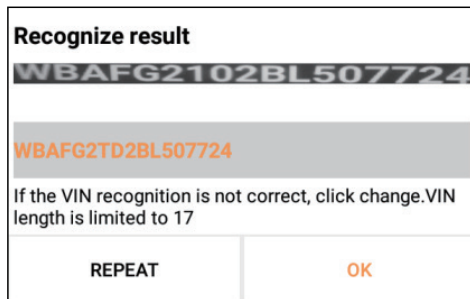

Note: the VIN code in yellow can be modified if it isn't correct.

2.1.2 Or, tap "Enter VIN", the following page will appear:

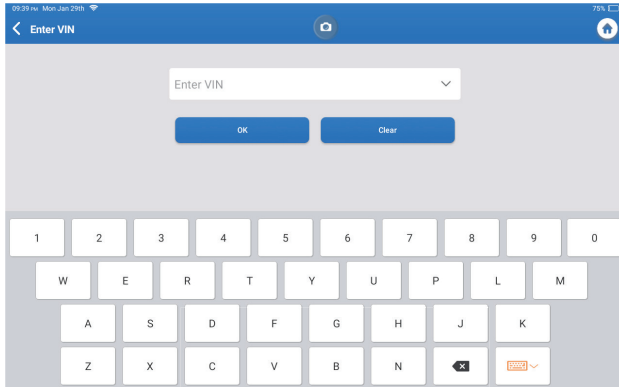

You need to input the vehicle's VIN manually.

Note: VIN characters need to be capital letters A through Z and numbers 1 through 0. However, the letters I, O, and Q won't be used in order to avoid misreading. No symbols or spaces are allowed in the VIN.

2.2 The second way is manually selecting the vehicle's make, model, and year.

Tap a corresponding diagnostic software logo on the following page:

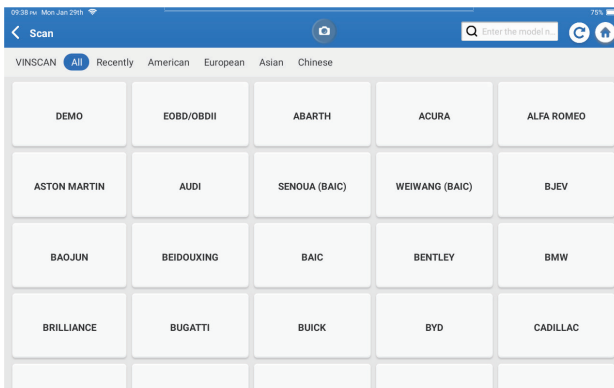

Take "Demo" as an example. The following page will appear:

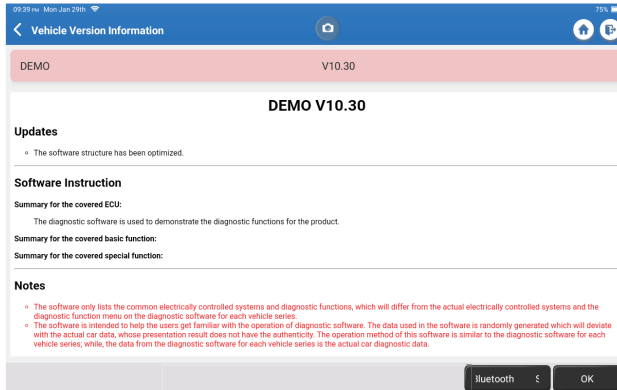

Tap "OK". Select "Demo" from the pop-up Notes. Then select a vehicle make. The tablet will automatically navigate to the Show Menu:

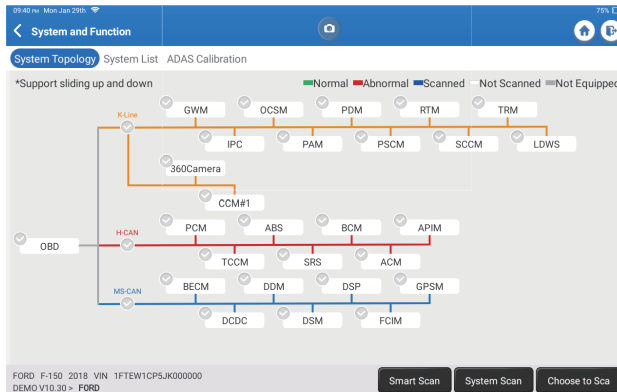

The interface has two display modes of system topology and system list, with the same functions. Switch according to personal preference.

2.2.1 Smart Scan

This function is used to quickly detect vehicles and view vehicle health reports (this item will only be displayed if the model diagnosis software supports this function).

Tap "Smart Scan", the system starts to scan fault codes in each system and displays specific scan results.

The systems with DTC(s) will be shown in red, with the specific definition(s).

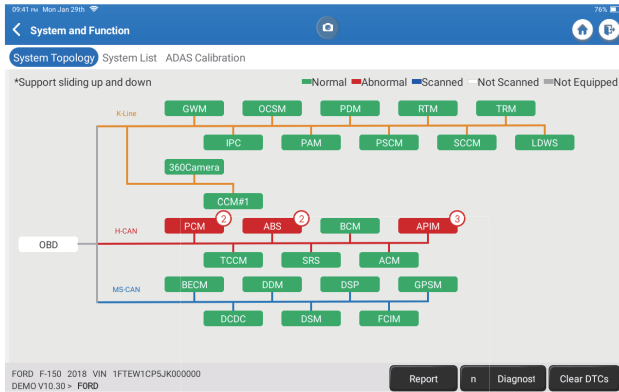

*Explanation of terms:

- Report: Save the current diagnosis result as a diagnosis report.
- Diagnostic Plan: Display all current Diagnostic Trouble Codes and descriptions.
- Clear DTCs: Clear all Diagnostic Trouble Codes with one simple touch.

Report

All System Diagnostic Report

TOPDON

Customer Name: N/A
Technician Name: N/A
Time: 2024-01-29 21:41:54

Shop Name: N/A	Phone Number: N/A
SN: 9TDP19700003	Email: N/A
Service Fee: N/A	Repair Order No: N/A
Address:	City: N/A
State/Country: N/A	Country: N/A
Zip Code: N/A	Remarks: N/A
Make: FORD	Model: F-150
Year: 2018	Displacement: 2.7L
VIN: 1FTEW1CP5JK000000	Mileage: 73239 km
Registration No: N/A	Vehicle Software Version: V10.30

Pre Scan

2024-01-29 21:41:54

Buttons: Share, Open now

2.2.2 System Scan

This function will automatically scan all systems of the vehicle.

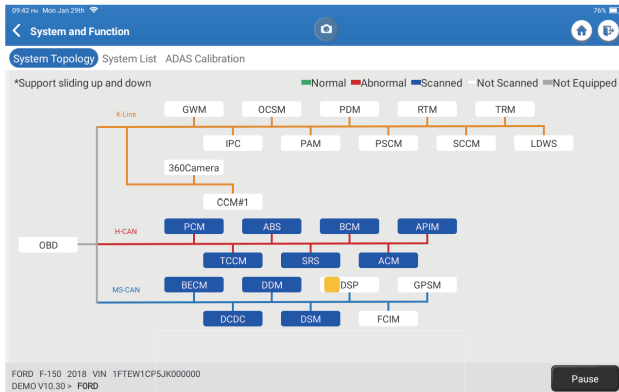

2.2.3 Choose to Scan

Scan the manually selected vehicle electric control system. Tap "PCM" --- as an example to demonstrate. Tap the check box of the "PCM" and tap "Choose to Scan" to scan the system. Tap "PCM" and tap "Enter", the following page will appear.

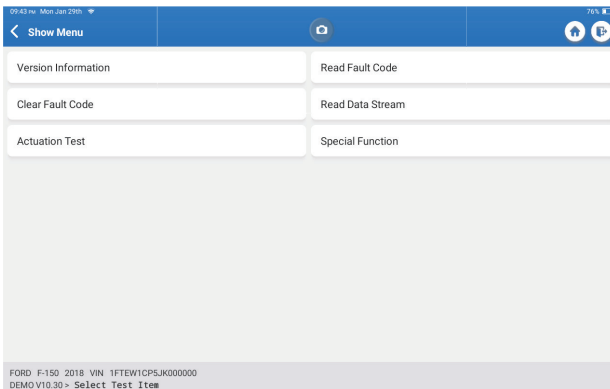

Note: This function will be available only when the diagnostic software supports it.

A. Version Information

This function reads the current version information of ECU.

B. Diagnostic Trouble Code

This function can read the Diagnostic Trouble Codes (DTCs) in the ECU memory, helping quickly identify the cause of the vehicle breakdown.

Tap "Read Fault Code". The screen will display diagnostic results.

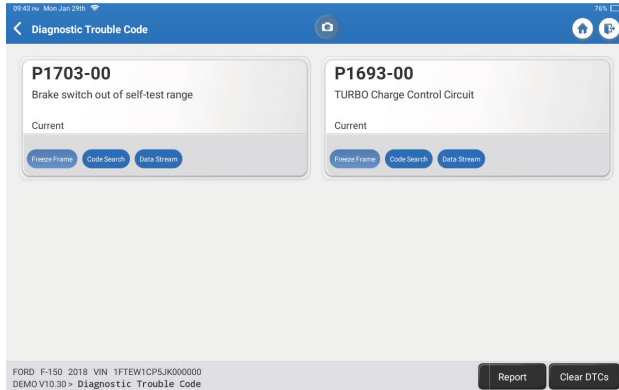

*Explanation of terms:

- Freeze Frame: Take a snapshot of specific data streams for verification when the DTC occurs.
- Code Search: Query DTC information through Google Chrome.
- Data Stream: Return to the data stream page.
- Report: Save the current diagnosis result as a diagnosis report.

C. Clear Fault Code

This function can clear the DTC of the ECU memory of the tested system.

D. Read Data Stream

This function can read and display real-time data and parameters.

Tap "Read Data Stream". The following page will appear:

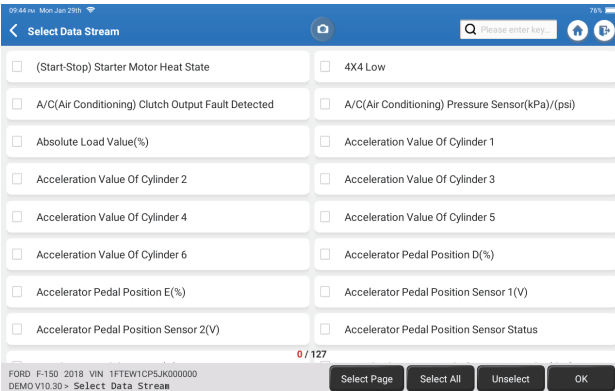

Select the data stream and tap “OK”:

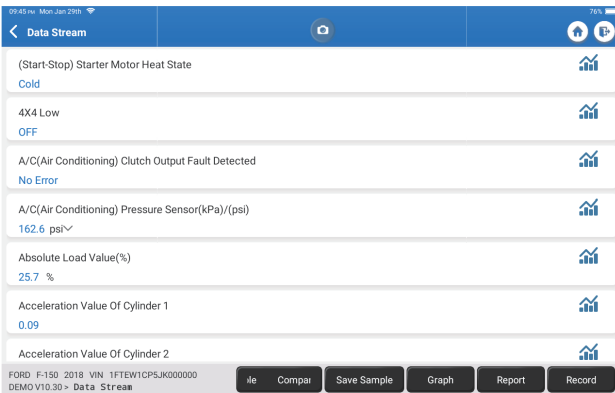



The system can display data streams in three modes:

- 1) Value (default): Shows parameters with numbers and lists.
- 2) Graph: Displays parameters with wave patterns.
- 3) Combine: The graphs can be merged for easier comparisons.

*Explanation of terms:

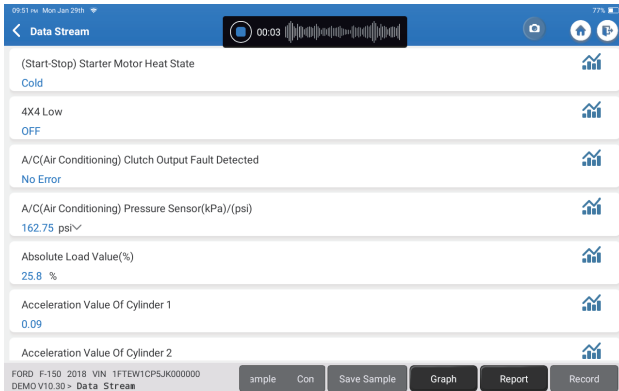
- Save Sample: You can save the current Data Stream as a Sample when the vehicle is running normally, and use this Sample Data Stream for future comparison and analysis. Tap “Save Sample” to start recording the sample data stream. The following page will appear:



Once the recording process is complete, tap “” to end the recording. The following page will appear:

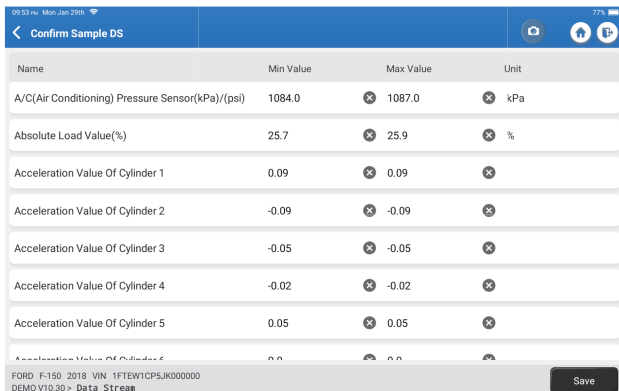

You can change the Min or Max value, and tap “Save” to save it as a Data Stream Sample. All Data Stream Sample files are stored in “User Info -> Data Stream Sample”.

- Compare Sample: Tap “Compare Sample” to select the saved Data Stream Sample files. The following page will appear:

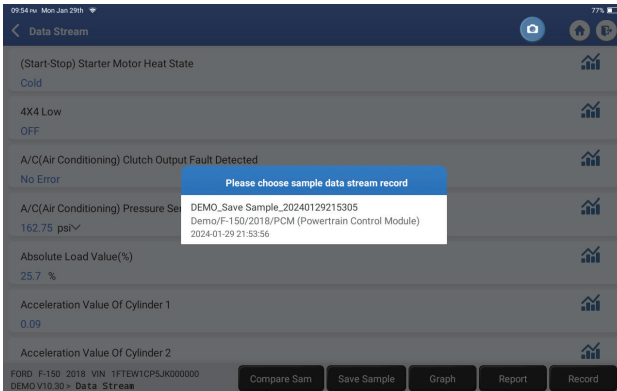

Tap the file you need. The following page will appear:

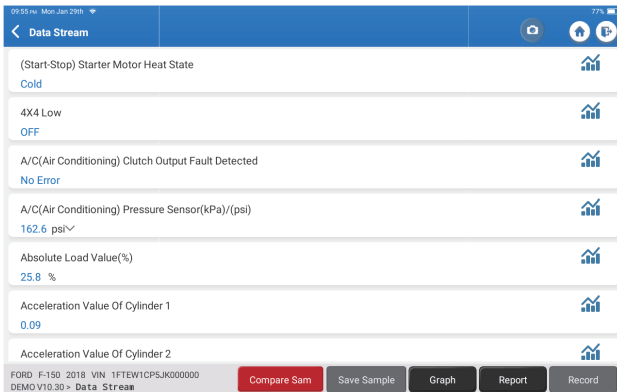

The Standard Range column will show the corresponding Data Stream Sample values for your comparison and analysis.

- Graph: To have the selected data streams (12 max items) displayed in waveform. Tap "Graph". The following page will appear:

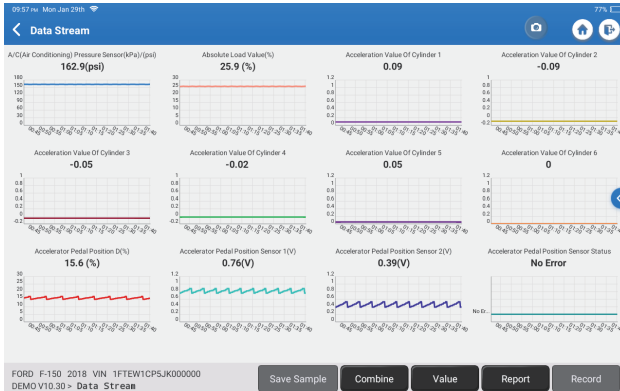

Tap “<” on the right side of the screen. The following page will appear:



Tap “Value” to view the data displayed in values.

Tap “Combine” to merge graphs for easier comparisons (A maximum of 4 values can be merged).

You can select specific data stream options to be viewed on the left.

Note: A maximum of 12 data streams can be displayed in this module.

- Report: To save the current data stream.
- Record: To record the diagnostic data for further analysis.
- 📊 : To view single data stream displayed in waveform. Tap “📊”. The following page will appear:

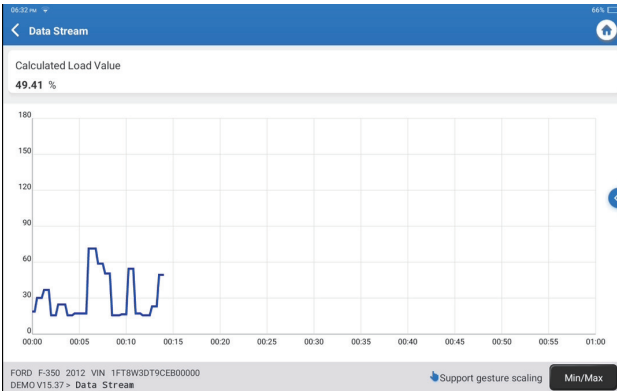

Tap "Min/Max" to define the maximum/minimum value. Once the value goes beyond the specified value, the data will be shown in red.

Tap "<" on the right side of the screen. The following page will appear:

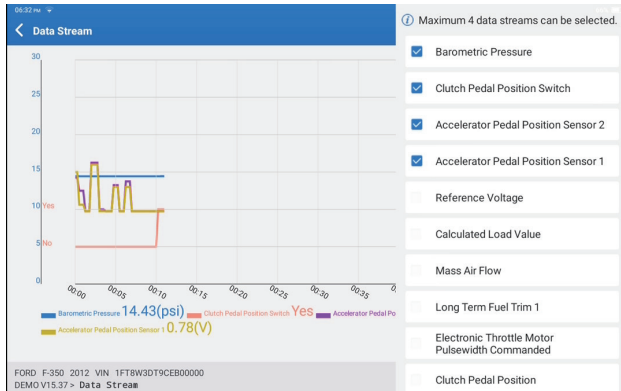

You can select specific data stream options to be viewed on the left. Note: A maximum of 4 data streams can be displayed in this module.

E. Actuation Test

This option is used to access vehicle-specific subsystem and component tests. Available tests vary by vehicle manufacturer, year, and model.

F. Special function

This option offers coding, reset, relearn, and more service functions, to help vehicles get back to functional status after repair or replacement. Available tests vary by vehicle manufacturer, year, and model.

2.2.4 ADAS Calibration

Tap "ADAS Calibration", and the screen will enter selection interface.

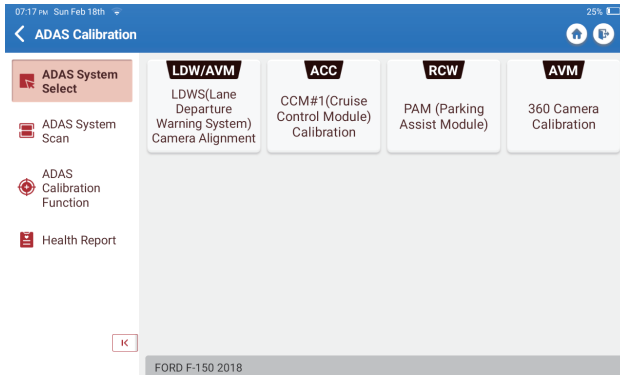

3. Services

TOPDON Phoenix Plus 2 is equipped with maintenance services to be very beneficial for technicians and mechanics working in the automotive repair industry.

3.1 OIL (Maintenance Light Reset)

This function enables you to reset the oil service lamp for the engine oil life system, which calculates an optimal oil life change interval depending on the vehicle driving conditions and weather events.

It needs to be performed in the following cases:

- If the service lamp is on, run car diagnostics first for troubleshooting. After that, reset the driving mileage or driving time, so as to turn off the service lamp, and enable a new driving cycle.
- If you have changed the engine oil or electric appliances that monitor oil life, you need to reset the service lamp.

3.2 ETS (Throttle Matching)

This function initializes the throttle actuator and returns the ECU's learning value to its initial state. This allows more accurate control of the throttle (or idle motor) movement to regulate the air intake.

It needs to be performed in the following cases:

- After replacing the electronic control unit, the relevant characteristics of the throttle operation have not been stored in the electronic control unit.
- After the electric control unit is powered off, the memory of the electric control unit is lost.
- After replacing the throttle assembly, you need to match the throttle.
- After replacing or disassembling the intake port, the controlling of the idle speed by the coordination between the electronic control unit and the throttle body is affected.
- The intake volume and the idle control behavior has changed while staying at the same throttle opening position, although the idle throttle potentiometer behavior hasn't changed.

3.3 SAS (Steering Angle Reset)

This function can reset the steering angle to zero to keep the car running straight.

It needs to be performed generally after replacing the steering angle position sensor, or after replacing the mechanical parts of the steering system (such as steering gear, steering column, tie rod ball head, steering knuckle), or after completing the four-wheel positioning, body repair, etc.

3.4 BMS (Battery Matching)

This function can reset the monitoring unit of the car battery, by clearing the original breakdown information about the lack of battery power to rematch the battery.

It needs to be performed in the following cases:

- Replacement of the main battery needs to utilize battery matching to clear the former information about the lack of power, thus avoiding false information detected by the relevant control module which may cause the failure of some electronic auxiliary functions. For example, the vehicle automatically stops. The sunroof can't work by one key. Electric windows can't open and close automatically.
- The battery monitoring sensor uses the battery matching function to re-match the control module with the monitoring sensor, so as to detect the use of the battery power more accurately, and avoid receiving wrong information from instrument prompts which will cause false alarms.

3.5 BLEEDING (ABS Bleeding)

This function enables you to perform tests to check the operating conditions of the Anti-lock Braking System (ABS).

It needs to be performed in the following cases:

- When the ABS lines contain air.
- When the ABS computer, ABS pump, brake master cylinder, brake cylinder, brake line, or brake fluid is replaced.

3.6 BRAKE (Electronic Parking Brake Reset)

This function helps you to replace and reset the brake pads.

It needs to be performed in the following cases:

- The brake pads and brake pad wear sensor are replaced.
- The brake pads indicator lamp is on.
- The brake pads sensor circuit is short, which is recovered.
- The servo motor is replaced.

3.7 DPF (DPF Regeneration)

This function can help remove particulate matter from the trap by using combustion oxidation methods to keep the performance of the trap stable.

It needs to be performed in the following cases:

- Replace the exhaust back pressure sensor.
- Disassembly or replacement of the particle trap.
- Removal or replacement of fuel additive nozzles.
- Removal or replacement of catalytic oxidizer.
- The DPF regeneration fault lamp is lit and matched after maintenance.
- Repair and replace the DPF regeneration control module.

3.8 GEAR (Tooth Learning)

This function can perform tooth learning for the car to turn off the MIL.

It needs to serve in the following cases:

- After the engine ECU, the crankshaft position sensor or crankshaft flywheel is replaced.
- There is a DTC of 'tooth not learned.'

3.9 IMMO (Anti-theft Matching)

This function can match the anti-theft key after replacing the ignition key, ignition switch, instrument cluster, engine control unit (ECU), body control module (BCM), and remote control battery.

3.10 INJEC (Injector Coding)

This function can write injector actual code or rewrite code in the ECU to the injector code of the corresponding cylinder, so as to have more accurately control or correct cylinder injection quantity.

It needs to be performed in the following cases:

- After the ECU or injector is replaced.

3.11 TPMS (Tire Pressure Reset)

This function can reset the tire pressure and turn off the tire pressure fault indicator when the car tire pressure fault indicator light is on.

3.12 SUS (Suspension Level Calibration)

This function is required to calibrate the level of the vehicle when the level sensor or control module in the air suspension system is replaced or when the level of the vehicle is incorrect.

3.13 AFS (Adaptive Front-Lighting System Reset)

This function enables you to initialize the adaptive headlamp system.

3.14 GEARBOX (A/T Learning)

This function helps complete the gearbox self-learning to improve gear shifting quality. It needs to be performed in the following cases:

- When the gearbox is disassembled or repaired (after some of the car battery is powered off), which leads to shift delay or shock problem.

3.15 SUN (Sunroof Initialization)

This function can set the sunroof lock off, close in rain, memory function of sliding / tilting sunroof, outside temperature threshold, etc.

3.16 EGR (EGR Adaption)

This function can learn the EGR (Exhaust Gas Recirculation) valve after it is cleaned or replaced.

3.17 ODO (ODO Reset)

This function can copy and write the value of kilometers in the chip of the odometer so that the odometer shows the actual mileage.

It can perform in the following cases:

- When the mileage is incorrect due to the damaged vehicle speed sensor or the odometer failure.

3.18 AIRBAG (Airbag Reset)

This function resets the airbag data to clear the airbag collision fault indicator, so that the airbag computer in the vehicle can run normally.

It needs to be performed in the following cases:

- When the vehicle collides and the airbag deploys, the corresponding fault code of the collision data appears, the airbag indicator lights up, and the fault code cannot be cleared.

3.19 TRANSPORT (Transport Mode)

This function can deactivate the transport mode, so that the vehicle can function normally.

It needs to be performed in the following cases:

- When the following functions disabled including limiting the vehicle speed, not waking up the door opening network, and disabling the remote control key, etc. in order to reduce the power consumption.

3.20 A/F (A/F Reset)

This function can set or learn Air/Fuel ratio parameters.

3.21 STOP/START (Stop/Start Reset)

This function can open or close the automatic start-stop function via setting the hidden function in ECU (provided that the vehicle has a corresponding hidden function supported by hardware).

3.22 NOX (NOx Sensor Reset)

This function can reset the catalytic converter learned value stored in the engine ECU.

It needs to be performed in the following cases:

- When the NOx fault is re-initialized and the NOx catalytic converter is replaced.

3.23 ADBLUE (Diesel Engine Exhaust Gas Filter)

After the diesel exhaust treatment fluid (car urea) is replaced or filled up, urea reset operation is required.

3.24 SEATS (Seat Calibration)

This function can match the seats with memory function that are replaced and repaired.

3.25 COOLANT (Coolant Bleeding)

This function can activate the electronic water pump before venting the cooling system.

3.26 TYRE (Tire Reset)

This function can set the size parameters of the modified or replaced tire.

3.27 WINDOWS (Windows Calibration)

This feature can perform door window matching to recover ECU initial memory, and recover the automatic ascending and descending function of power window.

3.28 LANGUAGE (Language Change)

This function can change the system language of the vehicle central control panel.

3.4.29 CLUTCH MATCHING

Clutch pedal position or switch learning. After ECU replacement, gearbox replacement/removal, clutch replacement, this function learns the contacts and positions where the clutch starts to transmit engine torque. Suitable for adaptive clutches. Confirm the behavior of the clutch corresponding to the position where the accelerator is lightly

depressed when the vehicle is started. If smooth, the contact point is correct. If the engine revs too high when the clutch starts to deliver engine torque, or if there is a hard jerk, the contact point is incorrect. This condition requires operation of the clutch matching function.

3.4.30 CODAGE ECU

After performing the encoding function of some systems, it is necessary to perform the control unit reset function; sometimes the data of your bad driving habits can also be eliminated by resetting the ECU.

The ECU reset service can command the ECU to perform self-reset through diagnostic commands. There are many forms of reset, which are distinguished according to the sub-function parameters. On the other hand, there are also hard factory resets by disconnecting the battery.

3.4.31 FRM MATCHING

The foot space module is referred to as FRM. It is composed of a circuit module with a CPU. Its main function is to control the doors, windows, headlights and communication system of the vehicle. After matching, it is used to clear the short circuit fault of the light.

When replacing the battery, the start switch is not turned off, the battery terminal is grounded, and some other non-professional battery operations can easily lead to damage to the FRM module. The general result is that the CPU data on the circuit board is lost, and there are control failures such as lights, doors and windows. If the data is lost, you only need to rewrite the same set of data to repair it.

3.4.32 GATEWAY MODULE DATA CALIBRATION

After replacing the gateway control unit, there may be inconsistencies such as VIN, so it needs to be calibrated.

A "gateway" is designed between the two independent buses of the power system CAN and the body system CAN to realize the resource sharing between each CAN and feed back the information of each data bus to the instrument panel.

3.4.33 RAINFALL LIGHT SENSOR

The rain sensor is used to adjust the wiper frequency, and the light sensor adjusts the light intensity of the automatic headlights according to the ambient light and darkness. This function can adjust the initial parameters.

3.4.34 TURBOCHARGING MATCHING

Learning after replacement of booster system components, or reset turbocharger learning value.

The parameters that affect the engine boost mainly include the air flow of the engine, the boost pressure ratio, the efficiency of the compressor, and the temperature of the engine exhaust gas. Replaced parts such as turbine, its initial value must be reset, and,

if fine-tuning is required, make some settings through this function.

3.4.35 IMMO PROG

The anti-theft programmer supports car key chip reading/writing, EEPROM chip reading/writing, MCU chip reading/writing.

4. ADAS

Advanced driver assistance systems (ADAS) is an electronic component in vehicles that include a variety of vehicle safety functions such as automatic emergency braking (AEB), lane departure warning (LDW), lane keeping assistance, blind spot elimination, night vision cameras, and self-adaptive lighting. For this function, it is necessary to use the ADAS calibration device produced and activate ADAS software.

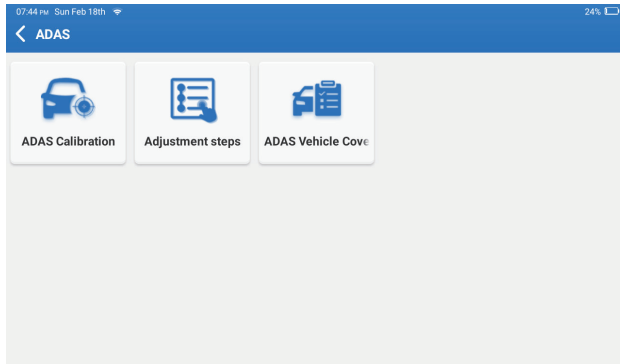

Notes: ADAS function requires additional hardware (optional), which needs to be purchased.

5. Module

This module displays extended functions that need to be used with external devices.

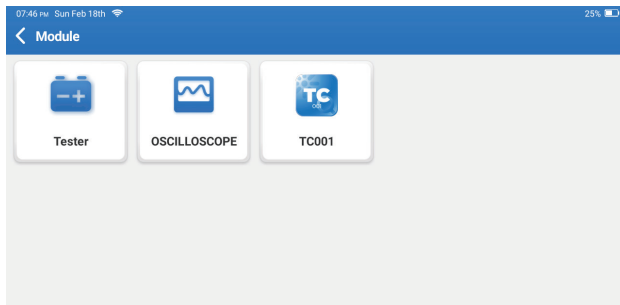

Notes: These functions requires additional hardware (optional), which needs to be purchased.

6. Update

This module allows you to update the diagnostic software & App to the latest version. Tap "Update" on the Home Menu. The following page will appear:

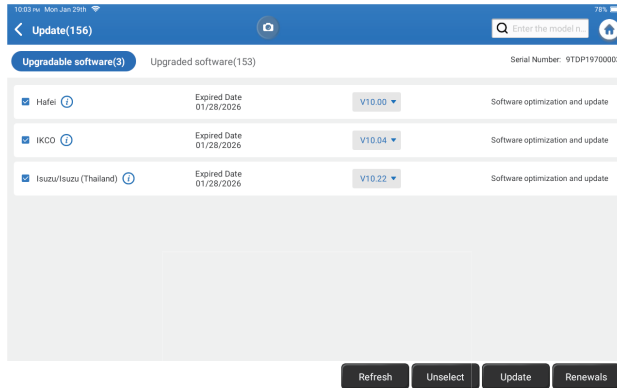

Tap "Update" to upgrade the selected software.

7. Support

In this function, you can request remote assistance through third-party software. By sending your device ID number to the remote technician or after-sales personnel, you can authorize the other party to remotely operate the Phoenix Plus 2 device, so as to guide you to the problems encountered in the process of using the device.

8. Library

Tap "Library" on the Home Menu. The following page will appear:

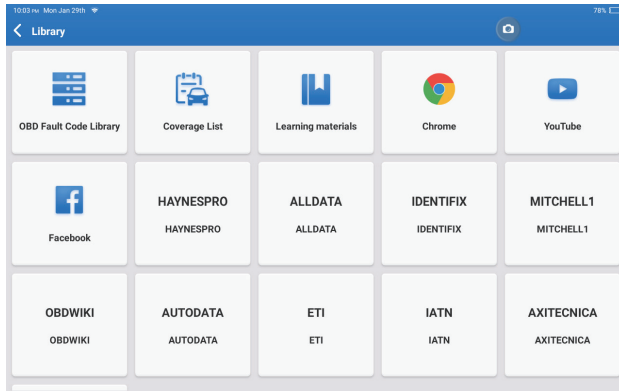

8.1 OBD Fault Code Library: To view the definition of DTCs (Diagnostic Trouble Codes).

8.2 Coverage List: To view the supported functions and car systems after selecting the vehicle make.

8.3 Learning Materials: To view the playback of operating functions on specific vehicle models.

9. History

This module can record and establish the file of the diagnosed vehicles, including all diagnostic-related data such as diagnostic reports, data stream records, and screenshots.

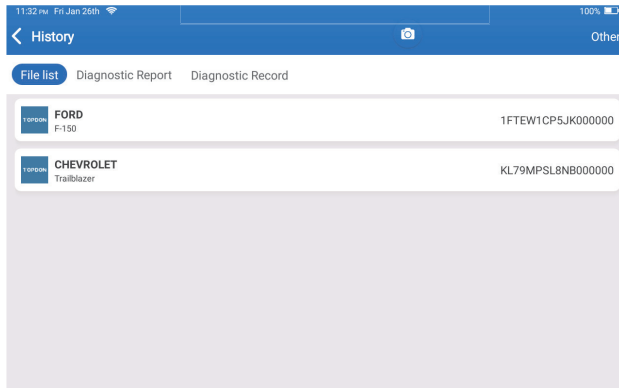

10. Feedback

You can send the last 20 test records to us by using “Feedback” feature for timely technical assistance if you encounter any unsolved problems in the diagnostic process. Tap “Feedback” on the Home Menu. The following page will appear:

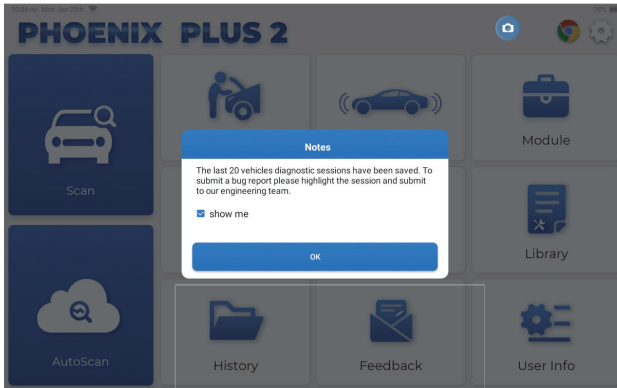

Tap “OK” to enter the vehicle diagnostic feedback selection menu.

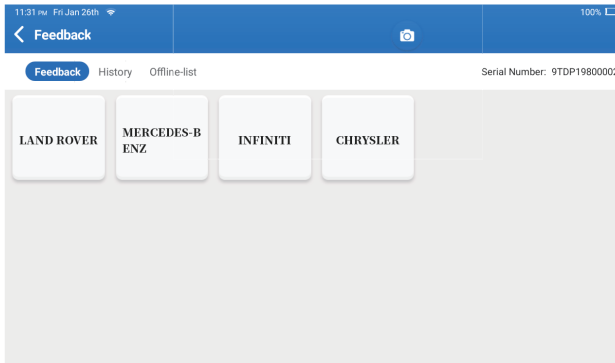

*Explanation of terms:

- Feedback: To show the tested vehicle model list.
- History: To view all diagnostic feedback and check the processes.
- Offline-list: To display all diagnostic feedback logs which have not been submitted successfully yet due to the network failure. The failed logs will be re-uploaded automatically once the tablet gets the stable network signal.

Our technical support will handle your feedback in time for your satisfaction.

11. User Info

You can modify or add related information in this module, or make settings.

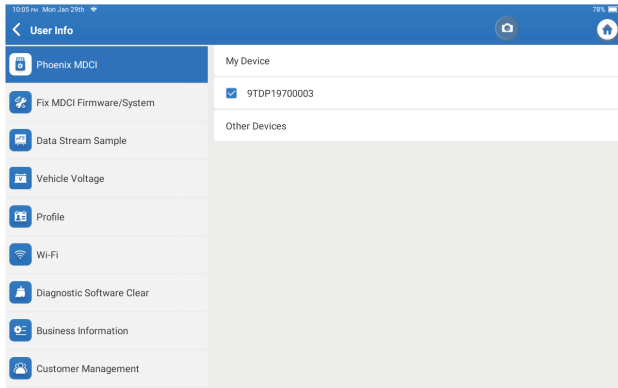

11.1 Phoenix MDCI

This option allows you to choose the suitable MDCI dongle if there are several dongles registered on this tablet.

11.2 Fix MDCI Firmware/System

This option can repair the MDCI firmware. Please don't power off or switch interfaces in the process.

11.3 Data Stream Sample

This option manages the recorded data stream sample files.

11.4 Profile

To set and manage personal information.

11.5 Wi-Fi

This option sets up Wi-Fi networks that can be connected.

11.6 Diagnostic Software Clear

This option can clear some unused diagnostic software and free up the storage space.

11.7 Business Information

This option can add information about the workshop, which will be displayed in the diagnostic report.

11.8 Customer Management

This option manages the information and data of clients.

11.9 Photo Album

This module saves the screenshots.

11.10 Screen Recorder

This module saves the screen recordings.

11.11 Upload Log

When you encounter problems during use, you can use this function to upload APP logs, and we will help you solve the problem.

11.12 Settings

This option makes settings including Units, Time System, Diagnostic Software Auto Update, Language, Time Zone, Renewals, Clear Cache, USB Connection Mode, and Restore Factory Settings.

Technical Specification

Operating System: Android 10.0

Screen: 10" Touchable; 1280 * 800

Memory: 4G

Storage: 64G

Battery Capacity: 12600 mAh/3.8 V

Camera: Rear 8.0MP

Network: Wi-Fi, WLAN 802.11b/g/n

Bluetooth: Bluetooth 5.0

Working Temperature: 32°F~122°F (0°C~50°C)

Storage Temperature: -4°F~140°F (-20°C~60°C)

Dimensions: 10.92*7.51*1.75 inches (277.3*190.8*44.5 mm)

Weight: 54.85 oz (1555g)

Warnings

- ✔ Always perform automotive testing in a safe environment.
- ✔ DO NOT smoke near the vehicle during testing.
- ✔ DO NOT place the diagnostic tool near the engine or exhaust pipe to avoid damage from high temperatures.
- ✔ DO NOT wear loose clothing or jewelry when working on an engine.
- ✔ DO NOT connect or disconnect any test equipment while the ignition is on or the engine is running.
- ✔ DO NOT disassemble the Phoenix Plus 2.
- ✔ Engine parts will become hot when the engine is running. To prevent severe burns, avoid contact with hot engine parts.
- ✔ When an engine is running, it produces carbon monoxide, a toxic and poisonous gas. Operate the vehicle ONLY in a well-ventilated area.
- ✔ Wear safety eye protection that meets ANSI standards.

Cautions

- ✔ Please ensure that the vehicle battery is fully charged and the scanner is firmly connected to the vehicle DLC to avoid erroneous data generated by the scanner and diagnostic systems.
- ✔ Please do not use the diagnostic tool during driving.
- ✔ Keep clothing, hair, hands, tools, test equipment, etc. away from all moving or hot engine parts.
- ✔ Keep the scanner dry, clean, free from oil/water, or grease. Use a mild detergent on a clean cloth to clean the outside of the scan tool, when necessary.
- ✔ Keep the scanner out of the reach of children.

FAQ

Q: The tablet cannot be turned on after being fully charged.

A:

Possible Cause	Solution
The tablet has been standby for too long, and the battery drains.	Charge it for over 2 hours before turning it on.
Problem of the Charger.	Please contact the dealer or TOPDON after-sale service for timely support.

Q: Why cannot register?

A:

Possible Cause	Solution
The tablet isn't connected to a network.	Make sure the network is stable.
There is no verification code in the email box.	Check if the email address is valid and resent the code.
Server problem.	Server maintenance. Please try again later.

Q: There is no power in the MDCI dongle after connecting to the vehicle's DLC port.

A:

Possible Cause	Solution
Poor contact of the MDCI dongle.	Plug out the MDCI dongle, and then plug it in again.
Poor contact of vehicle's DLC port.	Plug out the MDCI dongle, and then plug it in again.
Too low voltage of the vehicle battery.	<ul style="list-style-type: none">• Recharge the vehicle battery.• Replace the vehicle battery if it is damaged.
Fuse blown.	Check the fuse of the OBD module.

Q: The tablet cannot establish a connection with the MDCI dongle.

A:

Possible Cause	Solution
Poor contact of the MDCI dongle.	<ul style="list-style-type: none"> • Plug out the MDCI dongle, and then plug it in again. • Perform the MDCI Bluetooth pairing again.
The firmware is damaged.	Enter the User Info and tap "Fix MDCI Firmware/System" to fix the firmware.

Q: Can I use other chargers to charge the tablet?

A: No, please use the original charger provided by TOPDON.

Any damage and economic loss caused by using the improper battery charger will not be our responsibility.

Q: How to save the battery power?

A: Please switch off the screen while the tablet is idle, or set a short standby time, or reduce the brightness of the screen.

Q: Are there non-standard OBDII adapters in the box?

A: Yes.

Q: Communication error with vehicle ECU?

A: Please confirm the following cases:

- Whether the diagnostic MDCI dongle is correctly connected.
- Whether the ignition switch is ON.

Or, send your vehicle's year, make, model, and VIN data to us via the "Feedback" feature for timely technical assistance.

Q: Failed to get access to the vehicle's ECU system?

A: Please confirm the following cases:

- Whether the system is available in the vehicle.
- Whether the MDCI dongle is correctly connected.
- Whether the ignition switch is ON.

Q: The MDCI dongle is missing.

A: Please contact the dealer or TOPDON after-sale service for timely support.

Q: Error of the diagnostic software.

A: Please operate as follows:

- Tap "Feedback" to send specific problems to us for technical support.
- Tap the vehicle software icon, and hold it to uninstall the corresponding software, and then enter the upgrade center to download and install the new version.

Q: The downloaded diagnostic software is inconsistent with the serial number.

A: Selected the wrong MDCI dongle.

Enter the "User Info" -> "Phoenix MDCI" -> select the right MDCI dongle.

WARRANTY

TOPDON's One Year Limited Warranty

TOPDON warrants to its original purchaser that the company's products will be free from defects in material and workmanship for 12 months from the date of purchase (Warranty Period).

For the defects reported during the Warranty Period, TOPDON will either repair or replace the defective part or product according to its technical support analysis and confirmation.

TOPDON shall not be liable for any incidental or consequential damages arising from the device's use, misuse, or mounting.

If there is any conflict between the TOPDON warranty policy and local laws, the local laws shall prevail.

This limited warranty is void under the following conditions:

- Misused, disassembled, altered or repaired by unauthorized stores or technicians.
- Careless handling and operation's violation.

Notice: All information in this manual is based on the latest information available at the time of publication and no warranty can be made for its accuracy or completeness. TOPDON reserves the right to make changes at any time without notice.

FCC Statement

Any changes or modifications not expressly approved by the party responsible for compliance could void the user's authority to operate the equipment.

This device complies with Part 15 of the FCC Rules. Operation is subject to the following two conditions:

- (1) this device may not cause harmful interference, and
- (2) this device must accept any interference received, including interference that may cause undesired operation.

Note: This equipment has been tested and found to comply with the limits for a Class B digital device, pursuant to Part 15 of the FCC Rules. These limits are designed to provide reasonable protection against harmful interference in a residential installation. This equipment generates, uses, and can radiate radio frequency energy, and if not installed and used in accordance with the instructions, may cause harmful interference to radio communications. However, there is no guarantee that interference will not occur in a particular installation. If this equipment does cause harmful interference to radio or television reception, which can be determined by turning the equipment off and on, the user is encouraged to try to correct the interference by one or more of the following measures:

- Reorient or relocate the receiving antenna.
- Increase the separation between the equipment and receiver.
- Connect the equipment into an outlet on a circuit different from that to which the receiver is connected.
- Consult the dealer or an experienced radio/TV technician for help.

SAR compliance is based on a separation distance of 0 mm between the unit and the body of the user.