

Robotic Vacuum Cleaner

User Manual

L200PRO

FCC-ID: 2AVYJ-L100

Read this user manual carefully before using this product and save it properly for further reference.

Important Safety Instructions

WARNING: TO REDUCE THE RISK OF INJURY OR DAMAGE, READ THE FOLLOWING SAFETY PRECAUTIONS WHEN SETTING UP, USING AND MAINTAINING YOUR ROBOT.

Cautions

- This product is designed for indoor floor cleaning only, do not use it outdoors (such as on an open-ended terrace), on any surface other than the ground (such as a sofa), or in any commercial or industrial environment.
- Do not use this product on elevated surfaces without barriers such as the floor of a loft, an open-ended terrace, or on top of furniture.
- Do not use the product when the ambient temperature is higher than 104°F (40°C) , lower than 39°F (4°C), or if there are liquids or tacky substances on the floor.
- Before using the product, move wires off the ground or place them to the side to prevent them being pulled on by the cleaner.
- To prevent blocking the product and to avoid damage to valuables, remove light-weight items (such as plastic bags) and fragile objects (such as vases) from the floor before cleaning.
- Children should be supervised to ensure that they do not play with the appliance.
- This product is not intended for use by persons (including children) with reduced physical, sensory or mental capabilities, or lack of experience and knowledge, unless they have been given supervision or instruction concerning use of the product by a person responsible for their safety .
- This product can be used by children aged from 8 years and above and persons with reduced physical, sensory or mental capabilities or lack of experience and knowledge if they have been given supervision or instruction concerning use of the product in a safe way and understand the hazards involved. Children shall not play with the product. Cleaning and user maintenance shall not be made by children without supervision (EU).

Important Safety Instructions

Cautions

- Keep the main brush cleaning tools out of reach of children.
- Do not place any object (including children and pets) on the product, whether it is in operation or not.
- Keep hair, loose clothing, fingers, and all parts of the body away from openings and moving parts.
- Do not use the product on burning objects (such as cigarette butts).
- Do not use the product on high pile carpets (product effectiveness may also be reduced on dark carpets).
- Do not use the product to clean hard or sharp objects (such as decoration wastes, glass and nails).
- Do not carry the product by using the main unit cover, or collision buffer.
- The product must be switched off and the plug must be removed from socket-outlet before cleaning or maintaining the product.
- Do not use wet cloth or liquids for cleaning the product.
- Do not use the mopping module on carpets.
- Use the product according to the manual, Any loss or damage caused from improper use will be borne by the user.
- This product contains batteries that are only replaceable by skilled persons.

Important Safety Instructions

Battery and Charging

- Do not charge non-rechargeable batteries.
- For the purposes of recharging the battery, only use the detachable supply unit robot provided with this product.
- Do not dismantle, repair or modify the battery or charging dock.
- Keep the charging dock away from heat (such as heating vents).
- The battery must be removed from the appliance before it is scrapped.
- The product must be disconnected from the power supply when removing the battery.
- The battery must be disposed of safely. Do not discard waste batteries, leave them with a professional recycling organization.
- Do not wipe or clean the charger prongs with wet cloth or wet hands.
- If the power cord is damaged, stop using it immediately. It must be replaced by the manufacturer, service agent, or similarly qualified persons to avoid a hazard.

FCC STATEMENT

1. This device complies with Part 15 of the FCC Rules. Operation is subject to the following two conditions:
 - (1) This device may not cause harmful interference, and
 - (2) This device must accept any interference received, including interference that may cause undesired operation.
2. Changes or modifications not expressly approved by the party responsible for compliance could void the user's authority to operate the equipment.

NOTE: This equipment has been tested and found to comply with the limits for a Class B digital device, pursuant to Part 15 of the FCC Rules. These limits are designed to provide reasonable protection against harmful interference in a residential installation.

This equipment generates uses and can radiate radio frequency energy and, if not installed and used in accordance with the instructions, may cause harmful interference to radio communications. However, there is no guarantee that interference will not occur in a particular installation. If this equipment does cause harmful interference to radio or television reception, which can be determined by turning the equipment off and on, the user is encouraged to try to correct the interference by one or more of the following measures:

Reorient or relocate the receiving antenna.

Increase the separation between the equipment and receiver.

Connect the equipment into an outlet on a circuit different from that to which the receiver is connected.

Consult the dealer or an experienced radio/TV technician for help.

Radiation Exposure Statement

This equipment complies with FCC radiation exposure limits set forth for an uncontrolled environment. This equipment should be installed and operated with minimum distance 20cm between the radiator & your body

Product Introduction

1.Functions

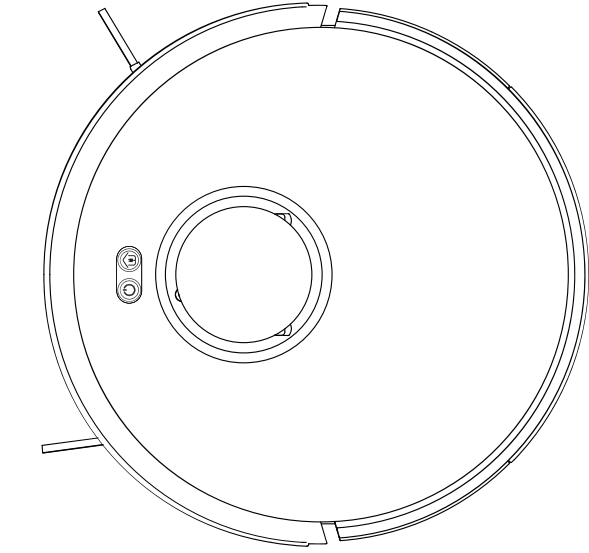

 Cleaning/Pause

 Recharge

Reset WIFI by holding down both buttons for 3 seconds at the same time

Indicator light

Power button red and blue dual color

Recharge button blue
WIFI indicator light blue

2.Dust collection lamp display function

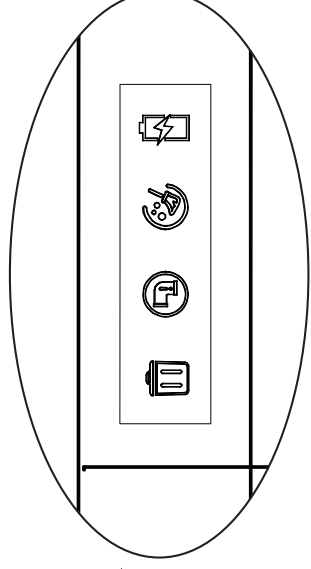
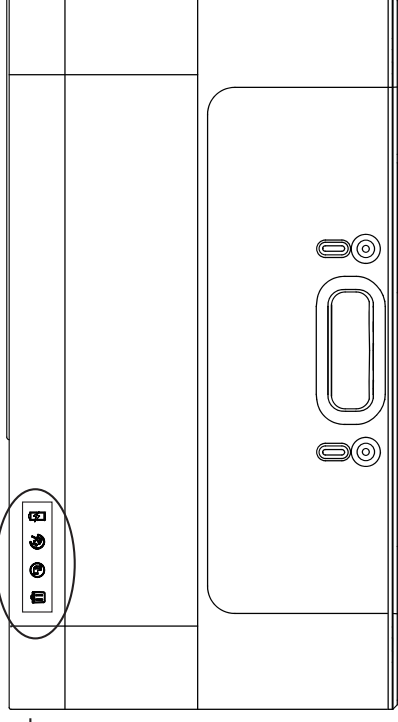

Dust bag installation indicator light
Dust bag not installed, light off
Dust bag installed, light on

Dust collection fault light channel blockage light flashing
normal light off



Dust collection indicator light can collect dust and

Dust collection indicator light
The uncharged light goes out
Lamp breathing during charging
Full charge electric light always on

Product Introduction

3.List of accessories

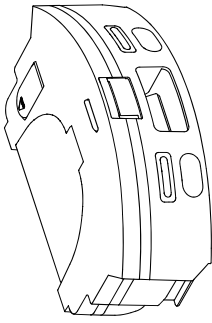

Two in one water pump
water tank X1

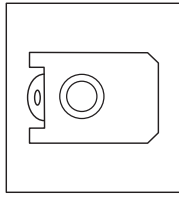

Dust bag X2

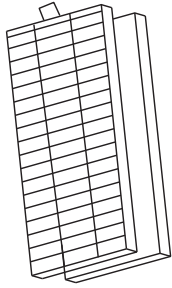

HEPA filter+Sponge
filter X1

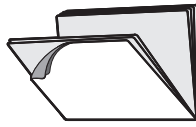

User Manual

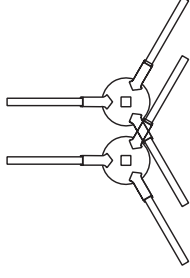

Side brush left X2
Side brush right X2

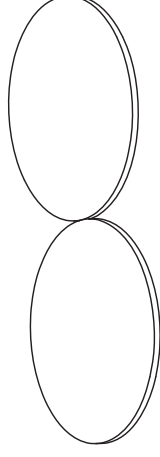

Rotating mop X2



Cleaning brush X1

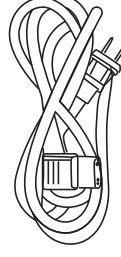

Power cord X1

Product Introduction

4. Robot

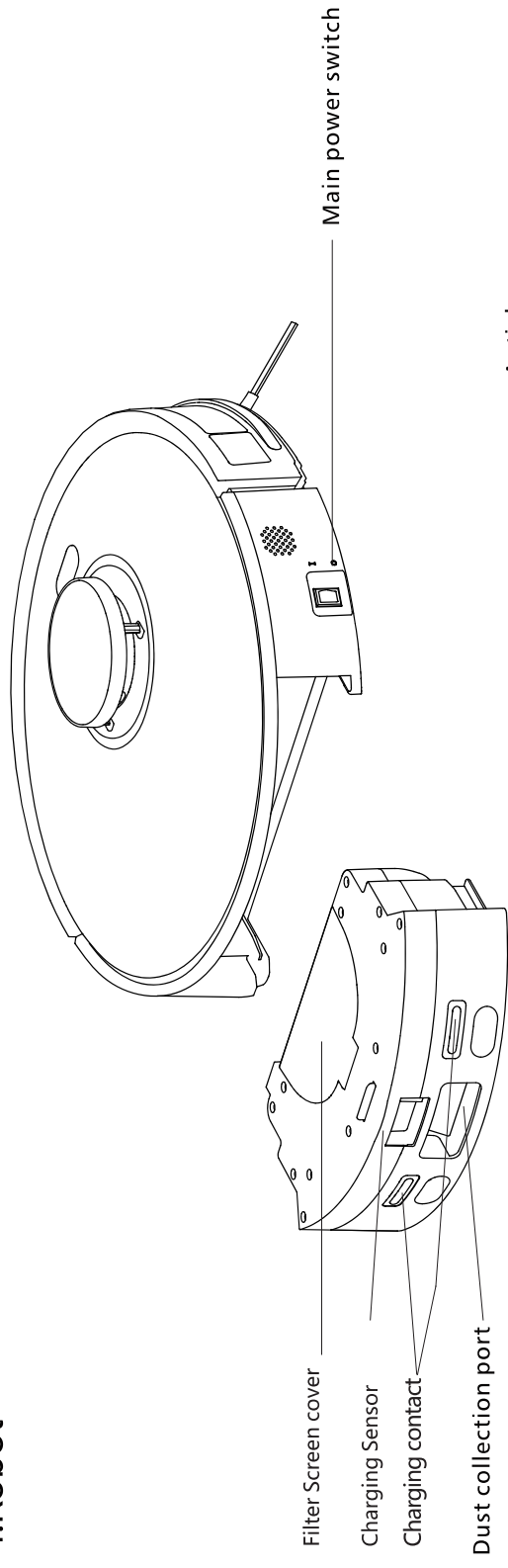

5. Sensor and structure

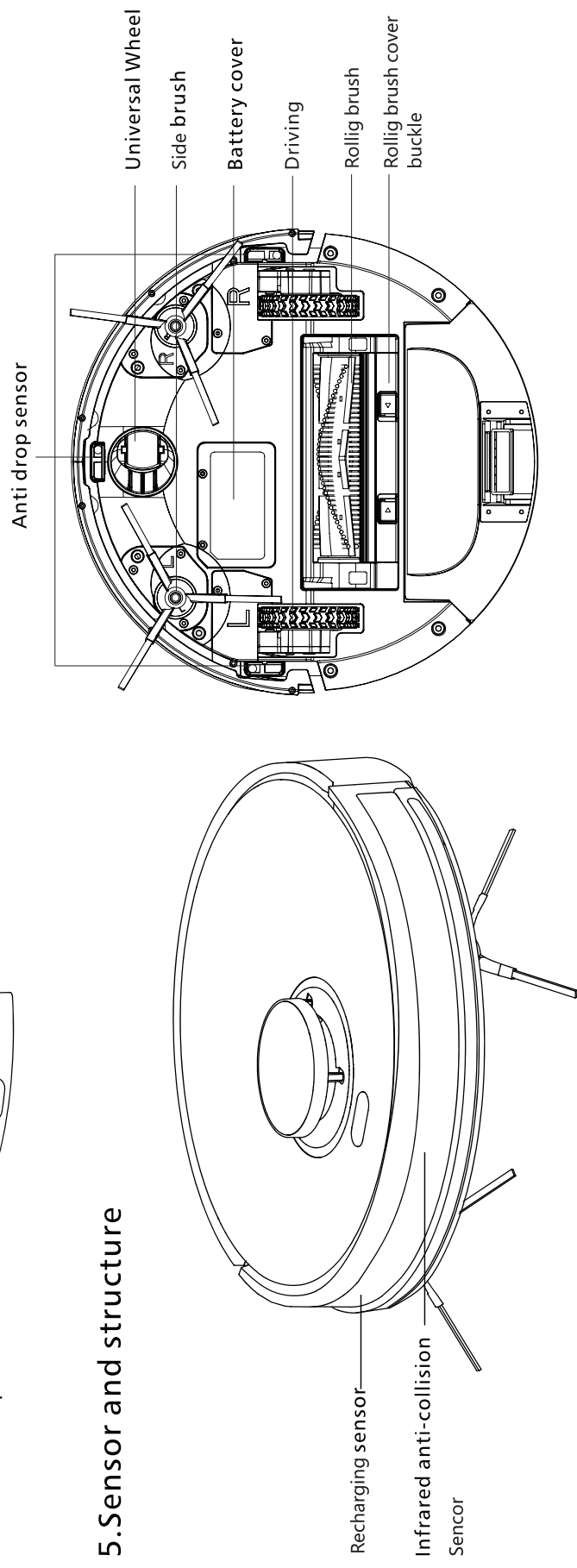

Product Introduction

6. Dust Collector (dust collecting charging in one)

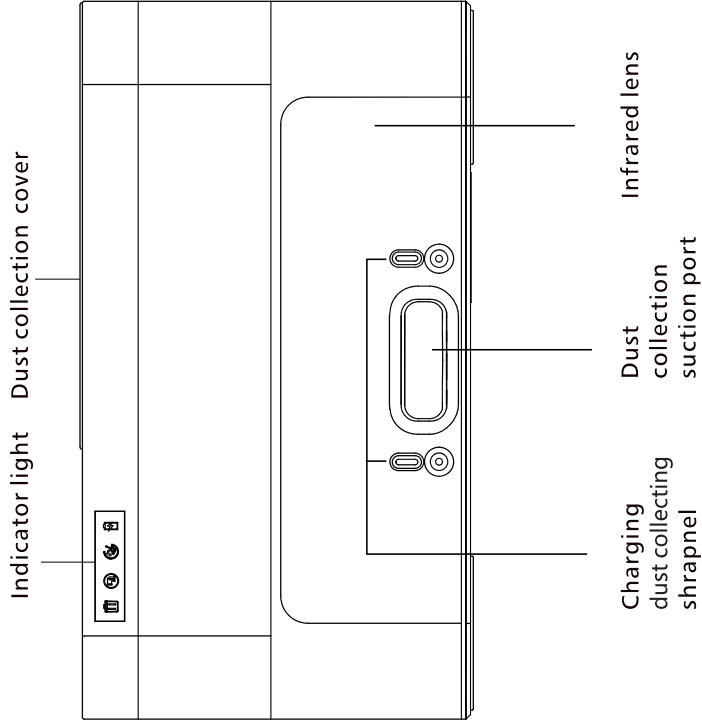

Front of Dust collector

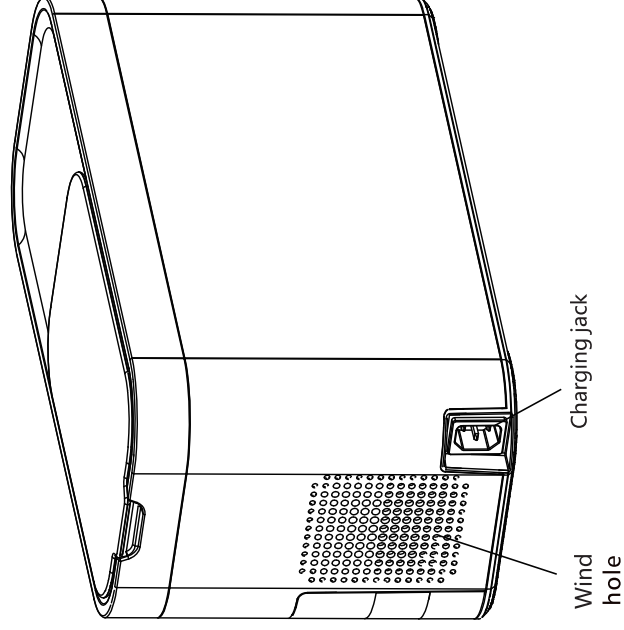

The Side of dust collector

Installation

1. Installation

Correspond the left brush (L) and right brush (R) to the letters L and R on the bottom shell, and press down to hear a "click" sound to indicate that the installation is in place

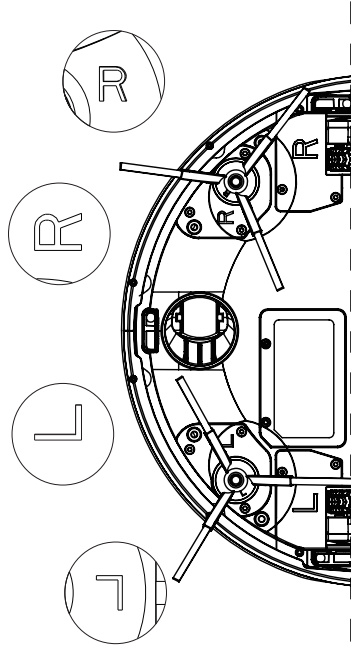

2. Install dust collector

① The dust collection treasure is placed against the wall and on a flat ground.

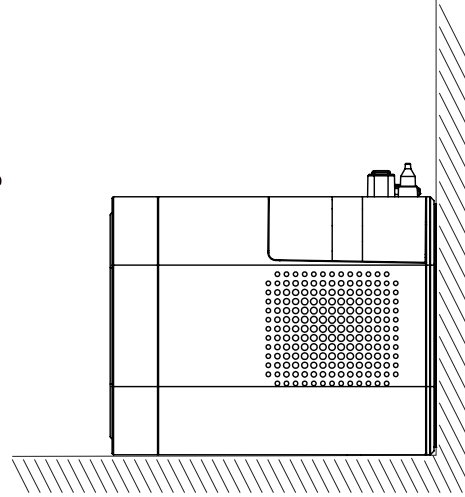

② Ensure a space of 1.5 meters or more in front of the dust collector and 0.5 meters or more on both sides.

① The dust collection treasure is placed against the wall and on flat ground.

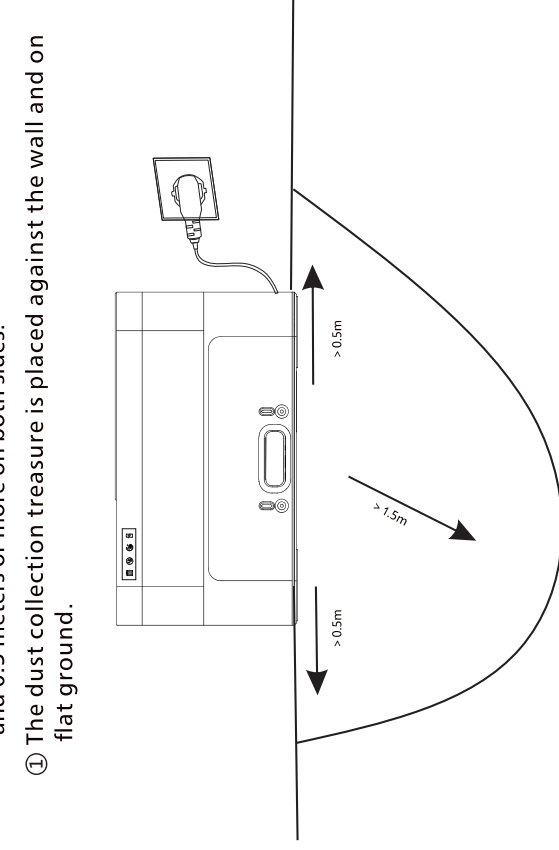

Installation Using the robot

3. Turn the robot over to install the side brushes.

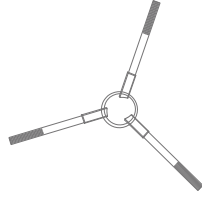
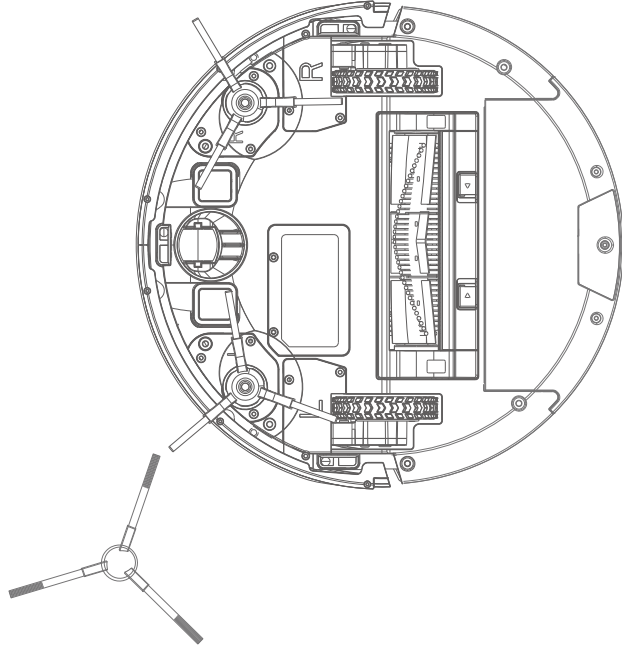

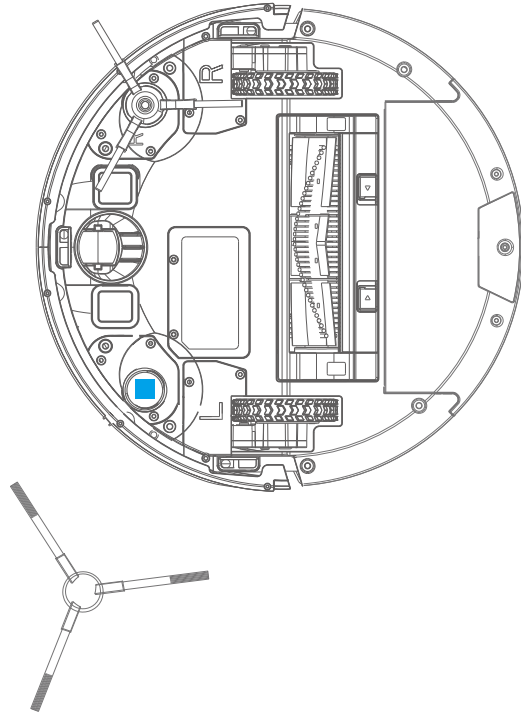

Install the side brushes

Install the side brushes on both sides of the roller at the bottom of the main unit. Pick up the side brushes with your hands and aim at the hole of the side brush installed on the base (note that the square column and the square hole correspond to each other), press it down to hear a "click" sound, indicating that the side brush is installed in place.



Installation Using the robot

Charging

- Auto: After cleaning, the robot will automatically return to the charging dock to recharge. The  button light keeps flashing.
- Manual: In pause mode, press the  button to send the robot back to the charging dock. If the robot is stuck or can not find the charging dock, place the robot directly on the dock to recharge it.
- Recharge by remote control.

Note:

- The battery is fully charged to prolong the battery life. 5 hours charging time for the first time.
- Please keep charging dock power on. Or the robot can not find the charging dock.
- Close the Tuya App to reduce tablet/phone battery consumption when vacuum robot is cleaning.
- The furniture must be at least 98 mm height for the machine to pass through.

1. Power on and charge

- Placing the robot on to the charging dock and power on. Turning on the robot is defaulted.
- The robot will turn on when turn on main power switch if the robot not connected the charging dock. The power indicator lights up.
- Turn off main power switch to turn off the robot if the robot is not not onto the charging dock.

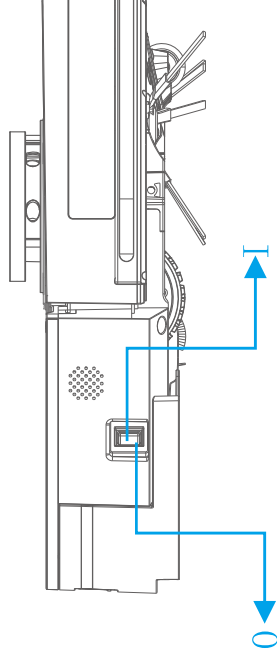

2. Pause

When the robot is cleaning, press  button to pause it. Then press  the button to continue cleaning or the  button to stop the current cleaning. Press  button twice to return it to the charging dock.

3. Sleep

If the robot is paused and not connect the charging dock for over 10 minutes, it will go to sleep, press any button to wake it back up.

Installation for use

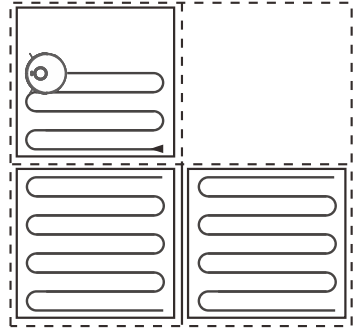

Start cleanup

Press the  button to start cleaning. Once started, the robot leaves charging dock. The robot will plan its cleaning route based on its scan of the area. It cleans along a zone first and then move Zig - zag cleaning route to cover the internal area efficiently and thoroughly.

Note:

- Cleaning cannot start if the battery level is too low. Allow the robot to charge before restarting cleanup.
- Tidy away any cables on the ground (including the power cable of the charging dock) before cleaning to avoid losing power or damaging either the robot or the connected device.

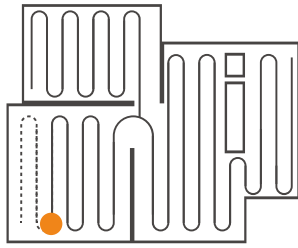

A. Cleaning mode

Press the  button to start cleaning. Once started, the robot will plan its cleaning route and map based on its scan of the area After cleaning, the robot will return to the charging dock automatically..

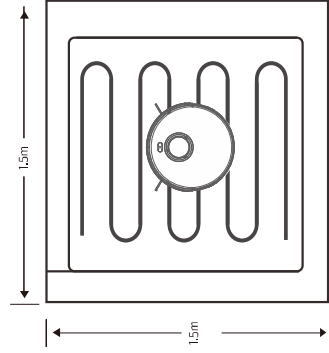

B. Spot Cleaning (Only remote control support)

After starting the spot cleaning mode, this mode is used to clean a 1.5m x 1.5m square area centered and it is in zig-zag cleaning mode on the map. After cleanup, the robot will return to the center of the square. Use the app to set a destination for the robot to go to.

Installation for use

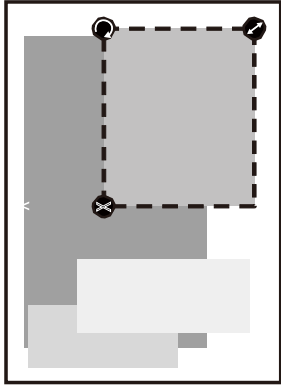

C. Zone Cleaning (Only App operation support)

Use the app to draw a specific zone for the robot to clean. Then, the robot will only clean the designated zone. After cleaning, the robot will return to the charging dock automatically.

D. Selective Room Cleaning (Only App operation support)

Select specific rooms for cleaning in the app. In this mode, the robot will only clean the selected rooms. After cleaning, the robot will return to the charging dock automatically.

Note:

- A full map must be created before this function can be used.
- After cleaning starts, the robot may move beyond the defined areas. Make sure there are no obstacles preventing the robot's access to the target rooms.

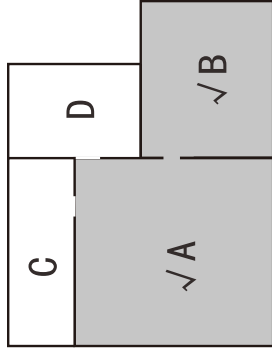

E. Virtual Wall (Only App operation support)

press virtual wall in APP to draw the virtual wall line. You can use virtual wall to isolate the areas that do not want to be cleaned.

Note:

- Dry vacuum module can be used on either smooth or carpeted surface.
- Remove / secure all loose floor mats / rugs in the area being vacuumed.
- Vacuum robot is designed to move across surface between 0 mm to 15 mm

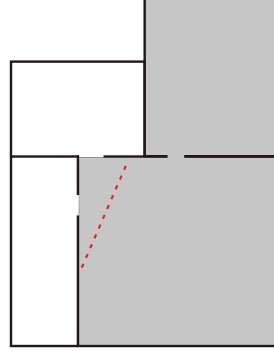

Installation Using the robot

6. Water tank

1. Install the mop cloth.

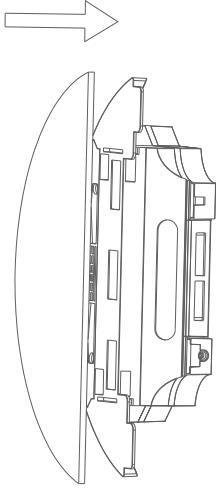

2. Open the water tank, fill it with water, and close it tightly

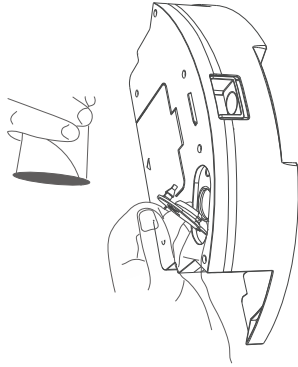

3. Install water tank.

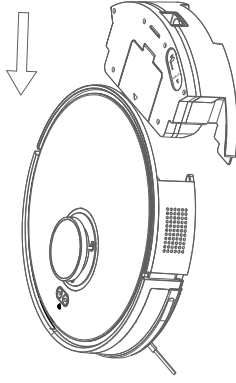

4. Start mopping.

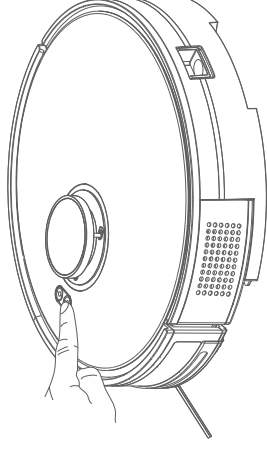

Note:

After finishing mopping, Please empty the water tank. Take off the mop and clean it.

Note:

- It is recommended that all floors are vacuumed at least three times before the first mopping session to reduce excessive dirt buildup on the mop.
- To prevent corrosion or damage, do not use cleaning fluid or disinfection in the water tank.
- Remove the mopping module after mopping, empty residual water and clean the mop cloth to prevent mildew or unpleasant odors.
- Remove the mopping module if not mopping.
- Mop module is designed only to be used on smooth flooring as the pad may catch on carpeting and prevent the vacuum unit from moving freely.

App Instruction

As the Tuya App is continuously being updated, your App may appear slightly different than what is pictured in this User Guide. App needs to be used in the networked state and please connect to the home network first. Make sure the network is normal.

Download 1. Scan the QR code and download "Tuya Smart APP". For IOS model phones, search for "Tuya Smart" in the APP store to download;

For Android model phones, search for Tuya Smart in the app store to download.



Tuya Smart

★★★★★ 4.9/3.0



Sign up:

New users enter the registration page by clicking create new account. Use an unregistered mobile phone number/email, and set a login password by obtaining a verification code. After registration, you can log in to use.

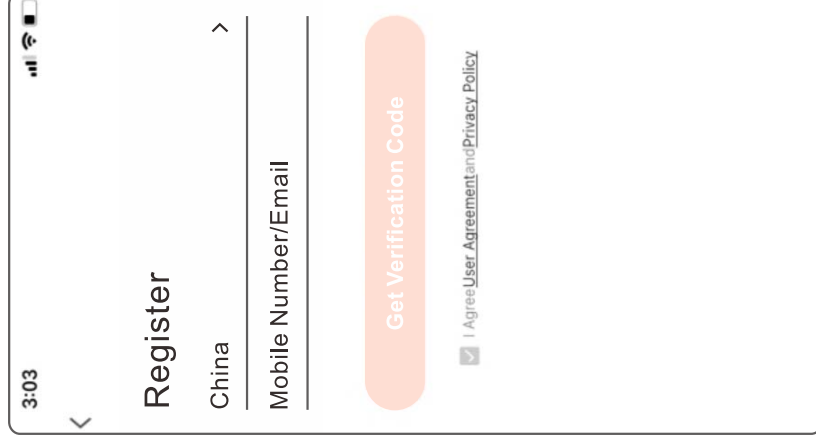

App Instruction

Log in:

If you have an account, enter your account and password in the APP login interface to log in. If you forget the password, click Forgot Password, enter the registered mobile phone number/ email, and obtain the verification code to log in to the account.

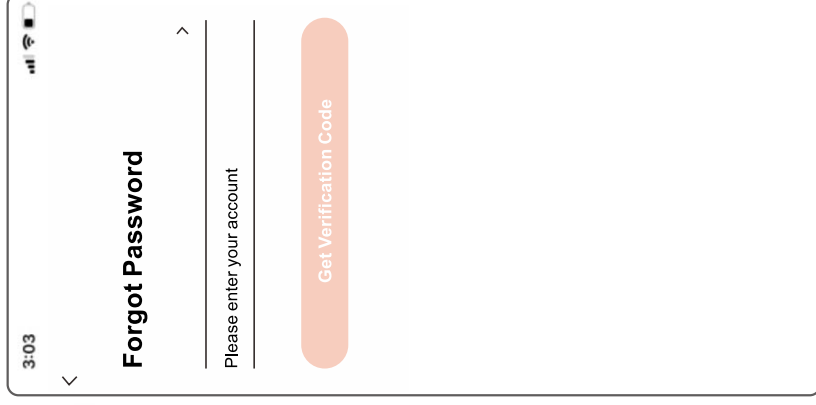
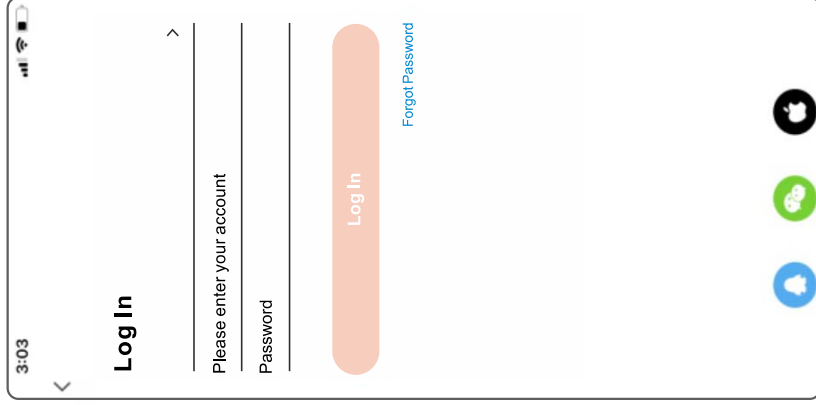

Add device:

1. After login, click Add Device;
2. Click "Small Appliances" and then "robot vacuum cleaners".

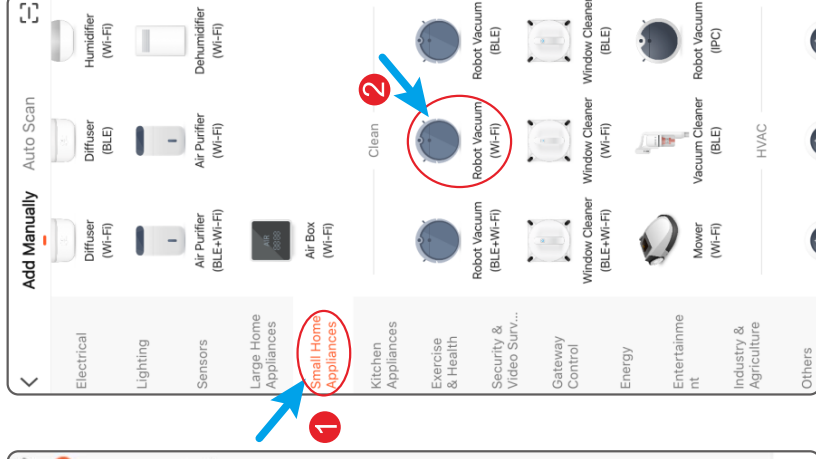
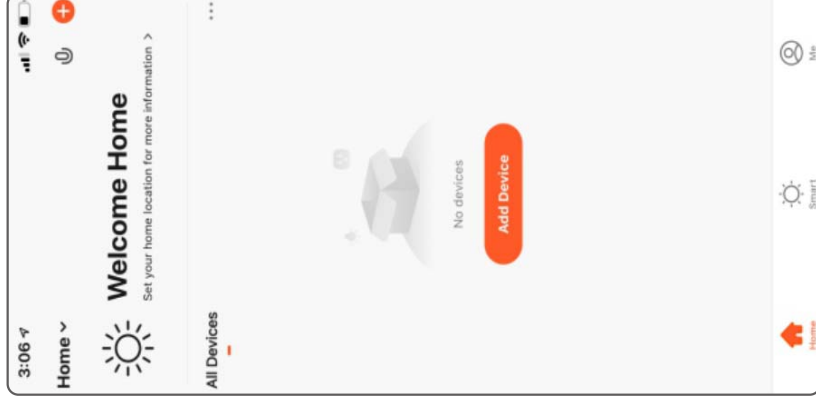

App Instruction

3. Press the  pause button for 2-3 seconds for the first time to start the smart network connection until there is a voice prompt. (WiFi indicator light flashes quickly);

4. Check "Confirm that the indicator light is flashing fast" and click Next.

5. Show that the robot vacuum cleaner is being added.

6. Click Finish after adding successfully.

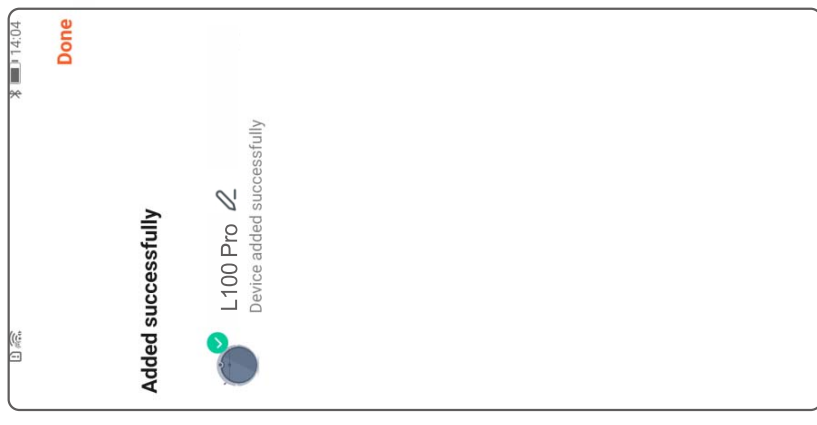
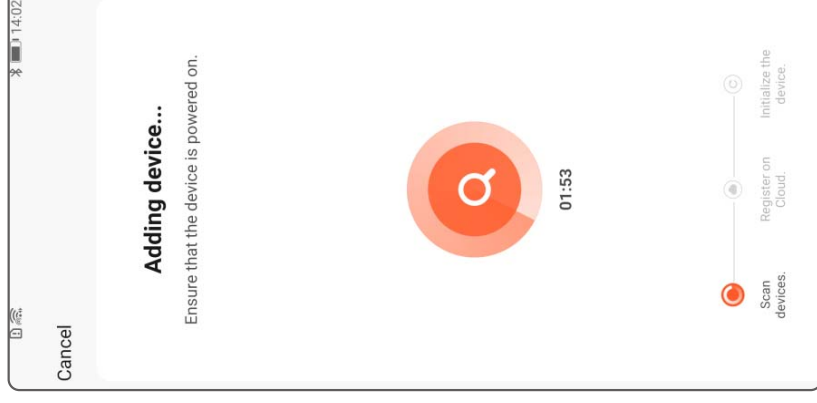
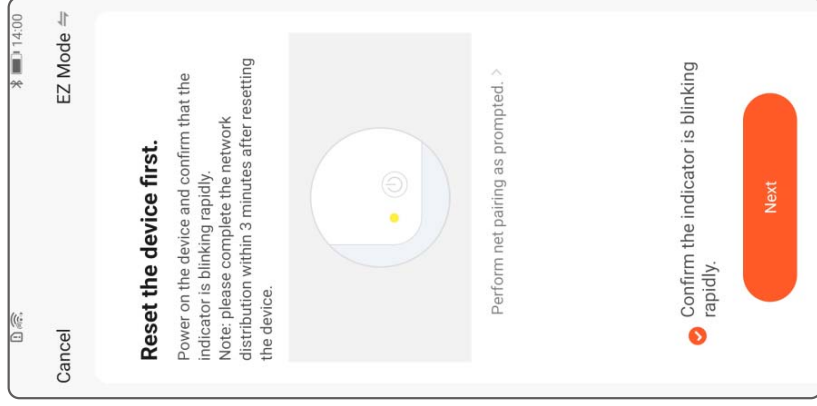
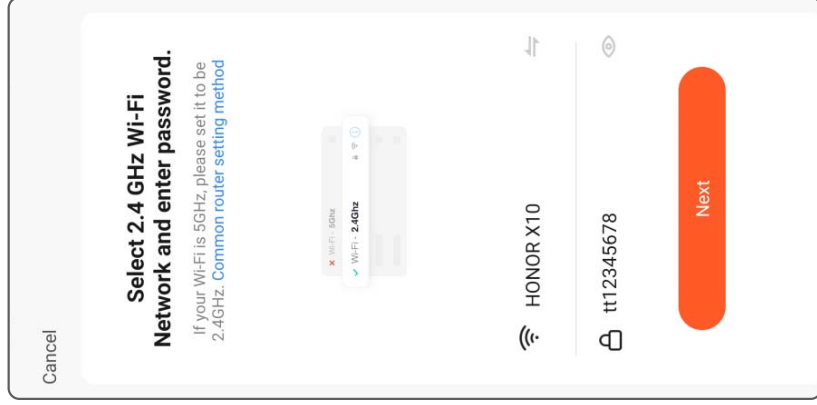

App Instruction

7. Hotspot AP network connection: Press the  pause button for 2-3 seconds for the second time to start the hotspot network connection until there is a voice prompt.(WiFi indicator light flashes slowly).

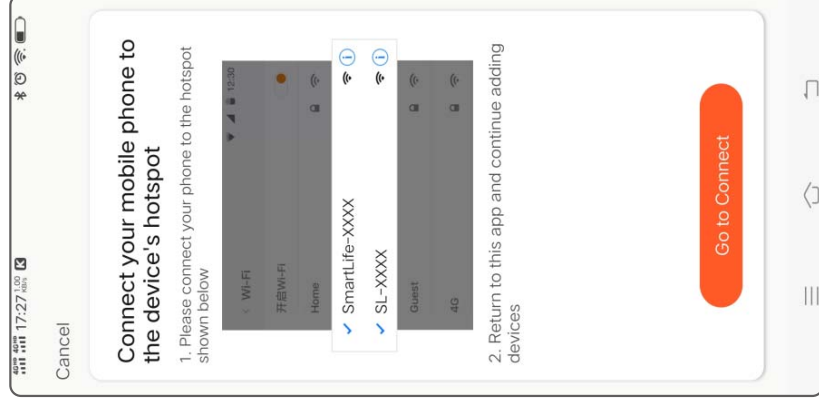
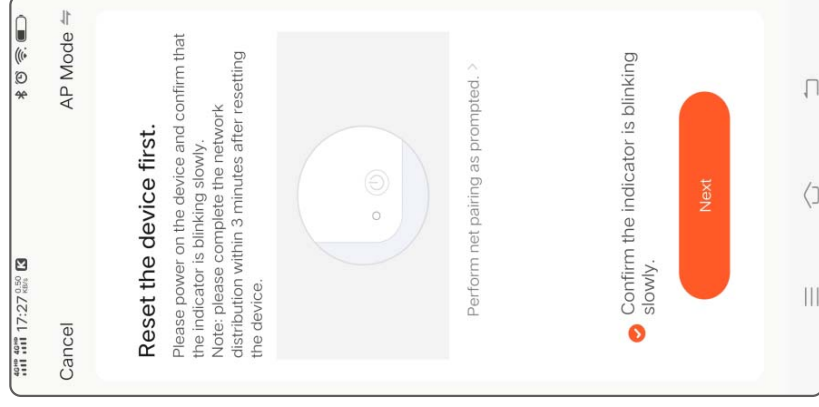
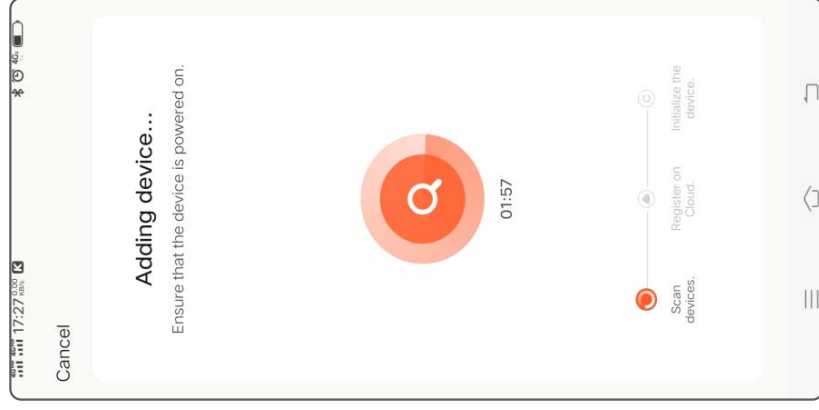
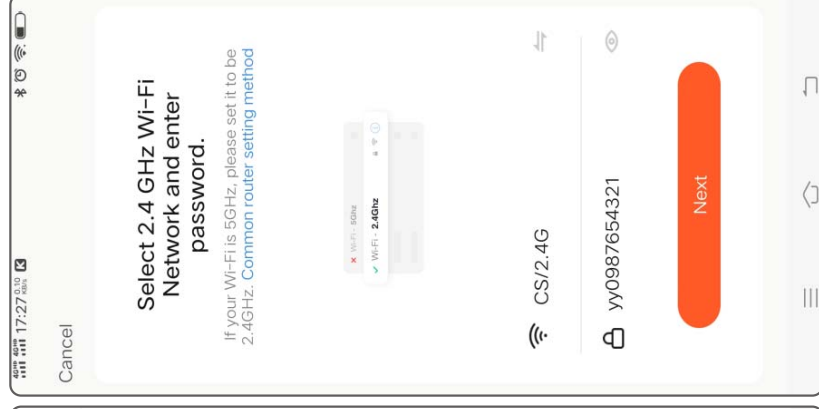
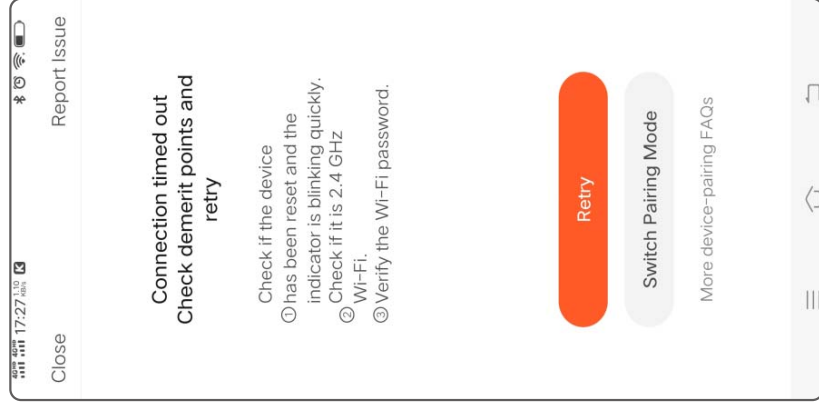

App Instruction

App interface

1. Cleaning modes "Smart Cleaning", "Designated Area Cleaning".
Note: Change the cleaning mode, the current cleaning mode must be ended first.

2. Recharging: when the robot is in standby mode or auto cleaning mode, if you press the recharging button, and the robot will look for the charging dock for recharging.

Setting

Click "Setting" on the home page to enter more pages.
and click to enter the corresponding function.

1. Manual control: control the direction button / pause button / start cleaning.
2. Room Manage: Reset or Save the map.
3. Click "seek robot" : the robot will voice prompt "I am here" .

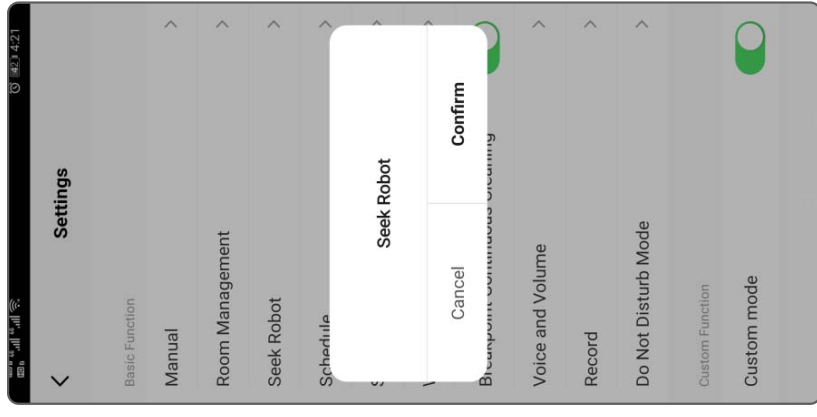
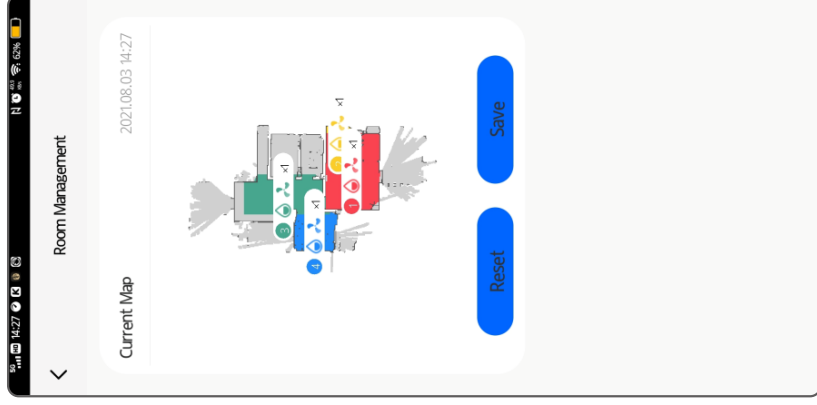
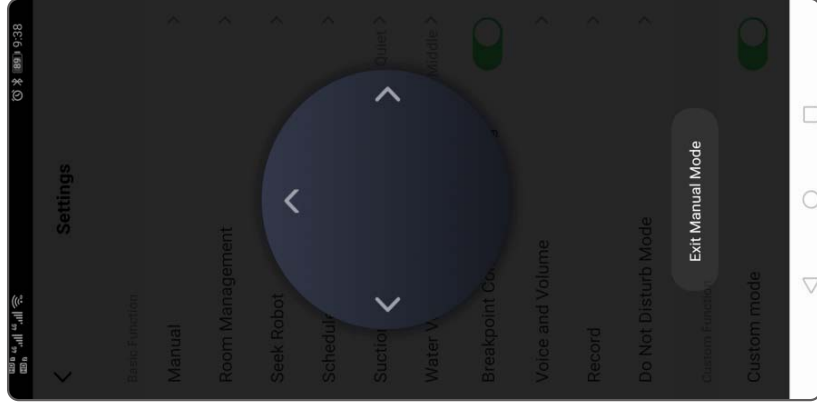
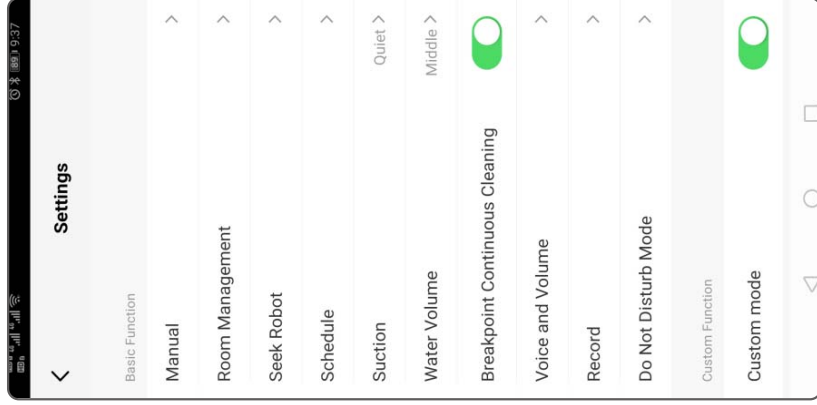
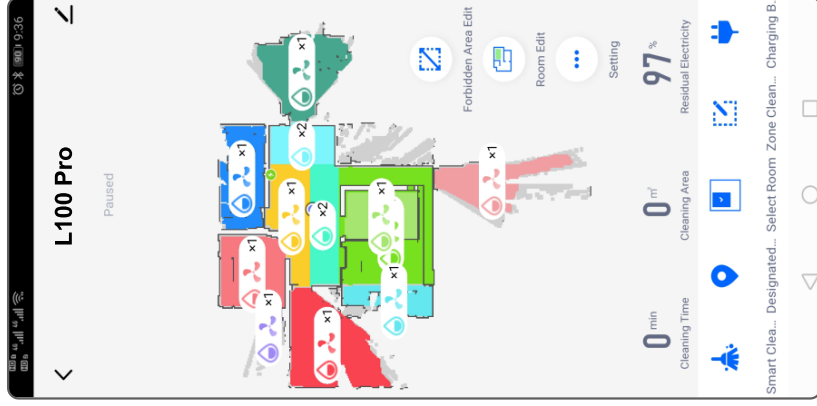

App Instruction

4. Use the app to set start times for scheduled cleanups.
Select scheduled cleaning and save the scheduled cleaning time

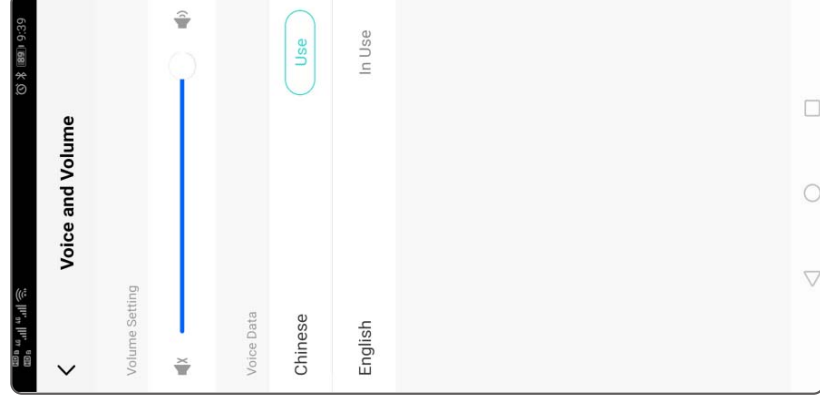
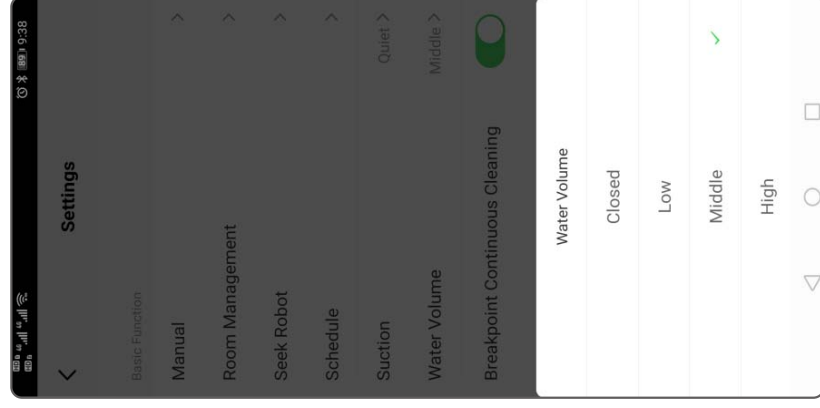
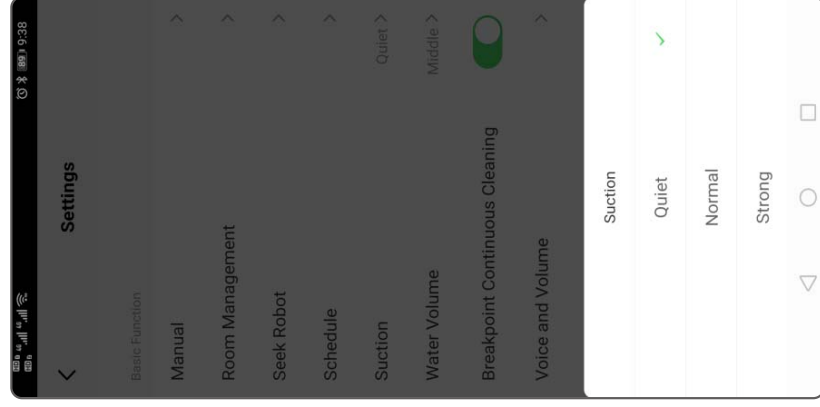
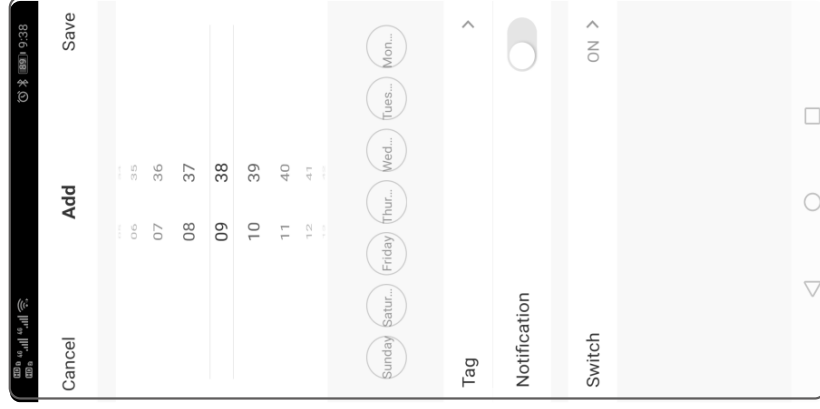

5. Suction power: Quiet, Normal, Strong.
6. Water quantity: Low, Middle, High.
7. Can adjust voice volume and switch language.

App Instruction

Setting

1. Click the upper right corner on the main control page to enter the robot settings page. And click to enter the corresponding function.

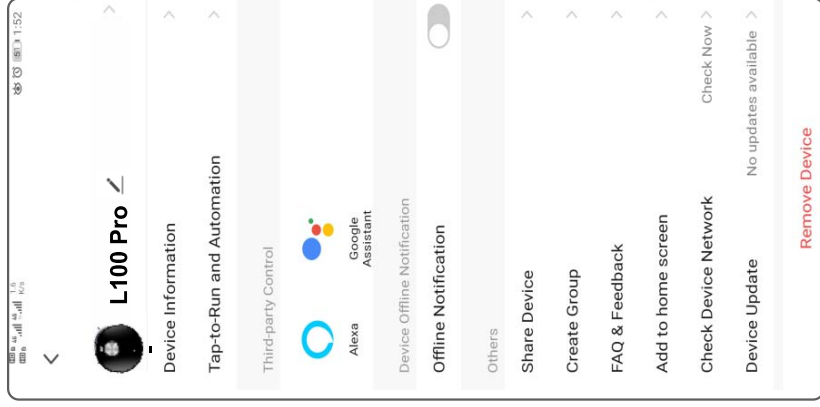

2. Adding share: Enter the robot account to be shared.
3. Remove device: Click "Remove device" to remove the bound device from this account

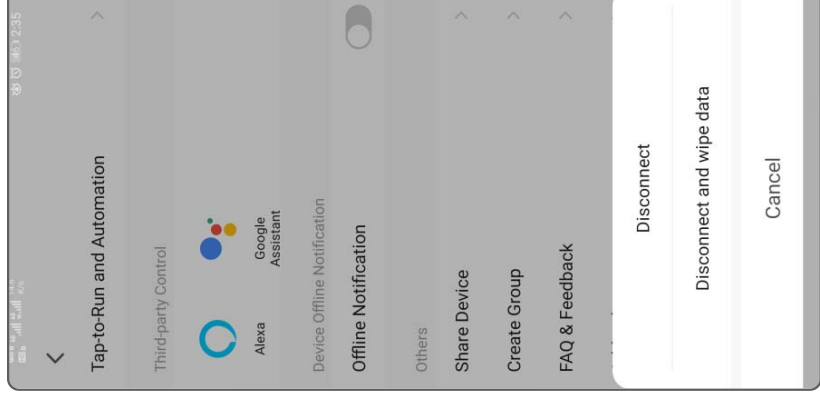
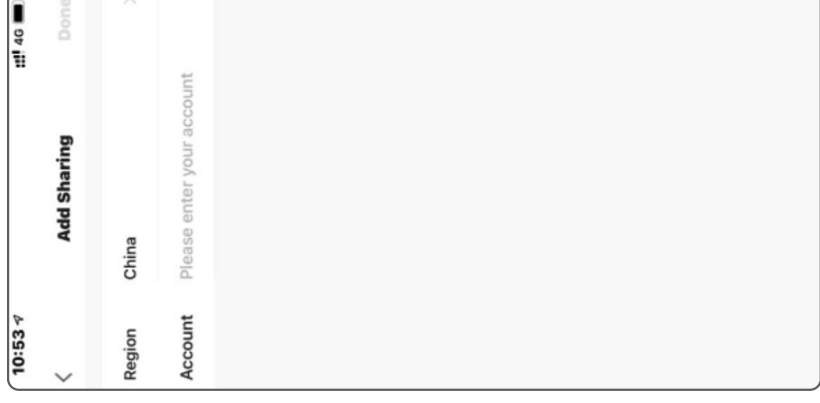

Reset WiFi

If your phone cannot connect to the robot because you have changed your router configuration, forgotten your password, or any other reason, press and hold  power button until you hear the "Resetting WiFi" voice alert.

Note:

- Before setting up Wi-Fi, please make sure that the robot and Wi-Fi network meet the following requirements.
Wi-Fi setup requirements.
- The robot is fully charged.
- The Wi-Fi status indicator flashes slowly in white.

Wi-Fi network:

- Use the correct wireless network password.
- Do not use VPN (Virtual Private Network) or proxy serve.
- The Wi-Fi router supports 802.11b/g/n and Ipv 4 protocols.
- The router frequency band is 2.4 GHz or dual -frequency router that supports the 2.4 GHz frequency band.
The robot does not support the 5 GHz frequency band.
- If the robot is unable to connect in the 2.4/5GHz dual-band Wi-Fi network, please switch to the 2.4 GHz network for Wi-Fi settings. After the setting is complete, you can switch back.
- When connecting to a hidden network, please make sure to enter the correct network name---SSID (case sensitive) and connect to a 2.4 GHz wireless network.
- When using a wireless extender/repeater, please make sure that the network name (SSID) and password are the same as the main network.
- Set the firewall and port of the Wi-Fi router to allow the robot to connect to the App server.

Network security requirements:

- Use TKIP, PSK, AES/ CCMP encrypted WPA and WPA 2 network.

Map management

A. Real-time creating room map

Real-time drawing room map can help you easily understand the cleaning path and environment, After cleaning, a floor map of the room will be generated, The map will be updated in real time during each cleaning to ensure normal navigation.

Create a complete floor map of the room:

- a. Open the door so that the robot can generate a map for each room.
- b. Remove any objects that may block or stuck the robot.
- c. After creating the map, please do not disassemble or move the charging dock.

B. Repositioning and recreating the map

When the robot / charging dock is adjusted or the surrounding environment changes significantly. The robot will try to relocate and may regenerate a new map to match the surrounding environment.

- a. If the relocation is successful, the robot will resume cleaning.
- b. If the relocation fails, the robot will regenerate the map to ensure normal navigation for the new cleaning.
- c. If the relocation fails and the original map has virtual boundary information (forbidden area).
the robot will not start new cleaning to avoid crossing the restricted area.

Note:

Make sure the robot is cleaned every time from the charging dock.

During cleaning, do not move the robot frequently, if moved, put the robot back to its original position.

Cleaning the Dust bin

- Step 1: Press the dust bin release buckle and take out the dust bin, as shown in Figure 1.
- Step 2: Use one hand to press and hold the release buckle, and the other hand to open the cover to open the dust bin and remove the dust.
- Step 3: Clean the dust bin as shown in Figure 3.
- Step 4: Take out the filters and clean the dust on them.
- Step 5: The dust bin and filters can be cleaned under running water. (Note: The dust bin and filters can only be put back after they are completely dry.)
- Step 6: After cleaning, re-install the filters and close the dust bin cover. Finally, insert the dust bin back into the robot.

Note:

- Please open the dust bin upwards to avoid spilling anything inside.
- For a new robot, clean the dust bin once every three days in the first month. After that, clean it once every week. (It is recommended to replace the filter every 3-6 months to ensure a better cleaning result.)
- Do not place the filter under direct sunlight.

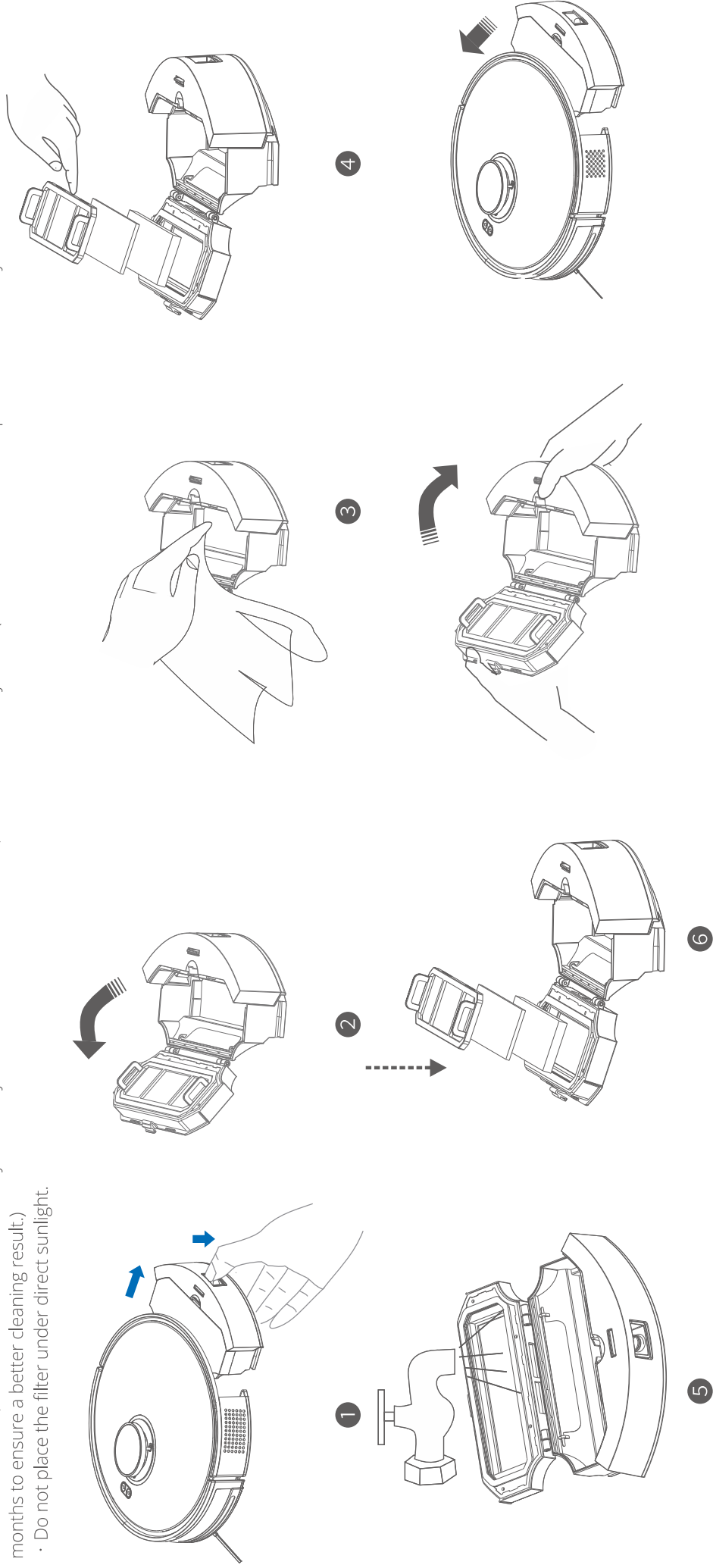

Maintenance

Main brush assembling and cleaning

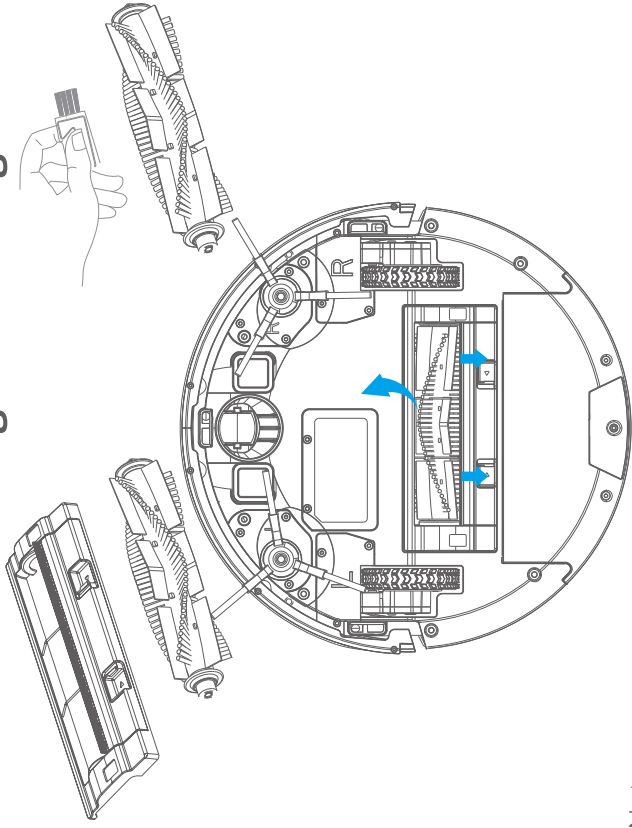

Note:

When replacing main brush after cleaning- make certain it is firmly seated

Primary filter/sponge foam/HEPA filter cleaning

Take out the primary filter/sponge foam/HEPA filter and they can be cleaned under the running water. After cleaning, dry them and re-install them .

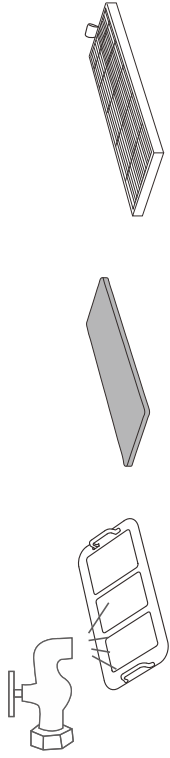

Side brush cleaning

- A. Use a brush cleaning tool to cut off the entangled debris.
- B. Use a clean cloth to clean the side brush.

Note: Side brush replacement every 3-6 months is recommended to maintain cleaning quality.

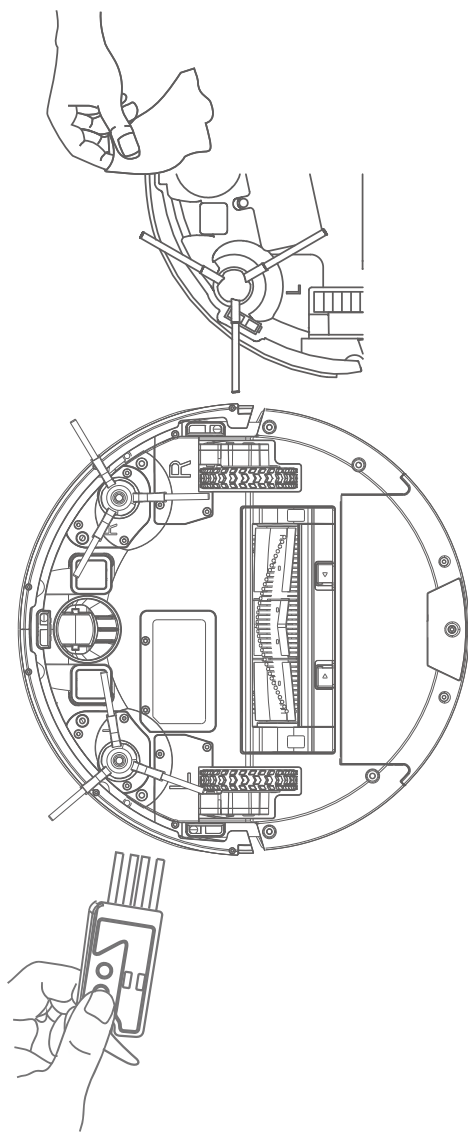

Top of vacuum unit cleaning

When the top of the vacuum unit collects dust and fingerprint, you may wipe and clean it with clean cloth .

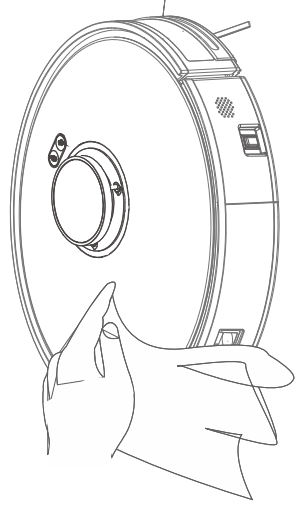

Routine Maintenance

Cleaning the Mopping Pad

- Step **1**: Press the water tank release buckle and take out the water tank, as shown in Figure 1.
- Step **2**: Remove the mopping pad from the velcro, as shown in Figure 2.
- Step **3**: Rinse the mopping cloth, dry it, and reuse it. Avoid drying in the sun, as shown in Figure 3.

Note: Do not directly clean the mopping pad with the water tank under the running water; the water temperature must not exceed 60 degrees; machine washing is not recommended.



Figure 1.

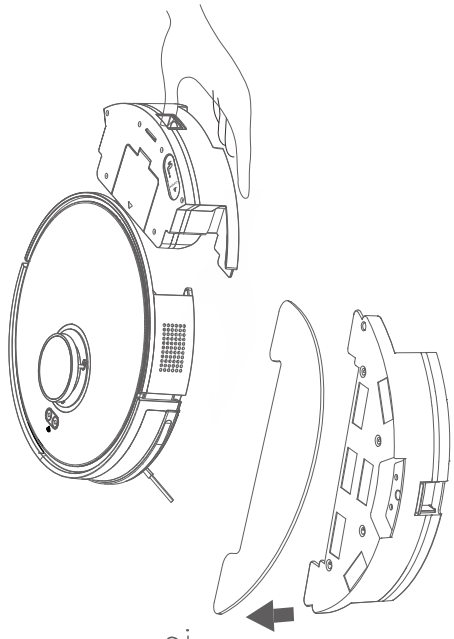
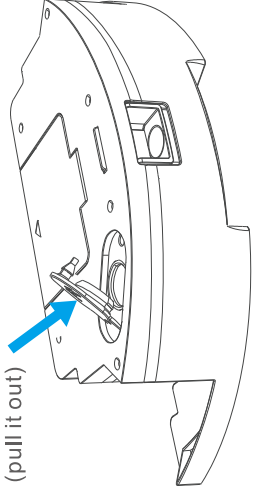

Figure 2.



(pull it out)

Remove the water tank plug that needs to be replaced and install a new suitable water tank plug.

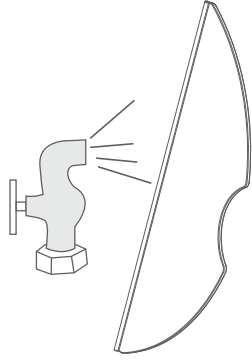
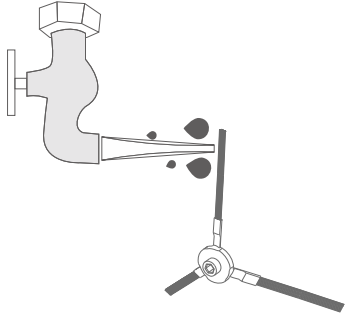

Figure 3.

Maintenance

C. When the side brush cannot be used, please remove the, damaged side brush and replace it in time

Note: Cleaning water must be lower than 60 degree Celsius



Robot sensor and cleaning

Use a soft dry cloth to clean the sensors.

Note: Do not touch the sensors directly with liquids such as water and thinner.

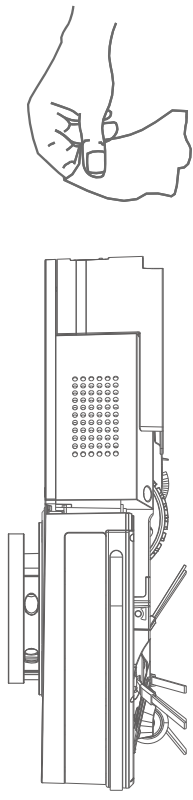

Omnidirectional wheel cleaning

1. Turn the robot over.
2. Pull out the wheel upwards.
3. Reinstall after cleaning and press firmly.
4. Rinse the axle and the wheel with water to remove any hair and dirt.
5. Dry and reinstall the wheel then press it back in place.

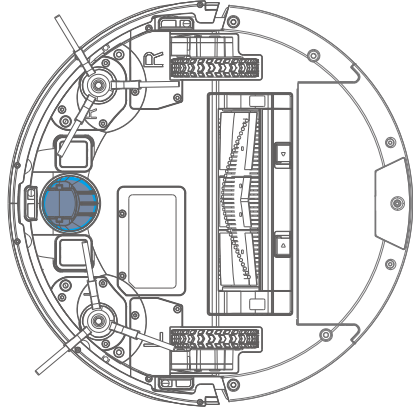
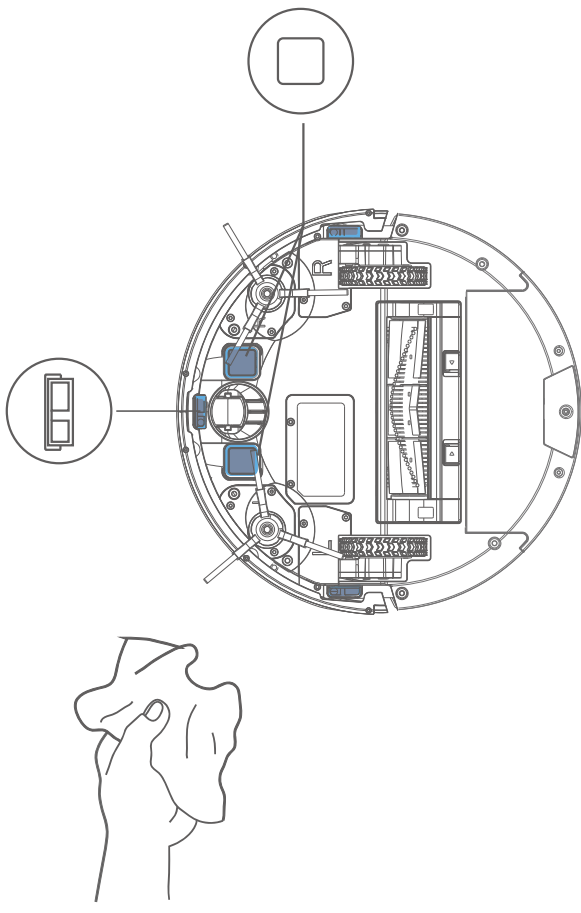

Troubleshooting

Error	Solution
The main brush tangled up	Please clean the roller brush
The side brush tangled up	Please clean the side brush
A wheel is abnormal and the robot jammed	Please check the driving wheels
The dust bin abnormal installation	Please install the dust bin
Abnormal cliff sensor / dirty cliff sensor	Please wipe the cliff sensors
The robot is stuck	Please clean any obstacle around it
The bumper is stuck	Please check the front bumper
The robot is suspended	Please put the robot back on the ground

FAQs

Problem	Solution
Unable to connect to WiFi	<p>WiFi is disabled. Reset the WiFi and try again.</p> <p>WiFi signal is poor. Make sure that the robot is in an area with good WiFi signal reception</p> <p>Only powered on, press the pause button for 3-5 seconds for the first time to start the smart network connection until there is a voice prompt (WiFi indicator light flashes quickly).</p> <p>Only 2.4G network is supported.</p>

FAQs

Problem	Solution
Unable to install the App	IOS 9.0, Android 5.0 and above systems, can download and use APP.
Unable to charge	If the charging dock is not receiving power, check that both ends of the power cable are properly connected. If contact is poor, clean the contact areas of the charging dock and the robot. Power is restored when the power indicator light turns on.
Difficult to recharge	There are too many obstacles near the charging dock. Move it to an open area. The robot is too far from the charging dock. Place it closer and retry.
Poor cleaning ability	It is recommended to clean up the ground debris first. If there is a part missing to clean, the robot will automatically schedule to clean it.
The robot is jammed	The robot will actively try various methods to get rid of jams. Or it is recommended to help manually.
Noise during cleaning	The main brush, side brush, or main wheels may be jammed. Turn off the robot and clean them. If the omnidirectional wheel is jammed, remove it for cleaning.
Pure suction power	The dust bin is full and needs emptying. The filter is blocked and needs cleaning. The main brush is jammed and needs cleaning. Let the filter foam to air dry.

Product parameters

If the above methods cannot solve the problem, you can try the following:

1. Turn on the power switch on the side of the unit again and restart the machine.
2. If the machine keeps moving backwards, please pat the bumper with your hand and restart it.
3. If the machine does not move forward, please check whether the cliff sensor is blocked and clean the dust on the sensor cover.
4. If the problem cannot be solved by restarting, please return the machine to the after-sales service center for repair.

Tips :

1. The laser sweeper can automatically recognize the floor plan. During the cleaning process, it will move in zip zag shape.
2. The laser navigation machine has a repositioning function. When using this function, the machine needs to be paused first and be in the area that has been cleaned, otherwise the positioning will fail.

The robot Parameters

Name	Parameter
Size	L320*W320*H95mm
voltage	14.4V
ated power	32W
Battery	2500mAh Li-battery
Charging base Output voltage	20V
Charging base output current	0.9A

Remark: Storage temperature 0-45 °C

Docking station parameters

Name	Parameters
Size	L183*W140*H76mm
Rated input	□ 20 V === 0.9A
Rated output	□ 20 V === 0.9A
Rated power	50/60Hz



Product parameter

Name and content of hazardous substances in the product

Name	Parts						
	Lead(Pb)	Mercury(Hg)	Mercury(Cd)	Hexavalent Chromium (Cr(VI))	Polybrominated Biphenyls (PBB)	Polybrominated DiphenylEthers (PBDE)	
Circuit	×	○	○	○	○	○	
Metal Parts	○	○	○	○	○	○	
Plastic Casing	○	○	○	○	○	○	
Battery	○	○	○	○	○	○	
Other parts	○	○	○	○	○	○	
<p>This form is compiled in accordance with the regulations of SJ/T 11364.</p> <p>○ Means that the content of the hazardous substance in all homogeneous materials of the part is below the limit requirement specified in GB/T 26572.</p> <p>× Means that the hazardous substance at least in a certain homogeneous material of the part exceeds the limit requirement of GB/T 26572.</p>							



