



**FCC 47 CFR PART 15 SUBPART C**

**CERTIFICATION TEST REPORT**

*For*

**CONSUMER CAMERA**

**MODEL NUMBER: IPC-TA22CP**

**ADDITIONAL MODEL NUMBER: IPC-TA22CN;IPC-TA22CP-imou;  
IPC-TA22CN-imou;IPC-TA22C-imou;LC-A2X**

**PROJECT NUMBER: 4789644578**

**REPORT NUMBER: 4789644578-4**

**FCC ID: 2AVYF-IPC-TAX2C**

**ISSUE DATE: Nov. 05, 2020**

*Prepared for*

**Hangzhou Huacheng Network Technology Co., Ltd.**

*Prepared by*

**UL-CCIC COMPANY LIMITED**

**No. 2, Chengwan Road, Suzhou Industrial Park, People's Republic of China**

**Tel: +86 769 22038881**

**Fax: +86 769 33244054**

**Website: [www.ul.com](http://www.ul.com)**



Revision History

<u>Rev.</u>	<u>Issue Date</u>	<u>Revisions</u>	<u>Revised By</u>
V0	11/05/2020	Initial Issue	



## TABLE OF CONTENTS

<b>1. ATTESTATION OF TEST RESULTS .....</b>	<b>4</b>
<b>2. TEST METHODOLOGY .....</b>	<b>6</b>
<b>3. FACILITIES AND ACCREDITATION .....</b>	<b>6</b>
<b>4. CALIBRATION AND UNCERTAINTY .....</b>	<b>7</b>
4.1. <i>MEASURING INSTRUMENT CALIBRATION .....</i>	<i>7</i>
4.2. <i>MEASUREMENT UNCERTAINTY.....</i>	<i>7</i>
<b>5. EQUIPMENT UNDER TEST .....</b>	<b>8</b>
5.1. <i>DESCRIPTION OF EUT .....</i>	<i>8</i>
5.2. <i>MAXIMUM OUTPUT POWER.....</i>	<i>9</i>
5.3. <i>CHANNEL LIST .....</i>	<i>9</i>
5.4. <i>TEST CHANNEL CONFIGURATION.....</i>	<i>10</i>
5.5. <i>THE WORSE CASE POWER SETTING PARAMETER.....</i>	<i>10</i>
5.6. <i>DESCRIPTION OF AVAILABLE ANTENNAS .....</i>	<i>11</i>
5.7. <i>THE WORSE CASE CONFIGURATIONS .....</i>	<i>11</i>
5.8. <i>TEST ENVIRONMENT .....</i>	<i>12</i>
5.9. <i>DESCRIPTION OF TEST SETUP.....</i>	<i>13</i>
5.10. <i>MEASURING INSTRUMENT AND SOFTWARE USED .....</i>	<i>14</i>
<b>6. MEASUREMENT METHODS .....</b>	<b>15</b>
<b>7. ANTENNA PORT TEST RESULTS .....</b>	<b>16</b>
7.1. <i>ON TIME AND DUTY CYCLE.....</i>	<i>16</i>
7.2. <i>6 dB BANDWIDTH.....</i>	<i>19</i>
7.3. <i>PEAK CONDUCTED OUTPUT POWER.....</i>	<i>27</i>
7.4. <i>POWER SPECTRAL DENSITY.....</i>	<i>29</i>
7.5. <i>CONDUCTED BANDEDGE AND SPURIOUS EMISSIONS.....</i>	<i>37</i>
7.6. <i>RADIATED TEST RESULTS .....</i>	<i>74</i>
7.6.1. <i>LIMITS AND PROCEDURE .....</i>	<i>74</i>
7.6.2. <i>TEST ENVIRONMENT .....</i>	<i>79</i>
7.6.3. <i>RESTRICTED BANDEDGE .....</i>	<i>79</i>
7.6.4. <i>SPURIOUS EMISSIONS .....</i>	<i>96</i>
<b>8. AC POWER LINE CONDUCTED EMISSIONS.....</b>	<b>153</b>
<b>9. ANTENNA REQUIREMENTS.....</b>	<b>156</b>



# 1. ATTESTATION OF TEST RESULTS

## Applicant Information

Company Name: Hangzhou Huacheng Network Technology Co., Ltd.  
Address: No.2930, Nanhuan Road, Binjiang District, Hangzhou, China

## Manufacturer Information

Company Name: Hangzhou Huacheng Network Technology Co., Ltd.  
Address: No.2930, Nanhuan Road, Binjiang District, Hangzhou, China

## EUT Description

Product Name: CONSUMER CAMERA  
Model Name: IPC-TA22CP  
Additional No. : IPC-TA22CN;IPC-TA22CP-imou;IPC-TA22CN-imou;  
IPC-TA22C-imou;LC-A2X  
Sample Number: 3379318  
Data of Receipt Sample: Sep. 24, 2020  
Date Tested: Sep. 24, 2020~ Nov. 01, 2020

APPLICABLE STANDARDS	
STANDARD	TEST RESULTS
CFR 47 Part 15 Subpart C	PASS



Summary of Test Results			
Clause	Test Items	FCC Rules	Test Results
1	6db DTS Bandwidth	FCC 15.247 (a) (2)	Complied
2	Conducted Power	FCC 15.247 (b) (3)	Complied
3	Power Spectral Density	FCC 15.247 (e)	Complied
4	Conducted Band edge And Spurious emission	FCC 15.247 (d)	Complied
5	Radiated Band edges and Spurious emission	FCC 15.247 (d) FCC 15.209 FCC 15.205	Complied
6	Conducted Emission Test For AC Power Port	FCC 15.207	Complied
7	Antenna Requirement	FCC 15.203	Complied
Remark: 1) The measurement result for the sample received is <Pass> according to < ANSI C63.10-2013, FCC CFR 47 Part 2, FCC CFR 47 Part 15C> when <Accuracy Method> decision rule is applied.			

Prepared By:

*Jason Yang*

Jason Yang  
Engineer

Reviewed By:

*Tom Tang*

Tom Tang  
Engineer Project Associate

Authorized By:

*Chris Zhong*

Chris Zhong  
Laboratory Leader



## 2. TEST METHODOLOGY

The tests documented in this report were performed in accordance with FCC KDB 558074 D01 15.247 Meas Guidance v05r02, KDB 414788 D01 Radiated Test Site v01r01, ANSI C63.10-2013, FCC CFR 47 Part 2, FCC CFR 47 Part 15.

## 3. FACILITIES AND ACCREDITATION

Accreditation Certificate	<p><b>A2LA (Certificate No.: 4829.01)</b>  <b>UL-CCIC COMPANY LIMITED has been assessed and proved to be in compliance with A2LA.</b></p> <p><b>FCC (FCC Designation No.: CN1247)</b>  <b>UL-CCIC COMPANY LIMITED has been recognized to perform compliance testing on equipment subject to the Commission's Declaration of Conformity (DoC) and Certification rules.</b></p> <p><b>IC (IC Designation No.: 25056)</b>  <b>UL-CCIC COMPANY LIMITED has been recognized to perform compliance testing on equipment subject to the Commission's Declaration of Conformity (DoC) and Certification rules.</b></p>
---------------------------	--

Note 1: All tests measurement facilities use to collect the measurement data are located at No. 2, Chengwan Road, Suzhou Industrial Park, Suzhou 215122, People's Republic of China

Note 2: For below 30MHz, lab had performed measurements at test anechoic chamber and comparing to measurements obtained on an open field site. These measurements below 30MHz had been correlated to measurements performed on an OFS.

Note 3: The test anechoic chamber in UL-CCIC COMPANY LIMITED had been calibrated and compared to the open field sites and the test anechoic chamber is shown to be equivalent to or worst case from the open field site.



## 4. CALIBRATION AND UNCERTAINTY

### 4.1. MEASURING INSTRUMENT CALIBRATION

The measuring equipment utilized to perform the tests documented in this report has been calibrated in accordance with the manufacturer's recommendations, and is traceable to recognized national standards.

### 4.2. MEASUREMENT UNCERTAINTY

Where relevant, the following measurement uncertainty levels have been estimated for tests performed on the apparatus:

Test Item	Uncertainty
Conduction emission	3.1dB
Radiation Emission test(include Fundamental emission) (9KHz-30MHz)	3.4dB
Radiation Emission test(include Fundamental emission) (30MHz-1GHz)	3.4dB
Radiation Emission test (1GHz to 26GHz)( include Fundamental emission)	3.9dB (1GHz-18Gz)
	4.2dB (18GHz-26.5Gz)
Note: This uncertainty represents an expanded uncertainty expressed at approximately the 95% confidence level using a coverage factor of k=2.	



## 5. EQUIPMENT UNDER TEST

### 5.1. DESCRIPTION OF EUT

Product Name:	CONSUMER CAMERA
Model No.:	IPC-TA22CP
Operating Frequency:	IEEE 802.11b/g/n(HT20): 2412MHz to 2462MHz IEEE 802.11n(HT40): 2422MHz to 2452MHz
Type of Modulation:	IEEE for 802.11b: DSSS (CCK, DQPSK, DBPSK) IEEE for 802.11g: OFDM (64QAM, 16QAM, QPSK, BPSK) IEEE for 802.11n (HT20 and HT40): OFDM (64QAM, 16QAM, QPSK, BPSK)
Channels Step:	Channels with 5MHz step
Sample Type:	Fixed production
Test software of EUT:	Secure CRT (manufacturer declare)
Antenna Type:	Shrapnel antenna
Antenna Gain:	Antenna1: 2.84 dBi Remark: This data is provided by customer and our lab isn't responsible for this data
Adapter	NAME: Power Adapter MODEL: NBS5B050100VUU INPUT:100-240V,50/60Hz, 0.2A OUTPUT:5.0V  1.0A

Remark:

Model No.:

Number:	Name:	Number:	Name:	Number:	Name:
1	IPC-TA22CP	2	IPC-TA22CN	3	IPC-TA22CP-imou
4	IPC-TA22CN-imou	5	IPC-TA22C-imou	6	LC-A2X

Only the main model **IPC-TA22CP** was tested and only the data of this model is shown in this test report.

Since Their electrical circuit design, layout, components used and internal wiring are identical, only the market regions and customers are different.





## 5.2. MAXIMUM OUTPUT POWER

Number of Transmit Chains (NTX)	IEE Std. 802.11	Channel Number	Max AV Conducted Power (dBm)
1	IEEE 802.11B SISO	1-11[11]	15.32
1	IEEE 802.11G SISO	1-11[11]	10.60
1	IEEE 802.11nHT20	1-11[11]	11.03
1	IEEE 802.11nHT40	3-9[7]	7.04

## 5.3. CHANNEL LIST

Channel List for 802.11b/g/n (20 MHz)							
Channel	Frequency (MHz)	Channel	Frequency (MHz)	Channel	Frequency (MHz)	Channel	Frequency (MHz)
1	2412	4	2427	7	2442	10	2457
2	2417	5	2432	8	2447	11	2462
3	2422	6	2437	9	2452		

Channel List for 802.11n (40 MHz)							
Channel	Frequency (MHz)	Channel	Frequency (MHz)	Channel	Frequency (MHz)	Channel	Frequency (MHz)
3	2422	5	2432	7	2442	9	2452
4	2427	6	2437	8	2447		



#### 5.4. TEST CHANNEL CONFIGURATION

Test Mode	Test Channel	Frequency
WiFi TX(802.11b)	CH 1, CH 6, CH 11	2412MHz, 2437MHz, 2462MHz
WiFi TX(802.11g)	CH 1, CH 6, CH 11	2412MHz, 2437MHz, 2462MHz
WiFi TX(802.11n HT20)	CH 1, CH 6, CH 11	2412MHz, 2437MHz, 2462MHz
WiFi TX(802.11n HT40)	CH 3, CH 6, CH 9	2422MHz, 2437MHz, 2452MHz

#### 5.5. THE WORSE CASE POWER SETTING PARAMETER

The Worst Case Power Setting Parameter under 2400 ~ 2483.5MHz Band							
Test Software		SecureCRT					
Modulation Mode	Transmit Antenna Number	Test Channel					
		NCB: 20MHz			NCB: 40MHz		
		CH 1	CH 6	CH 11	CH 3	CH 6	CH 9
802.11b	1	-6	-6	-6	/		
802.11g	1	N/A	N/A	N/A			
802.11n HT20	1	N/A	N/A	N/A			
802.11n HT40	1	/			N/A	N/A	N/A



## 5.6. DESCRIPTION OF AVAILABLE ANTENNAS

Ant.	Frequency (MHz)	Antenna Type	Antenna Gain (dBi)
1	2400-2483.5	Shrapnel antenna	2.84

Test Mode	Transmit and Receive Mode	Description
IEEE 802.11b	<input checked="" type="checkbox"/> 1TX, 1RX	Antenna1 can be used as transmitting/receiving antenna independently.
IEEE 802.11g	<input checked="" type="checkbox"/> 1TX, 1RX	Antenna1 can be used as transmitting/receiving antenna independently.
IEEE 802.11N (HT20)	<input checked="" type="checkbox"/> 1TX, 1RX	Antenna1 can be used as transmitting/receiving antenna independently.
IEEE 802.11N (HT20)	<input checked="" type="checkbox"/> 1TX, 1RX	Antenna1 can be used as transmitting/receiving antenna independently.

## 5.7. THE WORSE CASE CONFIGURATIONS

For the product, there two transmission antennas, and pre-testing both of them, only the worse data for the antenna is recorded in the report.

Worst-case data rates as provided by the client were:

802.11b mode: 1 Mbps  
802.11b mode: 6 Mbps  
802.11n HT20 mode: MCS0  
802.11n HT40 mode: MCS0



### 5.8. TEST ENVIRONMENT

Environment Parameter	Selected Values During Tests	
Relative Humidity	55 ~ 65%	
Atmospheric Pressure:	1025Pa	
Temperature	TN	23 ~ 28°C
Voltage :	VL	N/A
	VN	AC 120V
	VH	N/A

Note: VL= Lower Extreme Test Voltage  
VN= Nominal Voltage  
VH= Upper Extreme Test Voltage  
TN= Normal Temperature

## 5.9. DESCRIPTION OF TEST SETUP

### SUPPORT EQUIPMENT

Item	Equipment	Brand Name	Model Name	Description
1	Laptop	ThinkPad	E550c	N/A
2	Fixed Frequency Board	N/A	N/A	Supply by UL Lab

### I/O PORT

Cable No	Port	Connector Type	Cable Type	Cable Length(m)	Remarks
1	USB	USB	USB-VGA	100cm Length (Supply by UL Lab)	N/A

### ACCESSORY

Item	Accessory	Brand Name	Model Name	Description
1	Micro SD card	Kingston	32GB	Supply by UL lab

### TEST SETUP

The EUT can work in an engineer mode with a software through a table PC.

### SETUP DIAGRAM FOR TESTS

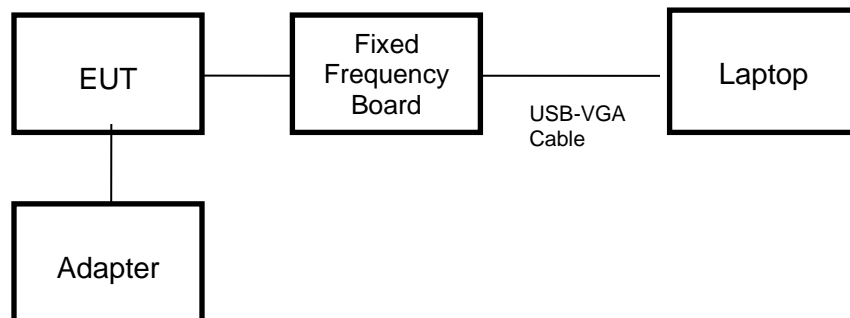

Remark: The EUT has been built one SD card during the testing.



### 5.10. MEASURING INSTRUMENT AND SOFTWARE USED

Conducted Emissions (Instrument)							
Used	Equipment	Manufacturer	Model No.	Serial No.	Upper Last Cal.	Last Cal.	Next Cal.
<input checked="" type="checkbox"/>	EMI Test Receiver	R&S	ESR3	126700	2018-12-13	2019-12-12	2020-12-11
<input checked="" type="checkbox"/>	Two-Line V-Network	R&S	ENV216	126701	2018-12-13	2019-12-12	2020-12-11
<input checked="" type="checkbox"/>	Artificial Mains Networks	R&S	ENY81	126711	2018-12-13	2019-12-12	2020-12-11
Software							
Used	Description	Manufacturer	Name	Version			
<input checked="" type="checkbox"/>	Test Software for Conducted disturbance	R&S	EMC32	Ver. 9.25			
Radiated Emissions (Instrument)							
Used	Equipment	Manufacturer	Model No.	Serial No.	Upper Last Cal.	Last Cal.	Next Cal.
<input checked="" type="checkbox"/>	Spectrum Analyzer	Keysight	N9010B	MY57110128	2019-05-29	2020-05-10	2021-05-09
<input checked="" type="checkbox"/>	EMI test receiver	R&S	ESR26	1267603	2018-12-13	2019-12-22	2020-12-21
<input checked="" type="checkbox"/>	Receiver Antenna (9kHz-30MHz)	Schwarzbeck	FMZB 1513	513-265	N/A	2018-06-15	2021-06-14
<input checked="" type="checkbox"/>	Receiver Antenna (30MHz-1GHz)	SunAR RF Motion	JB1	126704	N/A	2019-01-28	2022-01-27
<input checked="" type="checkbox"/>	Receiver Antenna (1GHz-18GHz)	R&S	HF907	126705	2019-01-26	2020-01-26	2021-01-25
<input checked="" type="checkbox"/>	Receiver Antenna (18GHz-26.5GHz)	Schwarzbeck	BBHA9170	126706	2019-02-06	2020-02-05	2021-02-04
<input checked="" type="checkbox"/>	Pre-amplification (To 1GHz)	R&S	SCU-03D	134666	2019-02-06	2020-02-05	2021-02-04
<input checked="" type="checkbox"/>	Pre-amplification (To 18GHz)	Compliance Direction System Inc.	PAP-1G18-50	14140-13467	2019-03-18	2020-02-20	2021-02-19
<input checked="" type="checkbox"/>	Pre-amplification (To 26.5GHz)	R&S	SCU-26D	134668	2019-02-06	2020-02-05	2021-02-04
<input checked="" type="checkbox"/>	Band Reject Filter	Wainwright	WRCJV8-2350-2400-2483.5-2533.5-40SS	1	2019-05-29	2020-05-10	2021-05-09
<input checked="" type="checkbox"/>	Highpass Filter	Wainwright	WHKX10-2700-3000-18000-40SS	2	2019-05-29	2020-05-10	2021-05-09
Software							
Used	Description	Manufacturer	Name	Version			
<input checked="" type="checkbox"/>	Test Software for Radiated disturbance	Tonscend	JS32	V1.0			
Other instruments							
Used	Equipment	Manufacturer	Model No.	Serial No.	Upper Last Cal.	Last Cal.	Next Cal.
<input checked="" type="checkbox"/>	Spectrum Analyzer	Keysight	N9010B	MY57110128	2019-05-29	2020-05-10	2021-05-09
<input checked="" type="checkbox"/>	Power Meter	Keysight	U2021XA	MY57110002	2019-06-12	2020-05-10	2021-05-09



## 6. MEASUREMENT METHODS

No.	Test Item	KDB Name	Section
1	6dB Bandwidth	KDB 558074 D01 15.247 Meas Guidance v05r02	8.2
2	Peak Output Power	KDB 558074 D01 15.247 Meas Guidance v05r02	8.3.1.3/8.3.2.3
3	Power Spectral Density	KDB 558074 D01 15.247 Meas Guidance v05r02	8.4
4	Out-of-band emissions in non-restricted bands	KDB 558074 D01 15.247 Meas Guidance v05r02	8.5
5	Out-of-band emissions in restricted bands	KDB 558074 D01 15.247 Meas Guidance v05r02	8.6
6	Band-edge	KDB 558074 D01 15.247 Meas Guidance v05r02	8.7
7	Conducted Emission Test For AC Power Port	ANSI C63.10-2013	6.2



## 7. ANTENNA PORT TEST RESULTS

### 7.1. ON TIME AND DUTY CYCLE

#### LIMITS

None; for reporting purposes only

#### PROCEDURE

FCC KDB 558074 Zero-Span Spectrum Analyzer Method

#### TEST SETUP

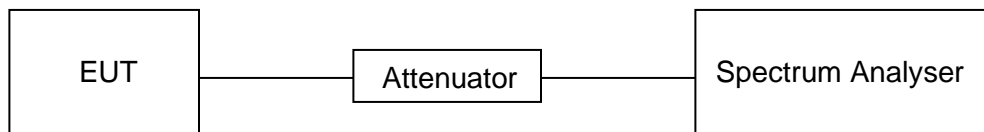

#### TEST ENVIRONMENT

Temperature	22°C	Relative Humidity	56%
Atmosphere Pressure	101kPa	Test Voltage	AC 120V

#### RESULTS

Mode	On Time (msec)	Period (msec)	Duty Cycle x (Linear)	Duty Cycle (%)	Duty Cycle Correction Factor (db)	1/T Minimum VBW (KHz)	Final Minimum VBW (KHz)
11B	2.24	2.33	0.9614	96.14	0.17	0.45	1
11G	0.7106	0.7941	0.8948	89.48	0.48	1.41	2
11N HT20	0.6669	0.7075	0.9426	94.26	0.26	1.50	2
11N HT40	0.339	0.3805	0.8909	89.09	0.50	2.95	3

Note: 1) Duty Cycle Correction Factor=10log(1/x).  
 2) Where: x is Duty Cycle(Linear)  
 3) Where: T is On Time (transmit duration)





### 11B ON TIME AND DUTY CYCLE MID CH (WORSE CASE)

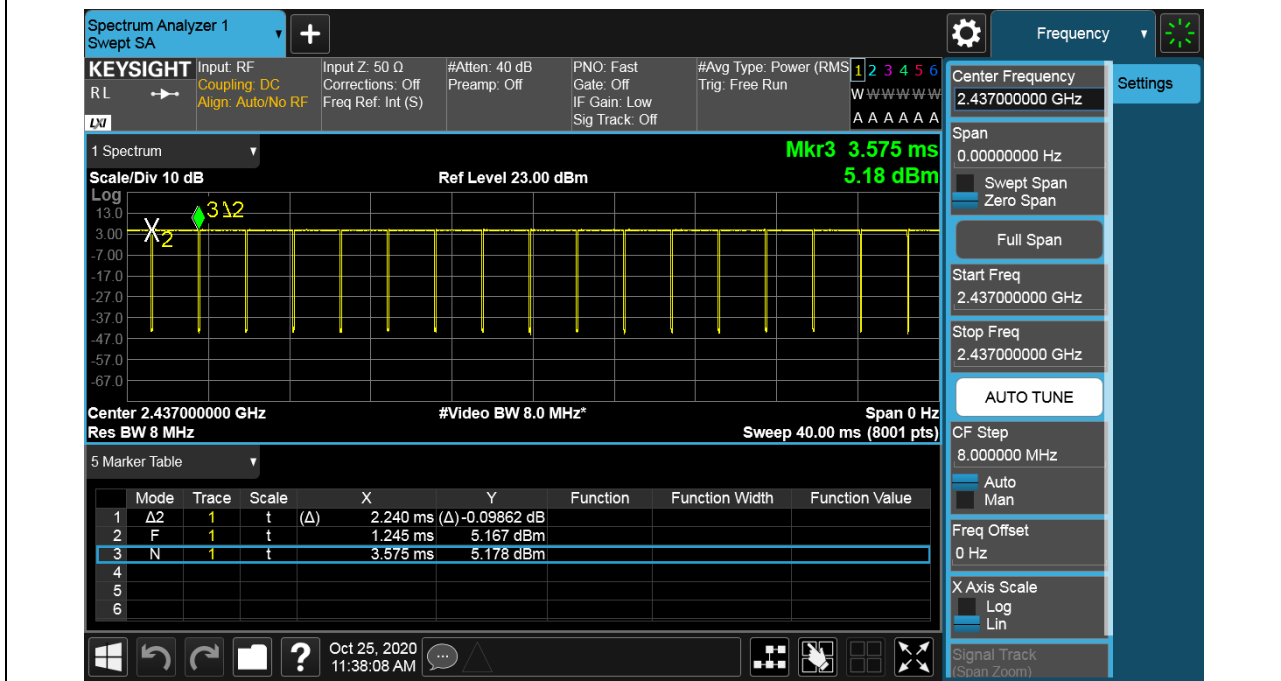

### 11G ON TIME AND DUTY CYCLE MID CH (WORSE CASE)

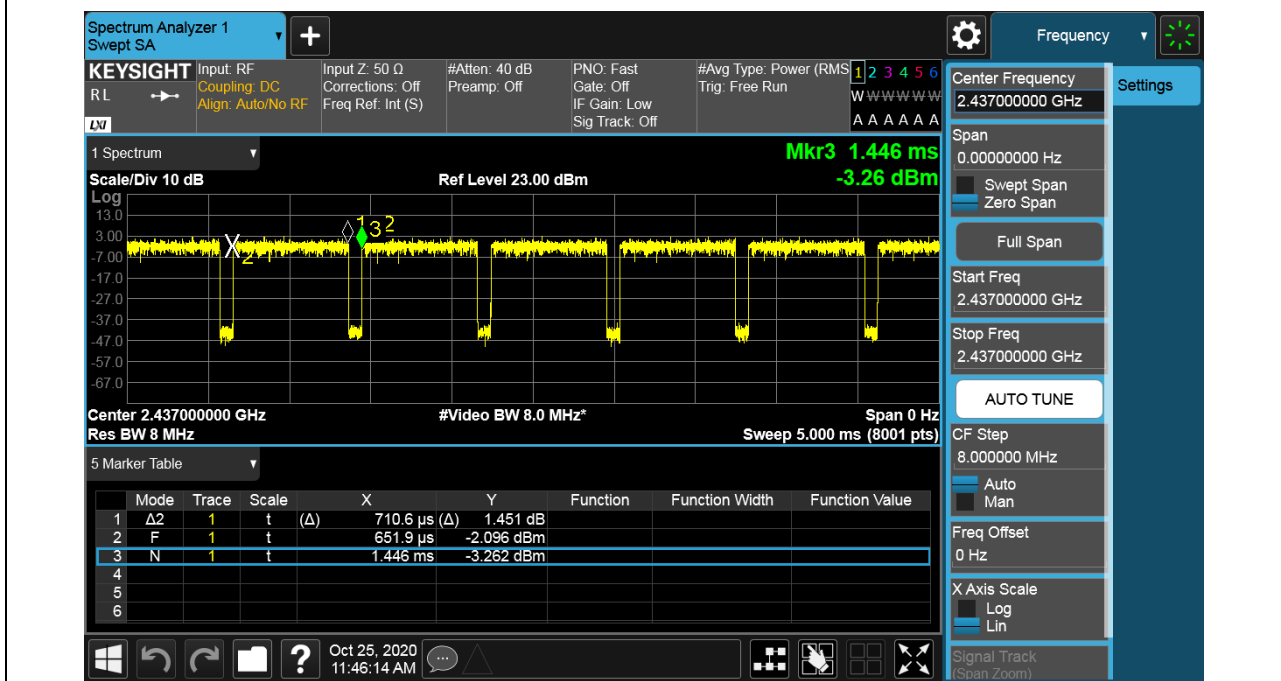



### 11N HT20 ON TIME AND DUTY CYCLE MID CH (WORSE CASE)

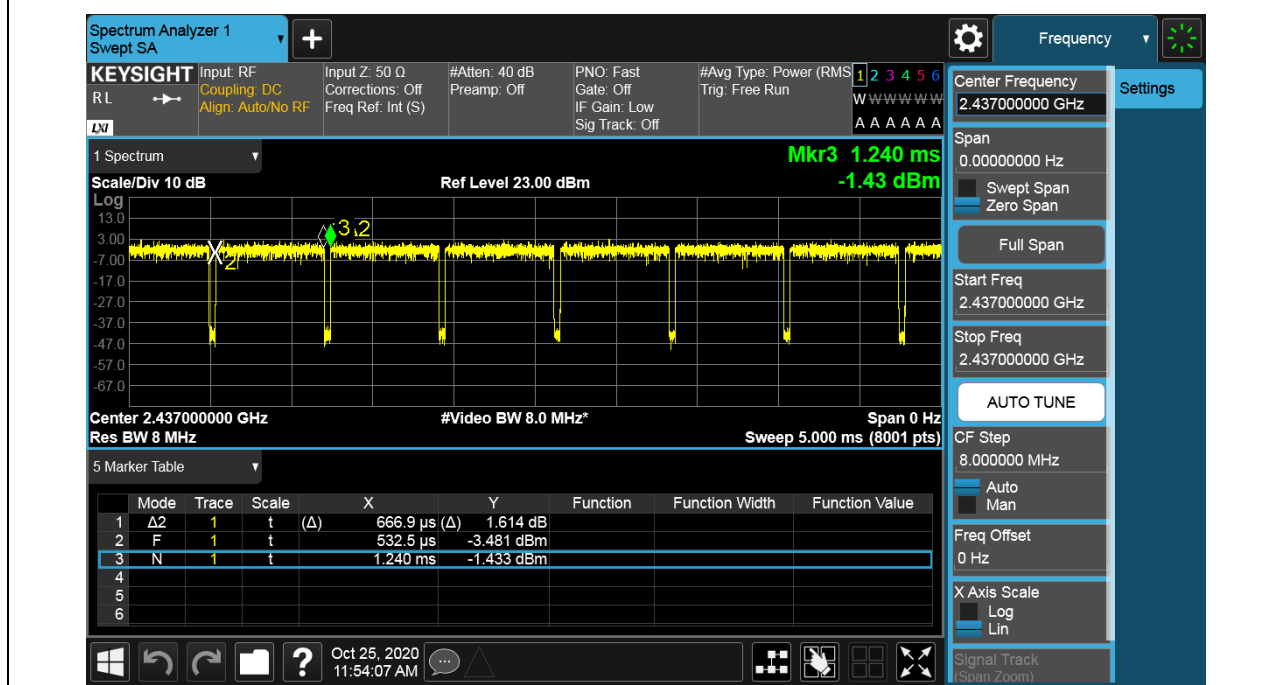

### 11N HT40 ON TIME AND DUTY CYCLE MID CH (WORSE CASE)

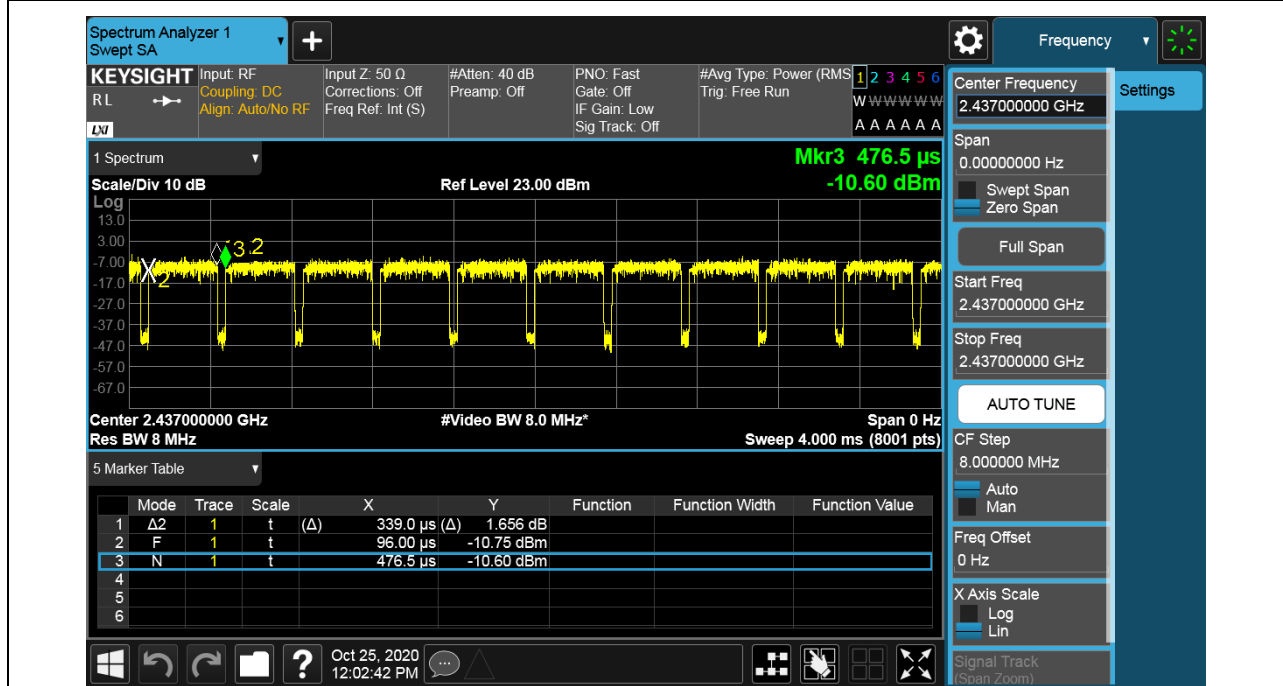

## 7.2. 6 dB BANDWIDTH

### LIMITS

FCC Part15 (15.247) Subpart C			
Section	Test Item	Limit	Frequency Range (MHz)
FCC 15.247(a)(2)	6dB Bandwidth	$\geq 500\text{KHz}$	2400-2483.5

### TEST PROCEDURE

Refer to FCC KDB 558074, connect the UUT to the spectrum analyzer and use the following settings:

Center Frequency	The centre frequency of the channel under test
Detector	Peak
RBW	For 6 dB Bandwidth :100K
VBW	For 6dB Bandwidth : $\geq 3 \times \text{RBW}$
Trace	Max hold
Sweep	Auto couple

Allow the trace to stabilize and measure the maximum width of the emission that is constrained by the frequencies associated with the two outermost amplitude points (upper and lower frequencies) that are attenuated by 6 dB relative to the maximum level measured in the fundamental emission.

### TEST SETUP

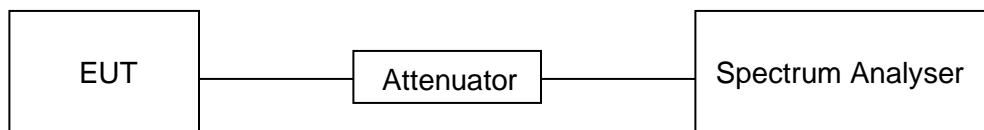



**RESULTS**

Test Mode	Test Channel	6dB bandwidth (MHz)	Result
11B SISO	LCH	9.822	Pass
	MCH	9.925	Pass
	HCH	9.684	Pass
11G SISO	LCH	15.36	Pass
	MCH	16.33	Pass
	HCH	16.34	Pass
11N HT20	LCH	17.04	Pass
	MCH	17.04	Pass
	HCH	17.03	Pass
11N HT40	LCH	35.49	Pass
	MCH	35.16	Pass
	HCH	35.45	Pass



**Test Graphs**

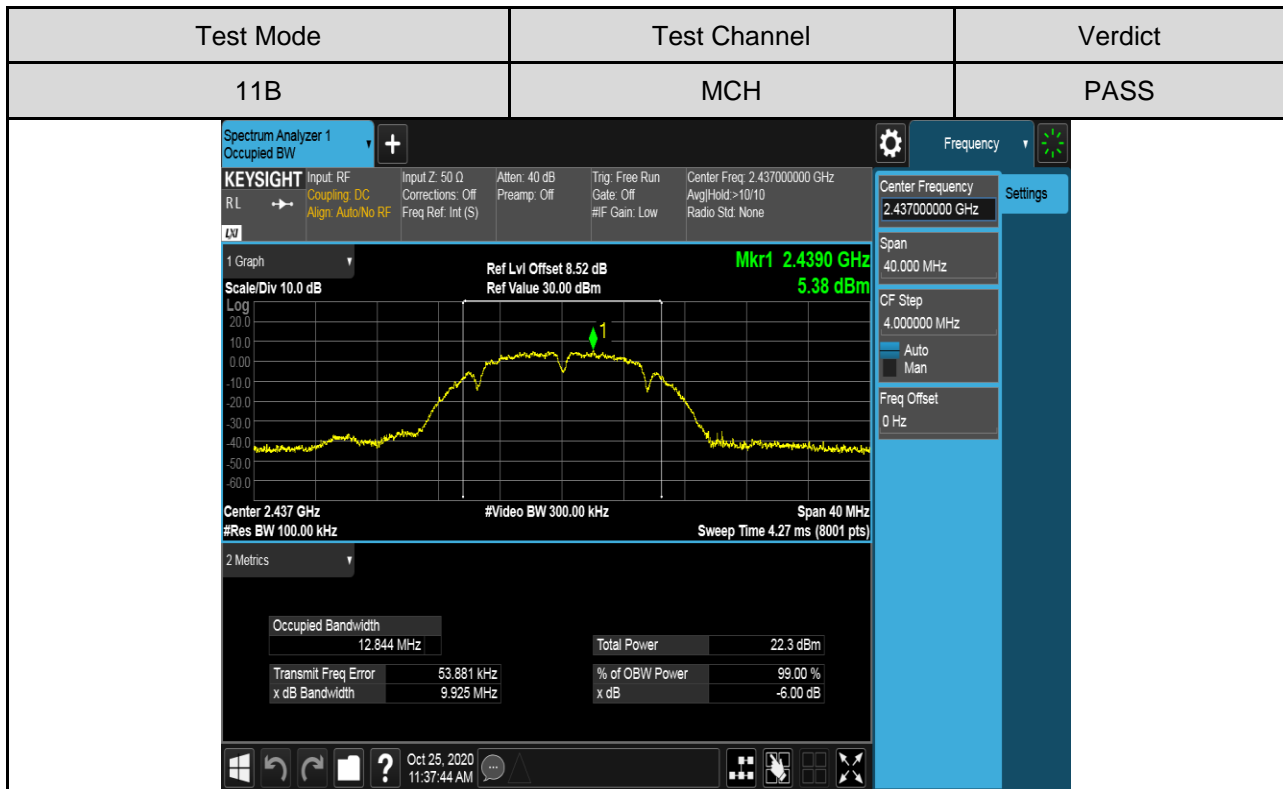
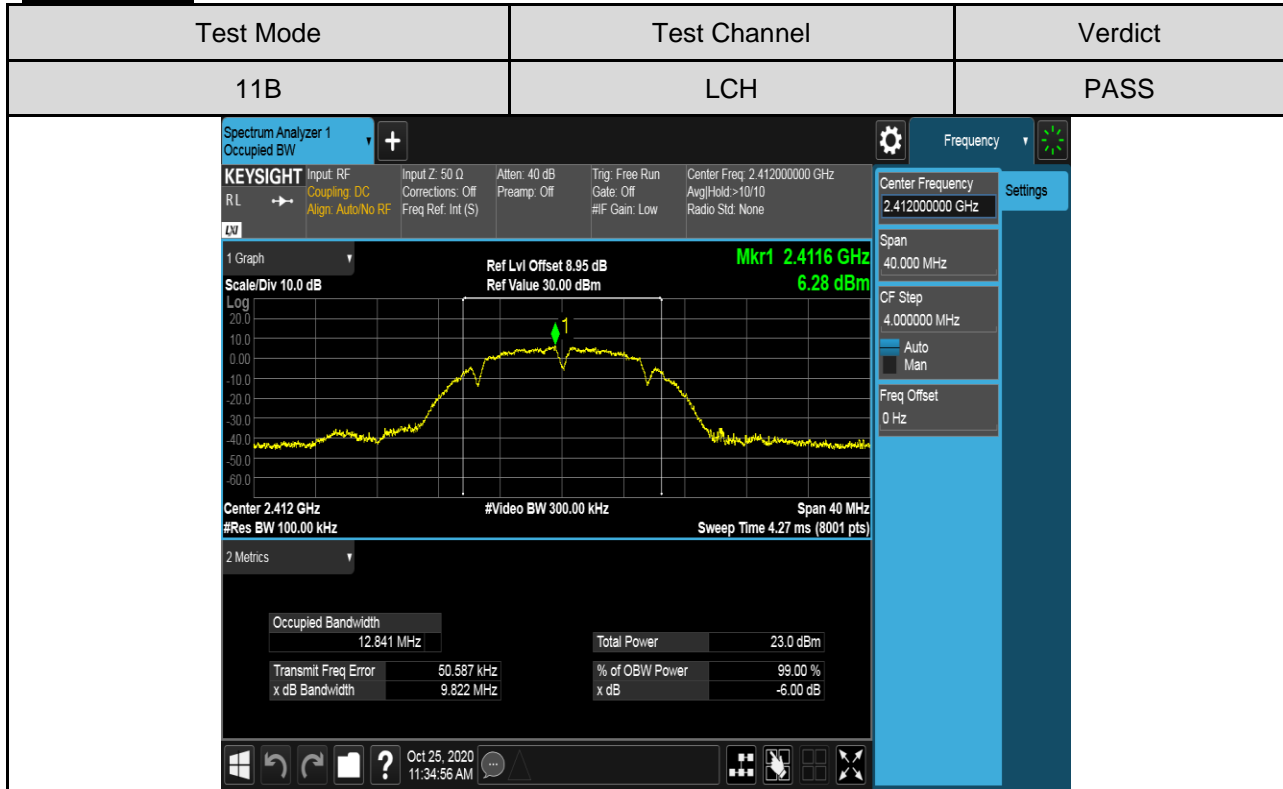

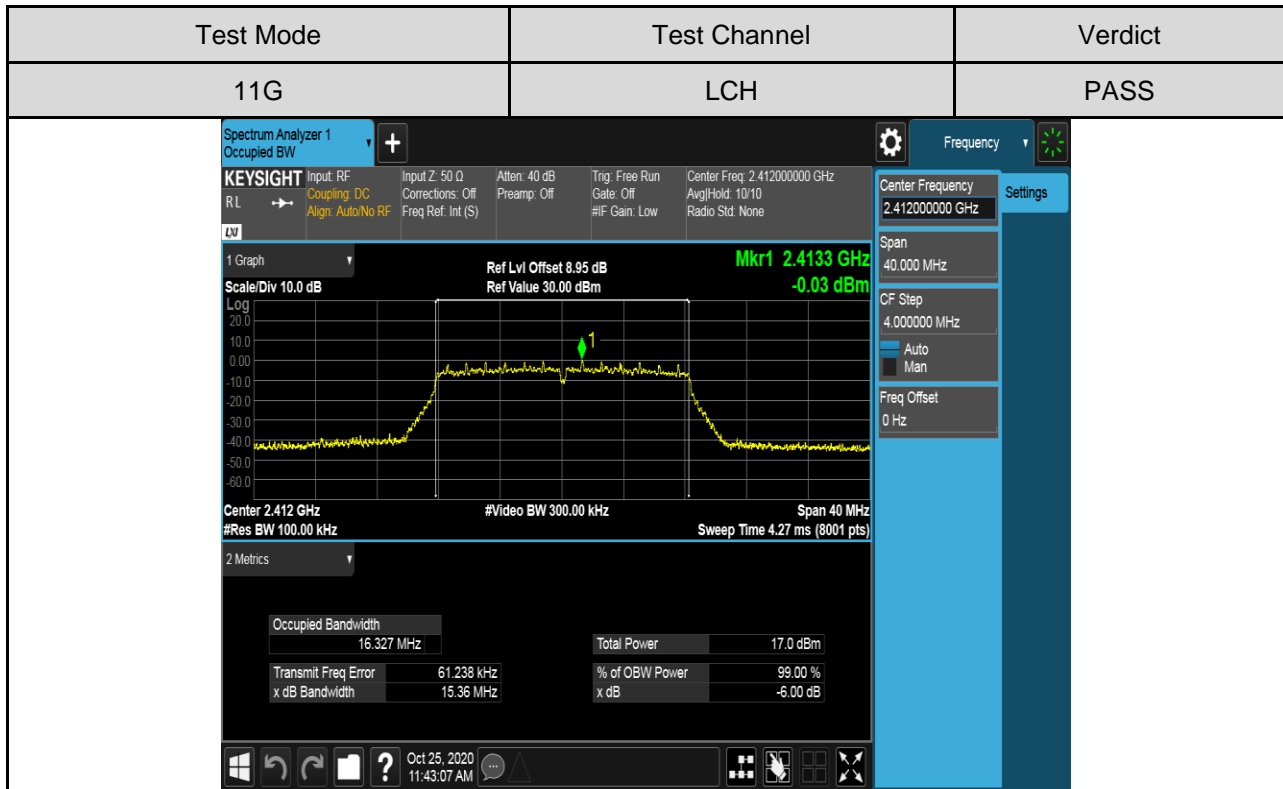
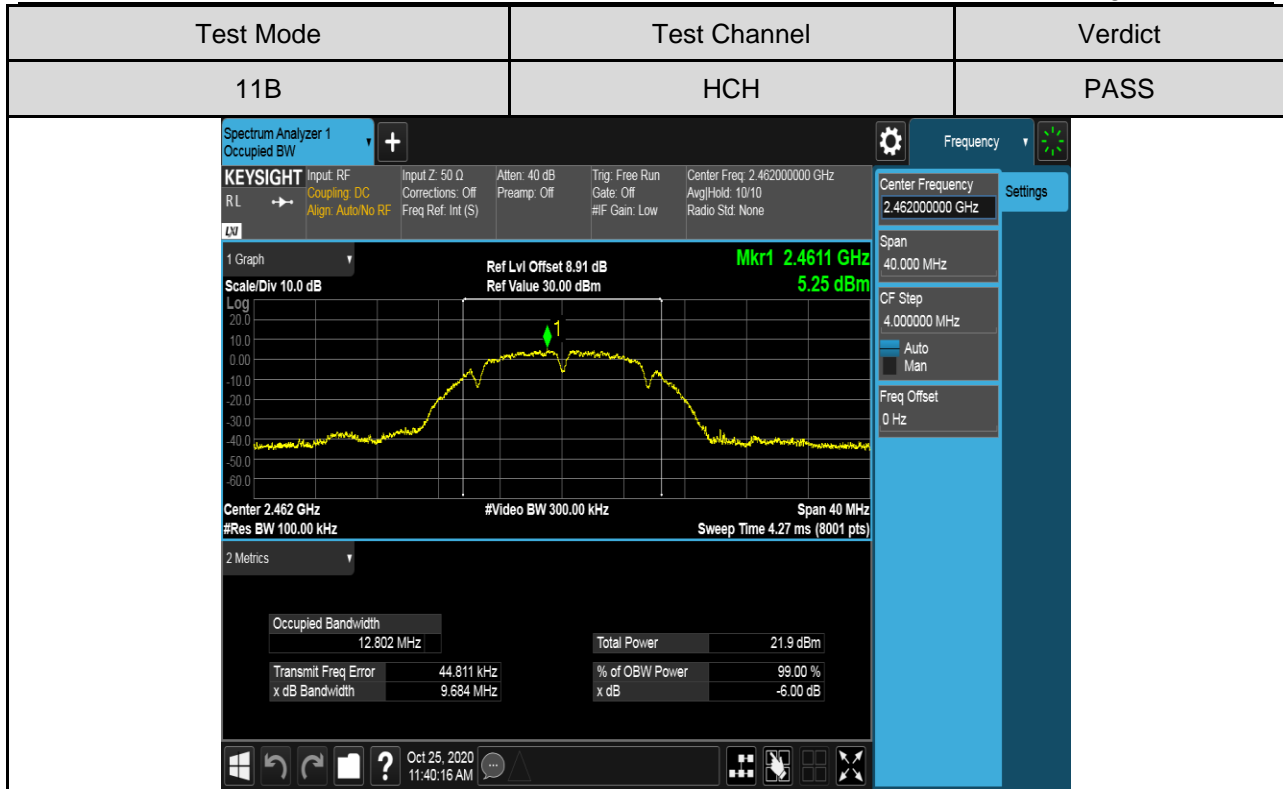

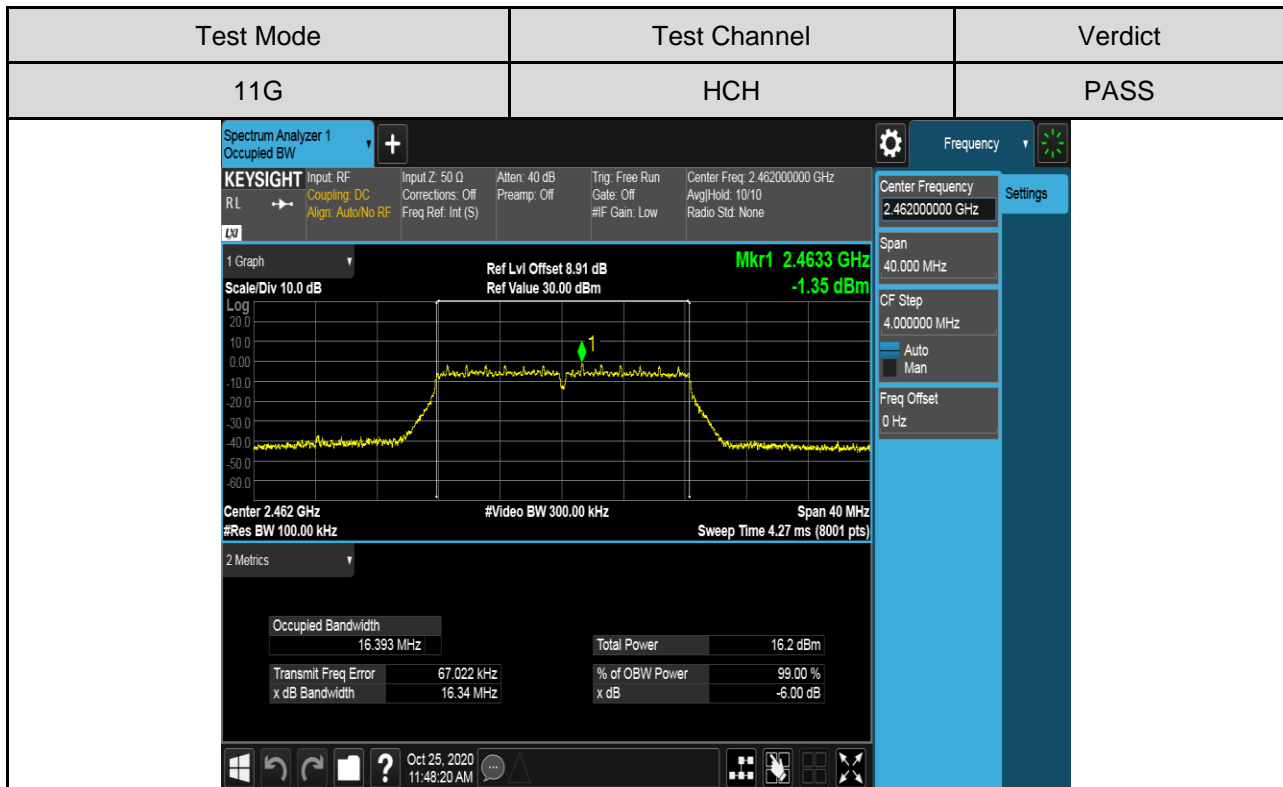
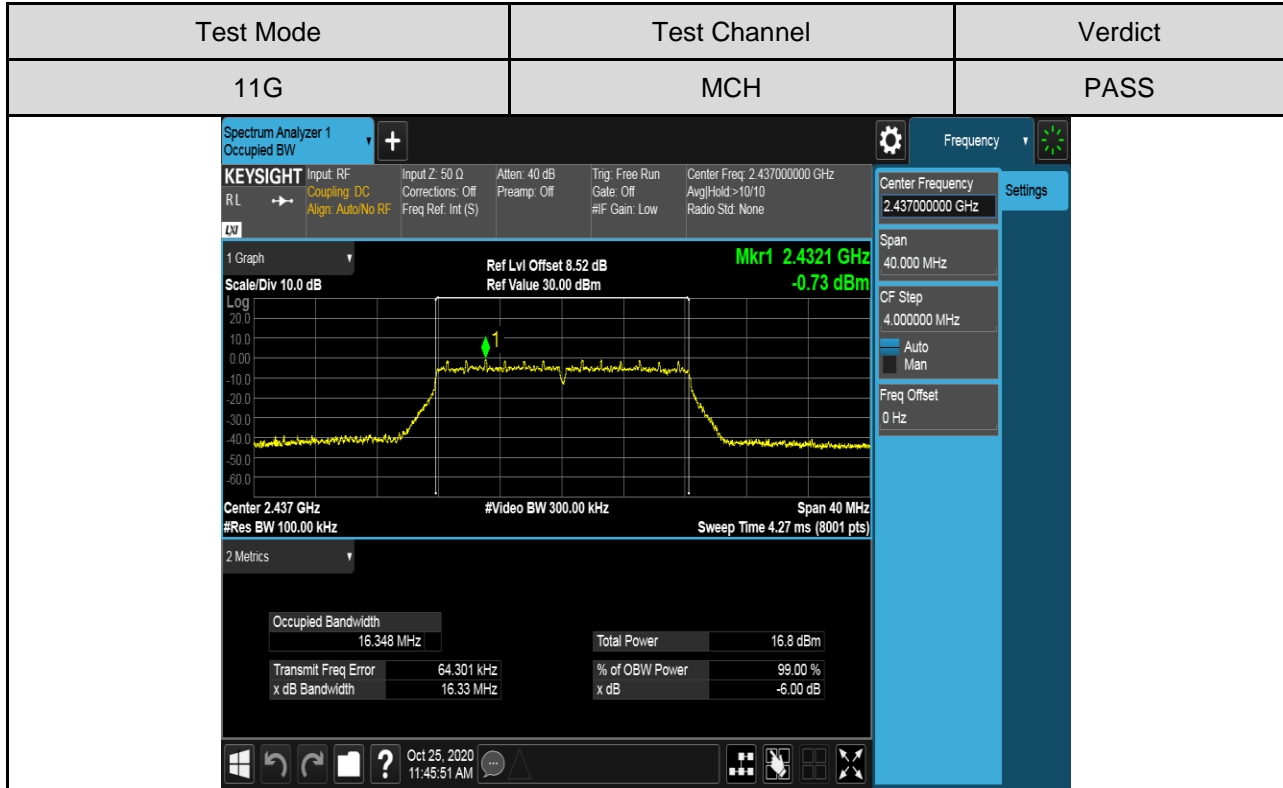

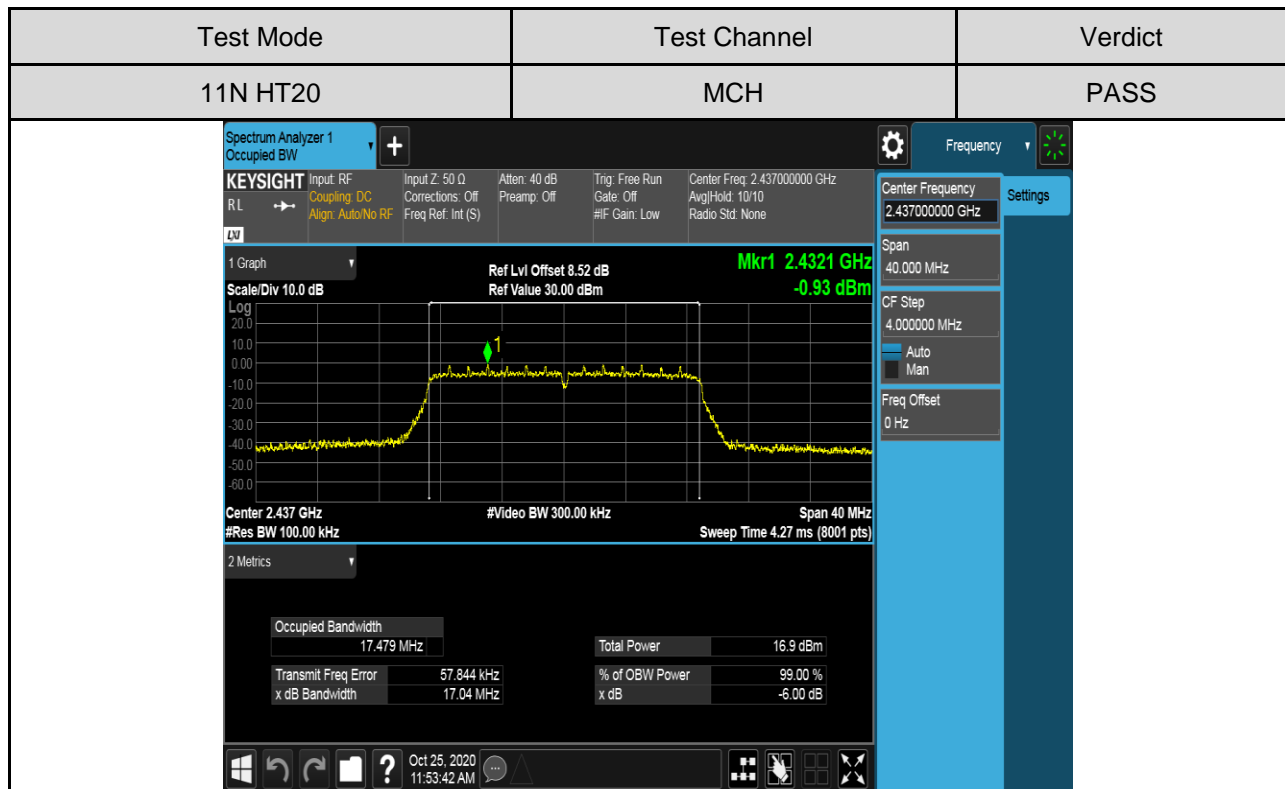
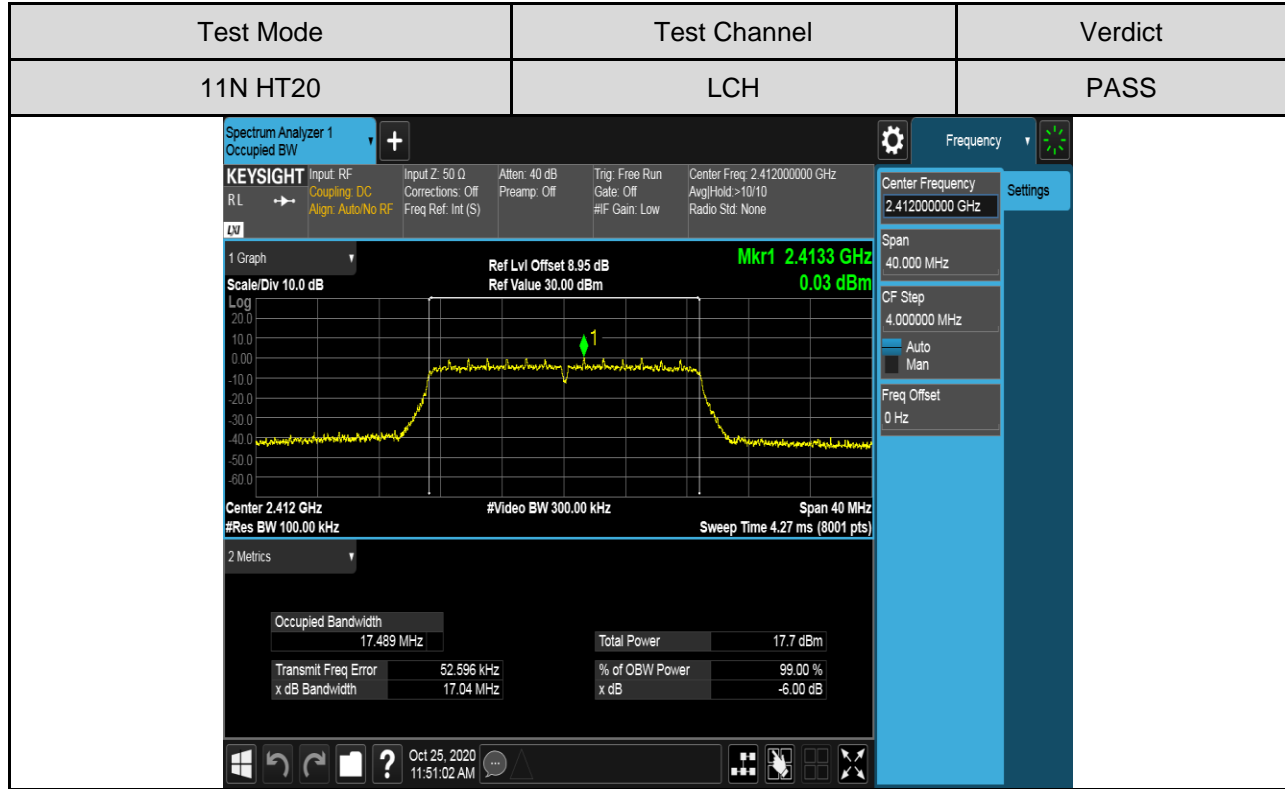



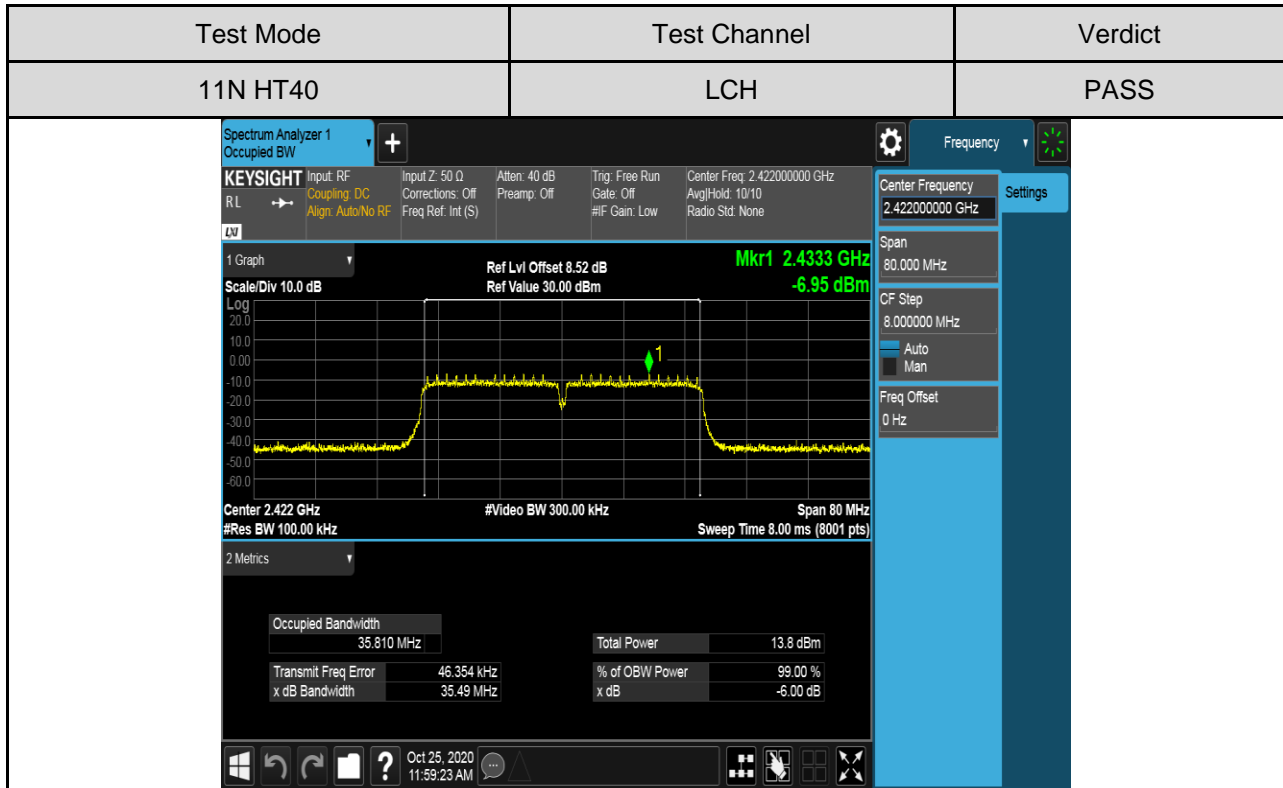
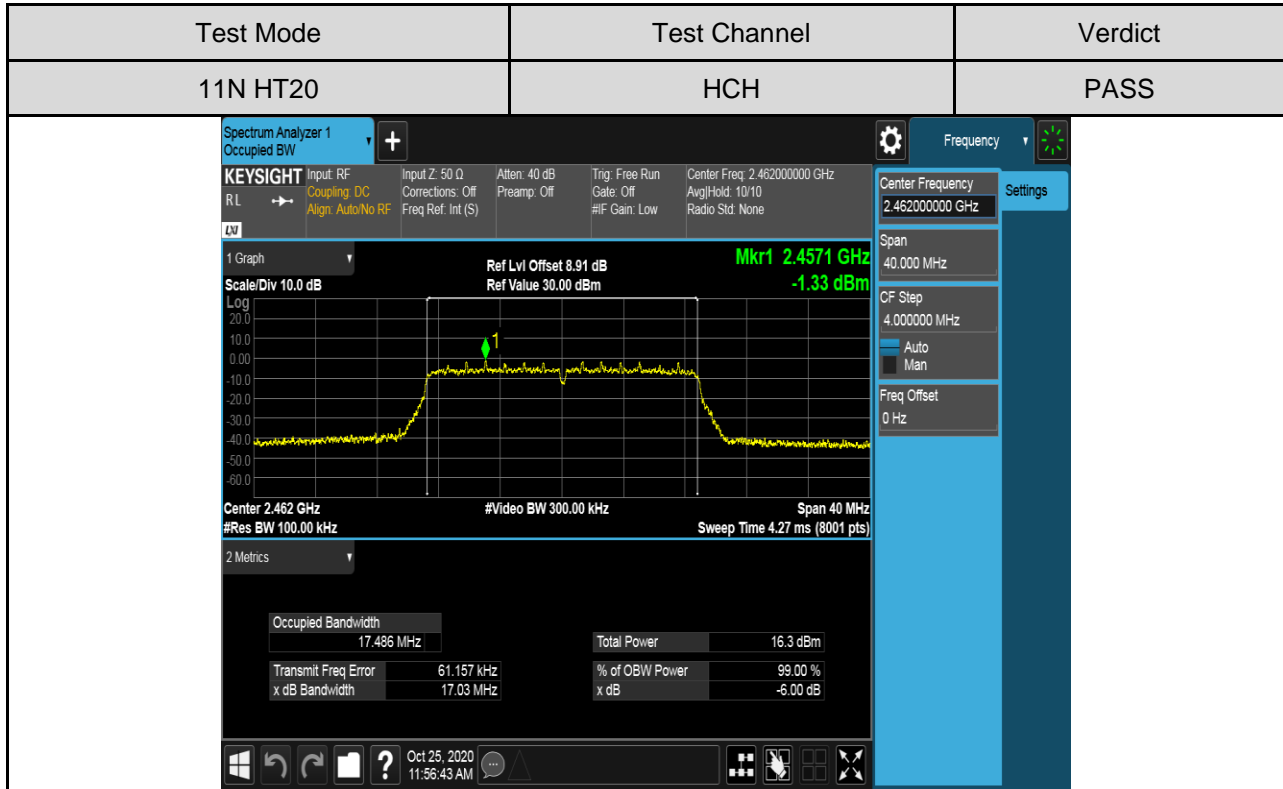

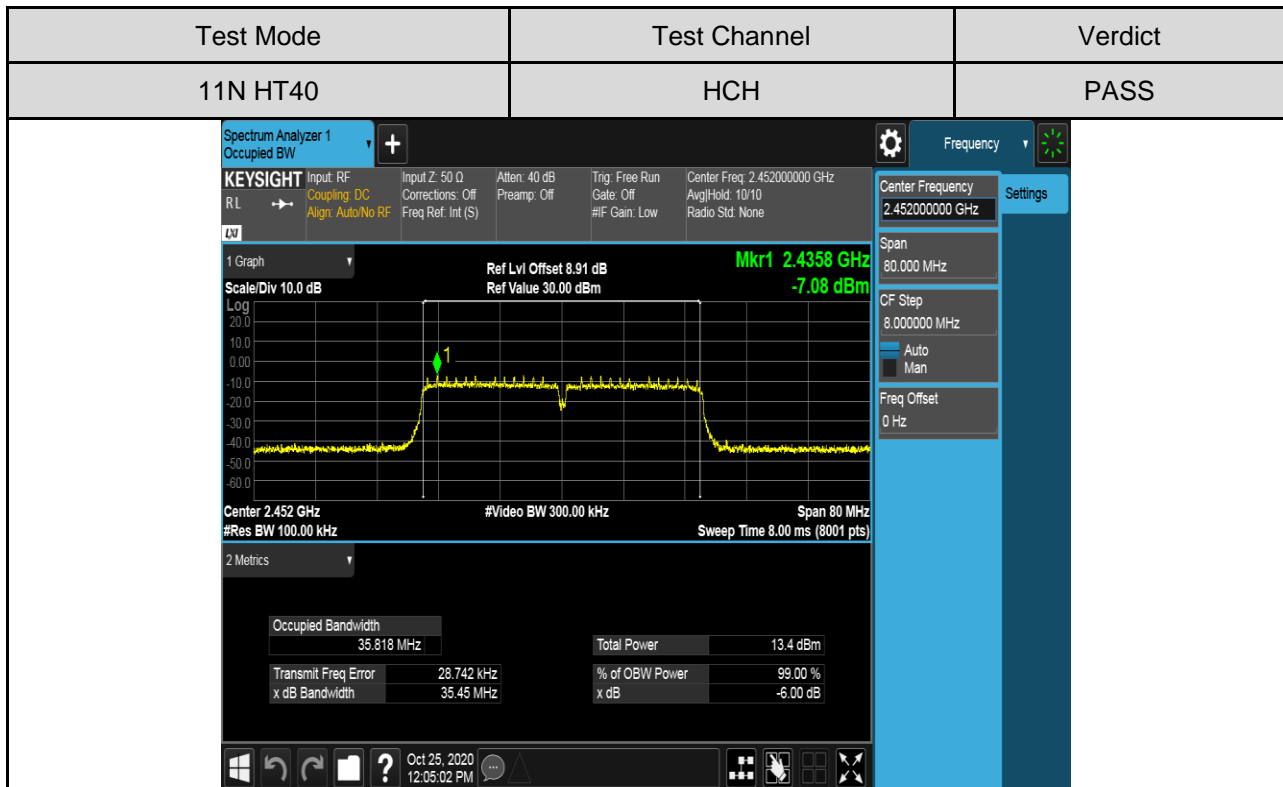
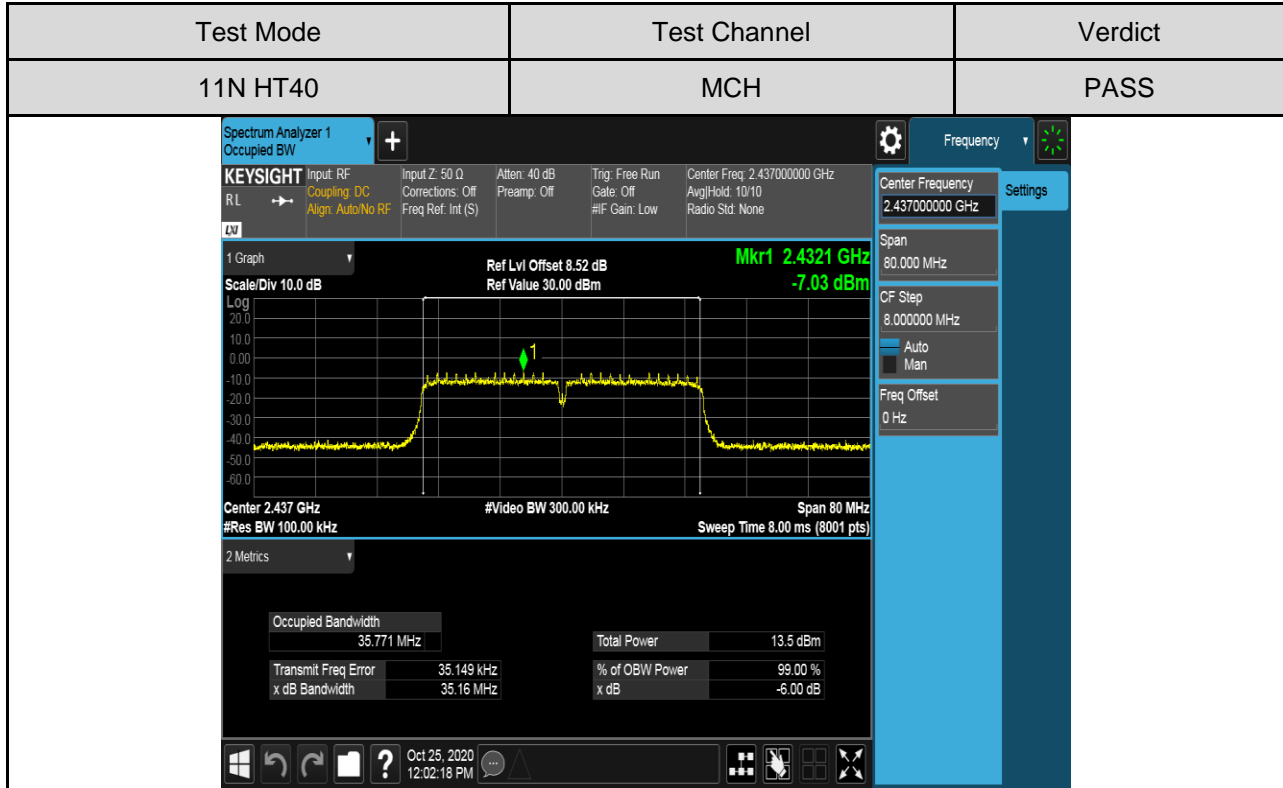

### 7.3. CONDUCTED POWER

#### LIMITS

FCC Part15 (15.247) , Subpart C			
Section	Test Item	Limit	Frequency Range (MHz)
FCC 15.247(b)(3)	Output Power	1 watt or 30dBm	2400-2483.5

#### TEST PROCEDURE

Place the EUT on the table and set it in the transmitting mode.  
Remove the antenna from the EUT and then connect a low loss RF cable from the antenna port to the Power sensor.  
Measure the power of each channel.  
Peak Detector use for Peak result.  
AVG Detector use for AVG result.

#### TEST SETUP

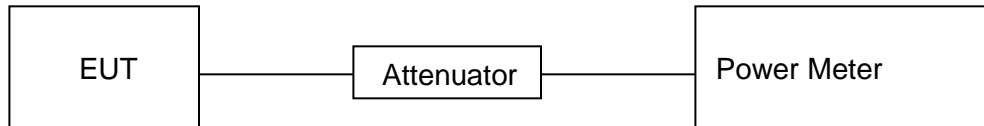



**RESULTS**

Test Mode	Test Channel	Maximum Conducted Output Power (PK)	Maximum Conducted Output Power (AV)	Result
		dBm	dBm	
11B	LCH	18.35	15.32	Pass
	MCH	17.77	14.73	Pass
	HCH	17.24	14.23	Pass
11G	LCH	18.25	10.60	Pass
	MCH	18.03	10.24	Pass
	HCH	17.86	10.00	Pass
11N HT20	LCH	19.03	11.03	Pass
	MCH	18.10	10.15	Pass
	HCH	17.61	9.66	Pass
11N HT40	LCH	N/A	7.04	Pass
	MCH	N/A	6.72	Pass
	HCH	N/A	6.70	Pass

## 7.4. POWER SPECTRAL DENSITY

### LIMITS

FCC Part15 (15.247) , Subpart C			
Section	Test Item	Limit	Frequency Range (MHz)
FCC §15.247 (e)	Power Spectral Density	8 dBm in any 3 kHz band	2400-2483.5

### TEST PROCEDURE

Refer to FCC KDB 558074, connect the UUT to the spectrum analyser and use the following settings:

Center Frequency	The centre frequency of the channel under test
Detector	Peak
RBW	$3 \text{ kHz} \leq \text{RBW} \leq 100 \text{ kHz}$
VBW	$\geq 3 \times \text{RBW}$
Span	1.5 x DTS bandwidth
Trace	Max hold
Sweep time	Auto couple.

Allow trace to fully stabilize and use the peak marker function to determine the maximum amplitude level within the RBW.

If measured value exceeds limit, reduce RBW (no less than 3 kHz) and repeat.

### TEST ENVIRONMENT

Temperature	22°C	Relative Humidity	56%
Atmosphere Pressure	101kPa	Test Voltage	AC 120V

### TEST SETUP

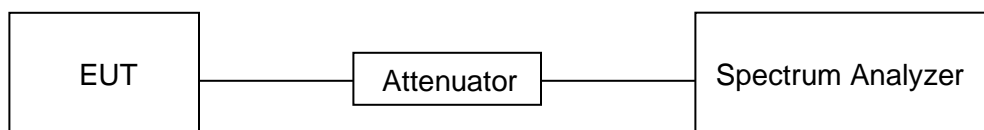



**RESULTS**

Test Mode	Test Channel	Maximum Peak power spectral density (dBm/30kHz)	Result
11B	LCH	2.48	Pass
	MCH	1.31	Pass
	HCH	1.21	Pass
11G	LCH	-5.20	Pass
	MCH	-5.97	Pass
	HCH	-6.01	Pass
11N HT20	LCH	-5.19	Pass
	MCH	-5.14	Pass
	HCH	-6.21	Pass
11N HT40	LCH	-11.27	Pass
	MCH	-11.51	Pass
	HCH	-11.55	Pass



**Test Graphs:**

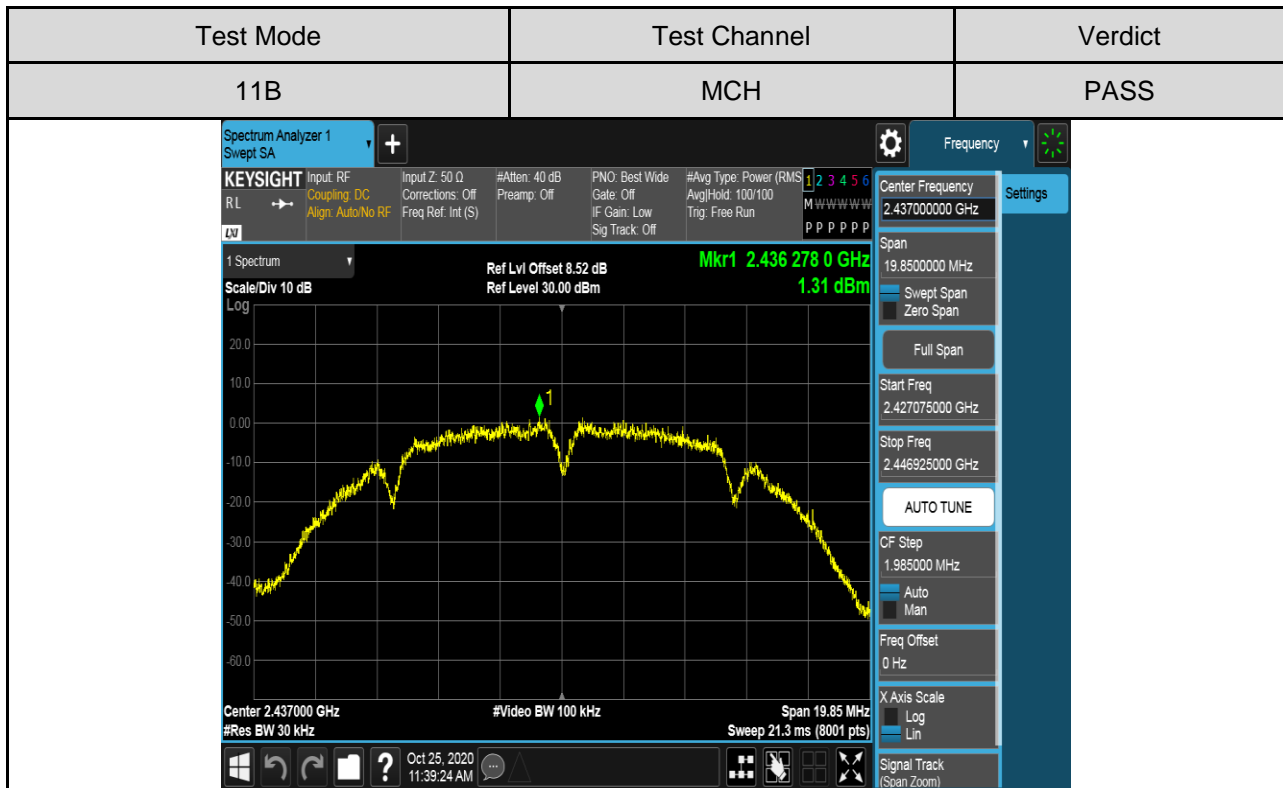
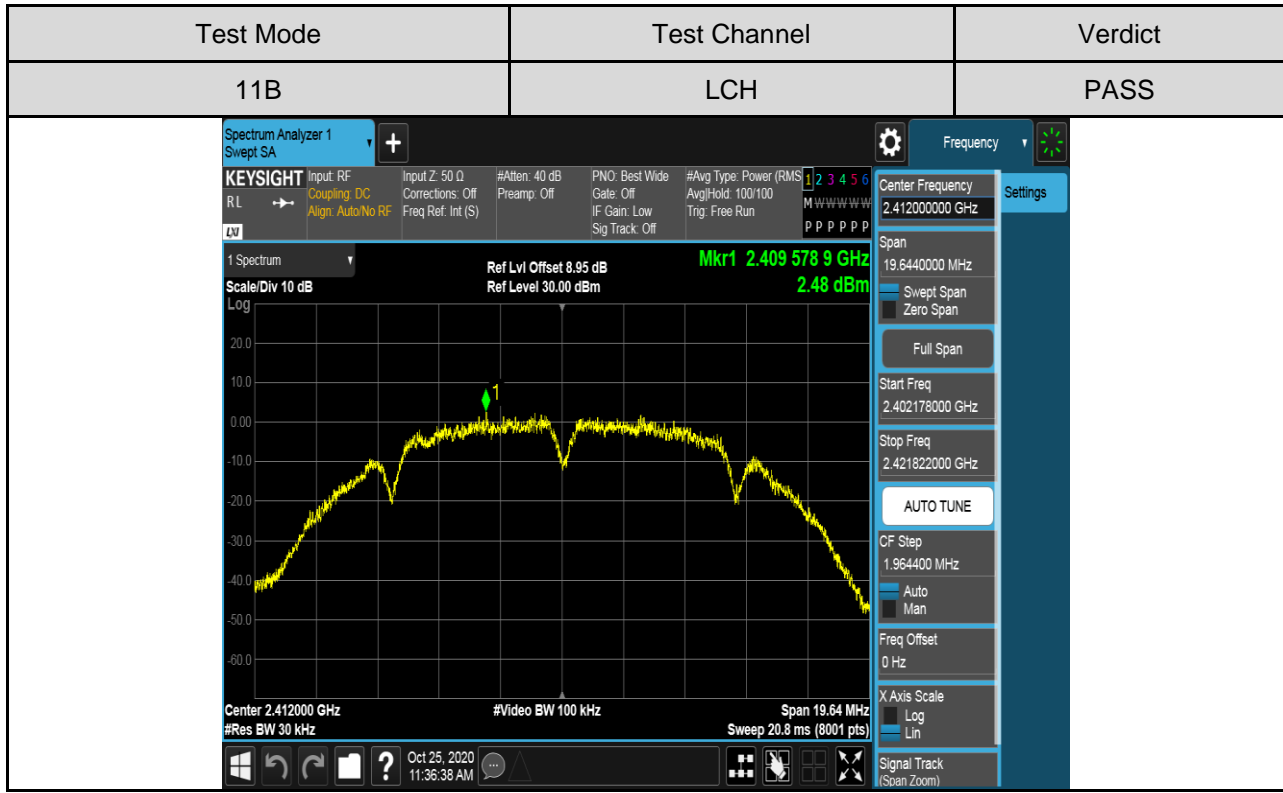

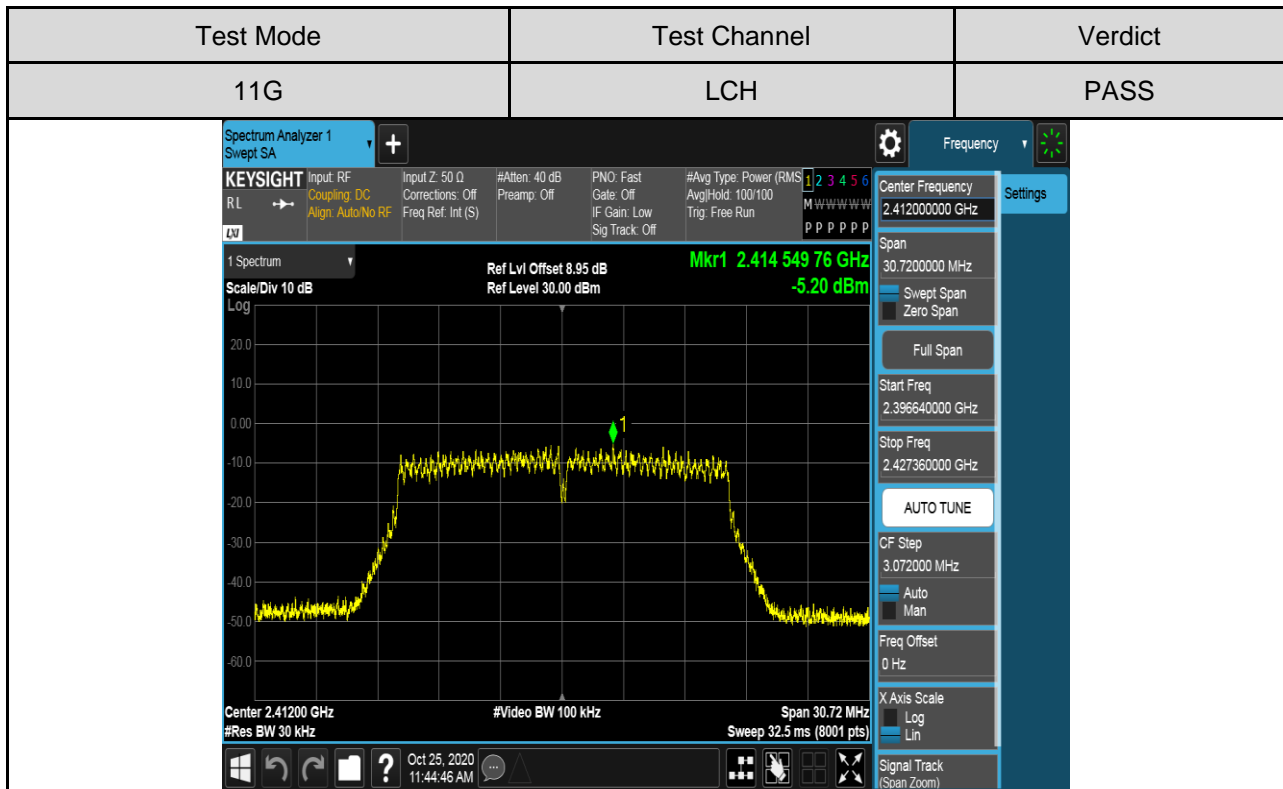
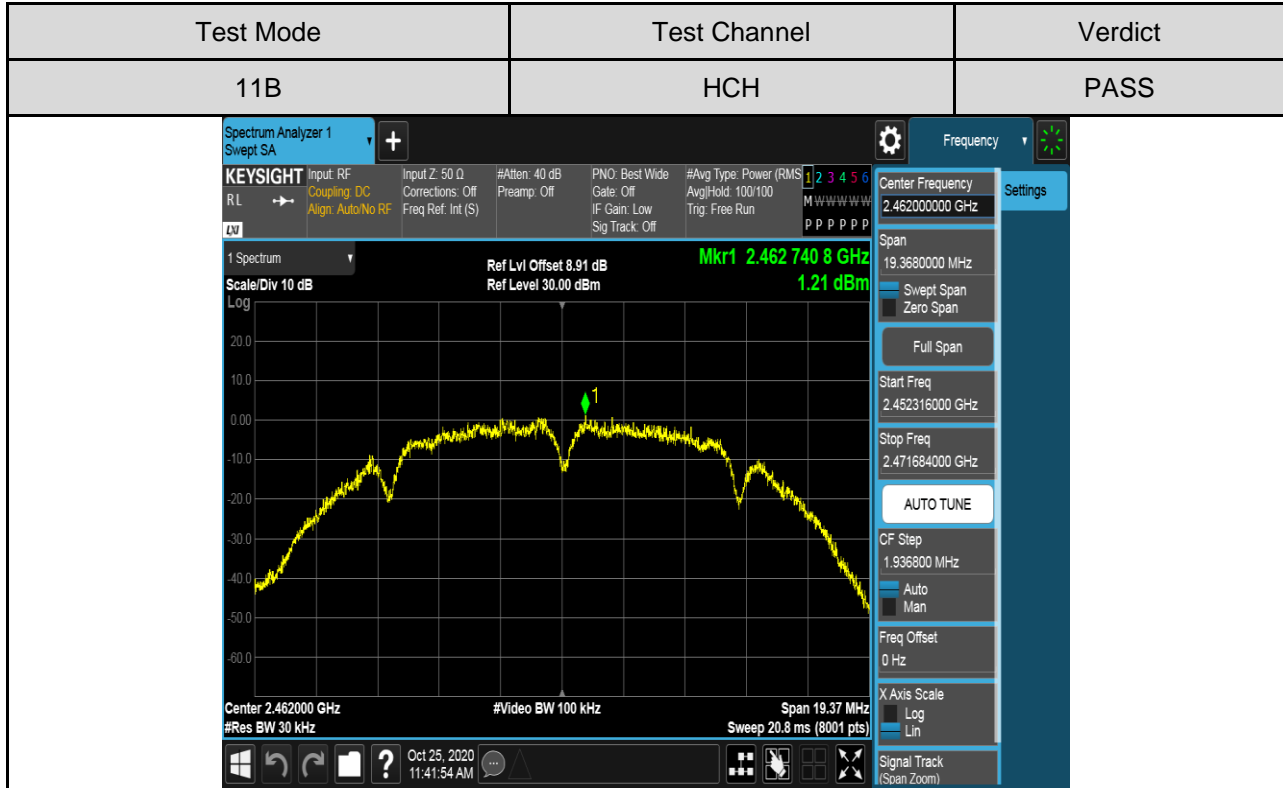



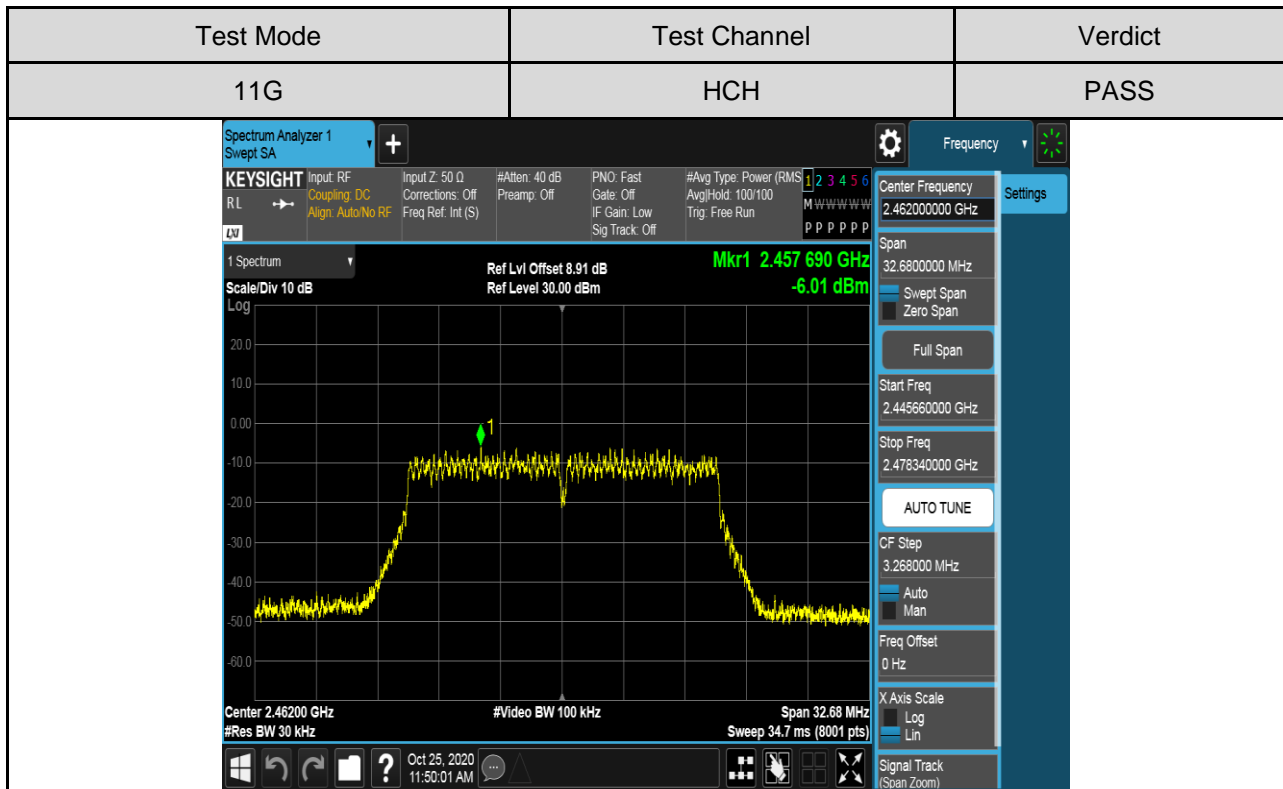
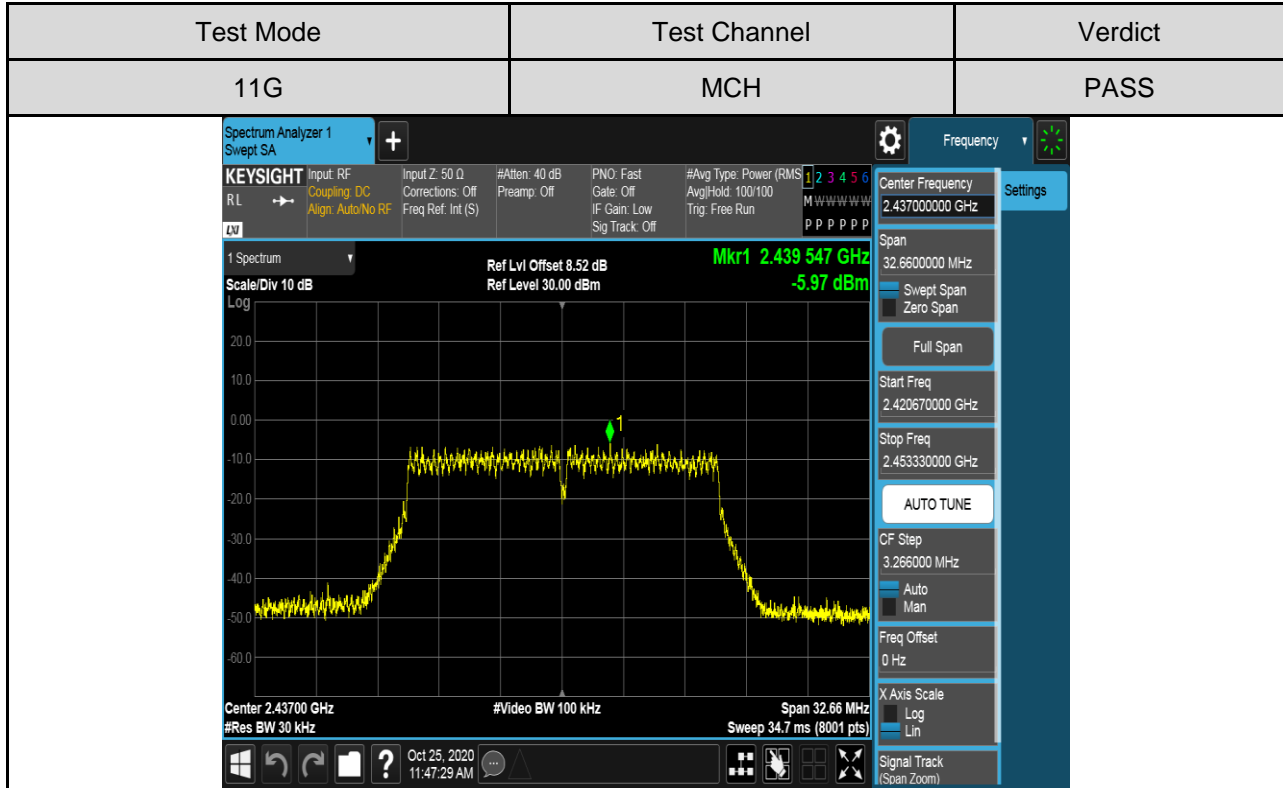

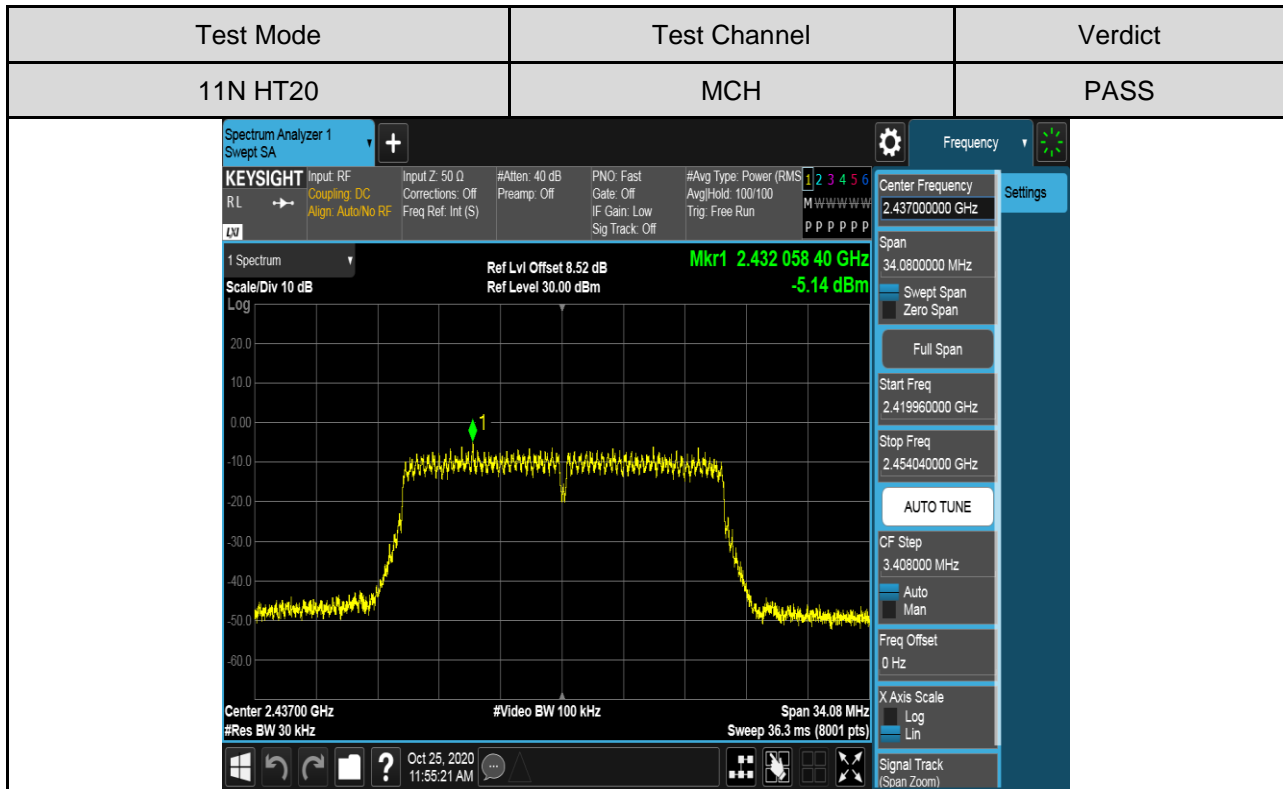
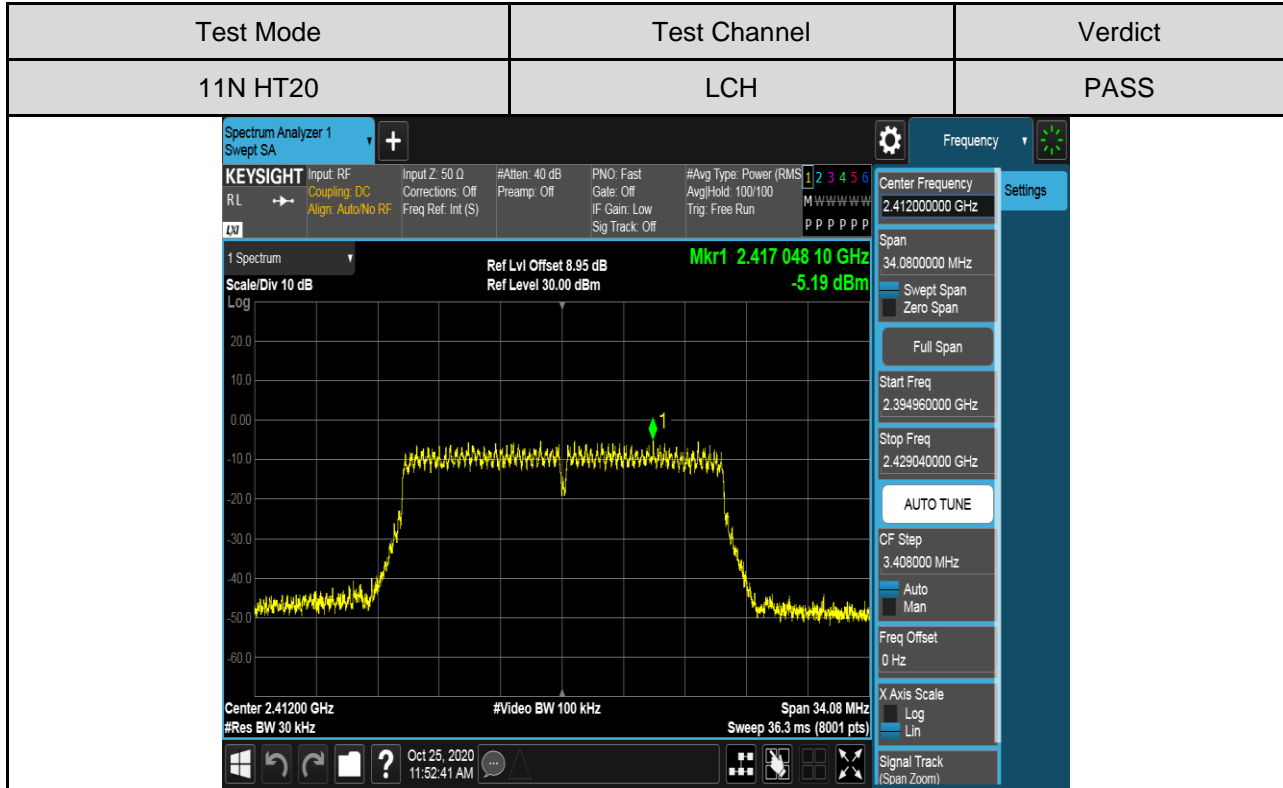

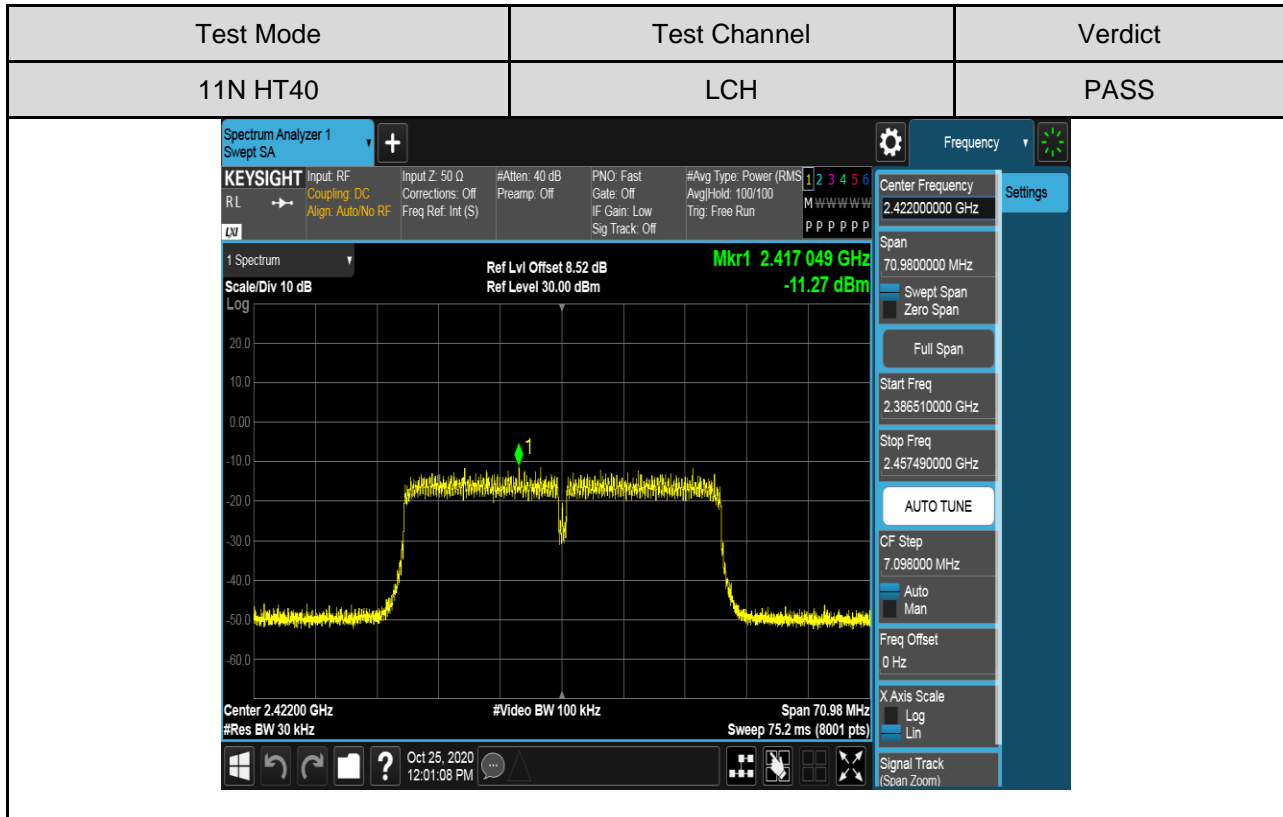
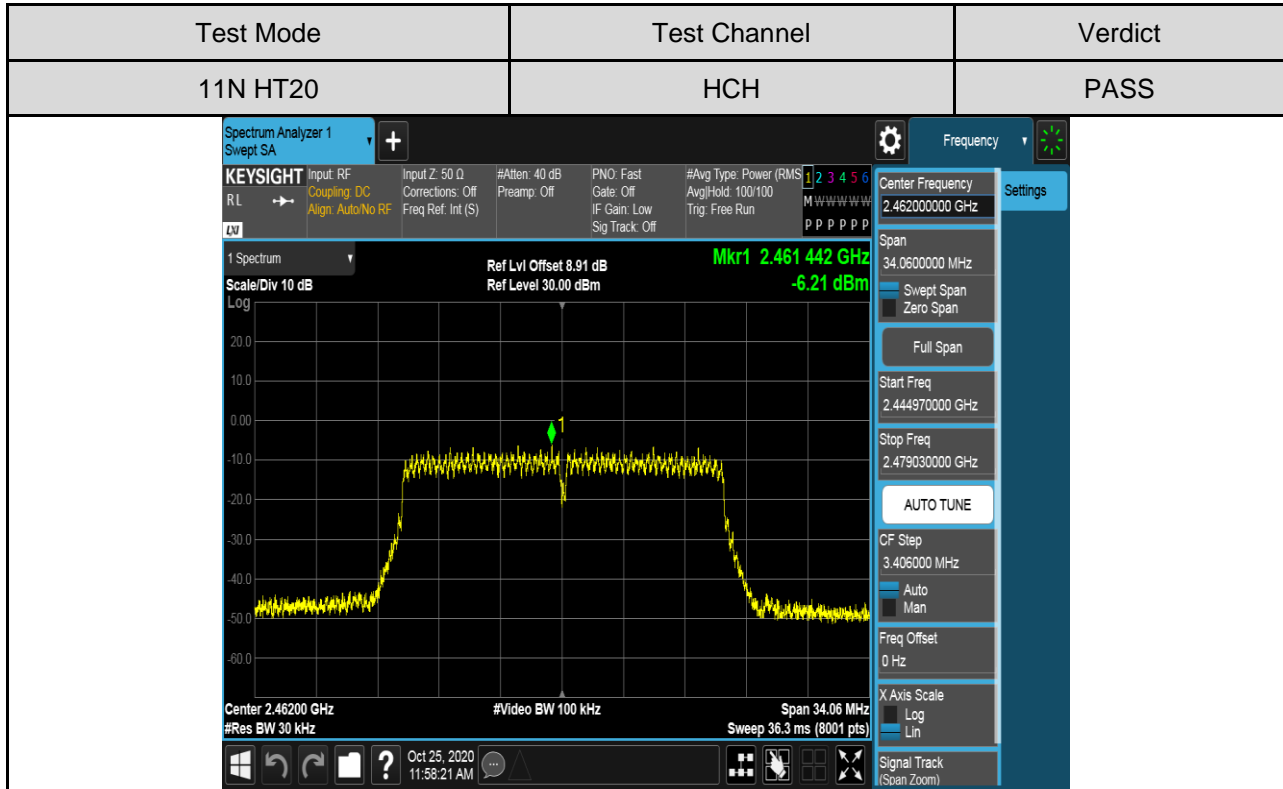

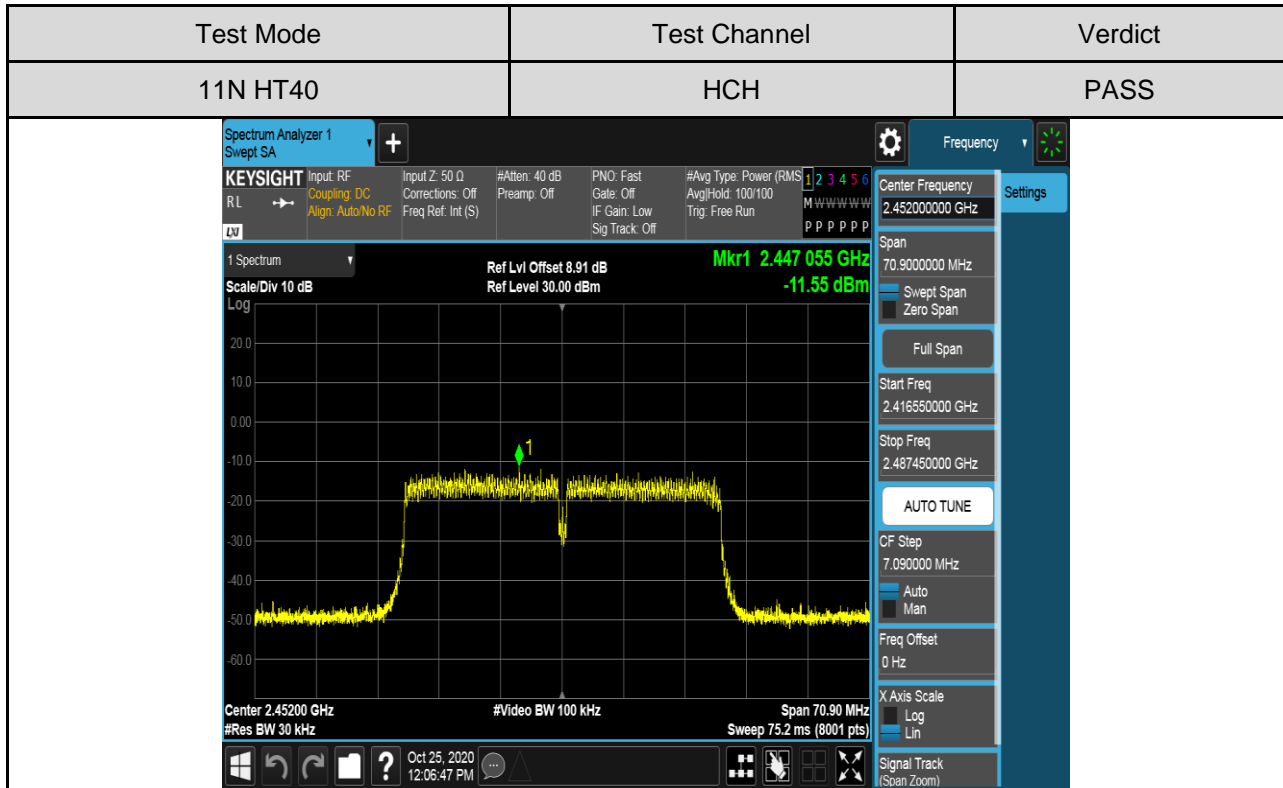
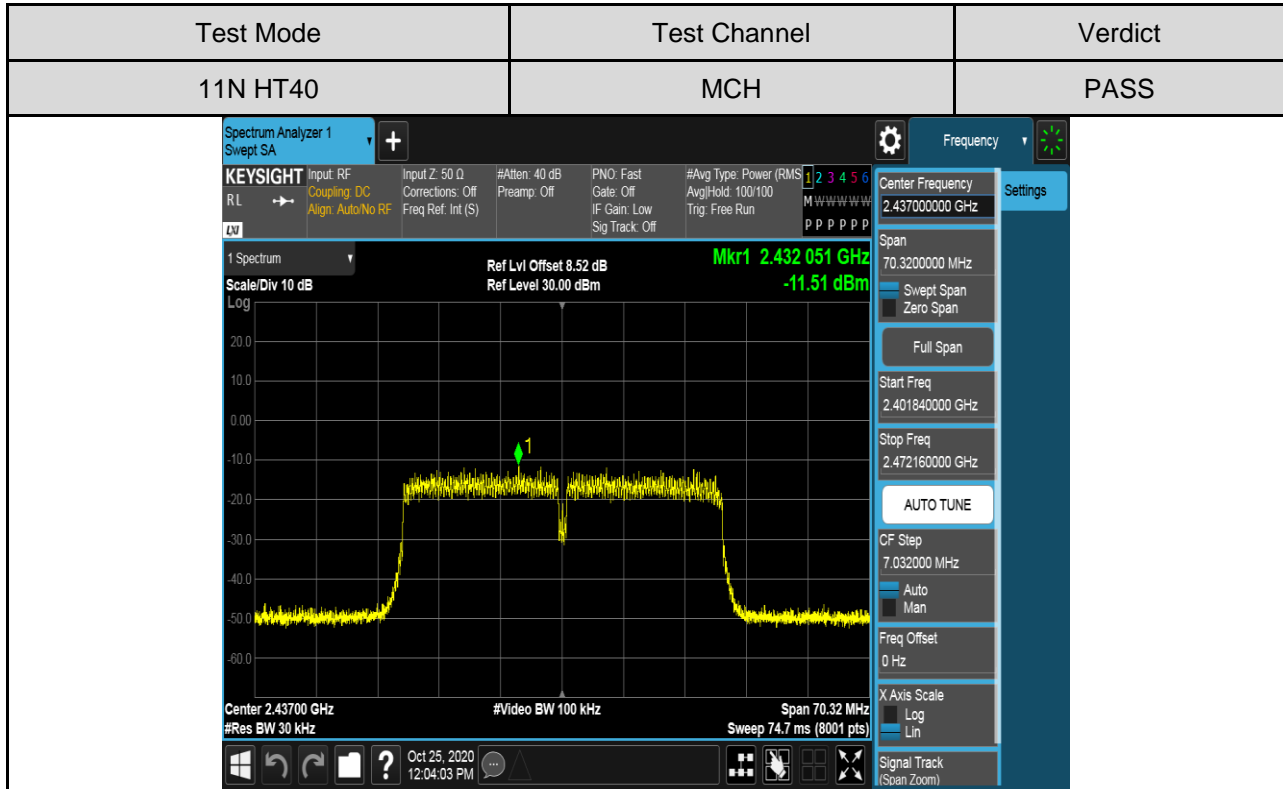



## 7.5. CONDUCTED BANDEGE AND SPURIOUS EMISSIONS

### LIMITS

FCC Part15 (15.247) , Subpart C		
Section	Test Item	Limit
FCC §15.247 (d)	Conducted Bandedge and Spurious Emissions	1) For 11B, 11G and 11N HT20 modes: at least 20 dB below that in the 100 kHz bandwidth within the band that contains the highest level of the desired power; 2) For 11N HT40 mode: at least 30 dB below that in the 100 kHz bandwidth within the band that contains the highest level of the desired power

### TEST PROCEDURE

Refer to FCC KDB 558074, connect the UUT to the spectrum analyser and use the following

Center Frequency	The centre frequency of the channel under test
Detector	Peak
RBW	100K
VBW	$\geq 3 \times \text{RBW}$
Span	1.5 x DTS bandwidth
Trace	Max hold
Sweep time	Auto couple.

settings:

Use the peak marker function to determine the maximum PSD level.

Span	Set the center frequency and span to encompass frequency range to be measured
Detector	Peak
RBW	100K
VBW	$\geq 3 \times \text{RBW}$
measurement points	$\geq \text{span}/\text{RBW}$
Trace	Max hold
Sweep time	Auto couple.

Use the peak marker function to determine the maximum amplitude level.



TEST SETUP

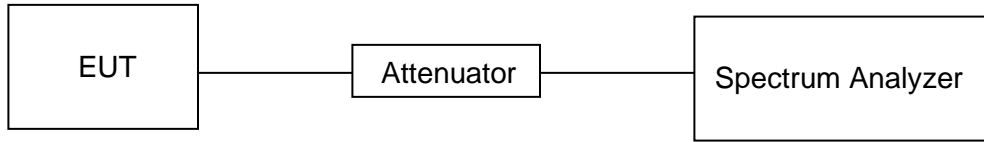



**TEST ENVIRONMENT**

Temperature	22°C	Relative Humidity	56%
Atmosphere Pressure	101kPa	Test Voltage	AC 120V



**Part I :Conducted Bandedge**

**RESULTS TABLE**

Test Mode	Test Channel	Carrier Power[dBm]	Max. Spurious Level [dBm]	Limit [dBm]	Verdict
11B	LCH	6.698	-40.86	-13.30	PASS
	HCH	5.019	-40.96	-14.98	PASS
11G	LCH	-0.139	-40.53	-20.14	PASS
	HCH	-1.316	-40.69	-21.32	PASS
11N HT20	LCH	-0.052	-41.27	-20.05	PASS
	HCH	-1.338	-40.89	-21.34	PASS
11N HT40	LCH	-7.045	-41.25	-37.05	PASS
	HCH	-7.124	-41.41	-37.12	PASS





TEST GRAPHS

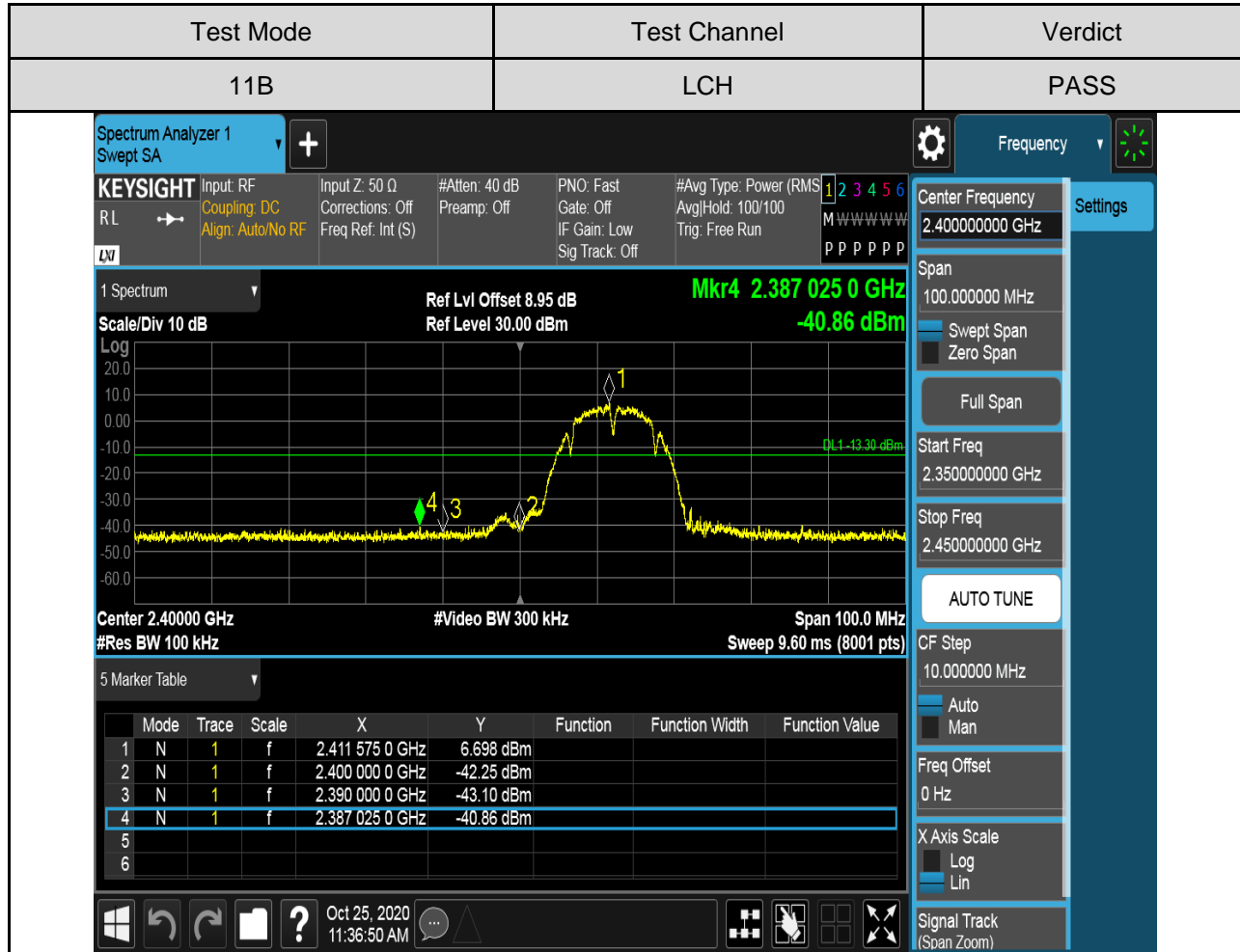

Test Mode	Test Channel	Verdict
11B	HCH	PASS

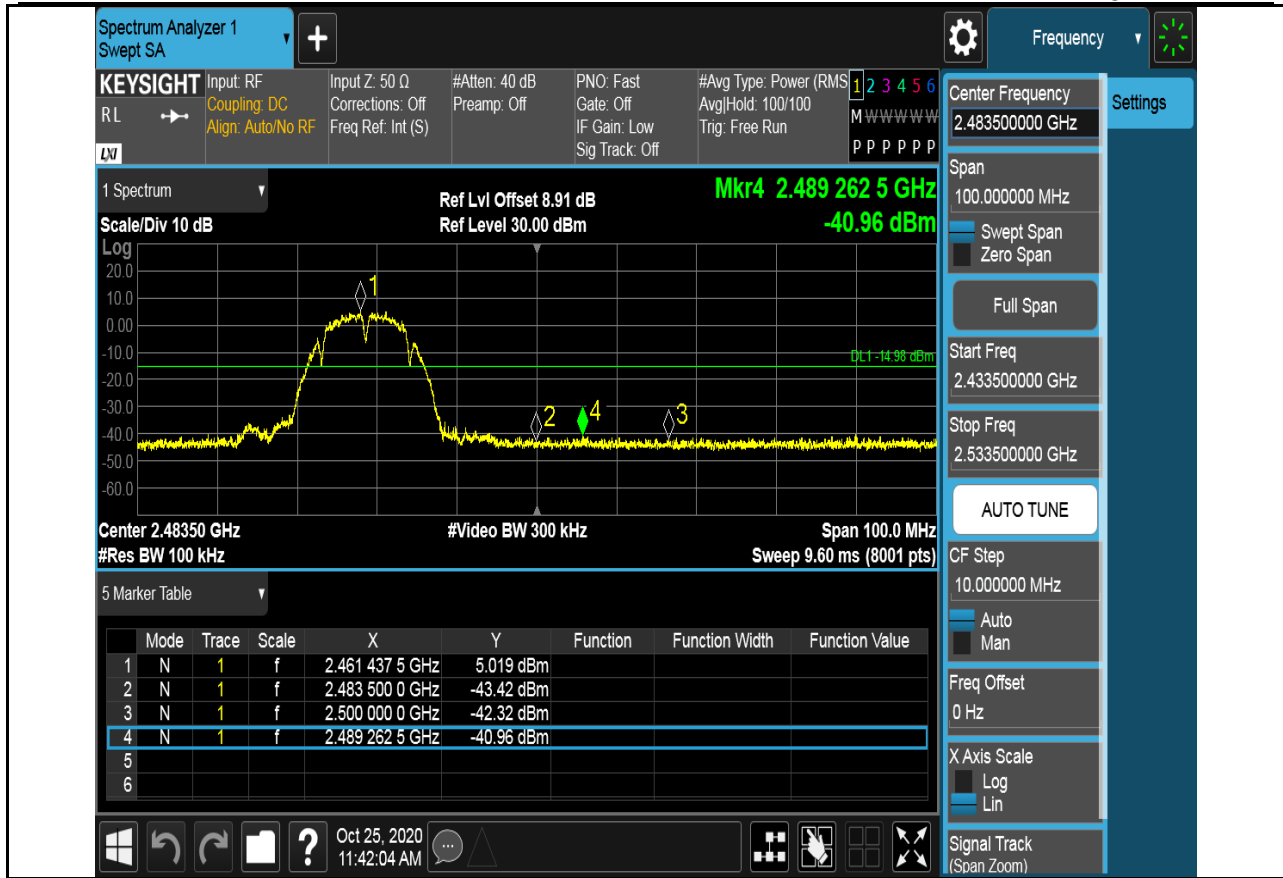

Test Mode	Test Channel	Verdict
11G	LCH	PASS

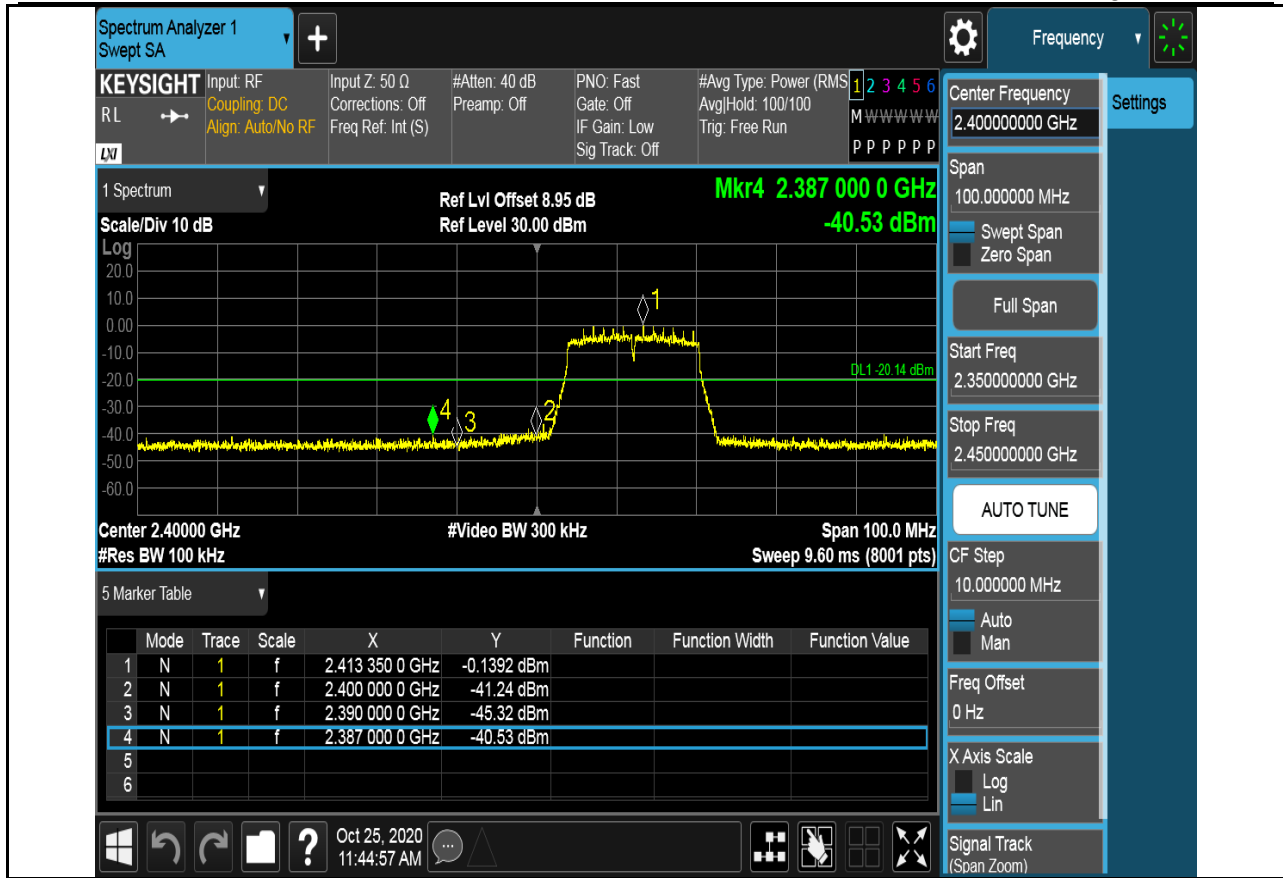

Test Mode	Test Channel	Verdict
11G	HCH	PASS

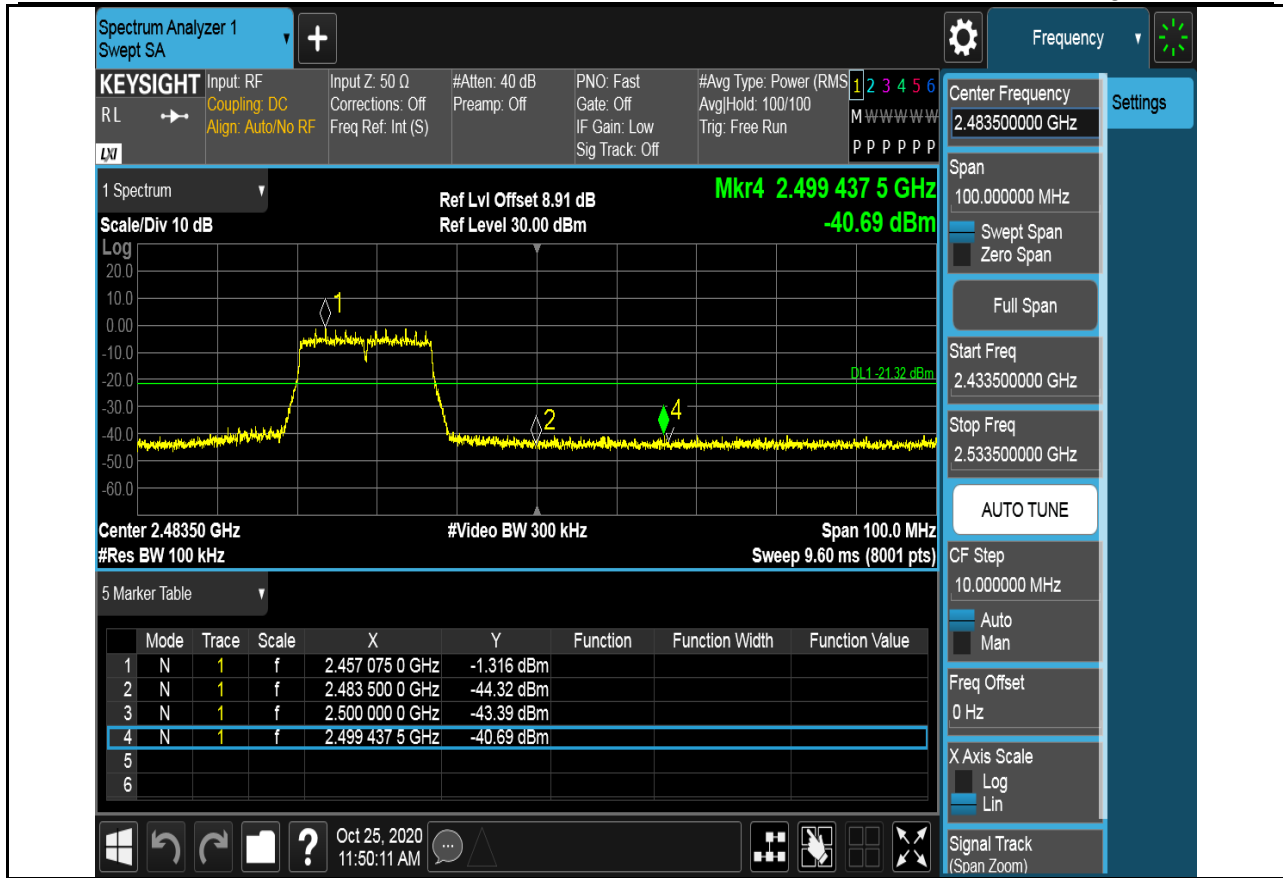

Test Mode	Test Channel	Verdict
11N HT20	LCH	PASS

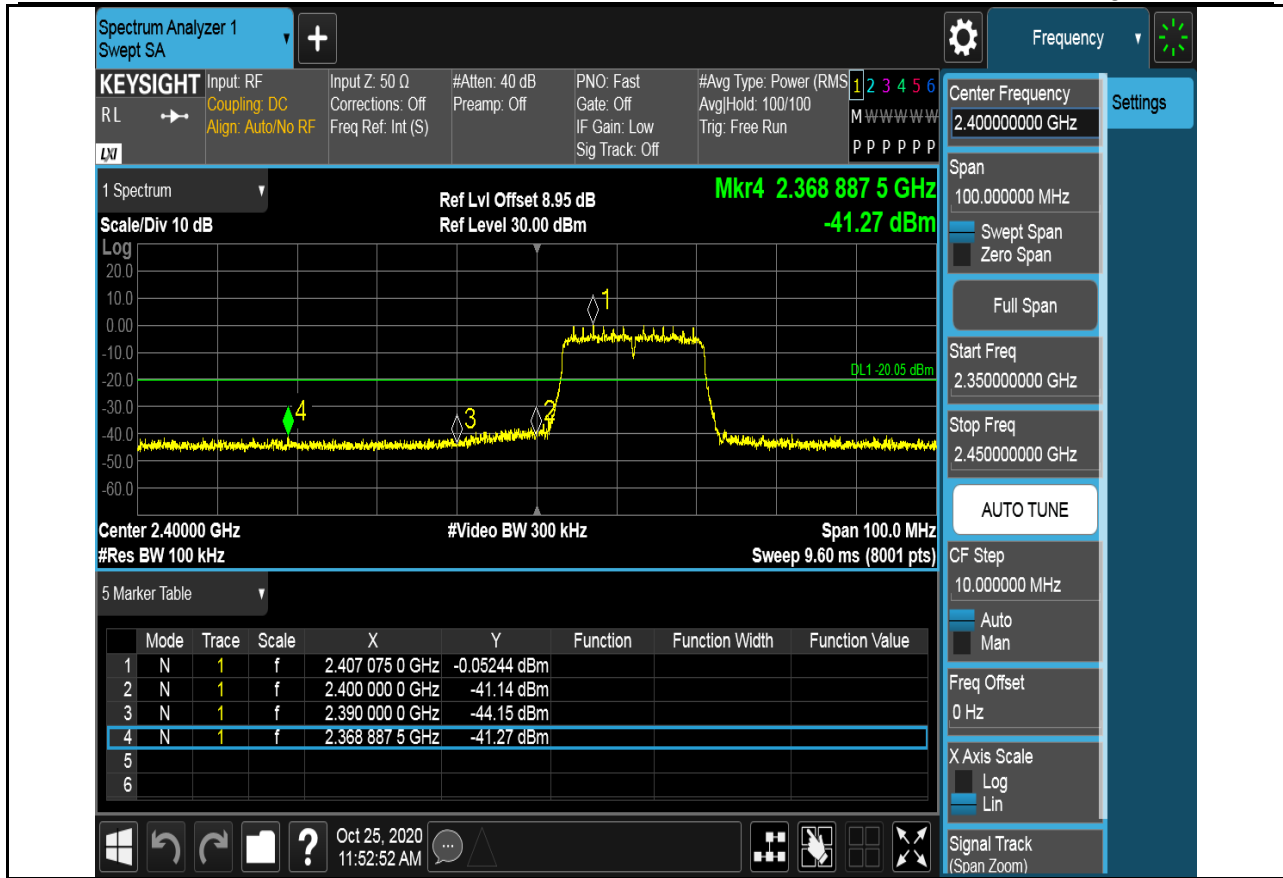

Test Mode	Test Channel	Verdict
11N HT20	HCH	PASS

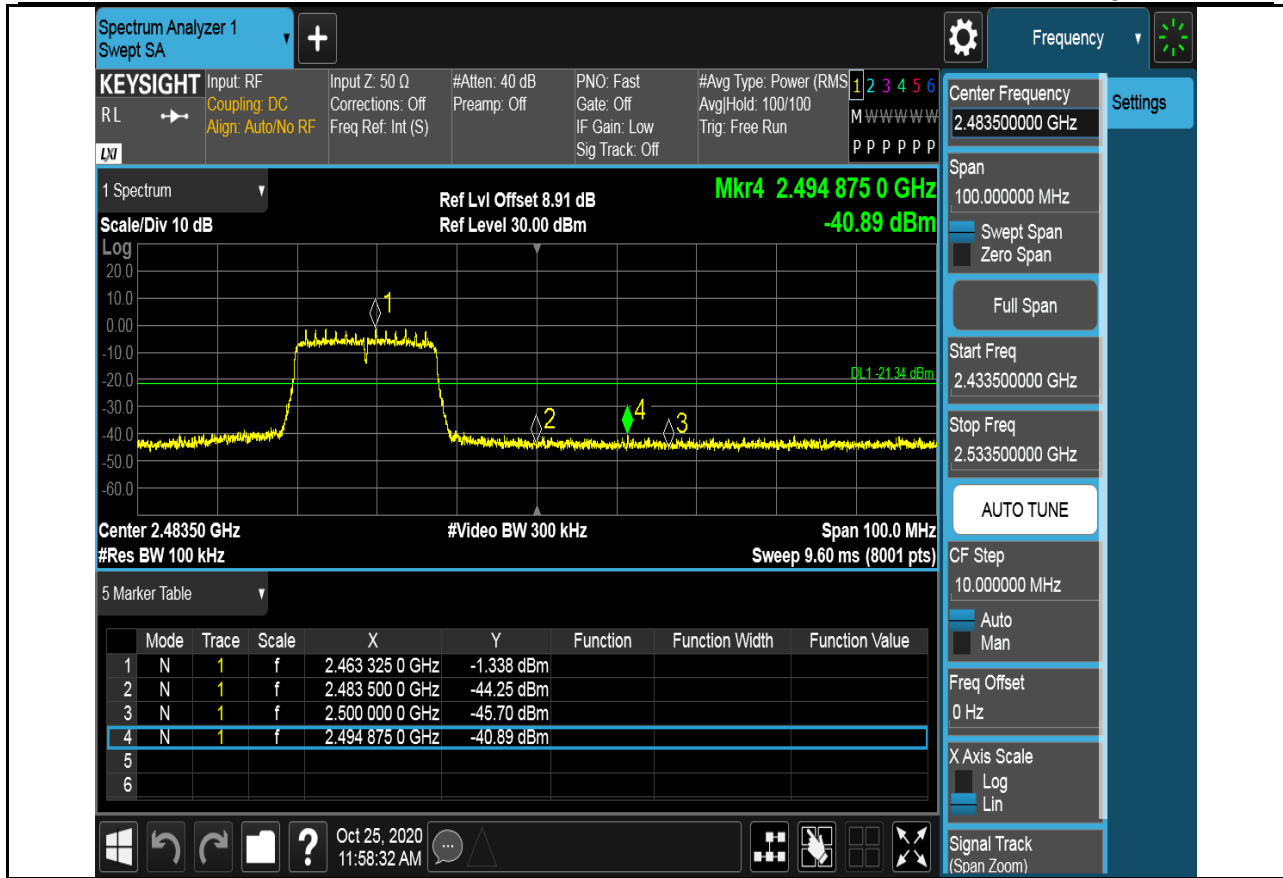

Test Mode	Test Channel	Verdict
11N HT40	LCH	PASS

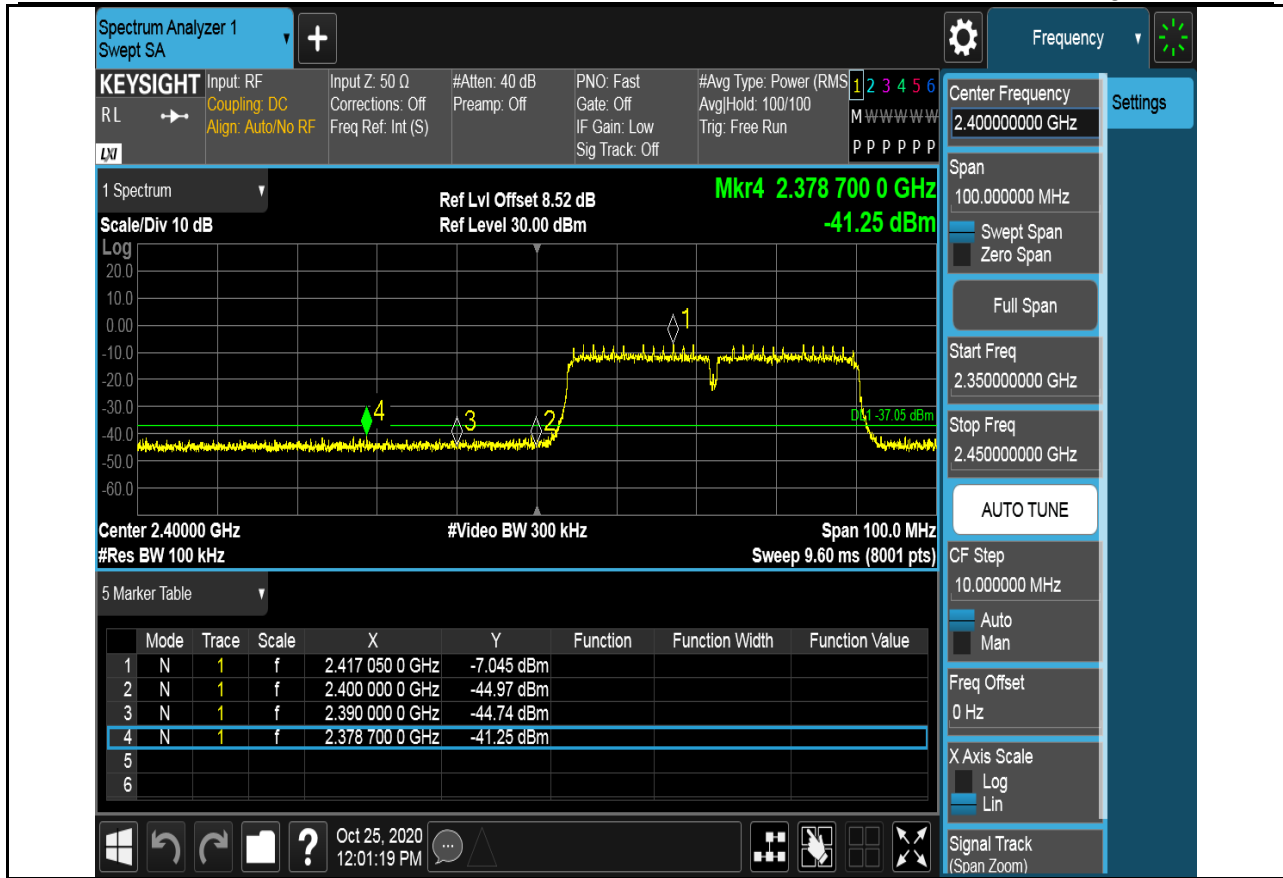

Test Mode	Test Channel	Verdict
11N HT40	HCH	PASS

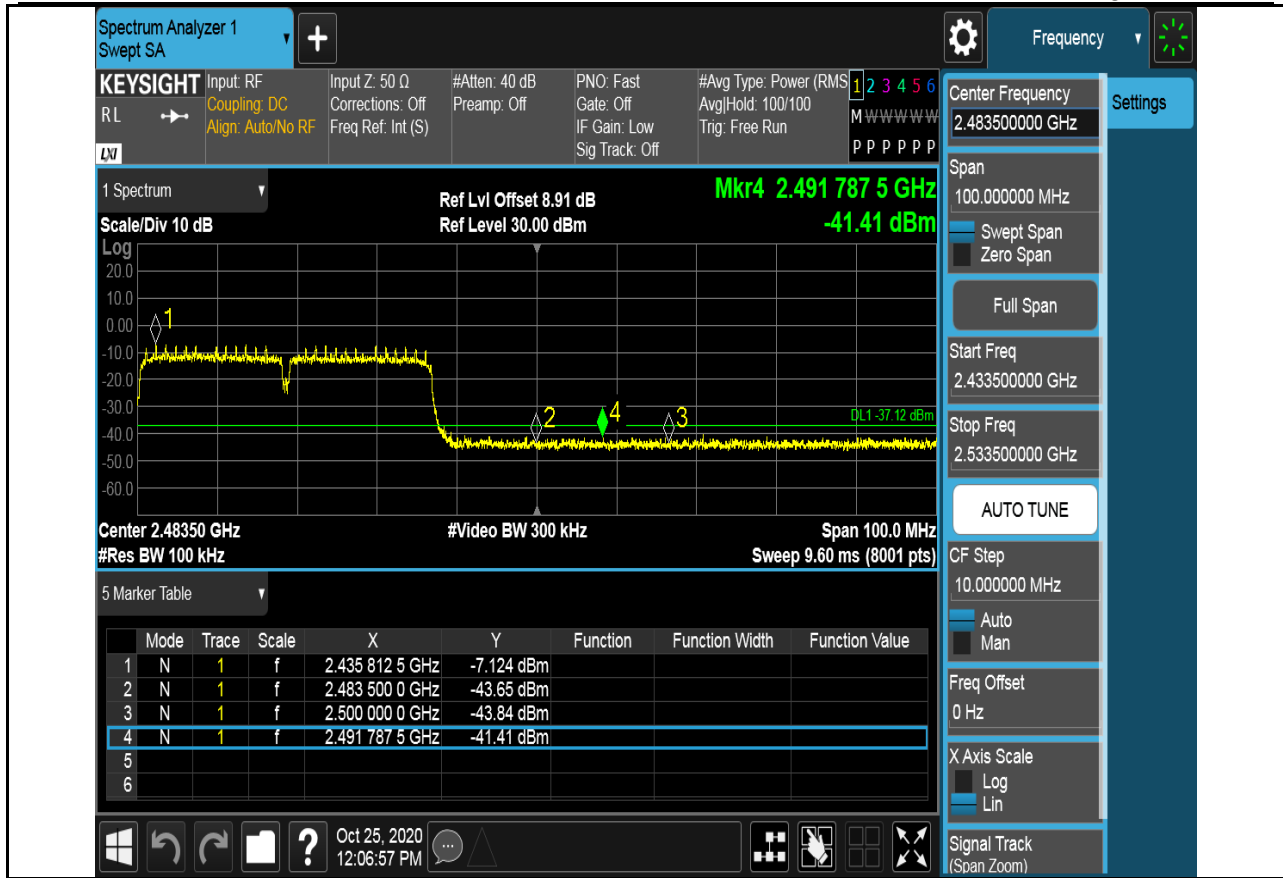





**Part II :Conducted Emission**

Test Result Table

Test Mode	Test Antenna	Channel	Pref(dBm)	Puw(dBm)	Verdict
11B	Antenna 1	LCH	6.61	<Limit	PASS
		MCH	5.54	<Limit	PASS
		HCH	4.83	<Limit	PASS
11G	Antenna 1	LCH	-0.02	<Limit	PASS
		MCH	-0.91	<Limit	PASS
		HCH	-1.20	<Limit	PASS
11N HT20	Antenna 1	LCH	-0.02	<Limit	PASS
		MCH	-0.91	<Limit	PASS
		HCH	-1.43	<Limit	PASS
11N HT20	Antenna 1	LCH	-7.04	<Limit	PASS
		MCH	-7.18	<Limit	PASS
		HCH	-7.27	<Limit	PASS



**Test Plots**

Test Mode	Channel	Verdict
11B	LCH	PASS

**Pref test Plot**





Puw test Plot

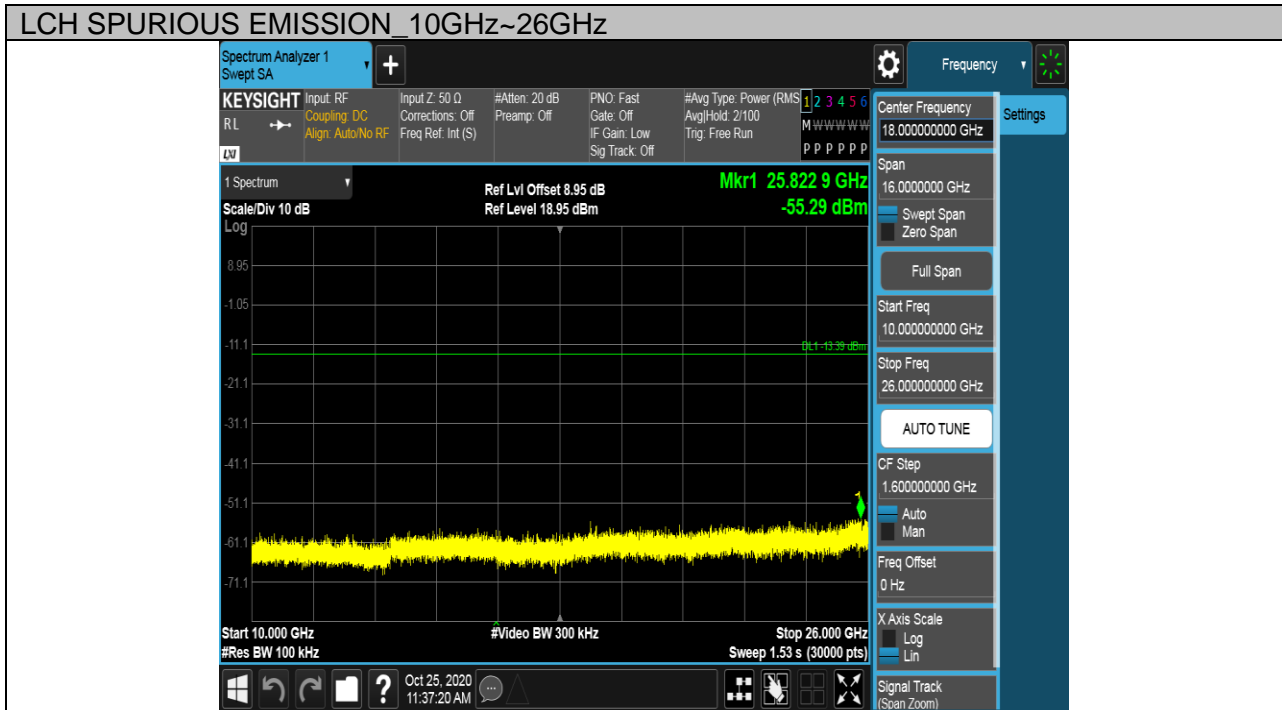
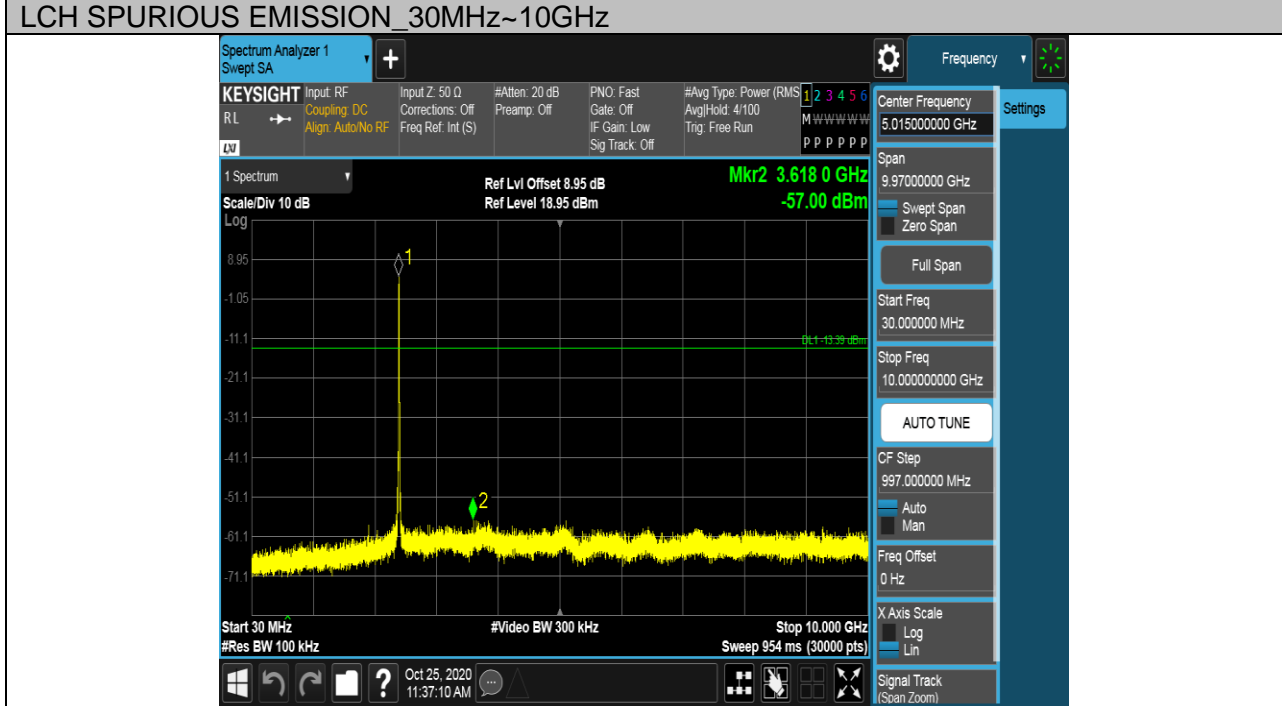



Test Mode	Channel	Verdict
11B	MCH	PASS

Pref test Plot





Puw test Plot

MCH SPURIOUS EMISSION\_30MHz~10GHz

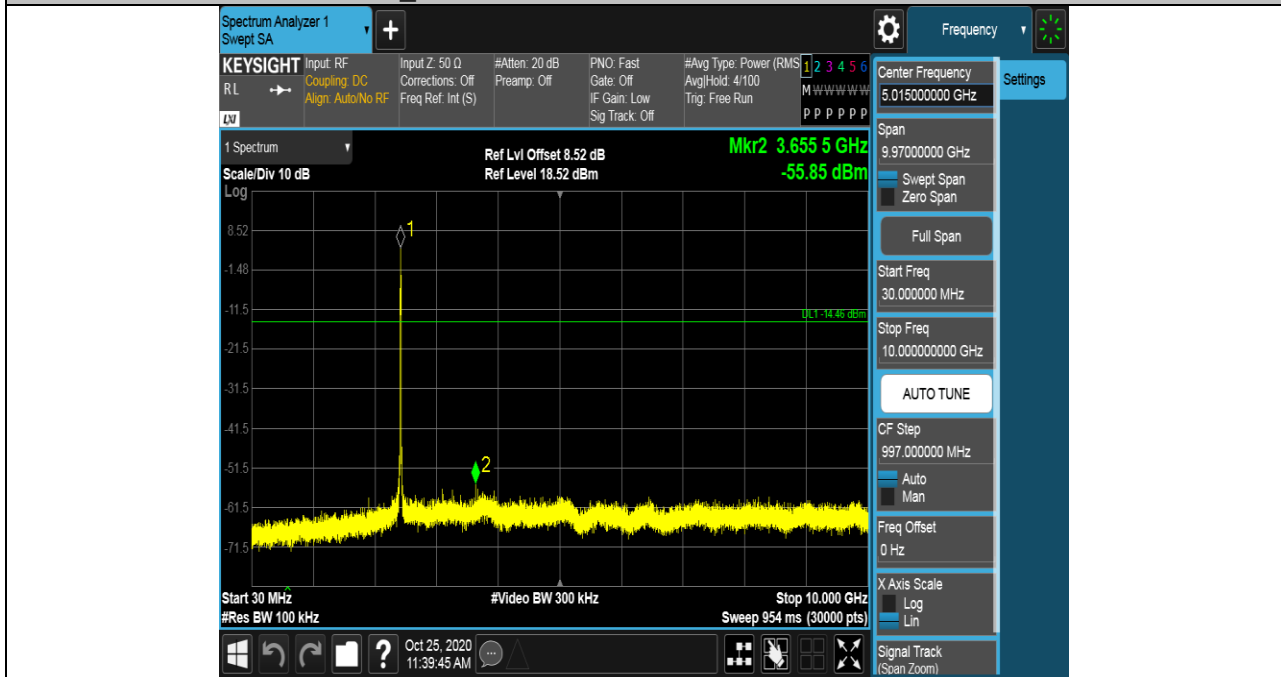

MCH SPURIOUS EMISSION\_10GHz~26GHz

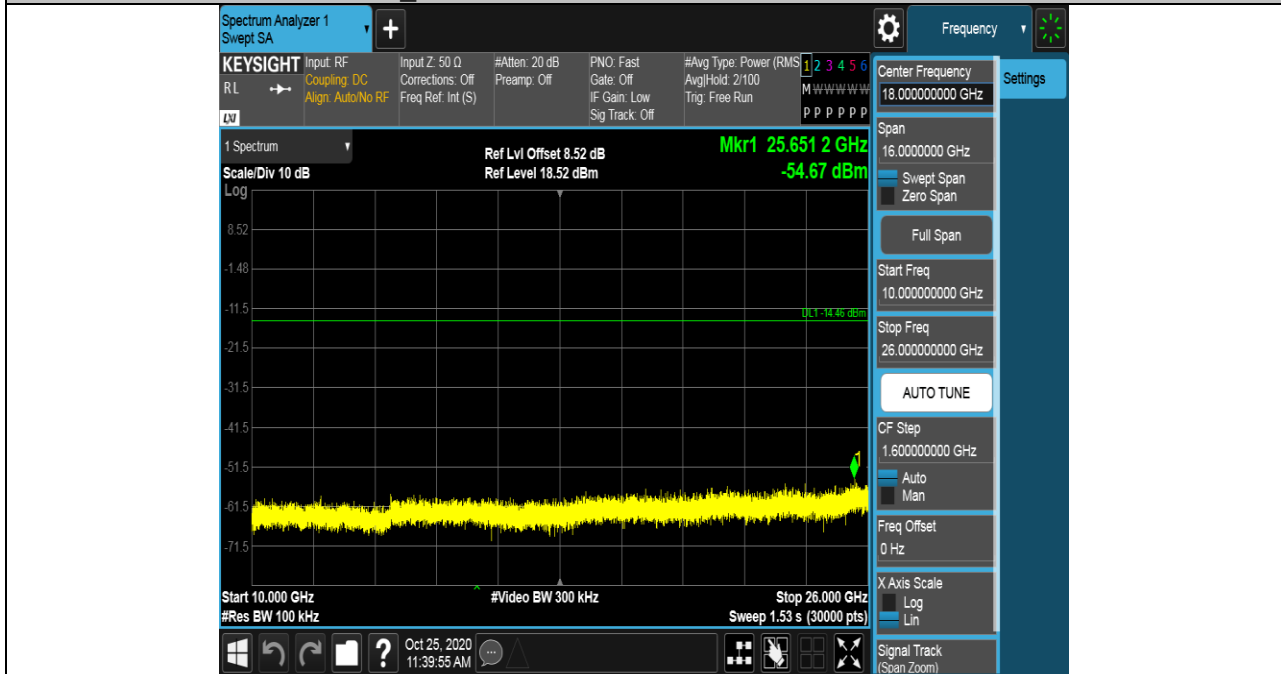



Test Mode	Channel	Verdict
11B	HCH	PASS

Pref test Plot





Puw test Plot

HCH SPURIOUS EMISSION\_30MHz~10GHz

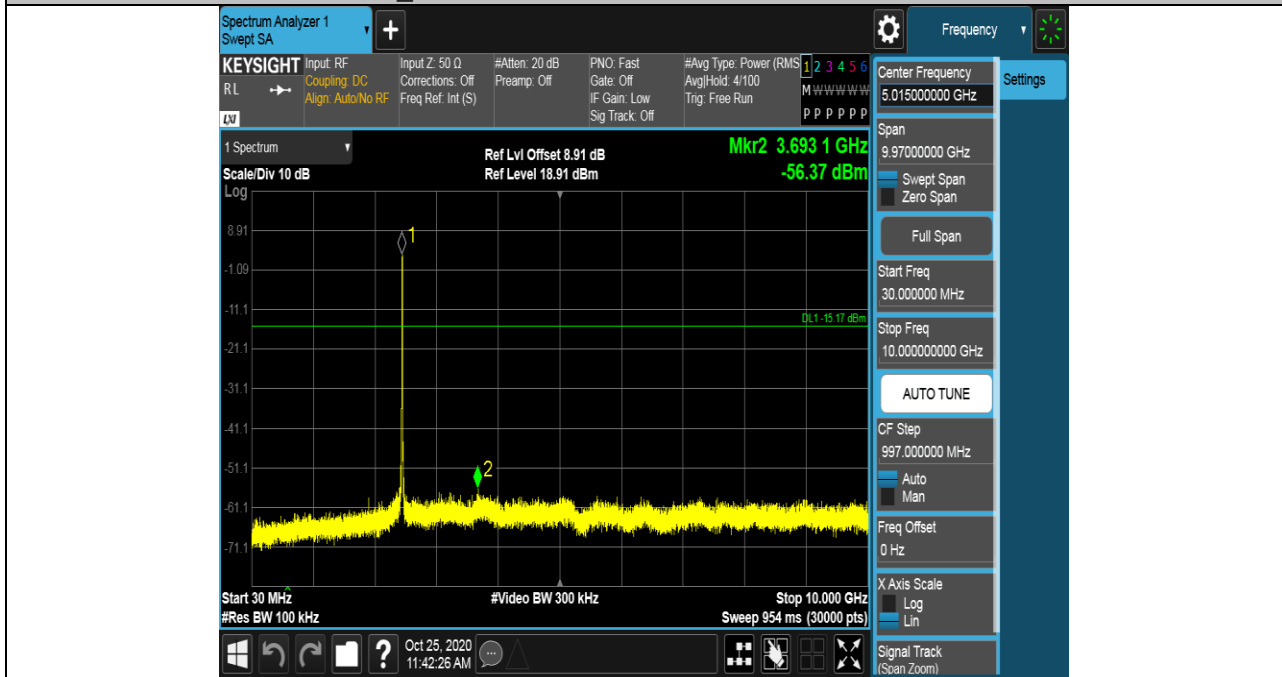

HCH SPURIOUS EMISSION\_10GHz~26GHz

