



FCC 47 CFR PART 15 SUBPART C

CERTIFICATION TEST REPORT

For

CONSUMER CAMERA

MODEL NUMBER: IPC-F42FP

**ADDITIONAL MODEL NUMBER: IPC-TF42F-LC; IPC-F42F-LC; IPC-F42FP-imou;
IPC-F42FN-imou; IPC-F42FN; IPC-F42F; LC-TF2F-4M; LC-A32F-4M; F42F;
IPC-TF42F-0280B-LC; IPC-TF42F-0360B-LC; IPC-TF42F-0600B-LC; IPC-F42F-
0280B-LC; IPC-F42F-0360B-LC; IPC-F42F-0600B-LC; IPC-F42FP-0280B-imou;
IPC-F42FP-0360B-imou; IPC-F42FP-0600B-imou; IPC-F42FN-0280B-imou;
IPC-F42FN-0360B-imou; IPC-F42FN-0600B-imou; IPC-F42FP-0280B; IPC-F42FP-
0360B; IPC-F42FP-0600B; IPC-F42FN-0280B; IPC-F42FN-0360B; IPC-F42FN-0600B**

PROJECT NUMBER: 4789796034

REPORT NUMBER: 4789796034-4

FCC ID: 2AVYF-IPC-F42FX

ISSUE DATE: Feb. 20, 2021

Prepared for

Hangzhou Huacheng Network Technology Co., Ltd.

Prepared by

UL-CCIC COMPANY LIMITED

No. 2, Chengwan Road, Suzhou Industrial Park, People's Republic of China

Tel: +86 769 22038881

Fax: +86 769 33244054

Website: www.ul.com



Revision History

<u>Rev.</u>	<u>Issue Date</u>	<u>Revisions</u>	<u>Revised By</u>
V0	02/20/2021	Initial Issue	



TABLE OF CONTENTS

1. ATTESTATION OF TEST RESULTS	4
2. TEST METHODOLOGY	6
3. FACILITIES AND ACCREDITATION	6
4. CALIBRATION AND UNCERTAINTY	7
4.1. <i>MEASURING INSTRUMENT CALIBRATION</i>	<i>7</i>
4.2. <i>MEASUREMENT UNCERTAINTY.....</i>	<i>7</i>
5. EQUIPMENT UNDER TEST	8
5.1. <i>DESCRIPTION OF EUT</i>	<i>8</i>
5.2. <i>MAXIMUM OUTPUT POWER.....</i>	<i>10</i>
5.3. <i>CHANNEL LIST</i>	<i>10</i>
5.4. <i>TEST CHANNEL CONFIGURATION.....</i>	<i>11</i>
5.5. <i>THE WORSE CASE POWER SETTING PARAMETER.....</i>	<i>11</i>
5.6. <i>DESCRIPTION OF AVAILABLE ANTENNAS</i>	<i>12</i>
5.7. <i>THE WORSE CASE CONFIGURATIONS</i>	<i>12</i>
5.8. <i>TEST ENVIRONMENT</i>	<i>13</i>
5.9. <i>DESCRIPTION OF TEST SETUP.....</i>	<i>14</i>
5.10. <i>MEASURING INSTRUMENT AND SOFTWARE USED</i>	<i>15</i>
6. MEASUREMENT METHODS	16
7. ANTENNA PORT TEST RESULTS	17
7.1. <i>ON TIME AND DUTY CYCLE.....</i>	<i>17</i>
7.2. <i>6 dB BANDWIDTH.....</i>	<i>20</i>
7.3. <i>PEAK CONDUCTED OUTPUT POWER.....</i>	<i>34</i>
7.4. <i>POWER SPECTRAL DENSITY</i>	<i>36</i>
7.5. <i>CONDUCTED BANDEDGE AND SPURIOUS EMISSIONS.....</i>	<i>50</i>
7.6. <i>RADIATED TEST RESULTS</i>	<i>110</i>
7.6.1. <i>LIMITS AND PROCEDURE</i>	<i>110</i>
7.6.2. <i>TEST ENVIRONMENT</i>	<i>115</i>
7.6.3. <i>RESTRICTED BANDEDGE</i>	<i>115</i>
7.6.4. <i>SPURIOUS EMISSIONS</i>	<i>132</i>
8. AC POWER LINE CONDUCTED EMISSIONS.....	189
9. ANTENNA REQUIREMENTS.....	192



1. ATTESTATION OF TEST RESULTS

Applicant Information

Company Name: Hangzhou Huacheng Network Technology Co., Ltd.
Address: No.2930, Nanhuan Road, Binjiang District, Hangzhou, China

Manufacturer Information

Company Name: Hangzhou Huacheng Network Technology Co., Ltd.
Address: No.2930, Nanhuan Road, Binjiang District, Hangzhou, China

EUT Description

Product Name: CONSUMER CAMERA
Model Name: IPC-F42FP
Additional No. : IPC-TF42F-LC; IPC-F42F-LC; IPC-F42FP-imou; IPC-F42FN-imou; IPC-F42FN; IPC-F42F; LC-TF2F-4M; LC-A32F-4M; F42F; IPC-TF42F-0280B-LC; IPC-TF42F-0360B-LC; IPC-TF42F-0600B-LC; IPC-F42F-0280B-LC; IPC-F42F-0360B-LC; IPC-F42F-0600B-LC; IPC-F42FP-0280B-imou; IPC-F42FP-0360B-imou; IPC-F42FP-0600B-imou; IPC-F42FN-0280B-imou; IPC-F42FN-0360B-imou; IPC-F42FN-0600B-imou; IPC-F42FP-0280B; IPC-F42FP-0360B; IPC-F42FP-0600B; IPC-F42FN-0280B; IPC-F42FN-0360B; IPC-F42FN-0600B
Sample Number: 3607003
Data of Receipt Sample: Jan. 19, 2021
Date Tested: Jan. 19, 2021~ Feb. 18, 2021

APPLICABLE STANDARDS	
STANDARD	TEST RESULTS
CFR 47 Part 15 Subpart C	PASS



Summary of Test Results			
Clause	Test Items	FCC/IC Rules	Test Results
1	6db DTS Bandwidth	FCC 15.247 (a) (2)	Complied
2	Conducted Output Power	FCC 15.247 (b) (3)	Complied
3	Power Spectral Density	FCC 15.247 (e)	Complied
4	Conducted Band edge And Spurious emission	FCC 15.247 (d)	Complied
5	Radiated Band edges and Spurious emission	FCC 15.247 (d) FCC 15.209 FCC 15.205	Complied
6	Conducted Emission Test For AC Power Port	FCC 15.207	Complied
7	Antenna Requirement	FCC 15.203	Complied
<p>Remark:</p> <p>1) The measurement result for the sample received is <Pass> according to < ANSI C63.10-2013, FCC CFR 47 Part 2, FCC CFR 47 Part 15C> when <Accuracy Method> decision rule is applied.</p> <p>2) For this product, it has two antennas, antenna1 and antenna2, but only the modes of 11N HT20 and 11N HT40 can support MIMO mode.</p>			

Prepared By:

Jason Yang

Jason Yang
Engineer

Reviewed By:

Tom Tang

Tom Tang
Engineer Project Associate

Authorized By:

Chris Zhong

Chris Zhong
Laboratory Leader



2. TEST METHODOLOGY

The tests documented in this report were performed in accordance with FCC KDB 558074 D01 15.247 Meas Guidance v05r02, KDB 414788 D01 Radiated Test Site v01r01, ANSI C63.10-2013, FCC CFR 47 Part 2, FCC CFR 47 Part 15, KDB 662911 D01 Multiple Transmitter Output v02r01.

3. FACILITIES AND ACCREDITATION

Accreditation Certificate	<p>A2LA (Certificate No.: 4829.01) UL-CCIC COMPANY LIMITED has been assessed and proved to be in compliance with A2LA.</p> <p>FCC (FCC Designation No.: CN1247) UL-CCIC COMPANY LIMITED has been recognized to perform compliance testing on equipment subject to the Commission's Declaration of Conformity (DoC) and Certification rules.</p> <p>IC (IC Designation No.: 25056) UL-CCIC COMPANY LIMITED has been recognized to perform compliance testing on equipment subject to the Commission's Declaration of Conformity (DoC) and Certification rules.</p>
---------------------------	--

Note 1: All tests measurement facilities use to collect the measurement data are located at No. 2, Chengwan Road, Suzhou Industrial Park, Suzhou 215122, People's Republic of China

Note 2: For below 30MHz, lab had performed measurements at test anechoic chamber and comparing to measurements obtained on an open field site. These measurements below 30MHz had been correlated to measurements performed on an OFS.

Note 3: The test anechoic chamber in UL-CCIC COMPANY LIMITED had been calibrated and compared to the open field sites and the test anechoic chamber is shown to be equivalent to or worst case from the open field site.



4. CALIBRATION AND UNCERTAINTY

4.1. MEASURING INSTRUMENT CALIBRATION

The measuring equipment utilized to perform the tests documented in this report has been calibrated in accordance with the manufacturer's recommendations, and is traceable to recognized national standards.

4.2. MEASUREMENT UNCERTAINTY

Where relevant, the following measurement uncertainty levels have been estimated for tests performed on the apparatus:

Test Item	Uncertainty
Conduction emission	3.1dB
Radiation Emission test(include Fundamental emission) (9KHz-30MHz)	3.4dB
Radiation Emission test(include Fundamental emission) (30MHz-1GHz)	3.4dB
Radiation Emission test (1GHz to 26GHz)(include Fundamental emission)	3.9dB (1GHz-18Gz)
	4.2dB (18GHz-26.5Gz)
Note: This uncertainty represents an expanded uncertainty expressed at approximately the 95% confidence level using a coverage factor of k=2.	



5. EQUIPMENT UNDER TEST

5.1. DESCRIPTION OF EUT

Product Name:	CONSUMER CAMERA
Model No.:	IPC-F42FP
Operating Frequency:	IEEE 802.11b/g/n(HT20): 2412MHz to 2462MHz IEEE 802.11n(HT40): 2422MHz to 2452MHz
Type of Modulation:	IEEE for 802.11b: DSSS (CCK, DQPSK, DBPSK) IEEE for 802.11g: OFDM (64QAM, 16QAM, QPSK, BPSK) IEEE for 802.11n (HT20 and HT40): OFDM (64QAM, 16QAM, QPSK, BPSK)
Channels Step:	Channels with 5MHz step
Sample Type:	Fixed production
Test software of EUT:	Secure CRT (manufacturer declare)
Antenna Type:	Dipole Antenna
Antenna Gain:	Antenna1: 1.79 dBi Antenna2: 1.79 dBi Remark: This data is provided by customer and our lab isn't responsible for this data
Adapter	NAME: Power Adapter MODEL: ADS-12AM-12 12012-EPCU INPUT:100-240V,50/60Hz, 0.3A OUTPUT:12V  1A

Remark:

Model No.:

Number:	Name:	Number:	Name:	Number:	Name:
1	IPC-F42FP	2	IPC-TF42F-LC	3	IPC-F42F-LC
4	IPC-F42FP-imou	5	IPC-F42FN-imou	6	IPC-F42FN
7	IPC-F42F	8	LC-TF2F-4M	9	LC-A32F-4M
10	F42F	11	IPC-TF42F-0280B-LC	12	IPC-TF42F-0360B-LC
13	IPC-TF42F-0600B-LC	14	IPC-F42F-0280B-LC	15	IPC-F42F-0360B-LC
16	IPC-F42F-0600B-LC	17	IPC-F42FP-0280B-imou	18	IPC-F42FP-0360B-imou
19	IPC-F42FP-0600B-imou	20	IPC-F42FN-0280B-imou	21	IPC-F42FN-0360B-imou
22	IPC-F42FN-0600B-imou	23	IPC-F42FP-0280B	24	IPC-F42FP-0360B
25	IPC-F42FP-0600B	26	IPC-F42FN-0280B	27	IPC-F42FN-0360B
28	IPC-F42FN-0600B				

Only the main model **IPC-F42FP** was tested and only the data of this model is shown in this test report.

Since Their electrical circuit design, layout, components used and internal wiring are identical, only the name of the models.





5.2. MAXIMUM OUTPUT POWER

Number of Transmit Chains (NTX)	IEE Std. 802.11	Channel Number	Max AV Conducted Power (dBm)
1	IEEE 802.11B SISO	1-11[11]	18.26
1	IEEE 802.11G SISO	1-11[11]	16.69
2	IEEE 802.11N HT20 MIMO	1-11[11]	19.25
2	IEEE 802.11N HT40 MIMO	3-9[7]	18.99

Remark: For this product, it has two antennas, antenna1 and antenna2, but only the 802.11N HT20 and 802.11N HT40 modes can support both the SISO and MIMO technical.

5.3. CHANNEL LIST

Channel List for 802.11b/g/n (20 MHz)							
Channel	Frequency (MHz)	Channel	Frequency (MHz)	Channel	Frequency (MHz)	Channel	Frequency (MHz)
1	2412	4	2427	7	2442	10	2457
2	2417	5	2432	8	2447	11	2462
3	2422	6	2437	9	2452		

Channel List for 802.11n (40 MHz)							
Channel	Frequency (MHz)	Channel	Frequency (MHz)	Channel	Frequency (MHz)	Channel	Frequency (MHz)
3	2422	5	2432	7	2442	9	2452
4	2427	6	2437	8	2447		



5.4. TEST CHANNEL CONFIGURATION

Test Mode	Test Channel	Frequency
WiFi TX(802.11b)	CH 1, CH 6, CH 11	2412MHz, 2437MHz, 2462MHz
WiFi TX(802.11g)	CH 1, CH 6, CH 11	2412MHz, 2437MHz, 2462MHz
WiFi TX(802.11n HT20)	CH 1, CH 6, CH 11	2412MHz, 2437MHz, 2462MHz
WiFi TX(802.11n HT40)	CH 3, CH 6, CH 9	2422MHz, 2437MHz, 2452MHz

5.5. THE WORSE CASE POWER SETTING PARAMETER

The Worst Case Power Setting Parameter under 2400 ~ 2483.5MHz Band							
Test Software		SecureCRT					
Modulation Mode	Transmit Antenna Number	Test Channel					
		NCB: 20MHz			NCB: 40MHz		
		CH 1	CH 6	CH 11	CH 3	CH 6	CH 9
802.11b	1/2	N/A	N/A	N/A	/		
802.11g	1/2	N/A	N/A	N/A			
802.11n HT20	1/2	N/A	N/A	N/A			
802.11n HT40	1/2	/			N/A	N/A	N/A



5.6. DESCRIPTION OF AVAILABLE ANTENNAS

Ant.	Frequency (MHz)	Antenna Type	Antenna Gain (dBi)	Directional gain(dBi)
1	2400-2483.5	Dipole Antenna	1.79	4.80
2	2400-2483.5	Dipole Antenna	1.79	

Note:

- 1) Directional gain= $10\log [(10^{G1/20} + 10^{G2/20})^2 / N_{ANT}] = 4.80$ dBi
- 2) N_{ANT} : the number of Antenna
- 3) For this product, it has two antennas, antenna1 and antenna2, but only the 802.11N HT20 and 802.11N HT40 modes can support both the SISO and MIMO technical.

Test Mode	Transmit and Receive Mode	Description
IEEE 802.11b	<input checked="" type="checkbox"/> 2TX, 2RX	Antenna1 or Antenna2 can be used as transmitting/receiving antenna independently.
IEEE 802.11g	<input checked="" type="checkbox"/> 2TX, 2RX	Antenna1 or Antenna2 can be used as transmitting/receiving antenna independently.
IEEE 802.11N (HT20) MIMO	<input checked="" type="checkbox"/> 2TX, 2RX	Antenna1 or Antenna2 can be used as transmitting/receiving antenna independently.
IEEE 802.11N (HT20) MIMO	<input checked="" type="checkbox"/> 2TX, 2RX	Antenna1 or Antenna2 can be used as transmitting/receiving antenna independently.

Remark:

- 1) For this product, it has two antennas, antenna1 and antenna2, only the 802.11N HT20 and 802.11N HT40 modes can support both the SISO and MIMO technical. But for the 11B and 11G modes only support the SISO technical.
- 2) For the 11N mode (including the 11N HT20 SISO, 11N HT20 MIMO, 11N HT40 SISO, 11N HT40 MIMO), pre-testing all test modes, only the worst case modes is included in this report.

5.7. THE WORSE CASE CONFIGURATIONS

For the product, there two transmission antennas, and pre-testing both of them, only the worse data for the antenna is recorded in the report.

Worst-case data rates as provided by the client were:

802.11b mode: 1 Mbps
 802.11b mode: 6 Mbps
 802.11n HT20 mode: MCS0
 802.11n HT40 mode: MCS0



5.8. TEST ENVIRONMENT

Environment Parameter	Selected Values During Tests	
Relative Humidity	55 ~ 65%	
Atmospheric Pressure:	1025Pa	
Temperature	TN	23 ~ 28°C
Voltage :	VL	N/A
	VN	AC 120V
	VH	N/A

Note: VL= Lower Extreme Test Voltage
VN= Nominal Voltage
VH= Upper Extreme Test Voltage
TN= Normal Temperature

5.9. DESCRIPTION OF TEST SETUP

SUPPORT EQUIPMENT

Item	Equipment	Brand Name	Model Name	Description
1	Laptop	ThinkPad	E550c	N/A
2	Fixed Frequency Board	N/A	N/A	Supply by UL Lab

I/O PORT

Cable No	Port	Connector Type	Cable Type	Cable Length(m)	Remarks
1	LAN	LAN	LAN Cable	100cm Length (Supply by UL Lab)	N/A

ACCESSORY

Item	Accessory	Brand Name	Model Name	Description
1	Micro SD card	Kingston	32GB	Supply by UL lab

TEST SETUP

The EUT can work in an engineer mode with a software through a table PC.

SETUP DIAGRAM FOR TESTS

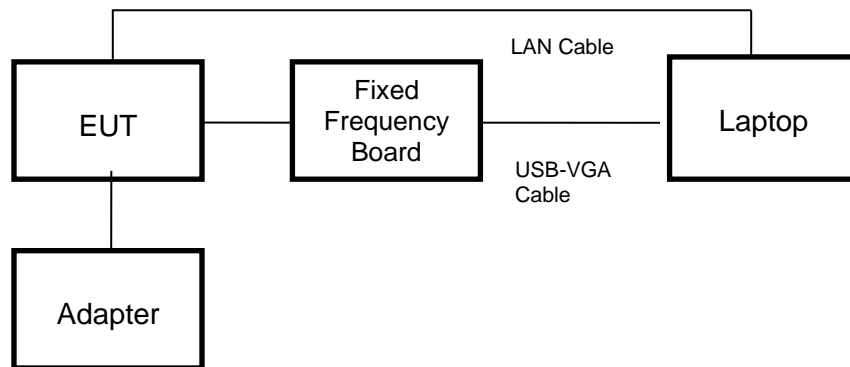

Remark: The EUT has been built one SD card during the testing.



5.10. MEASURING INSTRUMENT AND SOFTWARE USED

Conducted Emissions (Instrument)							
Used	Equipment	Manufacturer	Model No.	Serial No.	Upper Last Cal.	Last Cal.	Next Cal.
<input checked="" type="checkbox"/>	EMI Test Receiver	R&S	ESR3	126700	2019-12-12	2020-12-05	2021-12-04
<input checked="" type="checkbox"/>	Two-Line V-Network	R&S	ENV216	126701	2019-12-12	2020-12-05	2021-12-04
<input checked="" type="checkbox"/>	Artificial Mains Networks	R&S	ENY81	126711	2019-12-12	2020-12-05	2021-12-04
Software							
Used	Description		Manufacturer	Name	Version		
<input checked="" type="checkbox"/>	Test Software for Conducted disturbance		R&S	EMC32	Ver. 9.25		
Radiated Emissions (Instrument)							
Used	Equipment	Manufacturer	Model No.	Serial No.	Upper Last Cal.	Last Cal.	Next Cal.
<input checked="" type="checkbox"/>	Spectrum Analyzer	Keysight	N9010B	MY57110128	2019-05-29	2020-05-10	2021-05-09
<input checked="" type="checkbox"/>	EMI test receiver	R&S	ESR26	1267603	2019-12-12	2020-12-05	2021-12-04
<input checked="" type="checkbox"/>	Receiver Antenna (9kHz-30MHz)	Schwarzbeck	FMZB 1513	513-265	N/A	2018-06-15	2021-06-14
<input checked="" type="checkbox"/>	Receiver Antenna (30MHz-1GHz)	SunAR RF Motion	JB1	177821	N/A	2019-01-28	2022-01-27
<input checked="" type="checkbox"/>	Receiver Antenna (1GHz-18GHz)	R&S	HF907	126705	2018-01-29	2019-01-28	2022-01-27
<input checked="" type="checkbox"/>	Receiver Antenna (18GHz-26.5GHz)	Schwarzbeck	BBHA9170	126706	2019-02-06	2020-12-05	2021-12-04
<input checked="" type="checkbox"/>	Pre-amplification (To 18GHz)	Compliance Direction System Inc.	PAP-1G18-50	14140-13467	2019-03-18	2020-12-05	2021-12-04
<input checked="" type="checkbox"/>	Pre-amplification (To 26.5GHz)	R&S	SCU-26D	134668	2019-02-06	2020-09-27	2021-09-26
<input checked="" type="checkbox"/>	Band Reject Filter	Wainwright	WRCJV8-2350-2400-2483.5-2533.5-40SS	1	2019-05-29	2020-05-10	2021-05-09
<input checked="" type="checkbox"/>	Highpass Filter	Wainwright	WHKX10-2700-3000-18000-40SS	2	2019-05-29	2020-05-10	2021-05-09
Software							
Used	Description		Manufacturer	Name	Version		
<input checked="" type="checkbox"/>	Test Software for Radiated disturbance		Tonscend	JS32	V1.0		
Other instruments							
Used	Equipment	Manufacturer	Model No.	Serial No.	Upper Last Cal.	Last Cal.	Next Cal.
<input checked="" type="checkbox"/>	Spectrum Analyzer	Keysight	N9010B	MY57110128	2019-05-29	2020-05-10	2021-05-09
<input checked="" type="checkbox"/>	Power Meter	Keysight	U2021XA	MY57110002	2019-06-12	2020-05-10	2021-05-09



6. MEASUREMENT METHODS

No.	Test Item	KDB Name	Section
1	6dB Bandwidth	KDB 558074 D01 15.247 Meas Guidance v05r02	8.2
2	Conducted Output Power	KDB 558074 D01 15.247 Meas Guidance v05r02	8.3.1.3/8.3.2.3
3	Power Spectral Density	KDB 558074 D01 15.247 Meas Guidance v05r02	8.4
4	Out-of-band emissions in non-restricted bands	KDB 558074 D01 15.247 Meas Guidance v05r02	8.5
5	Out-of-band emissions in restricted bands	KDB 558074 D01 15.247 Meas Guidance v05r02	8.6
6	Band-edge	KDB 558074 D01 15.247 Meas Guidance v05r02	8.7
7	Conducted Emission Test For AC Power Port	ANSI C63.10-2013	6.2



7. ANTENNA PORT TEST RESULTS

7.1. ON TIME AND DUTY CYCLE

LIMITS

None; for reporting purposes only

PROCEDURE

FCC KDB 558074 Zero-Span Spectrum Analyzer Method

TEST SETUP

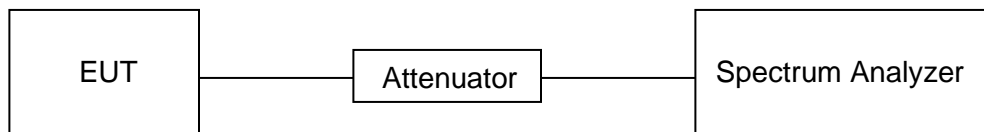

TEST ENVIRONMENT

Temperature	22°C	Relative Humidity	56%
Atmosphere Pressure	101kPa	Test Voltage	AC 120V

RESULTS

Mode	On Time (msec)	Period (msec)	Duty Cycle x (Linear)	Duty Cycle (%)	Duty Cycle Correction Factor (db)	1/T Minimum VBW (KHz)
11B	100	100	1	100	0	0.01
11G	100	100	1	100	0	0.01
11N20 MIMO	100	100	1	100	0	0.01
11N40 MIMO	100	100	1	100	0	0.01

Note: 1) Duty Cycle Correction Factor=10log(1/x).

2) Where: x is Duty Cycle(Linear)

3) Where: T is On Time (transmit duration)

4) Pre-testing Antenna 1 and Antenna2, and pre-testing SISO and MIMO modes, only the data of worse case is shown in this test report.



11B ON TIME AND DUTY CYCLE MID CH (WORSE CASE)

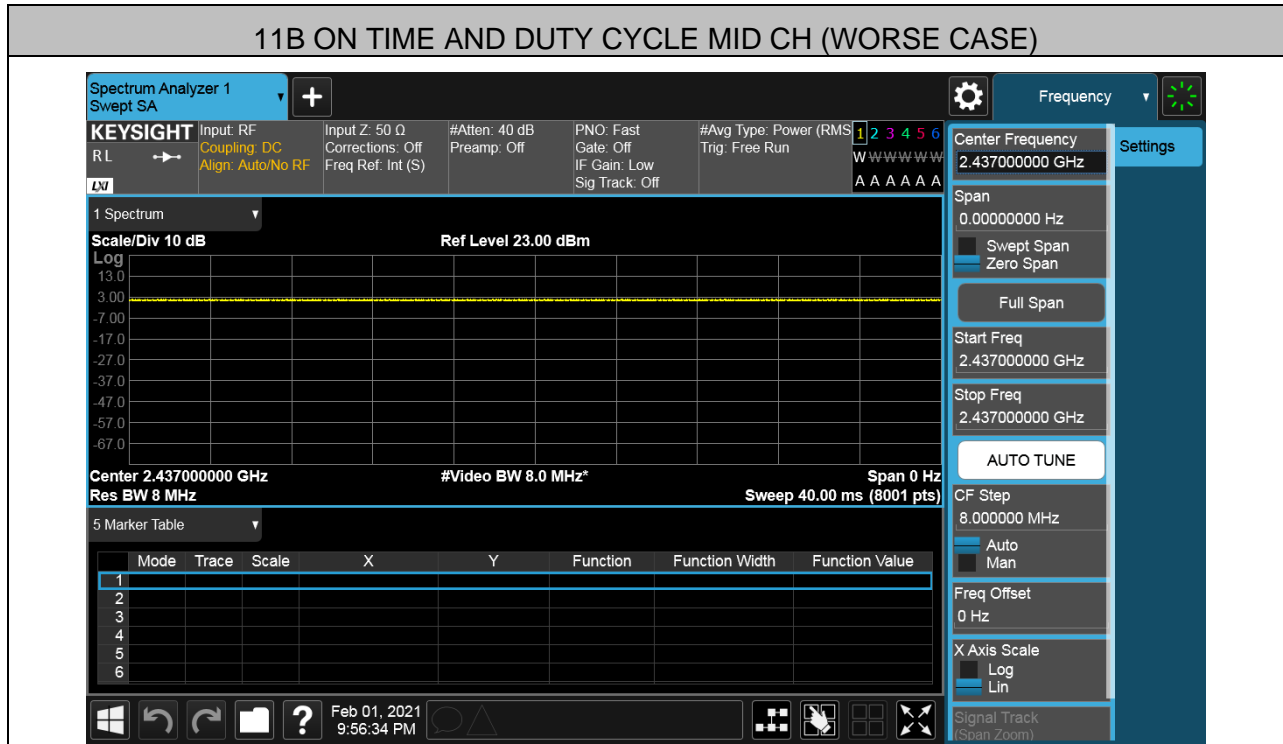

11G ON TIME AND DUTY CYCLE MID CH (WORSE CASE)

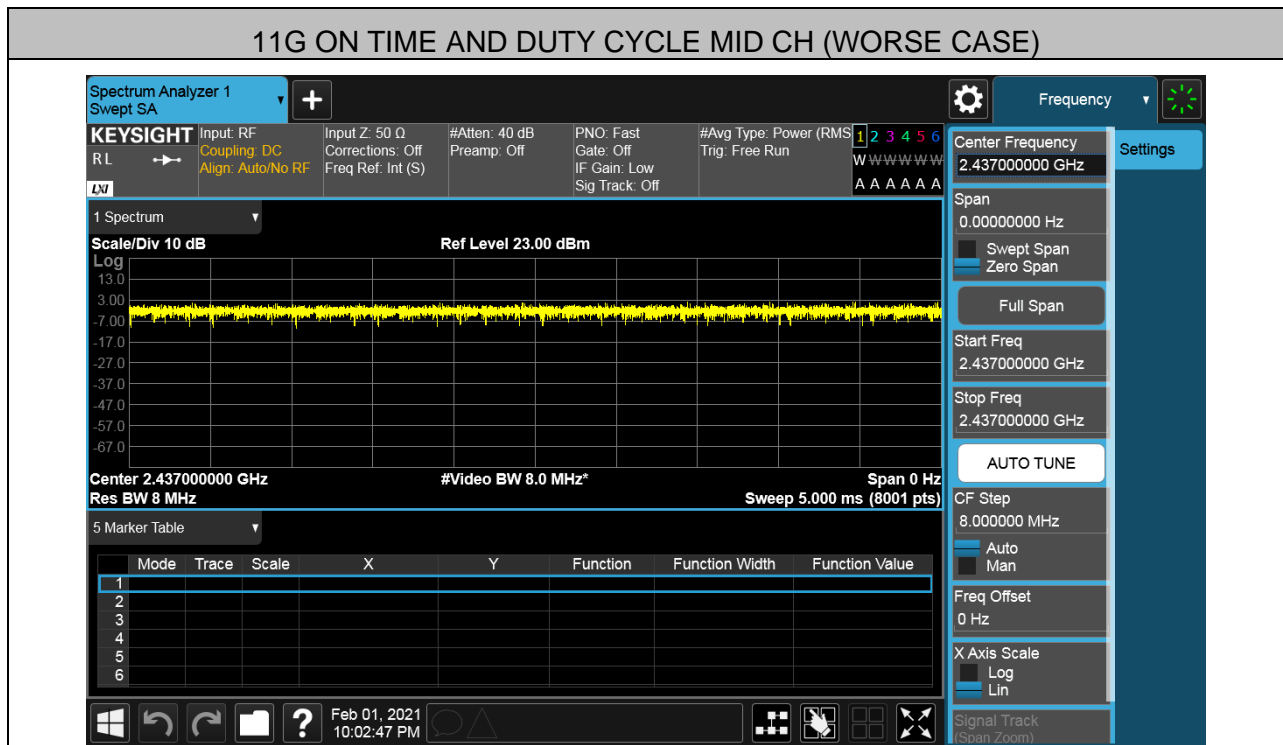



11N HT20 MIMO ON TIME AND DUTY CYCLE MID CH (WORSE CASE)

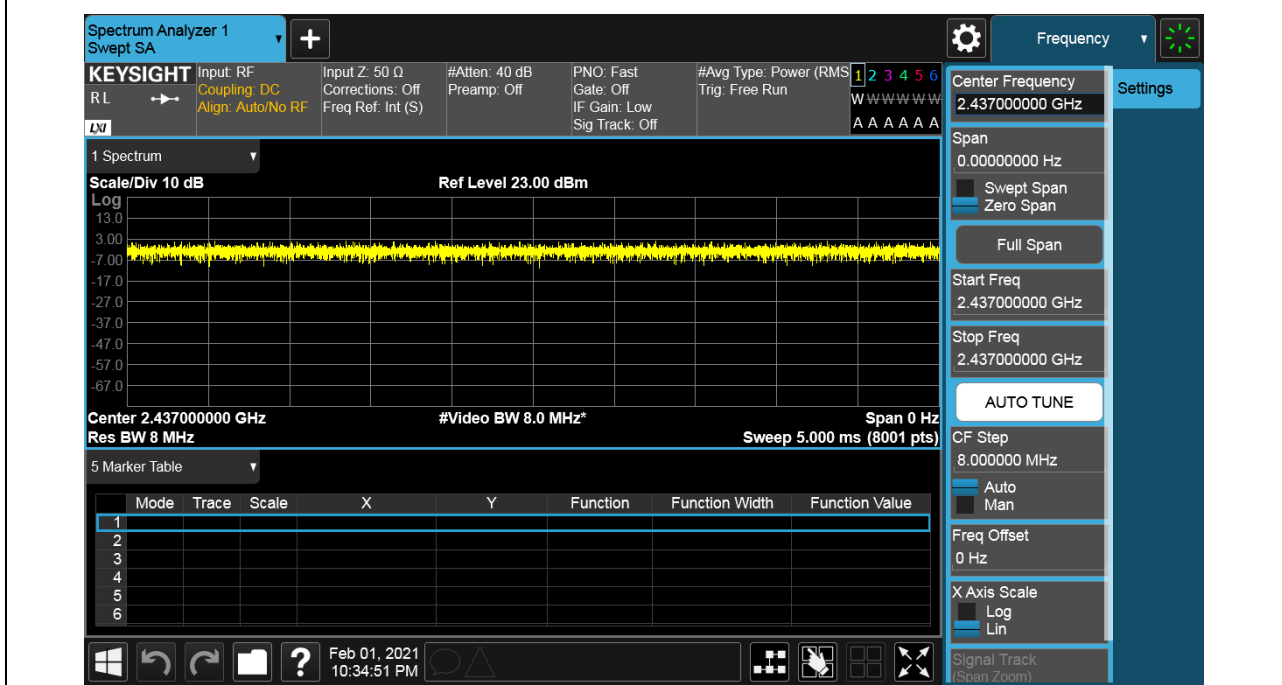

11N HT40 ON TIME AND DUTY CYCLE MID CH (WORSE CASE)

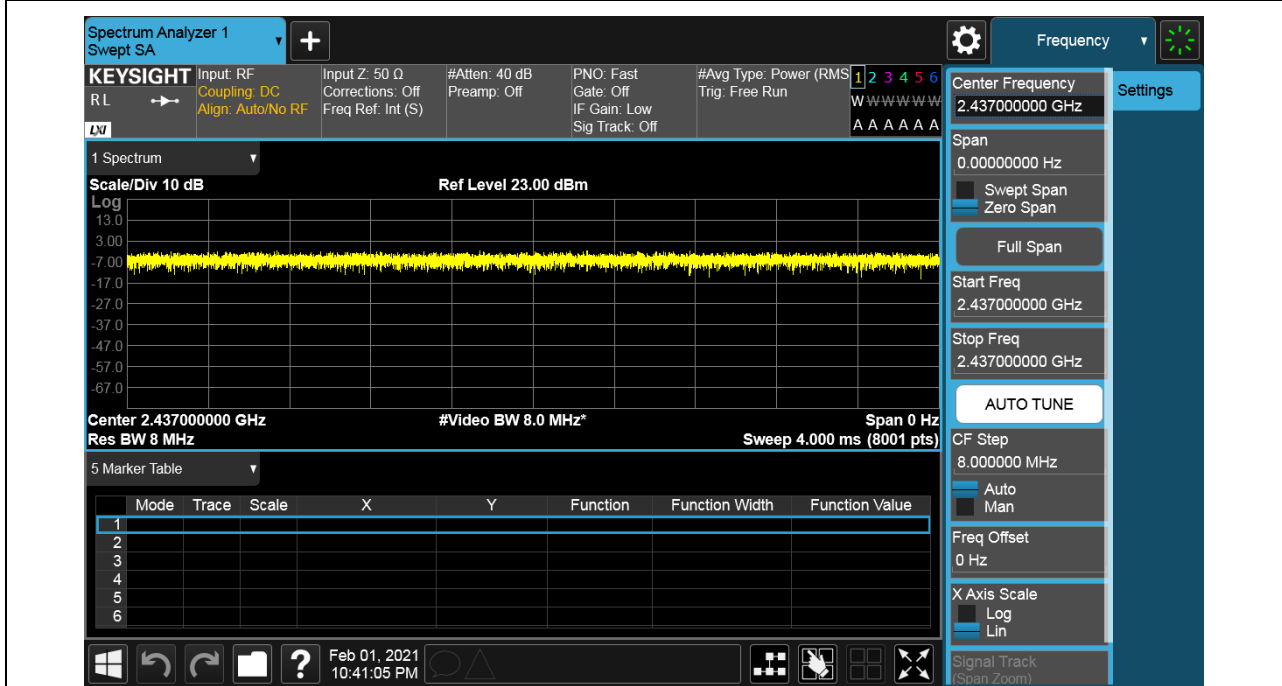

7.2. 6 dB BANDWIDTH

LIMITS

FCC Part15 (15.247) Subpart C			
Section	Test Item	Limit	Frequency Range (MHz)
FCC 15.247(a)(2)	6dB Bandwidth	$\geq 500\text{KHz}$	2400-2483.5

TEST PROCEDURE

Refer to FCC KDB 558074, connect the UUT to the spectrum analyser and use the following settings:

Center Frequency	The centre frequency of the channel under test
Detector	Peak
RBW	For 6 dB Bandwidth :100K
VBW	For 6dB Bandwidth : $\geq 3 \times \text{RBW}$
Trace	Max hold
Sweep	Auto couple

Allow the trace to stabilize and measure the maximum width of the emission that is constrained by the frequencies associated with the two outermost amplitude points (upper and lower frequencies) that are attenuated by 6 dB relative to the maximum level measured in the fundamental emission.

TEST SETUP

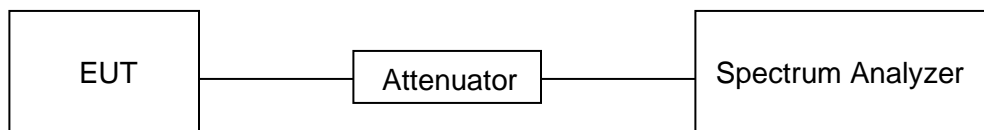



RESULTS

Test Mode	Test Antenna	Test Channel	6dB bandwidth (MHz)	Result
11B SISO	Antenna 1	LCH	10.08	Pass
		MCH	10.07	Pass
		HCH	10.08	Pass
	Antenna 2	LCH	10.07	Pass
		MCH	10.07	Pass
		HCH	10.08	Pass
11G SISO	Antenna 1	LCH	16.55	Pass
		MCH	16.56	Pass
		HCH	16.56	Pass
	Antenna 2	LCH	16.56	Pass
		MCH	16.54	Pass
		HCH	16.56	Pass
11N20MIMO	Antenna 1	LCH	17.76	Pass
		MCH	17.68	Pass
		HCH	17.79	Pass
	Antenna 2	LCH	17.78	Pass
		MCH	17.70	Pass
		HCH	17.75	Pass
11N40MIMO	Antenna 1	LCH	36.42	Pass
		MCH	36.42	Pass
		HCH	36.42	Pass
	Antenna 2	LCH	36.42	Pass
		MCH	36.42	Pass
		HCH	36.42	Pass

Remark:

- 1) For this product, it has two antennas, antenna1 and antenna2, but only the 802.11N HT20 and 802.11N HT40 modes can support both the SISO and MIMO technical.
- 2) Through pre-testing all the test modes of 11N 20 and 11N40, including SISO and MIMO, but only the data if worse case is included in this test report.



Test Graphs
Antenna1

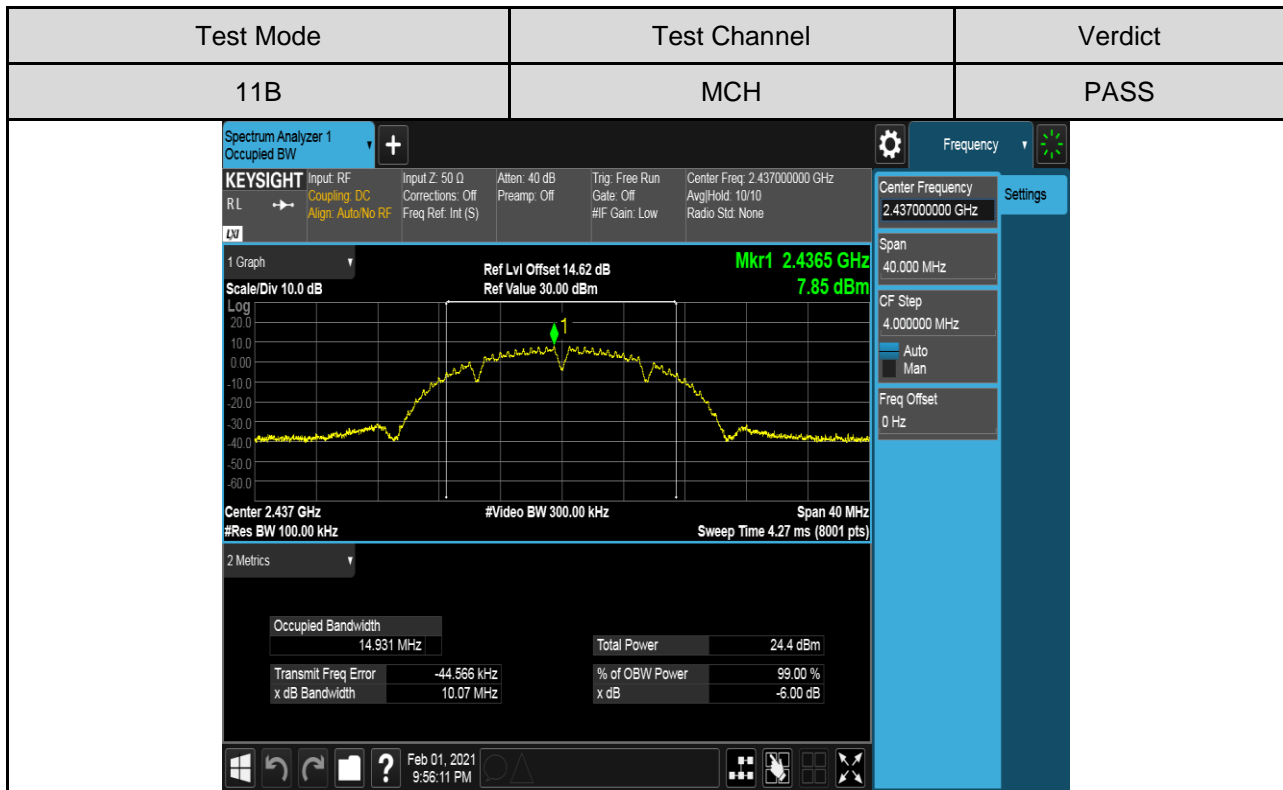
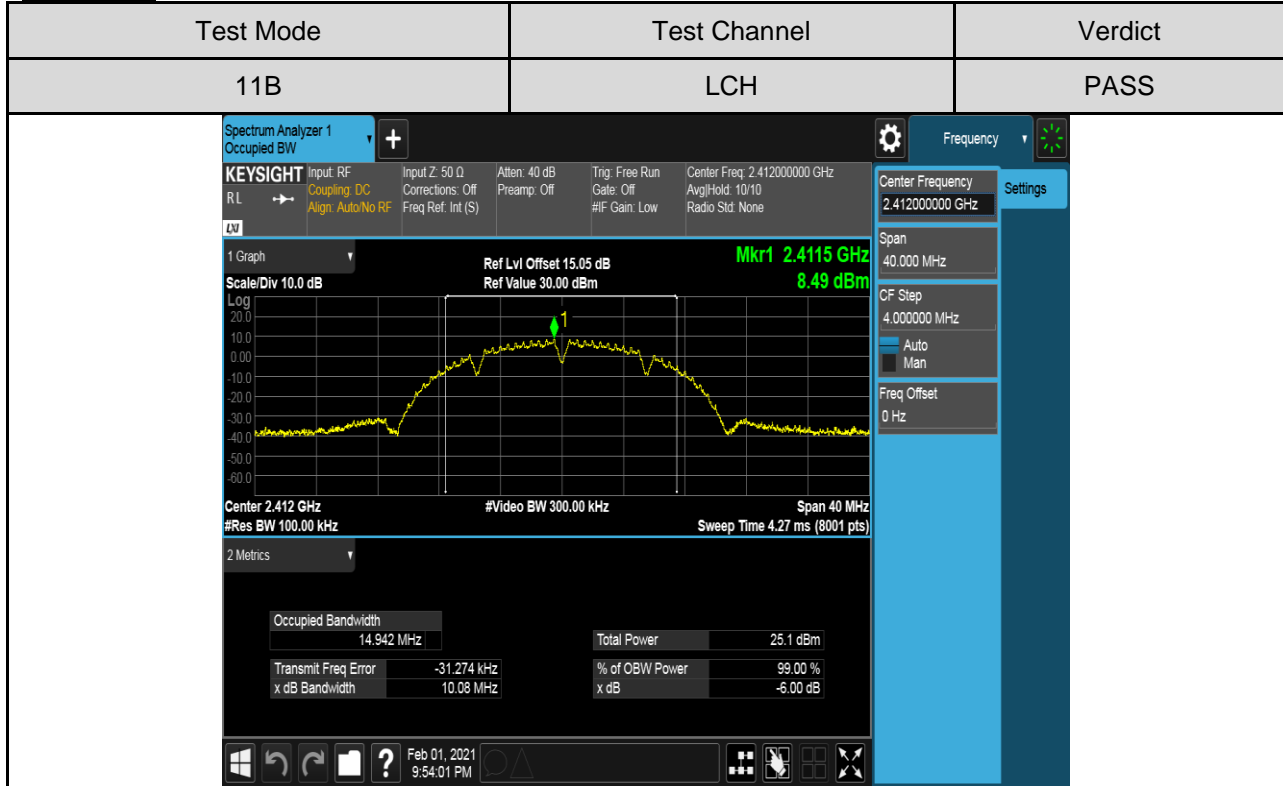

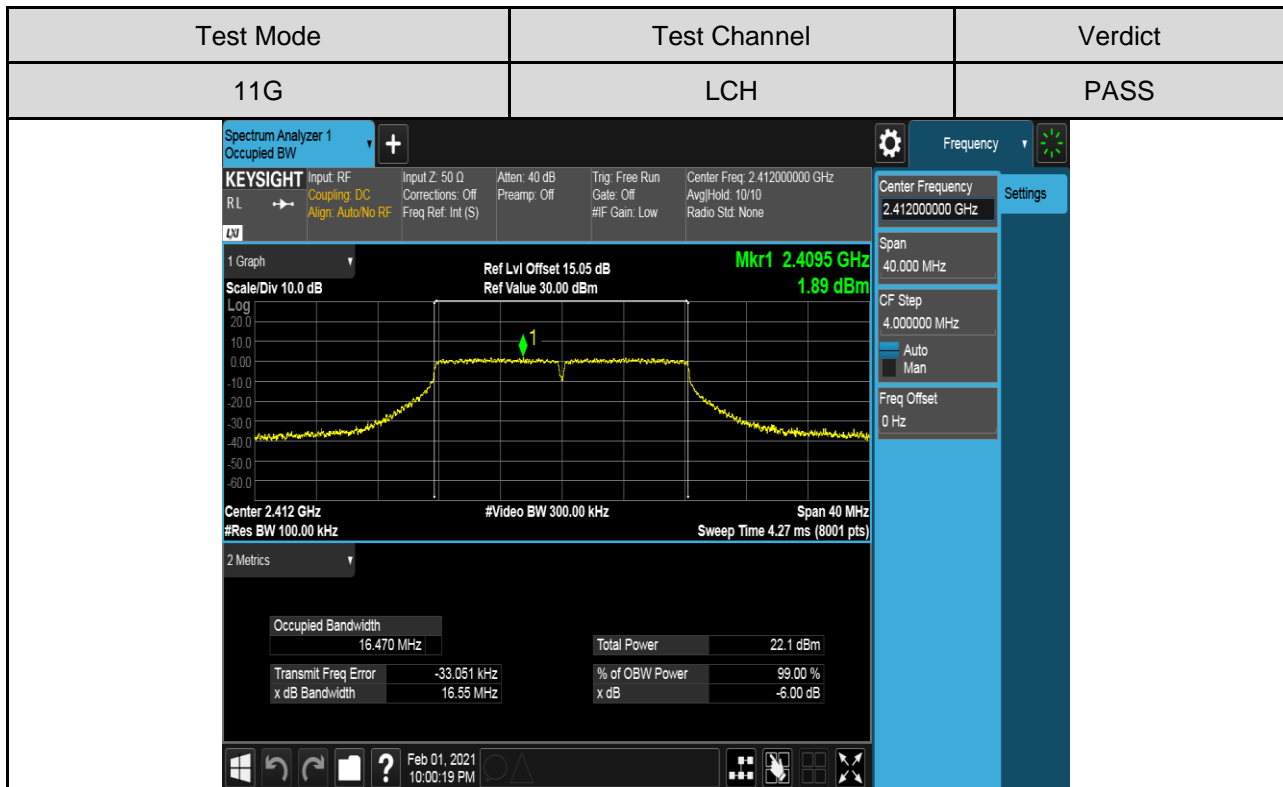
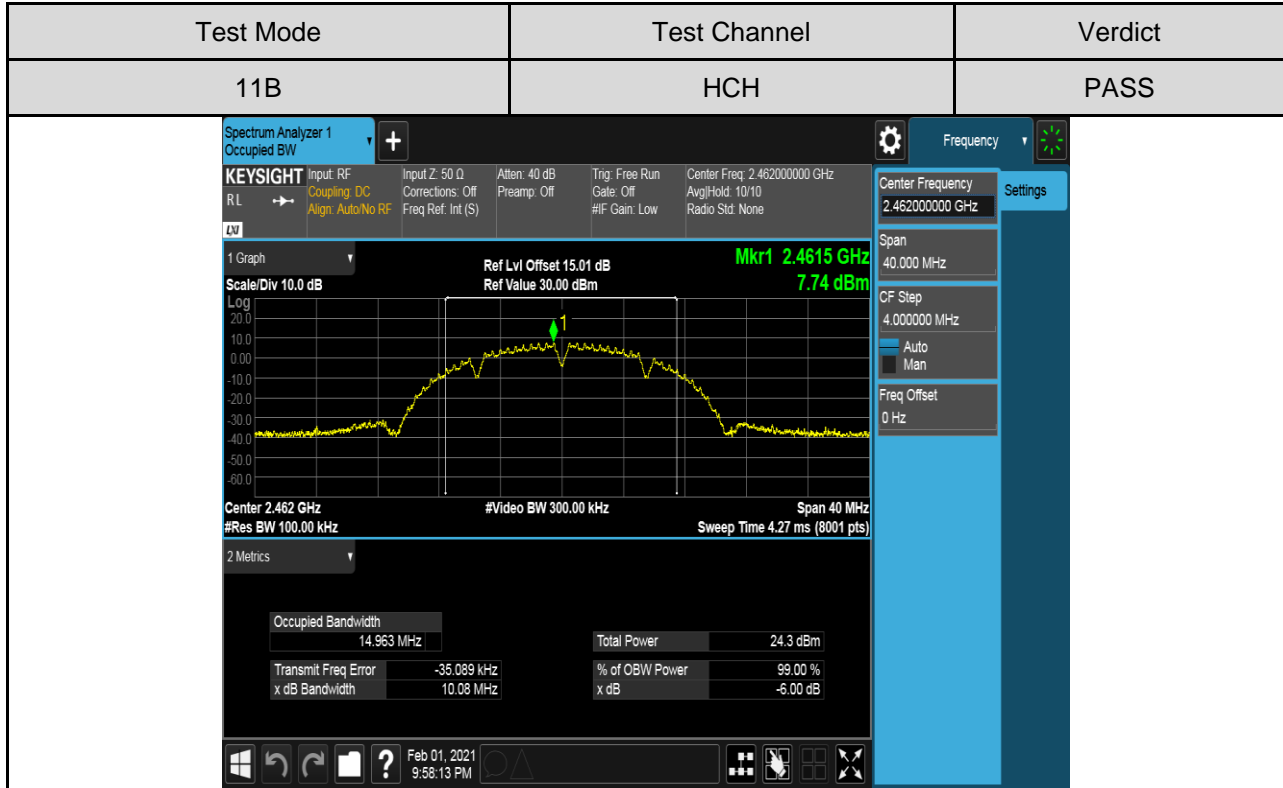

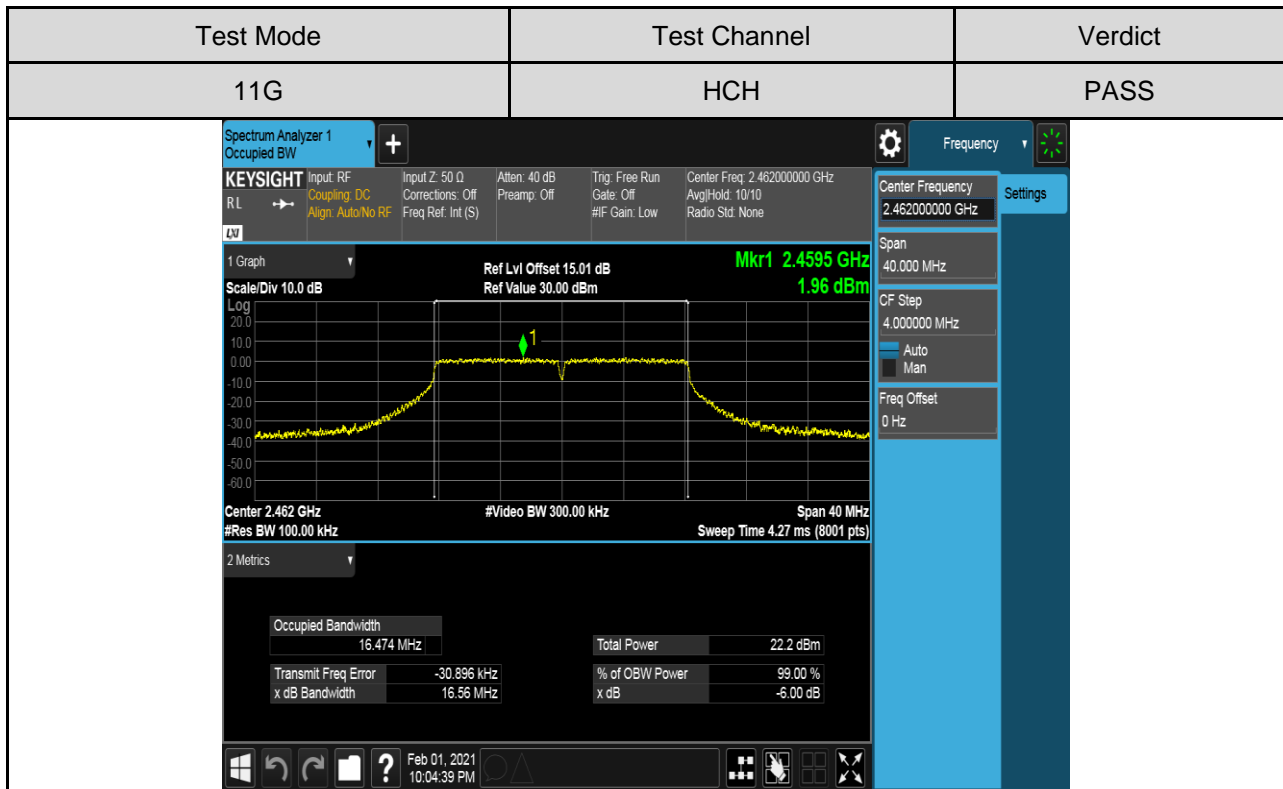
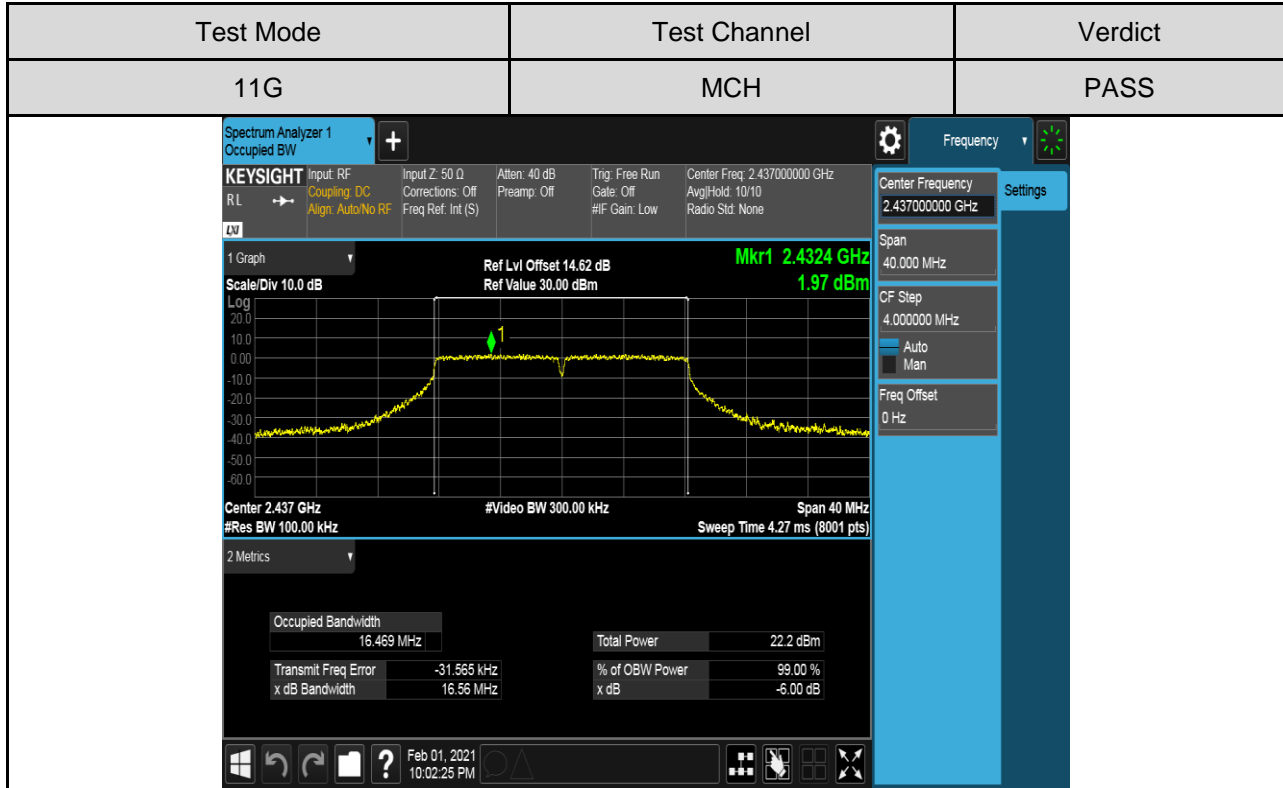

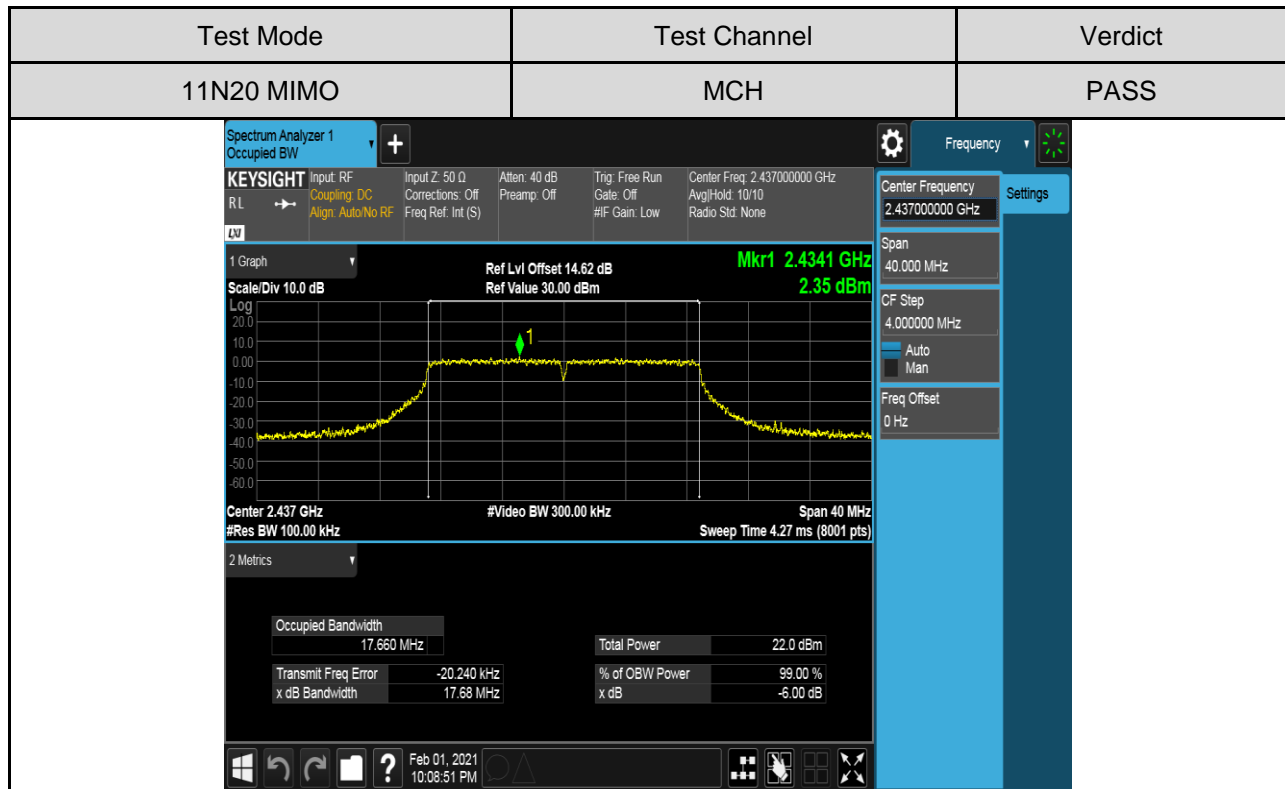
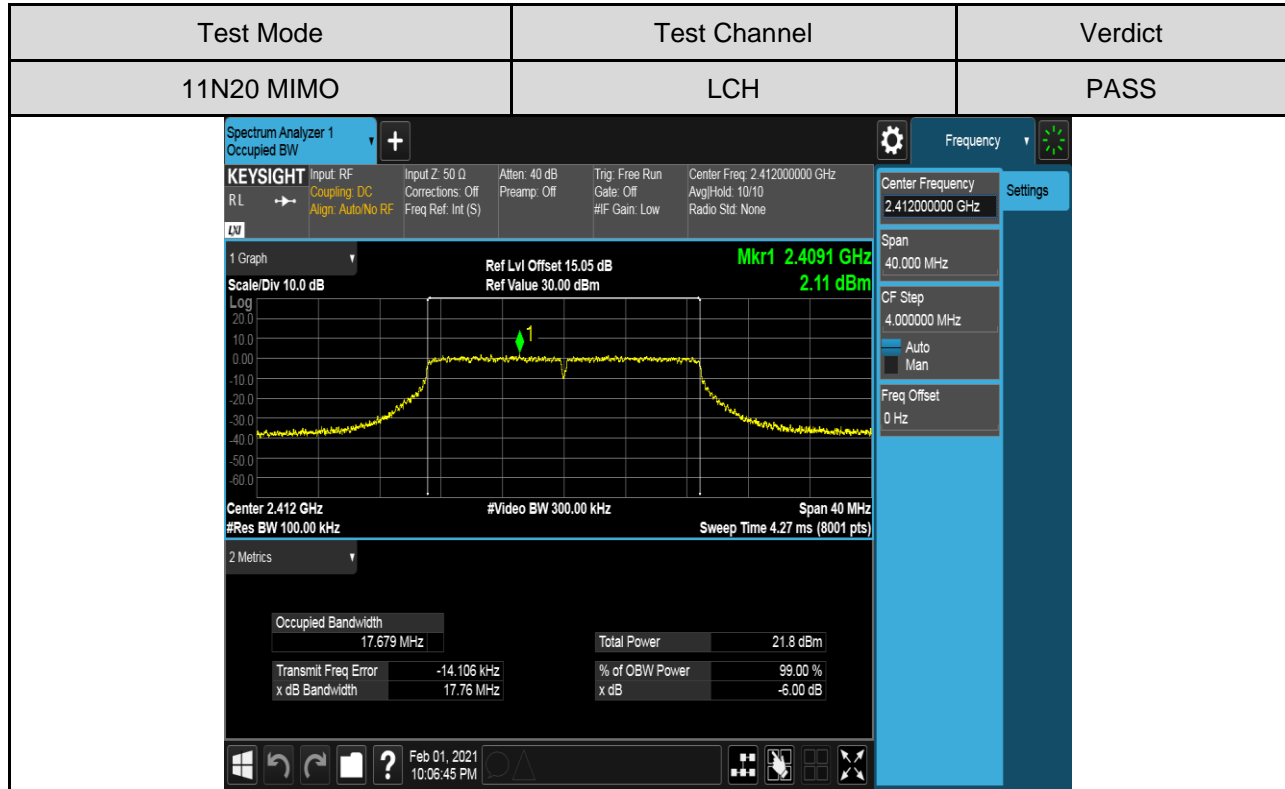

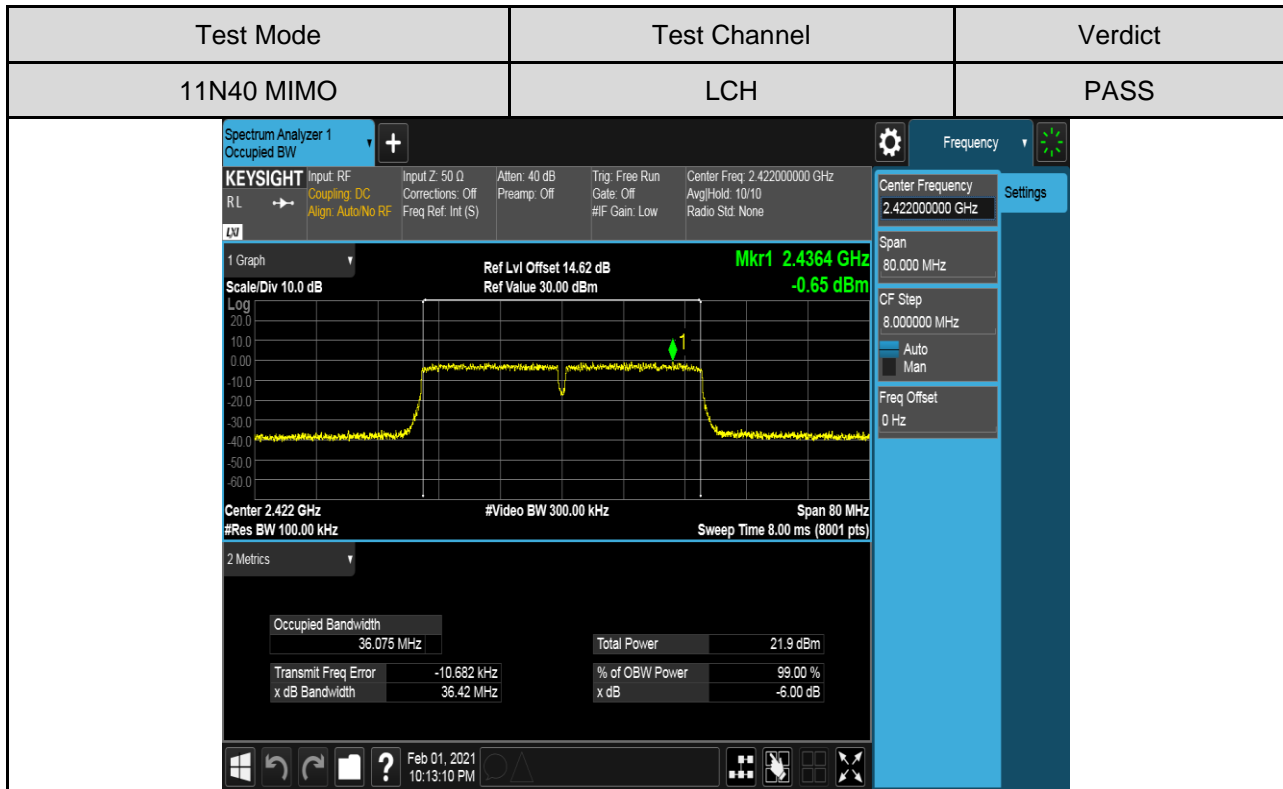
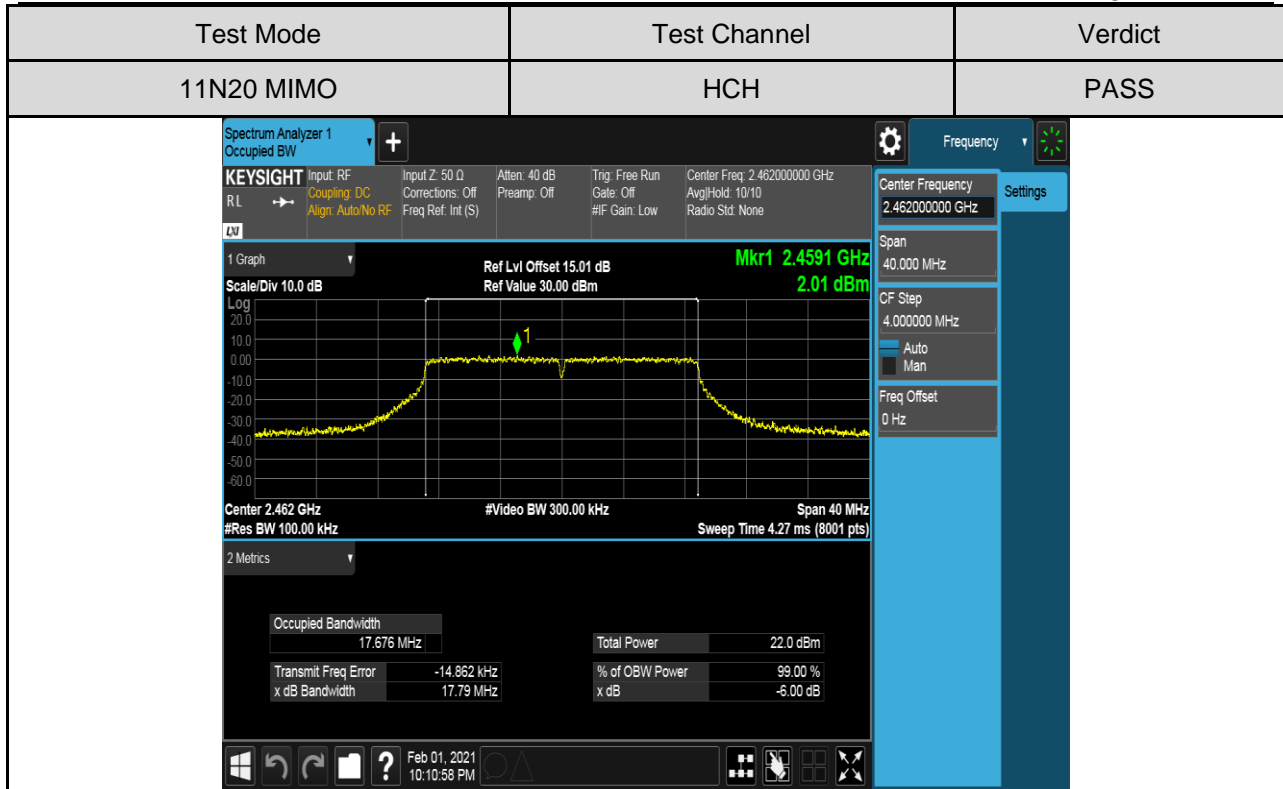

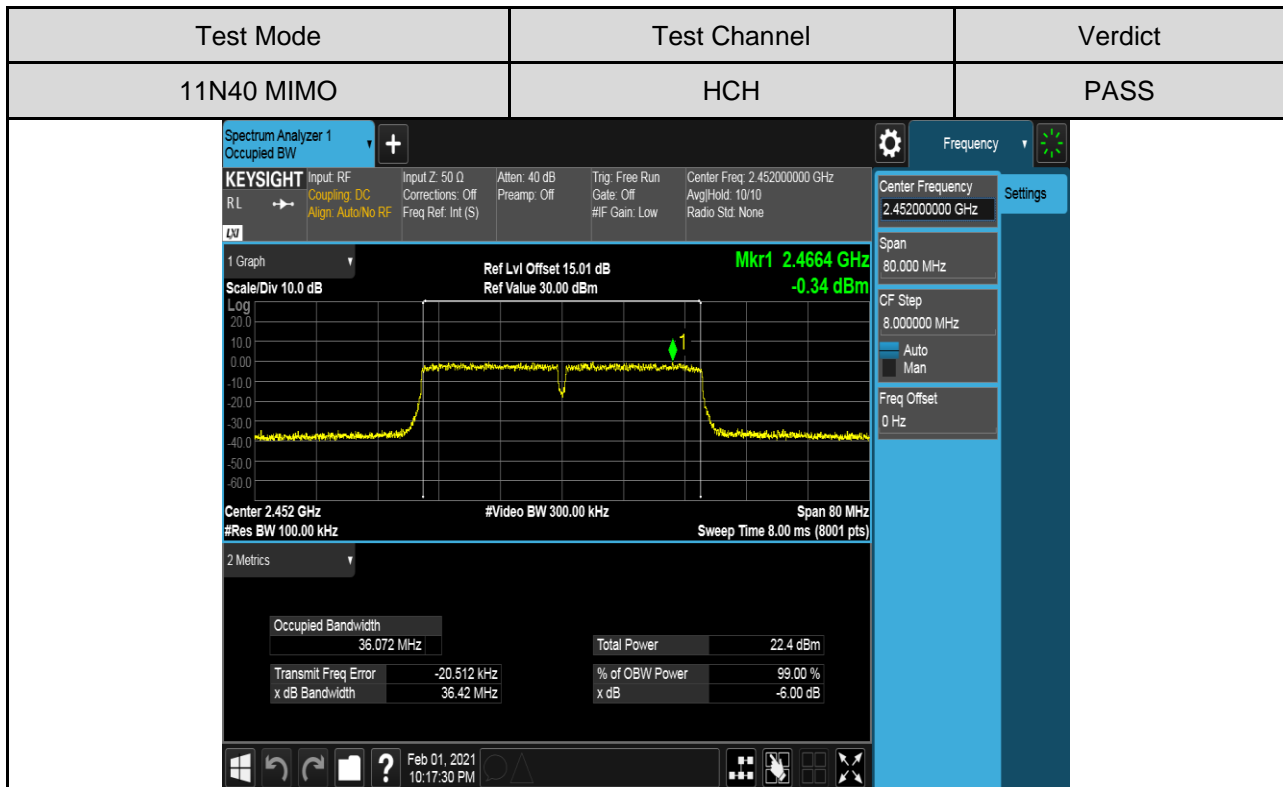
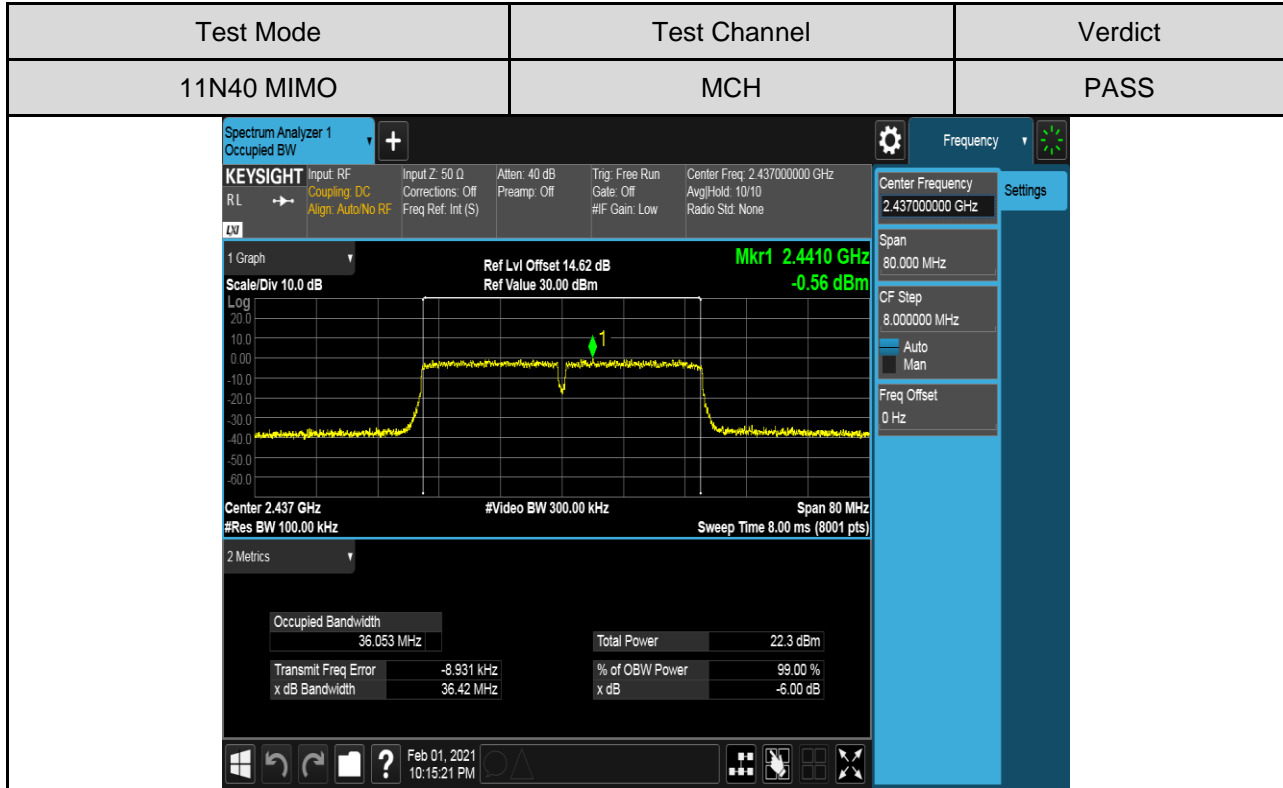



Antenna2

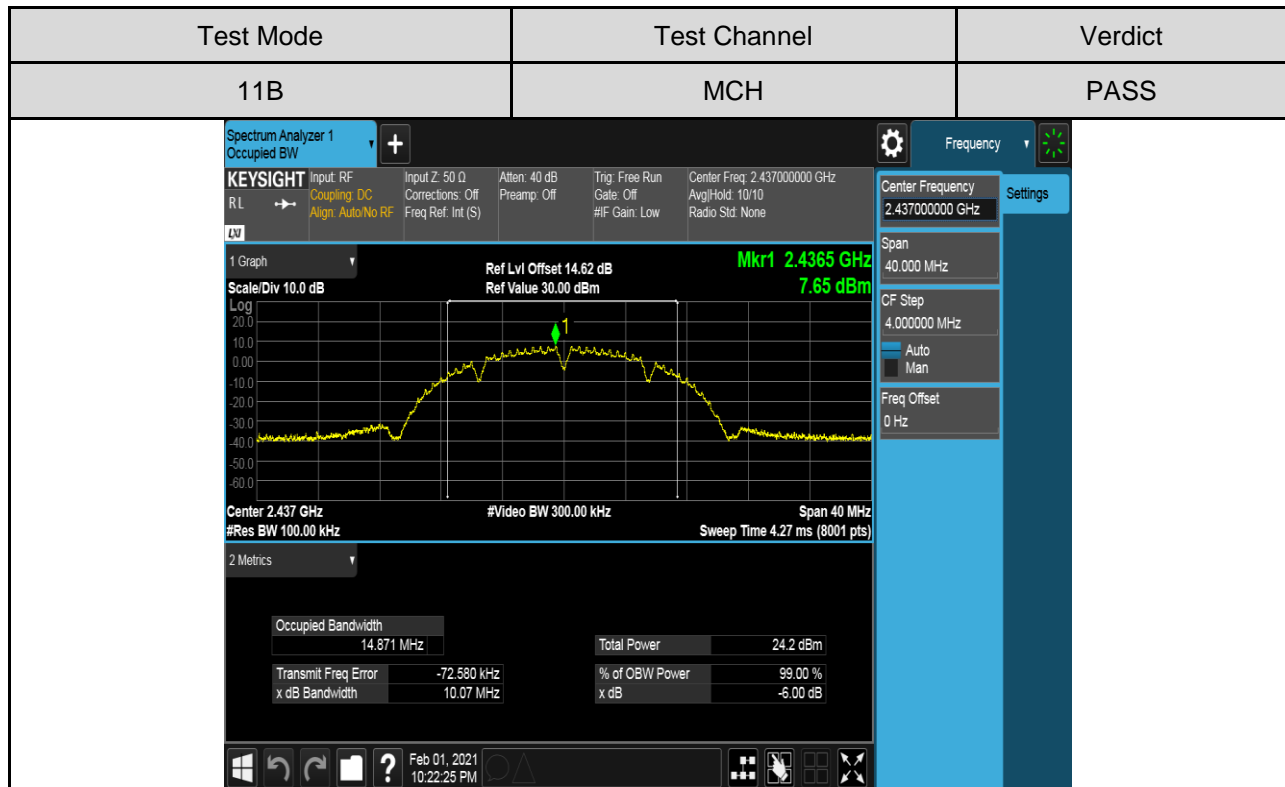
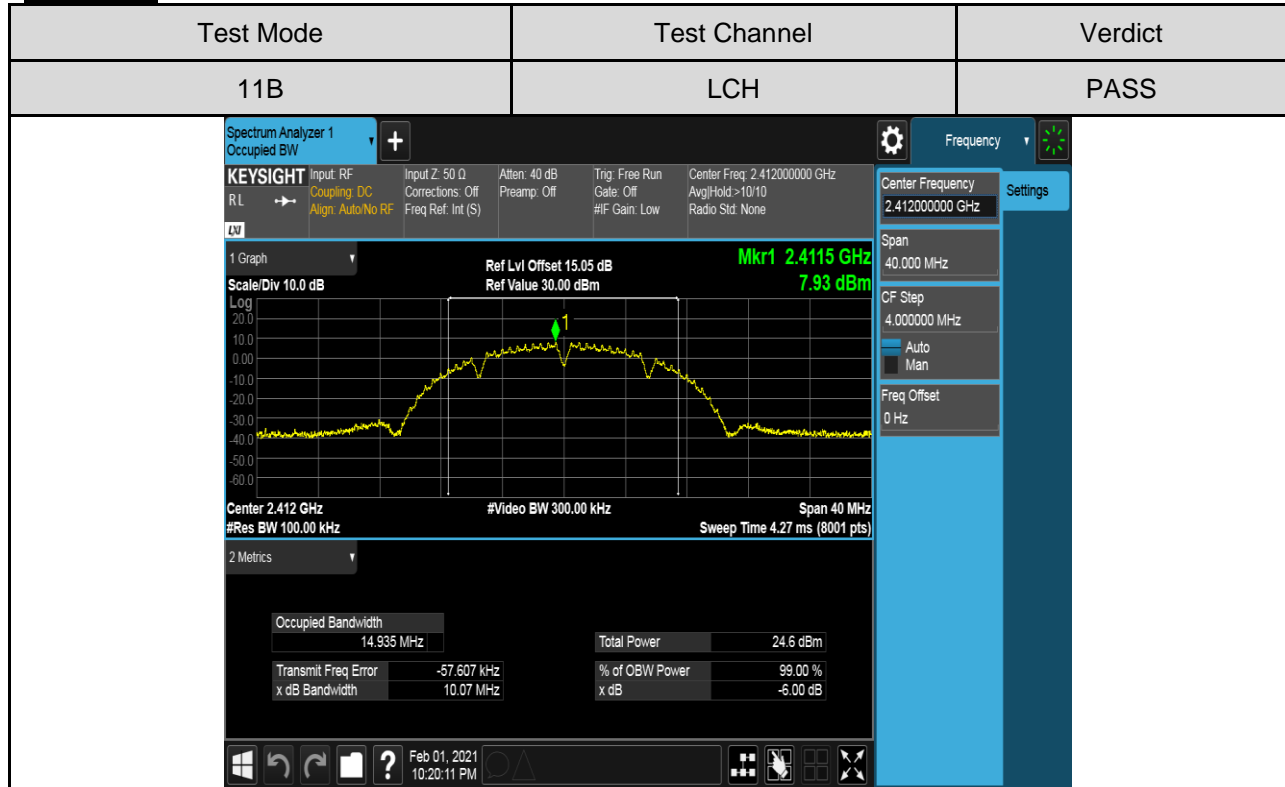

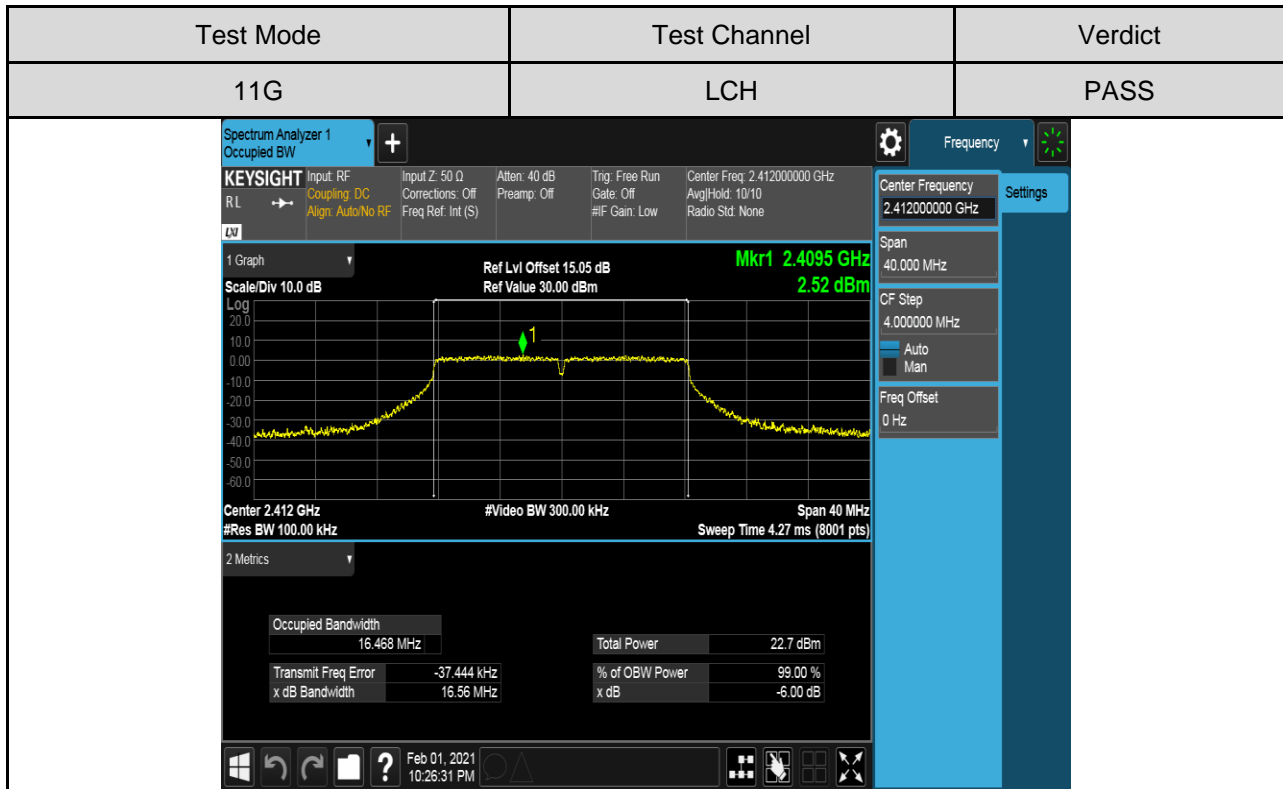
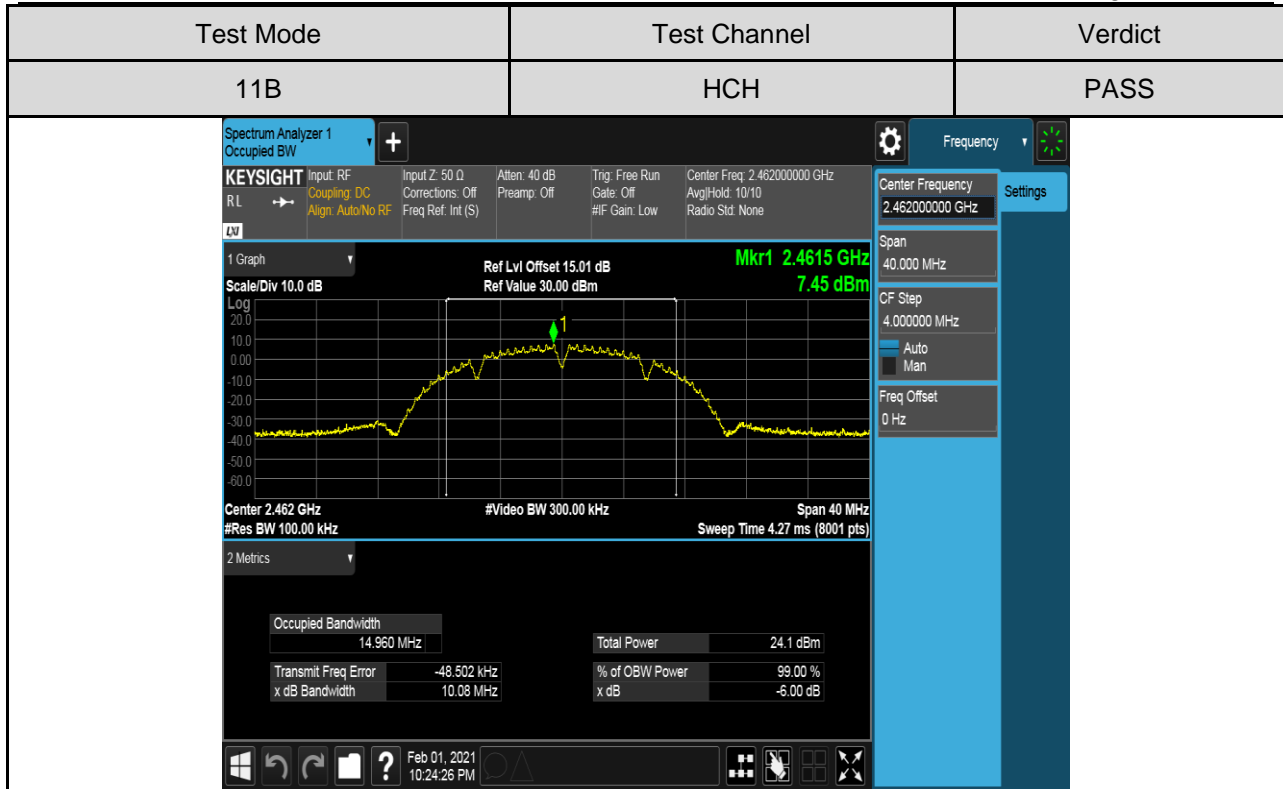

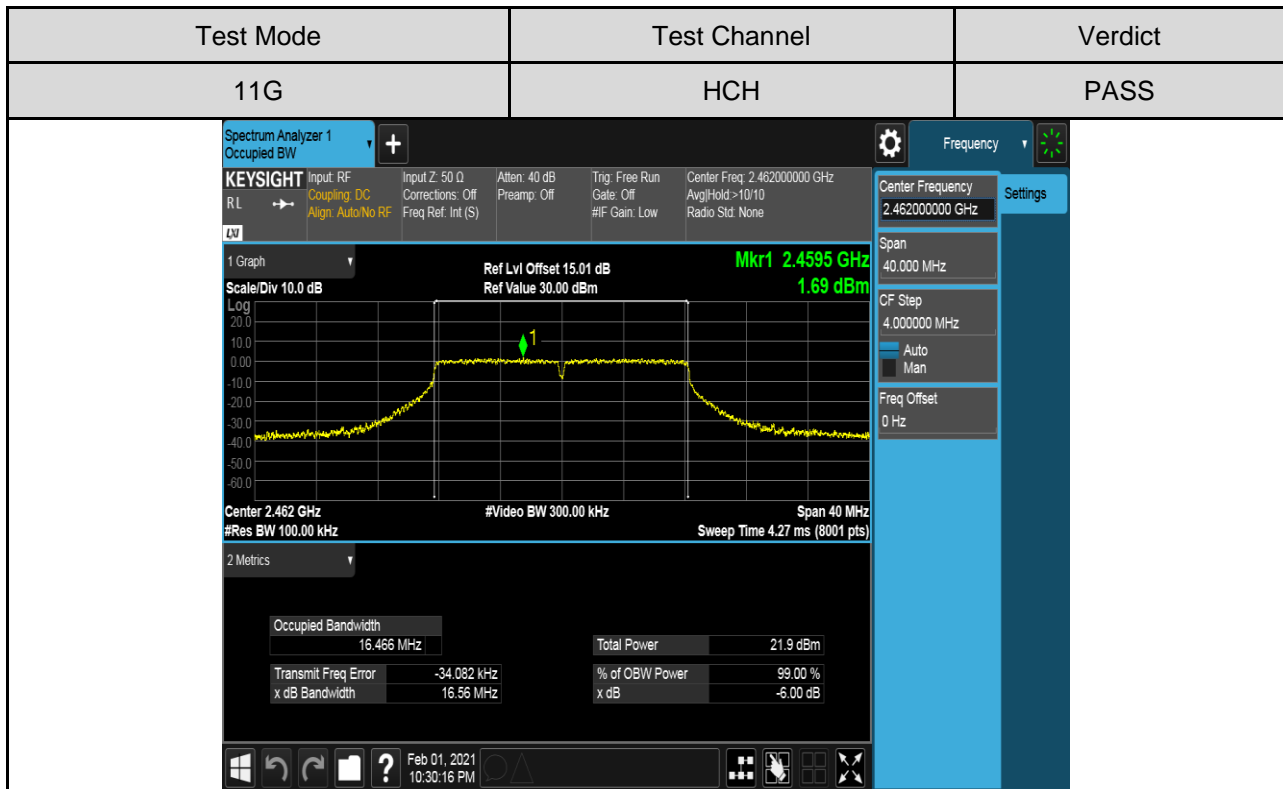
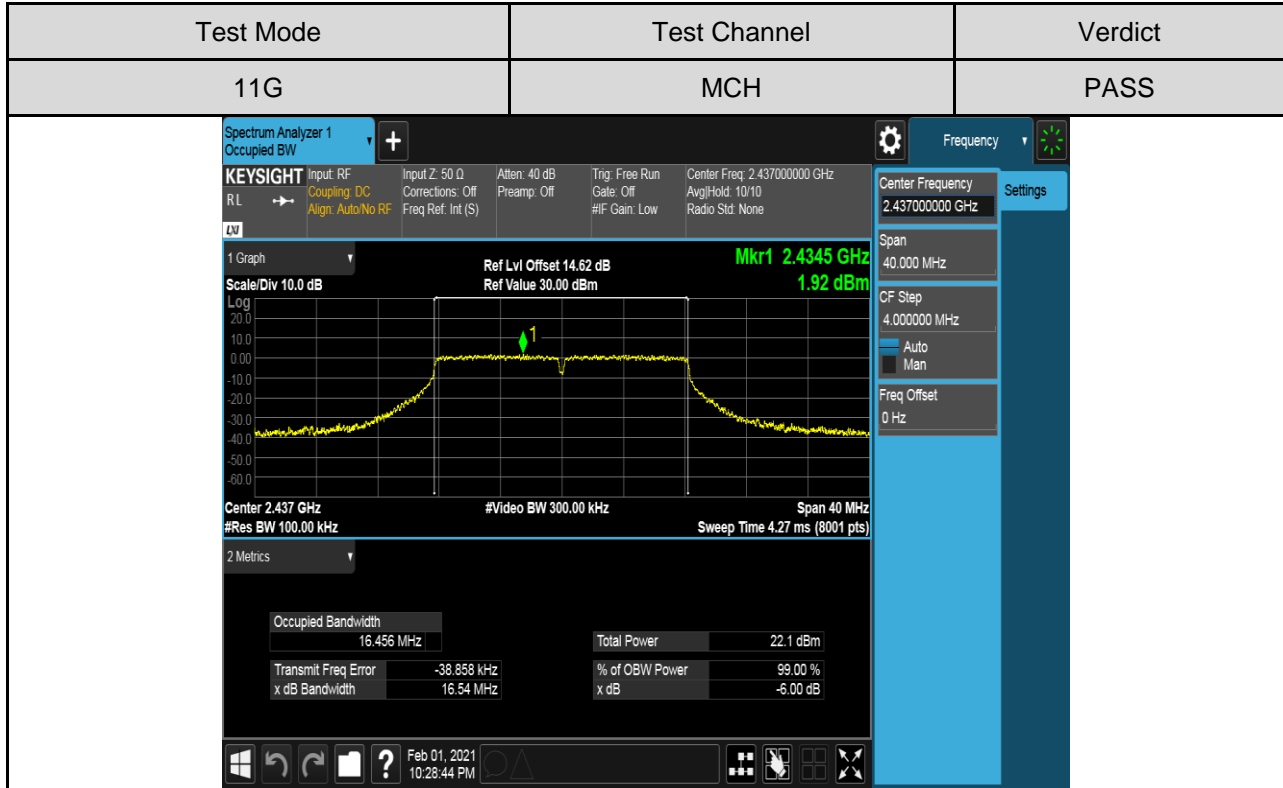



Test Mode	Test Channel	Verdict
11N20 MIMO	LCH	PASS
<p>Spectrum Analyzer 1 Occupied BW</p> <p>Center Freq: 2.41200000 GHz Mkr1 2.4066 GHz 2.62 dBm</p> <p>Occupied Bandwidth: 17.666 MHz Total Power: 22.6 dBm</p>		

Test Mode	Test Channel	Verdict
11N20 MIMO	MCH	PASS
<p>Spectrum Analyzer 1 Occupied BW</p> <p>Center Freq: 2.43700000 GHz Mkr1 2.4341 GHz 2.25 dBm</p> <p>Occupied Bandwidth: 17.654 MHz Total Power: 21.9 dBm</p>		

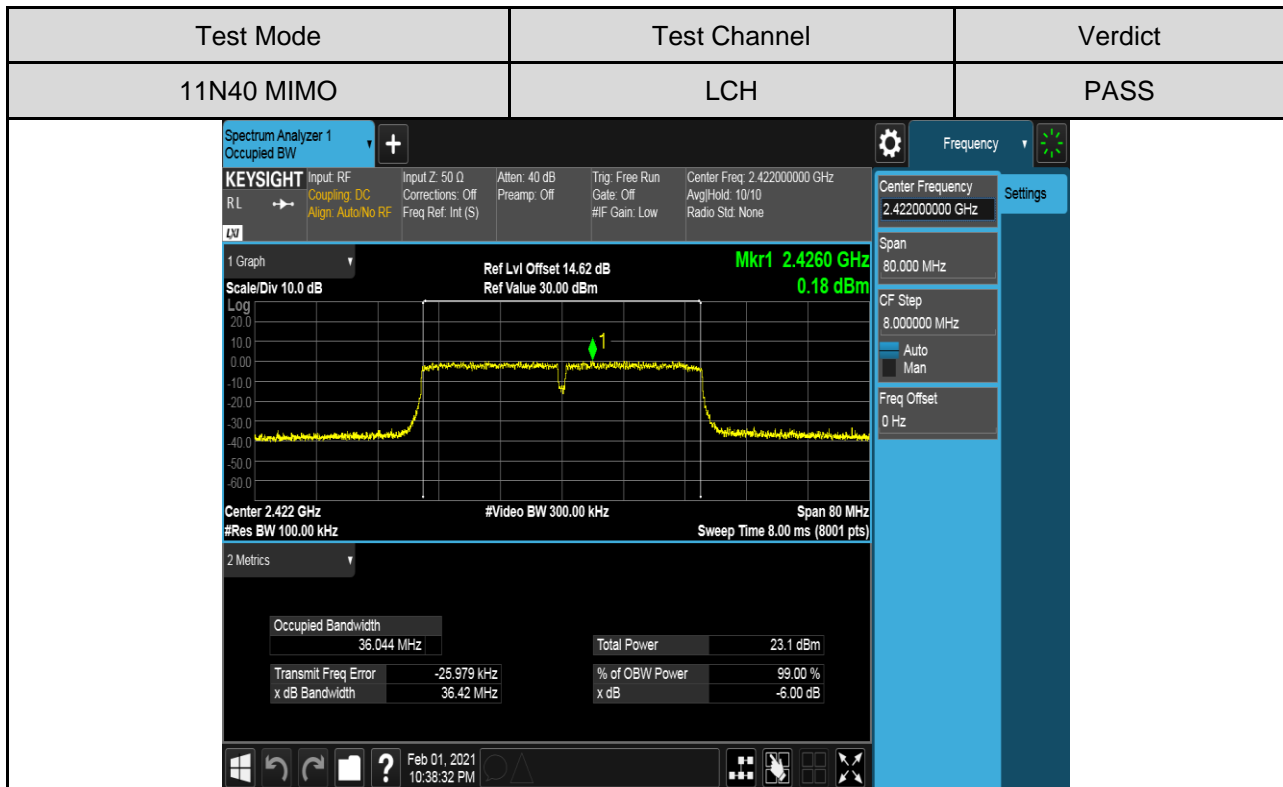
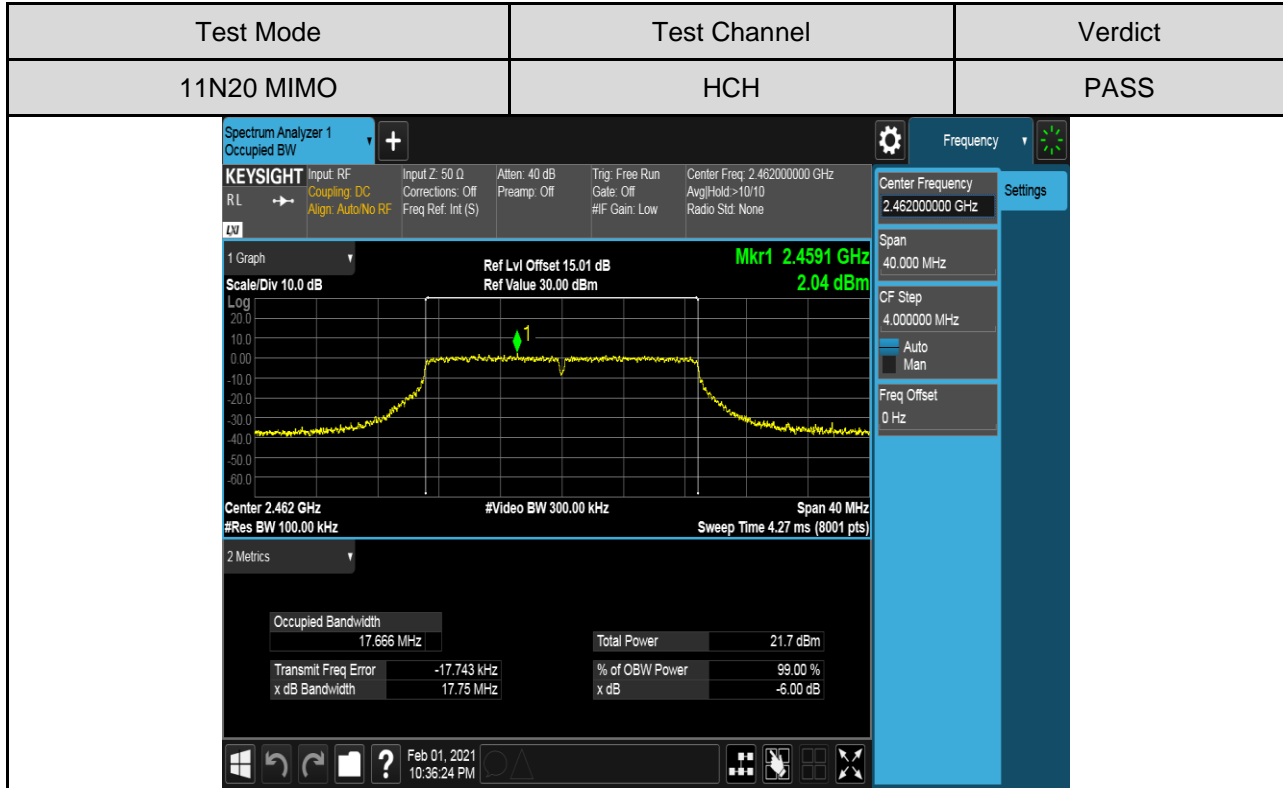



Test Mode	Test Channel	Verdict												
11N40 MIMO	MCH	PASS												
<p>Spectrum Analyzer 1 Occupied BW</p> <p>KEYSIGHT Input: RF Input Z: 50 Ω Atten: 40 dB Trig: Free Run Center Freq: 2.437000000 GHz Coupling: DC Corrections: Off Preamp: Off Gate: Off Avg/Hold: 10/10 Align: Auto/No RF Freq Ref: Int (S) #IF Gain: Low Radio Std: None</p> <p>1 Graph Scale/Div 10.0 dB Ref Lvl Offset 14.62 dB Mkr1 2.4410 GHz Log Ref Value 30.00 dBm 0.02 dBm</p> <p>Center 2.437 GHz #Video BW 300.00 kHz Span 80 MHz #Res BW 100.00 kHz Sweep Time 8.00 ms (8001 pts)</p> <p>2 Metrics</p> <table border="1"> <tr> <td>Occupied Bandwidth</td> <td>36.040 MHz</td> <td>Total Power</td> <td>22.9 dBm</td> </tr> <tr> <td>Transmit Freq Error</td> <td>-25.194 kHz</td> <td>% of OBW Power</td> <td>99.00 %</td> </tr> <tr> <td>x dB Bandwidth</td> <td>36.42 MHz</td> <td>x dB</td> <td>-6.00 dB</td> </tr> </table> <p>Feb 01, 2021 10:40:42 PM</p>			Occupied Bandwidth	36.040 MHz	Total Power	22.9 dBm	Transmit Freq Error	-25.194 kHz	% of OBW Power	99.00 %	x dB Bandwidth	36.42 MHz	x dB	-6.00 dB
Occupied Bandwidth	36.040 MHz	Total Power	22.9 dBm											
Transmit Freq Error	-25.194 kHz	% of OBW Power	99.00 %											
x dB Bandwidth	36.42 MHz	x dB	-6.00 dB											

Test Mode	Test Channel	Verdict												
11N40 MIMO	HCH	PASS												
<p>Spectrum Analyzer 1 Occupied BW</p> <p>KEYSIGHT Input: RF Input Z: 50 Ω Atten: 40 dB Trig: Free Run Center Freq: 2.452000000 GHz Coupling: DC Corrections: Off Preamp: Off Gate: Off Avg/Hold: 10/10 Align: Auto/No RF Freq Ref: Int (S) #IF Gain: Low Radio Std: None</p> <p>1 Graph Scale/Div 10.0 dB Ref Lvl Offset 15.01 dB Mkr1 2.4560 GHz Log Ref Value 30.00 dBm 0.23 dBm</p> <p>Center 2.452 GHz #Video BW 300.00 kHz Span 80 MHz #Res BW 100.00 kHz Sweep Time 8.00 ms (8001 pts)</p> <p>2 Metrics</p> <table border="1"> <tr> <td>Occupied Bandwidth</td> <td>36.061 MHz</td> <td>Total Power</td> <td>22.9 dBm</td> </tr> <tr> <td>Transmit Freq Error</td> <td>-28.455 kHz</td> <td>% of OBW Power</td> <td>99.00 %</td> </tr> <tr> <td>x dB Bandwidth</td> <td>36.42 MHz</td> <td>x dB</td> <td>-6.00 dB</td> </tr> </table> <p>Feb 01, 2021 10:42:43 PM</p>			Occupied Bandwidth	36.061 MHz	Total Power	22.9 dBm	Transmit Freq Error	-28.455 kHz	% of OBW Power	99.00 %	x dB Bandwidth	36.42 MHz	x dB	-6.00 dB
Occupied Bandwidth	36.061 MHz	Total Power	22.9 dBm											
Transmit Freq Error	-28.455 kHz	% of OBW Power	99.00 %											
x dB Bandwidth	36.42 MHz	x dB	-6.00 dB											

7.3. CONDUCTED OUTPUT POWER

LIMITS

FCC Part15 (15.247) , Subpart C			
Section	Test Item	Limit	Frequency Range (MHz)
FCC 15.247(b)(3)	Conducted Output Power	1 watt or 30dBm	2400-2483.5
1. If transmitting antennas of directional gain greater than 6 dBi are used, both the maximum conducted output power and the maximum power spectral density shall be reduced by the amount in dB that the directional gain of the antenna exceeds 6dBi.			

TEST PROCEDURE

Place the EUT on the table and set it in the transmitting mode.
Remove the antenna from the EUT and then connect a low loss RF cable from the antenna port to the Power sensor.
Measure the power of each channel.
AVG Detector use for AVG result.

TEST SETUP

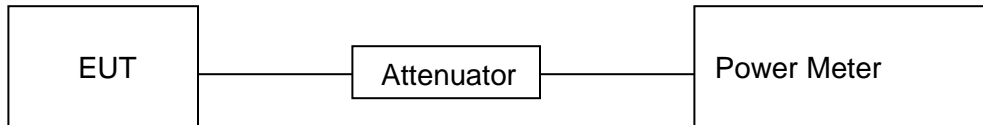



RESULTS

Test Mode	Test Antenna	Test Channel	Maximum Average Conducted Output Power (dBm)	Result
11B	Antenna 1	LCH	18.26	Pass
		MCH	17.67	Pass
		HCH	17.58	Pass
	Antenna 2	LCH	17.84	Pass
		MCH	17.51	Pass
		HCH	17.33	Pass
11G	Antenna 1	LCH	16.02	Pass
		MCH	16.22	Pass
		HCH	16.18	Pass
	Antenna 2	LCH	16.69	Pass
		MCH	16.02	Pass
		HCH	15.87	Pass
11N20MIMO	Antenna 1	LCH	15.84	Pass
		MCH	16.03	Pass
		HCH	16.01	Pass
	Antenna 2	LCH	16.60	Pass
		MCH	15.93	Pass
		HCH	15.79	Pass
	Antenna 1+2	LCH	19.25	Pass
		MCH	18.99	Pass
		HCH	18.91	Pass
11N40MIMO	Antenna 1	LCH	15.24	Pass
		MCH	15.54	Pass
		HCH	15.72	Pass
	Antenna 2	LCH	16.36	Pass
		MCH	16.14	Pass
		HCH	16.22	Pass
	Antenna 1+2	LCH	18.85	Pass
		MCH	18.86	Pass
		HCH	18.99	Pass

Remark:

- 1) For this product, it has two antennas, antenna1 and antenna2, but only the 802.11N HT20 and 802.11N HT40 modes can support both the SISO and MIMO technical.
- 2) Through pre-testing all the test modes of 11N 20 and 11N40, including SISO and MIMO, but only the data if worse case is included in this test report.

7.4. POWER SPECTRAL DENSITY

LIMITS

FCC Part15 (15.247) , Subpart C			
Section	Test Item	Limit	Frequency Range (MHz)
FCC §15.247 (e)	Power Spectral Density	8 dBm in any 3 kHz band	2400-2483.5
1. If transmitting antennas of directional gain greater than 6 dBi are used, both the maximum conducted output power and the maximum power spectral density shall be reduced by the amount in dB that the directional gain of the antenna exceeds 6dBi.			

TEST PROCEDURE

Refer to FCC KDB 558074, connect the UUT to the spectrum analyser and use the following settings:

Center Frequency	The centre frequency of the channel under test
Detector	Peak
RBW	$3 \text{ kHz} \leq \text{RBW} \leq 100 \text{ kHz}$
VBW	$\geq 3 \times \text{RBW}$
Span	1.5 x DTS bandwidth
Trace	Max hold
Sweep time	Auto couple.

Allow trace to fully stabilize and use the peak marker function to determine the maximum amplitude level within the RBW.

If measured value exceeds limit, reduce RBW (no less than 3 kHz) and repeat.

TEST ENVIRONMENT

Temperature	22°C	Relative Humidity	56%
Atmosphere Pressure	101kPa	Test Voltage	AC 120V

TEST SETUP

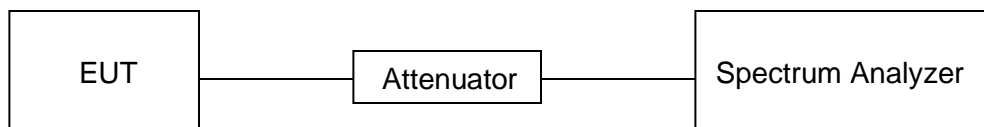



RESULTS

Test Mode	Test Antenna	Test Channel	Maximum Peak power spectral density(dBm/30kHz)	Result
11B	Antenna 1	LCH	3.30	Pass
		MCH	2.74	Pass
		HCH	2.63	Pass
	Antenna 2	LCH	2.93	Pass
		MCH	2.54	Pass
		HCH	2.40	Pass
11G	Antenna 1	LCH	-1.29	Pass
		MCH	-0.99	Pass
		HCH	-0.94	Pass
	Antenna 2	LCH	-0.44	Pass
		MCH	-1.10	Pass
		HCH	-1.18	Pass
11N20MIMO	Antenna 1	LCH	-1.12	Pass
		MCH	-0.88	Pass
		HCH	-0.84	Pass
	Antenna 2	LCH	-0.31	Pass
		MCH	-0.88	Pass
		HCH	-1.13	Pass
	Antenna 1+2	LCH	2.31	Pass
		MCH	2.13	Pass
		HCH	2.03	Pass
11N40MIMO	Antenna 1	LCH	-4.33	Pass
		MCH	-4.12	Pass
		HCH	-3.38	Pass
	Antenna 2	LCH	-3.22	Pass
		MCH	-2.92	Pass
		HCH	-2.47	Pass
	Antenna 1+2	LCH	-0.73	Pass
		MCH	-0.47	Pass
		HCH	0.11	Pass

Remark:

- 1) For this product, it has two antennas, antenna1 and antenna2, but only the 802.11N HT20 and 802.11N HT40 modes can support both the SISO and MIMO technical.
- 2) Through pre-testing all the test modes of 11N 20 and 11N40, including SISO and MIMO, but only the data if worse case is included in this test report.



Test Graphs:

Antenna1:

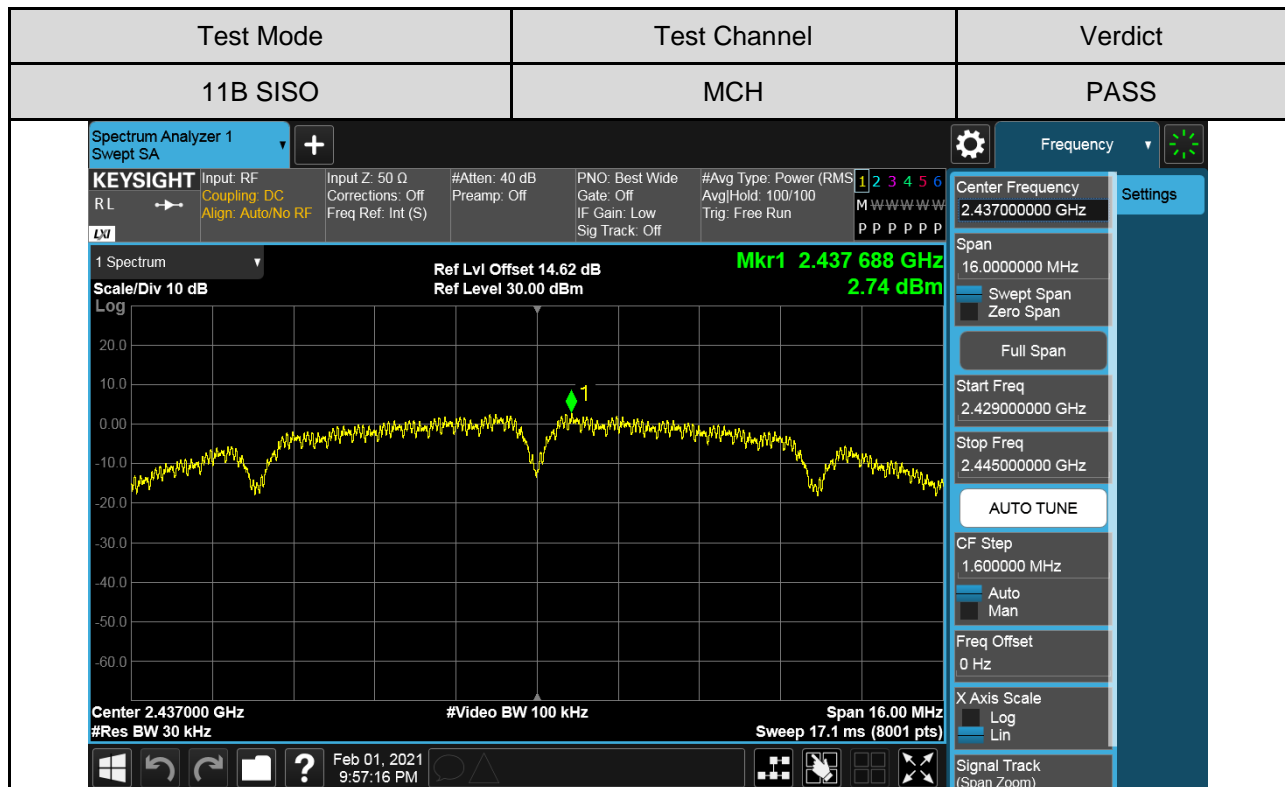
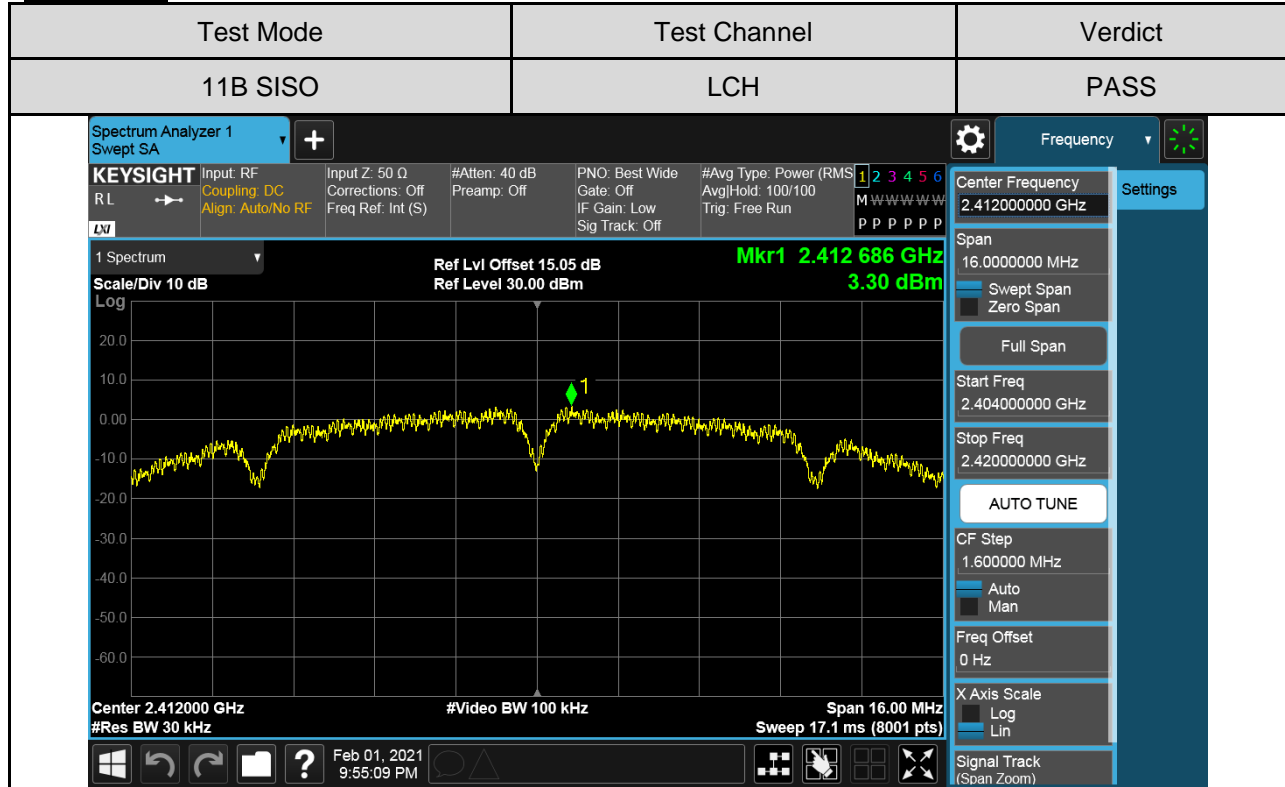

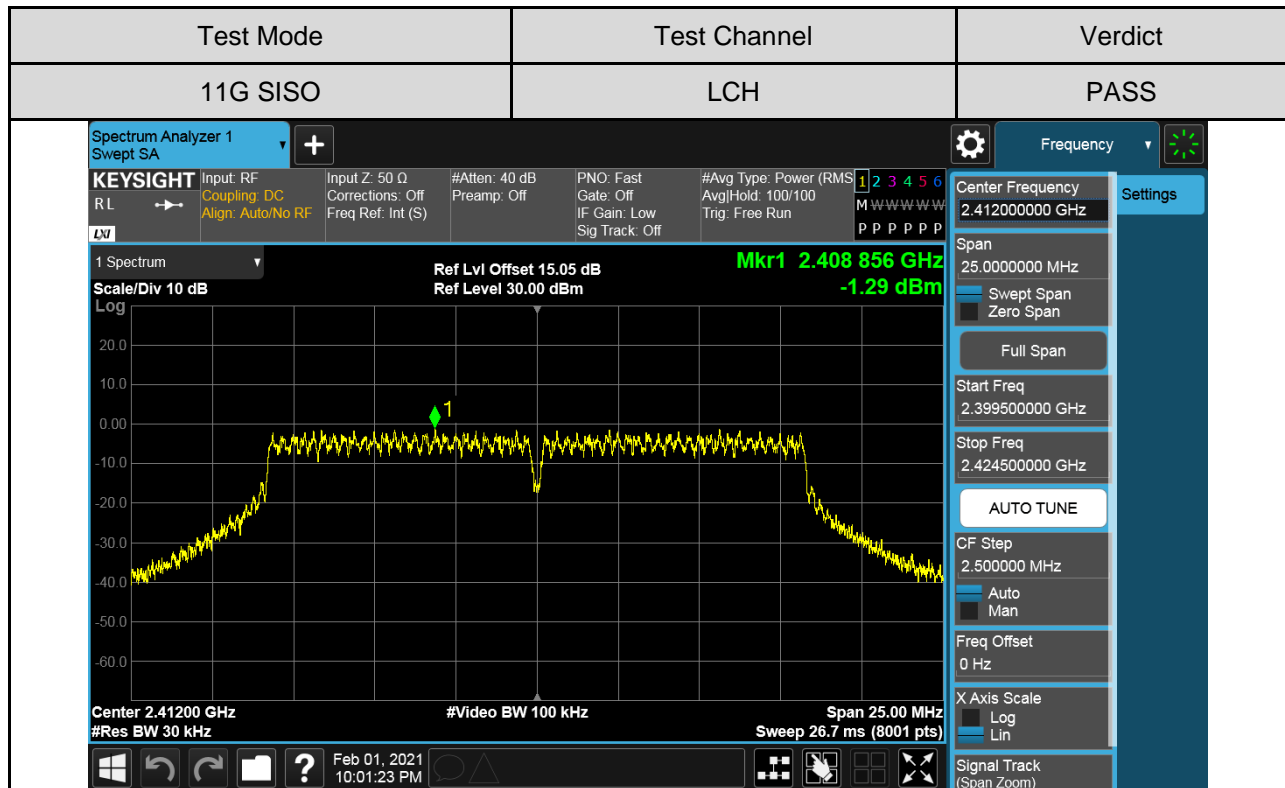
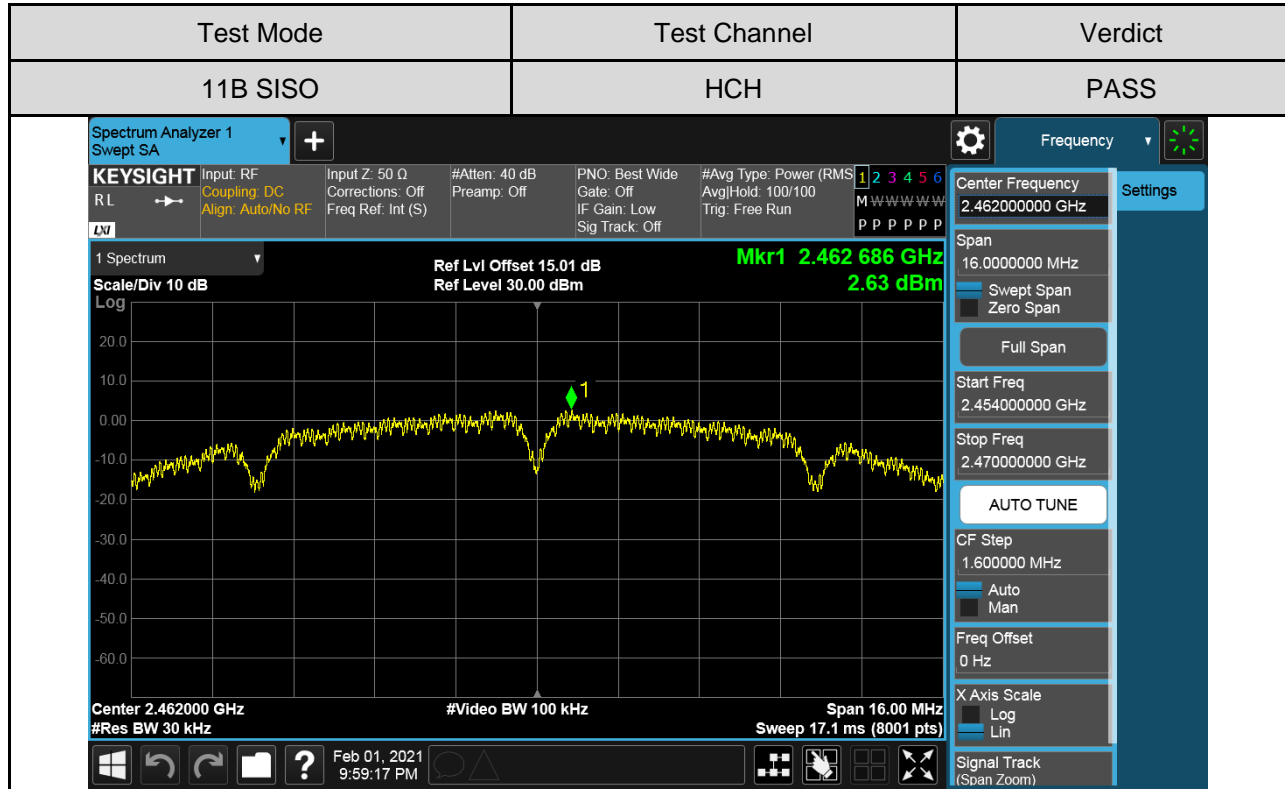

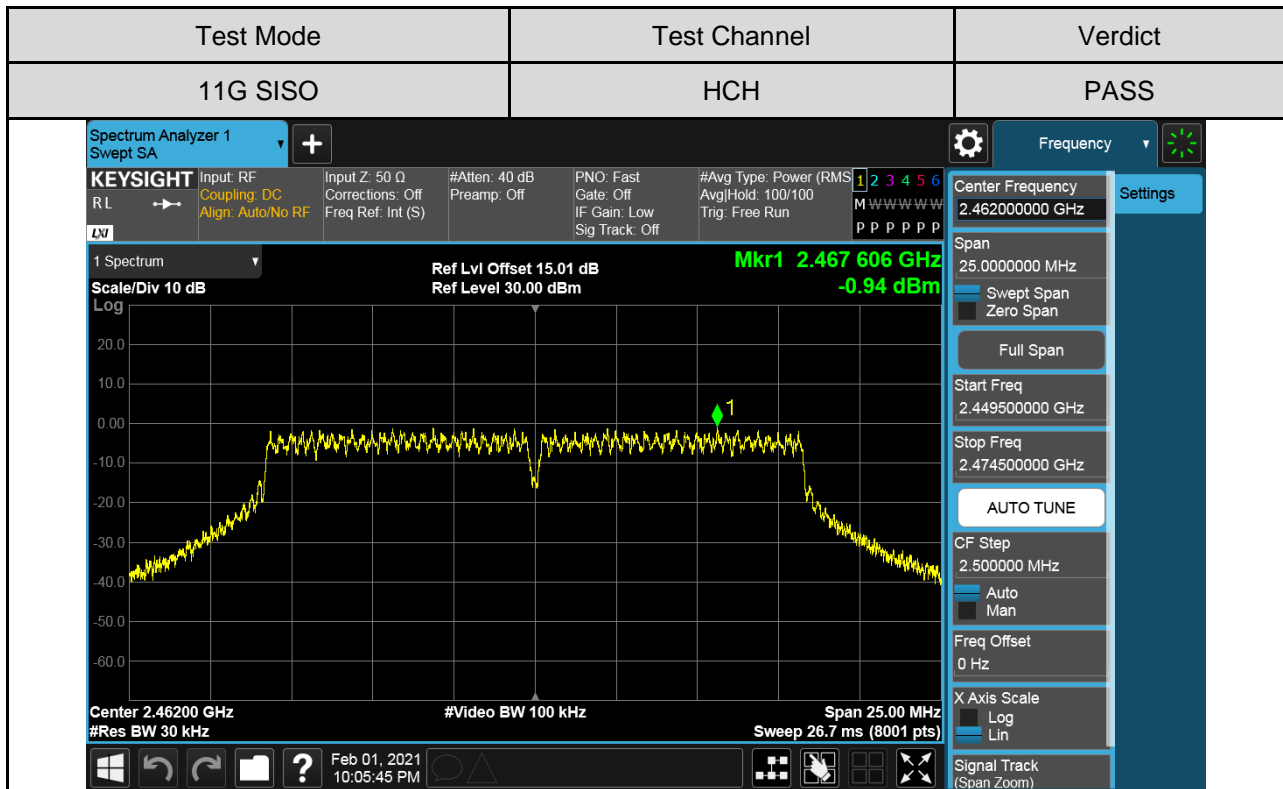
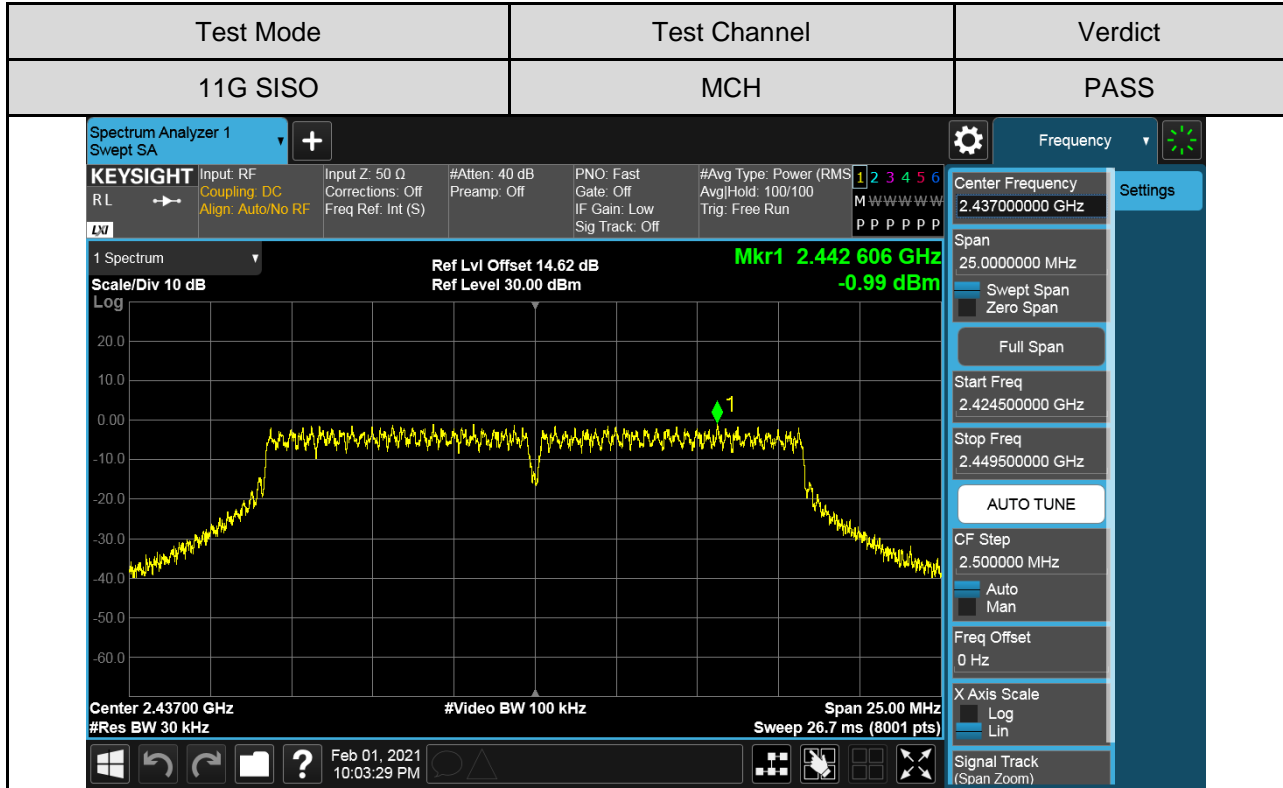

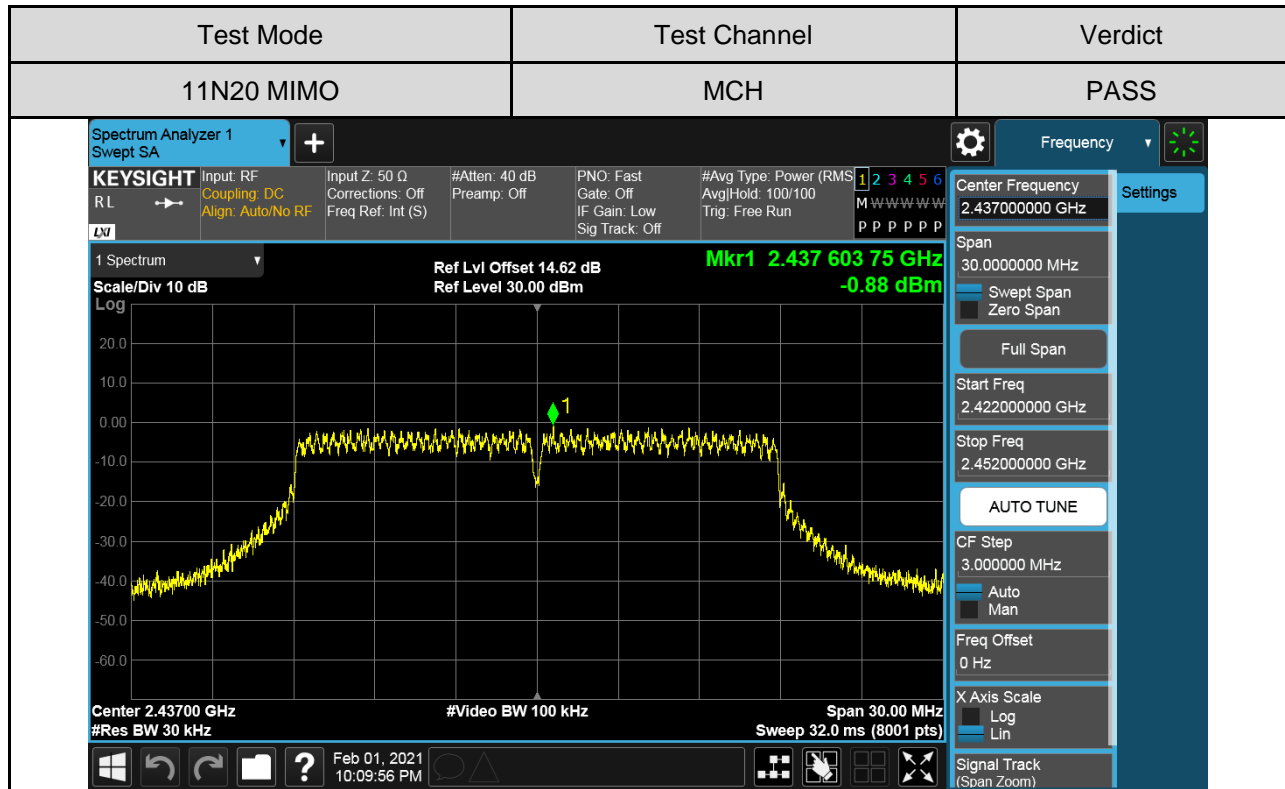
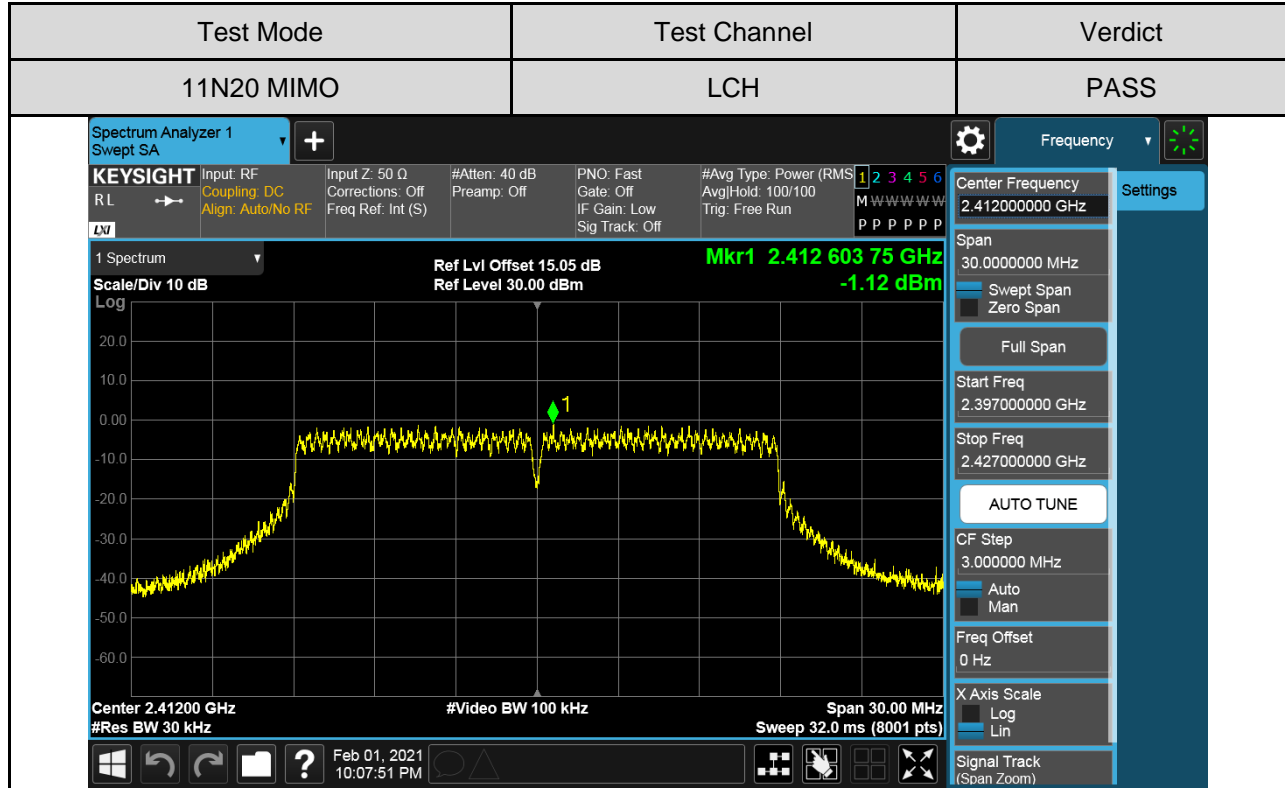

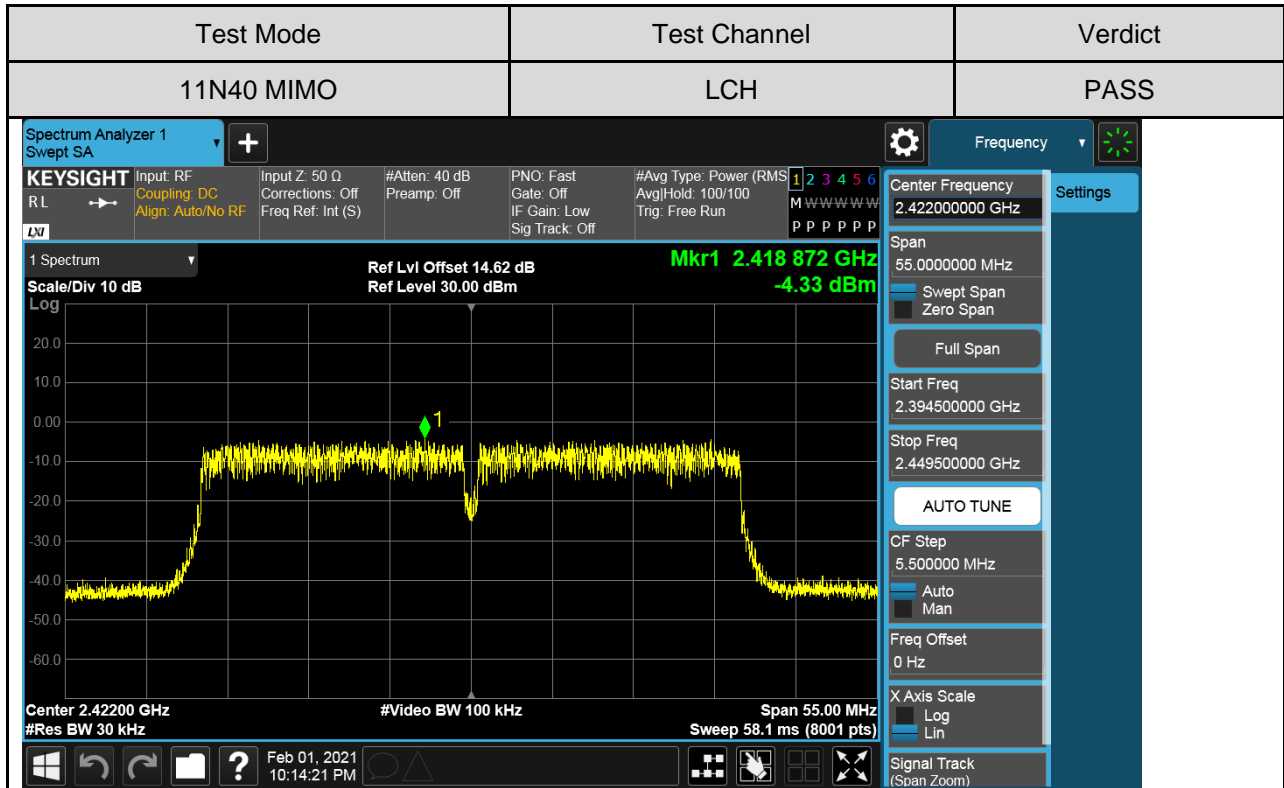
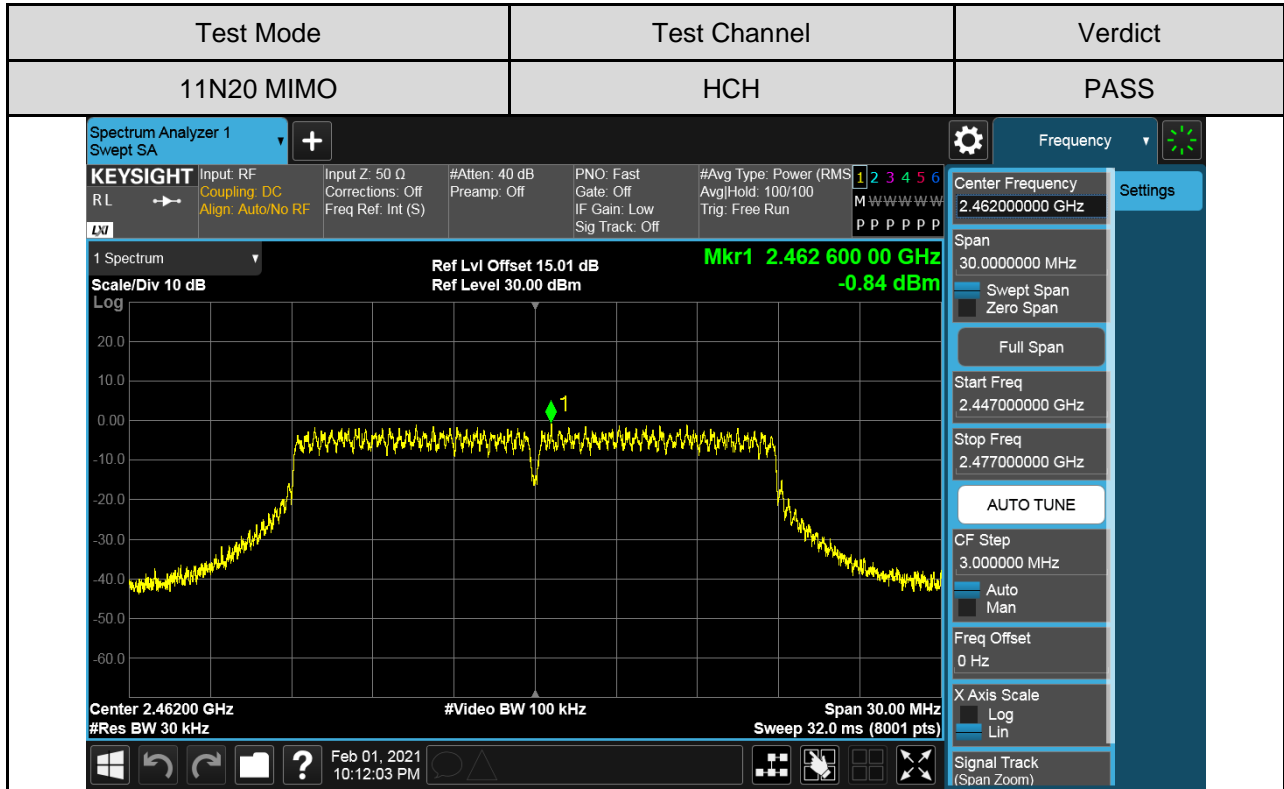

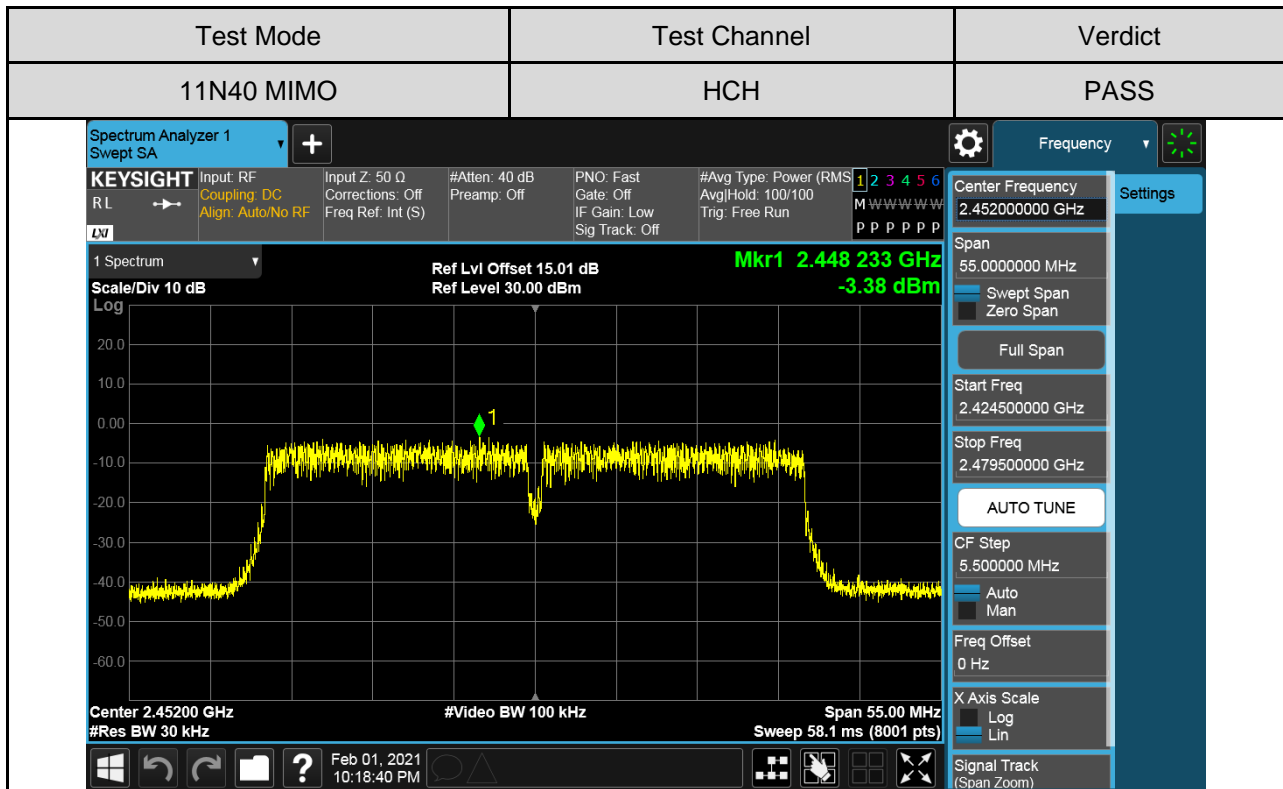
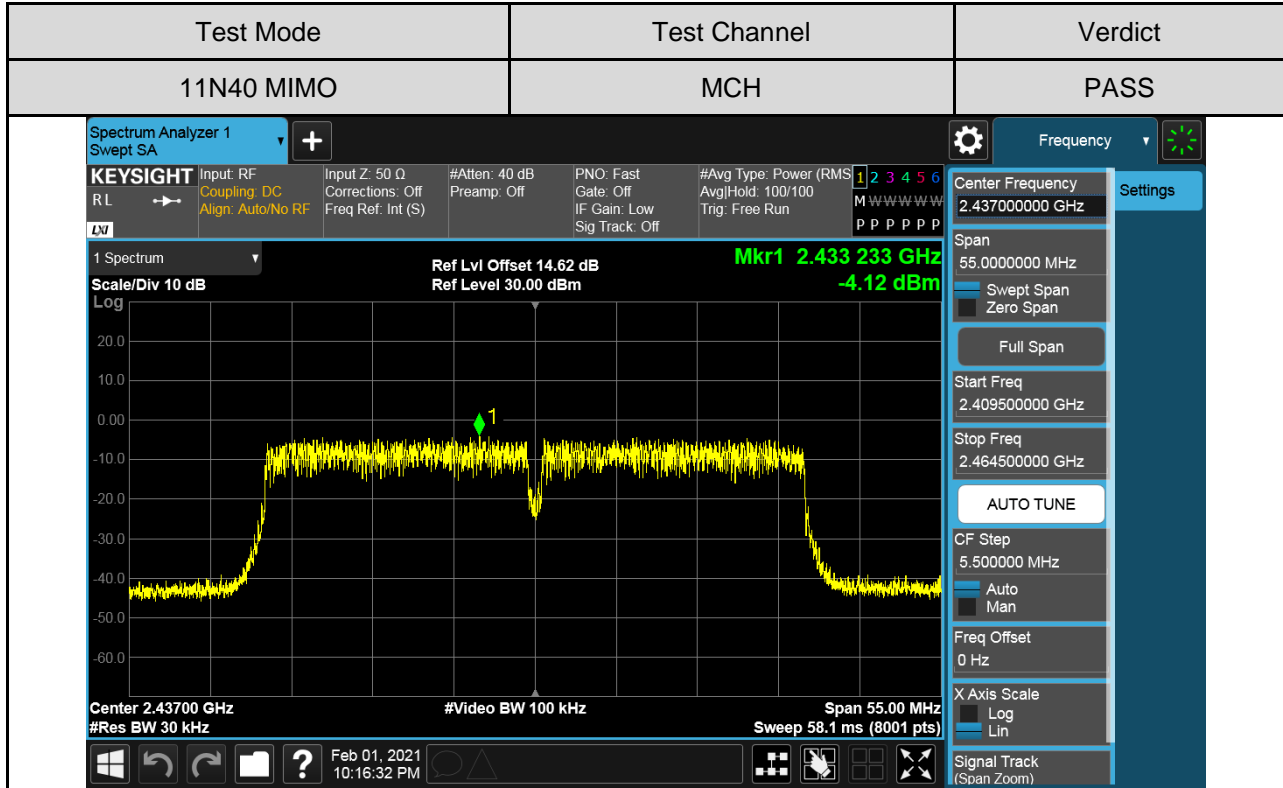



Antenna2:

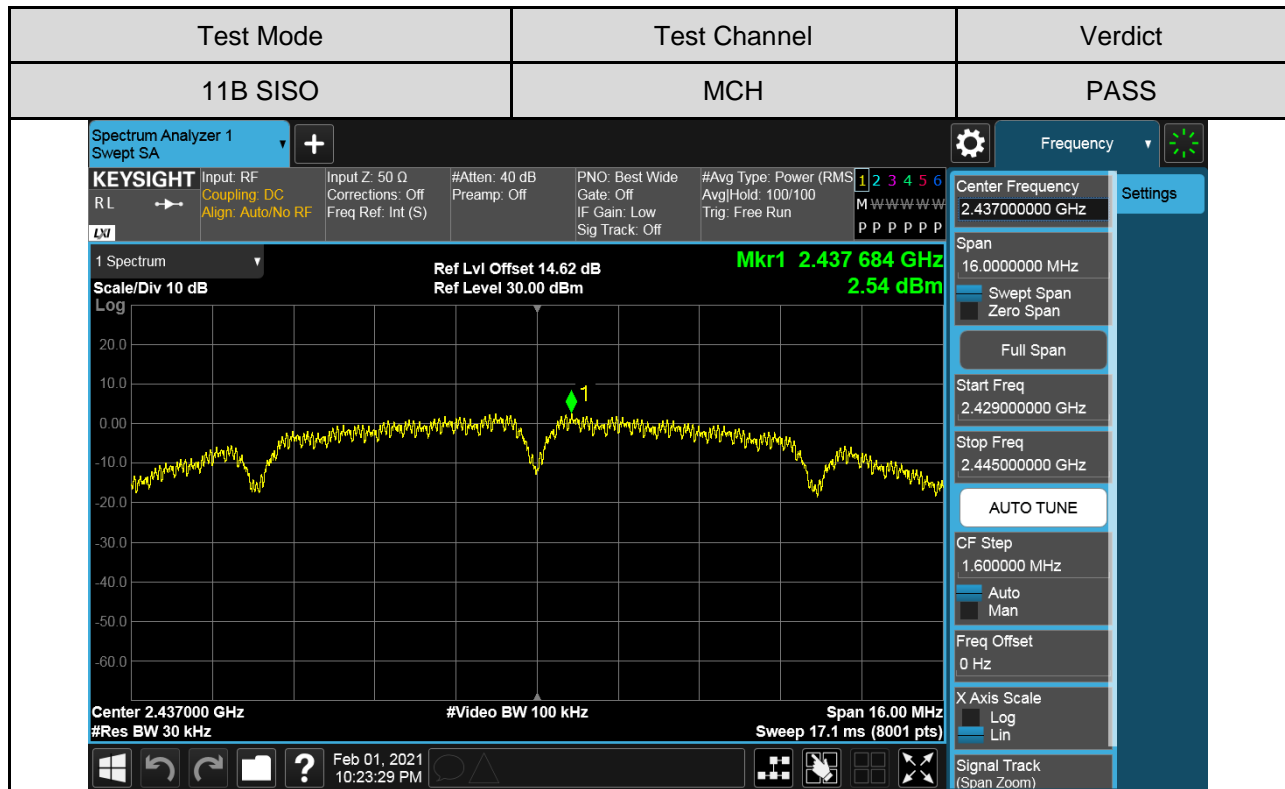
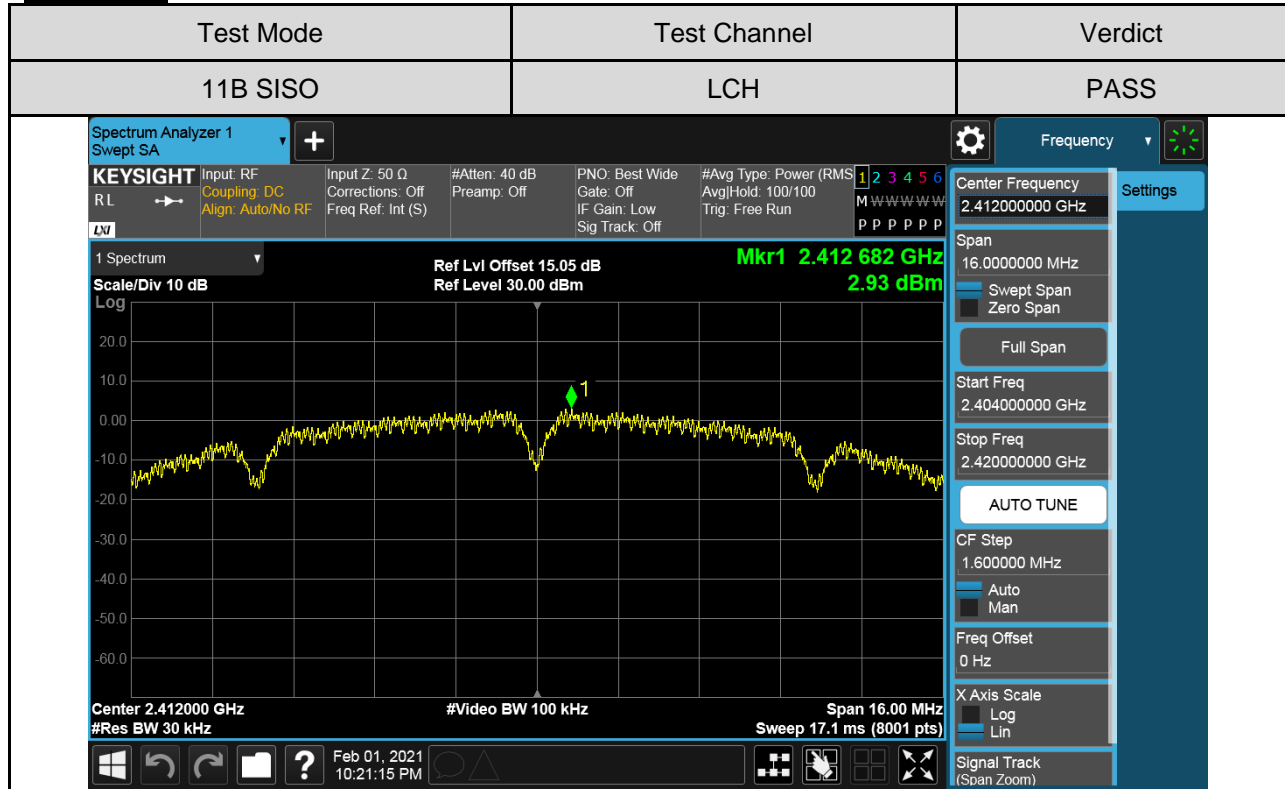

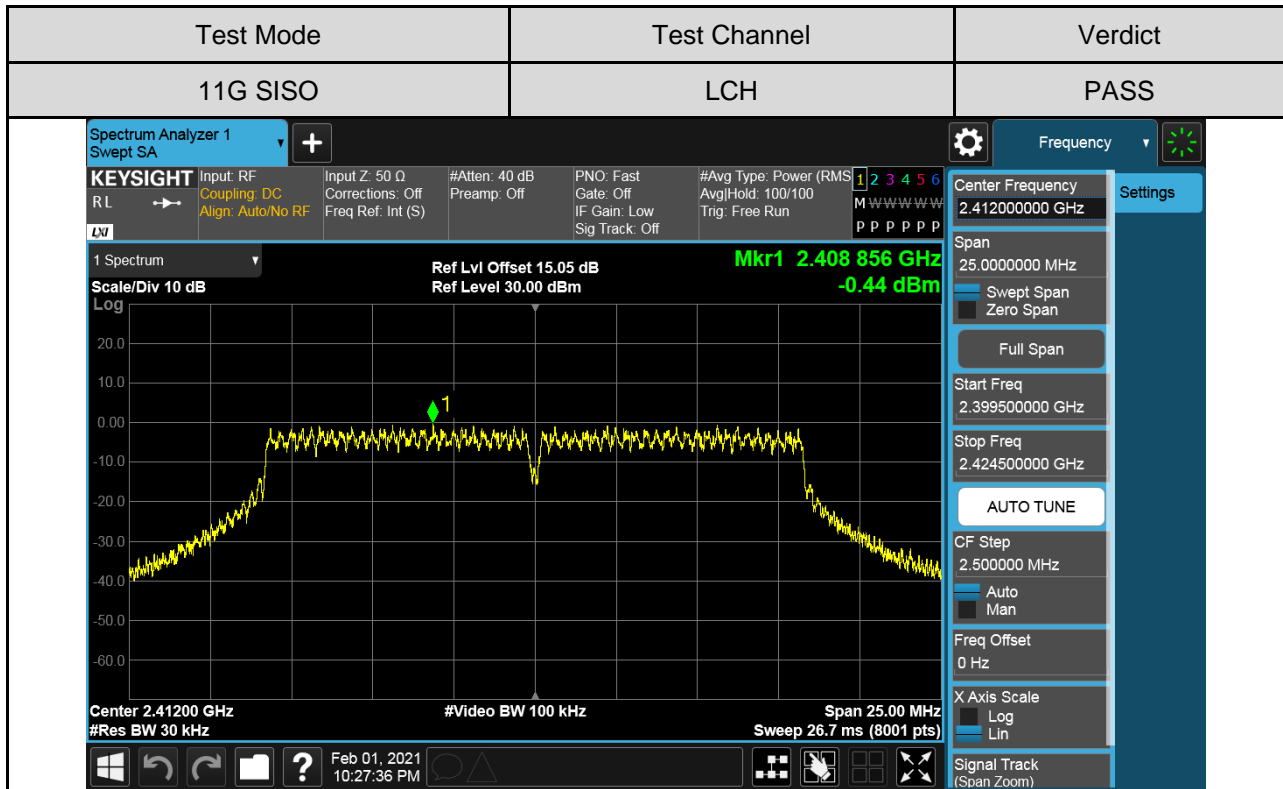
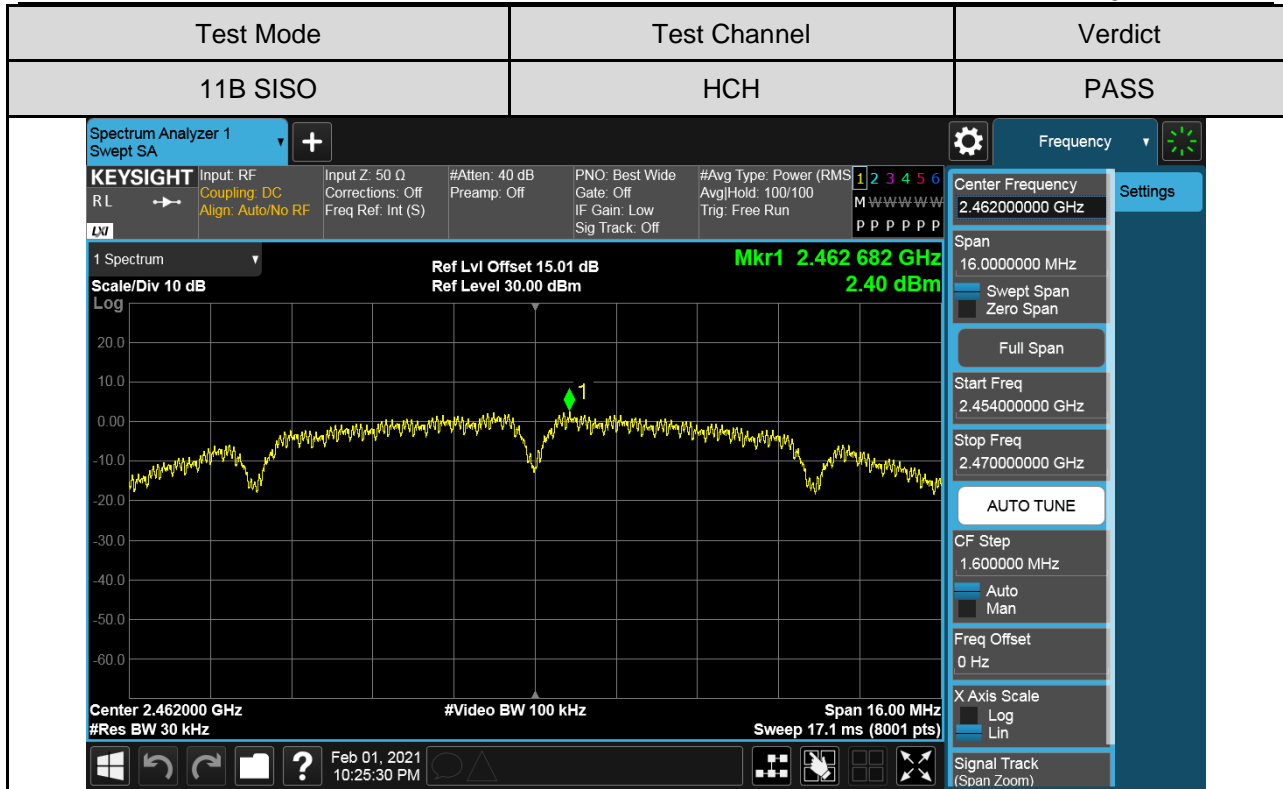

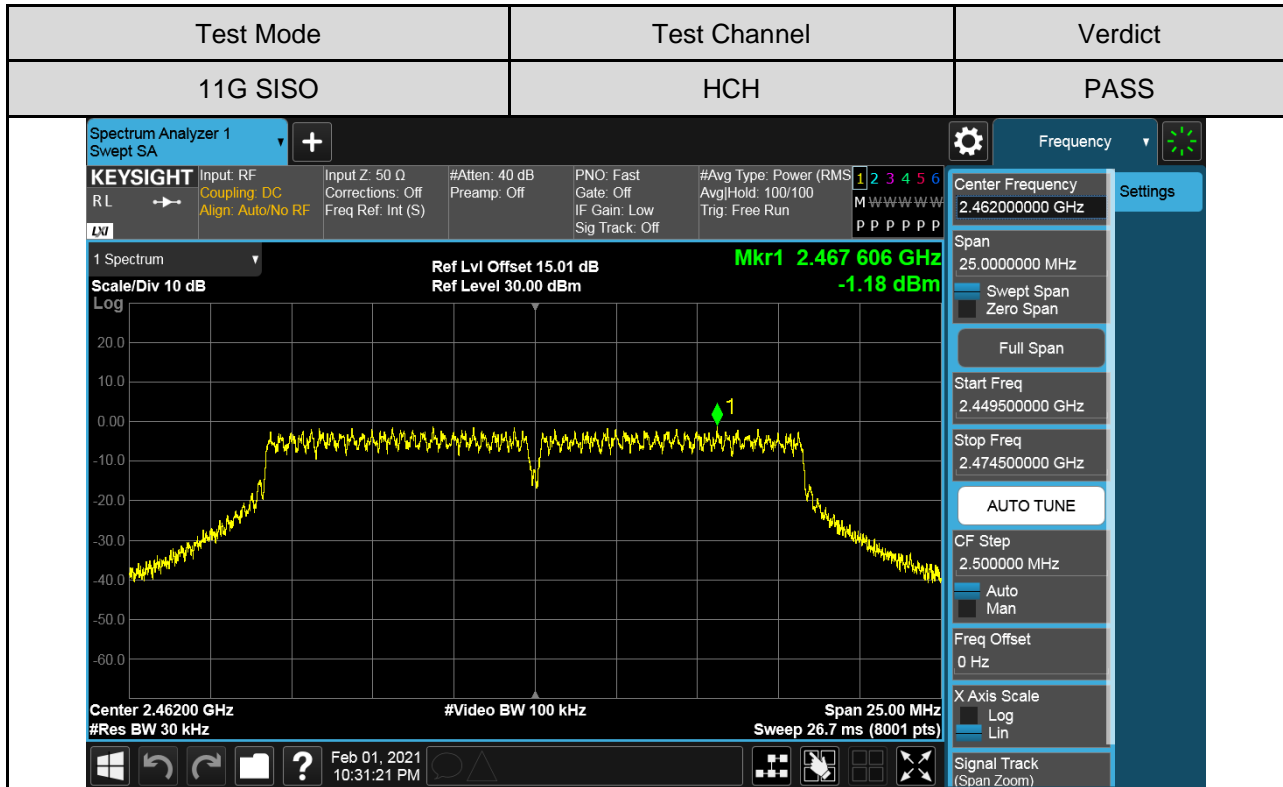
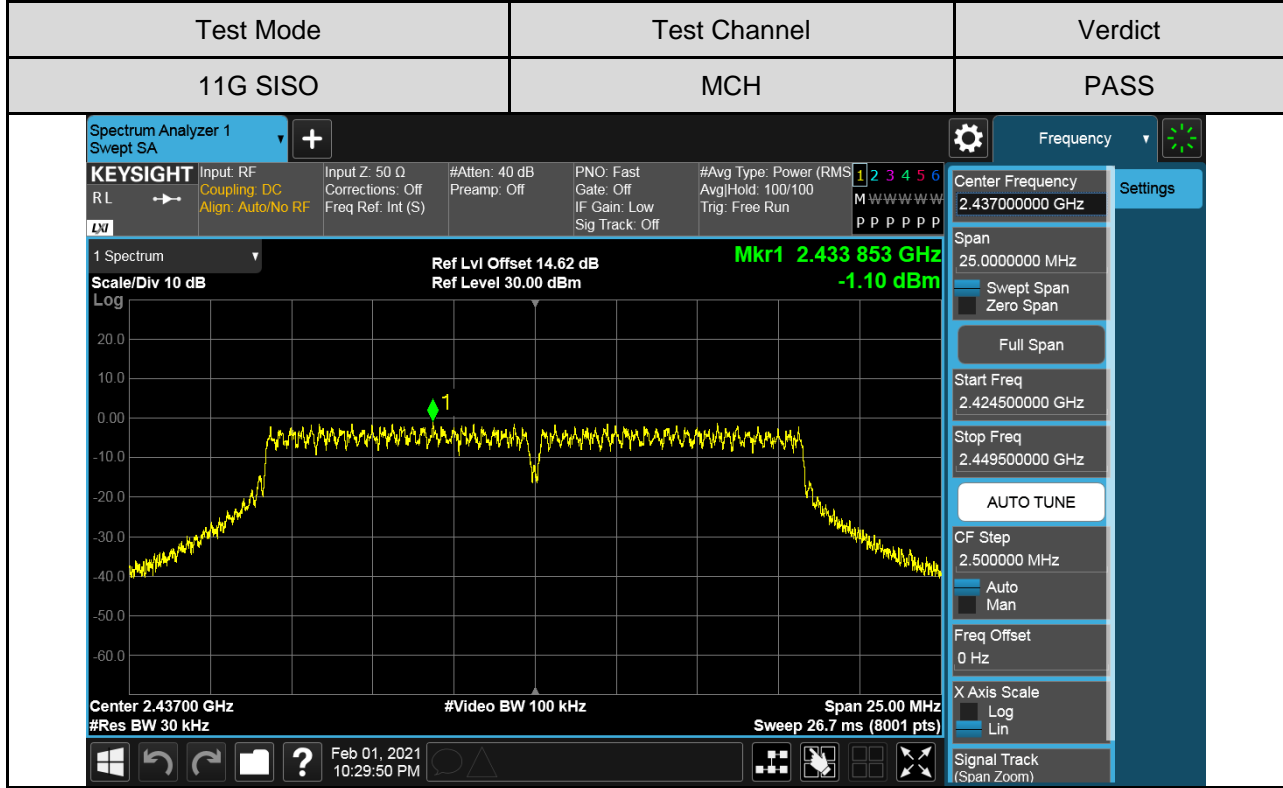

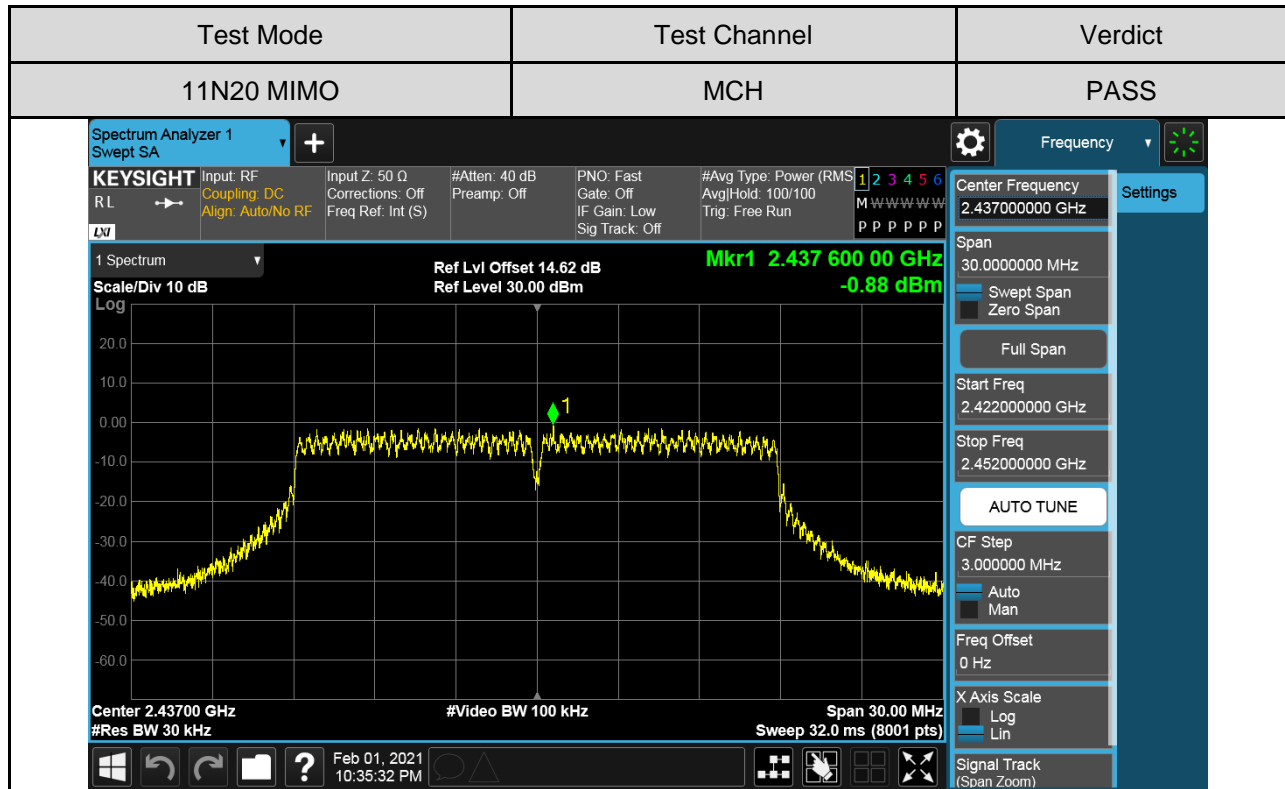
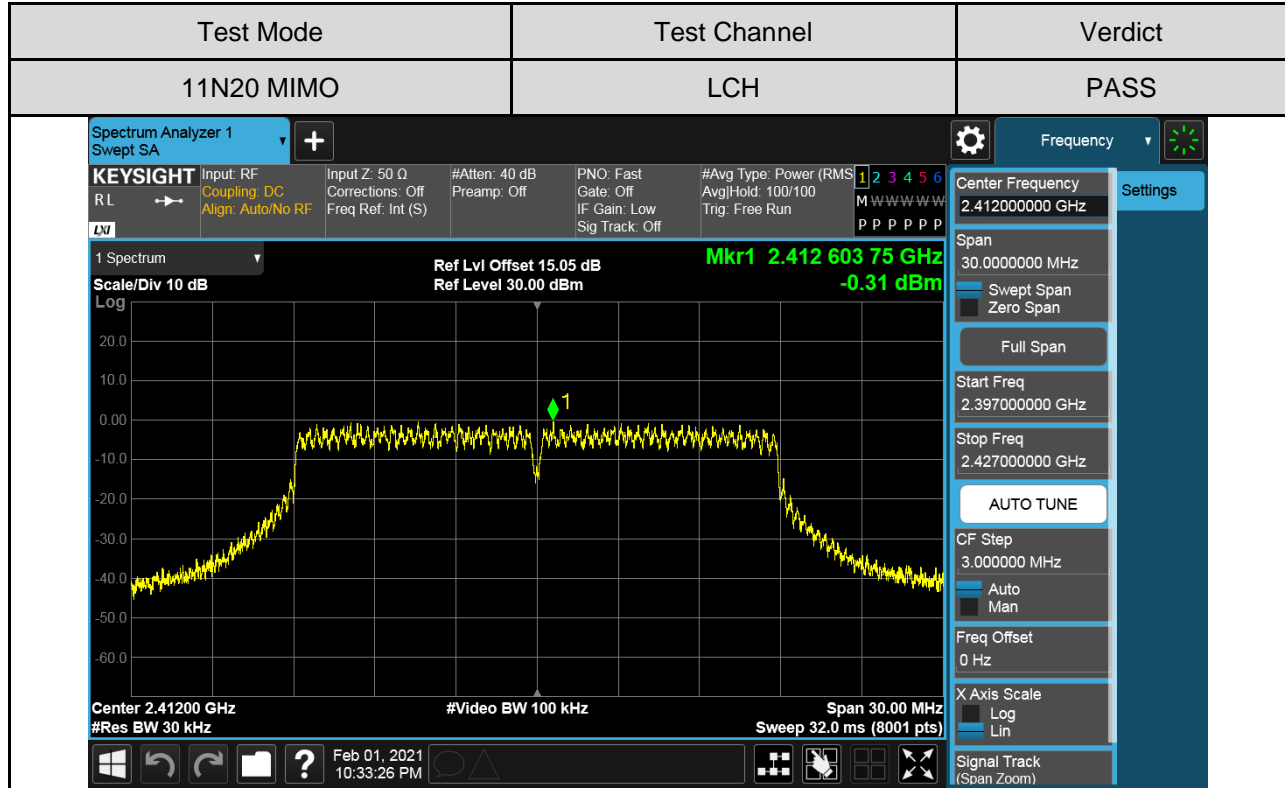

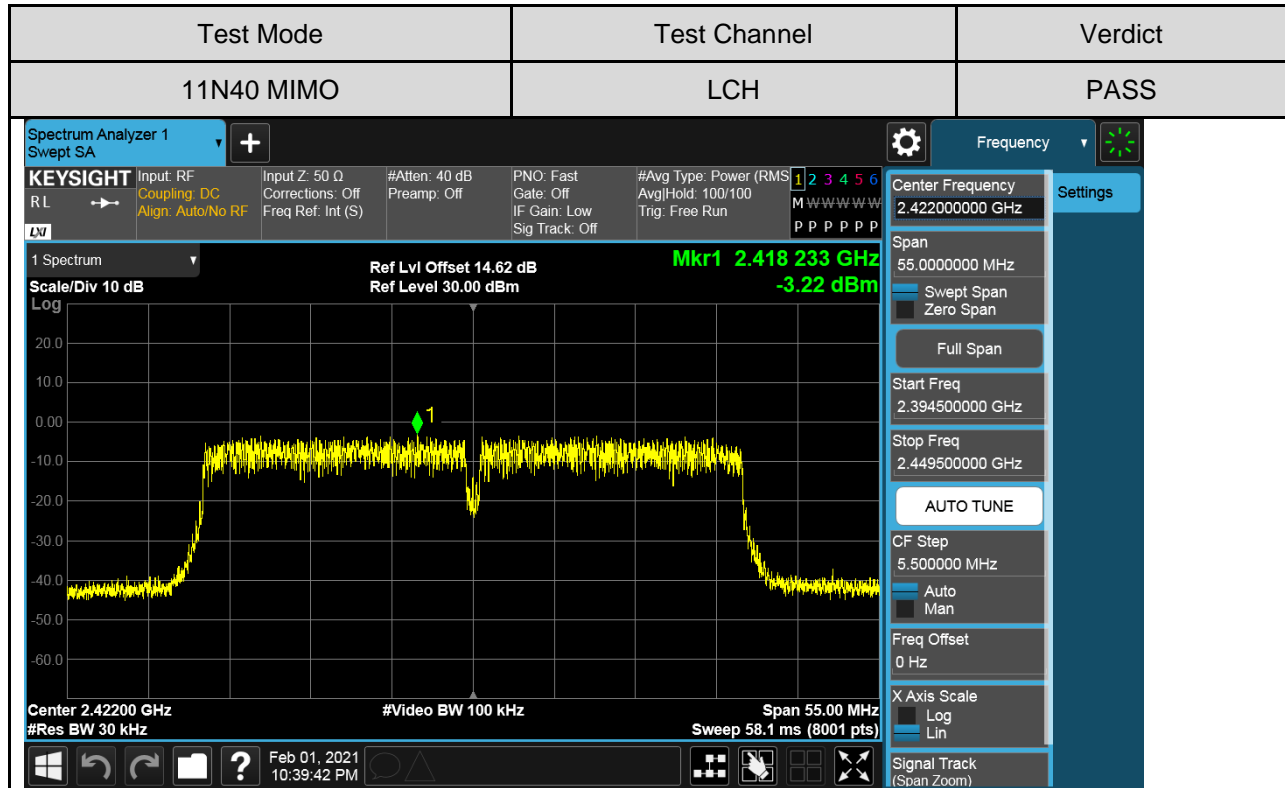
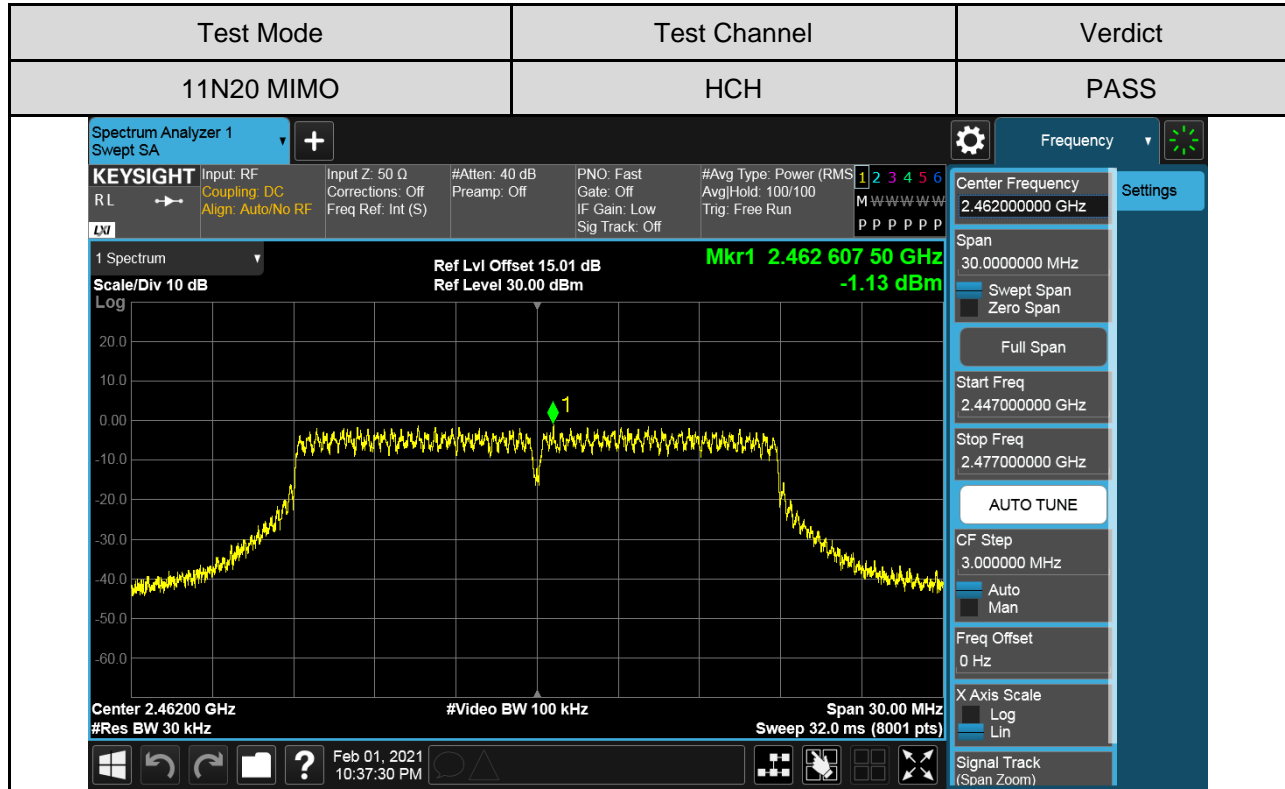

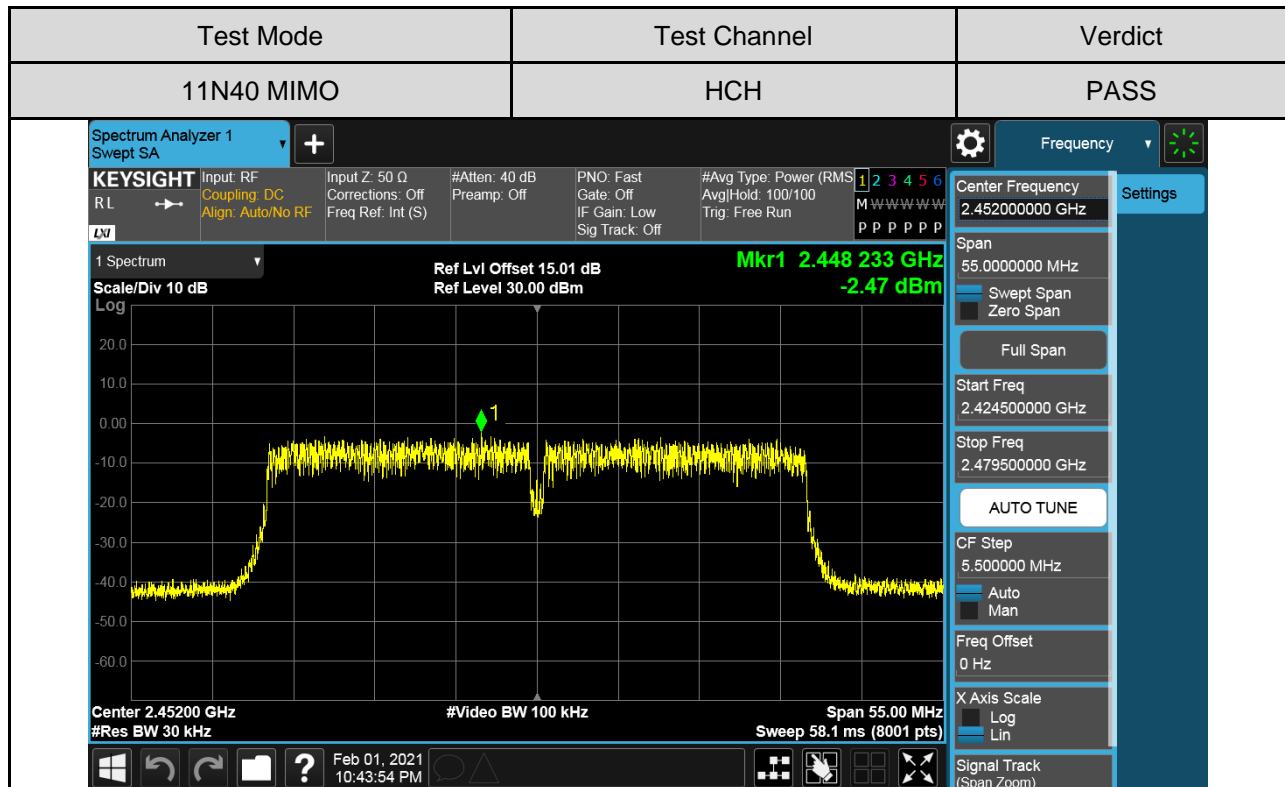
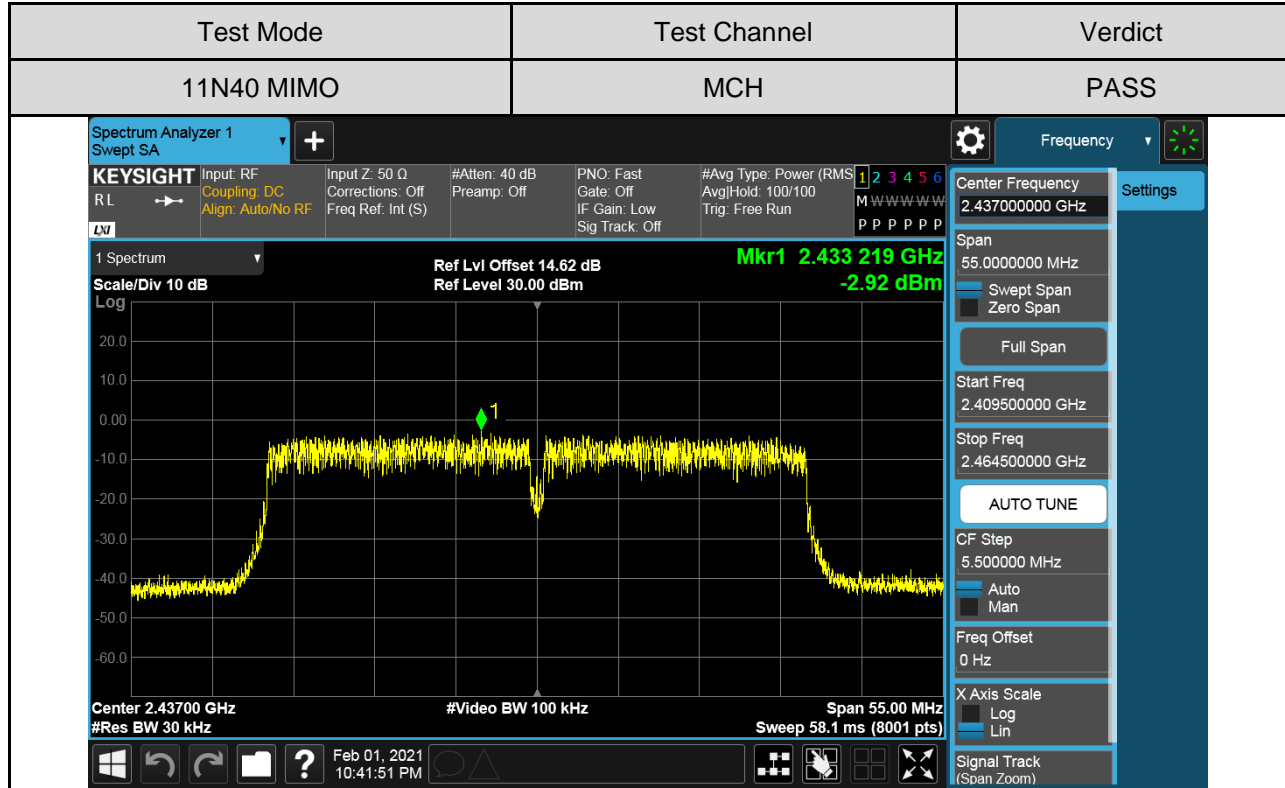

7.5. CONDUCTED BANDEDGE AND SPURIOUS EMISSIONS

LIMITS

FCC Part15 (15.247) , Subpart C		
Section	Test Item	Limit
FCC §15.247 (d)	Conducted Bandedge and Spurious Emissions	At least 30 dB below that in the 100 kHz bandwidth within the band that contains the highest level of the desired power

TEST PROCEDURE

Refer to FCC KDB 558074, connect the UUT to the spectrum analyzer and use the following

Center Frequency	The centre frequency of the channel under test
Detector	Peak
RBW	100K
VBW	$\geq 3 \times \text{RBW}$
Span	1.5 x DTS bandwidth
Trace	Max hold
Sweep time	Auto couple.

settings:

Use the peak marker function to determine the maximum PSD level.

Span	Set the center frequency and span to encompass frequency range to be measured
Detector	Peak
RBW	100K
VBW	$\geq 3 \times \text{RBW}$
measurement points	$\geq \text{span}/\text{RBW}$
Trace	Max hold
Sweep time	Auto couple.

Use the peak marker function to determine the maximum amplitude level.

TEST SETUP

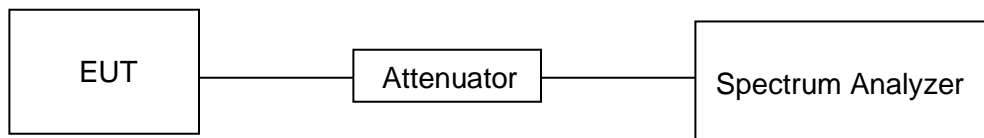



TEST ENVIRONMENT

Temperature	22°C	Relative Humidity	56%
Atmosphere Pressure	101kPa	Test Voltage	AC 120V



Part I :Conducted Bandedge

RESULTS TABLE

Test Mode	Test Antenna	Test Channel	Carrier Power[dBm]	Max. Spurious Level [dBm]	Limit [dBm]	Verdict
11B	Antenna 1	LCH	8.404	-34.70	-21.60	PASS
		HCH	7.785	-34.87	-22.22	PASS
	Antenna 2	LCH	8.021	-34.89	-21.98	PASS
		HCH	7.524	-34.99	-22.48	PASS
11G	Antenna 1	LCH	1.875	-35.21	-28.13	PASS
		HCH	2.037	-34.66	-27.96	PASS
	Antenna 2	LCH	2.328	-34.98	-27.67	PASS
		HCH	1.504	-35.10	-28.5	PASS
11N20MIMO	Antenna 1	LCH	1.813	-35.38	-28.19	PASS
		HCH	1.980	-34.96	-28.02	PASS
	Antenna 2	LCH	2.946	-35.33	-27.05	PASS
		HCH	1.599	-34.89	-28.40	PASS
11N40MIMO	Antenna 1	LCH	-0.527	-35.33	-30.53	PASS
		HCH	-0.317	-34.64	-30.32	PASS
	Antenna 2	LCH	0.156	-34.75	-29.84	PASS
		HCH	0.134	-33.63	-29.87	PASS

Remark:

- 1) For this product, it has two antennas, antenna1 and antenna2, but only the 802.11N HT20 and 802.11N HT40 modes can support both the SISO and MIMO technical.
- 2) Through pre-testing all the test modes of 11N 20 and 11N40, including SISO and MIMO, but only the data if worse case is included in this test report.