

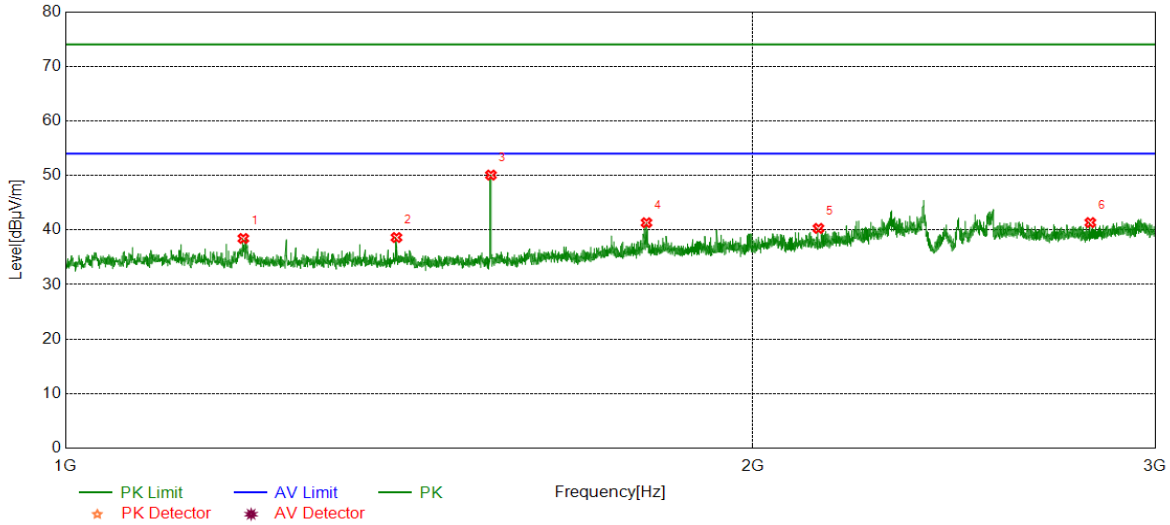

Test Mode	Channel	Polarization	Verdict
11G	MCH	Vertical	PASS



No.	Frequency	Reading Level	Correct Factor	Result	Limit	Margin	Remark
	[MHz]	[dBuV/m]	[dB]	[dBuV/m]	[dBuV/m]	[dB]	
1	1196.5246	44.01	-5.56	38.45	74.00	-35.55	Horizontal
2	1396.2995	44.32	-5.70	38.62	74.00	-35.38	Horizontal
3	1535.8170	55.82	-5.75	50.07	74.00	-23.93	Horizontal
4	1796.5996	45.14	-3.81	41.33	74.00	-32.67	Horizontal
5	2136.6421	42.66	-2.37	40.29	74.00	-33.71	Horizontal
6	2810.4763	41.59	-0.23	41.36	74.00	-32.64	Horizontal

- Note: 1. Measurement = Reading Level + Correct Factor.
 2. If Peak Result complies with AV limit, AV Result is deemed to comply with AV limit.
 3. Test setup: RBW: 1 MHz, VBW: 3 MHz, Sweep time: auto.
 4. Peak: Peak detector.
 5. For below 3GHz part, filter losses were only considered in the spurious frequency bands and the authorized band was not corrected for Band Reject Filter losses.
 6. Only the worst case emission was recorded, if it complies with the limit, the other emissions deemed to comply with the limit.



Test Mode	Channel	Polarization	Verdict
11G	HCH	Vertical	PASS

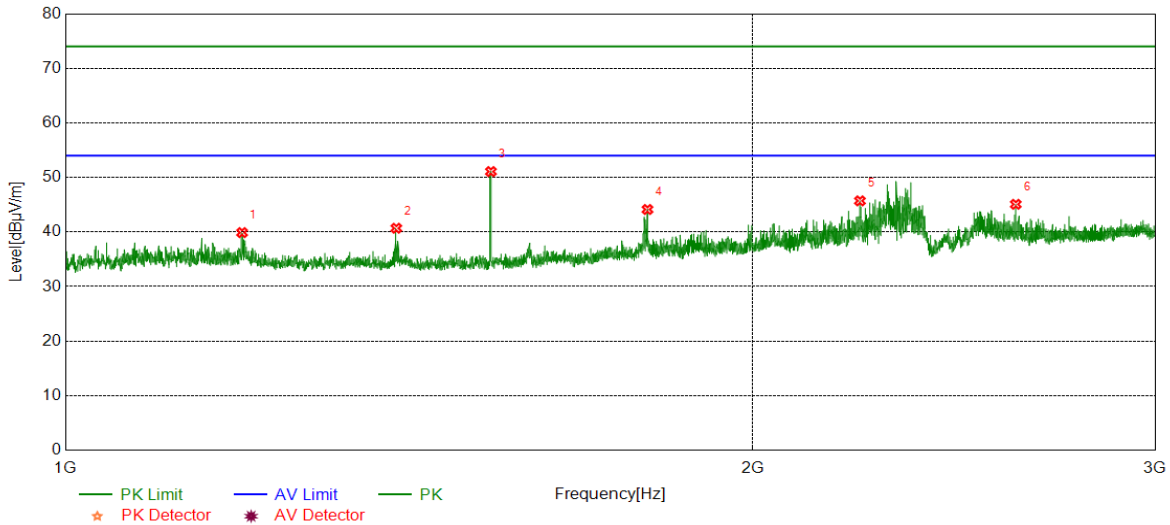

No.	Frequency	Reading Level	Correct Factor	Result	Limit	Margin	Remark
	[MHz]	[dBuV/m]	[dB]	[dBuV/m]	[dBuV/m]	[dB]	
1	1195.0244	45.46	-5.57	39.89	74.00	-34.11	Vertical
2	1396.0495	46.39	-5.70	40.69	74.00	-33.31	Vertical
3	1535.8170	56.83	-5.75	51.08	74.00	-22.92	Vertical
4	1798.3498	47.96	-3.83	44.13	74.00	-29.87	Vertical
5	2227.9035	47.89	-2.18	45.71	74.00	-28.29	Vertical
6	2606.9509	45.51	-0.43	45.08	74.00	-28.92	Vertical

- Note: 1. Measurement = Reading Level + Correct Factor.
 2. If Peak Result complies with AV limit, AV Result is deemed to comply with AV limit.
 3. Test setup: RBW: 1 MHz, VBW: 3 MHz, Sweep time: auto.
 4. Peak: Peak detector.
 5. For below 3GHz part, filter losses were only considered in the spurious frequency bands and the authorized band was not corrected for Band Reject Filter losses.
 6. Only the worst case emission was recorded, if it complies with the limit, the other emissions deemed to comply with the limit.



Test Mode	Channel	Polarization	Verdict
11N HT20	LCH	Horizontal	PASS

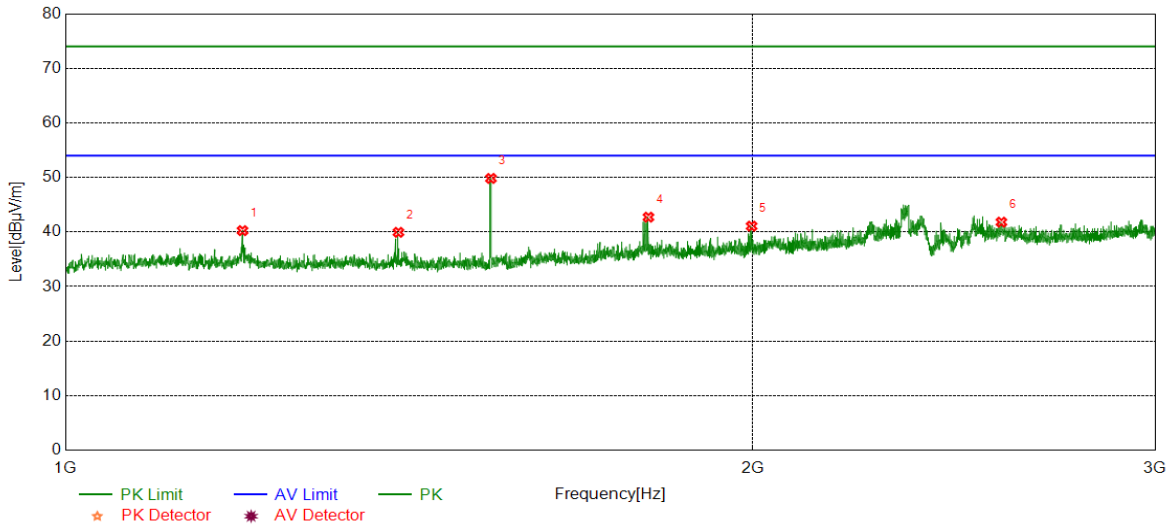

No.	Frequency	Reading Level	Correct Factor	Result	Limit	Margin	Remark
	[MHz]	[dBuV/m]	[dB]	[dBuV/m]	[dBuV/m]	[dB]	
1	1195.5244	45.81	-5.56	40.25	74.00	-33.75	Horizontal
2	1399.0499	45.61	-5.67	39.94	74.00	-34.06	Horizontal
3	1535.8170	55.57	-5.75	49.82	74.00	-24.18	Horizontal
4	1800.1000	46.57	-3.85	42.72	74.00	-31.28	Horizontal
5	1997.3747	44.09	-3.02	41.07	74.00	-32.93	Horizontal
6	2569.4462	42.60	-0.79	41.81	74.00	-32.19	Horizontal

- Note: 1. Measurement = Reading Level + Correct Factor.
 2. If Peak Result complies with AV limit, AV Result is deemed to comply with AV limit.
 3. Test setup: RBW: 1 MHz, VBW: 3 MHz, Sweep time: auto.
 4. Peak: Peak detector.
 5. For below 3GHz part, filter losses were only considered in the spurious frequency bands and the authorized band was not corrected for Band Reject Filter losses.
 6. Only the worst case emission was recorded, if it complies with the limit, the other emissions deemed to comply with the limit.



Test Mode	Channel	Polarization	Verdict
11N HT20	LCH	Vertical	PASS

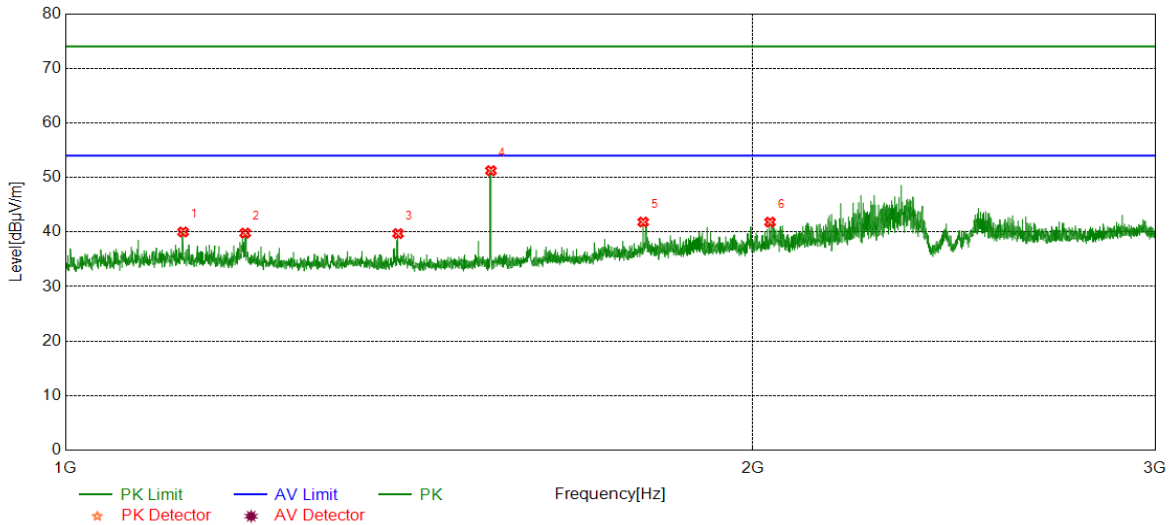

No.	Frequency	Reading Level	Correct Factor	Result	Limit	Margin	Remark
	[MHz]	[dBuV/m]	[dB]	[dBuV/m]	[dBuV/m]	[dB]	
1	1126.0158	45.48	-5.47	40.01	74.00	-33.99	Vertical
2	1198.7748	45.36	-5.56	39.80	74.00	-34.20	Vertical
3	1398.5498	45.38	-5.67	39.71	74.00	-34.29	Vertical
4	1535.8170	56.99	-5.75	51.24	74.00	-22.76	Vertical
5	1790.5988	45.57	-3.74	41.83	74.00	-32.17	Vertical
6	2034.8794	44.37	-2.56	41.81	74.00	-32.19	Vertical

- Note: 1. Measurement = Reading Level + Correct Factor.
 2. If Peak Result complies with AV limit, AV Result is deemed to comply with AV limit.
 3. Test setup: RBW: 1 MHz, VBW: 3 MHz, Sweep time: auto.
 4. Peak: Peak detector.
 5. For below 3GHz part, filter losses were only considered in the spurious frequency bands and the authorized band was not corrected for Band Reject Filter losses.
 6. Only the worst case emission was recorded, if it complies with the limit, the other emissions deemed to comply with the limit.



Test Mode	Channel	Polarization	Verdict
11N HT20	MCH	Horizontal	PASS

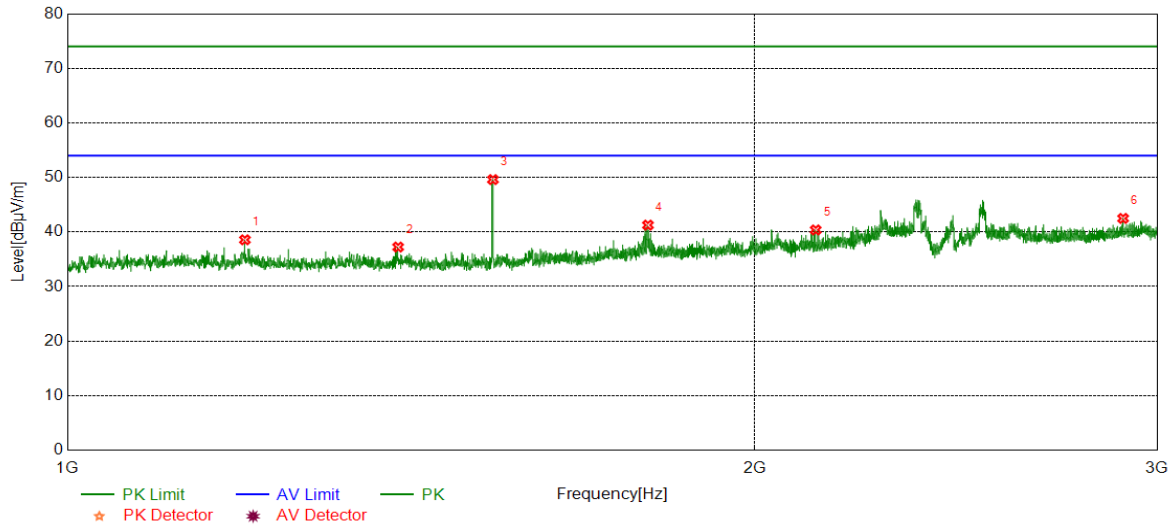

No.	Frequency	Reading Level	Correct Factor	Result	Limit	Margin	Remark
	[MHz]	[dBuV/m]	[dB]	[dBuV/m]	[dBuV/m]	[dB]	
1	1196.0245	44.13	-5.56	38.57	74.00	-35.43	Horizontal
2	1395.7995	42.95	-5.71	37.24	74.00	-36.76	Horizontal
3	1535.8170	55.36	-5.75	49.61	74.00	-24.39	Horizontal
4	1795.5995	45.06	-3.80	41.26	74.00	-32.74	Horizontal
5	2126.3908	42.73	-2.35	40.38	74.00	-33.62	Horizontal
6	2898.9874	42.14	0.35	42.49	74.00	-31.51	Horizontal

- Note: 1. Measurement = Reading Level + Correct Factor.
 2. If Peak Result complies with AV limit, AV Result is deemed to comply with AV limit.
 3. Test setup: RBW: 1 MHz, VBW: 3 MHz, Sweep time: auto.
 4. Peak: Peak detector.
 5. For below 3GHz part, filter losses were only considered in the spurious frequency bands and the authorized band was not corrected for Band Reject Filter losses.
 6. Only the worst case emission was recorded, if it complies with the limit, the other emissions deemed to comply with the limit.



Test Mode	Channel	Polarization	Verdict
11N HT20	MCH	Vertical	PASS

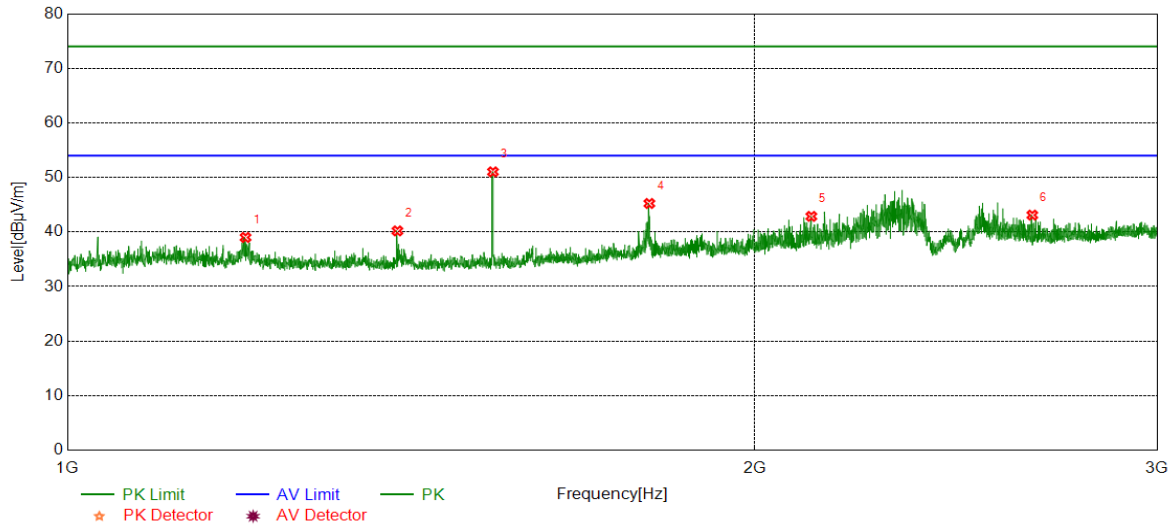

No.	Frequency	Reading Level	Correct Factor	Result	Limit	Margin	Remark
	[MHz]	[dBuV/m]	[dB]	[dBuV/m]	[dBuV/m]	[dB]	
1	1196.7746	44.56	-5.56	39.00	74.00	-35.00	Vertical
2	1394.7994	45.92	-5.72	40.20	74.00	-33.80	Vertical
3	1535.8170	56.78	-5.75	51.03	74.00	-22.97	Vertical
4	1798.0998	49.06	-3.83	45.23	74.00	-28.77	Vertical
5	2117.1396	45.31	-2.45	42.86	74.00	-31.14	Vertical
6	2645.4557	43.91	-0.81	43.10	74.00	-30.90	Vertical

- Note: 1. Measurement = Reading Level + Correct Factor.
 2. If Peak Result complies with AV limit, AV Result is deemed to comply with AV limit.
 3. Test setup: RBW: 1 MHz, VBW: 3 MHz, Sweep time: auto.
 4. Peak: Peak detector.
 5. For below 3GHz part, filter losses were only considered in the spurious frequency bands and the authorized band was not corrected for Band Reject Filter losses.
 6. Only the worst case emission was recorded, if it complies with the limit, the other emissions deemed to comply with the limit.



Test Mode	Channel	Polarization	Verdict
11N HT20	HCH	Horizontal	PASS

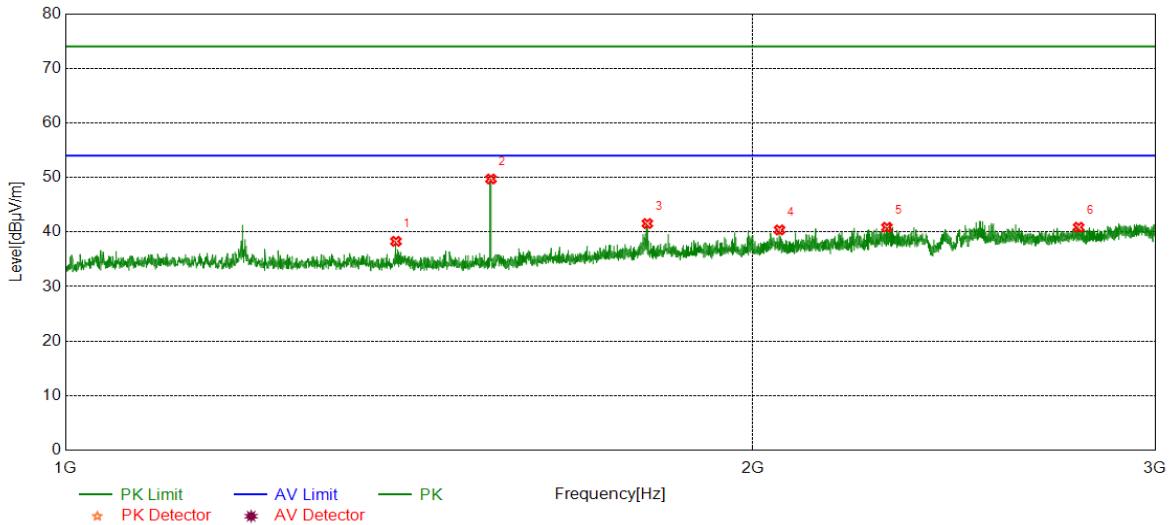

No.	Frequency	Reading Level	Correct Factor	Result	Limit	Margin	Remark
	[MHz]	[dBuV/m]	[dB]	[dBuV/m]	[dBuV/m]	[dB]	
1	1395.5494	44.00	-5.71	38.29	74.00	-35.71	Horizontal
2	1535.8170	55.47	-5.75	49.72	74.00	-24.28	Horizontal
3	1798.0998	45.38	-3.83	41.55	74.00	-32.45	Horizontal
4	2054.3818	42.87	-2.49	40.38	74.00	-33.62	Horizontal
5	2289.4112	42.80	-1.94	40.86	74.00	-33.14	Horizontal
6	2777.4722	41.13	-0.26	40.87	74.00	-33.13	Horizontal

- Note: 1. Measurement = Reading Level + Correct Factor.
 2. If Peak Result complies with AV limit, AV Result is deemed to comply with AV limit.
 3. Test setup: RBW: 1 MHz, VBW: 3 MHz, Sweep time: auto.
 4. Peak: Peak detector.
 5. For below 3GHz part, filter losses were only considered in the spurious frequency bands and the authorized band was not corrected for Band Reject Filter losses.
 6. Only the worst case emission was recorded, if it complies with the limit, the other emissions deemed to comply with the limit.



Test Mode	Channel	Polarization	Verdict
11N HT20	HCH	Vertical	PASS

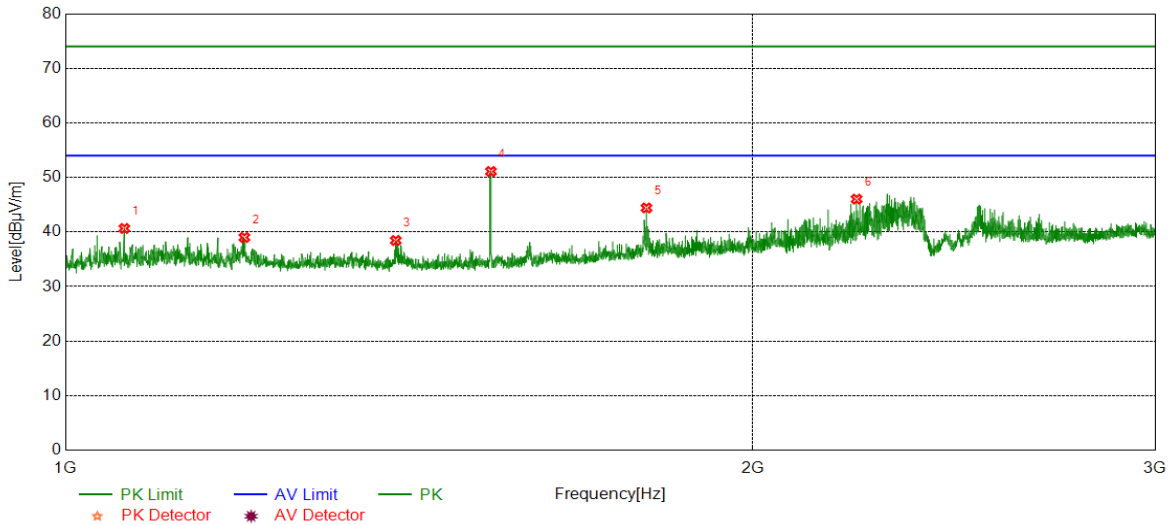

No.	Frequency	Reading Level	Correct Factor	Result	Limit	Margin	Remark
	[MHz]	[dBuV/m]	[dB]	[dBuV/m]	[dBuV/m]	[dB]	
1	1061.2577	46.20	-5.55	40.65	74.00	-33.35	Vertical
2	1197.7747	44.56	-5.56	39.00	74.00	-35.00	Vertical
3	1395.2994	44.15	-5.71	38.44	74.00	-35.56	Vertical
4	1535.8170	56.85	-5.75	51.10	74.00	-22.90	Vertical
5	1796.5996	48.22	-3.81	44.41	74.00	-29.59	Vertical
6	2220.4026	48.24	-2.22	46.02	74.00	-27.98	Vertical

- Note: 1. Measurement = Reading Level + Correct Factor.
 2. If Peak Result complies with AV limit, AV Result is deemed to comply with AV limit.
 3. Test setup: RBW: 1 MHz, VBW: 3 MHz, Sweep time: auto.
 4. Peak: Peak detector.
 5. For below 3GHz part, filter losses were only considered in the spurious frequency bands and the authorized band was not corrected for Band Reject Filter losses.
 6. Only the worst case emission was recorded, if it complies with the limit, the other emissions deemed to comply with the limit.



Test Mode	Channel	Polarization	Verdict
11N HT40	LCH	Horizontal	PASS

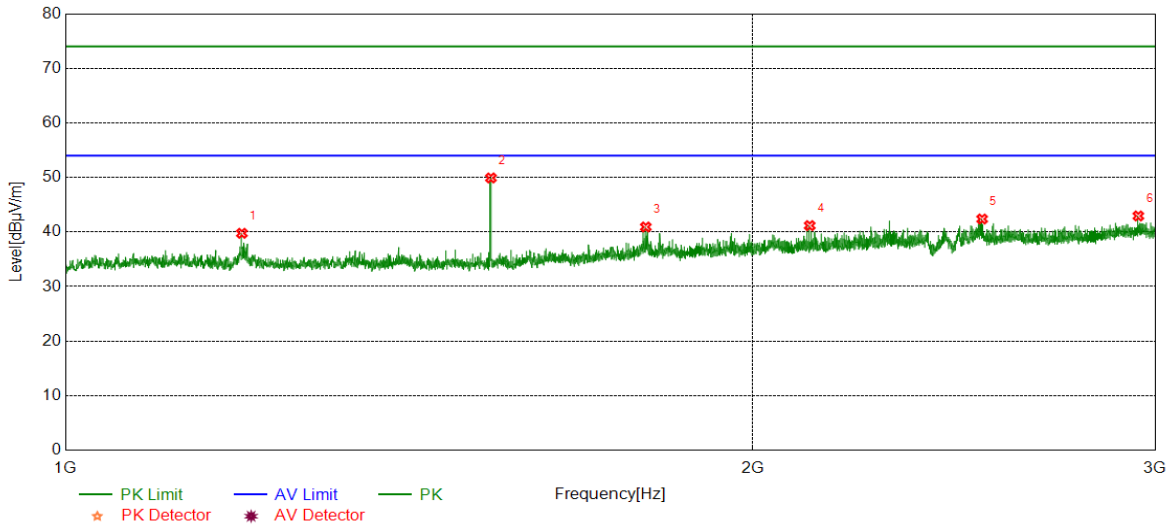

No.	Frequency	Reading Level	Correct Factor	Result	Limit	Margin	Remark
	[MHz]	[dBuV/m]	[dB]	[dBuV/m]	[dBuV/m]	[dB]	
1	1194.7743	45.33	-5.57	39.76	74.00	-34.24	Horizontal
2	1535.8170	55.66	-5.75	49.91	74.00	-24.09	Horizontal
3	1795.3494	44.71	-3.79	40.92	74.00	-33.08	Horizontal
4	2117.8897	43.60	-2.43	41.17	74.00	-32.83	Horizontal
5	2519.9400	42.70	-0.32	42.38	74.00	-31.62	Horizontal
6	2949.7437	42.20	0.74	42.94	74.00	-31.06	Horizontal

- Note: 1. Measurement = Reading Level + Correct Factor.
 2. If Peak Result complies with AV limit, AV Result is deemed to comply with AV limit.
 3. Test setup: RBW: 1 MHz, VBW: 3 MHz, Sweep time: auto.
 4. Peak: Peak detector.
 5. For below 3GHz part, filter losses were only considered in the spurious frequency bands and the authorized band was not corrected for Band Reject Filter losses.
 6. Only the worst case emission was recorded, if it complies with the limit, the other emissions deemed to comply with the limit.



Test Mode	Channel	Polarization	Verdict
11N HT40	LCH	Vertical	PASS

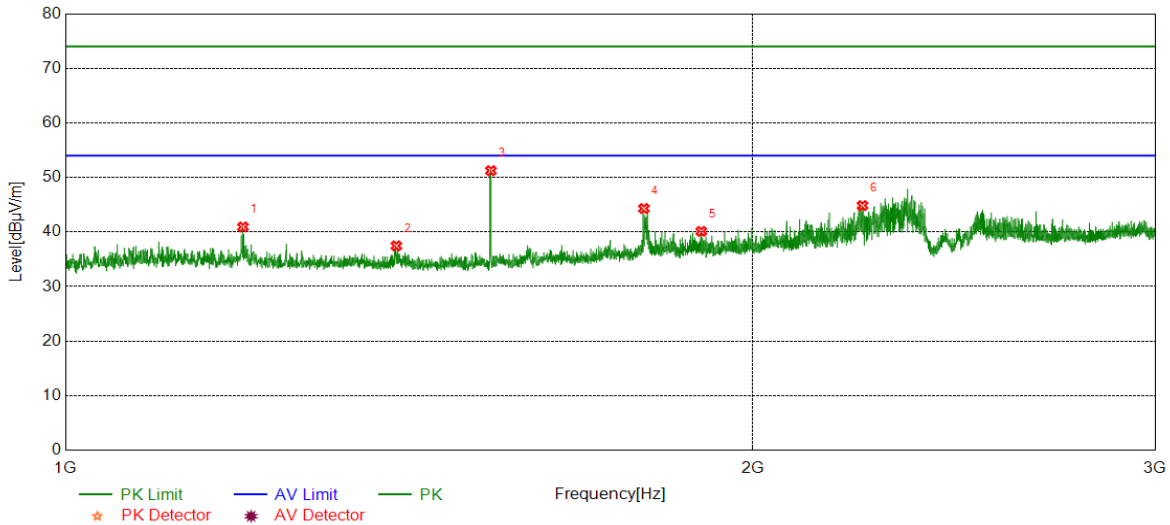

No.	Frequency	Reading Level	Correct Factor	Result	Limit	Margin	Remark
	[MHz]	[dBuV/m]	[dB]	[dBuV/m]	[dBuV/m]	[dB]	
1	1196.0245	46.48	-5.56	40.92	74.00	-33.08	Vertical
2	1396.0495	43.16	-5.70	37.46	74.00	-36.54	Vertical
3	1535.8170	57.00	-5.75	51.25	74.00	-22.75	Vertical
4	1791.8490	48.06	-3.76	44.30	74.00	-29.70	Vertical
5	1898.6123	43.44	-3.32	40.12	74.00	-33.88	Vertical
6	2233.6542	47.05	-2.21	44.84	74.00	-29.16	Vertical

- Note: 1. Measurement = Reading Level + Correct Factor.
 2. If Peak Result complies with AV limit, AV Result is deemed to comply with AV limit.
 3. Test setup: RBW: 1 MHz, VBW: 3 MHz, Sweep time: auto.
 4. Peak: Peak detector.
 5. For below 3GHz part, filter losses were only considered in the spurious frequency bands and the authorized band was not corrected for Band Reject Filter losses.
 6. Only the worst case emission was recorded, if it complies with the limit, the other emissions deemed to comply with the limit.



Test Mode	Channel	Polarization	Verdict
11N HT40	MCH	Horizontal	PASS

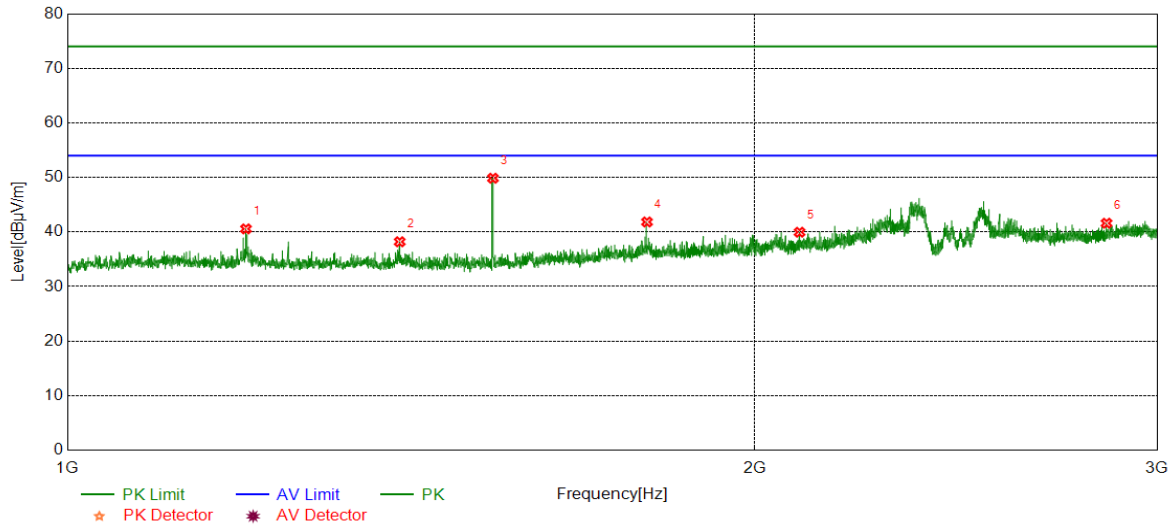

No.	Frequency	Reading Level	Correct Factor	Result	Limit	Margin	Remark
	[MHz]	[dBuV/m]	[dB]	[dBuV/m]	[dBuV/m]	[dB]	
1	1197.2747	46.13	-5.56	40.57	74.00	-33.43	Horizontal
2	1398.0498	43.89	-5.68	38.21	74.00	-35.79	Horizontal
3	1535.8170	55.61	-5.75	49.86	74.00	-24.14	Horizontal
4	1793.8492	45.62	-3.78	41.84	74.00	-32.16	Horizontal
5	2092.1365	42.53	-2.57	39.96	74.00	-34.04	Horizontal
6	2850.9814	41.49	0.12	41.61	74.00	-32.39	Horizontal

- Note: 1. Measurement = Reading Level + Correct Factor.
 2. If Peak Result complies with AV limit, AV Result is deemed to comply with AV limit.
 3. Test setup: RBW: 1 MHz, VBW: 3 MHz, Sweep time: auto.
 4. Peak: Peak detector.
 5. For below 3GHz part, filter losses were only considered in the spurious frequency bands and the authorized band was not corrected for Band Reject Filter losses.
 6. Only the worst case emission was recorded, if it complies with the limit, the other emissions deemed to comply with the limit.



Test Mode	Channel	Polarization	Verdict
11N HT40	MCH	Vertical	PASS

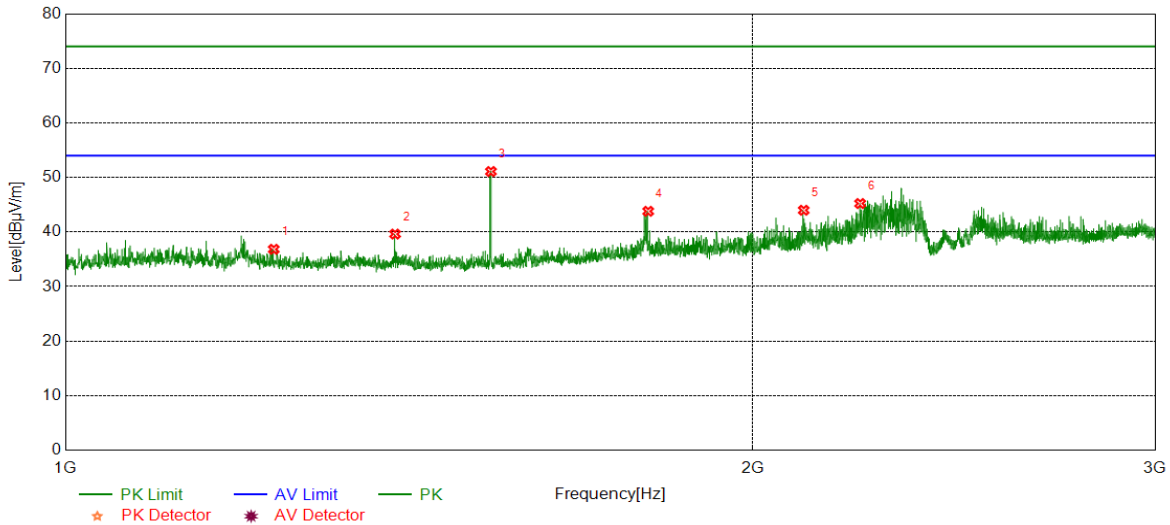

No.	Frequency	Reading Level	Correct Factor	Result	Limit	Margin	Remark
	[MHz]	[dBuV/m]	[dB]	[dBuV/m]	[dBuV/m]	[dB]	
1	1233.7792	42.46	-5.63	36.83	74.00	-37.17	Vertical
2	1394.2993	45.35	-5.73	39.62	74.00	-34.38	Vertical
3	1535.8170	56.84	-5.75	51.09	74.00	-22.91	Vertical
4	1799.6000	47.64	-3.84	43.80	74.00	-30.20	Vertical
5	2105.1381	46.52	-2.53	43.99	74.00	-30.01	Vertical
6	2228.4036	47.39	-2.17	45.22	74.00	-28.78	Vertical

- Note: 1. Measurement = Reading Level + Correct Factor.
 2. If Peak Result complies with AV limit, AV Result is deemed to comply with AV limit.
 3. Test setup: RBW: 1 MHz, VBW: 3 MHz, Sweep time: auto.
 4. Peak: Peak detector.
 5. For below 3GHz part, filter losses were only considered in the spurious frequency bands and the authorized band was not corrected for Band Reject Filter losses.
 6. Only the worst case emission was recorded, if it complies with the limit, the other emissions deemed to comply with the limit.



Test Mode	Channel	Polarization	Verdict
11N HT40	HCH	Horizontal	PASS

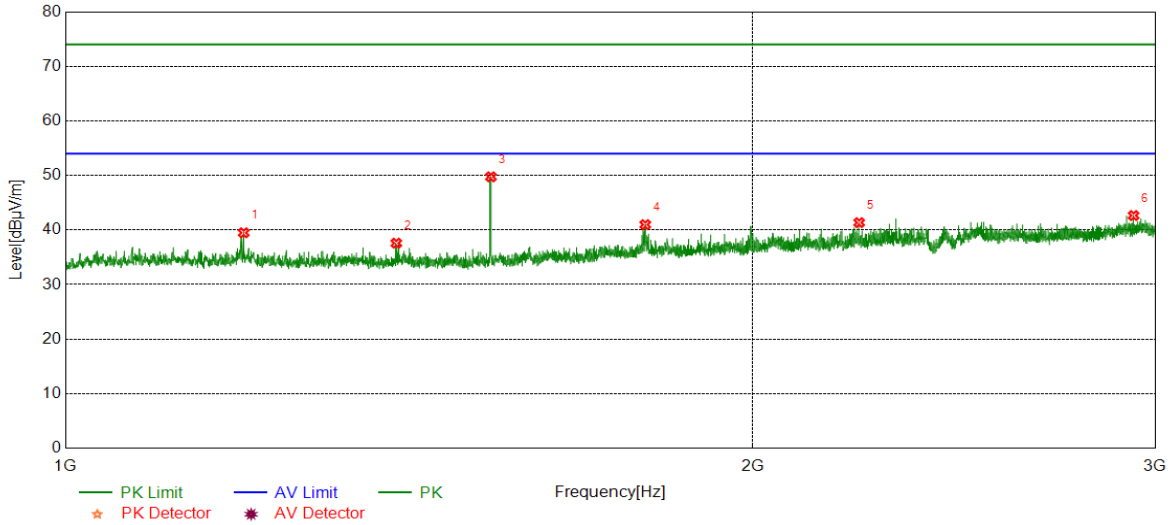

No.	Frequency	Reading Level	Correct Factor	Result	Limit	Margin	Remark
	[MHz]	[dBuV/m]	[dB]	[dBuV/m]	[dBuV/m]	[dB]	
1	1197.0246	45.05	-5.56	39.49	74.00	-34.51	Horizontal
2	1396.0495	43.29	-5.70	37.59	74.00	-36.41	Horizontal
3	1535.8170	55.50	-5.75	49.75	74.00	-24.25	Horizontal
4	1794.3493	44.76	-3.78	40.98	74.00	-33.02	Horizontal
5	2226.1533	43.54	-2.19	41.35	74.00	-32.65	Horizontal
6	2935.7420	42.18	0.47	42.65	74.00	-31.35	Horizontal

- Note: 1. Measurement = Reading Level + Correct Factor.
 2. If Peak Result complies with AV limit, AV Result is deemed to comply with AV limit.
 3. Test setup: RBW: 1 MHz, VBW: 3 MHz, Sweep time: auto.
 4. Peak: Peak detector.
 5. For below 3GHz part, filter losses were only considered in the spurious frequency bands and the authorized band was not corrected for Band Reject Filter losses.
 6. Only the worst case emission was recorded, if it complies with the limit, the other emissions deemed to comply with the limit.



Test Mode	Channel	Polarization	Verdict
11N HT40	HCH	Vertical	PASS

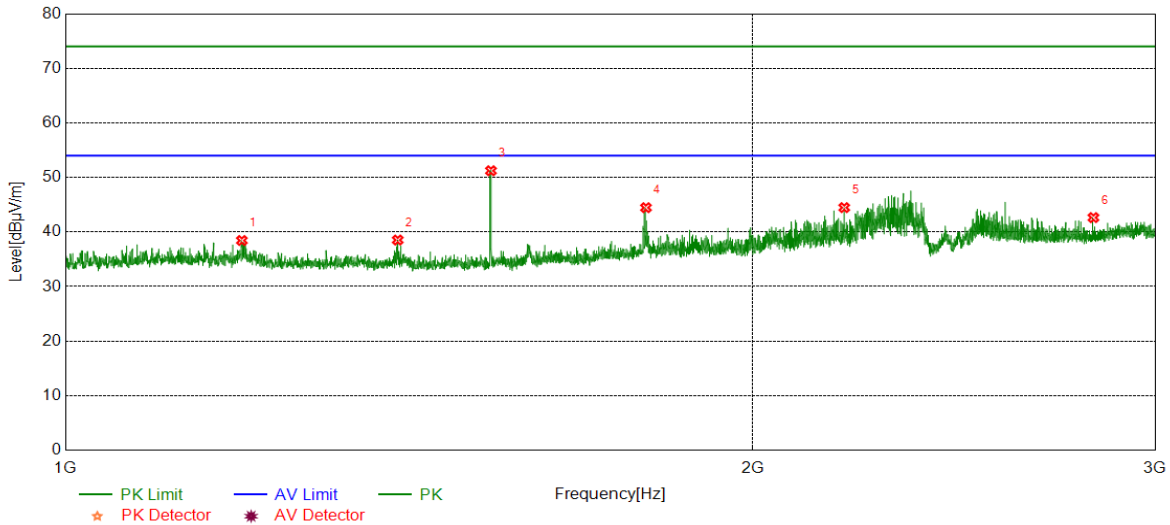

No.	Frequency	Reading Level	Correct Factor	Result	Limit	Margin	Remark
	[MHz]	[dBuV/m]	[dB]	[dBuV/m]	[dBuV/m]	[dB]	
1	1194.7743	44.01	-5.57	38.44	74.00	-35.56	Vertical
2	1398.0498	44.21	-5.68	38.53	74.00	-35.47	Vertical
3	1535.8170	56.98	-5.75	51.23	74.00	-22.77	Vertical
4	1795.5995	48.26	-3.80	44.46	74.00	-29.54	Vertical
5	2192.8991	46.80	-2.33	44.47	74.00	-29.53	Vertical
6	2819.2274	42.82	-0.18	42.64	74.00	-31.36	Vertical

- Note: 1. Measurement = Reading Level + Correct Factor.
 2. If Peak Result complies with AV limit, AV Result is deemed to comply with AV limit.
 3. Test setup: RBW: 1 MHz, VBW: 3 MHz, Sweep time: auto.
 4. Peak: Peak detector.
 5. For below 3GHz part, filter losses were only considered in the spurious frequency bands and the authorized band was not corrected for Band Reject Filter losses.
 6. Only the worst case emission was recorded, if it complies with the limit, the other emissions deemed to comply with the limit.



Part II: 3GHz~18GHz

HARMONICS AND SPURIOUS EMISSIONS

Test Mode	Channel	Polarization	Verdict
11B	LCH	Horizontal	PASS

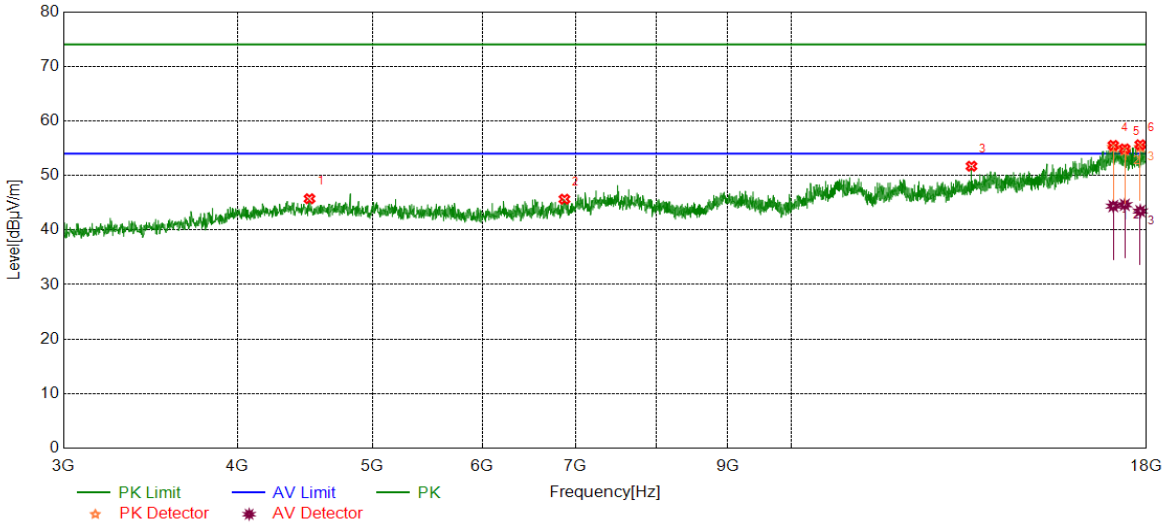

PK Result:

No.	Frequency	Reading Level	Correct Factor	Result	Limit	Margin	Remark
	[MHz]	[dBuV/m]	[dB]	[dBuV/m]	[dBuV/m]	[dB]	
1	4507.6885	40.25	5.48	45.73	74.00	-28.27	Horizontal
2	6872.3590	37.57	8.08	45.65	74.00	-28.35	Horizontal
3	13475.0594	39.16	12.53	51.69	74.00	-22.31	Horizontal
4	17038.0048	36.59	18.92	55.51	74.00	-18.49	Horizontal
5	17364.2955	36.66	18.21	54.87	74.00	-19.13	Horizontal
6	17816.2270	37.92	17.70	55.62	74.00	-18.38	Horizontal

AV Result:

No.	Frequency	Reading Level	Correct Factor	Result	Limit	Margin	Remark
	[MHz]	[dBuV/m]	[dB]	[dBuV/m]	[dBuV/m]	[dB]	
1	17038.0048	25.46	18.92	44.38	54.00	-9.62	Horizontal
2	17364.2955	26.41	18.21	44.62	54.00	-9.38	Horizontal
3	17816.2270	25.76	17.70	43.46	54.00	-10.54	Horizontal

- Note: 1. Measurement = Reading Level + Correct Factor;
 2. If Peak Result complies with AV limit, AV Result is deemed to comply with AV limit.
 3. Peak detector: RBW: 1 MHz, VBW: 3 MHz;
 4. Average detector: RBW: 1 MHz, VBW: 1/T MHz(refer to clause 7.1.);
 5. For above 3GHz part, filter losses were only considered in the spurious frequency bands and the authorized band was not corrected for HPF losses;
 6. Only the worst case emission was recorded, if it complies with the limit, the other emissions deemed to comply with the limit.



Test Mode	Channel	Polarization	Verdict
11B	LCH	Vertical	PASS

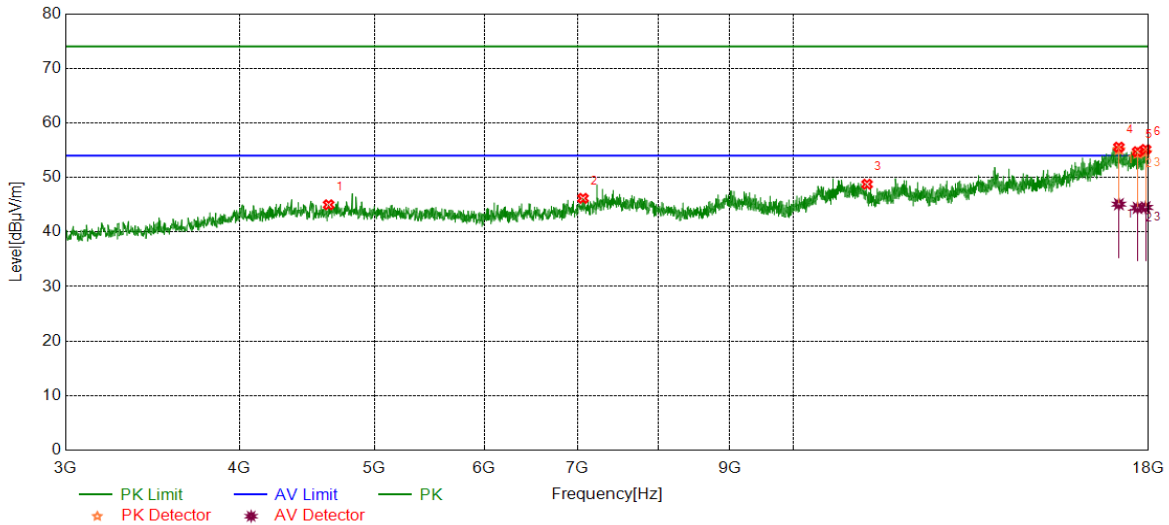

PK Result:

No.	Frequency	Reading Level	Correct Factor	Result	Limit	Margin	Remark
	[MHz]	[dBuV/m]	[dB]	[dBuV/m]	[dBuV/m]	[dB]	
1	4637.0796	39.55	5.44	44.99	74.00	-29.01	Vertical
2	7063.6330	37.99	8.18	46.17	74.00	-27.83	Vertical
3	11299.7875	36.99	11.77	48.76	74.00	-25.24	Vertical
4	17139.2674	37.30	18.26	55.56	74.00	-18.44	Vertical
5	17677.4597	36.84	17.88	54.72	74.00	-19.28	Vertical
6	17913.7392	37.05	18.09	55.14	74.00	-18.86	Vertical

AV Result:

No.	Frequency	Reading Level	Correct Factor	Result	Limit	Margin	Remark
	[MHz]	[dBuV/m]	[dB]	[dBuV/m]	[dBuV/m]	[dB]	
1	17139.2674	26.84	18.26	45.10	54.00	-8.90	Vertical
2	17677.4597	26.54	17.88	44.42	54.00	-9.58	Vertical
3	17913.7392	26.42	18.09	44.51	54.00	-9.49	Vertical

- Note: 1. Measurement = Reading Level + Correct Factor;
 2. If Peak Result complies with AV limit, AV Result is deemed to comply with AV limit.
 3. Peak detector: RBW: 1 MHz, VBW: 3 MHz;
 4. Average detector: RBW: 1 MHz, VBW: 1/T MHz(refer to clause 7.1.);
 5. For above 3GHz part, filter losses were only considered in the spurious frequency bands and the authorized band was not corrected for HPF losses;
 6. Only the worst case emission was recorded, if it complies with the limit, the other emissions deemed to comply with the limit.



Test Mode	Channel	Polarization	Verdict
11B	MCH	Horizontal	PASS

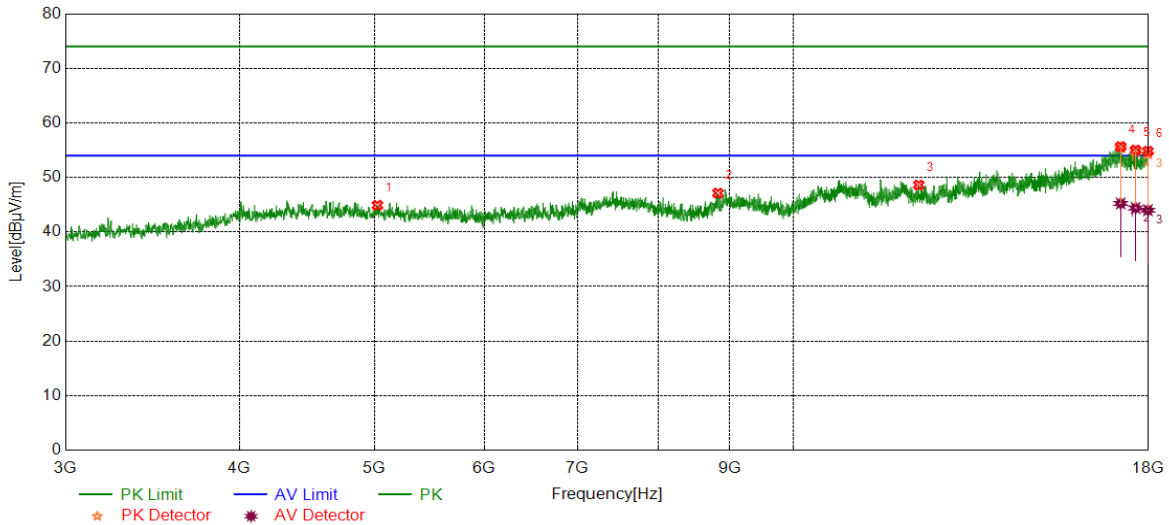

PK Result:

No.	Frequency	Reading Level	Correct Factor	Result	Limit	Margin	Remark
	[MHz]	[dBuV/m]	[dB]	[dBuV/m]	[dBuV/m]	[dB]	
1	5027.1284	39.37	5.53	44.90	74.00	-29.10	Horizontal
2	8830.1038	38.92	8.20	47.12	74.00	-26.88	Horizontal
3	12308.6636	36.95	11.66	48.61	74.00	-25.39	Horizontal
4	17191.7740	37.44	18.21	55.65	74.00	-18.35	Horizontal
5	17619.3274	37.38	17.64	55.02	74.00	-18.98	Horizontal
6	17983.1229	36.89	17.92	54.81	74.00	-19.19	Horizontal

AV Result:

No.	Frequency	Reading Level	Correct Factor	Result	Limit	Margin	Remark
	[MHz]	[dBuV/m]	[dB]	[dBuV/m]	[dBuV/m]	[dB]	
1	17191.7740	27.02	18.21	45.23	54.00	-8.77	Horizontal
2	17619.3274	26.76	17.64	44.40	54.00	-9.60	Horizontal
3	17983.1229	26.07	17.92	43.99	54.00	-10.01	Horizontal

- Note: 1. Measurement = Reading Level + Correct Factor;
 2. If Peak Result complies with AV limit, AV Result is deemed to comply with AV limit.
 3. Peak detector: RBW: 1 MHz, VBW: 3 MHz;
 4. Average detector: RBW: 1 MHz, VBW: 1/T MHz(refer to clause 7.1.);
 5. For above 3GHz part, filter losses were only considered in the spurious frequency bands and the authorized band was not corrected for HPF losses;
 6. Only the worst case emission was recorded, if it complies with the limit, the other emissions deemed to comply with the limit.



Test Mode	Channel	Polarization	Verdict
11B	MCH	Vertical	PASS

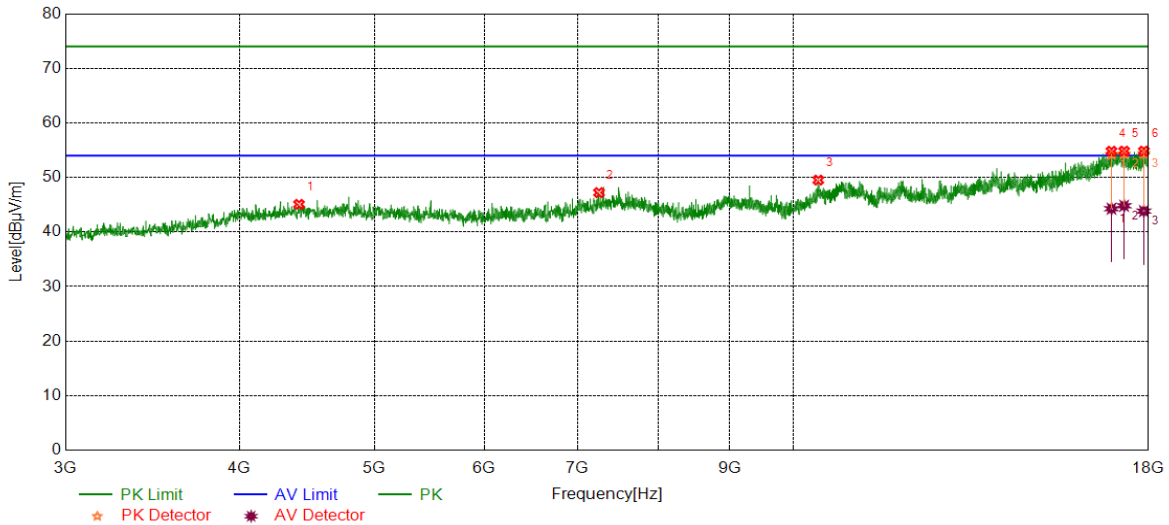

PK Result:

No.	Frequency	Reading Level	Correct Factor	Result	Limit	Margin	Remark
	[MHz]	[dBuV/m]	[dB]	[dBuV/m]	[dBuV/m]	[dB]	
1	4415.8020	39.82	5.25	45.07	74.00	-28.93	Vertical
2	7253.0316	38.52	8.70	47.22	74.00	-26.78	Vertical
3	10424.0530	38.14	11.38	49.52	74.00	-24.48	Vertical
4	16931.1164	36.43	18.38	54.81	74.00	-19.19	Vertical
5	17289.2862	36.94	17.89	54.83	74.00	-19.17	Vertical
6	17861.2327	36.35	18.48	54.83	74.00	-19.17	Vertical

AV Result:

No.	Frequency	Reading Level	Correct Factor	Result	Limit	Margin	Remark
	[MHz]	[dBuV/m]	[dB]	[dBuV/m]	[dBuV/m]	[dB]	
1	16931.1164	25.89	18.38	44.27	54.00	-9.73	Vertical
2	17289.2862	26.92	17.89	44.81	54.00	-9.19	Vertical
3	17861.2327	25.35	18.48	43.83	54.00	-10.17	Vertical

- Note: 1. Measurement = Reading Level + Correct Factor;
 2. If Peak Result complies with AV limit, AV Result is deemed to comply with AV limit.
 3. Peak detector: RBW: 1 MHz, VBW: 3 MHz;
 4. Average detector: RBW: 1 MHz, VBW: 1/T MHz(refer to clause 7.1.);
 5. For above 3GHz part, filter losses were only considered in the spurious frequency bands and the authorized band was not corrected for HPF losses;
 6. Only the worst case emission was recorded, if it complies with the limit, the other emissions deemed to comply with the limit.



Test Mode	Channel	Polarization	Verdict
11B	HCH	Horizontal	PASS

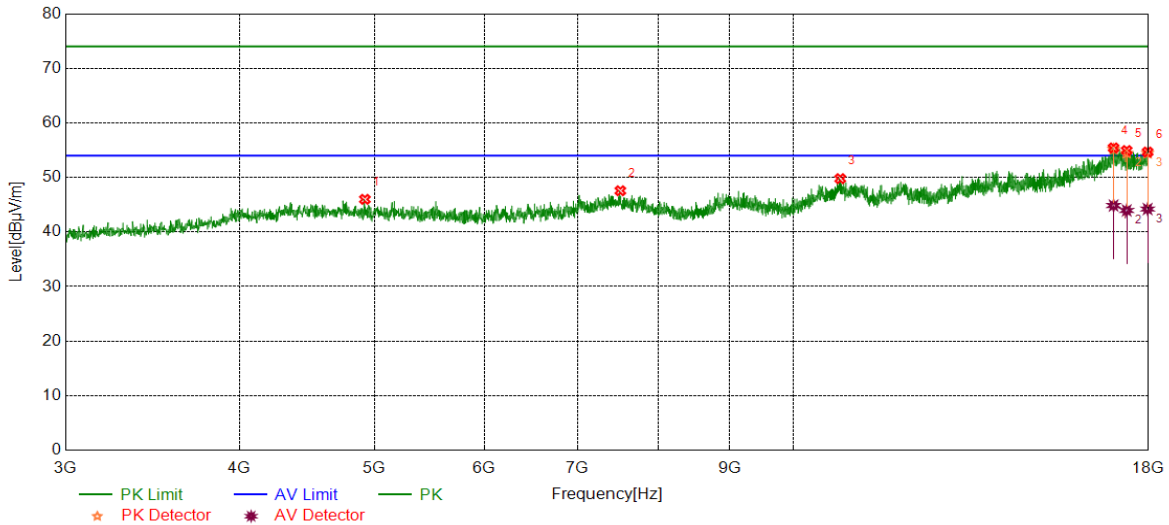

PK Result:

No.	Frequency	Reading Level	Correct Factor	Result	Limit	Margin	Remark
	[MHz]	[dBuV/m]	[dB]	[dBuV/m]	[dBuV/m]	[dB]	
1	4923.9905	40.81	5.18	45.99	74.00	-28.01	Horizontal
2	7513.6892	38.89	8.67	47.56	74.00	-26.44	Horizontal
3	10810.3513	37.57	12.21	49.78	74.00	-24.22	Horizontal
4	16989.2487	36.63	18.78	55.41	74.00	-18.59	Horizontal
5	17362.4203	36.81	18.12	54.93	74.00	-19.07	Horizontal
6	17973.7467	36.83	17.83	54.66	74.00	-19.34	Horizontal

AV Result:

No.	Frequency	Reading Level	Correct Factor	Result	Limit	Margin	Remark
	[MHz]	[dBuV/m]	[dB]	[dBuV/m]	[dBuV/m]	[dB]	
1	16989.2487	26.07	18.78	44.85	54.00	-9.15	Horizontal
2	17362.4203	25.83	18.12	43.95	54.00	-10.05	Horizontal
3	17973.7467	26.38	17.83	44.21	54.00	-9.79	Horizontal

- Note: 1. Measurement = Reading Level + Correct Factor;
 2. If Peak Result complies with AV limit, AV Result is deemed to comply with AV limit.
 3. Peak detector: RBW: 1 MHz, VBW: 3 MHz;
 4. Average detector: RBW: 1 MHz, VBW: 1/T MHz(refer to clause 7.1.);
 5. For above 3GHz part, filter losses were only considered in the spurious frequency bands and the authorized band was not corrected for HPF losses;
 6. Only the worst case emission was recorded, if it complies with the limit, the other emissions deemed to comply with the limit.



Test Mode	Channel	Polarization	Verdict
11B	HCH	Vertical	PASS

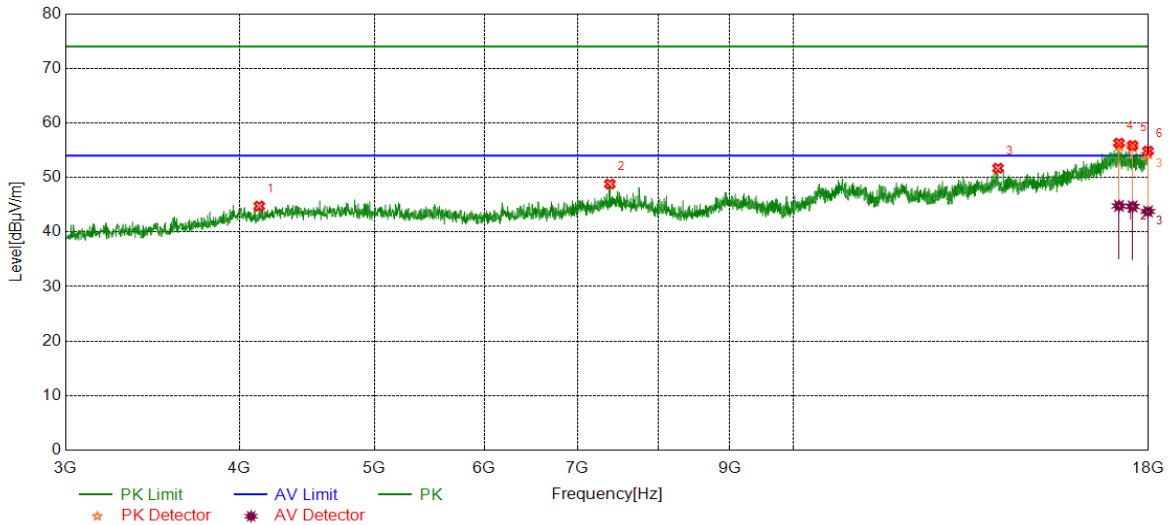

PK Result:

No.	Frequency	Reading Level	Correct Factor	Result	Limit	Margin	Remark
	[MHz]	[dBuV/m]	[dB]	[dBuV/m]	[dBuV/m]	[dB]	
1	4134.5168	40.11	4.64	44.75	74.00	-29.25	Vertical
2	7384.2980	40.21	8.59	48.80	74.00	-25.20	Vertical
3	14032.0040	37.06	14.63	51.69	74.00	-22.31	Vertical
4	17143.0179	38.01	18.28	56.29	74.00	-17.71	Vertical
5	17531.1914	38.00	17.86	55.86	74.00	-18.14	Vertical
6	17983.1229	36.92	17.92	54.84	74.00	-19.16	Vertical

AV Result:

No.	Frequency	Reading Level	Correct Factor	Result	Limit	Margin	Remark
	[MHz]	[dBuV/m]	[dB]	[dBuV/m]	[dBuV/m]	[dB]	
1	17143.0179	26.50	18.28	44.78	54.00	-9.22	Vertical
2	17531.1914	26.82	17.86	44.68	54.00	-9.32	Vertical
3	17983.1229	25.85	17.92	43.77	54.00	-10.23	Vertical

- Note: 1. Measurement = Reading Level + Correct Factor;
 2. If Peak Result complies with AV limit, AV Result is deemed to comply with AV limit.
 3. Peak detector: RBW: 1 MHz, VBW: 3 MHz;
 4. Average detector: RBW: 1 MHz, VBW: 1/T MHz(refer to clause 7.1.);
 5. For above 3GHz part, filter losses were only considered in the spurious frequency bands and the authorized band was not corrected for HPF losses;
 6. Only the worst case emission was recorded, if it complies with the limit, the other emissions deemed to comply with the limit.



Test Mode	Channel	Polarization	Verdict
11G	LCH	Horizontal	PASS

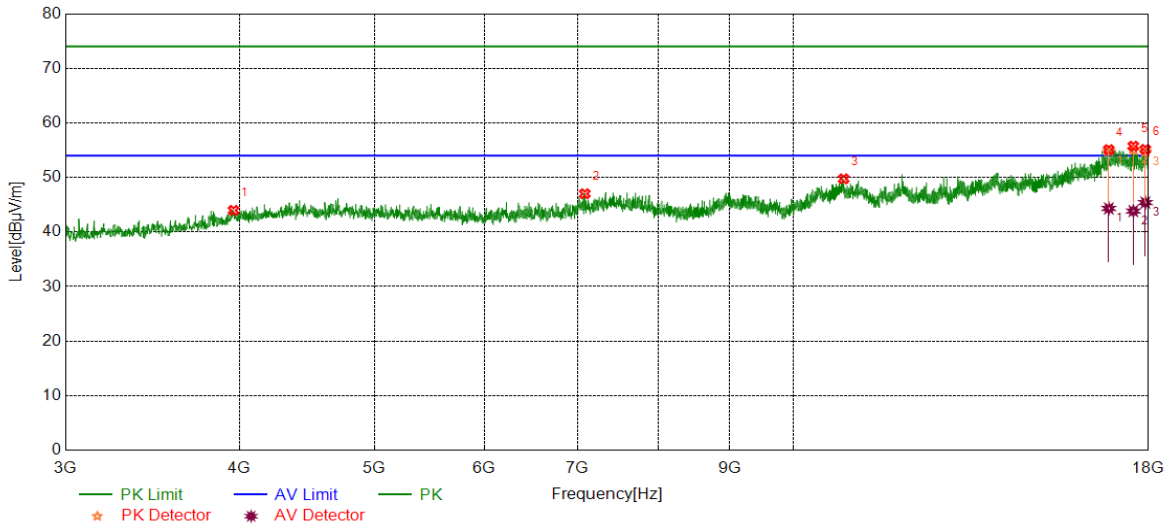

PK Result:

No.	Frequency	Reading Level	Correct Factor	Result	Limit	Margin	Remark
	[MHz]	[dBuV/m]	[dB]	[dBuV/m]	[dBuV/m]	[dB]	
1	3961.9952	39.47	4.49	43.96	74.00	-30.04	Horizontal
2	7084.2605	38.61	8.40	47.01	74.00	-26.99	Horizontal
3	10870.3588	37.58	12.16	49.74	74.00	-24.26	Horizontal
4	16856.1070	37.39	17.70	55.09	74.00	-18.91	Horizontal
5	17553.6942	37.73	18.01	55.74	74.00	-18.26	Horizontal
6	17906.2383	36.82	18.33	55.15	74.00	-18.85	Horizontal

AV Result:

No.	Frequency	Reading Level	Correct Factor	Result	Limit	Margin	Remark
	[MHz]	[dBuV/m]	[dB]	[dBuV/m]	[dBuV/m]	[dB]	
1	16856.1070	26.62	17.70	44.32	54.00	-9.68	Horizontal
2	17553.6942	25.83	18.01	43.84	54.00	-10.16	Horizontal
3	17906.2383	27.06	18.33	45.39	54.00	-8.61	Horizontal

- Note: 1. Measurement = Reading Level + Correct Factor;
 2. If Peak Result complies with AV limit, AV Result is deemed to comply with AV limit.
 3. Peak detector: RBW: 1 MHz, VBW: 3 MHz;
 4. Average detector: RBW: 1 MHz, VBW: 1/T MHz(refer to clause 7.1.);
 5. For above 3GHz part, filter losses were only considered in the spurious frequency bands and the authorized band was not corrected for HPF losses;
 6. Only the worst case emission was recorded, if it complies with the limit, the other emissions deemed to comply with the limit.



Test Mode	Channel	Polarization	Verdict
11G	LCH	Vertical	PASS

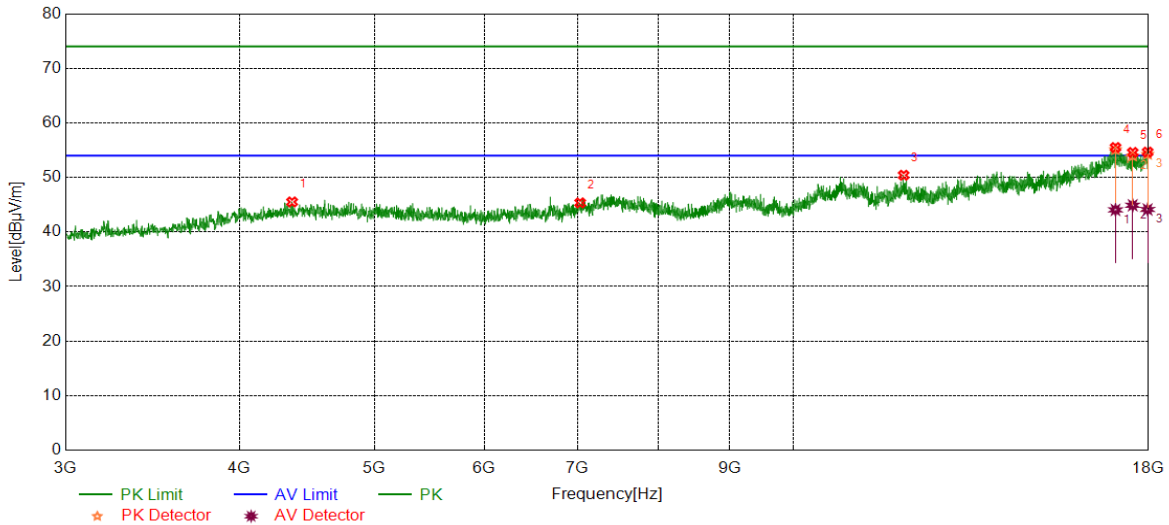

PK Result:

No.	Frequency	Reading Level	Correct Factor	Result	Limit	Margin	Remark
	[MHz]	[dBuV/m]	[dB]	[dBuV/m]	[dBuV/m]	[dB]	
1	4365.1706	40.56	4.95	45.51	74.00	-28.49	Vertical
2	7029.8787	37.18	8.16	45.34	74.00	-28.66	Vertical
3	12004.8756	37.57	12.84	50.41	74.00	-23.59	Vertical
4	17043.6305	36.73	18.76	55.49	74.00	-18.51	Vertical
5	17534.9419	36.93	17.65	54.58	74.00	-19.42	Vertical
6	17973.7467	36.82	17.83	54.65	74.00	-19.35	Vertical

AV Result:

No.	Frequency	Reading Level	Correct Factor	Result	Limit	Margin	Remark
	[MHz]	[dBuV/m]	[dB]	[dBuV/m]	[dBuV/m]	[dB]	
1	17043.6305	25.29	18.76	44.05	54.00	-9.95	Vertical
2	17534.9419	27.25	17.65	44.90	54.00	-9.10	Vertical
3	17973.7467	26.30	17.83	44.13	54.00	-9.87	Vertical

- Note: 1. Measurement = Reading Level + Correct Factor;
 2. If Peak Result complies with AV limit, AV Result is deemed to comply with AV limit.
 3. Peak detector: RBW: 1 MHz, VBW: 3 MHz;
 4. Average detector: RBW: 1 MHz, VBW: 1/T MHz(refer to clause 7.1.);
 5. For above 3GHz part, filter losses were only considered in the spurious frequency bands and the authorized band was not corrected for HPF losses;
 6. Only the worst case emission was recorded, if it complies with the limit, the other emissions deemed to comply with the limit.



Test Mode	Channel	Polarization	Verdict
11G	MCH	Horizontal	PASS

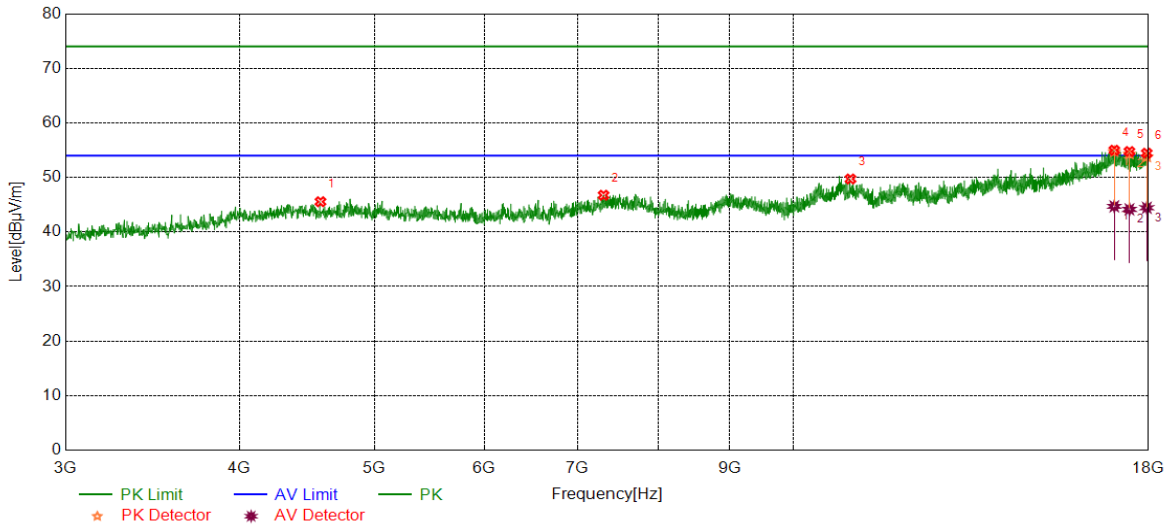

PK Result:

No.	Frequency	Reading Level	Correct Factor	Result	Limit	Margin	Remark
	[MHz]	[dBuV/m]	[dB]	[dBuV/m]	[dBuV/m]	[dB]	
1	4575.1969	40.19	5.36	45.55	74.00	-28.45	Horizontal
2	7307.4134	38.28	8.46	46.74	74.00	-27.26	Horizontal
3	10994.1243	37.40	12.32	49.72	74.00	-24.28	Horizontal
4	17009.8762	36.47	18.52	54.99	74.00	-19.01	Horizontal
5	17441.1801	36.87	17.88	54.75	74.00	-19.25	Horizontal
6	17949.3687	35.90	18.55	54.45	74.00	-19.55	Horizontal

AV Result:

No.	Frequency	Reading Level	Correct Factor	Result	Limit	Margin	Remark
	[MHz]	[dBuV/m]	[dB]	[dBuV/m]	[dBuV/m]	[dB]	
1	17009.8762	26.18	18.52	44.70	54.00	-9.30	Horizontal
2	17441.1801	26.27	17.88	44.15	54.00	-9.85	Horizontal
3	17949.3687	25.89	18.55	44.44	54.00	-9.56	Horizontal

- Note: 1. Measurement = Reading Level + Correct Factor;
 2. If Peak Result complies with AV limit, AV Result is deemed to comply with AV limit.
 3. Peak detector: RBW: 1 MHz, VBW: 3 MHz;
 4. Average detector: RBW: 1 MHz, VBW: 1/T MHz(refer to clause 7.1.);
 5. For above 3GHz part, filter losses were only considered in the spurious frequency bands and the authorized band was not corrected for HPF losses;
 6. Only the worst case emission was recorded, if it complies with the limit, the other emissions deemed to comply with the limit.



Test Mode	Channel	Polarization	Verdict
11G	MCH	Vertical	PASS

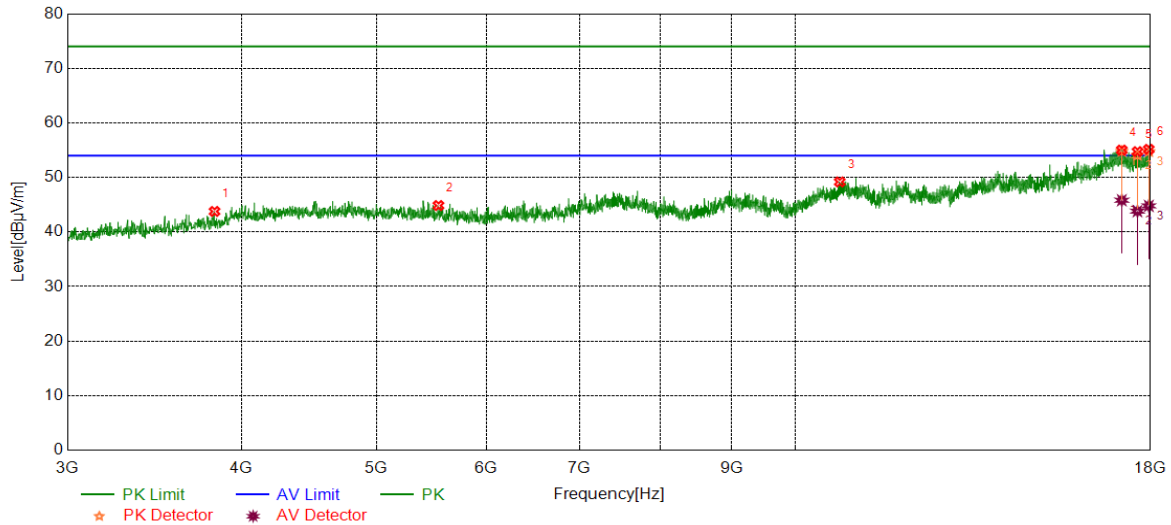

PK Result:

No.	Frequency	Reading Level	Correct Factor	Result	Limit	Margin	Remark
	[MHz]	[dBuV/m]	[dB]	[dBuV/m]	[dBuV/m]	[dB]	
1	3826.9784	40.04	3.73	43.77	74.00	-30.23	Vertical
2	5542.8179	39.51	5.34	44.85	74.00	-29.15	Vertical
3	10765.3457	37.04	12.14	49.18	74.00	-24.82	Vertical
4	17165.5207	36.71	18.31	55.02	74.00	-18.98	Vertical
5	17615.5769	37.01	17.73	54.74	74.00	-19.26	Vertical
6	17949.3687	36.61	18.55	55.16	74.00	-18.84	Vertical

AV Result:

No.	Frequency	Reading Level	Correct Factor	Result	Limit	Margin	Remark
	[MHz]	[dBuV/m]	[dB]	[dBuV/m]	[dBuV/m]	[dB]	
1	17165.5207	27.51	18.31	45.82	54.00	-8.18	Vertical
2	17615.5769	26.09	17.73	43.82	54.00	-10.18	Vertical
3	17949.3687	26.24	18.55	44.79	54.00	-9.21	Vertical

- Note: 1. Measurement = Reading Level + Correct Factor;
 2. If Peak Result complies with AV limit, AV Result is deemed to comply with AV limit.
 3. Peak detector: RBW: 1 MHz, VBW: 3 MHz;
 4. Average detector: RBW: 1 MHz, VBW: 1/T MHz(refer to clause 7.1.);
 5. For above 3GHz part, filter losses were only considered in the spurious frequency bands and the authorized band was not corrected for HPF losses;
 6. Only the worst case emission was recorded, if it complies with the limit, the other emissions deemed to comply with the limit.



Test Mode	Channel	Polarization	Verdict
11G	HCH	Horizontal	PASS

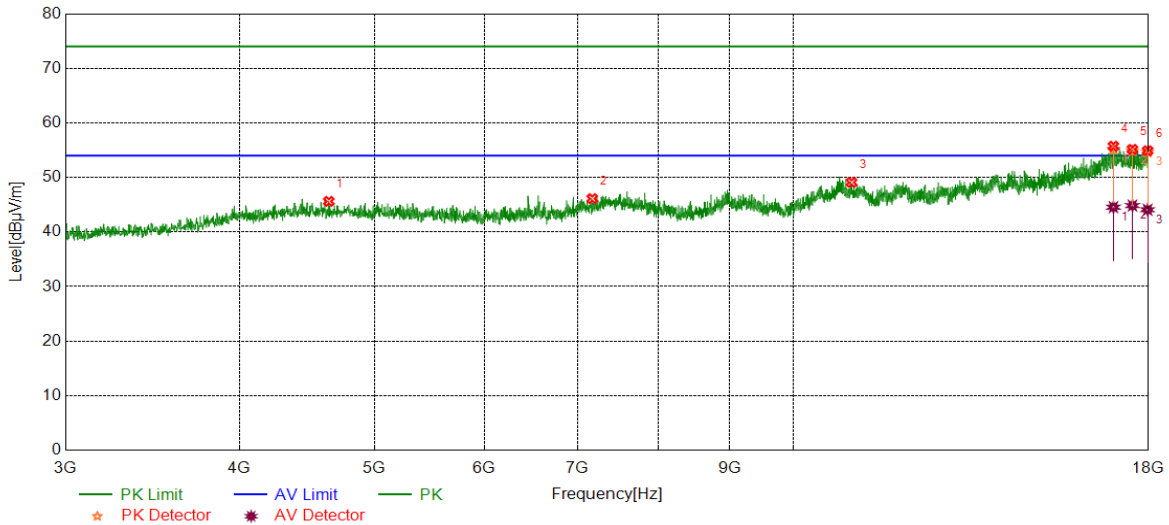

PK Result:

No.	Frequency	Reading Level	Correct Factor	Result	Limit	Margin	Remark
	[MHz]	[dBuV/m]	[dB]	[dBuV/m]	[dBuV/m]	[dB]	
1	4638.9549	40.15	5.46	45.61	74.00	-28.39	Horizontal
2	7172.3966	37.79	8.33	46.12	74.00	-27.88	Horizontal
3	11014.7518	36.58	12.51	49.09	74.00	-24.91	Horizontal
4	16985.4982	36.96	18.77	55.73	74.00	-18.27	Horizontal
5	17527.4409	37.28	17.87	55.15	74.00	-18.85	Horizontal
6	17973.7467	37.07	17.83	54.90	74.00	-19.10	Horizontal

AV Result:

No.	Frequency	Reading Level	Correct Factor	Result	Limit	Margin	Remark
	[MHz]	[dBuV/m]	[dB]	[dBuV/m]	[dBuV/m]	[dB]	
1	16985.4982	25.78	18.77	44.55	54.00	-9.45	Horizontal
2	17527.4409	26.97	17.87	44.84	54.00	-9.16	Horizontal
3	17973.7467	26.25	17.83	44.08	54.00	-9.92	Horizontal

- Note: 1. Measurement = Reading Level + Correct Factor;
 2. If Peak Result complies with AV limit, AV Result is deemed to comply with AV limit.
 3. Peak detector: RBW: 1 MHz, VBW: 3 MHz;
 4. Average detector: RBW: 1 MHz, VBW: 1/T MHz(refer to clause 7.1.);
 5. For above 3GHz part, filter losses were only considered in the spurious frequency bands and the authorized band was not corrected for HPF losses;
 6. Only the worst case emission was recorded, if it complies with the limit, the other emissions deemed to comply with the limit.



Test Mode	Channel	Polarization	Verdict
11G	HCH	Vertical	PASS

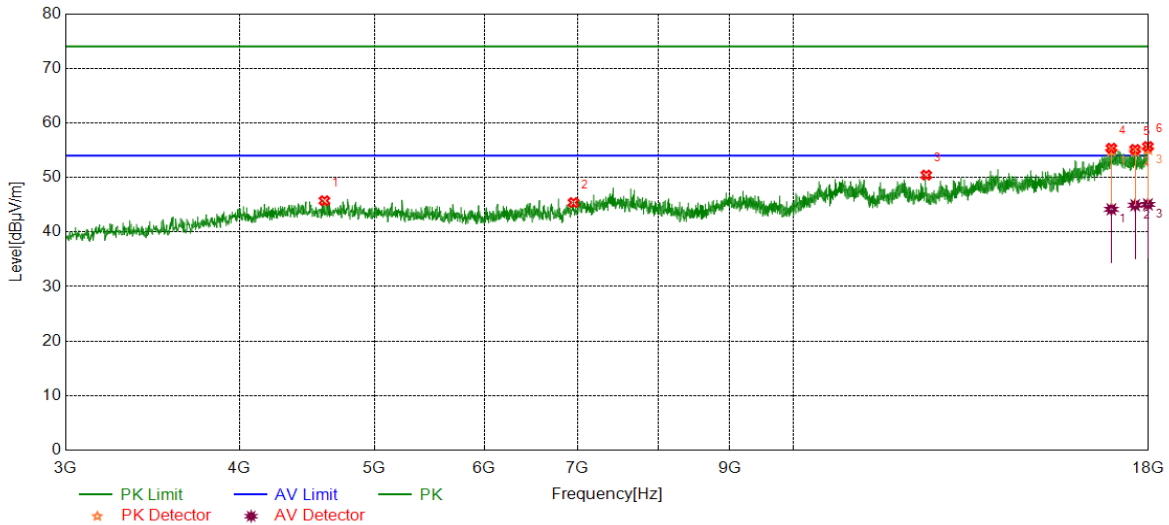

PK Result:

No.	Frequency	Reading Level	Correct Factor	Result	Limit	Margin	Remark
	[MHz]	[dBuV/m]	[dB]	[dBuV/m]	[dBuV/m]	[dB]	
1	4605.2007	40.32	5.41	45.73	74.00	-28.27	Vertical
2	6952.9941	36.80	8.59	45.39	74.00	-28.61	Vertical
3	12462.4328	39.08	11.36	50.44	74.00	-23.56	Vertical
4	16927.3659	37.19	18.17	55.36	74.00	-18.64	Vertical
5	17606.2008	37.43	17.71	55.14	74.00	-18.86	Vertical
6	17981.2477	37.63	18.04	55.67	74.00	-18.33	Vertical

AV Result:

No.	Frequency	Reading Level	Correct Factor	Result	Limit	Margin	Remark
	[MHz]	[dBuV/m]	[dB]	[dBuV/m]	[dBuV/m]	[dB]	
1	16927.3659	25.99	18.17	44.16	54.00	-9.84	Vertical
2	17606.2008	27.21	17.71	44.92	54.00	-9.08	Vertical
3	17981.2477	27.02	18.04	45.06	54.00	-8.94	Vertical

- Note: 1. Measurement = Reading Level + Correct Factor;
 2. If Peak Result complies with AV limit, AV Result is deemed to comply with AV limit.
 3. Peak detector: RBW: 1 MHz, VBW: 3 MHz;
 4. Average detector: RBW: 1 MHz, VBW: 1/T MHz(refer to clause 7.1.);
 5. For above 3GHz part, filter losses were only considered in the spurious frequency bands and the authorized band was not corrected for HPF losses;
 6. Only the worst case emission was recorded, if it complies with the limit, the other emissions deemed to comply with the limit.



Test Mode	Channel	Polarization	Verdict
11N HT20	LCH	Horizontal	PASS

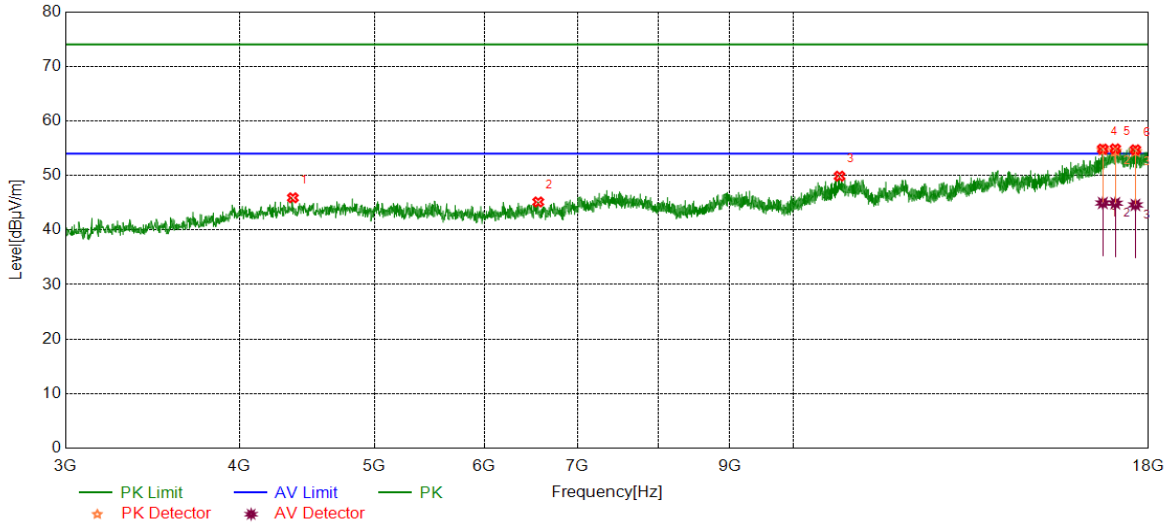

PK Result:

No.	Frequency	Reading Level	Correct Factor	Result	Limit	Margin	Remark
	[MHz]	[dBuV/m]	[dB]	[dBuV/m]	[dBuV/m]	[dB]	
1	4370.7964	40.96	4.94	45.90	74.00	-28.10	Horizontal
2	6559.1949	37.58	7.56	45.14	74.00	-28.86	Horizontal
3	10797.2247	37.81	12.06	49.87	74.00	-24.13	Horizontal
4	16689.2112	36.67	18.17	54.84	74.00	-19.16	Horizontal
5	17038.0048	35.96	18.92	54.88	74.00	-19.12	Horizontal
6	17615.5769	36.98	17.73	54.71	74.00	-19.29	Horizontal

AV Result:

No.	Frequency	Reading Level	Correct Factor	Result	Limit	Margin	Remark
	[MHz]	[dBuV/m]	[dB]	[dBuV/m]	[dBuV/m]	[dB]	
1	16689.2112	26.78	18.17	44.95	54.00	-9.05	Horizontal
2	17038.0048	25.99	18.92	44.91	54.00	-9.09	Horizontal
3	17615.5769	26.87	17.73	44.60	54.00	-9.40	Horizontal

- Note: 1. Measurement = Reading Level + Correct Factor;
 2. If Peak Result complies with AV limit, AV Result is deemed to comply with AV limit.
 3. Peak detector: RBW: 1 MHz, VBW: 3 MHz;
 4. Average detector: RBW: 1 MHz, VBW: 1/T MHz(refer to clause 7.1.);
 5. For above 3GHz part, filter losses were only considered in the spurious frequency bands and the authorized band was not corrected for HPF losses;
 6. Only the worst case emission was recorded, if it complies with the limit, the other emissions deemed to comply with the limit.



Test Mode	Channel	Polarization	Verdict
11N HT20	LCH	Vertical	PASS

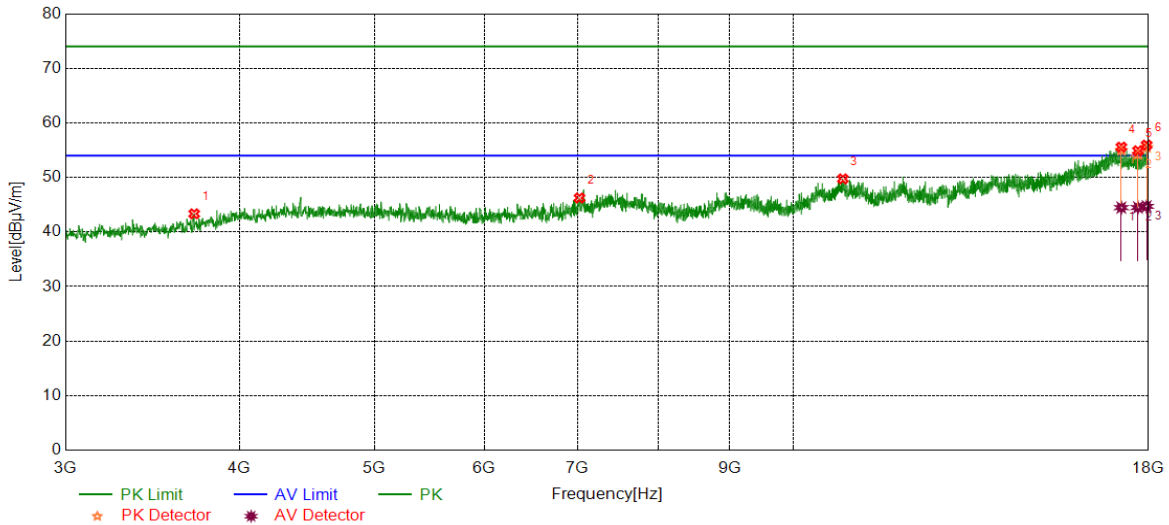

PK Result:

No.	Frequency	Reading Level	Correct Factor	Result	Limit	Margin	Remark
	[MHz]	[dBuV/m]	[dB]	[dBuV/m]	[dBuV/m]	[dB]	
1	3712.5891	40.15	3.19	43.34	74.00	-30.66	Vertical
2	7022.3778	37.97	8.26	46.23	74.00	-27.77	Vertical
3	10857.2322	37.50	12.24	49.74	74.00	-24.26	Vertical
4	17208.6511	37.66	17.90	55.56	74.00	-18.44	Vertical
5	17688.7111	36.93	17.96	54.89	74.00	-19.11	Vertical
6	17943.7430	37.55	18.38	55.93	74.00	-18.07	Vertical

AV Result:

No.	Frequency	Reading Level	Correct Factor	Result	Limit	Margin	Remark
	[MHz]	[dBuV/m]	[dB]	[dBuV/m]	[dBuV/m]	[dB]	
1	17208.6511	26.57	17.90	44.47	54.00	-9.53	Vertical
2	17688.7111	26.53	17.96	44.49	54.00	-9.51	Vertical
3	17943.7430	26.32	18.38	44.70	54.00	-9.30	Vertical

- Note: 1. Measurement = Reading Level + Correct Factor;
 2. If Peak Result complies with AV limit, AV Result is deemed to comply with AV limit.
 3. Peak detector: RBW: 1 MHz, VBW: 3 MHz;
 4. Average detector: RBW: 1 MHz, VBW: 1/T MHz(refer to clause 7.1.);
 5. For above 3GHz part, filter losses were only considered in the spurious frequency bands and the authorized band was not corrected for HPF losses;
 6. Only the worst case emission was recorded, if it complies with the limit, the other emissions deemed to comply with the limit.



Test Mode	Channel	Polarization	Verdict
11N HT20	MCH	Horizontal	PASS

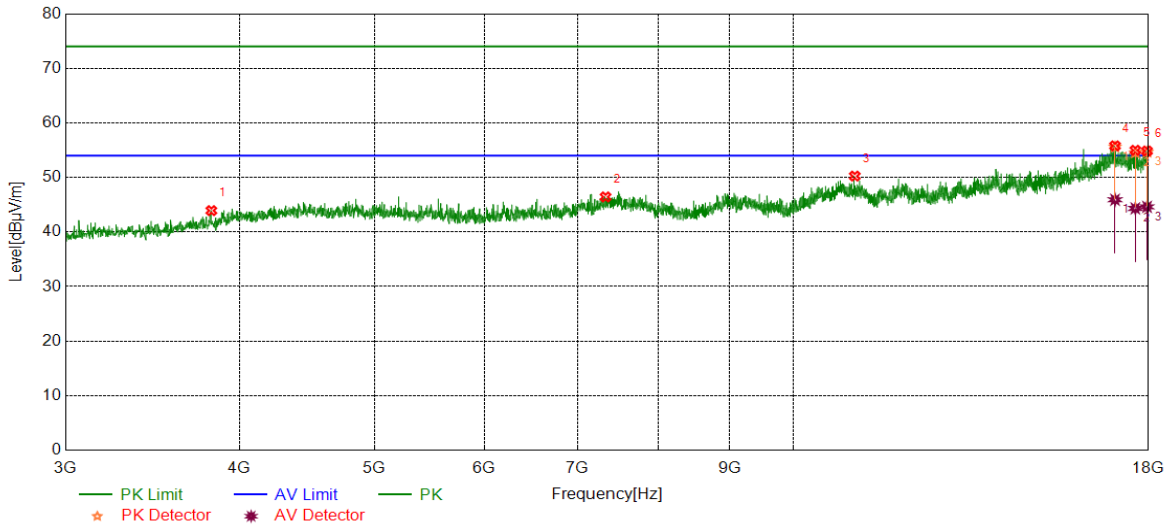

PK Result:

No.	Frequency	Reading Level	Correct Factor	Result	Limit	Margin	Remark
	[MHz]	[dBuV/m]	[dB]	[dBuV/m]	[dBuV/m]	[dB]	
1	3819.4774	40.17	3.75	43.92	74.00	-30.08	Horizontal
2	7331.7915	37.82	8.61	46.43	74.00	-27.57	Horizontal
3	11072.8841	38.11	12.14	50.25	74.00	-23.75	Horizontal
4	17030.5038	36.76	19.03	55.79	74.00	-18.21	Horizontal
5	17611.8265	37.16	17.82	54.98	74.00	-19.02	Horizontal
6	17956.8696	36.35	18.50	54.85	74.00	-19.15	Horizontal

AV Result:

No.	Frequency	Reading Level	Correct Factor	Result	Limit	Margin	Remark
	[MHz]	[dBuV/m]	[dB]	[dBuV/m]	[dBuV/m]	[dB]	
1	17030.5038	26.88	19.03	45.91	54.00	-8.09	Horizontal
2	17611.8265	26.51	17.82	44.33	54.00	-9.67	Horizontal
3	17956.8696	26.11	18.50	44.61	54.00	-9.39	Horizontal

- Note: 1. Measurement = Reading Level + Correct Factor;
 2. If Peak Result complies with AV limit, AV Result is deemed to comply with AV limit.
 3. Peak detector: RBW: 1 MHz, VBW: 3 MHz;
 4. Average detector: RBW: 1 MHz, VBW: 1/T MHz(refer to clause 7.1.);
 5. For above 3GHz part, filter losses were only considered in the spurious frequency bands and the authorized band was not corrected for HPF losses;
 6. Only the worst case emission was recorded, if it complies with the limit, the other emissions deemed to comply with the limit.



Test Mode	Channel	Polarization	Verdict
11N HT20	MCH	Vertical	PASS

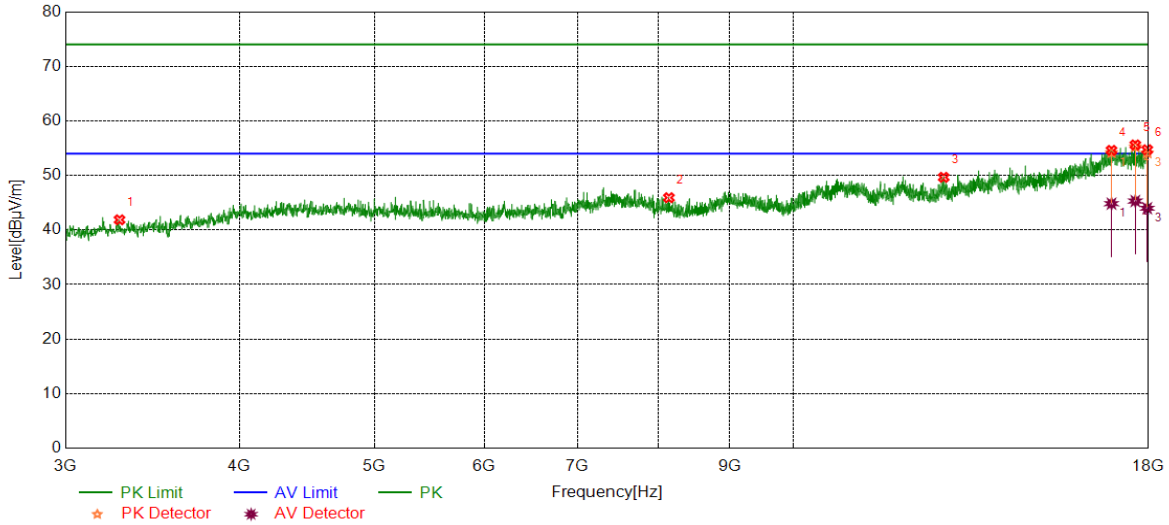

PK Result:

No.	Frequency	Reading Level	Correct Factor	Result	Limit	Margin	Remark
	[MHz]	[dBuV/m]	[dB]	[dBuV/m]	[dBuV/m]	[dB]	
1	3281.2852	40.41	1.46	41.87	74.00	-32.13	Vertical
2	8141.8927	38.49	7.43	45.92	74.00	-28.08	Vertical
3	12826.2283	37.91	11.75	49.66	74.00	-24.34	Vertical
4	16931.1164	36.22	18.38	54.60	74.00	-19.40	Vertical
5	17611.8265	37.78	17.82	55.60	74.00	-18.40	Vertical
6	17962.4953	36.45	18.27	54.72	74.00	-19.28	Vertical

AV Result:

No.	Frequency	Reading Level	Correct Factor	Result	Limit	Margin	Remark
	[MHz]	[dBuV/m]	[dB]	[dBuV/m]	[dBuV/m]	[dB]	
1	16931.1164	26.45	18.38	44.83	54.00	-9.17	Vertical
2	17611.8265	27.49	17.82	45.31	54.00	-8.69	Vertical
3	17962.4953	25.72	18.27	43.99	54.00	-10.01	Vertical

- Note: 1. Measurement = Reading Level + Correct Factor;
 2. If Peak Result complies with AV limit, AV Result is deemed to comply with AV limit.
 3. Peak detector: RBW: 1 MHz, VBW: 3 MHz;
 4. Average detector: RBW: 1 MHz, VBW: 1/T MHz(refer to clause 7.1.);
 5. For above 3GHz part, filter losses were only considered in the spurious frequency bands and the authorized band was not corrected for HPF losses;
 6. Only the worst case emission was recorded, if it complies with the limit, the other emissions deemed to comply with the limit.



Test Mode	Channel	Polarization	Verdict
11N HT20	HCH	Horizontal	PASS

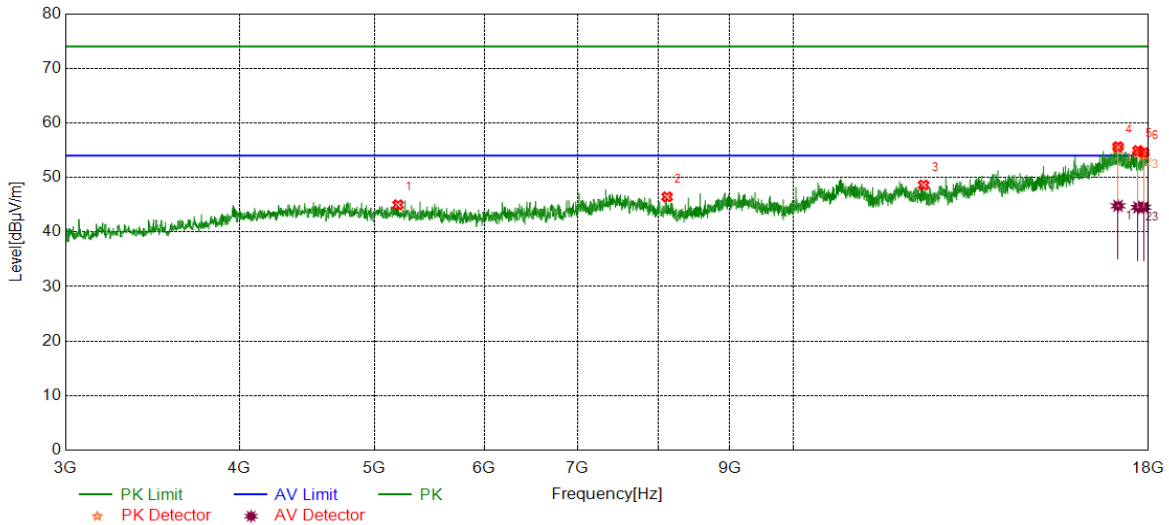

PK Result:

No.	Frequency	Reading Level	Correct Factor	Result	Limit	Margin	Remark
	[MHz]	[dBuV/m]	[dB]	[dBuV/m]	[dBuV/m]	[dB]	
1	5201.5252	39.70	5.28	44.98	74.00	-29.02	Horizontal
2	8117.5147	39.12	7.32	46.44	74.00	-27.56	Horizontal
3	12408.0510	37.14	11.47	48.61	74.00	-25.39	Horizontal
4	17114.8894	37.64	18.01	55.65	74.00	-18.35	Horizontal
5	17690.5863	36.99	17.94	54.93	74.00	-19.07	Horizontal
6	17857.4822	36.25	18.30	54.55	74.00	-19.45	Horizontal

AV Result:

No.	Frequency	Reading Level	Correct Factor	Result	Limit	Margin	Remark
	[MHz]	[dBuV/m]	[dB]	[dBuV/m]	[dBuV/m]	[dB]	
1	17114.8894	26.79	18.01	44.80	54.00	-9.20	Horizontal
2	17690.5863	26.57	17.94	44.51	54.00	-9.49	Horizontal
3	17857.4822	26.25	18.30	44.55	54.00	-9.45	Horizontal

- Note: 1. Measurement = Reading Level + Correct Factor;
 2. If Peak Result complies with AV limit, AV Result is deemed to comply with AV limit.
 3. Peak detector: RBW: 1 MHz, VBW: 3 MHz;
 4. Average detector: RBW: 1 MHz, VBW: 1/T MHz(refer to clause 7.1.);
 5. For above 3GHz part, filter losses were only considered in the spurious frequency bands and the authorized band was not corrected for HPF losses;
 6. Only the worst case emission was recorded, if it complies with the limit, the other emissions deemed to comply with the limit.



Test Mode	Channel	Polarization	Verdict
11N HT20	HCH	Vertical	PASS

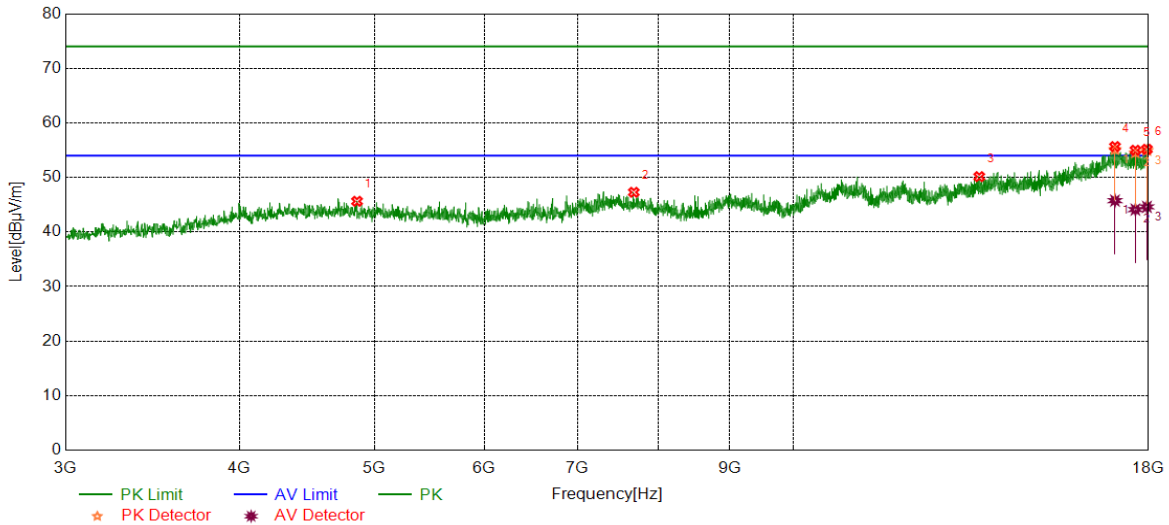

PK Result:

No.	Frequency	Reading Level	Correct Factor	Result	Limit	Margin	Remark
	[MHz]	[dBuV/m]	[dB]	[dBuV/m]	[dBuV/m]	[dB]	
1	4860.2325	40.27	5.36	45.63	74.00	-28.37	Vertical
2	7682.4603	38.83	8.45	47.28	74.00	-26.72	Vertical
3	13604.4506	37.23	12.92	50.15	74.00	-23.85	Vertical
4	17028.6286	36.72	18.94	55.66	74.00	-18.34	Vertical
5	17613.7017	37.21	17.78	54.99	74.00	-19.01	Vertical
6	17953.1191	36.63	18.54	55.17	74.00	-18.83	Vertical

AV Result:

No.	Frequency	Reading Level	Correct Factor	Result	Limit	Margin	Remark
	[MHz]	[dBuV/m]	[dB]	[dBuV/m]	[dBuV/m]	[dB]	
1	17028.6286	26.81	18.94	45.75	54.00	-8.25	Vertical
2	17613.7017	26.33	17.78	44.11	54.00	-9.89	Vertical
3	17953.1191	26.07	18.54	44.61	54.00	-9.39	Vertical

- Note: 1. Measurement = Reading Level + Correct Factor;
 2. If Peak Result complies with AV limit, AV Result is deemed to comply with AV limit.
 3. Peak detector: RBW: 1 MHz, VBW: 3 MHz;
 4. Average detector: RBW: 1 MHz, VBW: 1/T MHz(refer to clause 7.1.);
 5. For above 3GHz part, filter losses were only considered in the spurious frequency bands and the authorized band was not corrected for HPF losses;
 6. Only the worst case emission was recorded, if it complies with the limit, the other emissions deemed to comply with the limit.



Test Mode	Channel	Polarization	Verdict
11N HT40	LCH	Horizontal	PASS

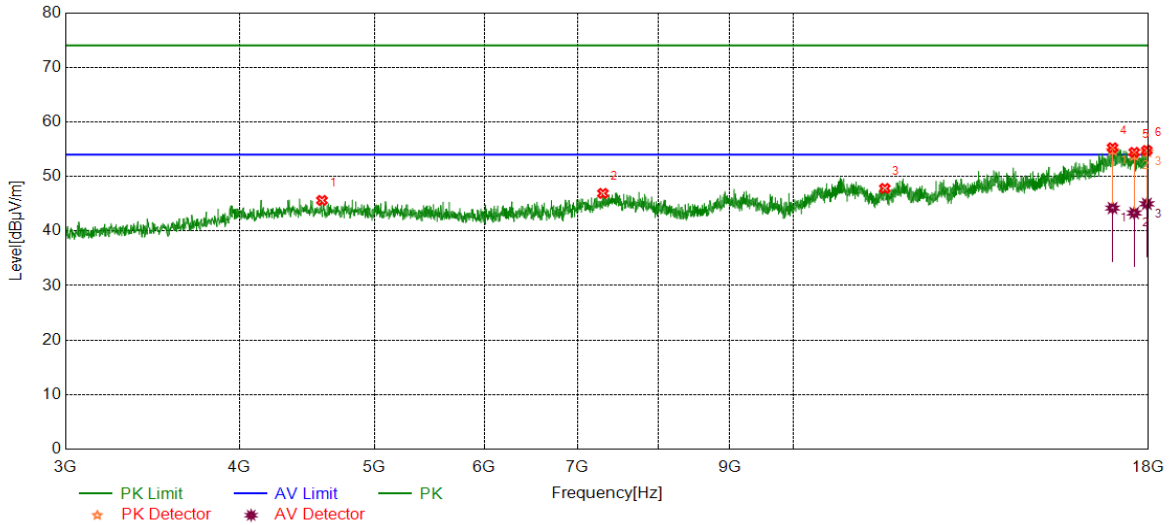

PK Result:

No.	Frequency	Reading Level	Correct Factor	Result	Limit	Margin	Remark
	[MHz]	[dBuV/m]	[dB]	[dBuV/m]	[dBuV/m]	[dB]	
1	4586.4483	40.15	5.46	45.61	74.00	-28.39	Horizontal
2	7299.9125	38.35	8.55	46.90	74.00	-27.10	Horizontal
3	11637.3297	36.34	11.46	47.80	74.00	-26.20	Horizontal
4	16961.1201	36.62	18.64	55.26	74.00	-18.74	Horizontal
5	17579.9475	36.86	17.56	54.42	74.00	-19.58	Horizontal
6	17951.2439	36.21	18.56	54.77	74.00	-19.23	Horizontal

AV Result:

No.	Frequency	Reading Level	Correct Factor	Result	Limit	Margin	Remark
	[MHz]	[dBuV/m]	[dB]	[dBuV/m]	[dBuV/m]	[dB]	
1	16961.1201	25.57	18.64	44.21	54.00	-9.79	Horizontal
2	17579.9475	25.74	17.56	43.30	54.00	-10.70	Horizontal
3	17951.2439	26.42	18.56	44.98	54.00	-9.02	Horizontal

- Note: 1. Measurement = Reading Level + Correct Factor;
 2. If Peak Result complies with AV limit, AV Result is deemed to comply with AV limit.
 3. Peak detector: RBW: 1 MHz, VBW: 3 MHz;
 4. Average detector: RBW: 1 MHz, VBW: 1/T MHz(refer to clause 7.1.);
 5. For above 3GHz part, filter losses were only considered in the spurious frequency bands and the authorized band was not corrected for HPF losses;
 6. Only the worst case emission was recorded, if it complies with the limit, the other emissions deemed to comply with the limit.



Test Mode	Channel	Polarization	Verdict
11N HT40	LCH	Vertical	PASS

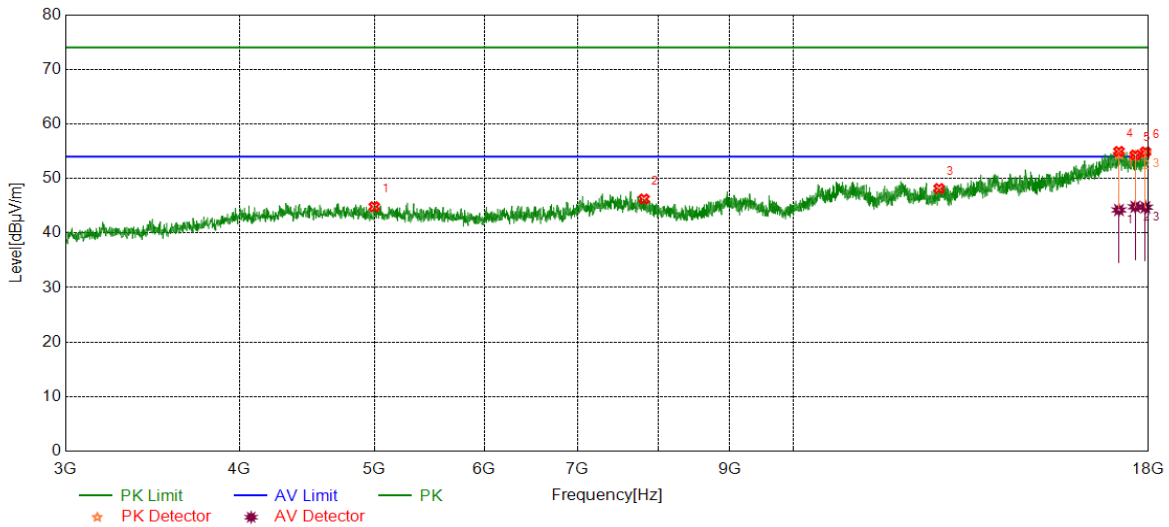

PK Result:

No.	Frequency	Reading Level	Correct Factor	Result	Limit	Margin	Remark
	[MHz]	[dBuV/m]	[dB]	[dBuV/m]	[dBuV/m]	[dB]	
1	5000.8751	39.53	5.29	44.82	74.00	-29.18	Vertical
2	7813.7267	38.22	8.01	46.23	74.00	-27.77	Vertical
3	12730.5913	36.69	11.47	48.16	74.00	-25.84	Vertical
4	17141.1426	36.68	18.28	54.96	74.00	-19.04	Vertical
5	17609.9512	36.42	17.87	54.29	74.00	-19.71	Vertical
6	17909.9887	36.60	18.28	54.88	74.00	-19.12	Vertical

AV Result:

No.	Frequency	Reading Level	Correct Factor	Result	Limit	Margin	Remark
	[MHz]	[dBuV/m]	[dB]	[dBuV/m]	[dBuV/m]	[dB]	
1	17141.1426	25.94	18.28	44.22	54.00	-9.78	Vertical
2	17609.9512	26.93	17.87	44.80	54.00	-9.20	Vertical
3	17909.9887	26.44	18.28	44.72	54.00	-9.28	Vertical

- Note: 1. Measurement = Reading Level + Correct Factor;
 2. If Peak Result complies with AV limit, AV Result is deemed to comply with AV limit.
 3. Peak detector: RBW: 1 MHz, VBW: 3 MHz;
 4. Average detector: RBW: 1 MHz, VBW: 1/T MHz(refer to clause 7.1.);
 5. For above 3GHz part, filter losses were only considered in the spurious frequency bands and the authorized band was not corrected for HPF losses;
 6. Only the worst case emission was recorded, if it complies with the limit, the other emissions deemed to comply with the limit.



Test Mode	Channel	Polarization	Verdict
11N HT40	MCH	Horizontal	PASS

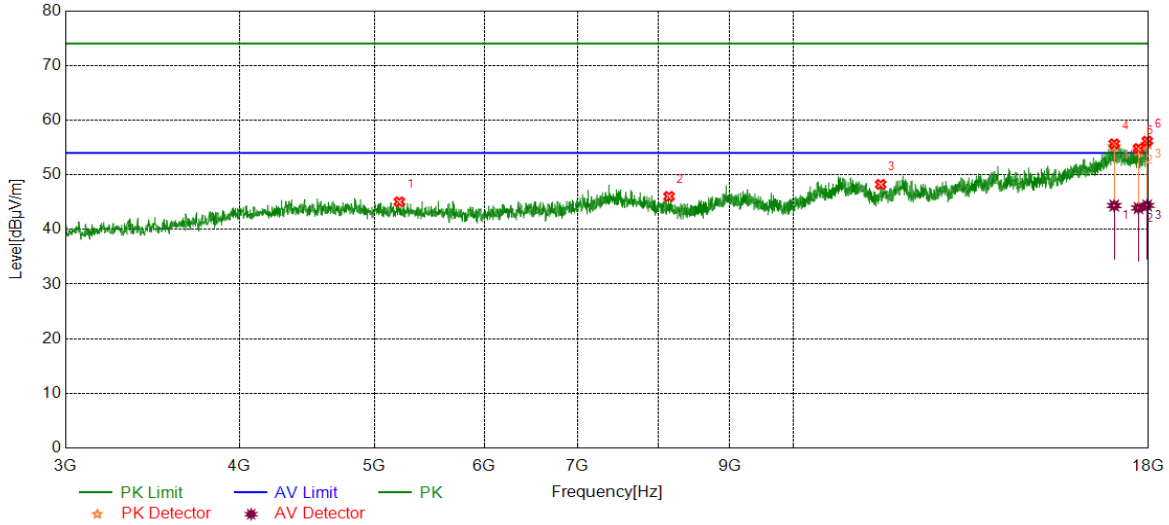

PK Result:

No.	Frequency	Reading Level	Correct Factor	Result	Limit	Margin	Remark
	[MHz]	[dBuV/m]	[dB]	[dBuV/m]	[dBuV/m]	[dB]	
1	5212.7766	39.57	5.48	45.05	74.00	-28.95	Horizontal
2	8143.7680	38.64	7.39	46.03	74.00	-27.97	Horizontal
3	11556.6946	36.89	11.34	48.23	74.00	-25.77	Horizontal
4	17008.0010	37.13	18.53	55.66	74.00	-18.34	Horizontal
5	17703.7130	37.09	17.71	54.80	74.00	-19.20	Horizontal
6	17960.6201	37.73	18.42	56.15	74.00	-17.85	Horizontal

AV Result:

No.	Frequency	Reading Level	Correct Factor	Result	Limit	Margin	Remark
	[MHz]	[dBuV/m]	[dB]	[dBuV/m]	[dBuV/m]	[dB]	
1	17008.0010	25.83	18.53	44.36	54.00	-9.64	Horizontal
2	17703.7130	26.21	17.71	43.92	54.00	-10.08	Horizontal
3	17960.6201	25.96	18.42	44.38	54.00	-9.62	Horizontal

- Note: 1. Measurement = Reading Level + Correct Factor;
 2. If Peak Result complies with AV limit, AV Result is deemed to comply with AV limit.
 3. Peak detector: RBW: 1 MHz, VBW: 3 MHz;
 4. Average detector: RBW: 1 MHz, VBW: 1/T MHz(refer to clause 7.1.);
 5. For above 3GHz part, filter losses were only considered in the spurious frequency bands and the authorized band was not corrected for HPF losses;
 6. Only the worst case emission was recorded, if it complies with the limit, the other emissions deemed to comply with the limit.



Test Mode	Channel	Polarization	Verdict
11N HT40	MCH	Vertical	PASS

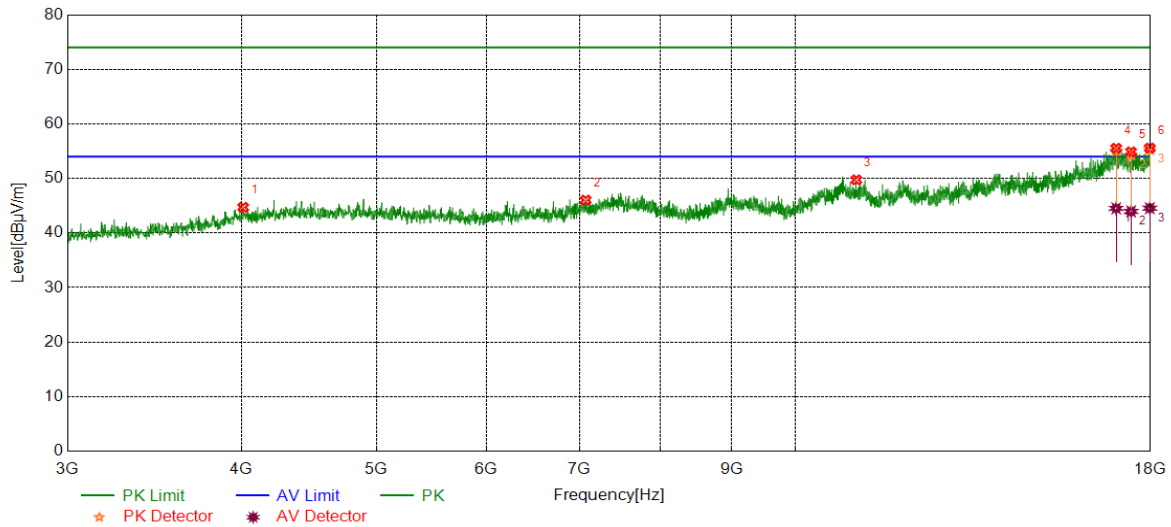

PK Result:

No.	Frequency	Reading Level	Correct Factor	Result	Limit	Margin	Remark
	[MHz]	[dBuV/m]	[dB]	[dBuV/m]	[dBuV/m]	[dB]	
1	4012.6266	40.12	4.59	44.71	74.00	-29.29	Vertical
2	7071.1339	37.75	8.27	46.02	74.00	-27.98	Vertical
3	11065.3832	37.56	12.19	49.75	74.00	-24.25	Vertical
4	17006.1258	36.99	18.54	55.53	74.00	-18.47	Vertical
5	17431.8040	36.98	17.89	54.87	74.00	-19.13	Vertical
6	17979.3724	37.47	18.09	55.56	74.00	-18.44	Vertical

AV Result:

No.	Frequency	Reading Level	Correct Factor	Result	Limit	Margin	Remark
	[MHz]	[dBuV/m]	[dB]	[dBuV/m]	[dBuV/m]	[dB]	
1	17006.1258	25.98	18.54	44.52	54.00	-9.48	Vertical
2	17431.8040	26.07	17.89	43.96	54.00	-10.04	Vertical
3	17979.3724	26.46	18.09	44.55	54.00	-9.45	Vertical

- Note: 1. Measurement = Reading Level + Correct Factor;
 2. If Peak Result complies with AV limit, AV Result is deemed to comply with AV limit.
 3. Peak detector: RBW: 1 MHz, VBW: 3 MHz;
 4. Average detector: RBW: 1 MHz, VBW: 1/T MHz(refer to clause 7.1.);
 5. For above 3GHz part, filter losses were only considered in the spurious frequency bands and the authorized band was not corrected for HPF losses;
 6. Only the worst case emission was recorded, if it complies with the limit, the other emissions deemed to comply with the limit.



Test Mode	Channel	Polarization	Verdict
11N HT40	HCH	Horizontal	PASS

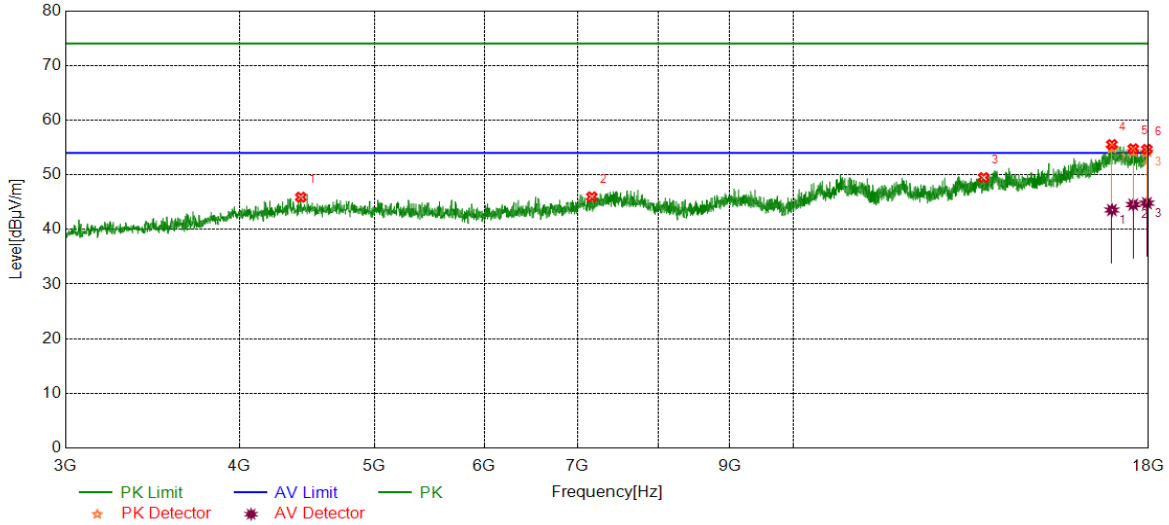

PK Result:

No.	Frequency	Reading Level	Correct Factor	Result	Limit	Margin	Remark
	[MHz]	[dBuV/m]	[dB]	[dBuV/m]	[dBuV/m]	[dB]	
1	4428.9286	40.81	5.09	45.90	74.00	-28.10	Horizontal
2	7166.7708	37.58	8.39	45.97	74.00	-28.03	Horizontal
3	13705.7132	36.12	13.37	49.49	74.00	-24.51	Horizontal
4	16942.3678	37.10	18.44	55.54	74.00	-18.46	Horizontal
5	17549.9437	36.69	18.08	54.77	74.00	-19.23	Horizontal
6	17953.1191	36.11	18.54	54.65	74.00	-19.35	Horizontal

AV Result:

No.	Frequency	Reading Level	Correct Factor	Result	Limit	Margin	Remark
	[MHz]	[dBuV/m]	[dB]	[dBuV/m]	[dBuV/m]	[dB]	
1	16942.3678	25.11	18.44	43.55	54.00	-10.45	Horizontal
2	17549.9437	26.46	18.08	44.54	54.00	-9.46	Horizontal
3	17953.1191	26.27	18.54	44.81	54.00	-9.19	Horizontal

- Note: 1. Measurement = Reading Level + Correct Factor;
 2. If Peak Result complies with AV limit, AV Result is deemed to comply with AV limit.
 3. Peak detector: RBW: 1 MHz, VBW: 3 MHz;
 4. Average detector: RBW: 1 MHz, VBW: 1/T MHz(refer to clause 7.1.);
 5. For above 3GHz part, filter losses were only considered in the spurious frequency bands and the authorized band was not corrected for HPF losses;
 6. Only the worst case emission was recorded, if it complies with the limit, the other emissions deemed to comply with the limit.



Test Mode	Channel	Polarization	Verdict
11N HT40	HCH	Vertical	PASS

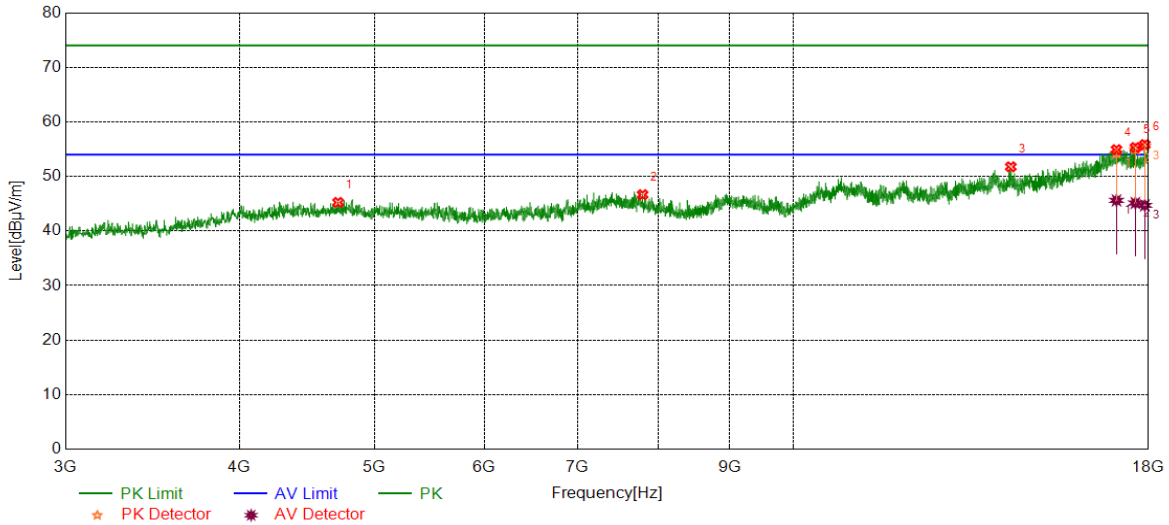

PK Result:

No.	Frequency	Reading Level	Correct Factor	Result	Limit	Margin	Remark
	[MHz]	[dBuV/m]	[dB]	[dBuV/m]	[dBuV/m]	[dB]	
1	4710.2138	39.56	5.68	45.24	74.00	-28.76	Vertical
2	7794.9744	38.60	8.06	46.66	74.00	-27.34	Vertical
3	14333.9167	37.64	14.13	51.77	74.00	-22.23	Vertical
4	17071.7590	35.81	19.11	54.92	74.00	-19.08	Vertical
5	17613.7017	37.52	17.78	55.30	74.00	-18.70	Vertical
6	17891.2364	37.31	18.53	55.84	74.00	-18.16	Vertical

AV Result:

No.	Frequency	Reading Level	Correct Factor	Result	Limit	Margin	Remark
	[MHz]	[dBuV/m]	[dB]	[dBuV/m]	[dBuV/m]	[dB]	
1	17071.7590	26.50	19.11	45.61	54.00	-8.39	Vertical
2	17613.7017	27.35	17.78	45.13	54.00	-8.87	Vertical
3	17891.2364	26.17	18.53	44.70	54.00	-9.30	Vertical

- Note: 1. Measurement = Reading Level + Correct Factor;
 2. If Peak Result complies with AV limit, AV Result is deemed to comply with AV limit.
 3. Peak detector: RBW: 1 MHz, VBW: 3 MHz;
 4. Average detector: RBW: 1 MHz, VBW: 1/T MHz(refer to clause 7.1.);
 5. For above 3GHz part, filter losses were only considered in the spurious frequency bands and the authorized band was not corrected for HPF losses;
 6. Only the worst case emission was recorded, if it complies with the limit, the other emissions deemed to comply with the limit.



Part III: 18GHz~26.5GHz

SPURIOUS EMISSIONS 18GHz TO 26.5GHz (WORST-CASE CONFIGURATION)

Test Mode	Channel	Polarization	Verdict
11B	LCH	Horizontal	PASS

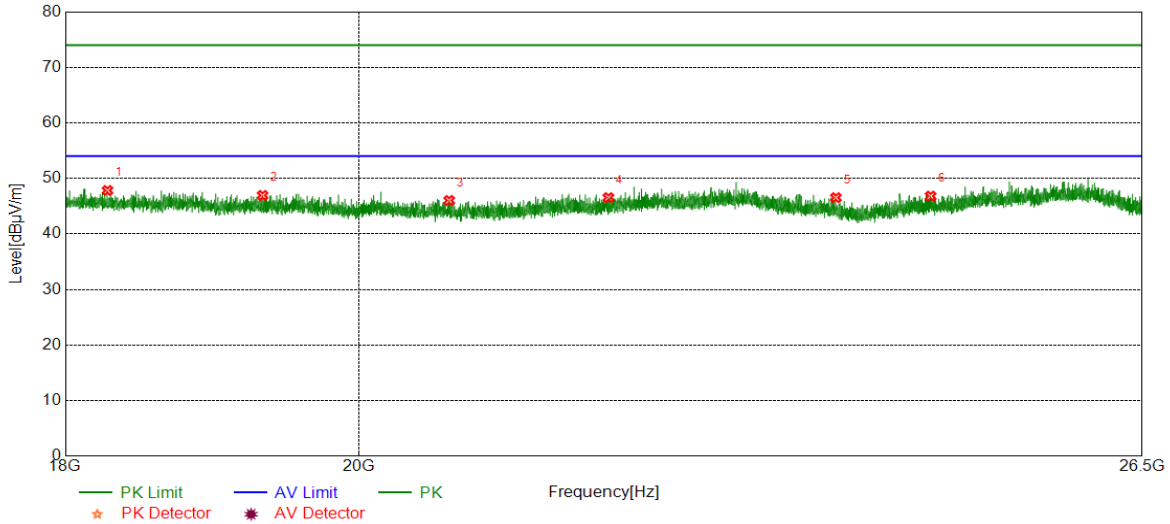

No.	Frequency	Reading Level	Correct Factor	Result	Limit	Margin	Remark
	[MHz]	[dBuV/m]	[dB]	[dBuV/m]	[dBuV/m]	[dB]	
1	18274.5775	48.86	-1.03	47.83	74.00	-26.17	Horizontal
2	19321.8822	47.79	-0.86	46.93	74.00	-27.07	Horizontal
3	20661.6162	46.86	-0.83	46.03	74.00	-27.97	Horizontal
4	21878.0878	46.54	0.00	46.54	74.00	-27.46	Horizontal
5	23740.6241	47.20	-0.67	46.53	74.00	-27.47	Horizontal
6	24562.6563	47.30	-0.49	46.81	74.00	-27.19	Horizontal

Note: 1. If Peak Result complies with AV limit, AV Result is deemed to comply with AV limit.
 2. Test setup: RBW: 1 MHz, VBW: 3 MHz, Sweep time: auto.
 3. Measurement = Reading Level + Correct Factor.
 4. Only the worst case emission was recorded, if it complies with the limit, the other emissions deemed to comply with the limit.



Test Mode	Channel	Polarization	Verdict
11B	LCH	Vertical	PASS

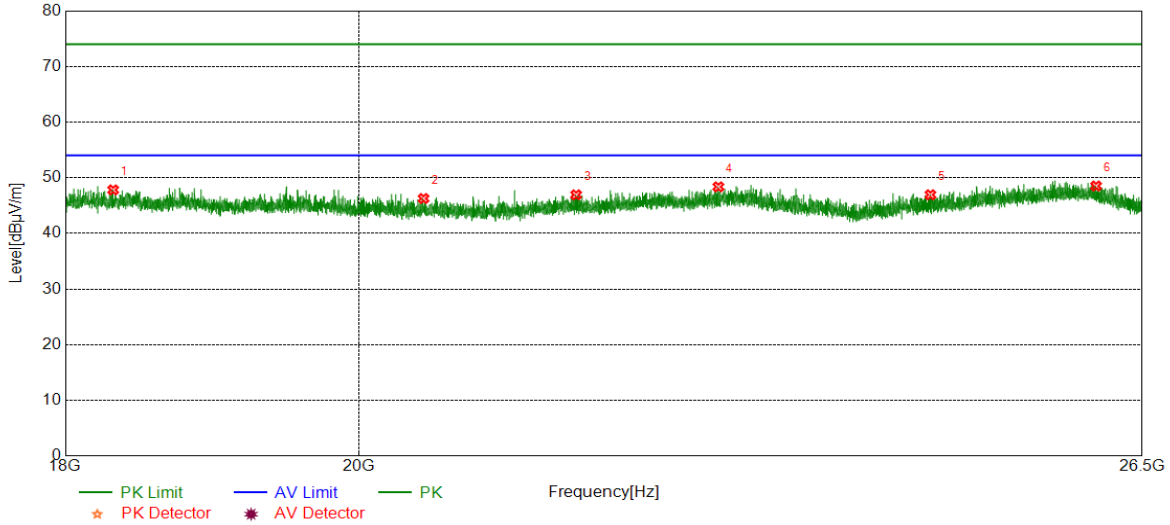

No.	Frequency	Reading Level	Correct Factor	Result	Limit	Margin	Remark
	[MHz]	[dBuV/m]	[dB]	[dBuV/m]	[dBuV/m]	[dB]	
1	18311.9812	48.83	-1.01	47.82	74.00	-26.18	Vertical
2	20472.0472	46.94	-0.67	46.27	74.00	-27.73	Vertical
3	21625.6126	47.27	-0.34	46.93	74.00	-27.07	Vertical
4	22759.6260	47.33	1.04	48.37	74.00	-25.63	Vertical
5	24560.9561	47.44	-0.50	46.94	74.00	-27.06	Vertical
6	26067.3067	46.98	1.54	48.52	74.00	-25.48	Vertical

- Note: 1. If Peak Result complies with AV limit, AV Result is deemed to comply with AV limit.
 2. Test setup: RBW: 1 MHz, VBW: 3 MHz, Sweep time: auto.
 3. Measurement = Reading Level + Correct Factor.
 4. Only the worst case emission was recorded, if it complies with the limit, the other emissions deemed to comply with the limit.



Part IV: 30MHz~1GHz

SPURIOUS EMISSIONS 30M TO 1GHz (WORST-CASE CONFIGURATION)

Test Mode	Channel	Polarization	Verdict
11B	LCH	Horizontal	PASS

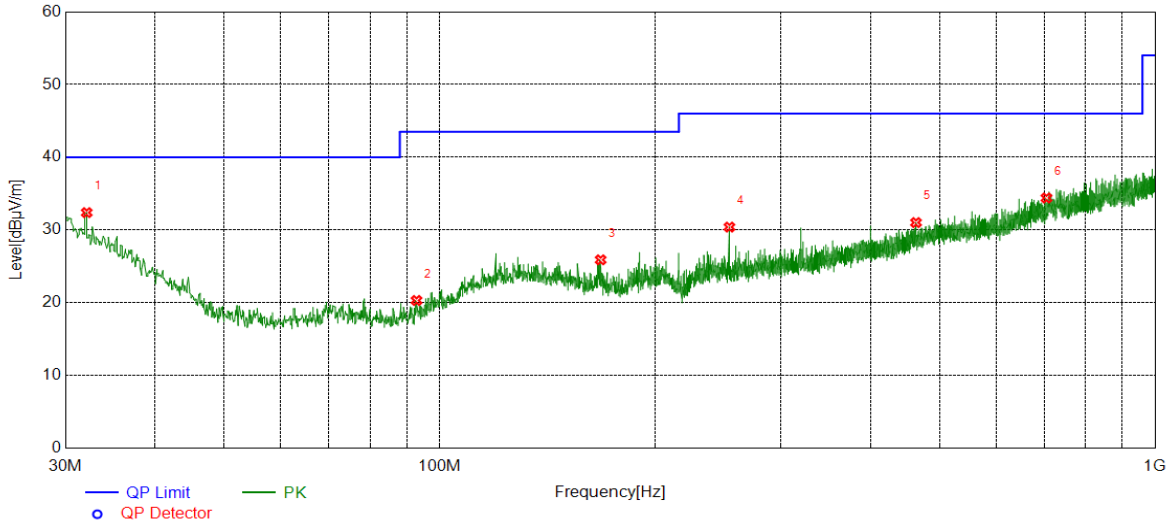

No.	Frequency	Reading Level	Correct Factor	Result	Limit	Margin	Remark
	[MHz]	[dBuV/m]	[dB]	[dBuV/m]	[dBuV/m]	[dB]	
1	32.1342	6.70	25.69	32.39	40.00	-7.61	Horizontal
2	92.8623	5.17	15.14	20.31	43.50	-23.19	Horizontal
3	167.9478	7.47	18.43	25.90	43.50	-17.60	Horizontal
4	254.1894	11.36	19.04	30.40	46.00	-15.60	Horizontal
5	463.3423	6.32	24.70	31.02	46.00	-14.98	Horizontal
6	704.9935	5.79	28.61	34.40	46.00	-11.60	Horizontal

Note: 1. If Peak Result complies with QP limit, QP Result is deemed to comply with QP limit.
 2. Test setup: RBW: 120 kHz, VBW: 300 kHz, Sweep time: auto.
 3. Measurement = Reading Level + Correct Factor.



Test Mode	Channel	Polarization	Verdict
11B	LCH	Vertical	PASS

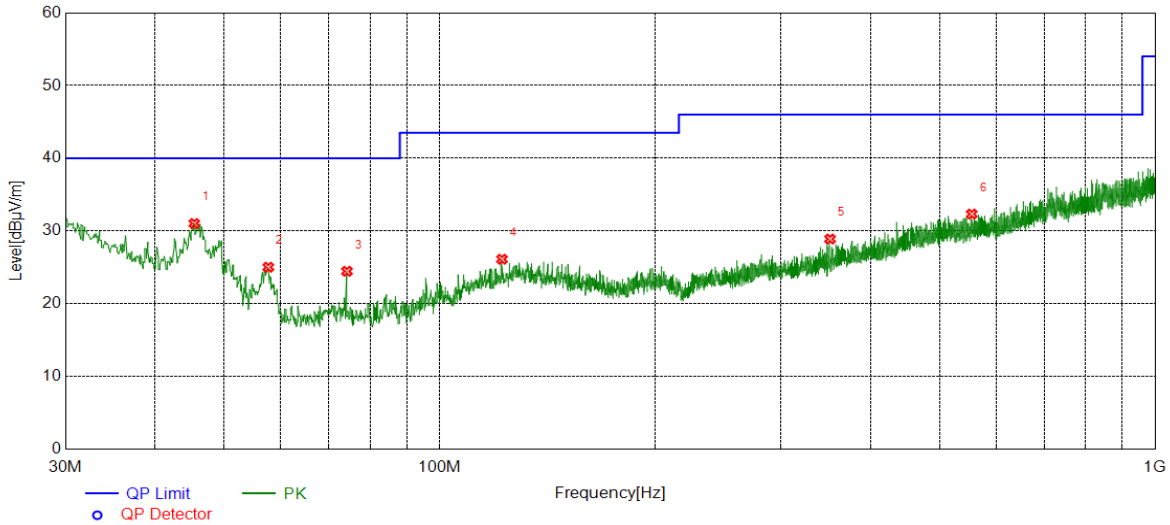

No.	Frequency	Reading Level	Correct Factor	Result	Limit	Margin	Remark
	[MHz]	[dBuV/m]	[dB]	[dBuV/m]	[dBuV/m]	[dB]	
1	45.4245	13.67	17.36	31.03	40.00	-8.97	Vertical
2	57.6478	10.88	14.14	25.02	40.00	-14.98	Vertical
3	74.2364	9.85	14.61	24.46	40.00	-15.54	Vertical
4	122.2562	5.75	20.37	26.12	43.50	-17.38	Vertical
5	351.3931	7.17	21.73	28.90	46.00	-17.10	Vertical
6	554.3374	6.13	26.20	32.33	46.00	-13.67	Vertical

Note: 1. If Peak Result complies with QP limit, QP Result is deemed to comply with QP limit.
 2. Test setup: RBW: 120 kHz, VBW: 300 kHz, Sweep time: auto.
 3. Measurement = Reading Level + Correct Factor.



Part V: 9KHz~30MHz

SPURIOUS EMISSIONS Below 30MHz (WORST CASE CONFIGURATION-FACE ON)

Test Mode	Channel	Frequency Range	Verdict
11B	LCH	9kHz~150kHz	PASS

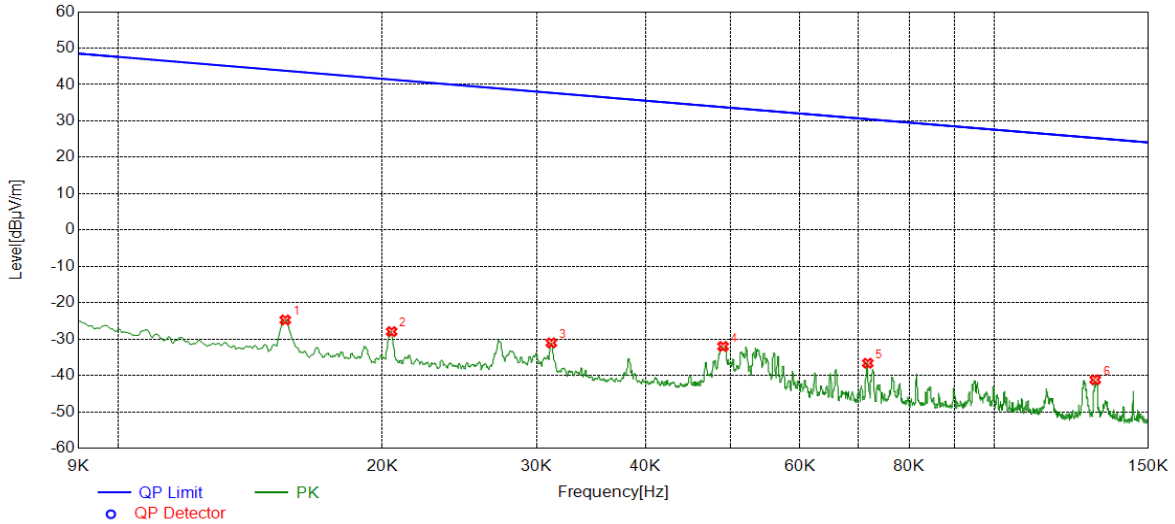

No.	Frequency	Reading Level	Correct Factor	Result	Limit	Margin	Remark
	[MHz]	[dBuV/m]	[dB]	[dBuV/m]	[dBuV/m]	[dB]	
1	0.0155	36.24	-60.98	-24.74	43.80	-68.54	Horizontal
2	0.0205	32.91	-60.85	-27.94	41.38	-69.32	Horizontal
3	0.0312	29.88	-60.92	-31.04	37.72	-68.76	Horizontal
4	0.0490	29.02	-61.03	-32.01	33.80	-65.81	Horizontal
5	0.0717	24.76	-61.38	-36.62	30.49	-67.11	Horizontal
6	0.1304	19.90	-61.08	-41.18	25.30	-66.48	Horizontal

- Note: 1. Measurement = Reading Level + Correct Factor.
 2. If Peak Result complies with AV and QP limit, AV and QP Result are deemed to comply with AV limit.
 3. All 3 polarizations(Horizontal, Face-on and Face-off) of the loop antenna had been tested, but only the worst data recorded in the report.



Test Mode	Channel	Frequency Range	Verdict
11B	LCH	150kHz~490kHz	PASS

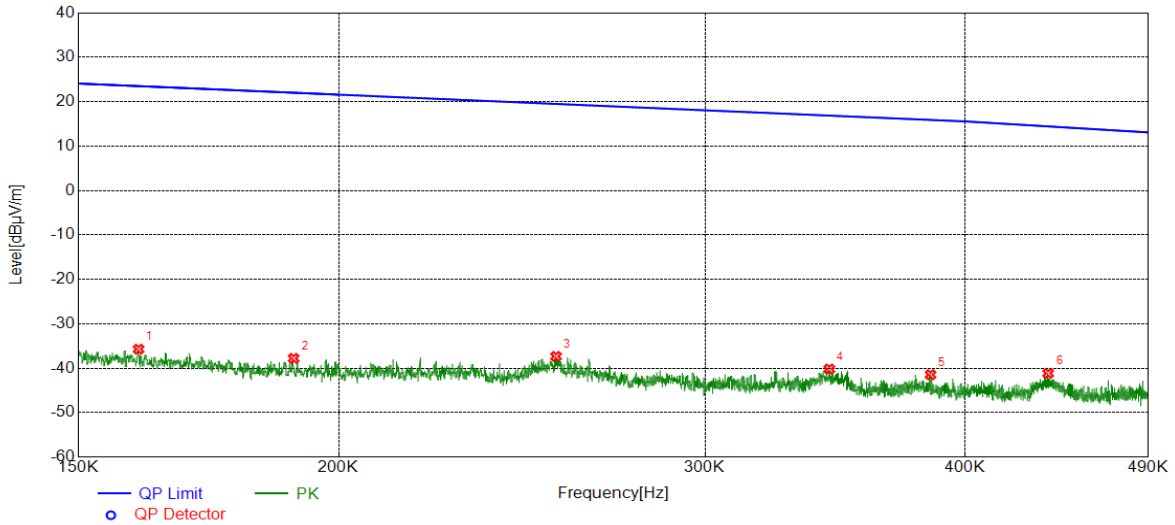

No.	Frequency	Reading Level	Correct Factor	Result	Limit	Margin	Remark
	[MHz]	[dBuV/m]	[dB]	[dBuV/m]	[dBuV/m]	[dB]	
1	0.1603	25.55	-61.26	-35.71	23.50	-59.21	Vertical
2	0.1903	23.34	-61.11	-37.77	22.02	-59.79	Vertical
3	0.2544	23.47	-60.80	-37.33	19.49	-56.82	Vertical
4	0.3442	20.55	-60.72	-40.17	16.86	-57.03	Vertical
5	0.3850	19.24	-60.69	-41.45	15.89	-57.34	Vertical
6	0.4385	19.50	-60.65	-41.15	14.44	-55.59	Vertical

- Note: 1. Measurement = Reading Level + Correct Factor.
 2. If Peak Result complies with AV and QP limit, AV and QP Result are deemed to comply with AV limit.
 3. All 3 polarizations(Horizontal, Face-on and Face-off) of the loop antenna had been tested, but only the worst data recorded in the report.



Test Mode	Channel	Frequency Range	Verdict
11B	LCH	490kHz~30MHz	PASS

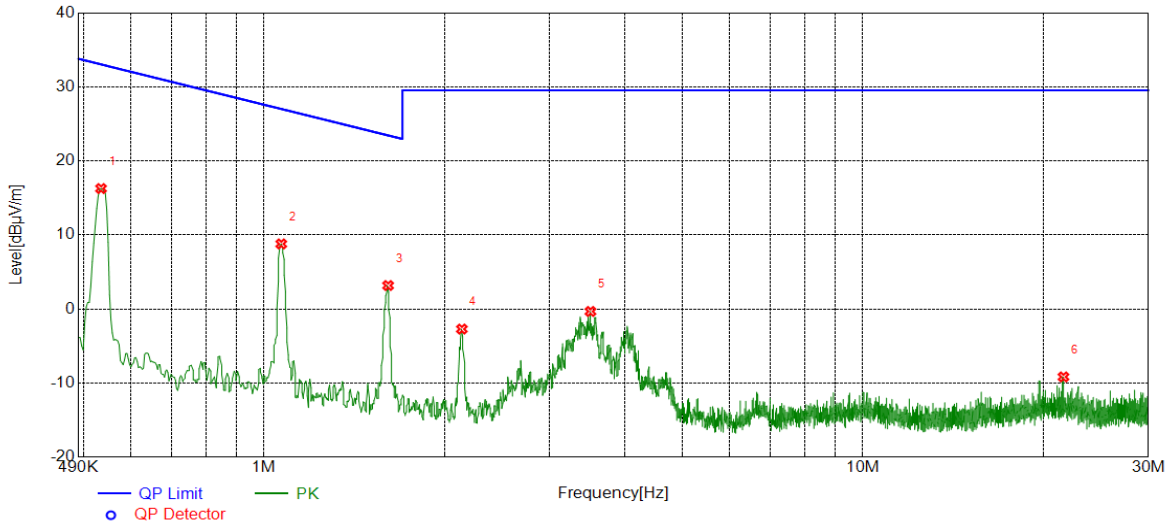

No.	Frequency	Reading Level	Correct Factor	Result	Limit	Margin	Remark
	[MHz]	[dBuV/m]	[dB]	[dBuV/m]	[dBuV/m]	[dB]	
1	0.5343	36.87	-20.60	16.27	33.05	-16.78	Vertical
2	1.0685	29.14	-20.35	8.79	27.03	-18.24	Vertical
3	1.6115	23.44	-20.27	3.17	23.46	-20.29	Vertical
4	2.1398	17.53	-20.24	-2.71	29.54	-32.25	Vertical
5	3.5092	19.92	-20.25	-0.33	29.54	-29.87	Vertical
6	21.6301	8.37	-17.54	-9.17	29.54	-38.71	Vertical

- Note: 1. Measurement = Reading Level + Correct Factor.
 2. If Peak Result complies with AV and QP limit, AV and QP Result are deemed to comply with AV limit.
 3. All 3 polarizations(Horizontal, Face-on and Face-off) of the loop antenna had been tested, but only the worst data recorded in the report.

8. AC POWER LINE CONDUCTED EMISSIONS

LIMITS

Please refer to FCC §15.207 (a)

FREQUENCY (MHz)	Limit (dBuV)	
	Quasi-peak	Average
0.15 -0.5	66 - 56 *	56 - 46 *
0.50 -5.0	56.00	46.00
5.0 -30.0	60.00	50.00

TEST SETUP AND PROCEDURE

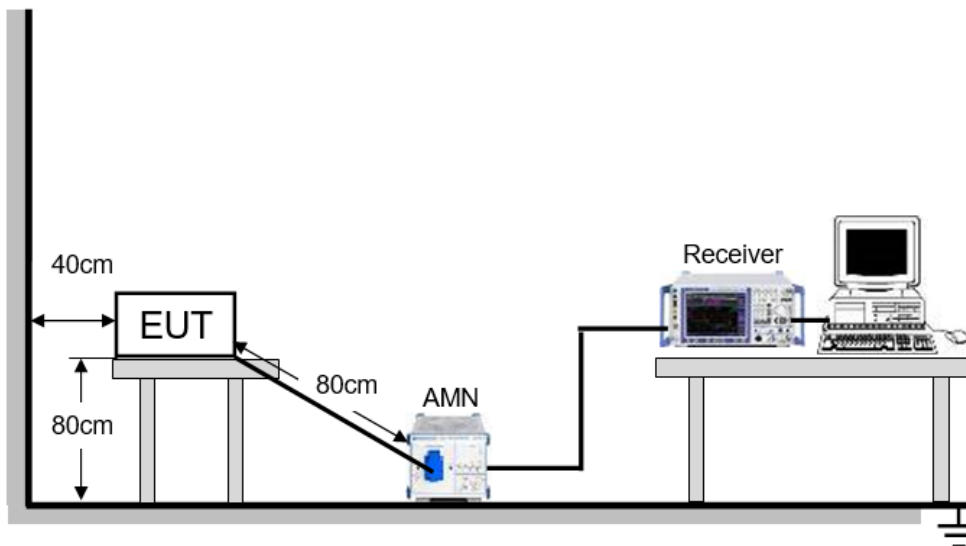

The EUT is put on a table of non-conducting material that is 80cm high. The vertical conducting wall of shielding is located 40cm to the rear of the EUT. The power line of the EUT is connected to the AC mains through a Artificial Mains Network (A.M.N.). A EMI Measurement Receiver (R&S Test Receiver ESR3) is used to test the emissions from both sides of AC line. According to the requirements in Section 6.2 of ANSI C63.10-2013. Conducted emissions from the EUT measured in the frequency range between 0.15 MHz and 30MHz using CISPR Quasi-Peak and average detector mode. The bandwidth of EMI test receiver is set at 9kHz.

The arrangement of the equipment is installed to meet the standards and operating in a manner, which tends to maximize its emission characteristics in a normal application.



LINE L RESULTS (WORST-CASE CONFIGURATION)

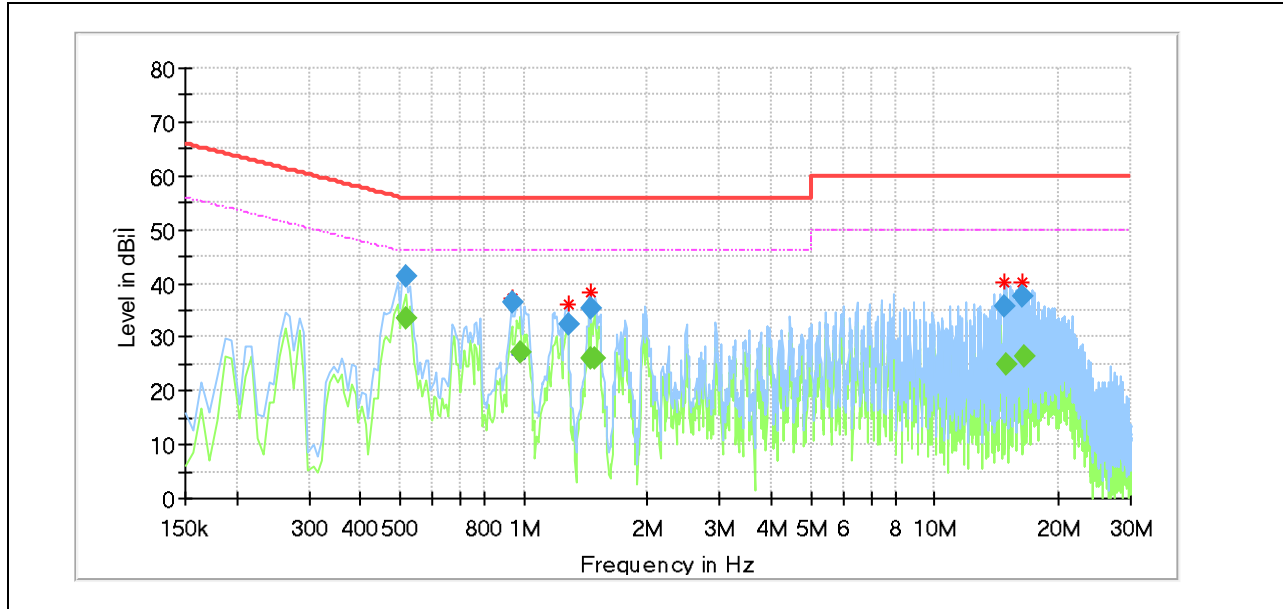

Final_Result

Frequency [MHz]	QuasiPeak [dBμV]	Average [dBμV]	Limit [dBμV]	Margin [dB]	Meas. Time [ms]	Bandwidth [kHz]	Line	Filter	Corr. [dB]
0.515663	---	33.60	46.00	12.40	1000.0	9.000	L1	OFF	9.7
0.515663	41.46	---	56.00	14.54	1000.0	9.000	L1	OFF	9.7
0.933563	36.50	---	56.00	19.50	1000.0	9.000	L1	OFF	9.7
0.978338	---	27.12	46.00	18.88	1000.0	9.000	L1	OFF	9.7
1.284300	32.40	---	56.00	23.60	1000.0	9.000	L1	OFF	9.5
1.448475	---	25.96	46.00	20.04	1000.0	9.000	L1	OFF	9.5
1.463400	35.21	---	56.00	20.79	1000.0	9.000	L1	OFF	9.5
1.493250	---	26.08	46.00	19.92	1000.0	9.000	L1	OFF	9.6
14.716800	35.75	---	60.00	24.25	1000.0	9.000	L1	OFF	9.5
14.880975	---	24.75	50.00	25.25	1000.0	9.000	L1	OFF	9.5
16.358550	37.56	---	60.00	22.44	1000.0	9.000	L1	OFF	9.5
16.463025	---	26.36	50.00	23.64	1000.0	9.000	L1	OFF	9.5

- Note: 1. If QP Result complies with AV limit, AV Result is deemed to comply with AV limit.
 2. Test setup: RBW: 200 Hz (9 kHz—150 kHz), 9 kHz (150 kHz—30 MHz).
 3. Step size: 80Hz (0.009MHz-0.15MHz), 4 kHz (0.15MHz-30MHz), Scan time: auto.
 4. The extension cord/outlet strip was calibrated with the LISN as required by ANSI C63.10:2013 Clause 6.2.2.
 5. Pre-testing all test modes and channels, and find the LCH of 11b which is the worst case, so only the worst case is included in this test report.



LINE N RESULTS (WORST-CASE CONFIGURATION)

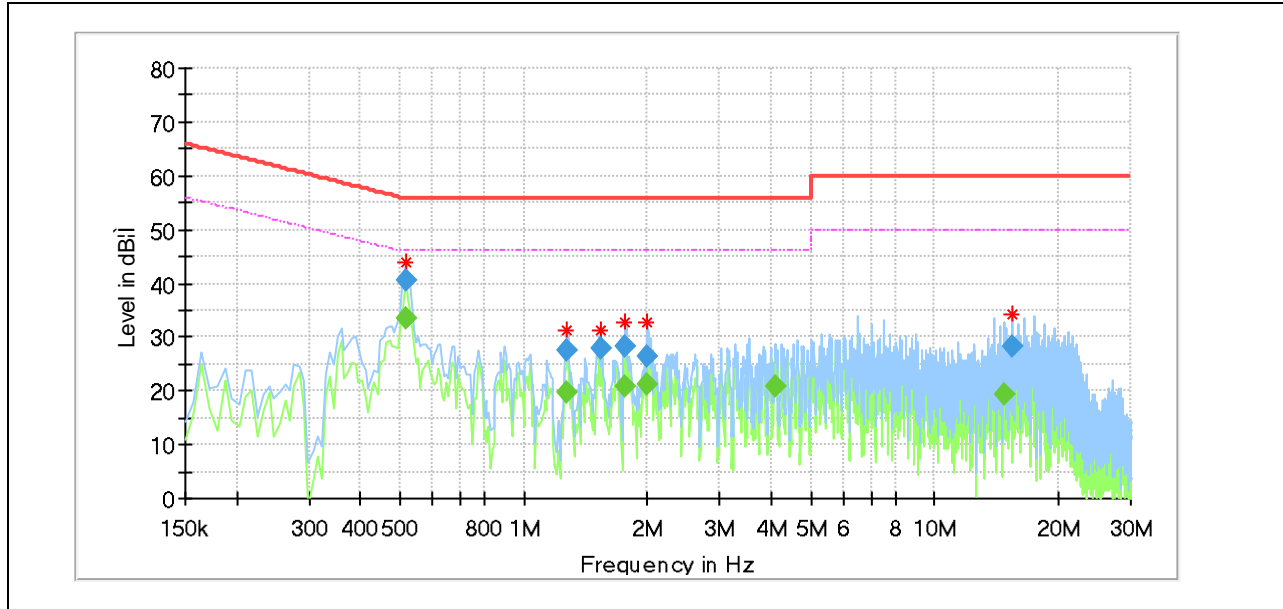

Final_Result

Frequency [MHz]	QuasiPeak [dBμV]	Average [dBμV]	Limit [dBμV]	Margin [dB]	Meas. Time [ms]	Bandwidth [kHz]	Line	Filter	Corr. [dB]
0.515663	---	33.61	46.00	12.39	1000.0	9.000	N	OFF	9.6
0.515663	40.62	---	56.00	15.38	1000.0	9.000	N	OFF	9.6
1.276838	---	19.72	46.00	26.28	1000.0	9.000	N	OFF	9.6
1.276838	27.62	---	56.00	28.38	1000.0	9.000	N	OFF	9.6
1.545488	28.09	---	56.00	27.91	1000.0	9.000	N	OFF	9.5
1.769363	---	20.85	46.00	25.15	1000.0	9.000	N	OFF	9.6
1.769363	28.35	---	56.00	27.65	1000.0	9.000	N	OFF	9.6
2.000700	---	21.04	46.00	24.96	1000.0	9.000	N	OFF	9.7
2.000700	26.59	---	56.00	29.41	1000.0	9.000	N	OFF	9.7
4.090200	---	20.99	46.00	25.01	1000.0	9.000	N	OFF	9.6
14.731725	---	19.30	50.00	30.70	1000.0	9.000	N	OFF	9.5
15.470513	28.18	---	60.00	31.82	1000.0	9.000	N	OFF	9.5

- Note: 1. If QP Result complies with AV limit, AV Result is deemed to comply with AV limit.
 2. Test setup: RBW: 200 Hz (9 kHz—150 kHz), 9 kHz (150 kHz—30 MHz).
 3. Step size: 80Hz (0.009MHz-0.15MHz), 4 kHz (0.15MHz-30MHz), Scan time: auto.
 4. The extension cord/outlet strip was calibrated with the LISN as required by ANSI C63.10:2013 Clause 6.2.2.
 5. Pre-testing all test modes and channels, and find the LCH of 11b which is the worst case, so only the worst case is included in this test report.



9. ANTENNA REQUIREMENTS

APPLICABLE REQUIREMENTS

Please refer to FCC §15.203

An intentional radiator shall be designed to ensure that no antenna other than that furnished by the responsible party shall be used with the device. The use of a permanently attached antenna or of an antenna that uses a unique coupling to the intentional radiator shall be considered sufficient to comply with the provisions of this section. The manufacturer may design the unit so that a broken antenna can be replaced by the user, but the use of a standard antenna jack or electrical connector is prohibited.

Please refer to FCC §15.247(b)(4)

The conducted output power limit specified in paragraph (b) of this section is based on the use of antennas with directional gains that do not exceed 6 dBi. Except as shown in paragraph (c) of this section, if transmitting antennas of directional gain greater than 6 dBi are used, the conducted output power from the intentional radiator shall be reduced below the stated values in paragraphs (b)(1), (b)(2), and (b)(3) of this section, as appropriate, by the amount in dB that the directional gain of the antenna exceeds 6 dBi.

ANTENNA GAIN

The antenna gain of EUT is less than 6 dBi

END OF REPORT