

FCC RADIO TEST REPORT

FCC ID:2AVYC-PANTHEONE1

Product: Active speaker
Trade Name: PANTHEONE
Model Name: Pantheone I
Serial Model: N/A
Report No.: UNIA20010610ER-02

Prepared for

Pantheone Pty Ltd

Level 6,151 Macquarie Street Sydney NSW 2000 Australia

Prepared by

Shenzhen United Testing Technology Co., Ltd.

2F, Annex Bldg, Jiahuangyuan Tech Park, #365 Baotian 1 Rd, Tiegang Community, Xixiang Str, Bao'an District, Shenzhen, China



TEST RESULT CERTIFICATION

Applicant's name.....: Pantheone Pty Ltd

Address.....: Level 6,151 Macquarie Street Sydney NSW 2000 Australia

Manufacturer's Name.....: Pantheone Pty Ltd

Address.....: Level 6,151 Macquarie Street Sydney NSW 2000 Australia

Product description

Product name.....: Active speaker

Trade Mark.....: PANTHEONE

Model and/or type reference : Pantheone I

Standards.....: FCC Rules and Regulations Part 15 Subpart C Section 15.249,
ANSI C63.10: 2013

This device described above has been tested by Shenzhen United Testing Technology Co., Ltd., and the test results show that the equipment under test (EUT) is in compliance with the FCC requirements. And it is applicable only to the tested sample identified in the report.

This report shall not be reproduced except in full, without the written approval of UNI, this document may be altered or revised by Shenzhen United Testing Technology Co., Ltd., personnel only, and shall be noted in the revision of the document.

Date of Test.....:

Date (s) of performance of tests.....: Jan. 06, 2020 ~ Mar. 24, 2020

Date of Issue.....: Mar. 24, 2020

Test Result.....: Pass

Prepared by:

Bob Liao

Bob Liao/Editor

Reviewer:

Kahn Yan

Kahn Yan/Supervisor

Approved & Authorized Signer:

Liuze

Liuze/Manager

Table of Contents

Page

1. TEST SUMMARY.....	4
2. GENERAL INFORMATION.....	5
2.1 GENERAL DESCRIPTION OF EUT.....	5
2.2 Carrier Frequency of Channels.....	6
2.3 Operation of EUT during testing.....	7
2.4 DESCRIPTION OF TEST SETUP.....	7
2.5 MEASUREMENT INSTRUMENTS LIST.....	8
3. CONDUCTED EMISSIONS TEST.....	9
3.1 Conducted Power Line Emission Limit.....	9
3.2 Test Setup.....	9
3.3 Test Procedure.....	9
3.4 Test Result.....	9
4. RADIATED EMISSION TEST.....	12
4.1 Radiation Limit.....	12
4.2 Test Setup.....	12
4.3 Test Procedure.....	13
4.4 Test Result.....	13
5. BAND EDGE.....	25
5.1 Limits.....	25
5.2 Test Procedure.....	25
5.3 Test Result.....	25
6. OCCUPIED BANDWIDTH MEASUREMENT.....	31
6.1 Test Setup.....	31
6.2 Test Procedure.....	31
6.3 Measurement Equipment Used.....	31
6.4 Test Result.....	31
7. ANTENNA REQUIREMENT.....	37
8. PHOTOGRAPH OF TEST.....	38
8.1 Radiated Emission.....	38
8.2 Conducted Emission.....	39

1. TEST SUMMARY

TEST PROCEDURES AND RESULTS

DESCRIPTION OF TEST	RESULT	STANGARD
CONDUCTED EMISSIONS TEST	COMPLIANT	FCC Part 15.207
RADIATED EMISSION TEST	COMPLIANT	FCC Part 15.209/15.249
BAND EDGE	COMPLIANT	FCC Part 15.249/15.205
20dB Bandwidth	COMPLIANT	FCC Part 15.215
ANTENNA REQUIREMENT	COMPLIANT	FCC Part 15.203

TEST FACILITY

Test Firm : Shenzhen United Testing Technology Co., Ltd.
 Address : 2F, Annex Bldg, Jiahuangyuan Tech Park, #365 Baotian 1 Rd, Tiegang Community, Xixiang Str, Bao'an District, Shenzhen, China

The testing quality ability of our laboratory meet with "Quality Law of People's Republic of China" Clause 19.The testing quality system of our laboratory meets with ISO/IEC-17025 requirements. This approval result is accepted by MRA of APLAC.

Our test facility is recognized, certified, or accredited by the following organizations:

A2LA Certificate Number: 4747.01

The EMC Laboratory has been accredited by A2LA, and in compliance with ISO/IEC 17025:2017 General Requirements for testing Laboratories.

FCC Registration Number: 674885

The EMC Laboratory has been registered and fully described in a report filed with the (FCC) Federal Communications commission.

IC Registration Number: 21947

The EMC Laboratory has been registered and fully described in a report filed with the (IC) Industry Canada.

MEASUREMENT UNCERTAINTY

Measurement Uncertainty

Conducted Emission Expanded Uncertainty	=	2.23dB, k=2
Radiated emission expanded uncertainty(9kHz-30MHz)	=	3.08dB, k=2
Radiated emission expanded uncertainty(30MHz-1000MHz)	=	4.42dB, k=2
Radiated emission expanded uncertainty(Above 1GHz)	=	4.06dB, k=2

2. GENERAL INFORMATION

2.1 GENERAL DESCRIPTION OF EUT

Equipment	Active speaker
Trade Mark	PANTHEONE
Model Name	Pantheone I
Serial No.	N/A
Model Difference	N/A
FCC ID	2AVYC-PANTHEONE1
Antenna Type	Active speaker
Antenna Gain	1dBi
Frequency Range	2402~2480MHz
Number of Channels	79CH
Modulation Type	GFSK, $\pi/4$ DQPSK, 8DPSK
Battery	N/A
PowerSource	AC 100-240V~50/60Hz

2.2 Carrier Frequency of Channels

Channel List							
Channel	Frequency (MHz)	Channel	Frequency (MHz)	Channel	Frequency (MHz)	Channel	Frequency (MHz)
00	2402	21	2423	42	2444	63	2465
01	2403	22	2424	43	2445	64	2466
02	2404	23	2425	44	2446	65	2467
03	2405	24	2426	45	2447	66	2468
04	2406	25	2427	46	2448	67	2469
05	2407	26	2428	47	2449	68	2470
06	2408	27	2429	48	2450	69	2471
07	2409	28	2430	49	2451	70	2472
08	2410	29	2431	50	2452	71	2473
09	2411	30	2432	51	2453	72	2474
10	2412	31	2433	52	2454	73	2475
11	2413	32	2434	53	2455	74	2476
12	2414	33	2435	54	2456	75	2477
13	2415	34	2436	55	2457	76	2478
14	2416	35	2437	56	2458	77	2479
15	2417	36	2438	57	2459	78	2480
16	2418	37	2439	58	2460		
17	2419	38	2440	59	2461		
18	2420	39	2441	60	2462		
19	2421	40	2442	61	2463		
20	2422	41	2443	62	2464		

2.3 Operation of EUT during testing

Operating Mode

The mode is used: Transmitting mode

Low Channel: 2402MHz

Middle Channel: 2441MHz

High Channel: 2480MHz

2.4 DESCRIPTION OF TEST SETUP

Operation of EUT during Conducted testing:



Operation of EUT during Radiation testing:



Table for auxiliary equipment:

Equipment Description	Manufacturer	Model	Calibration Due Date
N/A	N/A	N/A	N/A

2.5 MEASUREMENT INSTRUMENTS LIST

Item	Equipment	Manufacturer	Model No.	Serial No.	Calibrated until
Conduction Emissions Measurement					
1	Conducted Emission Test Software	EZ-EMC	Ver.CCS-3A1-CE	N/A	N/A
2	AMN	Schwarzbeck	NNLK8121	8121370	2020.10.15
3	AMN	ETS	3810/2	00020199	2020.10.15
4	AAN	TESEQ	T8-Cat6	38888	2020.10.15
5	Pulse Limiter	CYBRTEK	EM5010	E115010056	2020.05.26
6	EMI Test Receiver	Rohde&Schwarz	ESCI	101210	2020.10.15
Radiated Emissions Measurement					
1	Radiated Emission Test Software	EZ-EMC	Ver.CCS-03A1	N/A	N/A
2	Horn Antenna	Sunol	DRH-118	A101415	2020.10.18
3	Broadband Hybrid Antenna	Sunol	JB1	A090215	2020.11.15
4	PREAMP	HP	8449B	3008A00160	2020.10.21
5	PREAMP	HP	8447D	2944A07999	2020.05.26
6	EMI Test Receiver	Rohde&Schwarz	ESR3	101891	2020.10.15
7	MXA Signal Analyzer	Keysight	N9020A	MY51110104	2020.10.15
8	Active Loop Antenna	Com-Power	AL-310R	10160009	2020.05.28
9	Horn Antenna	Schwarzbeck	BBHA9120D	9120D-1680	2020.05.28
10	Horn Antenna	A-INFOMW	LB-180400-KF	J211060660	2020.10.23
11	Loop Antenna	Beijing daze Technology	ZN30401	13015	2020.10.15
12	EM Clamp	Schwarzbeck	MDS21	03350	2020.10.20

3. CONDUCTED EMISSIONS TEST

3.1 Conducted Power Line Emission Limit

For unintentional device, according to § 15.107(a) Line Conducted Emission Limits is as following

Frequency (MHz)	Maximum RF Line Voltage(dBμV)			
	CLASS A		CLASS B	
	Q.P.	Ave.	Q.P.	Ave.
0.15~0.50	79	66	66~56*	56~46*
0.50~5.00	73	60	56	46
5.00~30.0	73	60	60	50

* Decreasing linearly with the logarithm of the frequency

For intentional device, according to §15.207(a) Line Conducted Emission Limit is same as above table.

3.2 Test Setup

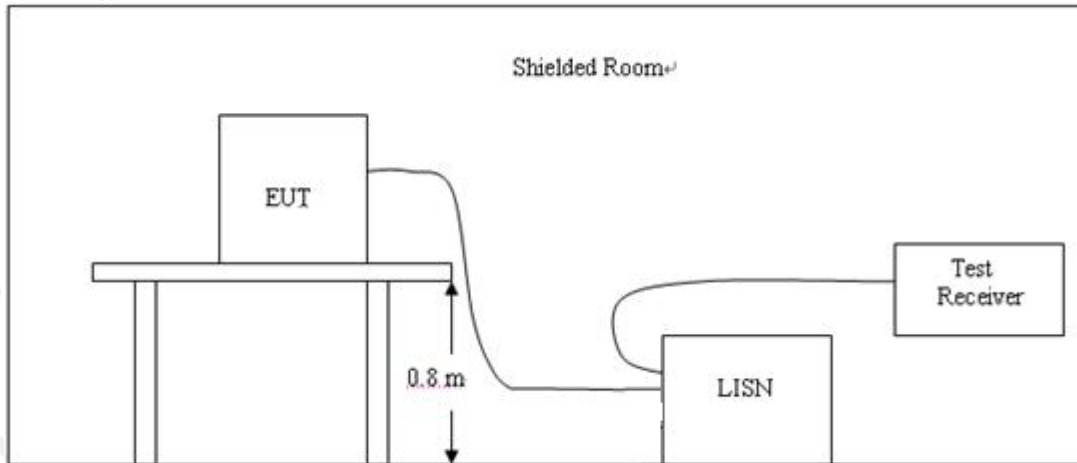

3.3 Test Procedure

- 1, The equipment was set up as per the test configuration to simulate typical actual usage per the user's manual. The EUT is a tabletop system, a wooden table with a height of 0.8 meters is used and is placed on the ground plane as per ANSI C63.10.
- 2, Support equipment, if needed, was placed as per ANSI C63.10.
- 3, All I/O cables were positioned to simulate typical actual usage as per ANSI C63.10.
- 4, If a EUT received DC power from the USB Port of Notebook PC, the PC's adapter received AC120V/60Hz power through a Line Impedance Stabilization Network (LISN) which supplied power source and was grounded to the ground plane.
- 5, All support equipments received AC power from a second LISN, if any.
- 6, The EUT test program was started. Emissions were measured on each current carrying line of the EUT using a spectrum Analyzer / Receiver connected to the LISN powering the EUT. The LISN has two monitoring points: Line 1 (Hot Side) and Line 2 (Neutral Side). Two scans were taken: one with Line 1 connected to Analyzer / Receiver and Line 2 connected to a 50 ohm load; the second scan had Line 1 connected to a 50 ohm load and Line 2 connected to the Analyzer / Receiver.
- 7, Analyzer / Receiver scanned from 150 KHz to 30MHz for emissions in each of the test modes.

3.4 Test Result

Pass

Remark:

1. All modes were tested at AC 120V and 240V, only the worst result of AC 120V was reported.
2. All modes of Low, Middle, and High channel were tested, only the worst result of High Channel was reported as below:

Temperature:	24°C	Relative Humidity:	45%
Test Date:	Mar. 10, 2020	Pressure:	1010hPa
Test Voltage:	AC 120V, 60Hz	Phase:	Line
Test Mode:	Transmitting mode of GFSK 2480MHz		

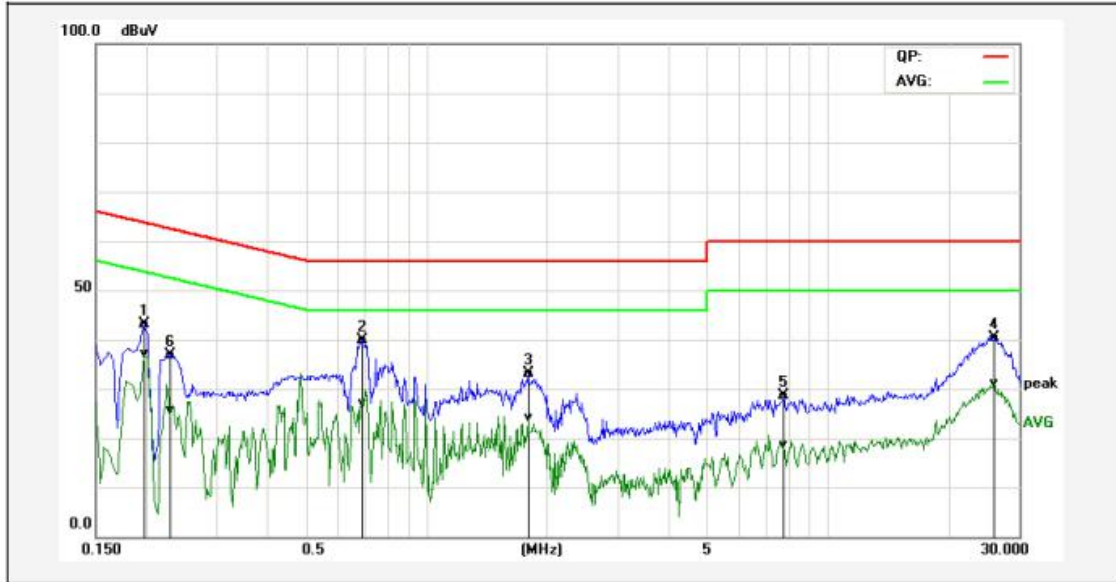

No.	Frequency (MHz)	QuasiPeak reading (dBuV)	Average reading (dBuV)	Correction factor (dB)	QuasiPeak result (dBuV)	Average result (dBuV)	QuasiPeak limit (dBuV)	Average limit (dBuV)	QuasiPeak margin (dB)	Average margin (dB)	Remark
1P	0.1980	43.18	37.18	0.05	43.23	37.23	63.69	53.69	-20.46	-16.46	Pass
2*	0.6900	39.93	27.19	0.05	39.98	27.24	56.00	46.00	-16.02	-18.76	Pass
3P	1.7940	32.94	24.15	0.07	33.01	24.22	56.00	46.00	-22.99	-21.78	Pass
4P	25.8860	39.81	30.55	0.68	40.49	31.23	60.00	50.00	-19.51	-18.77	Pass
5P	7.7740	28.57	18.54	0.09	28.66	18.63	60.00	50.00	-31.34	-31.37	Pass
6P	0.2316	36.72	25.66	0.05	36.77	25.71	62.39	52.39	-25.62	-26.68	Pass

Remark: Factor = Insertion Loss + Cable Loss, Result=Reading + Factor, Margin=Result – Limit.

Temperature:	24°C	Relative Humidity:	45%
Test Date:	Mar. 10, 2020	Pressure:	1010hPa
Test Voltage:	AC 120V, 60Hz	Phase:	Neutral
Test Mode:	Transmitting mode of GFSK 2480MHz		

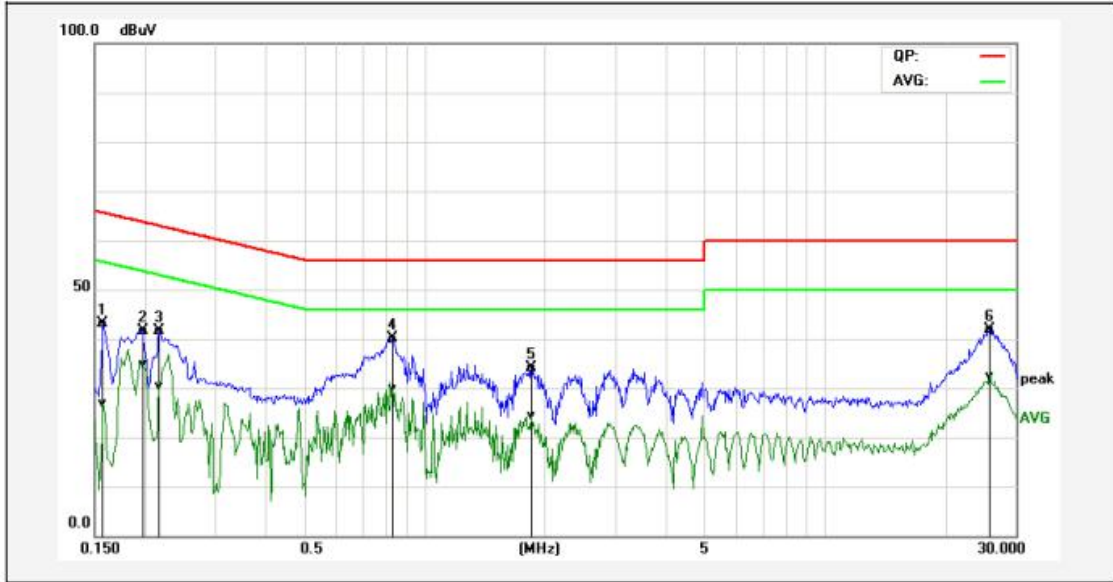

No.	Frequency (MHz)	QuasiPeak reading (dBuV)	Average reading (dBuV)	Correction factor (dB)	QuasiPeak result (dBuV)	Average result (dBuV)	QuasiPeak limit (dBuV)	Average limit (dBuV)	QuasiPeak margin (dB)	Average margin (dB)	Remark
1P	0.1580	43.11	26.78	0.05	43.16	26.83	65.56	55.57	-22.40	-28.74	Pass
2P	0.1980	41.70	34.71	0.05	41.75	34.76	63.69	53.69	-21.94	-18.93	Pass
3P	0.2180	41.70	30.45	0.05	41.75	30.50	62.89	52.89	-21.14	-22.39	Pass
4*	0.8340	39.95	29.85	0.05	40.00	29.90	56.00	46.00	-16.00	-16.10	Pass
5P	1.8500	33.94	24.22	0.07	34.01	24.29	56.00	46.00	-21.99	-21.71	Pass
6P	25.7500	41.22	31.72	0.68	41.90	32.40	60.00	50.00	-18.10	-17.60	Pass

Remark: Factor = Insertion Loss + Cable Loss, Result=Reading + Factor, Margin=Result – Limit.

4 RADIATED EMISSION TEST

4.1 Radiation Limit

For unintentional device, according to § 15.109(a), except for Class A digital devices, the field strength of radiated emissions from unintentional radiators at a distance of 3 meters shall not exceed the following values:

Limit calculation and transfer to 3m distance as showed in the following table:

Frequency (MHz)	Limit (dBuV/m)	Distance (m)
0.009-0.490	$20\log(2400/F(\text{KHz})) + 40\log(300/3)$	3
0.490-1.705	$20\log(24000/F(\text{KHz})) + 40\log(30/3)$	3
1.705-30.0	69.5	3
30-88	40.0	3
88-216	43.5	3
216-960	46.0	3
Above 960	54.0	3

For intentional device, according to § 15.209(a), the general requirement of field strength of radiated emissions from intentional radiators at a distance of 3 meters shall not exceed the above table.

4.2 Test Setup

1. Radiated Emission Test-Up Frequency Below 30MHz

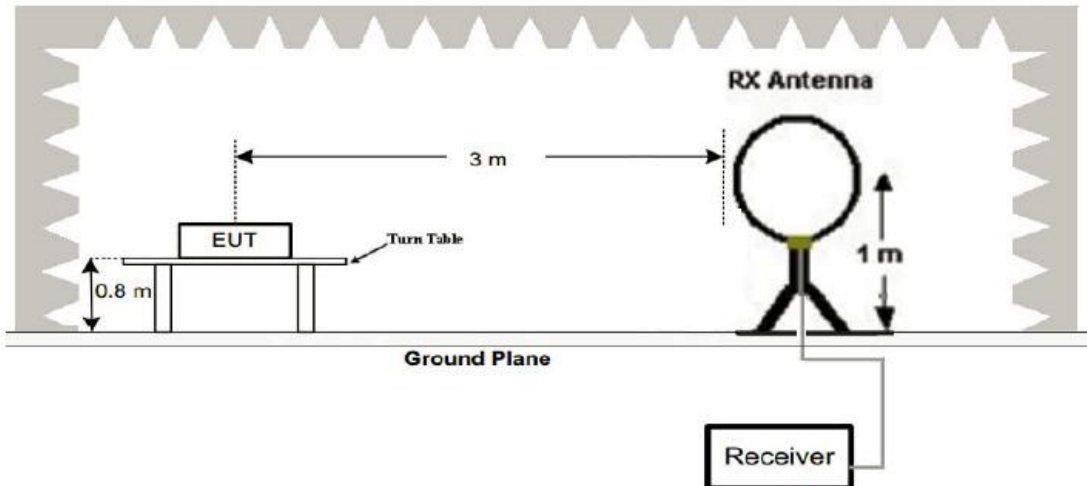

2. Radiated Emission Test-Up Frequency 30MHz~1GHz

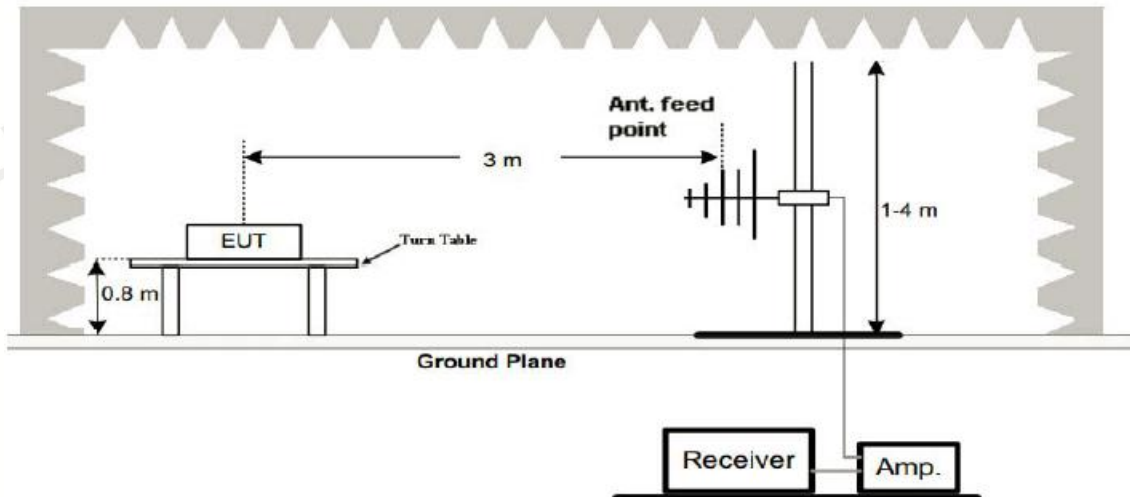

3. Radiated Emission Test-Up Frequency Above 1GHz

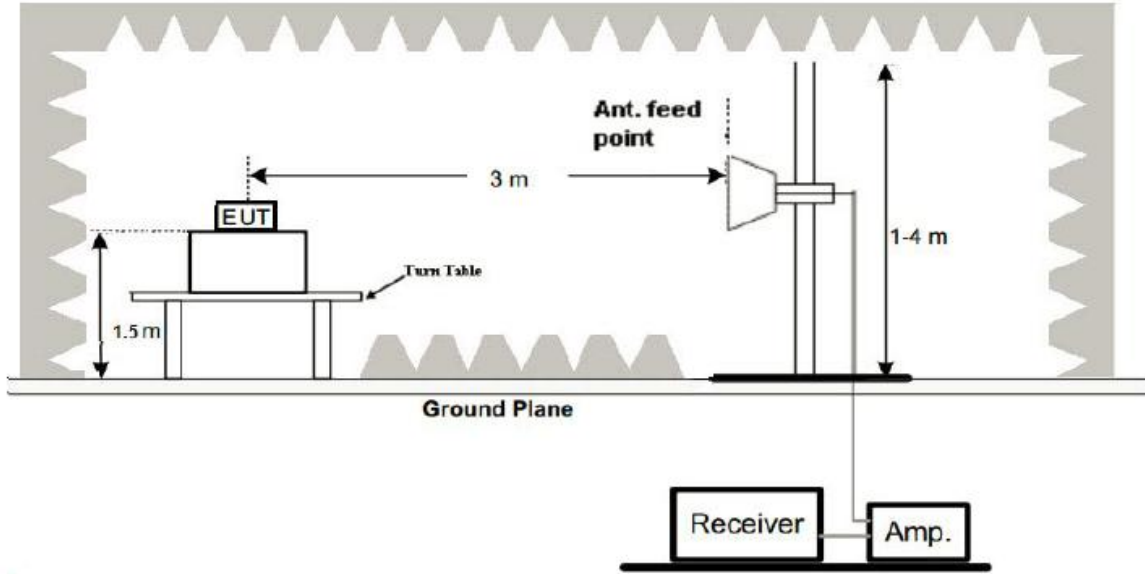

4.3 Test Procedure

1. Below 1GHz measurement the EUT is placed on turntable which is 0.8m above ground plane. And above 1GHz measurement EUT was placed on low permittivity and low tangent turn table which is 1.5m above ground plane.
2. The turntable shall be rotated for 360 degrees to determine the position of maximum emission level.
3. EUT is set 3m away from the receiving antenna, which is varied from 1m to 4m to find out the highest emissions.
4. Maximum procedure was performed on the six highest emissions to ensure EUT compliance.
5. And also, each emission was to be maximized by changing the polarization of receiving antenna both horizontal and vertical.
6. Repeat above procedures until the measurements for all frequencies are complete.
7. The test frequency range from 9KHz to 25GHz per FCC PART 15.33(a).

Note:

For battery operated equipment, the equipment tests shall be performed using a new battery.

4.4 Test Result

PASS

Remark:

1. All the test modes completed for test. The worst case of Radiated Emission is High channel, the test data of this mode was reported.
2. By preliminary testing and verifying three axis (X, Y and Z) position of EUT transmitted status, it was found that "Z axis" position was the worst, and test data recorded in this report.
3. Radiated emission test from 9KHz to 10th harmonic of fundamental was verified, and no emission found except system noise floor in 9KHz to 30MHz and not recorded in this report.

Below 1GHz Test Results:

Temperature:	24°C	Relative Humidity:	45%
Test Date:	Mar. 10, 2020	Pressure:	1010hPa
Test Voltage:	AC 120V, 60Hz	Polarization:	Horizontal
Test Mode:	Transmitting mode of GFSK 2480MHz		

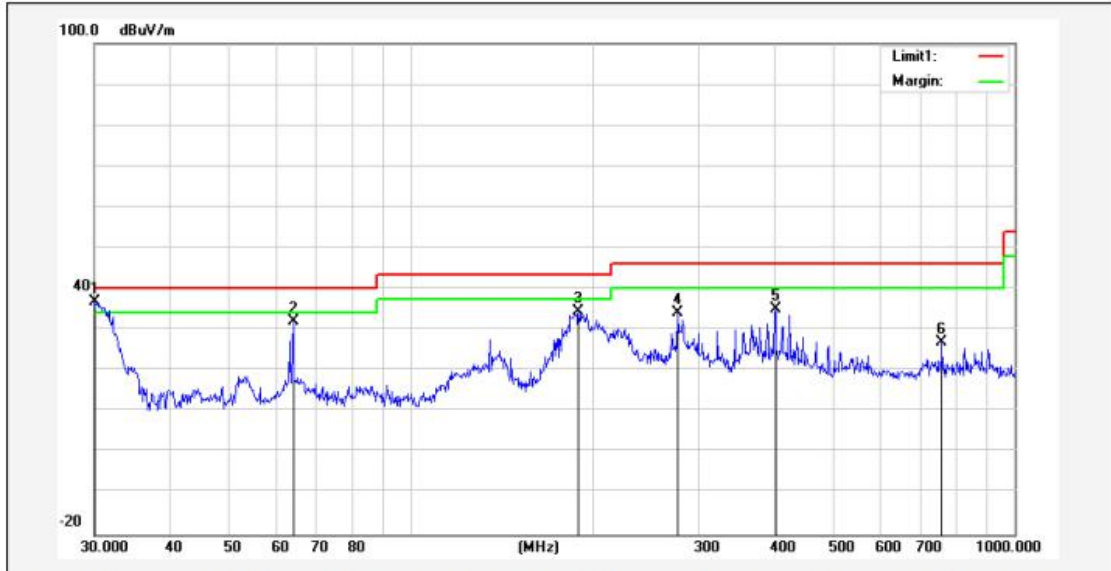

No.	Frequency (MHz)	Reading (dBuV)	Correction factor(dB/m)	Result (dBuV/m)	Limit (dBuV/m)	Margin (dB)	Degree (deg.)	Height (cm)	Remark
1*	30.1053	43.99	-7.23	36.76	40.00	-3.24	120	100	peak
2	63.9827	53.63	-21.55	32.08	40.00	-7.92	240	100	peak
3	189.7384	52.46	-18.03	34.43	43.50	-9.07	90	100	peak
4	277.0935	49.39	-15.27	34.12	46.00	-11.88	210	100	peak
5	401.8385	47.91	-12.84	35.07	46.00	-10.93	120	100	peak
6	758.0407	35.43	-8.36	27.07	46.00	-18.93	330	100	peak

Remark: Absolute Level= Reading Level+ Factor, Margin= Absolute Level – Limit
 Factor=Ant. Factor + Cable Loss – Pre-amplifier

Temperature:	24°C	Relative Humidity:	45%
Test Date:	Mar. 10, 2020	Pressure:	1010hPa
Test Voltage:	AC 120V, 60Hz	Polarization:	Vertical
Test Mode:	Transmitting mode of GFSK 2480MHz		

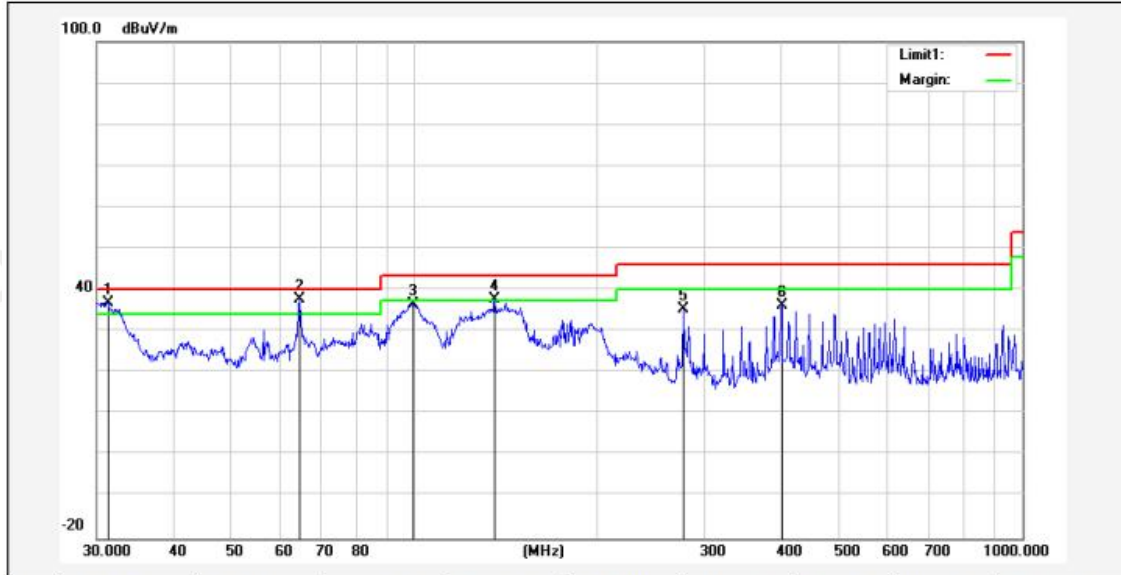

No.	Frequency (MHz)	Reading (dBuV)	Correction factor(dB/m)	Result (dBuV/m)	Limit (dBuV/m)	Margin (dB)	Degree (deg.)	Height (cm)	Remark
1!	31.2893	45.12	-8.16	36.96	40.00	-3.04	300	100	peak
2*	64.6594	59.26	-21.52	37.74	40.00	-2.26	330	100	peak
3	99.5280	55.65	-19.20	36.45	43.50	-7.05	240	100	peak
4!	135.5062	54.15	-16.41	37.74	43.50	-5.76	90	100	peak
5	277.0935	50.49	-15.27	35.22	46.00	-10.78	150	100	peak
6	401.8385	49.00	-12.84	36.16	46.00	-9.84	60	100	peak

Remark: Absolute Level= Reading Level+ Factor, Margin= Absolute Level – Limit
 Factor=Ant. Factor + Cable Loss – Pre-amplifier

Remark:

- (1) Measuring frequencies from 9 KHz to the 1 GHz, Radiated emission test from 9KHz to 30MHz was verified, and no any emission was found except system noise floor.
- (2) * denotes emission frequency which appearing within the Restricted Bands specified in provision of 15.205, then the general radiated emission limits in 15.209 apply.
- (3) The IF bandwidth of EMI Test Receiver between 30MHz to 1GHz was 120KHz, 1 MHz for measuring above 1 GHz, below 30MHz was 10KHz.

Above 1 GHz Test Results:
CH Low (2402MHz)

GFSK
Horizontal:

Frequency (MHz)	Reading Result (dBμV)	Factor (dB)	Emission Level (dBμV/m)	Limits (dBμV/m)	Margin (dB)	Detector Type
2402	108.45	-5.84	102.61	114	-11.39	PK
2402	79.81	-5.84	73.97	94	-20.03	AV
4804	62.31	-3.64	58.67	74	-15.33	PK
4804	49.28	-3.64	45.64	54	-8.36	AV
7206	56.37	-0.95	55.42	74	-18.58	PK
7206	46.58	-0.95	45.63	54	-8.37	AV

Remark: Factor = Antenna Factor + Cable Loss – Pre-amplifier. Margin= Absolute Level – Limit

Vertical:

Frequency (MHz)	Reading Result (dBμV)	Factor (dB)	Emission Level (dBμV/m)	Limits (dBμV/m)	Margin (dB)	Detector Type
2402	108.42	-5.84	102.58	114	-11.42	PK
2402	78.65	-5.84	72.81	94	-21.19	AV
4804	62.34	-3.64	58.70	74	-15.30	PK
4804	49.21	-3.64	45.57	54	-8.43	AV
7206	56.87	-0.95	55.92	74	-18.08	PK
7206	47.03	-0.95	46.08	54	-7.92	AV

Remark: Factor = Antenna Factor + Cable Loss – Pre-amplifier. Margin= Absolute Level – Limit

CH Middle (2441MHz)

Horizontal:

Frequency (MHz)	Reading Result (dBμV)	Factor (dB)	Emission Level (dBμV/m)	Limits (dBμV/m)	Margin (dB)	Detector Type
2441	107.92	-5.71	102.21	114	-11.79	PK
2441	80.04	-5.71	74.33	94	-19.67	AV
4882	61.59	-3.51	58.08	74	-15.92	PK
4882	47.82	-3.51	44.31	54	-9.69	AV
7323	56.31	-0.82	55.49	74	-18.51	PK
7323	45.79	-0.82	44.97	54	-9.03	AV

Remark: Factor = Antenna Factor + Cable Loss – Pre-amplifier. Margin = Absolute Level – Limit

Vertical:

Frequency (MHz)	Reading Result (dBμV)	Factor (dB)	Emission Level (dBμV/m)	Limits (dBμV/m)	Margin (dB)	Detector Type
2441	107.42	-5.71	101.71	114	-12.29	PK
2441	79.31	-5.71	73.60	94	-20.40	AV
4882	62.15	-3.51	58.64	74	-15.36	PK
4882	48.36	-3.51	44.85	54	-9.15	AV
7323	56.27	-0.82	55.45	74	-18.55	PK
7323	46.29	-0.82	45.47	54	-8.53	AV

Remark: Factor = Antenna Factor + Cable Loss – Pre-amplifier. Margin= Absolute Level – Limit

CH High (2480MHz)
Horizontal:

Frequency (MHz)	Reading Result (dBμV)	Factor (dB)	Emission Level (dBμV/m)	Limits (dBμV/m)	Margin (dB)	Detector Type
2480	108.21	-5.65	102.56	114	-11.44	PK
2480	80.31	-5.65	74.66	94	-19.34	AV
4960	61.24	-3.43	57.81	74	-16.19	PK
4960	48.31	-3.43	44.88	54	-9.12	AV
7440	57.16	-0.75	56.41	74	-17.59	PK
7440	46.31	-0.75	45.56	54	-8.44	AV

Remark: Factor = Antenna Factor + Cable Loss – Pre-amplifier. Margin= Absolute Level – Limit

Vertical:

Frequency (MHz)	Reading Result (dBμV)	Factor (dB)	Emission Level (dBμV/m)	Limits (dBμV/m)	Margin (dB)	Detector Type
2480	108.16	-5.65	102.51	114	-11.49	PK
2480	80.32	-5.65	74.67	94	-19.33	AV
4960	61.27	-3.43	57.84	74	-16.16	PK
4960	48.35	-3.43	44.92	54	-9.08	AV
7440	57.21	-0.75	56.46	74	-17.54	PK
7440	47.39	-0.75	46.64	54	-7.36	AV

Remark: Factor = Antenna Factor + Cable Loss – Pre-amplifier. Margin= Absolute Level – Limit

Remark:

- (1) Measuring frequencies from 1 GHz to the 25 GHz.
- (2) "F" denotes fundamental frequency; "H" denotes spurious frequency. "E" denotes band edge frequency.
- (3) * denotes emission frequency which appearing within the Restricted Bands specified in provision of 15.205, then the general radiated emission limits in 15.209 apply.
- (4) Data of measurement within this frequency range ,that the value more than 20dB below limit is not record in the form.
- (5) The IF bandwidth of EMI Test Receiver between 30MHz to 1GHz was 120KHz, 1 MHz for measuring above 1 GHz, below 30MHz was 10KHz.The resolution bandwidth of test receiver/spectrum analyzer is 1MHzand video bandwidth is 3MHz for peak measurement with peak detectorat frequency above 1GHz.The resolution bandwidth of test receiver/spectrum analyzer is 1MHzand video bandwidth is 10Hz for Average measurement with peak detection at frequency above 1GHz.
- (6) When the test results of Peak Detected below the limits of Average Detected, the Average Detected is not need completed. For example: Top Channel at Fundamental 73.16dBuV/m(PK Value) <93.98(AV Limit), at harmonic 53.20 dBuV/m(PK Value) <54 dBuV/m(AV Limit), the Average Detected not need to completed.
- (7)All modes of operation were investigated and the worst-case emissionsare reported.

$\pi/4$ DQPSK

Horizontal:

Frequency (MHz)	Reading Result (dB μ V)	Factor (dB)	Emission Level (dB μ V/m)	Limits (dB μ V/m)	Margin (dB)	Detector Type
2402	108.02	-5.84	102.18	114	-11.82	PK
2402	80.42	-5.84	74.58	94	-19.42	AV
4804	62.17	-3.64	58.53	74	-15.47	PK
4804	48.36	-3.64	44.72	54	-9.28	AV
7206	56.37	-0.95	55.42	74	-18.58	PK
7206	47.08	-0.95	46.13	54	-7.87	AV

Remark: Factor = Antenna Factor + Cable Loss – Pre-amplifier. Margin= Absolute Level – Limit

Vertical:

Frequency (MHz)	Reading Result (dB μ V)	Factor (dB)	Emission Level (dB μ V/m)	Limits (dB μ V/m)	Margin (dB)	Detector Type
2402	107.34	-5.84	101.50	114	-12.50	PK
2402	79.28	-5.84	73.44	94	-20.56	AV
4804	61.34	-3.64	57.70	74	-16.30	PK
4804	47.26	-3.64	43.62	54	-10.38	AV
7206	56.51	-0.95	55.56	74	-18.44	PK
7206	46.89	-0.95	45.94	54	-8.06	AV

Remark: Factor = Antenna Factor + Cable Loss – Pre-amplifier. Margin= Absolute Level – Limit

CH Middle (2441MHz)

Horizontal:

Frequency (MHz)	Reading Result (dBμV)	Factor (dB)	Emission Level (dBμV/m)	Limits (dBμV/m)	Margin (dB)	Detector Type
2441	107.85	-5.71	102.14	114	-11.86	PK
2441	80.26	-5.71	74.55	94	-19.45	AV
4882	62.04	-3.51	58.53	74	-15.47	PK
4882	47.61	-3.51	44.10	54	-9.90	AV
7323	56.41	-0.82	55.59	74	-18.41	PK
7323	47.26	-0.82	46.44	54	-7.56	AV

Remark: Factor = Antenna Factor + Cable Loss – Pre-amplifier. Margin = Absolute Level – Limit

Vertical:

Frequency (MHz)	Reading Result (dBμV)	Factor (dB)	Emission Level (dBμV/m)	Limits (dBμV/m)	Margin (dB)	Detector Type
2441	108.46	-5.71	102.75	114	-11.25	PK
2441	80.21	-5.71	74.50	94	-19.50	AV
4882	61.29	-3.51	57.78	74	-16.22	PK
4882	50.34	-3.51	46.83	54	-7.17	AV
7323	56.29	-0.82	55.47	74	-18.53	PK
7323	47.62	-0.82	46.80	54	-7.20	AV

Remark: Factor = Antenna Factor + Cable Loss – Pre-amplifier. Margin= Absolute Level – Limit

CH High (2480MHz)
Horizontal:

Frequency (MHz)	Reading Result (dBμV)	Factor (dB)	Emission Level (dBμV/m)	Limits (dBμV/m)	Margin (dB)	Detector Type
2480	107.46	-5.65	101.81	114	-12.19	PK
2480	80.31	-5.65	74.66	94	-19.34	AV
4960	61.25	-3.43	57.82	74	-16.18	PK
4960	49.51	-3.43	46.08	54	-7.92	AV
7440	57.62	-0.75	56.87	74	-17.13	PK
7440	47.36	-0.75	46.61	54	-7.39	AV

Remark: Factor = Antenna Factor + Cable Loss – Pre-amplifier. Margin= Absolute Level – Limit

Vertical:

Frequency (MHz)	Reading Result (dBμV)	Factor (dB)	Emission Level (dBμV/m)	Limits (dBμV/m)	Margin (dB)	Detector Type
2480	107.51	-5.65	101.86	114	-12.14	PK
2480	79.61	-5.65	73.96	94	-20.04	AV
4960	62.01	-3.43	58.58	74	-15.42	PK
4960	48.67	-3.43	45.24	54	-8.76	AV
7440	56.81	-0.75	56.06	74	-17.94	PK
7440	47.03	-0.75	46.28	54	-7.72	AV

Remark: Factor = Antenna Factor + Cable Loss – Pre-amplifier. Margin= Absolute Level – Limit

Remark:

- (1) Measuring frequencies from 1 GHz to the 25 GHz.
- (2) "F" denotes fundamental frequency; "H" denotes spurious frequency. "E" denotes band edge frequency.
- (3) * denotes emission frequency which appearing within the Restricted Bands specified in provision of 15.205, then the general radiated emission limits in 15.209 apply.
- (4) Data of measurement within this frequency range ,that the value more than 20dB below limit is not record in the form.
- (5) The IF bandwidth of EMI Test Receiver between 30MHz to 1GHz was 120KHz, 1 MHz for measuring above 1 GHz, below 30MHz was 10KHz. The resolution bandwidth of test receiver/spectrum analyzer is 1MHz and video bandwidth is 3MHz for peak measurement with peak detector at frequency above 1GHz. The resolution bandwidth of test receiver/spectrum analyzer is 1MHz and video bandwidth is 10Hz for Average measurement with peak detection at frequency above 1GHz.
- (6) When the test results of Peak Detected below the limits of Average Detected, the Average Detected is not need completed. For example: Top Channel at Fundamental 73.16dBuV/m(PK Value) <93.98(AV Limit), at harmonic 53.20 dBuV/m(PK Value) <54 dBuV/m(AV Limit), the Average Detected not need to completed.
- (7) All modes of operation were investigated and the worst-case emissions are reported.

8DPSK
Horizontal:

Frequency	Reading Result	Factor	Emission Level	Limits	Margin	Detector
(MHz)	(dBμV)	(dB)	(dBμV/m)	(dBμV/m)	(dB)	Type
2402	108.42	-5.84	102.58	114	-11.42	PK
2402	79.34	-5.84	73.5	94	-20.5	AV
4804	61.25	-3.64	57.61	74	-16.39	PK
4804	49.35	-3.64	45.71	54	-8.29	AV
7206	56.72	-0.95	55.77	74	-18.23	PK
7206	47.16	-0.95	46.21	54	-7.79	AV

Remark: Factor = Antenna Factor + Cable Loss – Pre-amplifier. Margin= Absolute Level – Limit

Vertical:

Frequency	Reading Result	Factor	Emission Level	Limits	Margin	Detector
(MHz)	(dBμV)	(dB)	(dBμV/m)	(dBμV/m)	(dB)	Type
2402	107.95	-5.84	102.11	114	-11.89	PK
2402	79.51	-5.84	73.67	94	-20.33	AV
4804	61.4	-3.64	57.76	74	-16.24	PK
4804	48.86	-3.64	45.22	54	-8.78	AV
7206	56.37	-0.95	55.42	74	-18.58	PK
7206	46.29	-0.95	45.34	54	-8.66	AV

Remark: Factor = Antenna Factor + Cable Loss – Pre-amplifier. Margin= Absolute Level – Limit

CH Middle (2441MHz)

Horizontal:

Frequency (MHz)	Reading Result (dBμV)	Factor (dB)	Emission Level (dBμV/m)	Limits (dBμV/m)	Margin (dB)	Detector Type
2441	108.24	-5.71	102.53	114	-11.47	PK
2441	81.23	-5.71	75.52	94	-18.48	AV
4882	61.34	-3.51	57.83	74	-16.17	PK
4882	48.09	-3.51	44.58	54	-9.42	AV
7323	57.03	-0.82	56.21	74	-17.79	PK
7323	47.18	-0.82	46.36	54	-7.64	AV

Remark: Factor = Antenna Factor + Cable Loss – Pre-amplifier. Margin = Absolute Level – Limit

Vertical:

Frequency (MHz)	Reading Result (dBμV)	Factor (dB)	Emission Level (dBμV/m)	Limits (dBμV/m)	Margin (dB)	Detector Type
2441	108.63	-5.71	102.92	114	-11.08	PK
2441	80.26	-5.71	74.55	94	-19.45	AV
4882	61.24	-3.51	57.73	74	-16.27	PK
4882	47.82	-3.51	44.31	54	-9.69	AV
7323	57.36	-0.82	56.54	74	-17.46	PK
7323	47.29	-0.82	46.47	54	-7.53	AV

Remark: Factor = Antenna Factor + Cable Loss – Pre-amplifier. Margin= Absolute Level – Limit

CH High (2480MHz)
Horizontal:

Frequency (MHz)	Reading Result (dBμV)	Factor (dB)	Emission Level (dBμV/m)	Limits (dBμV/m)	Margin (dB)	Detector Type
2480	107.62	-5.65	101.97	114	-12.03	PK
2480	81.34	-5.65	75.69	94	-18.31	AV
4960	62.01	-3.43	58.58	74	-15.42	PK
4960	48.61	-3.43	45.18	54	-8.82	AV
7440	57.69	-0.75	56.94	74	-17.06	PK
7440	48.24	-0.75	47.49	54	-6.51	AV

Remark: Factor = Antenna Factor + Cable Loss – Pre-amplifier. Margin= Absolute Level – Limit

Vertical:

Frequency (MHz)	Reading Result (dBμV)	Factor (dB)	Emission Level (dBμV/m)	Limits (dBμV/m)	Margin (dB)	Detector Type
2480	107.46	-5.65	101.81	114	-12.19	PK
2480	80.31	-5.65	74.66	94	-19.34	AV
4960	61.29	-3.43	57.86	74	-16.14	PK
4960	47.34	-3.43	43.91	54	-10.09	AV
7440	57.64	-0.75	56.89	74	-17.11	PK
7440	47.39	-0.75	46.64	54	-7.36	AV

Remark: Factor = Antenna Factor + Cable Loss – Pre-amplifier. Margin= Absolute Level – Limit

Remark:

- (1) Measuring frequencies from 1 GHz to the 25 GHz.
- (2) “F” denotes fundamental frequency; “H” denotes spurious frequency. “E” denotes band edge frequency.
- (3) * denotes emission frequency which appearing within the Restricted Bands specified in provision of 15.205, then the general radiated emission limits in 15.209 apply.
- (4) Data of measurement within this frequency range ,that the value more than 20dB below limit is not record in the form.
- (5) The IF bandwidth of EMI Test Receiver between 30MHz to 1GHz was 120KHz, 1 MHz for measuring above 1 GHz, below 30MHz was 10KHz. The resolution bandwidth of test receiver/spectrum analyzer is 1MHz and video bandwidth is 3MHz for peak measurement with peak detector at frequency above 1GHz. The resolution bandwidth of test receiver/spectrum analyzer is 1MHz and video bandwidth is 10Hz for Average measurement with peak detection at frequency above 1GHz.
- (6) When the test results of Peak Detected below the limits of Average Detected, the Average Detected is not need completed. For example: Top Channel at Fundamental 73.16dBuV/m(PK Value) <93.98(AV Limit), at harmonic 53.20 dBuV/m(PK Value) <54 dBuV/m(AV Limit), the Average Detected not need to completed.
- (7) All modes of operation were investigated and the worst-case emissions are reported.

5 BAND EDGE

5.1 Limits

FCC PART 15.249(d) Emissions radiated outside of the specified frequency bands, except for harmonics, shall be attenuated by at least 50 dB below the level of the fundamental or to the general radiated emission limits in §15.209, whichever is the lesser attenuation.

5.2 Test Procedure

The band edge compliance of RF radiated emission should be measured by following the guidance in ANSIC63.10 with respect to maximizing the emission by rotating the EUT, measuring the emission while the EUT is situated in three orthogonal planes (if appropriate), adjusting the measurement antenna height and polarization etc. Set RBW to 100KHz and VBM to 300KHz to measure the peak field strength and set RBW to 1MHz and VBW to 10Hz to measure the average radiated field strength. The conducted RF band edge was measured by using a spectrum analyzer. Set span wide enough to capture the highest in-band emission and the emission at the band edge. Set RBW to 100 KHz and VBW to 300 KHz, to measure the conducted peak band edge.

5.3 Test Result

PASS

Radiated Band Edge Test:

GFSK Operation Mode: TX CH Low (2402MHz)

Horizontal:

Frequency (MHz)	Reading Result (dBμV)	Factor (dB)	Emission Level (dBμV/m)	Limits (dBμV/m)	Margin (dB)	Detector Type
2310	55.31	-5.81	49.5	74	-24.50	PK
2310	/	-5.81	/	54	/	AV
2390	56.29	-5.84	50.45	74	-23.55	PK
2390	/	-5.84	/	54	/	AV
2400	57.61	-5.84	51.77	74	-22.23	PK
2400	/	-5.84	/	54	/	AV

Remark: Factor = Antenna Factor + Cable Loss – Pre-amplifier.

Vertical:

Frequency (MHz)	Reading Result (dBμV)	Factor (dB)	Emission Level (dBμV/m)	Limits (dBμV/m)	Margin (dB)	Detector Type
2310	54.37	-5.81	48.56	74	-25.44	PK
2310	/	-5.81	/	54	/	AV
2390	56.49	-5.84	50.65	74	-23.35	PK
2390	/	-5.84	/	54	/	AV
2400	57.69	-5.84	51.85	74	-22.15	PK
2400	/	-5.84	/	54	/	AV

Remark: Factor = Antenna Factor + Cable Loss – Pre-amplifier.

GFSK Operation Mode: TX CH High (2480MHz)

Horizontal:

Frequency	Reading Result	Factor	Emission Level	Limits	Margin	Detector Type
(MHz)	(dB μ V)	(dB)	(dB μ V/m)	(dB μ V/m)	(dB)	
2483.5	57.13	-5.65	51.48	74	-22.52	PK
2483.5	/	-5.65	/	54	/	AV
2500	56.06	-5.72	50.34	74	-23.66	PK
2500	/	-5.72	/	54	/	AV

Remark: Factor = Antenna Factor + Cable Loss – Pre-amplifier.

Vertical:

Frequency	Reading Result	Factor	Emission Level	Limits	Margin	Detector Type
(MHz)	(dB μ V)	(dB)	(dB μ V/m)	(dB μ V/m)	(dB)	
2483.5	57.31	-5.65	51.66	74	-22.34	PK
2483.5	/	-5.65	/	54	/	AV
2500	55.46	-5.72	49.74	74	-24.26	PK
2500	/	-5.72	/	54	/	AV

Remark: Factor = Antenna Factor + Cable Loss – Pre-amplifier.

π /4 DQPSK Operation Mode: TX CH High (2402MHz)

Horizontal:

Frequency	Reading Result	Factor	Emission Level	Limits	Margin	Detector Type
(MHz)	(dBμV)	(dB)	(dBμV/m)	(dBμV/m)	(dB)	
2310	54.21	-5.81	48.40	74	-25.60	PK
2310	/	-5.81	/	54	/	AV
2390	55.68	-5.84	49.84	74	-24.16	PK
2390	/	-5.84	/	54	/	AV
2400	57.26	-5.84	51.42	74	-22.58	PK
2400	/	-5.84	/	54	/	AV

Remark: Factor = Antenna Factor + Cable Loss – Pre-amplifier.

Vertical:

Frequency	Reading Result	Factor	Emission Level	Limits	Margin	Detector Type
(MHz)	(dBμV)	(dB)	(dBμV/m)	(dBμV/m)	(dB)	
2310	54.87	-5.81	49.06	74	-24.94	PK
2310	/	-5.81	/	54	/	AV
2390	55.91	-5.84	50.07	74	-23.93	PK
2390	/	-5.84	/	54	/	AV
2400	57.37	-5.84	51.53	74	-22.47	PK
2400	/	-5.84	/	54	/	AV

Remark: Factor = Antenna Factor + Cable Loss – Pre-amplifier.

π /4 DQPSK Operation Mode: TX CH High (2480MHz)

Horizontal:

Frequency	Reading Result	Factor	Emission Level	Limits	Margin	Detector Type
(MHz)	(dB μ V)	(dB)	(dB μ V/m)	(dB μ V/m)	(dB)	
2483.5	57.64	-5.65	51.99	74	-22.01	PK
2483.5	/	-5.65	/	54	/	AV
2500	54.31	-5.72	48.59	74	-25.41	PK
2500	/	-5.72	/	54	/	AV

Remark: Factor = Antenna Factor + Cable Loss – Pre-amplifier.

Vertical:

Frequency	Reading Result	Factor	Emission Level	Limits	Margin	Detector Type
(MHz)	(dB μ V)	(dB)	(dB μ V/m)	(dB μ V/m)	(dB)	
2483.5	58.02	-5.65	52.37	74	-21.63	PK
2483.5	/	-5.65	/	54	/	AV
2500	55.06	-5.72	49.34	74	-24.66	PK
2500	/	-5.72	/	54	/	AV

Remark: Factor = Antenna Factor + Cable Loss – Pre-amplifier.

8DPSK Operation Mode: TX CH High (2402MHz)

Horizontal:

Frequency (MHz)	Reading Result (dBμV)	Factor (dB)	Emission Level (dBμV/m)	Limits (dBμV/m)	Margin (dB)	Detector Type
2310	55.24	-5.81	49.43	74	-24.57	PK
2310	/	-5.81	/	54	/	AV
2390	56.39	-5.84	50.55	74	-23.45	PK
2390	/	-5.84	/	54	/	AV
2400	57.41	-5.84	51.57	74	-22.43	PK
2400	/	-5.84	/	54	/	AV

Remark: Factor = Antenna Factor + Cable Loss – Pre-amplifier.

Vertical:

Frequency (MHz)	Reading Result (dBμV)	Factor (dB)	Emission Level (dBμV/m)	Limits (dBμV/m)	Margin (dB)	Detector Type
2310	54.36	-5.81	48.55	74	-25.45	PK
2310	/	-5.81	/	54	/	AV
2390	56.06	-5.84	50.22	74	-23.78	PK
2390	/	-5.84	/	54	/	AV
2400	57.89	-5.84	52.05	74	-21.95	PK
2400	/	-5.84	/	54	/	AV

Remark: Factor = Antenna Factor + Cable Loss – Pre-amplifier.

8DPSK Operation Mode: TX CH High (2480MHz)

Horizontal:

Frequency	Reading Result	Factor	Emission Level	Limits	Margin	Detector Type
(MHz)	(dBμV)	(dB)	(dBμV/m)	(dBμV/m)	(dB)	
2483.5	57.26	-5.65	51.61	74	-22.39	PK
2483.5	/	-5.65	/	54	/	AV
2500	54.79	-5.72	49.07	74	-24.93	PK
2500	/	-5.72	/	54	/	AV

Remark: Factor = Antenna Factor + Cable Loss – Pre-amplifier.

Vertical:

Frequency	Reading Result	Factor	Emission Level	Limits	Margin	Detector Type
(MHz)	(dBμV)	(dB)	(dBμV/m)	(dBμV/m)	(dB)	
2483.5	57.51	-5.65	51.86	74	-22.14	PK
2483.5	/	-5.65	/	54	/	AV
2500	55.21	-5.72	49.49	74	-24.51	PK
2500	/	-5.72	/	54	/	AV

Remark: Factor = Antenna Factor + Cable Loss – Pre-amplifier.

6 OCCUPIED BANDWIDTH MEASUREMENT

6.1 Test Setup

Same as Radiated Emission Measurement

6.2 Test Procedure

1. The EUT was placed on a turn table which is 0.8m above ground plane.
2. Set EUT as normal operation.
3. Based on ANSI C63.10 section 6.9.2: RBW=30KHz. VBW=100KHz, Span=3MHz.
4. The useful radiated emission from the EUT was detected by the spectrum analyzer with peak detector.

6.3 Measurement Equipment Used

Same as Radiated Emission Measurement. The two headset circuits of the prototype are the same, so only one headset is tested.

6.4 Test Result

PASS

Left earphone

DH5

Frequency (MHz)	20dB Bandwidth (MHz)	Result
2402	0.9595	PASS
2441	0.9584	PASS
2480	0.9605	PASS

CH:2402MHz



CH:2441MHz

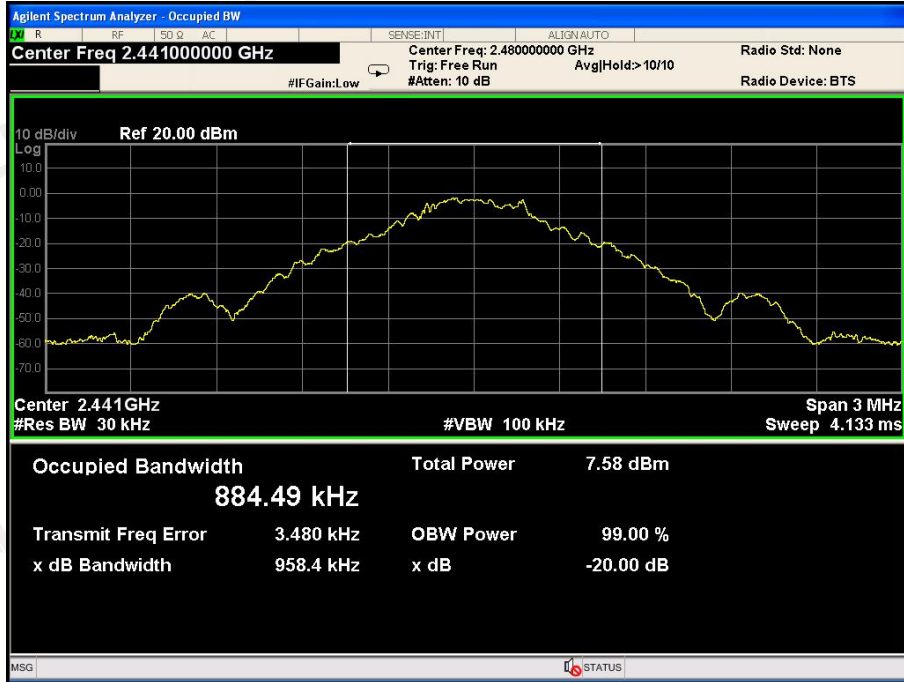

CH:2480MHz



2DH5

Frequency (MHz)	20dB Bandwidth (MHz)	Result
2402	1.283	PASS
2441	1.287	PASS
2480	1.280	PASS

CH:2402MHz

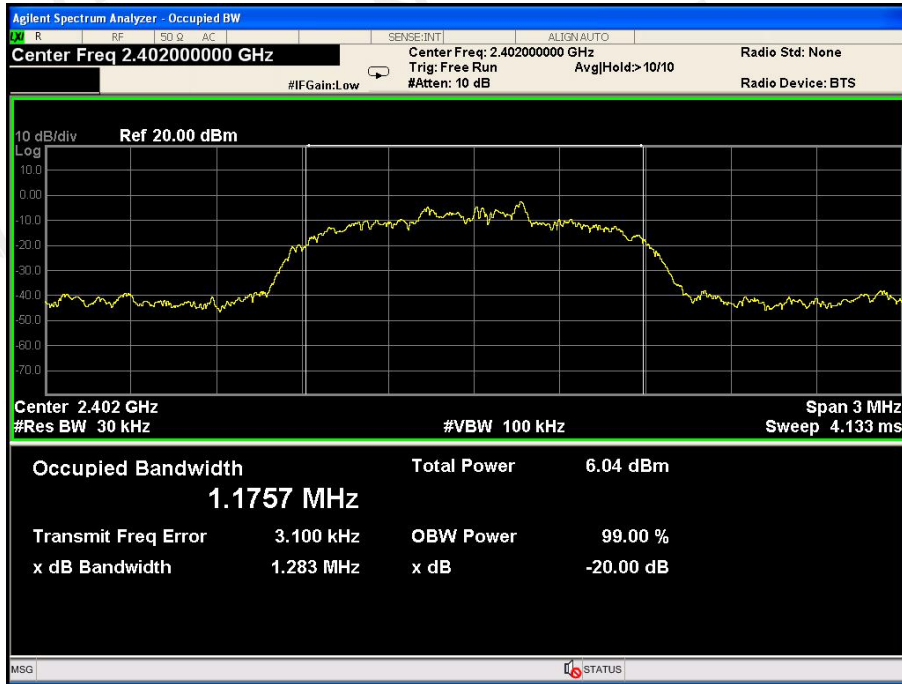

CH:2441MHz

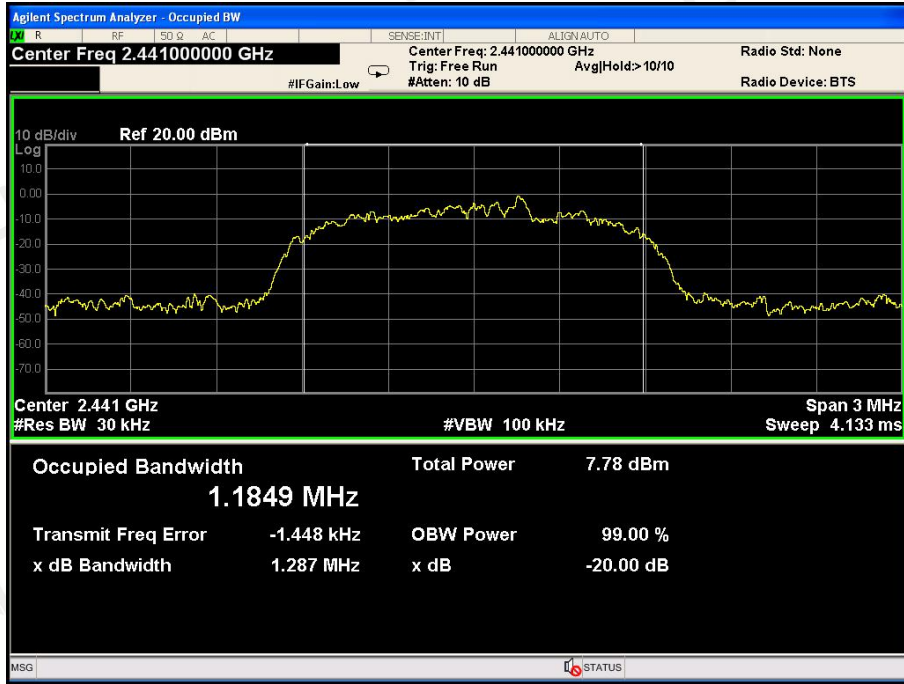

CH:2480MHz

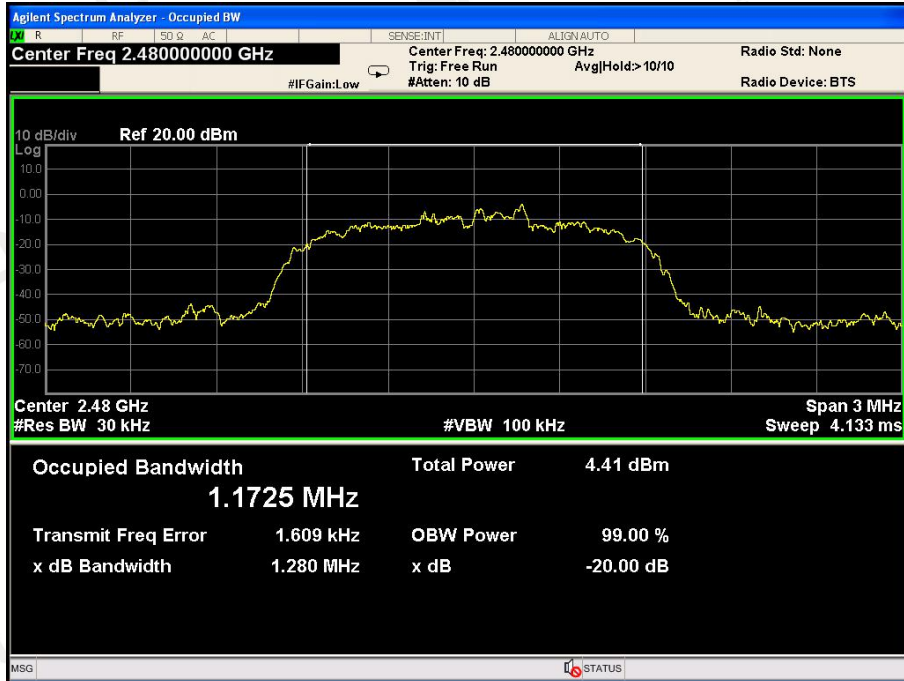



3DH5

Frequency (MHz)	20dB Bandwidth (MHz)	Result
2402	1.284	PASS
2441	1.286	PASS
2480	1.294	PASS

CH:2402MHz

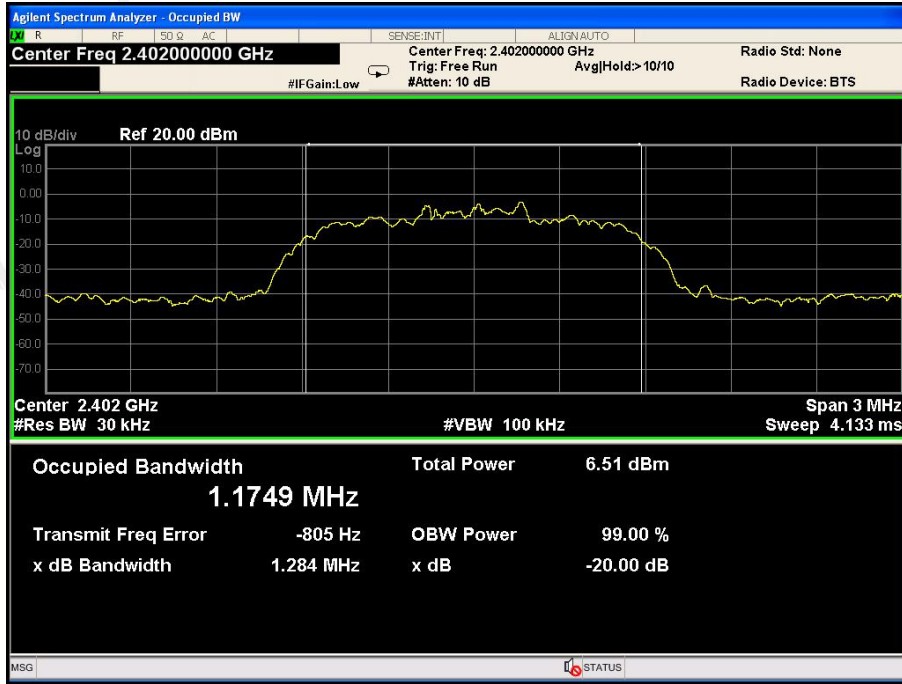

CH:2441MHz

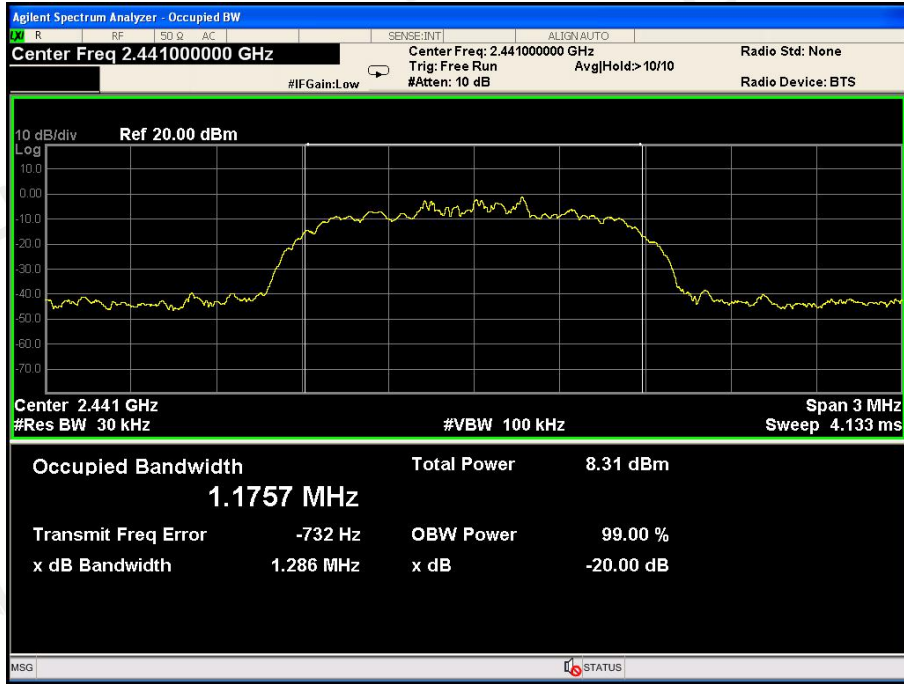

CH:2480MHz

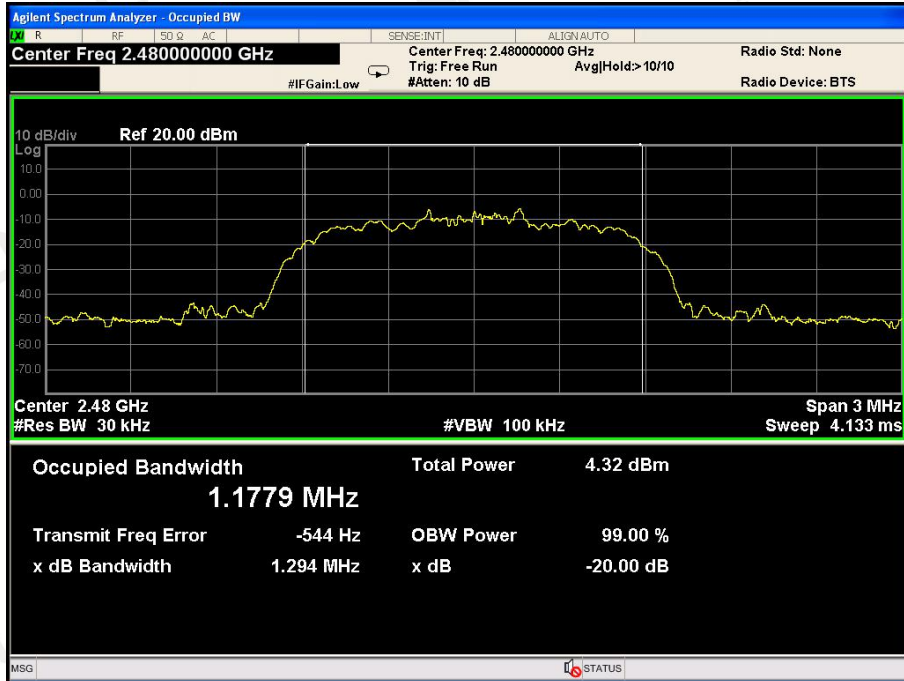

7 ANTENNA REQUIREMENT

Standard Applicable:

For intentional device, according to FCC 47 CFR Section 15.203, an intentional radiator shall be designed to ensure that no antenna other than that furnished by the responsible party shall be used with the device.

Antenna Connected Construction

The antenna used in this product is a PCB Antenna, The directional gains of antenna used for transmitting is 1dBi.

ANTENNA:

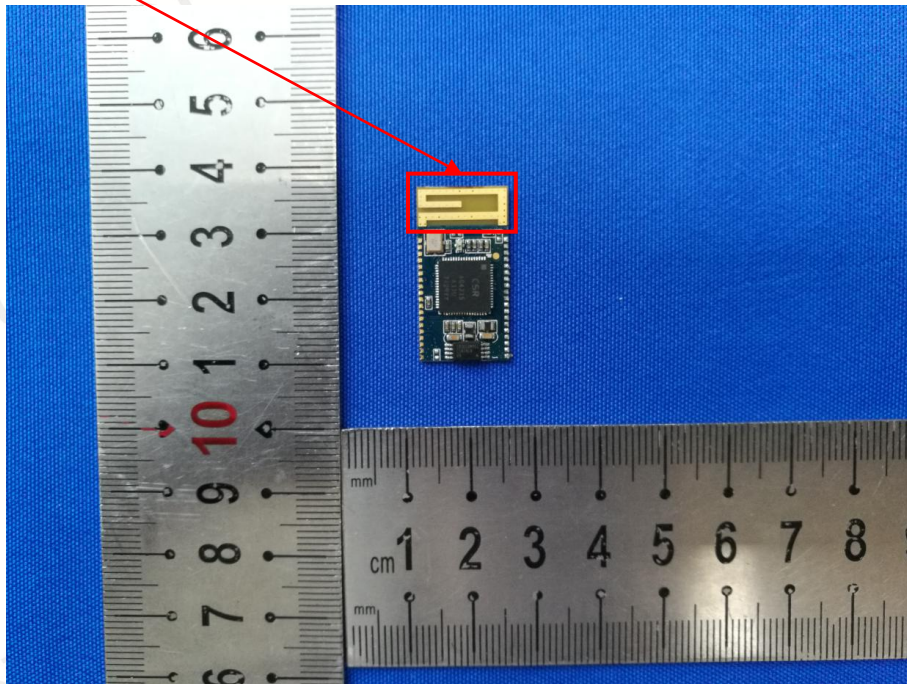

8 PHOTOGRAPH OF TEST

8.1 Radiated Emission



8.2 Conducted Emission

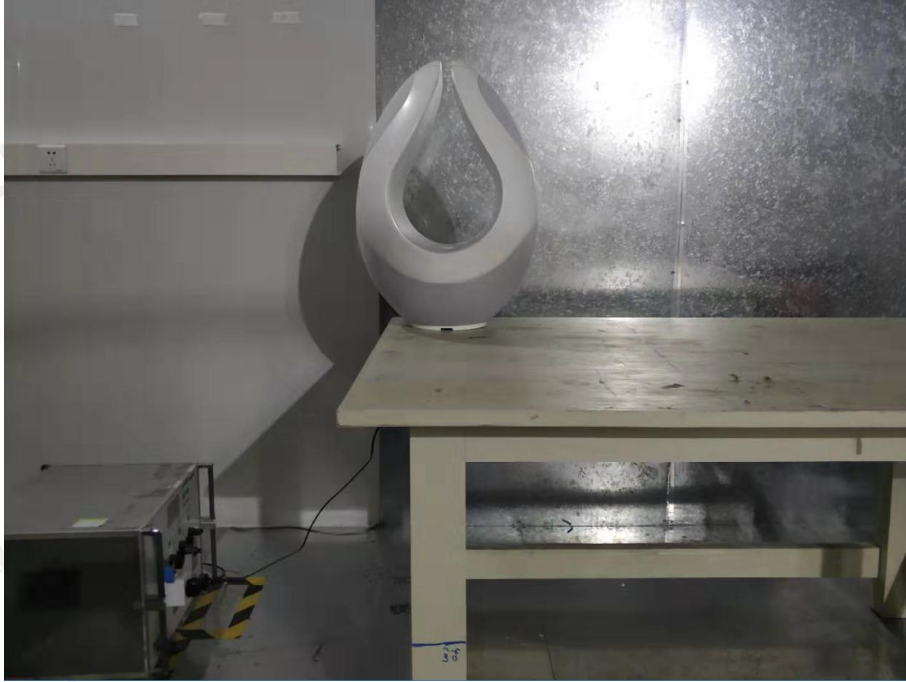

End of Report