

PIXIE CRUISER

6+

OPERATING INSTRUCTIONS AND PLAY

Carefully remove items from package.

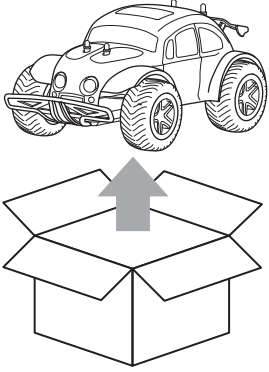

Make sure the ON/OFF switch is set to OFF. Open the battery compartment and insert 6 "AA" (1.5V) batteries (included). Replace the cover.

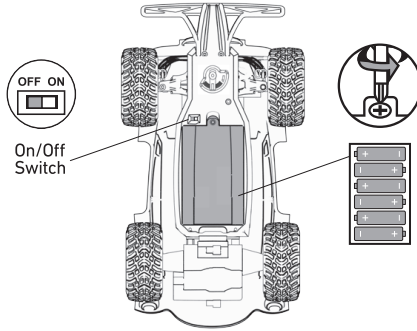

Use Alkaline batteries for best performance

Open battery cover and install 1 9V battery (included). Replace the cover.

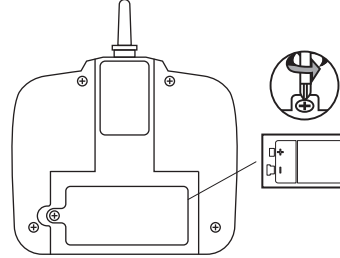

Play

- The remote pair light will flash after you installed the battery. Turn the power switch on the bottom of the vehicle to the "ON" position. The remote pair light will turn solid when paired.
- After 5 minutes, remote will go to sleep to preserve battery. To wake, push the lever on the remote.

Reverse

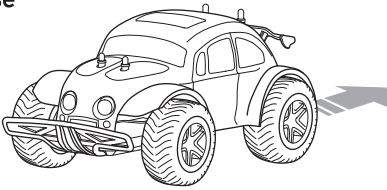

Push the throttle lever backwards.

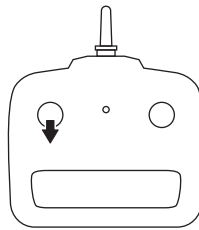

Forward

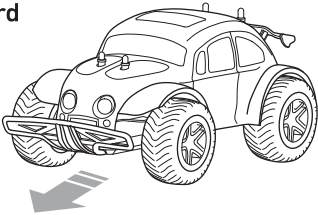

Push the throttle lever forwards.

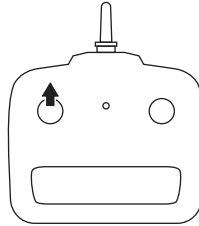

Turn Left

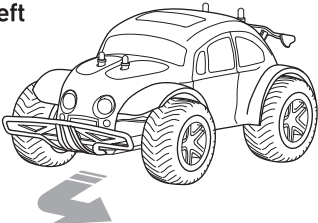

Push the throttle lever forwards and press the steering lever to the left.

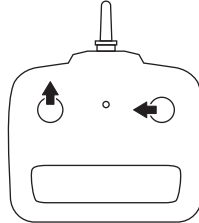

Turn Right

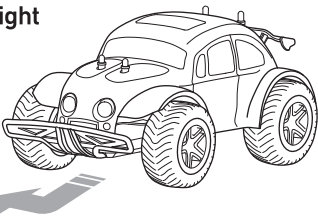

Push the throttle lever forwards and press the steering lever to the right.

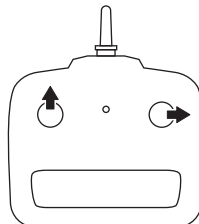

Drift Left

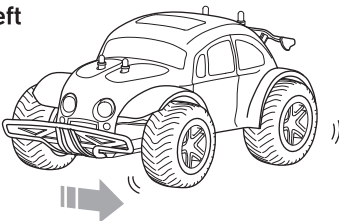

If the car tends to drift to the left, move the trimmer (beneath the car) to the left to adjust the steering.

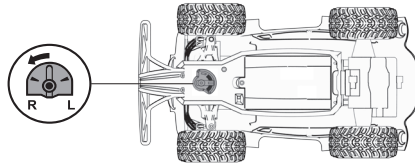

Drift Right

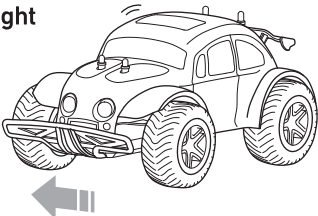

If the car tends to drift to the right, move the trimmer (beneath the car) to the right to adjust the steering.

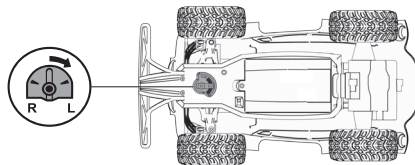

SAFETY PRECAUTIONS

- Parents: please read the instructions with your children before using the product for the first time.
- Stop the vehicle with the remote control before picking it up.
- Keep hands, hair and clothing away from moving parts when the toy is operating.
- Do not use the vehicle with the radio control in the street. Avoid collisions with people, animals and furniture.
- The wires are not to be inserted into socket-outlets.

BATTERY WARNING:

- Do not recharge non-rechargeable batteries.
- Rechargeable batteries must be removed before recharging. (For replaceable battery)
- Rechargeable batteries are only to be charged under the adult supervision.
- Do not mix different types of batteries or new batteries with old batteries.
- Only use batteries of the recommended type or an equivalent type.
- Take care to respect the + and - polarities when inserting batteries.
- Used batteries must be removed from the product.
- Do not short-circuit the power terminals.
- Do not mix alkaline batteries, standard batteries (carbon-zinc) and rechargeable batteries.

CARE AND MAINTENANCE:

- Always remove the batteries from the toy if it is not used for a long time.
- Wipe the toy gently with a clean cloth.
- Keep the toy away from direct sources of heat.
- Do not immerse the toy in water, as this could damage electronic components.
- Replace batteries when they become less powerful.
- Operation temperature 5 - 35°C
- Receiver Category 3

SAFETY CIRCUIT:

During use, the internal power in the electric circuit can get quite high (for example during a 360 spin). In such a case safety circuit will shut down the vehicle for approximately 1 minute. During this period the car will not respond to signals from the transmitter. This is not a defect but a safety measure to protect the electronic circuits. After this period, the car will resume normal operation.

WASTE ELECTRICAL AND ELECTRONIC EQUIPMENT (WEEE):

When this device reaches the end of its life, please remove all batteries and dispose of them separately. Take electrical devices to a collection centre for electronic equipment and household appliances. Other components can be disposed of with household waste.

The use of the product may be disrupted by electromagnetic interference. If this is the case, switch the device off and on again following the instructions in the user manual. If the functions are not reset, move to another location.

WARNING: Changes / modifications not approved by the responsible party could void the user's authority to operate the equipment.

This device complies with Part 15 of the FCC Rules. Operation is subject to the following two conditions: (1) this device may not cause harmful interference, and (2) this device must accept any interference received, including interference that may cause undesired operation.

Note: This equipment has been tested and found to comply with the limits for a Class B digital device, pursuant to part 15 of the FCC Rules. These limits are designed to provide reasonable protection against harmful interference in a residential installation. This equipment generates, uses and can radiate radio frequency energy and, if not installed and used in accordance with the instructions, may cause harmful interference to radio communications.

However, there is no guarantee that interference will not occur in a particular installation. If this equipment does cause harmful interference to radio or television reception, which can be determined by turning the equipment off and on, the user is encouraged to try to correct the interference by one or more of the following measures:
 —Reorient or relocate the receiving antenna.
 —Increase the separation between the equipment and receiver.
 —Connect the equipment into an outlet on a circuit different from that to which the receiver is connected.
 —Consult the dealer or an experienced radio/TV technician for help.

Keep this Instruction manual for reference as it contains important information.

WARNING:
 CHOKING HAZARD - Small Parts.
 Not for Children under 3 years.

©2018 MerchSource, LLC. Irvine, CA 92618. All rights reserved.
 PRINTED IN CHINA.

QUESTIONS OR CONCERNS?
 PLEASE GIVE US A CALL... WE'RE HERE TO HELP
CUSTOMER SERVICE (800) 374-2744

Before calling please locate the 10-digit code printed on the back of your remote