

FCC TEST REPORT

FCC ID:2AVVO-WF150N

Report Number : ZKT-2106072391E

Date of Test Jun. 24, 2021 to Jul. 06, 2021

Date of issue : Jul. 06, 2021

Total number of pages 51

Test Result : PASS

Testing Laboratory : **Shenzhen ZKT Technology Co., Ltd.**

Address : 1/F, No. 101, Building B, No. 6, Tangwei Community Industrial Avenue, Fuhai Street, Bao'an District, Shenzhen, China

Applicant's name : **Shenzhen QR Technology Development Corporation Limited**

Address : Floor 3, Building 7, Zhengzhong Industrial Park Dayang Community, Fuhai, Baoan District, Shenzhen, Guangdong Province, China

Manufacturer's name : **Shenzhen QR Technology Development Corporation Limited**

Address : Floor 3, Building 7, Zhengzhong Industrial Park Dayang Community, Fuhai, Baoan District, Shenzhen, Guangdong Province, China

Test specification:

Standard : FCC CFR Title 47 Part 15 Subpart C Section 15.247
ANSI C63.10:2013

Test procedure : /

Non-standard test method : N/A

Test Report Form No. : TRF-EL-110_V0

Test Report Form(s) Originator : ZKT Testing

Master TRF : Dated: 2020-01-06

This device described above has been tested by ZKT, and the test results show that the equipment under test (EUT) is in compliance with the FCC requirements. And it is applicable only to the tested sample identified in the report.

This report shall not be reproduced except in full, without the written approval of ZKT, this document may be altered or revised by ZKT, personal only, and shall be noted in the revision of the document.

Product name : **WiFi digital photo frame**

Trademark : N/A

Model/Type reference : WF150N,
WF116N, WF120N, WF125N , WF133N, WF140N, WF156N

Ratings : Input: DC 12V From Switching Power Supply

Testing procedure and testing location:

Testing Laboratory.....: **Shenzhen ZKT Technology Co., Ltd.**

Address.....: 1/F, No. 101, Building B, No. 6, Tangwei Community
Industrial Avenue, Fuhai Street, Bao'an District,
Shenzhen, China

Tested by (name + signature).....: **Alen He**



Reviewer (name + signature).....: **Joe Liu**



Approved (name + signature).....: **Lake Xie**



Table of Contents

	Page
1. VERSION	5
2. SUMMARY OF TEST RESULTS	6
2.1 TEST FACILITY	7
2.2 MEASUREMENT UNCERTAINTY	7
3. GENERAL INFORMATION	8
3.1 GENERAL DESCRIPTION OF EUT	8
3.2 DESCRIPTION OF TEST MODES	9
3.3 BLOCK DIGRAM SHOWING THE CONFIGURATION OF SYSTEM TESTED	9
3.4 DESCRIPTION OF SUPPORT UNITS(CONDUCTED MODE)	10
3.5EQUIPMENTS LIST FOR ALL TEST ITEMS	11
4. EMC EMISSION TEST	12
4.1 CONDUCTED EMISSION MEASUREMENT	12
4.1.1 POWER LINE CONDUCTED EMISSION LIMITS	12
4.1.2 TEST PROCEDURE	12
4.1.3 DEVIATION FROM TEST STANDARD	12
4.1.4 TEST SETUP	13
4.1.5 EUT OPERATING CONDITIONS	13
4.1.6 TEST RESULT	14
4.2 RADIATED EMISSION MEASUREMENT	16
4.2.1 RADIATED EMISSION LIMITS	16
4.2.2 TEST PROCEDURE	16
4.2.3 DEVIATION FROM TEST STANDARD	17
4.2.4 TEST SETUP	17
4.2.5 EUT OPERATING CONDITIONS	18
4.2.6 TEST RESULTS	18
5.RADIATED BAND EMISSIONMEASUREMENT	27
5.1 TEST REQUIREMENT:	27
5.2 TEST PROCEDURE	27
5.3 DEVIATION FROM TEST STANDARD	27
5.4 TEST SETUP	28
5.5 EUT OPERATING CONDITIONS	28
5.6 TEST RESULT	29
6.POWER SPECTRAL DENSITY TEST	31
6.1 APPLIED PROCEDURES / LIMIT	31
6.2 TEST PROCEDURE	31
6.3 DEVIATION FROM STANDARD	31
6.4 TEST SETUP	31
6.5 EUT OPERATION CONDITIONS	31

6.6 TEST RESULT	32
7. CHANNEL BANDWIDTH& 99% OCCUPY BANDWIDTH	38
7.1 APPLIED PROCEDURES / LIMIT	38
7.2 TEST PROCEDURE	38
7.3 DEVIATION FROM STANDARD	38
7.4 TEST SETUP	38
7.5 EUT OPERATION CONDITIONS	38
7.6 TEST RESULT	39
8.PEAK OUTPUT POWER TEST	42
8.1 APPLIED PROCEDURES/LIMIT	42
8.2 TEST PROCEDURE	42
8.3 DEVIATION FROM STANDARD	42
8.4 TEST SETUP	42
8.5 EUT OPERATION CONDITIONS	42
8.6 TEST RESULT	43
9. CONDUCTED BAND EDGE AND SPURIOUS EMISSION	44
9.1 APPLICABLE STANDARD	44
9.2 TEST PROCEDURE	44
9.3 DEVIATION FROM STANDARD	44
9.4 TEST SETUP	44
9.5 EUT OPERATION CONDITIONS	44
9.6 TEST RESULTS	44
10. ANTENNA REQUIREMENT	50
11. TEST SETUP PHOTO	51
12. EUT CONSTRUCTIONAL DETAILS	51

1. VERSION

Report No.	Version	Description	Approved
ZKT-2106072391E	Rev.01	Initial issue of report	Jul. 06, 2021

2. SUMMARY OF TEST RESULTS

Test procedures according to the technical standards:

FCC Part15 (15.247) , Subpart C				
	Standard Section	Test Item	Result	Remark
	FCC part 15.203/15.247 (c)	Antenna requirement	PASS	
	FCC part 15.207	AC Power Line Conducted Emission	PASS	
	FCC part 15.247 (b)(3)	Conducted Peak Output Power	PASS	
	FCC part 15.247 (a)(2)	Channel Bandwidth& 99% OCB	PASS	
	FCC part 15.247 (e)	Power Spectral Density	PASS	
	FCC part 15.247(d)	Band Edge	PASS	
	FCC part 15.205/15.209	Spurious Emission	PASS	

NOTE:

(1)" N/A" denotes test is not applicable in this Test Report

2.1 TEST FACILITY

Shenzhen ZKT Technology Co., Ltd.
Add. : 1/F, No. 101, Building B, No. 6, Tangwei Community Industrial Avenue, Fuhai Street, Bao'an District, Shenzhen, China

FCC Test Firm Registration Number: 692225
Designation Number: CN1299
IC Registered No.: 27033

2.2 MEASUREMENT UNCERTAINTY

The reported uncertainty of measurement $y \pm U$, where expanded uncertainty U is based on a standard uncertainty multiplied by a coverage factor of $k=2$, providing a level of confidence of approximately 95 %.

No.	Item	Uncertainty
1	Conducted Emission Test	$\pm 1.38\text{dB}$
2	RF power conducted	$\pm 0.16\text{dB}$
3	Spurious emissions conducted	$\pm 0.21\text{dB}$
4	All emissions radiated(<1G)	$\pm 4.68\text{dB}$
5	All emissions radiated(>1G)	$\pm 4.89\text{dB}$
6	Temperature	$\pm 0.5^{\circ}\text{C}$
7	Humidity	$\pm 2\%$

3. GENERAL INFORMATION

3.1 GENERAL DESCRIPTION OF EUT

Product Name:	WiFi digital photo frame
Model No.:	WF150N, WF116N, WF120N, WF125N, WF133N, WF140N, WF156N
Model Different.:	Only for different model name.
Serial No.:	N/A
Hardware Version:	H1.0
Software Version:	S1.0
Sample(s) Status:	Engineer sample
Channel numbers:	802.11b/802.11g /802.11n(HT20):11
Channel separation:	5MHz
Modulation technology:	802.11b: Direct Sequence Spread Spectrum(DSSS) 802.11g/802.11n(H20): Orthogonal Frequency Division Multiplexing(OFDM)
Antenna Type:	FPCB Antenna
Antenna gain:	0dBi
Power supply:	Input: DC 12V From Switching Power Supply

Operation Frequency each of channel							
Channel	Frequency	Chann el	Frequency	Chann el	Frequency	Chann el	Frequency
1	2412MHz	4	2427MHz	7	2442MHz	10	2457MHz
2	2417MHz	5	2432MHz	8	2447MHz	11	2462MHz
3	2422MHz	6	2437MHz	9	2452MHz	X	

Note:

In section 15.31(m), regards to the operating frequency range over 10 MHz, the Lowest frequency, the middle frequency, and the highest frequency of channel were selected to perform the test, and the selected channel see below:

Test channel	Frequency (MHz)	
	802.11b/802.11g/802.11n(HT20)	
Lowest channel	2412MHz	
Middle channel	2437MHz	
Highest channel	2462MHz	

3.2 DESCRIPTION OF TEST MODES

Transmitting mode	Keep the EUT in continuously transmitting mode
Remark: During the test, the duty cycle >98%, the test voltage was tuned from 85% to 115% of the nominal rated supply voltage, and found that the worst case was under the nominal rated supply condition. So the report just shows that condition's data.	

We have verified the construction and function in typical operation. All the test modes were carried out with the EUT in transmitting operation, which was shown in this test report and defined as follows:				
Pre-scan all kind of data rate in lowest channel, and found the follow list which it was worst case.				
Mode	802.11b	802.11g	802.11n(HT20)	
Data rate	1Mbps	6Mbps	6.5Mbps	

Test Software	Realtek Test Tool
Power level setup	<13dBm

3.3 BLOCK DIGRAM SHOWING THE CONFIGURATION OF SYSTEM TESTED

Conducted Emission



Radiated Emission

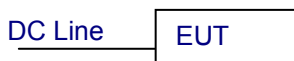

Conducted Spurious

DC Line

EUT

3.4 DESCRIPTION OF SUPPORT UNITS(CONDUCTED MODE)

The EUT has been tested as an independent unit together with other necessary accessories or support units. The following support units or accessories were used to form a representative test configuration during the tests.

Item	Equipment	Mfr/Brand	Model/Type No.	Series No.	Note
E-1	WiFi digital photo frame	N/A	WF150N	N/A	EUT
E-2	Switching Power Supply	N/A	XSD-1201500SUSD	N/A	EUT

Item	Shielded Type	Ferrite Core	Length	Note

Note:

- (1) The support equipment was authorized by Declaration of Confirmation.
- (2) For detachable type I/O cable should be specified the length in cm in 『Length』 column.

3.5EQUIPMENTS LIST FOR ALL TEST ITEMS
Radiation Test equipment

Item	Equipment	Manufacturer	Type No.	Serial No.	Last calibration	Calibrated until
1	Spectrum Analyzer (9kHz-26.5GHz)	KEYSIGHT	9020A	MY45109572	Sep. 22, 2020	Sep. 21, 2021
2	Spectrum Analyzer (1GHz-40GHz)	Agilent	E4446A	100363	Sep. 22, 2020	Sep. 21, 2021
3	Test Receiver (9kHz-7GHz)	R&S	ESC17	101169	Sep. 22, 2020	Sep. 21, 2021
4	Bilog Antenna (30MHz-1400MHz)	Schwarzbeck	VULB9168	00877	Sep. 22, 2020	Sep. 21, 2021
5	Horn Antenna (1GHz-18GHz)	SCHWARZBEC K	BBHA9120D	1541	Sep. 22, 2020	Sep. 21, 2021
6	Horn Antenna (18GHz-40GHz)	A.H. System	SAS-574	588	Sep. 22, 2020	Sep. 21, 2021
7	Amplifier (30-1000MHz)	EM Electronics	EM330 Amplifier	N/A	Sep. 22, 2020	Sep. 21, 2021
8	Amplifier (1GHz-40GHz)	全聚达	DLE-161	097	Sep. 22, 2020	Sep. 21, 2021
9	Loop Antenna (9KHz-30MHz)	SCHWARZBEC K	FMZB1519B	014	Sep. 22, 2020	Sep. 21, 2021
10	RF cables1 (9kHz-30MHz)	N/A	9kHz-30MHz	N/A	Sep. 22, 2020	Sep. 21, 2021
11	RF cables2 (30MHz-1GHz)	N/A	30MHz-1GHz	N/A	Sep. 22, 2020	Sep. 21, 2021
12	RF cables3 (1GHz-40GHz)	N/A	1GHz-40GHz	N/A	Sep. 22, 2020	Sep. 21, 2021
13	CMW500 Test	R&S	CMW500	106504	Sep. 22, 2020	Sep. 21, 2021
14	ESG Signal Generator	Agilent	E4421B	GB40051203	Sep. 22, 2020	Sep. 21, 2021
15	Signal Generator	Agilent	N5182A	MY47420215	Sep. 22, 2020	Sep. 21, 2021
16	D.C. Power Supply	LongWei	TPR-6405D	\	\	\
17	Software	Frad	EZ-EMC	FA-03A2 RE	\	\

Conduction Test equipment

Item	Kind of Equipment	Manufacturer	Type No.	Serial No.	Last calibration	Calibrated until
1	LISN	R&S	ENV216	101471	Sep. 22, 2020	Sep. 21, 2021
2	LISN	CYBERTEK	EM5040A	E185040014 9	Sep. 22, 2020	Sep. 21, 2021
3	Test Cable	N/A	C01	N/A	Sep. 22, 2020	Sep. 21, 2021
4	Test Cable	N/A	C02	N/A	Sep. 22, 2020	Sep. 21, 2021
5	EMI Test Receiver	R&S	ESRP3	101946	Sep. 22, 2020	Sep. 21, 2021
6	Absorbing Clamp	DZ	ZN23201	N/A	Sep. 22, 2020	Sep. 21, 2021

4. EMC EMISSION TEST

4.1 CONDUCTED EMISSION MEASUREMENT

Test Requirement:	FCC Part15 C Section 15.207
Test Method:	ANSI C63.10:2013
Test Frequency Range:	150KHz to 30MHz
Receiver setup:	RBW=9KHz, VBW=30KHz, Sweep time=auto

4.1.1 POWER LINE CONDUCTED EMISSION Limits

FREQUENCY (MHz)	Limit (dBuV)		Standard
	Quasi-peak	Average	
0.15 -0.5	66 - 56 *	56 - 46 *	FCC
0.50 -5.0	56.00	46.00	FCC
5.0 -30.0	60.00	50.00	FCC

Note:

(1) *Decreases with the logarithm of the frequency.

4.1.2 TEST PROCEDURE

- The EUT was placed 0.1 meters from the horizontal ground plane with EUT being connected to the power mains through a line impedance stabilization network (LISN). All other support equipments powered from additional LISN(s). The LISN provide 50 Ohm/ 50uH of coupling impedance for the measuring instrument.
- Interconnecting cables that hang closer than 40 cm to the ground plane shall be folded back and forth in the center forming a bundle 30 to 40 cm long.
- I/O cables that are not connected to a peripheral shall be bundled in the center. The end of the cable may be terminated, if required, using the correct terminating impedance. The overall length shall not exceed 1 m.
- LISN at least 80 cm from nearest part of EUT chassis.
- For the actual test configuration, please refer to the related Item –EUT Test Photos.

4.1.3 DEVIATION FROM TEST STANDARD

No deviation

4.1.4 TEST SETUP

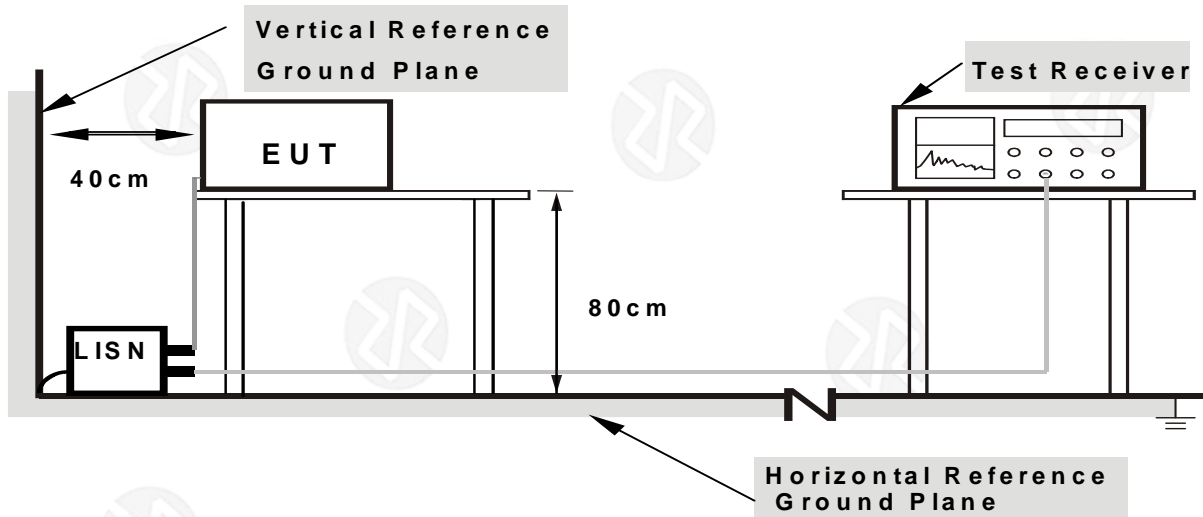

Note: 1.Support units were connected to second LISN.

2.Both of LISNs (AMN) are 80 cm from EUT and at least 80 cm from other units and other metal planes

4.1.5 EUT OPERATING CONDITIONS

The EUT was configured for testing in a typical fashion (as a customer would normally use it). The EUT has been programmed to Charging during test. This operating condition was tested and used to collect the included data.

We pretest AC 120V and AC 230V, the worst voltage was AC 120V and the data recording in the report.

4.1.6 TEST RESULT

Temperature :	26°C	Relative Humidity:	54%
Pressure :	101kPa	Phase :	L
Test Voltage :	AC 120V/60Hz		

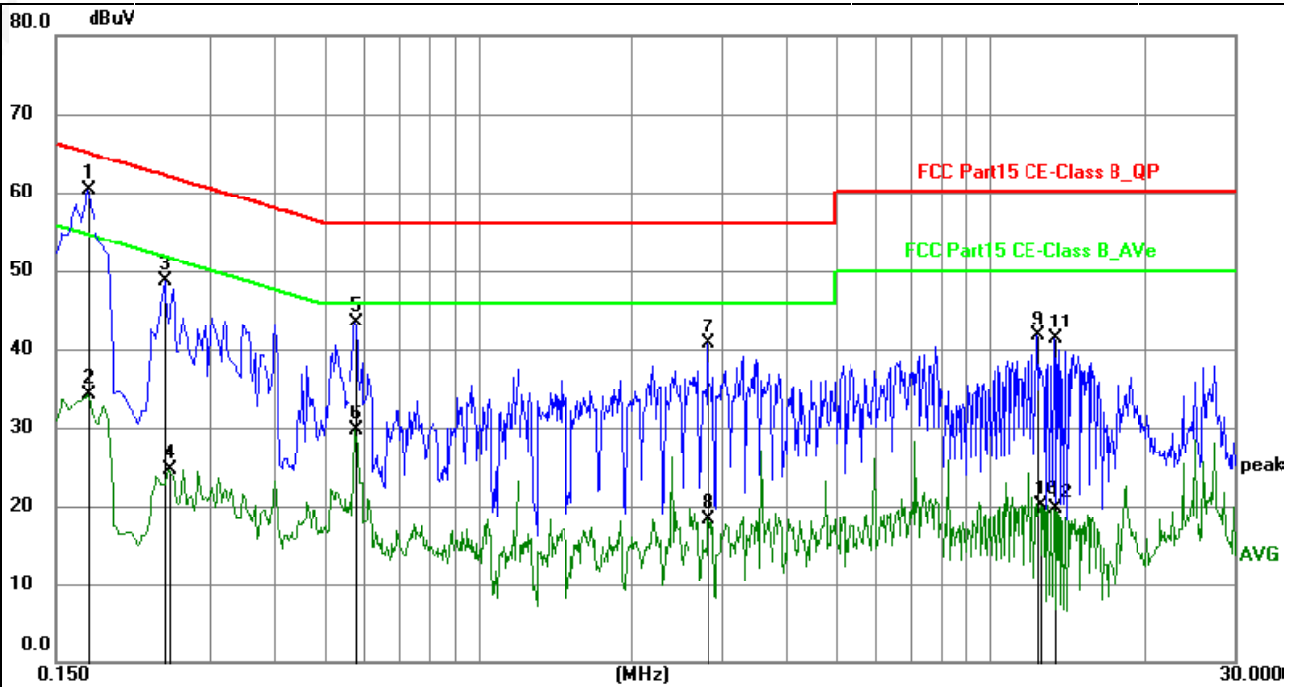

No.	Frequency (MHz)	Reading (dBuV)	Factor (dB)	Level (dBuV)	Limit (dBuV)	Margin (dB)	Detector	P/F	Remark
1	0.1725	47.70	12.51	60.21	64.84	-4.63	QP	P	
2	0.1725	21.83	12.51	34.34	54.84	-20.50	AVG	P	
3	0.2445	37.01	11.71	48.72	61.94	-13.22	QP	P	
4	0.2490	12.99	11.69	24.68	51.79	-27.11	AVG	P	
5	0.5775	32.95	10.52	43.47	56.00	-12.53	QP	P	
6	0.5775	19.21	10.52	29.73	46.00	-16.27	AVG	P	
7	2.8230	30.72	9.98	40.70	56.00	-15.30	QP	P	
8	2.8230	8.26	9.98	18.24	46.00	-27.76	AVG	P	
9	12.3900	32.91	8.79	41.70	60.00	-18.30	QP	P	
10	12.5925	11.28	8.82	20.10	50.00	-29.90	AVG	P	
11	13.3935	32.35	8.94	41.29	60.00	-18.71	QP	P	
12	13.3935	10.75	8.94	19.69	50.00	-30.31	AVG	P	

Notes:

1. An initial pre-scan was performed on the line and neutral lines with peak detector.
2. Quasi-Peak and Average measurement were performed at the frequencies with maximized peak emission.
3. Measurement Level = Reading level + Correct Factor

Temperature :	26°C	Relative Humidity:	54%
Pressure :	101kPa	Phase :	N
Test Voltage :	AC 120V/60Hz		

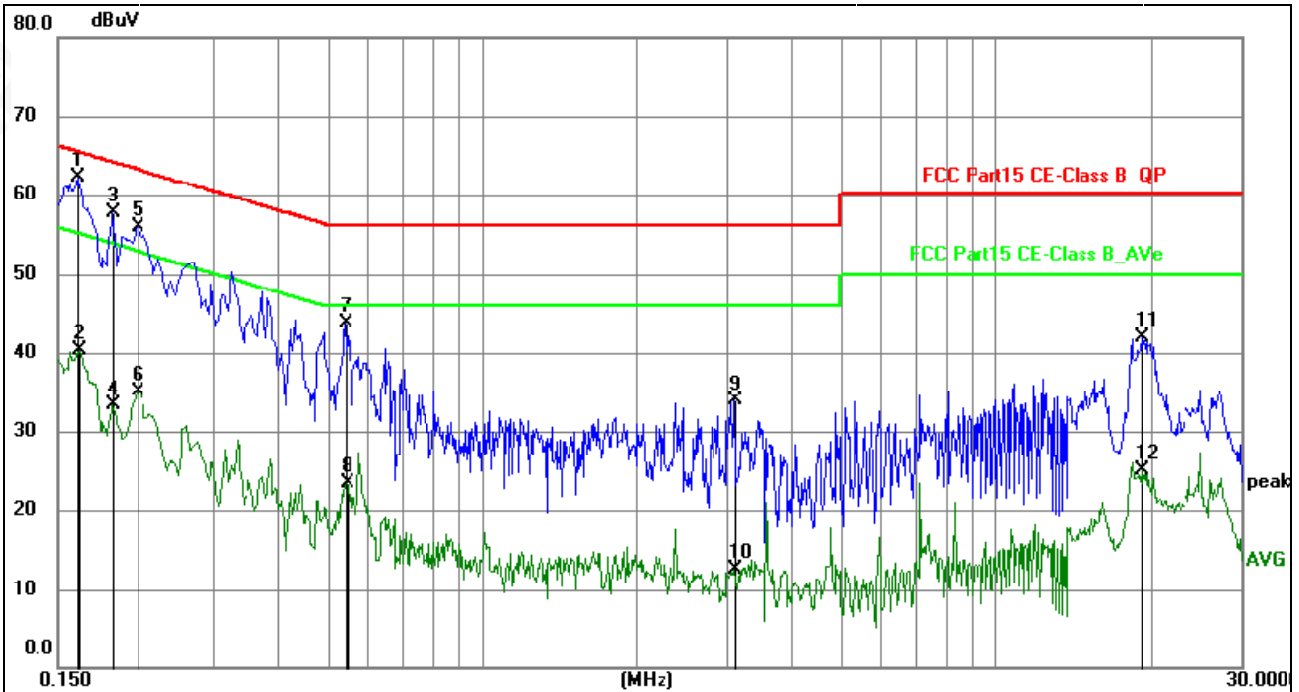

No.	Frequency (MHz)	Reading (dBuV)	Factor (dB)	Level (dBuV)	Limit (dBuV)	Margin (dB)	Detector	P/F	Remark
1	0.1635	49.51	12.71	62.22	65.28	-3.06	QP	P	
2	0.1650	27.62	12.68	40.30	55.21	-14.91	AVG	P	
3	0.1905	45.54	12.13	57.67	64.01	-6.34	QP	P	
4	0.1905	21.19	12.13	33.32	54.01	-20.69	AVG	P	
5	0.2130	44.07	11.86	55.93	63.09	-7.16	QP	P	
6	0.2130	23.16	11.86	35.02	53.09	-18.07	AVG	P	
7	0.5415	33.25	10.53	43.78	56.00	-12.22	QP	P	
8	0.5460	12.89	10.53	23.42	46.00	-22.58	AVG	P	
9	3.0975	24.02	9.88	33.90	56.00	-22.10	QP	P	
10	3.0975	2.56	9.88	12.44	46.00	-33.56	AVG	P	
11	19.2255	32.14	9.75	41.89	60.00	-18.11	QP	P	
12	19.2255	15.28	9.75	25.03	50.00	-24.97	AVG	P	

Notes:

1. An initial pre-scan was performed on the line and neutral lines with peak detector.
2. Quasi-Peak and Average measurement were performed at the frequencies with maximized peak emission.
3. Measurement Level = Reading level + Correct Factor

4.2 RADIATED EMISSION MEASUREMENT

Test Requirement:	FCC Part15 C Section 15.209				
Test Method:	ANSI C63.10:2013				
Test Frequency Range:	9kHz to 25GHz				
Test site:	Measurement Distance: 3m				
Receiver setup:	Frequency	Detector	RBW	VBW	Value
	9KHz-150KHz	Quasi-peak	200Hz	600Hz	Quasi-peak
	150KHz-30MHz	Quasi-peak	9KHz	30KHz	Quasi-peak
	30MHz-1GHz	Quasi-peak	100KHz	300KHz	Quasi-peak
	Above 1GHz	Peak	1MHz	3MHz	Peak
Peak		1MHz	10Hz	Average	

4.2.1 RADIATED EMISSION LIMITS

Frequencies (MHz)	Field Strength (micorvolts/meter)	Measurement Distance (meters)
0.009~0.490	2400/F(KHz)	300
0.490~1.705	24000/F(KHz)	30
1.705~30.0	30	30
30~88	100	3
88~216	150	3
216~960	200	3
Above 960	500	3

LIMITS OF RADIATED EMISSION MEASUREMENT

FREQUENCY (MHz)	Limit (dBuV/m) (at 3M)	
	PEAK	AVERAGE
Above 1000	74	54

Notes:

- (1) The limit for radiated test was performed according to FCC PART 15C.
- (2) The tighter limit applies at the band edges.
- (3) Emission level (dBuV/m)=20log Emission level (uV/m).

4.2.2 TEST PROCEDURE

Below 1GHz test procedure as below:

- a. The EUT was placed on the top of a rotating table 0.1 meters above the ground at a 3 meter semi-anechoiccamber. The table was rotated 360 degrees to determine the position of the highest radiation.
- b. The EUT was set 3 meters away from the interference-receiving antenna, which was mounted on the top of variable-height antenna tower.

- c. The antenna height is varied from one meter to four meters above the ground to determine the maximum value of the field strength. Both horizontal and vertical polarizations of the antenna are set to make the measurement.
- d. For each suspected emission, the EUT was arranged to its worst case and then the antenna was tuned to heights from 1 meter to 4 meters (for the test frequency of below 30MHz, the antenna was tuned to heights 1meter) and the rotatable table was turned from 0 degrees to 360 degrees to find the maximum reading.
- e. The test-receiver system was set to Peak Detect Function and Specified Bandwidth with Maximum Hold Mode.
- f. If the emission level of the EUT in peak mode was 10dB lower than the limit specified, then testing could be stopped and the peak values of the EUT would be reported. Otherwise the emissions that did not have 10dBmargin would be re-tested one by one using peak, quasi-peak or average method as specified and then reported in a data sheet.

Above 1GHz test procedure as below:

- g. Different between above is the test site, change from Semi- Anechoic Chamber to fully Anechoic Chamber and change form table 0.8 meter to 1.5 meter(Above 18GHz the distance is 1 meter and table is 1.5 meter).
- h. Test the EUT in the lowest channel ,the middle channel ,the Highest channel

Note:

Both horizontal and vertical antenna polarities were tested and performed pretest to three orthogonal axis. The worst case emissions were reported

4.2.3 DEVIATION FROM TEST STANDARD

No deviation

4.2.4 TEST SETUP

(A) Radiated Emission Test-Up Frequency Below 30MHz

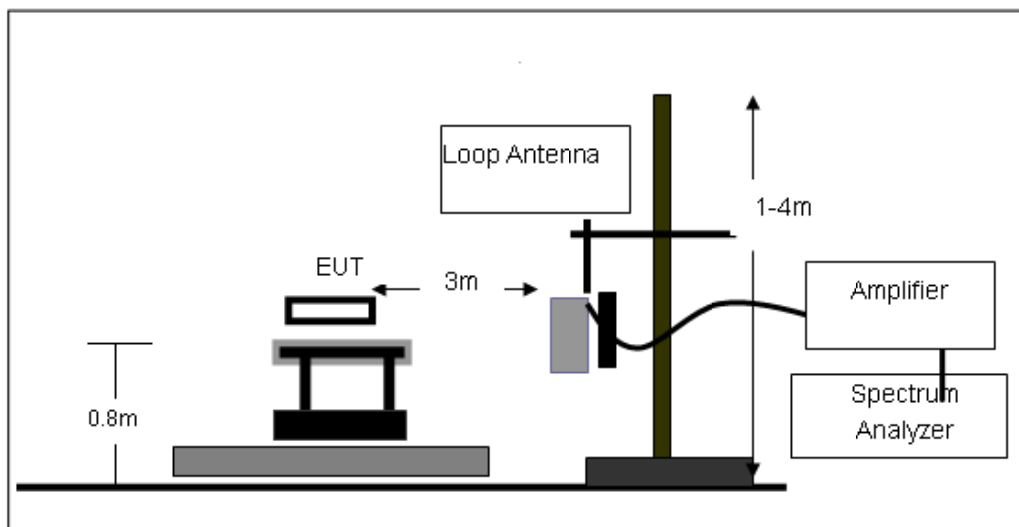

(B) Radiated Emission Test-Up Frequency 30MHz~1GHz

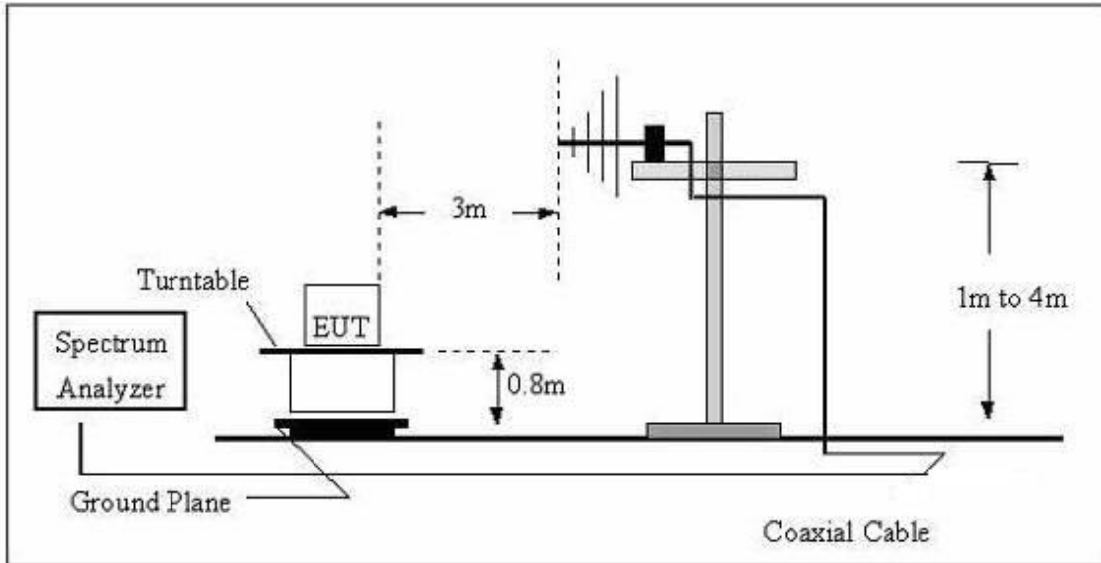

(C) Radiated Emission Test-Up Frequency Above 1GHz

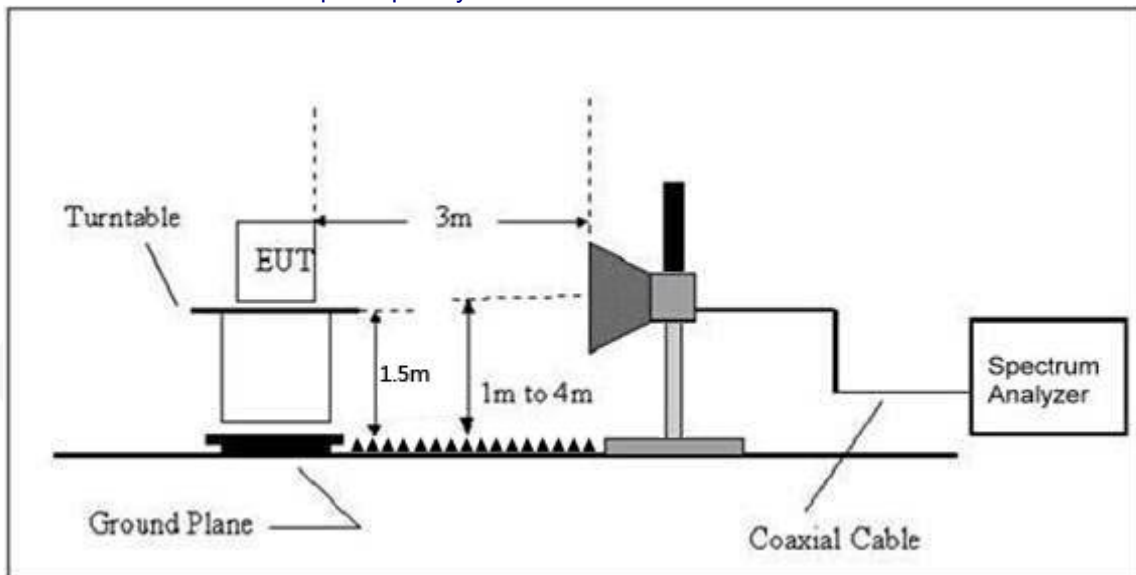

4.2.5 EUT OPERATING CONDITIONS

The EUT tested system was configured as the statements of 2.4 Unless otherwise a special operating condition is specified in the follows during the testing.

4.2.6 TEST RESULTS

Between 9KHz – 30MHz

The emission from 9 kHz to 30MHz was pre-tested and found the result was 20dB lower than the limit, and according to 15.31(o) & RSS-Gen 6.13, the test result no need to reported.

Between 30MHz – 1GHz

Temperature:	26°C	Relative Humidity:	54%
Pressure:	101 kPa	Polarization:	Horizontal
Test Voltage:	AC 120V/60Hz	Test Mode	Working

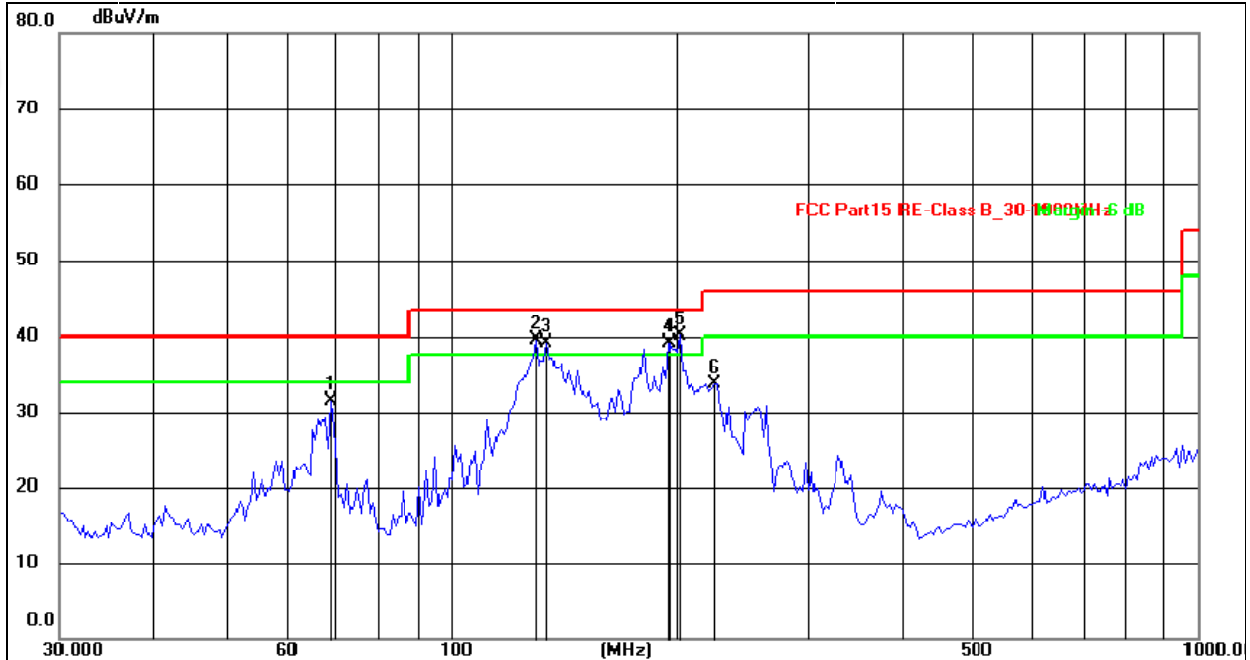

No.	Frequency (MHz)	Reading (dBuV)	Factor (dB/m)	Level (dBuV/m)	Limit (dBuV/m)	Margin (dB)	Detector
1	68.9929	48.11	-16.63	31.48	40.00	-8.52	QP
2	129.6949	57.60	-18.07	39.53	43.50	-3.97	QP
3	134.3234	56.82	-17.74	39.08	43.50	-4.42	QP
4	195.8219	58.69	-19.57	39.12	43.50	-4.38	QP
5	202.8103	59.83	-19.68	40.15	43.50	-3.35	QP
6	225.3079	52.30	-18.64	33.66	46.00	-12.34	QP

Temperature:	26°C	Relative Humidity:	54%
Pressure:	101kPa	Polarization:	Vertical
Test Voltage:	AC 120V/60Hz	Test Mode	Working

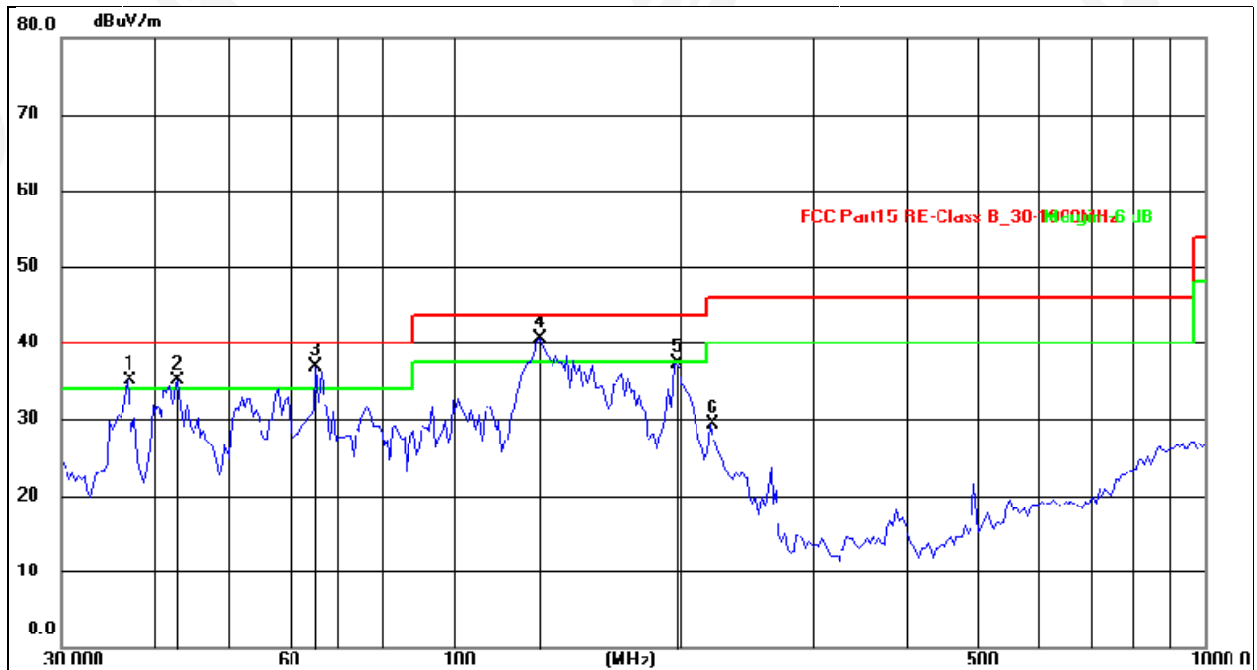

No.	Frequency (MHz)	Reading (dBuV)	Factor (dB/m)	Level (dBuV/m)	Limit (dBuV/m)	Margin (dB)	Detector
1	36.7018	52.51	-17.35	35.16	40.00	-4.84	QP
2	42.9750	52.14	-16.99	35.15	40.00	-4.85	QP
3	65.4578	55.71	-18.87	36.84	40.00	-3.16	QP
4	129.6949	61.93	-21.45	40.48	43.50	-3.02	QP
5	195.8220	58.83	-21.49	37.34	43.50	-6.16	QP
6	219.4598	50.98	-21.59	29.39	46.00	-16.61	QP

Remarks:

1. Final Level = Receiver Read level + Antenna Factor + Cable Loss – Pre-amplifier Factor
2. The emission levels of other frequencies are very lower than the limit and not show in test report.
3. The test data shows only the worst case 802.11b and DC 12V mode

1GHz~25GHz

802.11b

Polar (H/V)	Frequency	Meter Reading	Pre-amplifier	Cable Loss	Antenna Factor	Emission Level	Limits	Margin	Detect or Type
	(MHz)	(dBuV)	(dB)	(dB)	(dB)	(dBuV/m)	(dBuV/m)	(dB)	
Low Channel:2412MHz									
V	4824.00	54.36	30.55	5.77	24.66	54.24	74.00	-19.76	PK
V	4824.00	44.36	30.55	5.77	24.66	44.24	54.00	-9.76	AV
V	7236.00	53.39	30.33	6.32	24.55	53.93	74.00	-20.07	PK
V	7236.00	44.12	30.33	6.32	24.55	44.66	54.00	-9.34	AV
V	9648.00	52.36	30.85	7.45	24.69	53.65	74.00	-20.35	PK
V	9648.00	42.16	30.85	7.45	24.69	43.45	54.00	-10.55	AV
V	12060.00	53.61	31.02	8.99	25.57	57.15	74.00	-16.85	PK
V	12060.00	42.18	31.02	8.99	25.57	45.72	54.00	-8.28	AV
H	4824.00	54.36	30.55	5.77	24.66	54.24	74.00	-19.76	PK
H	4824.00	44.59	30.55	5.77	24.66	44.47	54.00	-9.53	AV
H	7236.00	52.36	30.33	6.32	24.55	52.9	74.00	-21.10	PK
H	7236.00	42.35	30.33	6.32	24.55	42.89	54.00	-11.11	AV
H	9648.00	53.62	30.85	7.45	24.69	54.91	74.00	-19.09	PK
H	9648.00	43.16	30.85	7.45	24.69	44.45	54.00	-9.55	AV
H	12060.00	51.27	31.02	8.99	25.57	54.81	74.00	-19.19	PK
H	12060.00	42.36	31.02	8.99	25.57	45.9	54.00	-8.10	AV

Polar (H/V)	Frequency	Meter Reading	Pre-amplifier	Cable Loss	Antenna Factor	Emission Level	Limits	Margin	Detect or Type
	(MHz)	(dBuV)	(dB)	(dB)	(dB)	(dBuV/m)	(dBuV/m)	(dB)	
Middle Channel:2437MHz									
V	4874.00	53.62	30.55	5.77	24.66	53.5	74.00	-20.5	PK
V	4874.00	43.11	30.55	5.77	24.66	42.99	54.00	-11.01	AV
V	7311.00	52.29	30.33	6.32	24.55	52.83	74.00	-21.17	PK
V	7311.00	43.62	30.33	6.32	24.55	44.16	54.00	-9.84	AV
V	9748.00	53.16	30.85	7.45	24.69	54.45	74.00	-19.55	PK
V	9748.00	41.27	30.85	7.45	24.69	42.56	54.00	-11.44	AV
V	12185.00	52.11	31.02	8.99	25.57	55.65	74.00	-18.35	PK
V	12185.00	42.36	31.02	8.99	25.57	45.9	54.00	-8.1	AV
H	4874.00	53.16	30.55	5.77	24.66	53.04	74.00	-20.96	PK
H	4874.00	42.36	30.55	5.77	24.66	42.24	54.00	-11.76	AV
H	7311.00	51.28	30.33	6.32	24.55	51.82	74.00	-22.18	PK
H	7311.00	43.25	30.33	6.32	24.55	43.79	54.00	-10.21	AV
H	9748.00	54.27	30.85	7.45	24.69	55.56	74.00	-18.44	PK
H	9748.00	42.69	30.85	7.45	24.69	43.98	54.00	-10.02	AV
H	12185.00	53.61	31.02	8.99	25.57	57.15	74.00	-16.85	PK
H	12185.00	43.69	31.02	8.99	25.57	47.23	54.00	-6.77	AV

Polar (H/V)	Frequency	Meter Reading	Pre-ampli fier	Cable Loss	Antenna Factor	Emission Level	Limits	Margin	Detect or Type
	(MHz)	(dBuV)	(dB)	(dB)	(dB)	(dBuV/m)	(dBuV/ m)	(dB)	
High Channel:2462MHz									
V	4924.00	53.64	30.55	5.77	24.66	53.52	74.00	-20.48	PK
V	4924.00	42.18	30.55	5.77	24.66	42.06	54.00	-11.94	AV
V	7386.00	53.61	30.33	6.32	24.55	54.15	74.00	-19.85	PK
V	7386.00	42.17	30.33	6.32	24.55	42.71	54.00	-11.29	AV
V	9848.00	53.61	30.85	7.45	24.69	54.9	74.00	-19.1	PK
V	9848.00	42.11	30.85	7.45	24.69	43.4	54.00	-10.6	AV
V	12310.00	52.63	31.02	8.99	25.57	56.17	74.00	-17.83	PK
V	12310.00	42.36	31.02	8.99	25.57	45.9	54.00	-8.1	AV
H	4924.00	53.62	30.55	5.77	24.66	53.5	74.00	-20.5	PK
H	4924.00	45.62	30.55	5.77	24.66	45.5	54.00	-8.5	AV
H	7386.00	54.16	30.33	6.32	24.55	54.7	74.00	-19.3	PK
H	7386.00	43.61	30.33	6.32	24.55	44.15	54.00	-9.85	AV
H	9848.00	51.29	30.85	7.45	24.69	52.58	74.00	-21.42	PK
H	9848.00	42.16	30.85	7.45	24.69	43.45	54.00	-10.55	AV
H	12310.00	53.61	31.02	8.99	25.57	57.15	74.00	-16.85	PK
H	12310.00	42.17	31.02	8.99	25.57	45.71	54.00	-8.29	AV

Remark:

1. Emission Level = Meter Reading + Antenna Factor + Cable Loss – Pre-amplifier,

Margin= Emission Level - Limit

2. If peak below the average limit, the average emission was no test.

3. The amplitude of spurious emissions which are attenuated by more than 20dB below the permissible value has no need to be reported.

802.11g

Polar (H/V)	Frequency	Meter Reading	Pre-amplifier	Cable Loss	Antenna Factor	Emission Level	Limits	Margin	Detect or Type
	(MHz)	(dBuV)	(dB)	(dB)	(dB)	(dBuV/m)	(dBuV/m)	(dB)	
Low Channel:2412MHz									
V	4824.00	51.51	30.55	5.77	24.66	51.39	74.00	-22.61	PK
V	4824.00	42.07	30.55	5.77	24.66	41.95	54.00	-12.05	AV
V	7236.00	49.60	30.33	6.32	24.55	50.14	74.00	-23.86	PK
V	7236.00	42.08	30.33	6.32	24.55	42.62	54.00	-11.38	AV
V	9648.00	50.10	30.85	7.45	24.69	51.39	74.00	-22.61	PK
V	9648.00	42.08	30.85	7.45	24.69	43.37	54.00	-10.63	AV
V	12060.00	50.20	31.02	8.99	25.57	53.74	74.00	-20.26	PK
V	12060.00	41.98	31.02	8.99	25.57	45.52	54.00	-8.48	AV
H	4824.00	52.15	30.55	5.77	24.66	52.03	74.00	-21.97	PK
H	4824.00	41.70	30.55	5.77	24.66	41.58	54.00	-12.42	AV
H	7236.00	50.49	30.33	6.32	24.55	51.03	74.00	-22.97	PK
H	7236.00	41.75	30.33	6.32	24.55	42.29	54.00	-11.71	AV
H	9648.00	50.49	30.85	7.45	24.69	51.78	74.00	-22.22	PK
H	9648.00	41.75	30.85	7.45	24.69	43.04	54.00	-10.96	AV
H	12060.00	50.49	31.02	8.99	25.57	54.03	74.00	-19.97	PK
H	12060.00	40.75	31.02	8.99	25.57	44.29	54.00	-9.71	AV

Polar (H/V)	Frequency	Meter Reading	Pre-amplifier	Cable Loss	Antenna Factor	Emission Level	Limits	Margin	Detect or Type
	(MHz)	(dBuV)	(dB)	(dB)	(dB)	(dBuV/m)	(dBuV/m)	(dB)	
Middle Channel:2437MHz									
V	4874.00	50.51	30.55	5.77	24.66	50.39	74.00	-23.61	PK
V	4874.00	41.40	30.55	5.77	24.66	41.28	54.00	-12.72	AV
V	7311.00	49.04	30.33	6.32	24.55	49.58	74.00	-24.42	PK
V	7311.00	41.08	30.33	6.32	24.55	41.62	54.00	-12.38	AV
V	9748.00	49.11	30.85	7.45	24.69	50.4	74.00	-23.6	PK
V	9748.00	41.08	30.85	7.45	24.69	42.37	54.00	-11.63	AV
V	12185.00	49.01	31.02	8.99	25.57	52.55	74.00	-21.45	PK
V	12185.00	41.08	31.02	8.99	25.57	44.62	54.00	-9.38	AV
H	4874.00	51.87	30.55	5.77	24.66	51.75	74.00	-22.25	PK
H	4874.00	41.43	30.55	5.77	24.66	41.31	54.00	-12.69	AV
H	7311.00	52.58	30.33	6.32	24.55	53.12	74.00	-20.88	PK
H	7311.00	41.21	30.33	6.32	24.55	41.75	54.00	-12.25	AV
H	9748.00	52.58	30.85	7.45	24.69	53.87	74.00	-20.13	PK
H	9748.00	41.21	30.85	7.45	24.69	42.5	54.00	-11.5	AV
H	12185.00	53.08	31.02	8.99	25.57	56.62	74.00	-17.38	PK
H	12185.00	41.21	31.02	8.99	25.57	44.75	54.00	-9.25	AV

Polar (H/V)	Frequency	Meter Reading	Pre-ampl ifier	Cable Loss	Antenna Factor	Emission Level	Limits	Margin	Detect or Type
	(MHz)	(dBuV)	(dB)	(dB)	(dB)	(dBuV/m)	(dBuV/ m)	(dB)	
High Channel:2462MHz									
V	4924.00	50.23	30.55	5.77	24.66	50.11	74.00	-23.89	PK
V	4924.00	41.77	30.55	5.77	24.66	41.65	54.00	-12.35	AV
V	7386.00	52.74	30.33	6.32	24.55	53.28	74.00	-20.72	PK
V	7386.00	42.09	30.33	6.32	24.55	42.63	54.00	-11.37	AV
V	9848.00	52.74	30.85	7.45	24.69	54.03	74.00	-19.97	PK
V	9848.00	43.08	30.85	7.45	24.69	44.37	54.00	-9.63	AV
V	12310.00	53.14	31.02	8.99	25.57	56.68	74.00	-17.32	PK
V	12310.00	41.98	31.02	8.99	25.57	45.52	54.00	-8.48	AV
H	4924.00	50.32	30.55	5.77	24.66	50.20	74.00	-23.8	PK
H	4924.00	41.99	30.55	5.77	24.66	41.87	54.00	-12.13	AV
H	7386.00	51.91	30.33	6.32	24.55	52.45	74.00	-21.55	PK
H	7386.00	42.25	30.33	6.32	24.55	42.79	54.00	-11.21	AV
H	9848.00	52.51	30.85	7.45	24.69	53.80	74.00	-20.20	PK
H	9848.00	42.35	30.85	7.45	24.69	43.64	54.00	-10.36	AV
H	12310.00	53.11	31.02	8.99	25.57	56.65	74.00	-17.35	PK
H	12310.00	42.35	31.02	8.99	25.57	45.89	54.00	-8.11	AV

Remark:

1. Emission Level = Meter Reading + Antenna Factor + Cable Loss – Pre-amplifier,
Margin= Emission Level - Limit

2. If peak below the average limit, the average emission was no test.

3. The amplitude of spurious emissions which are attenuated by more than 20dB below the permissible value has no need to be reported.

802.11n20

Polar (H/V)	Frequency	Meter Reading	Pre-amplifier	Cable Loss	Antenna Factor	Emission Level	Limits	Margin	Detect or Type
	(MHz)	(dBuV)	(dB)	(dB)	(dB)	(dBuV/m)	(dBuV/m)	(dB)	
Low Channel:2412MHz									
V	4824.00	52.25	30.55	5.77	24.66	52.13	74.00	-21.87	PK
V	4824.00	41.96	30.55	5.77	24.66	41.84	54.00	-12.16	AV
V	7236.00	48.85	30.33	6.32	24.55	49.39	74.00	-24.61	PK
V	7236.00	42.95	30.33	6.32	24.55	43.49	54.00	-10.51	AV
V	9648.00	50.17	30.85	7.45	24.69	51.46	74.00	-22.54	PK
V	9648.00	42.36	30.85	7.45	24.69	43.65	54.00	-10.35	AV
V	12060.00	49.95	31.02	8.99	25.57	53.49	74.00	-20.51	PK
V	12060.00	42.31	31.02	8.99	25.57	45.85	54.00	-8.15	AV
H	4824.00	51.37	30.55	5.77	24.66	51.25	74.00	-22.75	PK
H	4824.00	42.33	30.55	5.77	24.66	42.21	54.00	-11.79	AV
H	7236.00	51.36	30.33	6.32	24.55	51.9	74.00	-22.1	PK
H	7236.00	41.46	30.33	6.32	24.55	42	54.00	-12	AV
H	9648.00	50.25	30.85	7.45	24.69	51.54	74.00	-22.46	PK
H	9648.00	42.36	30.85	7.45	24.69	43.65	54.00	-10.35	AV
H	12060.00	51.33	31.02	8.99	25.57	54.87	74.00	-19.13	PK
H	12060.00	41.52	31.02	8.99	25.57	45.06	54.00	-8.94	AV

Polar (H/V)	Frequency	Meter Reading	Pre-amplifier	Cable Loss	Antenna Factor	Emission Level	Limits	Margin	Detect or Type
	(MHz)	(dBuV)	(dB)	(dB)	(dB)	(dBuV/m)	(dBuV/m)	(dB)	
Middle Channel:2437MHz									
V	4874.00	51.23	30.55	5.77	24.66	51.11	74.00	-22.89	PK
V	4874.00	42.11	30.55	5.77	24.66	41.99	54.00	-12.01	AV
V	7311.00	48.06	30.33	6.32	24.55	48.6	74.00	-25.4	PK
V	7311.00	41.88	30.33	6.32	24.55	42.42	54.00	-11.58	AV
V	9748.00	50.02	30.85	7.45	24.69	51.31	74.00	-22.69	PK
V	9748.00	41.66	30.85	7.45	24.69	42.95	54.00	-11.05	AV
V	12185.00	49.95	31.02	8.99	25.57	53.49	74.00	-20.51	PK
V	12185.00	41.26	31.02	8.99	25.57	44.8	54.00	-9.2	AV
H	4874.00	51.36	30.55	5.77	24.66	51.24	74.00	-22.76	PK
H	4874.00	41.36	30.55	5.77	24.66	41.24	54.00	-12.76	AV
H	7311.00	53.22	30.33	6.32	24.55	53.76	74.00	-20.24	PK
H	7311.00	41.96	30.33	6.32	24.55	42.5	54.00	-11.5	AV
H	9748.00	53.26	30.85	7.45	24.69	54.55	74.00	-19.45	PK
H	9748.00	41.26	30.85	7.45	24.69	42.55	54.00	-11.45	AV
H	12185.00	53.33	31.02	8.99	25.57	56.87	74.00	-17.13	PK
H	12185.00	42.33	31.02	8.99	25.57	45.87	54.00	-8.13	AV

Polar (H/V)	Frequency	Meter Reading	Pre-ampl ifier	Cable Loss	Antenna Factor	Emission Level	Limits	Margin	Detect or Type
	(MHz)	(dBuV)	(dB)	(dB)	(dB)	(dBuV/m)	(dBuV/ m)	(dB)	
High Channel:2462MHz									
V	4924.00	50.31	30.55	5.77	24.66	50.19	74.00	-23.81	PK
V	4924.00	41.20	30.55	5.77	24.66	41.08	54.00	-12.92	AV
V	7386.00	49.01	30.33	6.32	24.55	49.55	74.00	-24.45	PK
V	7386.00	41.03	30.33	6.32	24.55	41.57	54.00	-12.43	AV
V	9848.00	49.09	30.85	7.45	24.69	50.38	74.00	-23.62	PK
V	9848.00	41.05	30.85	7.45	24.69	42.34	54.00	-11.66	AV
V	12310.00	49.07	31.02	8.99	25.57	52.61	74.00	-21.39	PK
V	12310.00	41.06	31.02	8.99	25.57	44.6	54.00	-9.4	AV
H	4924.00	51.57	30.55	5.77	24.66	51.45	74.00	-22.55	PK
H	4924.00	41.33	30.55	5.77	24.66	41.21	54.00	-12.79	AV
H	7386.00	52.28	30.33	6.32	24.55	52.82	74.00	-21.18	PK
H	7386.00	41.11	30.33	6.32	24.55	41.65	54.00	-12.35	AV
H	9848.00	52.48	30.85	7.45	24.69	53.77	74.00	-20.23	PK
H	9848.00	41.11	30.85	7.45	24.69	42.4	54.00	-11.6	AV
H	12310.00	53.03	31.02	8.99	25.57	56.57	74.00	-17.43	PK
H	12310.00	41.11	31.02	8.99	25.57	44.65	54.00	-9.35	AV

Remark:

1. Emission Level = Meter Reading + Antenna Factor + Cable Loss – Pre-amplifier,
Margin= Emission Level - Limit
2. If peak below the average limit, the average emission was no test.
3. The amplitude of spurious emissions which are attenuated by more than 20dB below the permissible value has no need to be reported.

5. RADIATED BAND EMISSION MEASUREMENT

5.1 TEST REQUIREMENT:

Test Requirement:	FCC Part15 C Section 15.209 and 15.205				
Test Method:	ANSI C63.10: 2013				
Test Frequency Range:	All of the restrict bands were tested, only the worst band's (2310MHz to 2500MHz) data was showed.				
Test site:	Measurement Distance: 3m				
Receiver setup:	Frequency	Detector	RBW	VBW	Value
	Above 1GHz	Peak	1MHz	3MHz	Peak
		Average	1MHz	3MHz	Average

LIMITS OF RADIATED EMISSION MEASUREMENT (Above 1000MHz)

FREQUENCY (MHz)	Class B (dBuV/m) (at 3M)	
	PEAK	AVERAGE
Above 1000	74	54

Notes:

- (1) The limit for radiated test was performed according to FCC PART 15C.
- (2) The tighter limit applies at the band edges.
- (3) Emission level (dBuV/m)=20log Emission level (uV/m).

5.2 TEST PROCEDURE

Above 1GHz test procedure as below:

- a. 1. The EUT was placed on the top of a rotating table 1.5 meters above the ground at a 3 meter camber. The table was rotated 360 degrees to determine the position of the highest radiation.
- b. The EUT was set 3 meters away from the interference-receiving antenna, which was mounted on the top of a variable-height antenna tower.
- c. The antenna height is varied from one meter to four meters above the ground to determine the maximum value of the field strength. Both horizontal and vertical polarizations of the antenna are set to make the measurement.
- d. For each suspected emission, the EUT was arranged to its worst case and then the antenna was tuned to heights from 1 meter to 4 meters and the rota table was turned from 0 degrees to 360 degrees to find the maximum reading.
- e. The test-receiver system was set to Peak Detect Function and Specified Bandwidth with Maximum Hold Mode.
- f. If the emission level of the EUT in peak mode was 10dB lower than the limit specified, then testing could be stopped and the peak values of the EUT would be reported. Otherwise the emissions that did not have 10dBmargin would be re-tested one by one using peak, quasi-peak or average method as specified and then reported in a data sheet.
- g. Test the EUT in the lowest channel, the Highest channel

Note:

Both horizontal and vertical antenna polarities were tested and performed pretest to three orthogonal axis. The worst case emissions were reported

5.3 DEVIATION FROM TEST STANDARD

No deviation

5.4 TEST SETUP

Radiated Emission Test-Up Frequency Above 1GHz

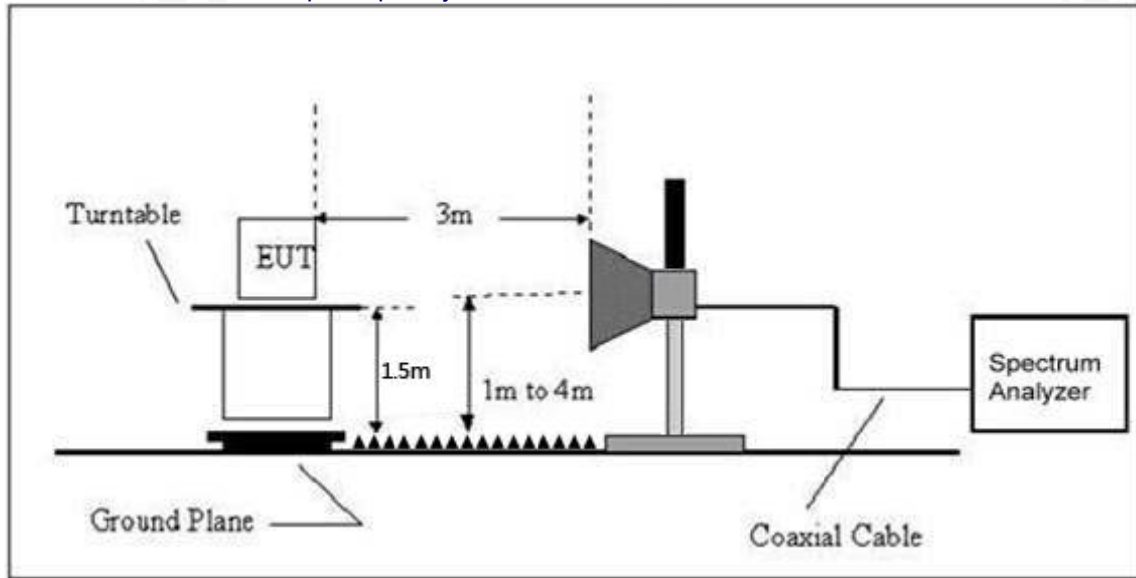

5.5 EUT OPERATING CONDITIONS

The EUT tested system was configured as the statements of 2.3 Unless otherwise a special operating condition is specified in the follows during the testing.

5.6 TEST RESULT

	Polar (H/V)	Frequency (MHz)	Meter Reading (dBuV)	Pre-amplifier (dB)	Cable Loss (dB)	Antenna Factor (dB/m)	Emission level (dBuV/m)	Limit (dBuV/m)	Detector Type	Result
802.11b	Low Channel 2412MHz									
	H	2390.00	59.53	30.22	4.85	23.98	58.14	74.00	PK	PASS
	H	2390.00	51.36	30.22	4.85	23.98	49.97	54.00	AV	PASS
	H	2400.00	61.26	30.22	4.85	23.98	59.87	74.00	PK	PASS
	H	2400.00	51.36	30.22	4.85	23.98	49.97	54.00	AV	PASS
	V	2390.00	59.38	30.22	4.85	23.98	57.99	74.00	PK	PASS
	V	2390.00	51.26	30.22	4.85	23.98	49.87	54.00	AV	PASS
	V	2400.00	61.11	30.22	4.85	23.98	59.72	74.00	PK	PASS
	V	2400.00	51.36	30.22	4.85	23.98	49.97	54.00	AV	PASS
	High Channel 2462MHz									
	H	2483.50	59.22	30.22	4.85	23.98	57.83	74.00	PK	PASS
	H	2485.50	50.26	30.22	4.85	23.98	48.87	54.00	AV	PASS
	H	2483.50	60.69	30.22	4.85	23.98	59.3	74.00	PK	PASS
	H	2485.50	51.14	30.22	4.85	23.98	49.75	54.00	AV	PASS
	V	2483.50	60.03	30.22	4.85	23.98	58.64	74.00	PK	PASS
	V	2485.50	51.63	30.22	4.85	23.98	50.24	54.00	AV	PASS
V	2483.50	60.22	30.22	4.85	23.98	58.83	74.00	PK	PASS	
V	2485.50	51.11	30.22	4.85	23.98	49.72	54.00	AV	PASS	
802.11g	Low Channel 2412MHz									
	H	2390.00	59.03	30.22	4.85	23.98	57.64	74.00	PK	PASS
	H	2390.00	51.26	30.22	4.85	23.98	49.87	54.00	AV	PASS
	H	2400.00	61.06	30.22	4.85	23.98	59.67	74.00	PK	PASS
	H	2400.00	51.16	30.22	4.85	23.98	49.77	54.00	AV	PASS
	V	2390.00	59.28	30.22	4.85	23.98	57.89	74.00	PK	PASS
	V	2390.00	51.06	30.22	4.85	23.98	49.67	54.00	AV	PASS
	V	2400.00	61.01	30.22	4.85	23.98	59.62	74.00	PK	PASS
	V	2400.00	51.06	30.22	4.85	23.98	49.67	54.00	AV	PASS
	High Channel 2462MHz									
	H	2483.50	60.33	30.22	4.85	23.98	58.94	74.00	PK	PASS
	H	2485.50	52.06	30.22	4.85	23.98	50.67	54.00	AV	PASS
	H	2483.50	62.16	30.22	4.85	23.98	60.77	74.00	PK	PASS
	H	2485.50	52.26	30.22	4.85	23.98	50.87	54.00	AV	PASS
	V	2483.50	60.23	30.22	4.85	23.98	58.84	74.00	PK	PASS
	V	2485.50	52.16	30.22	4.85	23.98	50.77	54.00	AV	PASS
V	2483.50	62.21	30.22	4.85	23.98	60.82	74.00	PK	PASS	
V	2485.50	52.33	30.22	4.85	23.98	50.94	54.00	AV	PASS	
802.11n20	Low Channel 2412MHz									
	H	2390.00	60.12	30.22	4.85	23.98	58.73	74.00	PK	PASS
	H	2390.00	52.35	30.22	4.85	23.98	50.96	54.00	AV	PASS
	H	2400.00	61.21	30.22	4.85	23.98	59.82	74.00	PK	PASS
	H	2400.00	52.13	30.22	4.85	23.98	50.74	54.00	AV	PASS
	V	2390.00	60.24	30.22	4.85	23.98	58.85	74.00	PK	PASS
	V	2390.00	52.24	30.22	4.85	23.98	50.85	54.00	AV	PASS
	V	2400.00	61.21	30.22	4.85	23.98	59.82	74.00	PK	PASS
	V	2400.00	53.21	30.22	4.85	23.98	51.82	54.00	AV	PASS
	High Channel 2462MHz									
	H	2483.50	59.33	30.22	4.85	23.98	57.94	74.00	60.35	PASS
	H	2485.50	51.06	30.22	4.85	23.98	49.67	54.00	51.68	PASS
	H	2483.50	61.16	30.22	4.85	23.98	59.77	74.00	61.22	PASS
	H	2485.50	51.26	30.22	4.85	23.98	49.87	54.00	53.24	PASS
	V	2483.50	59.23	30.22	4.85	23.98	57.84	74.00	61.03	PASS
	V	2485.50	51.16	30.22	4.85	23.98	49.77	54.00	52.45	PASS
V	2483.50	61.21	30.22	4.85	23.98	59.82	74.00	61.22	PASS	

	V	2485.50	52.36	30.22	4.85	23.98	50.97	54.00	52.36	PASS
Remark: 1. Emission Level = Meter Reading + Antenna Factor + Cable Loss – Pre-amplifier, Margin= Emission Level - Limit										

6. POWER SPECTRAL DENSITY TEST

Test Requirement:	FCC Part15 C Section 15.247 (e)
Test Method:	KDB558074 D0115.247 Meas Guidancev05r02

6.1 APPLIED PROCEDURES / LIMIT

FCC Part15 (15.247) , Subpart C				
Section	Test Item	Limit	Frequency Range (MHz)	Result
15.247	Power Spectral Density	8dBm/3kHz	2400-2483.5	PASS

6.2 TEST PROCEDURE

1. Set analyzer center frequency to DTS channel center frequency.
2. Set the span to 1.5 times the DTS bandwidth.
3. Set the RBW to: $3 \text{ kHz} \leq \text{RBW} \leq 100 \text{ kHz}$.
4. Set the VBW $\geq 3 \times \text{RBW}$.
5. Detector = peak.
6. Sweep time = auto couple.
7. Trace mode = max hold.
8. Allow trace to fully stabilize.
9. Use the peak marker function to determine the maximum amplitude level within the RBW.
10. If measured value exceeds limit, reduce RBW (no less than 3 kHz) and repeat.

6.3 DEVIATION FROM STANDARD

No deviation.

6.4 TEST SETUP



6.5 EUT OPERATION CONDITIONS

The EUT tested system was configured as the statements of 2.1 Unless otherwise a special operating condition is specified in the follows during the testing.

6.6 TEST RESULT

Temperature :	26°C	Relative Humidity :	54%
Pressure :	101kPa	Test Voltage :	DC 12V
Test Mode :	TX b Mode		

Frequency	Power Spectral Density (dBm/3kHz)	Limit (dBm/3kHz)	Result
2412 MHz	-21.038	8	PASS
2437 MHz	-20.780	8	PASS
2462 MHz	-20.334	8	PASS

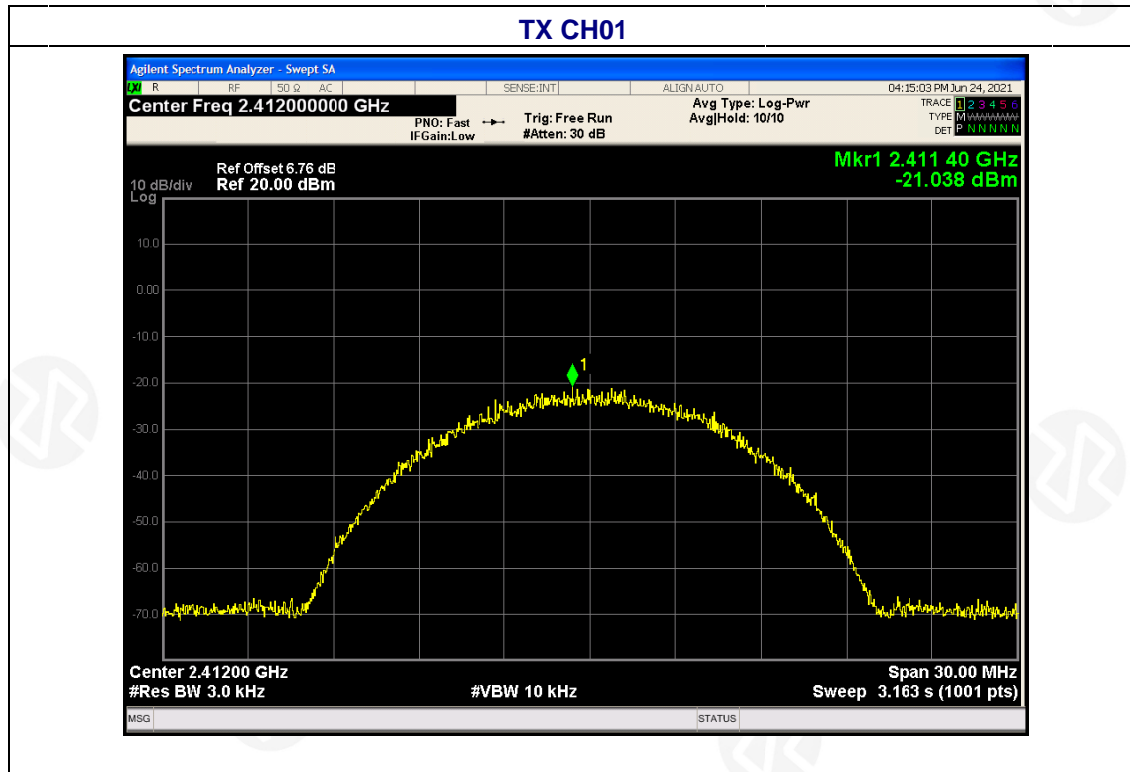

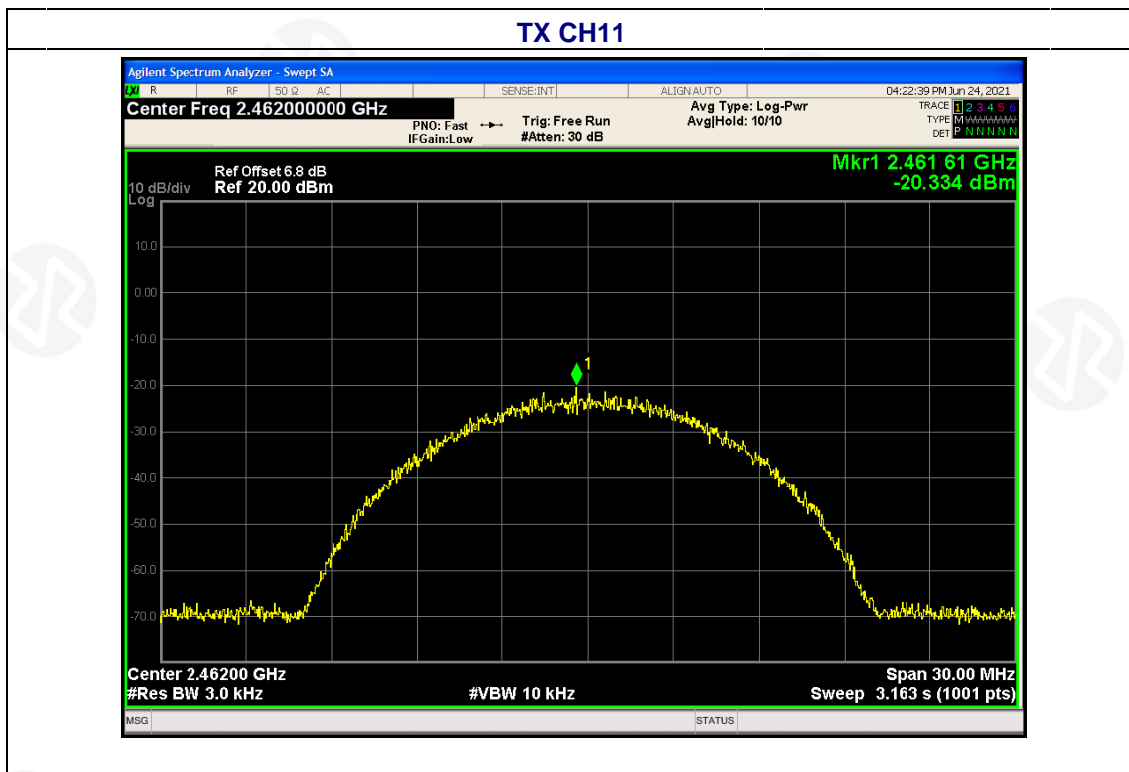
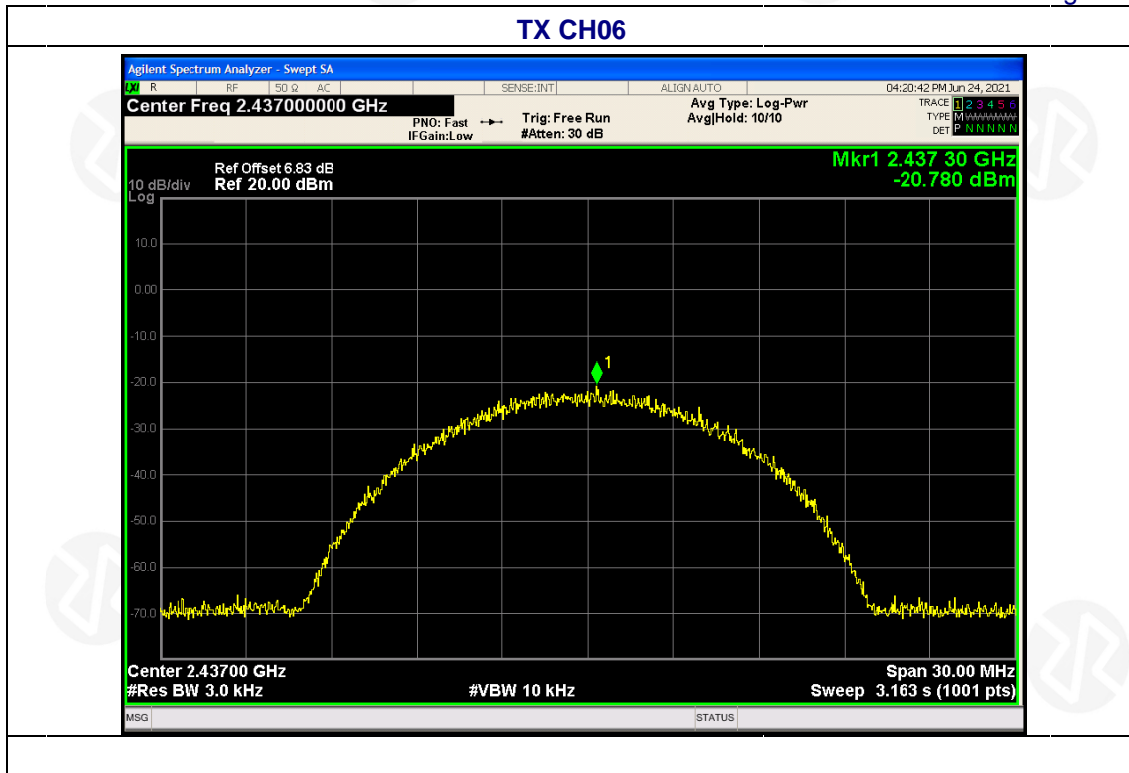

Temperature :	26°C	Relative Humidity :	54%
Pressure :	101kPa	Test Voltage :	DC 12V
Test Mode :	TX g Mode		

Frequency	Power Spectral Density (dBm/3kHz)	Limit (dBm/3kHz)	Result
2412 MHz	-23.725	8	PASS
2437 MHz	-20.332	8	PASS
2462 MHz	-25.106	8	PASS

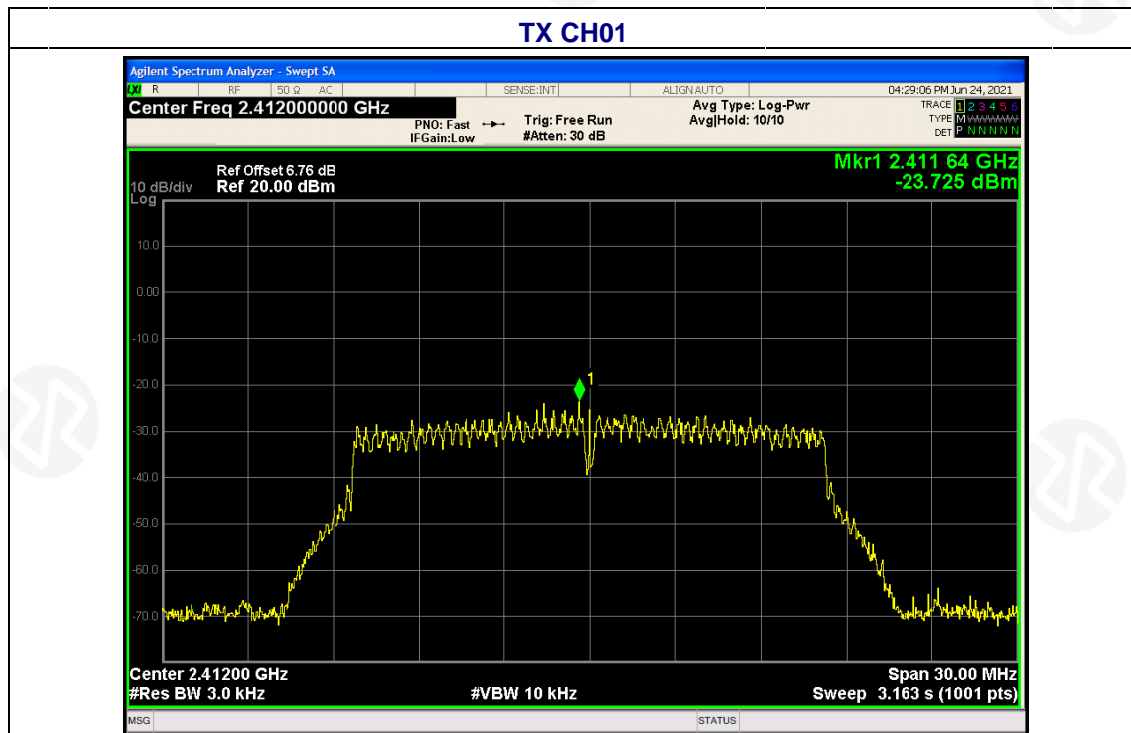

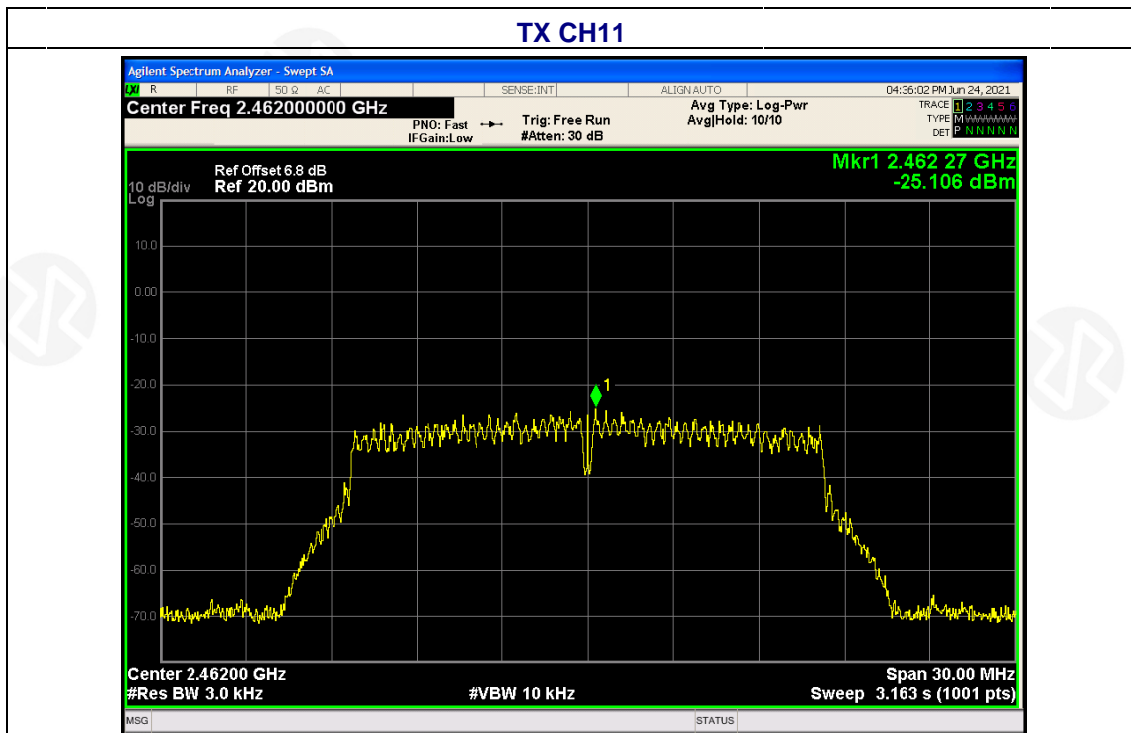
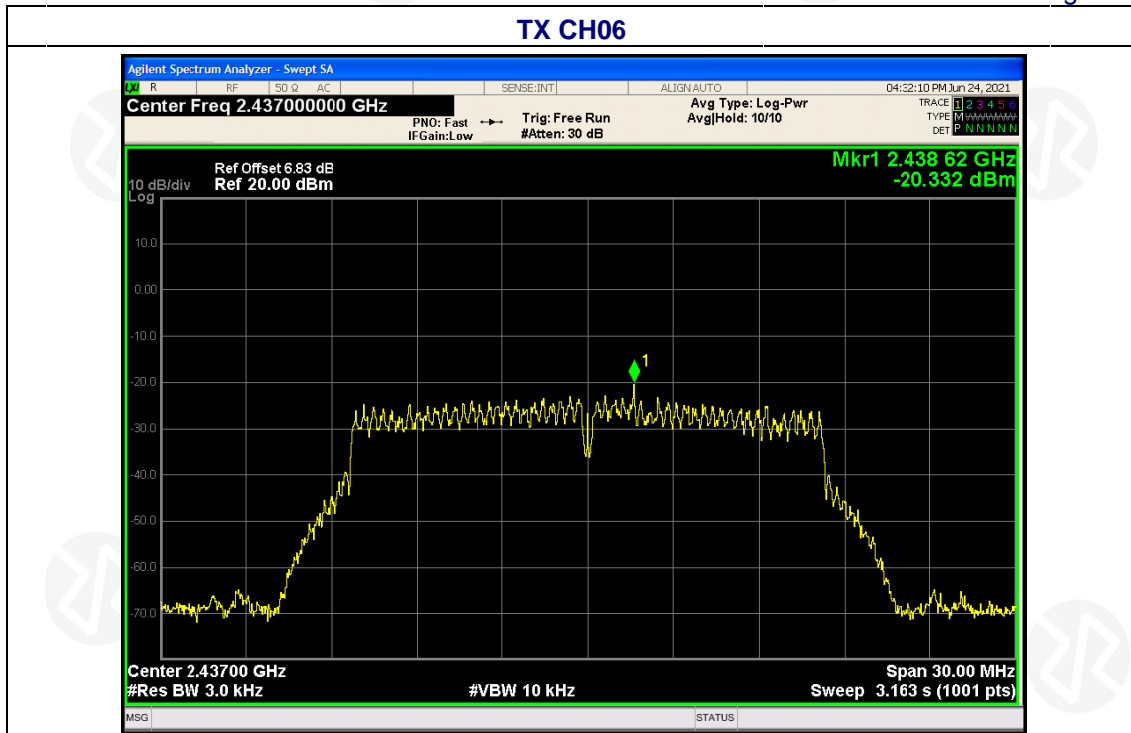

Temperature :	26°C	Relative Humidity :	54%
Pressure :	101kPa	Test Voltage :	DC 12V
Test Mode :	TX n Mode(20M)		

Frequency	Power Spectral Density (dBm/3kHz)	Limit (dBm/3kHz)	Result
2412 MHz	-25.905	8	PASS
2437 MHz	-25.637	8	PASS
2462 MHz	-26.311	8	PASS

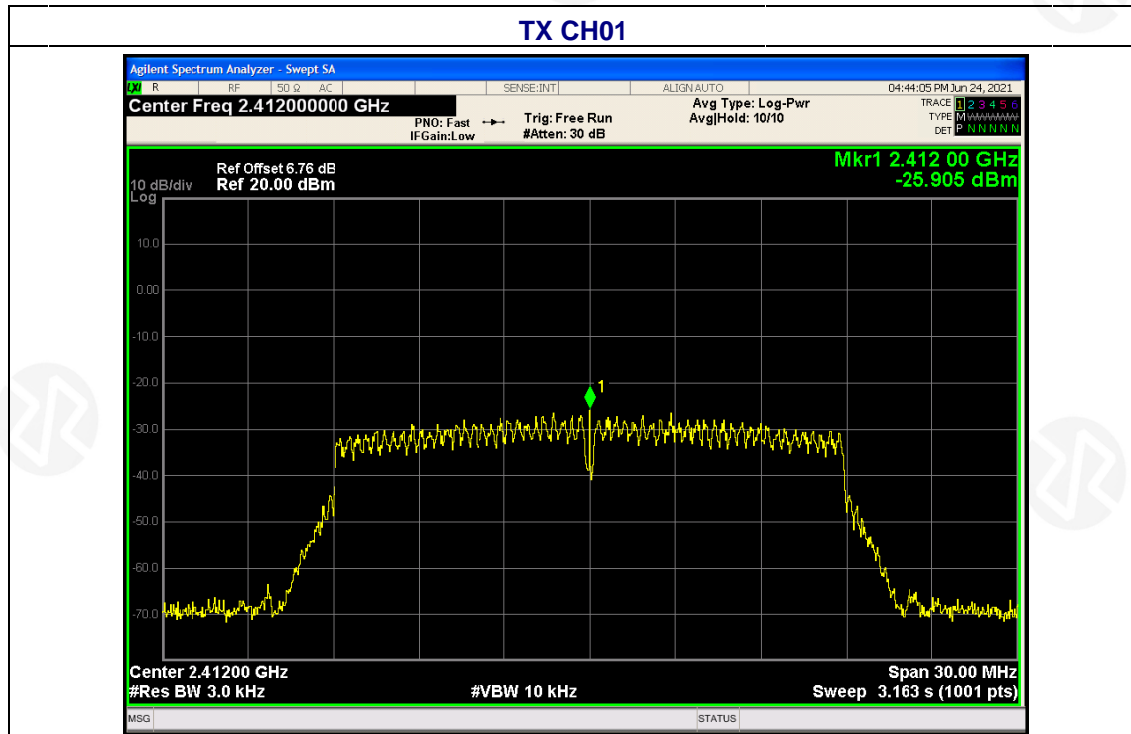

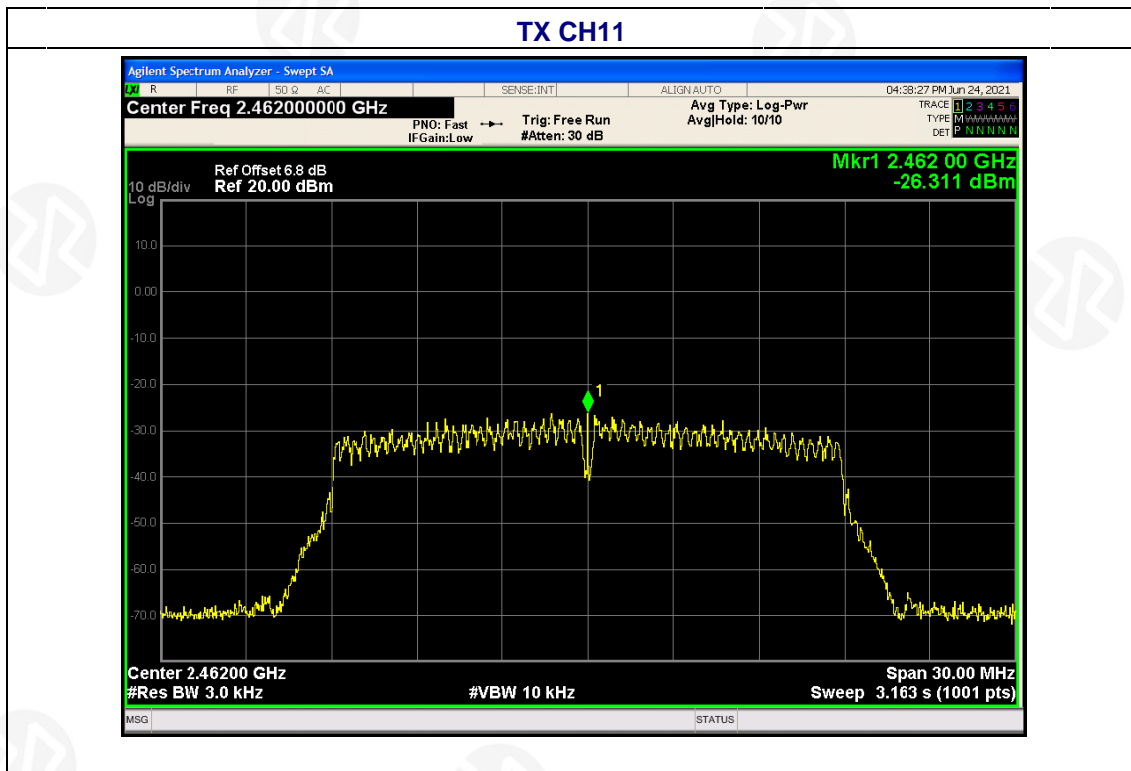
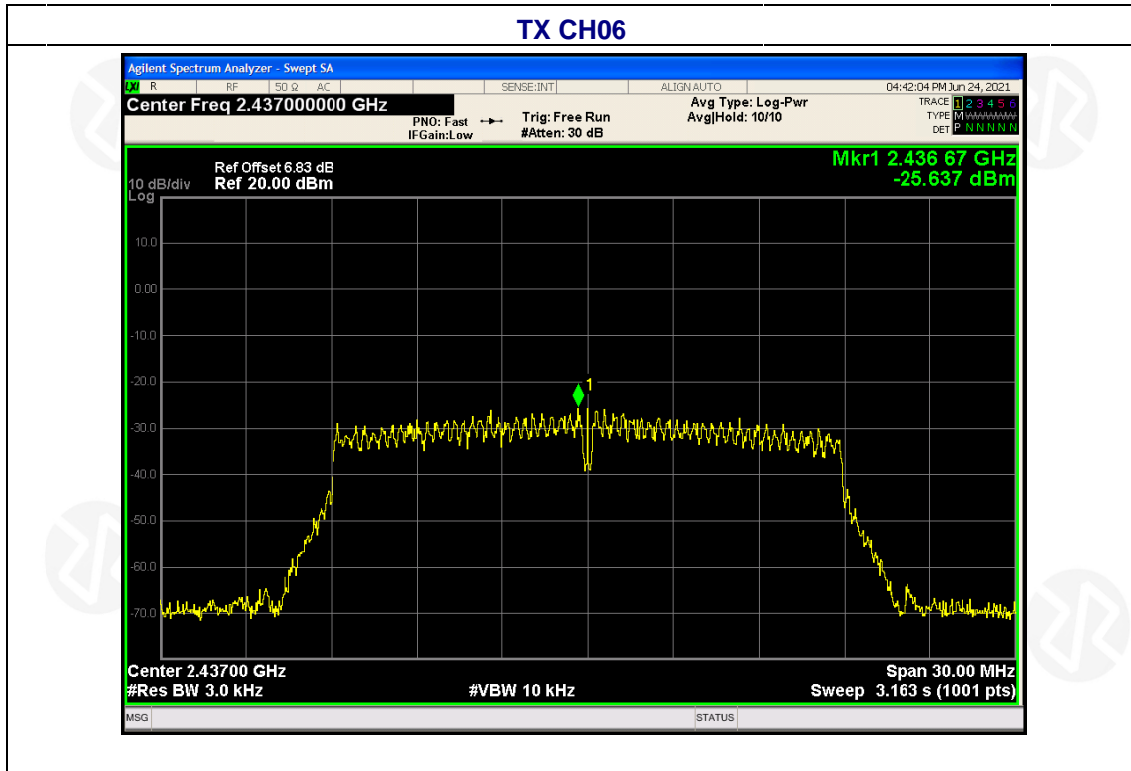

7. CHANNEL BANDWIDTH& 99% OCCUPY BANDWIDTH

Test Requirement:	FCC Part15 C Section 15.247 (a)(2)
Test Method:	KDB558074 D0115.247 Meas Guidancev05r02

7.1 APPLIED PROCEDURES / LIMIT

FCC Part15 (15.247) , Subpart C				
Section	Test Item	Limit	Frequency Range (MHz)	Result
15.247(a)(2)	Bandwidth	$\geq 500\text{KHz}$ (6dB bandwidth)	2400-2483.5	PASS

7.2 TEST PROCEDURE

1. Set RBW = 100 kHz.
2. Set the video bandwidth (VBW) $\geq 3 \times \text{RBW}$.
3. Detector = Peak.
4. Trace mode = max hold.
5. Sweep = auto couple.
6. Allow the trace to stabilize.
7. Measure the maximum width of the emission that is constrained by the frequencies associated with the two outermost amplitude points (upper and lower frequencies) that are attenuated by 6 dB relative to the maximum level measured in the fundamental emission.

7.3 DEVIATION FROM STANDARD

No deviation.

7.4 TEST SETUP

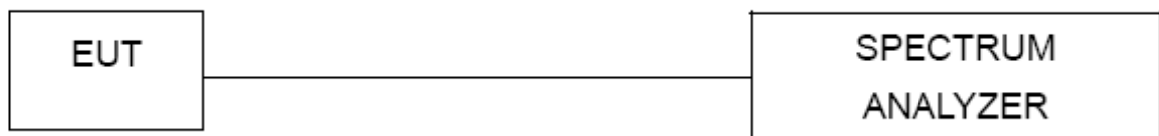

7.5 EUT OPERATION CONDITIONS

The EUT tested system was configured as the statements of 2.4 Unless otherwise a special operating condition is specified in the follows during the testing.

7.6 TEST RESULT

Temperature :	26°C	Relative Humidity :	54%
Pressure :	101kPa	Test Voltage :	DC 12V
Test Mode :	TX b Mode		

Test CH	802.11b	802.11g	802.11n(HT20)	Limit(KHz)	Result
	Lowest	7.914	16.300		
Middle	8.127	13.730	15.030	>500	Pass
Highest	8.029	15.020	15.400		

Test CH	99% Occupy Bandwidth (MHz)			Result
	802.11b	802.11g	802.11n(HT20)	
Lowest	12.557	16.354	17.553	Pass
Middle	12.614	16.335	17.539	
Highest	12.610	16.338	17.537	

Test plot as follows:

802.11b

802.11g

Lowest channel

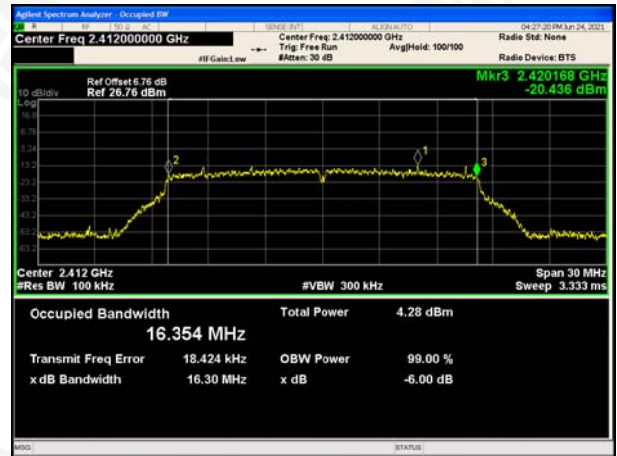
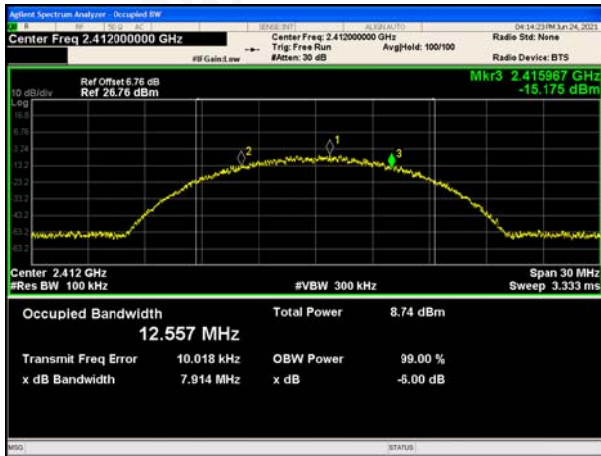

Middle channel

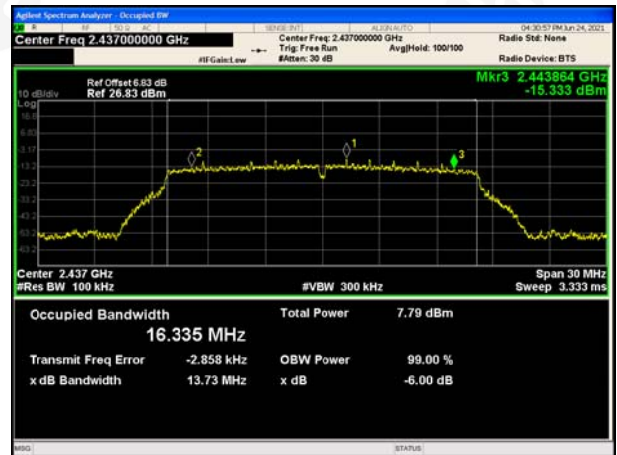
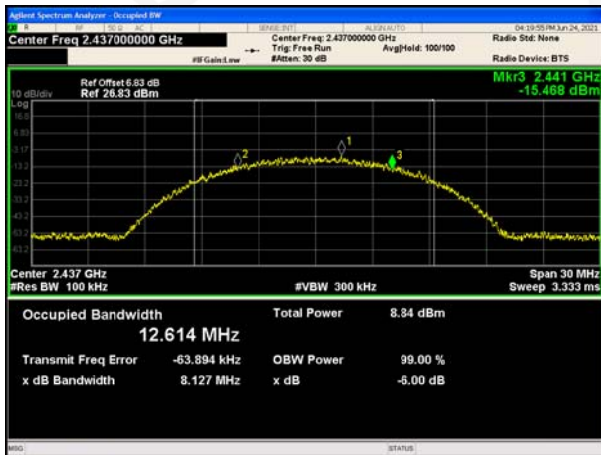

Highest channel

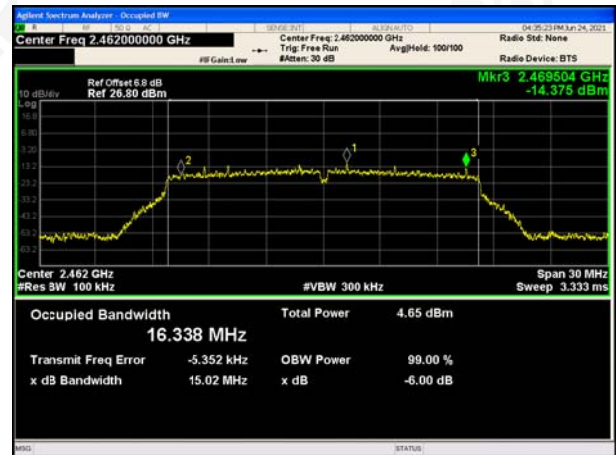
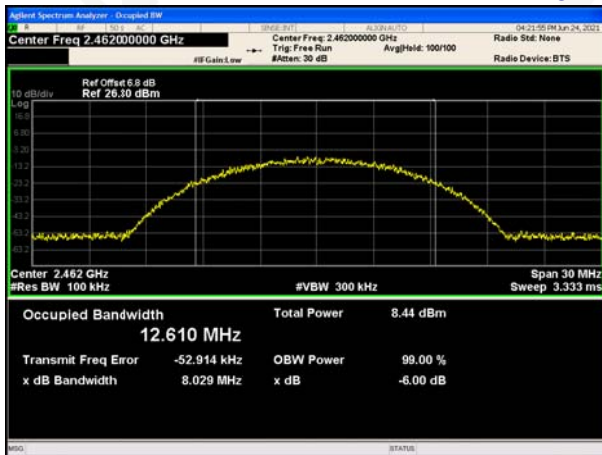

802.11n20

Lowest channel

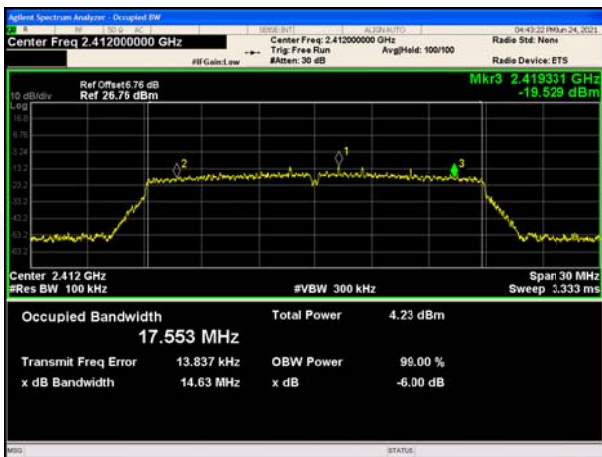

Middle channel

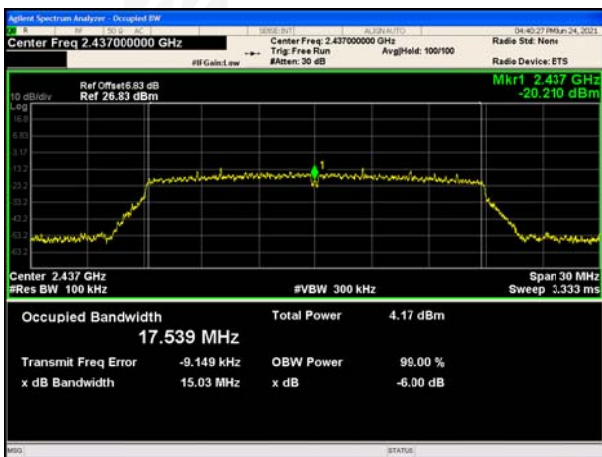

Highest channel

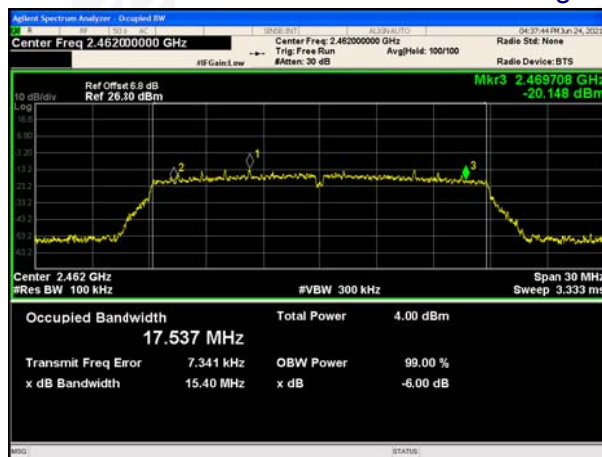

8. PEAK OUTPUT POWER TEST

Test Requirement:	FCC Part15 C Section 15.247 (b)(3)
Test Method:	KDB558074 D0115.247 Meas Guidancev05r02

8.1 APPLIED PROCEDURES/LIMIT

FCC Part15 (15.247) , Subpart C				
Section	Test Item	Limit	Frequency Range (MHz)	Result
15.247(b)(3)	Peak Output Power	1 watt or 30dBm	2400-2483.5	PASS

8.2 TEST PROCEDURE

- a. The EUT was directly connected to the Power meter

8.3 DEVIATION FROM STANDARD

No deviation.

8.4 TEST SETUP



8.5 EUT OPERATION CONDITIONS

The EUT tested system was configured as the statements of 2.4 Unless otherwise a special operating condition is specified in the follows during the testing.

8.6 TEST RESULT

Temperature :	26°C	Relative Humidity :	54%
Pressure :	101kPa	Test Voltage :	DC 12V

Test CH	Peak Output Power (dBm)				Result
	802.11b	802.11g	802.11n(HT20)	Limit(dBm)	
Lowest	8.235	7.452	6.565	30.00	Pass
Middle	8.138	7.289	6.528	30.00	
Highest	8.129	7.253	6.382	30.00	

9. CONDUCTED BAND EDGE AND SPURIOUS EMISSION

Test Requirement:	FCC Part15 C Section 15.247 (d)
Test Method:	KDB558074 D0115.247 Meas Guidancev05r02

9.1 APPLICABLE STANDARD

in any 100 kHz bandwidth outside the frequency bands in which the spread spectrum intentional radiator is operating, the radio frequency power that is produced by the intentional radiator shall be at least 20dB below that in the 100kHz bandwidth within the band that contains the highest level of the desired power, In addition, radiated emissions which fall in the restricted bands, as defined in§15.205(a), must also comply with the radiated emission limits specified in15.209(a).

9.2 TEST PROCEDURE

Using the following spectrum analyzer setting:

- A) Set the RBW = 100KHz.
- B) Set the VBW = 300KHz.
- C) Sweep time = auto couple.
- D) Detector function = peak.
- E) Trace mode = max hold.
- F) Allow trace to fully stabilize.

9.3 DEVIATION FROM STANDARD

No deviation.

9.4 TEST SETUP



9.5 EUT OPERATION CONDITIONS

The EUT tested system was configured as the statements of 2.4 Unless otherwise a special operating condition is specified in the follows during the testing.

9.6 TEST RESULTS

Test plot as follows:

Test mode: 802.11b

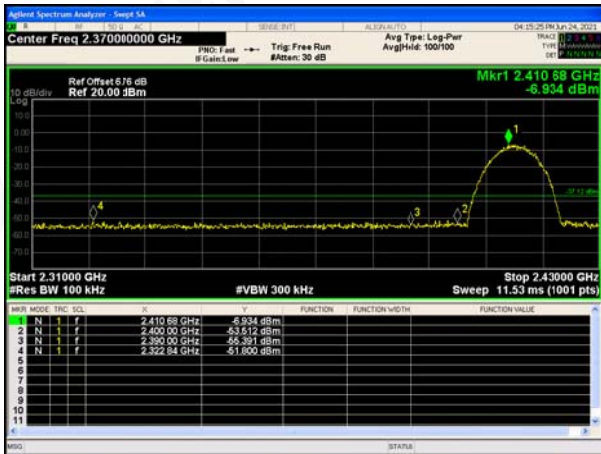

Lowest channel

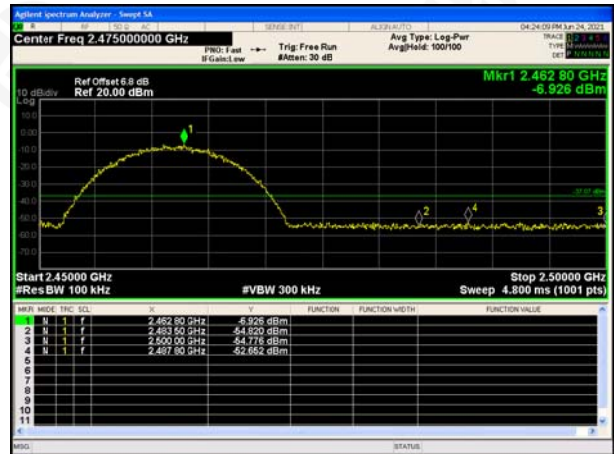

Highest channel

Test mode: 802.11g

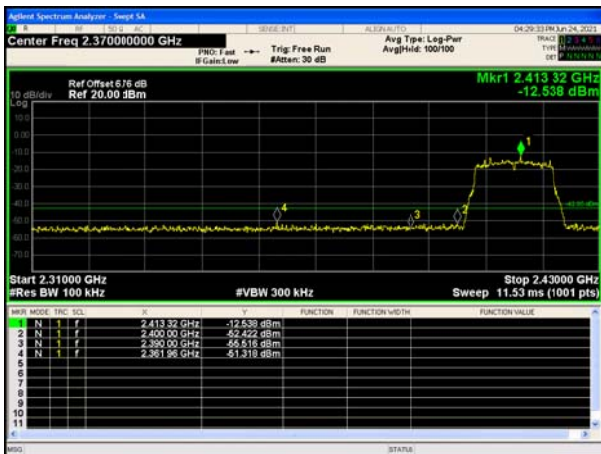

Lowest channel

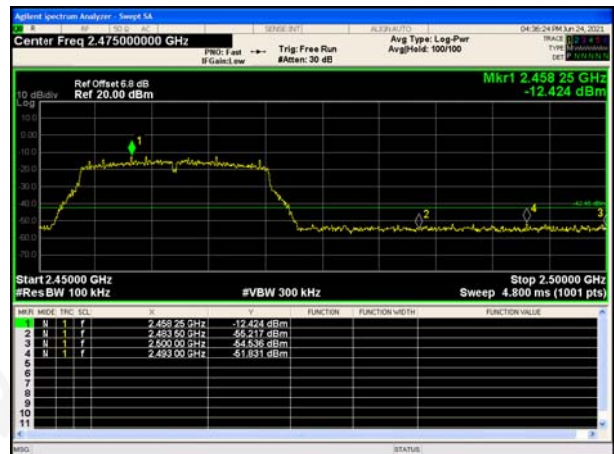

Highest channel

Test mode: 802.11n(HT20)



Lowest channel



Highest channel

Test plot as follows:

802.11b

Lowest channel

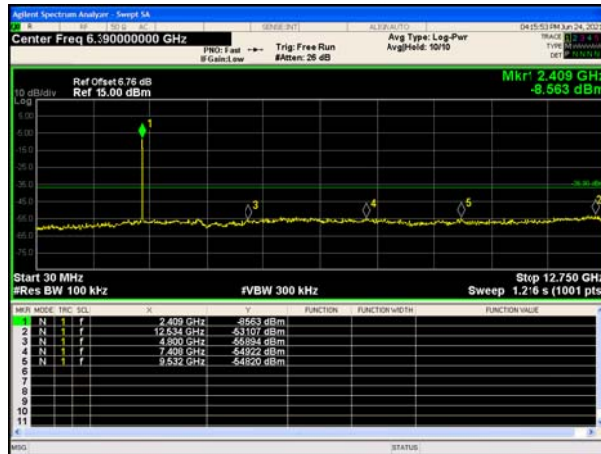

Middle channel

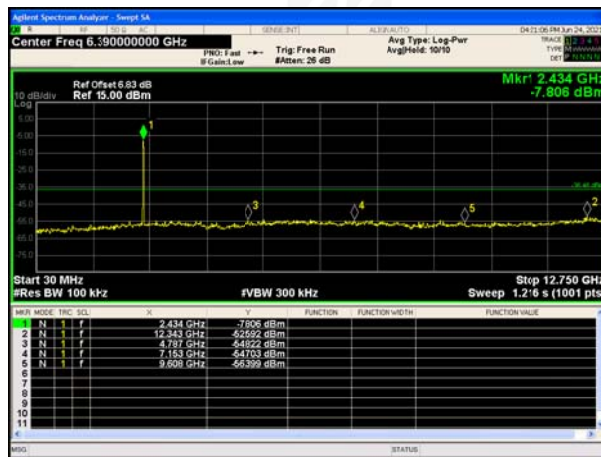

Highest channel

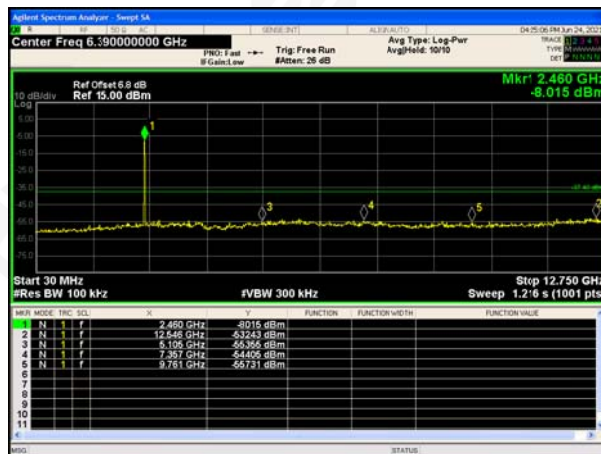

802.11g
Lowest channel

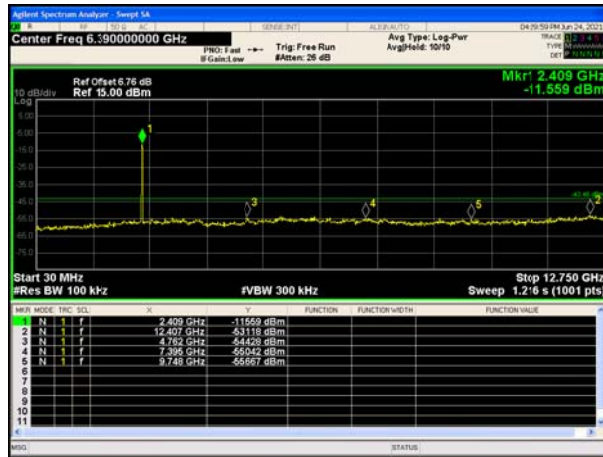

Middle channel

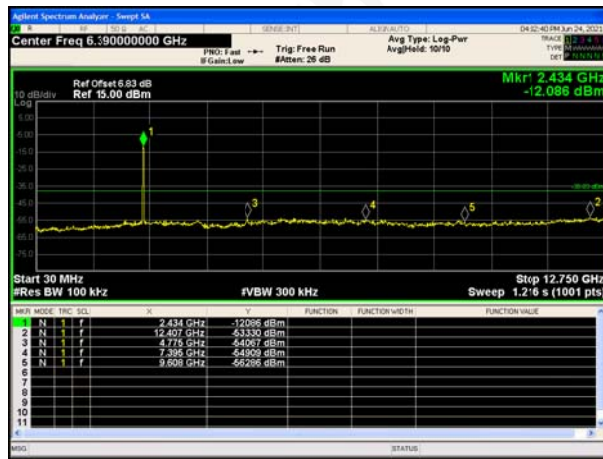

Highest channel

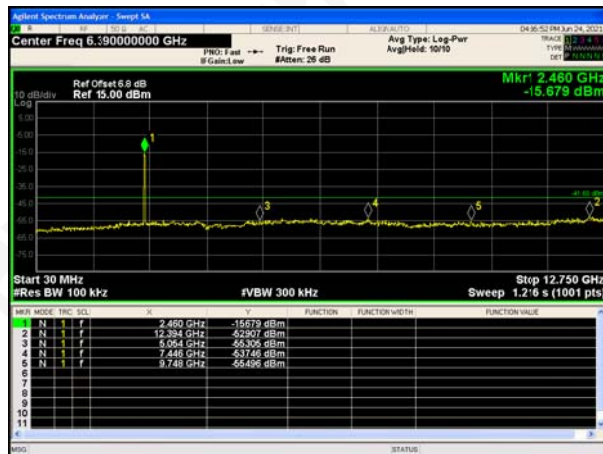

802.11n(HT20)
Lowest channel

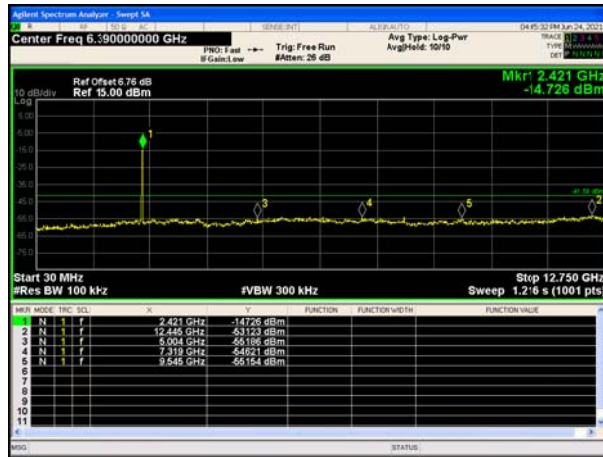

Middle channel

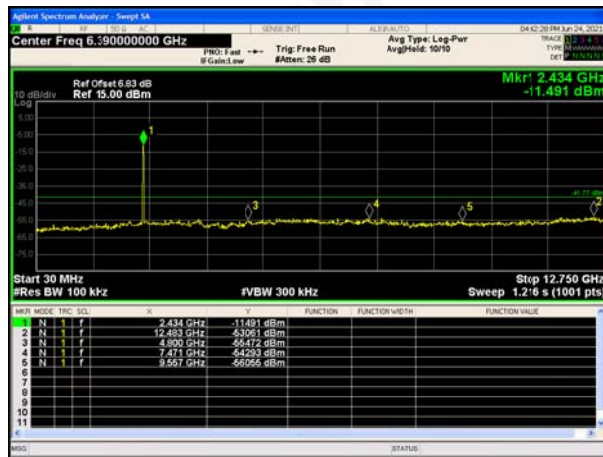

Highest channel

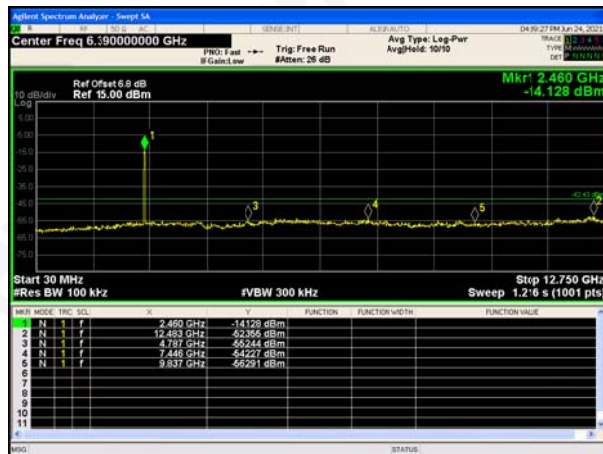

10. ANTENNA REQUIREMENT

Standard requirement:	FCC Part15 C Section 15.203 /247(c)
<p>15.203 requirement: An intentional radiator shall be designed to ensure that no antenna other than that furnished by the responsible party shall be used with the device. The use of a permanently attached antenna or of an antenna that uses a unique coupling to the intentional radiator, the manufacturer may design the unit so that a broken antenna can be replaced by the user, but the use of a standard antenna jack or electrical connector is prohibited.</p> <p>15.247(c) (1)(i) requirement: (i) Systems operating in the 2400-2483.5 MHz band that is used exclusively for fixed. Point-to-point operations may employ transmitting antennas with directional gain greater than 6dBi provided the maximum conducted output power of the intentional radiator is reduced by 1 dB for every 3 dB that the directional gain of the antenna exceeds 6dBi.</p>	
EUT Antenna:	
The antenna is FPCB Antenna, the best case gain of the antenna is 0dBi, reference to the appendix II for details	

11. TEST SETUP PHOTO

Reference to the appendix I for details.

12. EUT CONSTRUCTIONAL DETAILS

Reference to the appendix II for details.

***** END OF REPORT *****