

Boltune

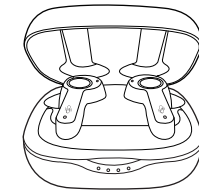

USER GUIDE

True Wireless Stereo Earbuds
Model: BT-BH020
FCC ID: 2AVUHBT-BH020V

PACKAGE CONTENTS (Fig. 1)

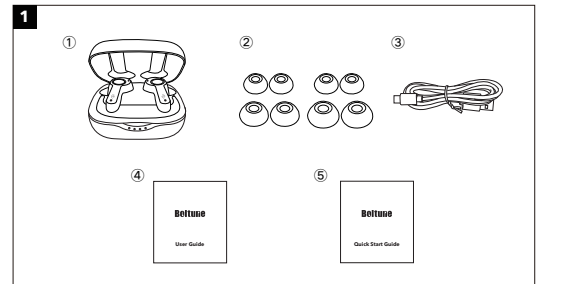

- 1 Boltune True Wireless Stereo Earbuds (BT-BH020)
- 2 8 x Ear Tips (two are equipped on the earbuds)
- 3 1 x USB-C Charging Cable
- 4 1 x User Guide
- 5 1 x Quick Start Guide

MIC ID, MIC Logo, Product name, trademark and model can be found on the charging box.

01

PRODUCT DIAGRAM (Fig. 2)

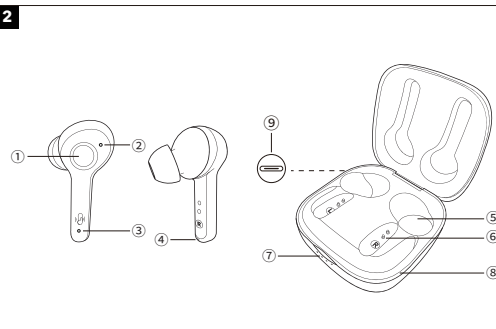

- 1 Multifunction Touch Control
- 2 Microphone
- 3 LED Indicator
- 4 Microphone
- 5 Charging Slot
- 6 Charging Contacts
- 7 Charging Indicators
- 8 Charging Case
- 9 USB-C Charging Port

02

IMPORTANT SAFETY INSTRUCTIONS

Please read the instructions thoroughly before using this product and retain it for future reference.

Hearing Safety

- Do not wear earbuds with high volume for a long time to avoid damaging your hearing.
- Set the earbuds to low volume before you put them on, then increase the volume gradually as per your preference.
- Do not set volume too high to stay aware of your surroundings.
- Please refer to local laws and regulations if you want to answer phone calls via this device during driving.
- For your safety, avoid distraction from music or phone calls when you are driving or doing other activities with potential dangers.

Warning: Please set the volume to proper level to avoid hearing damages.

Caution

- Do not expose this product to high temperatures.
- Do not immerse the earbuds into water or expose them to humidity for a long time.
- Do not clean the product with detergent containing alcohol, ammonia, benzene or abrasives.
- Avoid dropping.
- Place the earbuds back into the charging case when not in use and keep it

03

HOW TO WEAR

away from children and pets to avoid choking hazard.

- Unauthorized disassembly of any parts of this product is forbidden, which may cause fire hazard, warranty voidance, and/or property loss.
- Close attention is needed when using near children.
- Keep the charging case away from water, rain or any other liquid.
- Don't use the product in thunderstorm to avoid malfunction or electric shock.
- Always ask a professional technician or authorized personnel for repair.

Choose the Right Tips (Fig. 3)

Ear tips with different sizes are included in the package, try all sizes and choose the ones fitting you best.

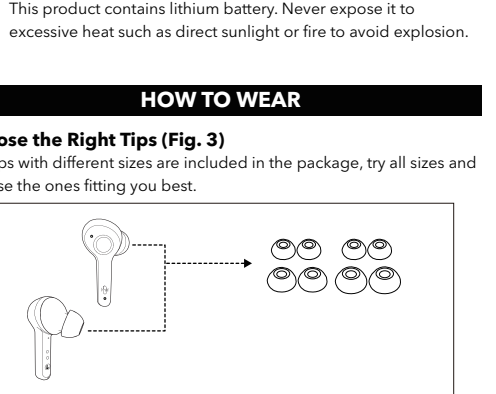

04

Wear the Earbuds (Fig. 4)

Please wear the earbuds as shown below.

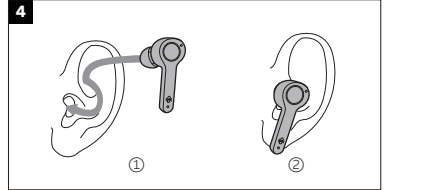

Pictures only for reference.

Bluetooth Caution

- When the device is connected wirelessly to another device, place the two devices close to each other to achieve their normal functionalities and avoid possible signal interference.
- When using a wireless connection, make sure there are no obstacles between the two devices. Obstacles including walls and fences may shorten the effective range.
- The maximum effective Bluetooth range may vary with the environmental circumstances.

05

USING YOUR EARBUDS

Charging the Earbuds

- Put the earbuds into the charging case as per the L (left) and R (right) marks (Fig. 5).
- Cover the lid and charging will start automatically (Fig. 6).

Note:

- Please fully charge the earbuds when using them for the first time.
- When battery is low, a "Battery low" voice prompt will be heard (if you are wearing the earbuds). Please charge it in time or the earbuds will turn off automatically around 10 minutes later.
- Charge the earbuds at least once every 3 months when not using for a long time.

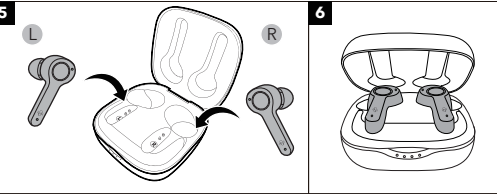

06

Charging the Charging Case

- Connect the charging port with any USB charging adapter or active computer USB port (Fig. 7).
 - The four charging indicators will light up progressively.
- Note:** Unplug the charging cable (timely) when fully charged.

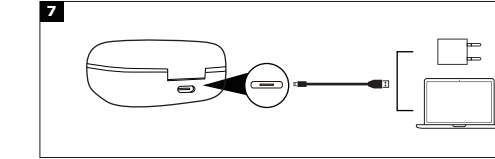

Power On (Fig. 8)

Uncover the lid and they will power on automatically.

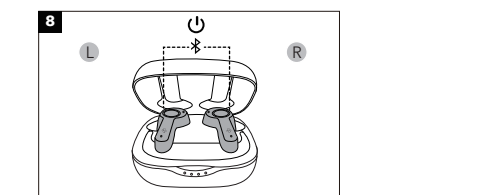

07

Power Off (Fig. 9)

Put the earbuds into the charging case and close the lid, they will turn off automatically.

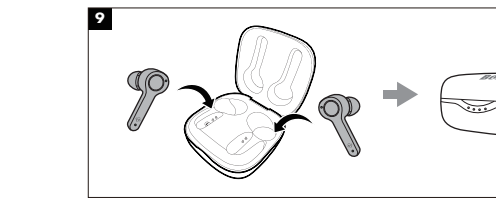

08

Boltune
www.boltune.net

BT-BH020 Pro_V1.0_EN

NORTH AMERICA
E-mail: support@boltune.net

MANUFACTURER
Shenzhen NearbyExpress Technology Development Co.,Ltd.
Address: Floor 7, Building E, Galaxy World Phase II, Shenzhen, China



Pairing

- You can use one earbud or both earbuds as per your preference. Please refer to the corresponding pairing instructions.
- Before pairing, please turn off other Bluetooth devices and place the device to be connected close to the earbuds.

Couple Earbuds Mode

- Uncover the lid to turn on the earbuds, they will connect with each other automatically. Once connected, The LED indicators on both earbuds will flash blue and white alternately indicating the earbuds are in pairing mode now.
- Turn on the Bluetooth function on your device and search for nearby devices. Find "Boltune BT-BH020" in the searching results, tap on the name to connect.
- Once connected, the LED indicators on both earbuds will flash blue slowly.

Note:

- The earbuds can remember the devices paired previously, and will attempt to pair with the last connected device. If re-pairing failed, the earbuds will enter pairing mode.
- It is not recommended to wear the two earbuds on different people. If necessary, please keep the two earbuds close to each other in couple earbuds mode.

Single Earbud Mode

- Take out one earbud from the charging case, and make sure the other one is placed in the charging case and the lid is covered.
- It will try to pair with the last paired device first then enter pairing

mode with its LED indicator flashing blue and white alternately if pairing failed.

- Turn on the Bluetooth function on your device and search for nearby devices. Find "Boltune BT-BH020" in the searching results, tap on the name to connect.
- Once connected, the LED indicator will flash blue slowly.

Note:

If you want to change to couple mode, simply take out the other earbud from the charging case, they will pair with each other automatically.

Clear Pairing List

If you failed to pair your device with the earbuds, please clear the pairing history as instructed below:

- Place both earbuds in the charging case.
- Press and hold the Multifunction Touch Control of both earbuds for 10 seconds until the LED indicators on both earbuds flash white three times.
- If you have paired your device with the earbuds before, remove "Boltune BT-BH020" from the Bluetooth device list and pair again.
- Re-pair with your Bluetooth® device as instructed in "Pairing" section.

Note:

If you want to pair the earbuds with another device when you have already paired them with a device, deactivate the Bluetooth function on the paired device or clear "Boltune BT-BH020" from its Bluetooth list. Restore the earbuds to factory settings as instructed above if pairing failed.

OPERATION AND FUNCTIONS

Function	Operation	Voice Prompt
Play / Pause	Tap the Touch Control on either of the earbuds twice under music	/
Volume +	Tap the Touch Control on the right earbud once	Toots when highest setting is reached
Volume -	Tap the Touch Control on the left earbud once	/
Next Track	Tap the Touch Control on the right earbud three times	/
Previous Track	Tap the Touch Control on the left earbud three times	/
Answer Phone Call	Tap the Touch Control on either of the earbuds once	/
Hang Up Phone Call	Tap and hold the Touch Control on either of the earbuds for 2 seconds	/

Function	Operation	Voice Prompt
Decline an Incoming Call	Tap and hold the Touch Control on either of the earbuds for 2 seconds	Call rejected
Turn On / Off Voice Control	When paired successfully, tap and hold the Touch Control on either of the earbuds for 2 seconds until a beep is heard	Toot
Clear Pairing List	Refer to the "Clear Pairing List" section	/
Go into Pairing Mode	Refer to the "Pairing" section	Pairing
Successfully paired with your device		Connected
Bluetooth out of Range / Failed to pair with your device		Disconnected

Note: Only when you are wearing the earbuds can you hear the voice prompt.

CLEANING AND MAINTENANCE

- Clean the earbuds and the charging case on a regular basis.
- Use dry and soft cotton cloth to wipe the unit.
- Do not insert anything into the product.
- Keep away from sharp objects to avoid scratches.
- Put the unit in a dry and shady place if it is to be idle for a long time.
- Do not clean the product with detergent or chemicals.

TROUBLESHOOTING

No.	Problem	Solution
1	Failed to turn on the earbuds	Earbuds low battery, please charge them
2	Failed to charge the earbuds	<ul style="list-style-type: none"> Place the earbuds into the charging case properly Make sure the charging case is charged fully
3	Can't charge the charging case	Make sure the charging cable is intact and plugged in properly
4	Can't find "Boltune BT-BH020" in the Bluetooth device list	<p>The earbuds reconnected with previously paired device automatically:</p> <ul style="list-style-type: none"> Deactivate the Bluetooth function of previously paired device or clear "Boltune BT-BH020" from its Bluetooth device list, and then search again Put the device to be connected close to the earbuds
5	Failed to pair the earbuds with your device	<ul style="list-style-type: none"> Turn on the device and activate its Bluetooth function before pairing Bring the earbuds into pairing mode as instructed in the "Pairing" section

No.	Problem	Solution
6	No sound in one of the earbuds in couple earbuds mode	Place both earbuds back to the charging case then take them out, they will pair with each other automatically. If pairing failed, restore them back to the factory settings as instructed in the "Clear Pairing List" section
7	Poor sound quality	<ul style="list-style-type: none"> Wear the earbuds properly and keep them close to each other. Place the connected device close to the earbuds or remove the obstacles between them Clear the debris on the earbuds
8	Unstable connection	<ul style="list-style-type: none"> Keep the earbuds close to your Bluetooth device The effective distance may shorten with obstacles in the way Turn off other Bluetooth devices to decrease the interference
9	Can't hear the other party during a phone call	Set the volume to higher level
10	The other party can't hear your voice during a phone call	Free the built-in microphone of any covers

No.	Problem	Solution
11	Multifunction Button of the earbuds is unresponsive	Place the two earbuds into the charging case and cover the lid, disconnect the Bluetooth connection. Uncover the lid to turn on the earbuds and pair again.

WARRANTY AND SERVICE

If any problems occur, please contact the Boltune Customer Care Centre via the contact information listed in this User Guide.



EN The Bluetooth® word mark and logos are registered trademarks owned by the Bluetooth SIG, Inc. and any use of such marks by Sunvalleytek International Inc. is under license. Other trademarks and trade names are those of their respective owners.

NOTE:

This equipment has been tested and found to comply with the limits for a Class B digital device, pursuant to part 15 of the FCC Rules. These limits are designed to provide reasonable protection against harmful interference in a residential installation. This equipment generates uses and can radiate radio frequency energy and, if not installed and used in accordance with the instructions, may cause harmful interference to radio communications. However, there is no guarantee that interference will not occur in a particular installation. If this equipment does cause harmful interference to radio or television reception, which can be determined by turning the equipment off and on, the user is encouraged to try to correct the interference by one or more of the following measures:

- Reorient or relocate the receiving antenna.
- Increase the separation between the equipment and receiver.
- Connect the equipment into an outlet on a circuit different from that to which the receiver is connected.
- Consult the dealer or an experienced radio/TV technician for help

Changes or modifications not expressly approved by the party responsible for compliance could void the user's authority to operate the equipment. This device complies with Part 15 of the FCC Rules. Operation is subject to the following two conditions:

- this device may not cause harmful interference, and
- this device must accept any interference received, including interference that may cause undesired operation.



WEEE Compliance

Correct Disposal of This Product (Waste Electrical & Electronic Equipment)(Applicable in countries with separate collection systems) This marking on the product, accessories or literature indicates that the product and its electronic accessories should not be disposed of with other household waste at the end of their working life. To prevent possible harm to the environment or human health from uncontrolled waste disposal, please separate these items from other types of waste and recycle them responsibly to promote the sustainable reuse of material resources. Household users should contact either the retailer where they purchased this product, or their local government office, for details of where and how they can take these items for environmentally safe recycling. Business users should contact their supplier and check the terms and conditions of the purchase contract. This product and its electronic accessories should not be mixed with other commercial wastes for disposal.