

Instruction Manual

TT603BT



You'll soon be enjoying your new Turntable.

It all begins here, with your instructions. Don't worry, there's nothing too technical coming up. Just simple, step-by-step guidance to get you up and running quickly. Sound good? Then let's get started.

Safety information

Safety information

Important - Please read these instructions fully before installing or operating

Power source

CAUTION TO REDUCE THE RISK OF ELECTRIC SHOCK, DO NOT REMOVE ANY COVER. NO USER-SERVICEABLE PARTS INSIDE. REFER ANY SERVICING TO QUALIFIED SERVICE PERSONNEL.

- Please read this owner's guide.
- Please take the time to follow the instructions in this owner's guide carefully. It will help you set up and operate your system properly and enjoy all of its advanced features.
- Please save this owner's guide for future reference.
- The product label is located on the back of the product.
- Heed all warnings - on the product and in the owner's guide.
- Do not use this apparatus near water or moisture.
- Do not use this product near a bathtub, washbowl, kitchen sink, and laundry tub, in a wet basement, near a swimming pool, or anywhere else that water or moisture is present.
- Only use attachments/accessories specified by the manufacturer.
- Unplug this apparatus during lightning storms or when unused for long periods of time - to prevent damage to this product.
- Refer all servicing to qualified service personnel.
- Servicing is required when the apparatus has been damaged in any way, such as liquid has been spilled or objects have fallen into the apparatus, the apparatus has been exposed to rain or moisture, does not operate normally, or has been dropped.
- Do not attempt to service this product yourself.
- Opening or removing covers may expose you to dangerous voltages or other hazards.
- To prevent risk of fire or electric shock, avoid overloading wall outlets, extension cords, or integral convenience receptacles.
- Use suitable power sources - Plug the product into a suitable power source, as described in the operating instructions or as marked on the product.



This symbol means that this unit is double insulated. An earth connection is not required.

Disposal information

WEEE marking "Information for the consumer"
Disposal of your old product: Your product is designed and manufactured with high quality materials and components, which can be recycled and reused. When this crossed out wheeled bin symbol is attached to a product, it means the product is covered by the European Directive 2002/96/EC.

Please make yourself aware of the local collection system for electrical and electronic products. Please act according to your local rules and do not dispose of your old products with your normal household waste. The correct disposal of your old product will help prevent potential negative consequences for the environment and human health.

Contents

Page Contents	
Warnings	5
Box contents and features	6
Using the turntable	7-8
Care and Maintenance	9
Changing the stylus	9
Trouble Shooting Guide	10

Warnings

- Warning**
1. No naked flame sources, such as lighted candles, should be placed on or near this equipment.
 2. Do not place the product in enclosed bookcases or racks without proper ventilation.
 3. The mains adaptor is used as the disconnect device and must be easily reached to unplug.
 4. Always use the power adaptor supplied if it needs to be replaced make sure the replacement has the same rating.
 5. The ventilation should not be impeded by covering the ventilation openings with items, such as newspapers, table-cloths, curtains, etc.
 6. Do not expose to dripping or splashed fluids. Objects filled with liquids, such as vases, must not be placed on or near this equipment.
 7. The unit should not be exposed to direct sunlight, very high or low temperature, moisture, vibrations or placed in dusty environment.
 8. Do not use abrasives, benzene, thinner or other solvents to clean the surface of the unit. To clean, wipe with clean soft cloth and a mild detergent solution.
 9. Never attempt to insert wires, pins or other such objects into the vents or opening of the unit.
 10. Do not disassemble or modify the turntable - apart from the stylus which can be replaced, there are no other user serviceable parts.
 11. If the turntable is damaged in anyway or malfunctions do not use. Consult a qualified service engineer.
 12. Switch off the mains socket the power adaptor is connected to when the turntable is not in use.
 13. Do not dispose of this product with household waste at the end of its life cycle; hand it over to a collection centre for the recycling of electrical and electronic appliances. By recycling, some of the materials can be reused. You are making an important contribution to protect our environment. Please check with your Local Authority or recycling advice.

- Disposal of your old appliance:**
1. When this crossed-out wheeled bin symbol is attached to a product, it means the product is covered by the European Directive.
 2. All electrical and electronic products should be disposed of separately from household waste at an appropriate recycling point/centre.
 3. The correct disposal of your old appliance will help prevent potential negative consequences for the environment and human health.
 4. For more detailed information about disposal of your old appliance, please contact your local authority or the shop where you purchased the product.

Classic Portable Turntable | Instruction Manual

5

Box contents and features

- Box Contents**
- 1x Turntable with attaché case housing
 - 1x Power adaptor
 - 1x 3.5mm jack AUX IN cables
 - 1x 3.5mm to 2-Male RCA Cable
 - 1x User guide
 - 1x Spare stylus

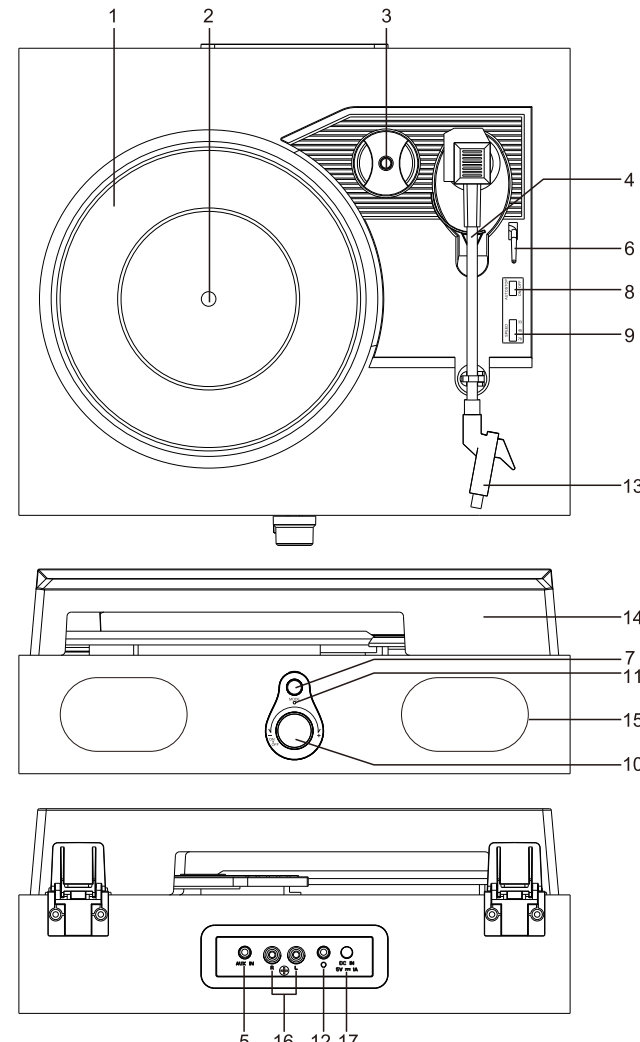

1. Turntable deck
2. Turntable shaft
3. Centre hole adaptor
4. Tone arm
5. Line in
6. Cueing lever
7. Function buttons
8. Auto stop control switch
9. Turntable speed selector
10. Power switch/Volume control
11. Status indicator
12. RED Standby
13. GREEN PHONO MODE
14. BLUE BT MODE
15. AMBER LINE IN MODE
16. Head phone jack
17. Stylus
18. Transparent cover
19. Speaker
20. Line out channel R/L
21. DC 5V IN

Classic Portable Turntable | Instruction Manual

6

Using the turntable

1. Place the tunable case on a flat level surface.
2. Insert the adaptor cord into the DC jack at the rear of the case and plug the adaptor into the mains supply socket.
3. On first use, ensure that the cable tie is removed from the player arm.
4. Remove the stylus cover (fig. 1) and keep in a safe place for future use.
5. Move the speed selector to the speed (33, 45 or 78rpm) corresponding to the record to be played.
6. Press function button to PHONO, indicator green.
7. Place a record onto the turntable spindle and unclip the tone arm (fig. 2).
8. Use the cueing lever to lift the tone arm (fig.3) and move the arm (fig.4) so that the stylus is positioned just inside the edge of the record or aligned with the start of the record to be played.
9. Slowly lower the arm and after a short interval the track will start to play.
10. Adjust the volume to the desired level by rotating the volume control knob.
11. When the end of the record has been reached thez turntable will stop.
12. Use the lever again to lift the tone arm (the deck will start to rotate again), move it back to the clip and lower into the cradle. The deck will stop.
13. Secure the tone arm using the clip and refit the stylus cover after use and ALWAYS before moving the turntable.
14. To turn off the turntable at any time, lift the tone arm on the record and turn the VOLUME knob fully anticlockwise. A



Fig 1

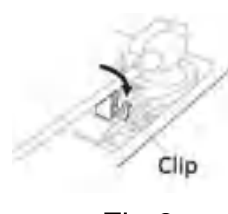

Fig 2

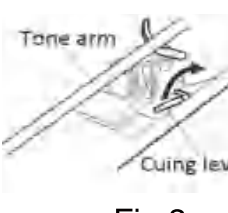

Fig 3

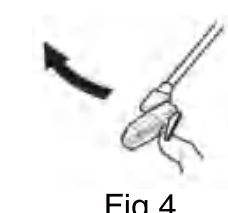

Fig 4

Note

Some records have larger centre hole and it may be necessary to fit the centre hole adaptor to the turntable shaft before placing the record on the turntable. Always refit the stylus cover and secure the turntable arm using the clip before moving the turntable.

Classic Portable Turntable | Instruction Manual

7

Using With Auxiliary Device

- Auxiliary analogue audio equipment can be connected and amplified via the turntable
1. Key switch to LIEN IN, indicator amber, 3.5mm jack on the back of the main unit terminal.
 2. Press the PLAY button on the auxiliary equipment and use the track controls as usual on the auxiliary device.
 3. The volume can be adjusted using the volume knob on the turntable or the controls on the connected auxiliary device.
 4. To turn off the unit at any time, turn the volume knob fully anticlockwise.

Using Headphones (not included)

A stereo headphone jack has been provided so that the turntable can be used without disturbing others. Plug in the headphones at the point marked "HEADPHONE" at the back terminal box and adjust the listening volume to your chosen level. Excessive sound pressure from earphones and headphones can cause hearing loss. The turntable speakers will not operate when earphones are fitted.

Bluetooth Operation

1. Press the button to switch the function to BT mode, indicator blue. The indicator light starts flashing when you switch to BT mode.
2. Turn your devices Bluetooth setting on, and search to BT mode.
3. Select the Bluetooth pairing name "YM2195" to connect to the record player.
4. Once you are connected the blue indicator light will stop flashing, you can now play music from your device through your record player, use the volume control dial to adjust the volume.

Note: After initial pairing the record player will stay paired to your device unless it is unpaired manually or the device is reset.

Classic Portable Turntable | Instruction Manual

8

Connecting the Turntable to External Speaker

If connecting the turntable to external speakers (via a suitable amplifier) use a twin phono to twin phono lead (not included) to connect the RCA output jacks to the AUDIO IN of the amplifier (see Fig. 5). Ensure red plugs are inserted into the red sockets and white into white.

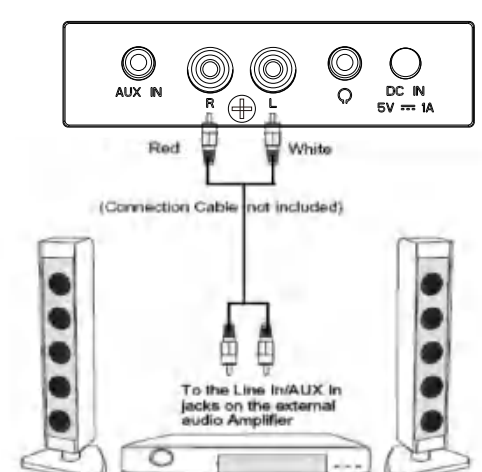
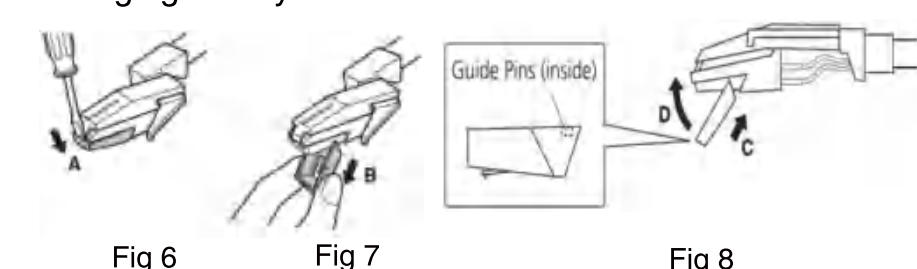

Fig 5

Care and Maintenance

Changing the stylus



1. Ensure the tone arm is secured by the clip.
2. Insert a tip of a small screwdriver as shown and gently push in a downward direction.
3. Remove the old stylus (fig.7).
4. Hold the tip of the new stylus, align the guide pins as shown and clip into position (fig.8)

Caring for the turntable

Wipe external surfaces with a soft cloth. If the case is very dirty, unplug from the mains supply and use a damp cloth soaked in a weak solution of washing up liquid and water. Allow to dry thoroughly before reusing

Classic Portable Turntable | Instruction Manual

9

Caring for records

Hold records by the label or edges (fig. 9). Oils from clean hands can leave a residue on the record surface that will gradually deteriorate the quality of your record.

Keep in a cool, dry place and store records in their sleeves and jackets when not in use. Store records upright (on their edges). Records stored horizontally will eventually bend and warp. Do not expose records to direct sunlight, high humidity and high temperatures. Long exposure to high temperatures will warp the record. Should the record become dirty, gently wipe the surface in a circular motion using a soft anti-static cloth (fig. 10) suitable for this application.

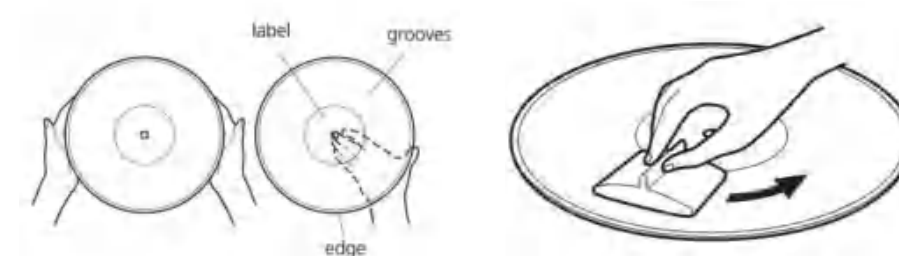

Trouble Shooting Guide

Observation	Potential cause / solution
The turntable does not work	Has the adaptor lead been correctly plugged into the mains and the DC input jack at the rear of the case? Does the socket that is being used have power? Has the volume knob been turned in a clockwise direction to switch the unit on?
No sound	Is the volume control set at minimum on the turntable or any auxiliary that has been connected?
Noisy sound	Has the turntable been placed close to a TV set or similar?
Record does not play	Has the stylus cover been removed? Is the stylus in contact with the record surface? Check the Aux in cable was removed?
Record sound skips	Is the stylus damaged? Does the surface of the record need cleaning? Is the record scratched or warped?
Auxiliary equipment does not play	Is the auxiliary equipment correctly connected to the unit?

Classic Portable Turntable | Instruction Manual

10

In the unlikely event of difficulties with your appliance please follow the trouble shooting guide. If the problem persists, Please send email to CustomerService@ttino.com

TECHNICAL SPECIFICATION	
Power adaptor	100 - 240V - 50/60Hz
Input	5V - 1500mA
Output	7.5W
Class II (double insulated)	-0.5W
Power consumption (max.)	Ceramic
Cartridge type	3W x 2 RMS
Audio output	1000mV Impedance 22KΩ
AUX Input: Max voltage	Temperature: 5°C to 35°C Humidity 5% to 90%
Operating conditions	Horizontal
Operating position	

RECYCLING ELECTRICAL PRODUCTS

You should now recycle your waste electrical goods and in doing so help the environment. This symbol means an electrical product should not be disposed of with normal household waste. Please ensure it is taken to a suitable facility for disposal.

This equipment has been tested and found to comply with the limits for a Class B digital device, pursuant to part 15 of the FCC Rules. These limits are designed to provide reasonable protection against harmful interference in a residential installation. This equipment generates, uses and can radiate radio frequency energy and, if not installed and used in accordance with the instructions, may cause harmful interference to radio communications. However, there is no guarantee that interference will not occur in a particular installation. If this equipment does cause harmful interference to radio or television reception, which can be determined by turning the equipment off and on, the user is encouraged to try to correct the interference by one or more of the following measures:

- Reorient or relocate the receiving antenna.
- Increase the separation between the equipment and receiver.
- Connect the equipment into an outlet on a circuit different from that to which the receiver is connected.
- Consult the dealer or an experienced radio/TV technician for help.

Caution: Any changes or modifications to this device not explicitly approved by manufacturer could void your authority to operate this equipment.

This device complies with part 15 of the FCC Rules. Operation is subject to the following two conditions: (1) This device may not cause harmful interference, and (2) this device must accept any interference received, including interference that may cause undesired operation.

Radiation Exposure Statement
This equipment complies with FCC radiation exposure limits set forth for an uncontrolled environment. This equipment should be installed and operated with minimum distance 20cm between the radiator and your body.

Classic Portable Turntable | Instruction Manual

11

a5
材质: 80G书纸单黑印刷