



## Test Report

Date : 2020-07-30  
No. : HMD20070008

Page 1 of 74

**Applicant** : TT Innovation Technology (HK) Co., Ltd.  
Unit 506A, Harbour Crystal Centre, 100 Granville Road, Tsim Sha Tsui, Kowloon, Hong Kong

**Supplier / Manufacturer** : Dongguan Fulun Electronics Co., Ltd.  
4-8 Building B Xinbosheng Industrial Park No.5 Xinyuan South Road  
Keyuan City Tangxia Dongguan China

**Description of Sample(s)** : Submitted sample(s) said to be  
Product: Heyday Wireless Bluetooth Earbuds  
Brand Name: heyday  
Model No.: TT2001  
FCC ID: 2AVTM-TT2001

**Date Samples Received** : 2020-07-20

**Date Tested** : 2020-07-20 to 2020-07-24

**Investigation Requested** : Perform Electro Magnetic Interference measurement in accordance with FCC 47CFR [Codes of Federal Regulations] Part 15 and ANSI C63.10:2013 for FCC Certification.

**Conclusions** : The submitted product COMPLIED with the requirements of Federal Communications Commission [FCC] Rules and Regulations Part 15. The tests were performed in accordance with the standards described above and on Section 2.2 in this Test Report.

**Remarks** : Bluetooth FHSS (GFSK /  $\pi/4$ -DQPSK)

  
  
LEUNG Kwun Hang, Joey  
Authorized Signatory



## Test Report

Date : 2020-07-30  
No. : HMD20070008

Page 2 of 74

### CONTENT:

Cover	Page 1 of 74	
Content	Page 2 of 74	
<b><u>1.0</u></b>	<b><u>General Details</u></b>	
1.1	Test Laboratory	Page 3 of 74
1.2	Equipment Under Test [EUT] Description of EUT operation	Page 3 of 74
1.3	Date of Order	Page 3 of 74
1.4	Submitted Sample(s)	Page 3 of 74
1.5	Test Duration	Page 3 of 74
1.6	Country of Origin	Page 3 of 74
1.7	RF Module Details	Page 4 of 74
1.8	Antenna Details	Page 4 of 74
1.9	Channel List	Page 4 of 74
<b><u>2.0</u></b>	<b><u>Technical Details</u></b>	
2.1	Investigations Requested	Page 5 of 74
2.2	Test Standards and Results Summary	Page 5 of 74
2.3	Table for Test Modes	Page 6 of 74
<b><u>3.0</u></b>	<b><u>Test Results</u></b>	
3.1	Emission	Page 7-70 of 74
<b><u>Appendix A</u></b>	<b>List of Measurement Equipment</b>	Page 71 of 74
<b><u>Appendix B</u></b>	<b>Photograph(s) of Product</b>	Page 72-74 of 74

The Hong Kong Standards and Testing Centre Limited

10 Dai Wang Street, Taiipo Industrial Estate, Tai Po, N.T., Hong Kong

Tel: +852 2666 1888 Fax: +852 2664 4353 Email: hkstc@stc.group Website: www.stc.group

This report shall not be reproduced unless with prior written approval from The Hong Kong Standards and Testing Centre Limited.

For Conditions of Issuance of this test report, please refer to "Conditions of Issuance of Test Reports" section or Website.



## Test Report

Date : 2020-07-30  
No. : HMD20070008

Page 3 of 74

### **1.0 General Details**

#### **1.1 Test Laboratory**

The Hong Kong Standards and Testing Centre Ltd.  
EMC Laboratory  
10 Dai Wang Street, Taipo Industrial Estate, New Territories, Hong Kong  
Telephone: 852 2666 1888  
Fax: 852 2664 4353

#### **1.2 Equipment Under Test [EUT]**

##### **Description of Sample(s)**

Product: Heyday Wireless Bluetooth Earbuds  
Manufacturer: Dongguan Fulun Electronics Co., Ltd.  
4-8 Building B Xinbosheng Industrial Park No.5 Xinyuan South  
Road Keyuan City Tangxia Dongguan China  
Brand Name: heyday  
Model Number: TT2001  
Rating: 5Vd.c.(power by USB port) /  
3.7Vd.c (Li-ion rechargeable battery x1)

#### **1.2.1 Description of EUT Operation**

The Equipment Under Test (EUT) is a Heyday Wireless Bluetooth Earbuds. The transmission signal is digital modulated with channel frequency range 2402-2480MHz. The R.F. signal was modulated by IC; the type of modulation used was frequency hopping spread spectrum Modulation.

#### **1.3 Date of Order**

2020-07-20

#### **1.4 Submitted Sample(s):**

1 Sample

#### **1.5 Test Duration**

2020-07-20 to 2020-07-24

#### **1.6 Country of Origin**

China

The Hong Kong Standards and Testing Centre Limited  
10 Dai Wang Street, Taipo Industrial Estate, Tai Po, N.T., Hong Kong

Tel: +852 2666 1888 Fax: +852 2664 4353 Email: hkstc@stc.group Website: www.stc.group

This report shall not be reproduced unless with prior written approval from The Hong Kong Standards and Testing Centre Limited.  
For Conditions of Issuance of this test report, please refer to "Conditions of Issuance of Test Reports" section or Website.



## Test Report

Date : 2020-07-30  
No. : HMD20070008

Page 4 of 74

### 1.7 RF Module Details

Module Model Number: AC6936D  
Module FCC ID: N/A  
Module Transmission Type: Bluetooth V4.2 EDR  
Modulation: FHSS (GFSK /  $\pi/4$ -DQPSK)  
Data Rates:  
1Mbps: GFSK  
2 Mbps:  $\pi/4$ -DQPSK  
Frequency Range: 2400-2483.5MHz  
Carrier Frequencies: 2402MHz – 2480MHz

Module Specification (specification provided by manufacturer)

### 1.8 Antenna Details

Antenna Type: PCB antenna  
Antenna Gain: 0dBi

### 1.9 Channel List

Channel	Frequency (MHz)	Channel	Frequency (MHz)
0	2402	42	2444
1	2403	43	2445
2	2404	44	2446
3	2405	45	2447
4	2406	46	2448
5	2407	47	2449
6	2408	48	2450
7	2409	...	...
8	2410	67	2469
9	2411	68	2470
...	...	69	2471
33	2435	70	2472
34	2436	71	2473
35	2437	72	2474
36	2438	73	2475
37	2439	74	2476
38	2440	75	2477
39	2441	76	2478
40	2442	77	2479
41	2443	78	2480

The Hong Kong Standards and Testing Centre Limited

10 Dai Wang Street, Taipo Industrial Estate, Tai Po, N.T., Hong Kong

Tel: +852 2666 1888 Fax: +852 2664 4353 Email: hkstc@stc.group Website: www.stc.group

This report shall not be reproduced unless with prior written approval from The Hong Kong Standards and Testing Centre Limited.

For Conditions of Issuance of this test report, please refer to "Conditions of Issuance of Test Reports" section or Website.



## Test Report

**Date : 2020-07-30**  
**No. : HMD20070008**

**Page 5 of 74**

### **2.0 Technical Details**

#### **2.1 Investigations Requested**

Perform Electromagnetic Interference measurements in accordance with FCC 47CFR [Codes of Federal Regulations] Part 15 Regulations and ANSI C63.10:2013 for FCC Certification.  
 According FCC KDB 558074 DSS Measurement Guidance, Duty cycle  $\geq 98\%$ .

#### **2.2 Test Standards and Results Summary Tables**

<b>EMISSION Results Summary</b>						
Test Condition	Test Requirement	Test Method	Class / Severity	Test Result		
				Pass	Failed	N/A
Maximum Peak Conducted Output Power	FCC 47CFR 15.247(b)(1)	ANSI C63.10: 2013	N/A	<input checked="" type="checkbox"/>	<input type="checkbox"/>	<input type="checkbox"/>
Radiated Spurious Emissions	FCC 47CFR 15.209	ANSI C63.10: 2013	N/A	<input checked="" type="checkbox"/>	<input type="checkbox"/>	<input type="checkbox"/>
AC Mains Conducted Emissions	FCC 47CFR 15.207	ANSI C63.10: 2013	N/A	<input checked="" type="checkbox"/>	<input type="checkbox"/>	<input type="checkbox"/>
Number of Hopping Frequency	FCC 47CFR 15.247 (b)(1)	ANSI C63.10: 2013	N/A	<input checked="" type="checkbox"/>	<input type="checkbox"/>	<input type="checkbox"/>
20dB Bandwidth	FCC 47CFR 15.247(a)(2)	ANSI C63.10: 2013	N/A	<input checked="" type="checkbox"/>	<input type="checkbox"/>	<input type="checkbox"/>
Hopping Channel Separation	FCC 47CFR 15.247(a)(1)	ANSI C63.10: 2013	N/A	<input checked="" type="checkbox"/>	<input type="checkbox"/>	<input type="checkbox"/>
Band-edge measurement (Radiated)	FCC 47CFR 15.247(d)	ANSI C63.10: 2013	N/A	<input checked="" type="checkbox"/>	<input type="checkbox"/>	<input type="checkbox"/>
Pseudorandom Hopping Algorithm	FCC 47CFR 15.247(a)(1)	N/A	N/A	<input checked="" type="checkbox"/>	<input type="checkbox"/>	<input type="checkbox"/>
Time of Occupancy (Dwell Time)	FCC 47CFR 15.247(a)(1)(iii)	ANSI C63.10: 2013	N/A	<input checked="" type="checkbox"/>	<input type="checkbox"/>	<input type="checkbox"/>
Antenna requirement	FCC 47CFR 15.203	N/A	N/A	<input checked="" type="checkbox"/>	<input type="checkbox"/>	<input type="checkbox"/>

Note: N/A - Not Applicable



## Test Report

Date : 2020-07-30  
No. : HMD20070008

Page 6 of 74

### 2.3 Table for Test Modes

Preliminary tests were performed in different data rate to find the worst radiated emission. The data rate in the table below is the worst case rate with respect to the specific test item.

Investigation has been done on all the possible configurations for searching the worst cases.

The device was realized by test software.

The following table is a list of the test modes shown in this test report.

Test Items	Mode	Data Rate
Maximum Peak Conducted Output Power	GFSK / $\pi/4$ -DQPSK	1MBps / 2MBps
Hopping Channel Separation	GFSK / $\pi/4$ -DQPSK	1MBps / 2MBps
Number of Hopping Frequency	GFSK / $\pi/4$ -DQPSK	1MBps / 2MBp
Time of Occupancy(Dwell Time)	$\pi/4$ -DQPSK (DH1 / DH3 / DH5)	2MBps
Radiated Spurious Emissions	GFSK / $\pi/4$ -DQPSK	1MBps / 2MBps
Band-edge compliance of Conducted Emission	GFSK / $\pi/4$ -DQPSK	1MBps / 2MBps

The Hong Kong Standards and Testing Centre Limited

10 Dai Wang Street, Taipo Industrial Estate, Tai Po, N.T., Hong Kong

Tel: +852 2666 1888 Fax: +852 2664 4353 Email: hkstc@stc.group Website: www.stc.group

This report shall not be reproduced unless with prior written approval from The Hong Kong Standards and Testing Centre Limited.

For Conditions of Issuance of this test report, please refer to "Conditions of Issuance of Test Reports" section or Website.

## Test Report

Date : 2020-07-30  
No. : HMD20070008

Page 7 of 74

### 3.0 Test Results

#### 3.1 Emission

##### 3.1.1 Maximum Peak Conducted Output Power

Test Requirement:	FCC 47CFR 15.247(b) (1)
Test Method:	ANSI C63.10: 2013
Test Date:	2020-07-23
Mode of Operation:	Tx mode

Ambient Temperature: 25°C      Relative Humidity: 51%      Atmospheric Pressure: 101 kPa

#### **Test Method:**

A temporary antenna connector was soldered to the RF output. The RF output of the EUT was connected to the spectrum analyzer. All the attenuation or cable loss will be added to the measured maximum output power. The results are recorded in Watt.

#### **Spectrum Analyzer Setting:**

RBW = 3 MHz, VBW= 3MHz, Sweep = Auto, Span: Approximately five times the 20 dB bandwidth  
Detector = Peak, Trace = Max. hold

#### **Test Setup:**

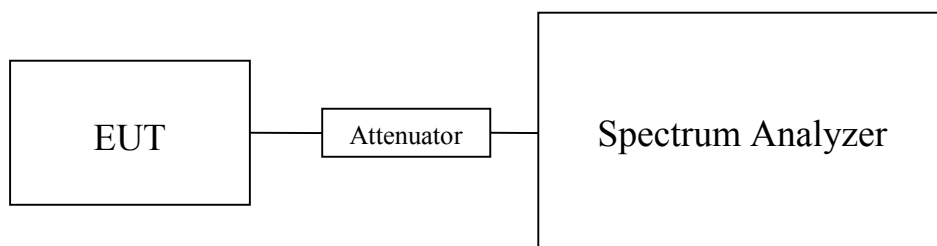

Note: a temporary antenna connector was soldered to the RF output.



## Test Report

Date : 2020-07-30  
No. : HMD20070008

Page 8 of 74

### Limits for Maximum Peak Conducted Output Power [FCC 47CFR 15.247]:

The maximum peak output power shall not exceeded the following limits:  
For frequency hopping systems employing at least 75 hopping channels: 1 Watt  
For all other frequency hopping systems in the 2400-2483.5 MHz band: 0.125 Watts  
For Digital Transmission systems in 2400-2483.5 MHz Band: 1 Watt

Results of Bluetooth Communication mode (GFSK) (Fundamental Power): Pass

Transmitter Frequency (MHz)	Maximum conducted output power (Watt)
2402	0.000513

Transmitter Frequency (MHz)	Maximum conducted output power (Watt)
2441	0.000454

Transmitter Frequency (MHz)	Maximum conducted output power (Watt)
2480	0.000369

Results of Bluetooth Communication mode ( $\pi/4$ -DQPSK) (Fundamental Power): Pass

Transmitter Frequency (MHz)	Maximum conducted output power (Watt)
2402	0.000670

Transmitter Frequency (MHz)	Maximum conducted output power (Watt)
2441	0.000590

Transmitter Frequency (MHz)	Maximum conducted output power (Watt)
2480	0.000480

Calculated measurement uncertainty : 30MHz to 1GHz 1.7dB  
1GHz to 18GHz 1.7dB

Remark:

1. All test data for each data rate were verified, but only the worst case was reported.
2. The EUT is programmed to transmit signals continuously for all testing.

The Hong Kong Standards and Testing Centre Limited

10 Dai Wang Street, Taipo Industrial Estate, Tai Po, N.T., Hong Kong

Tel: +852 2666 1888 Fax: +852 2664 4353 Email: hkstc@stc.group Website: www.stc.group

This report shall not be reproduced unless with prior written approval from The Hong Kong Standards and Testing Centre Limited.

For Conditions of Issuance of this test report, please refer to "Conditions of Issuance of Test Reports" section or Website.





## Test Report

Date : 2020-07-30  
No. : HMD20070008

Page 9 of 74

Test plot of Maximum Peak Conducted Output Power :

Bluetooth Communication mode (GFSK, 2402MHz)

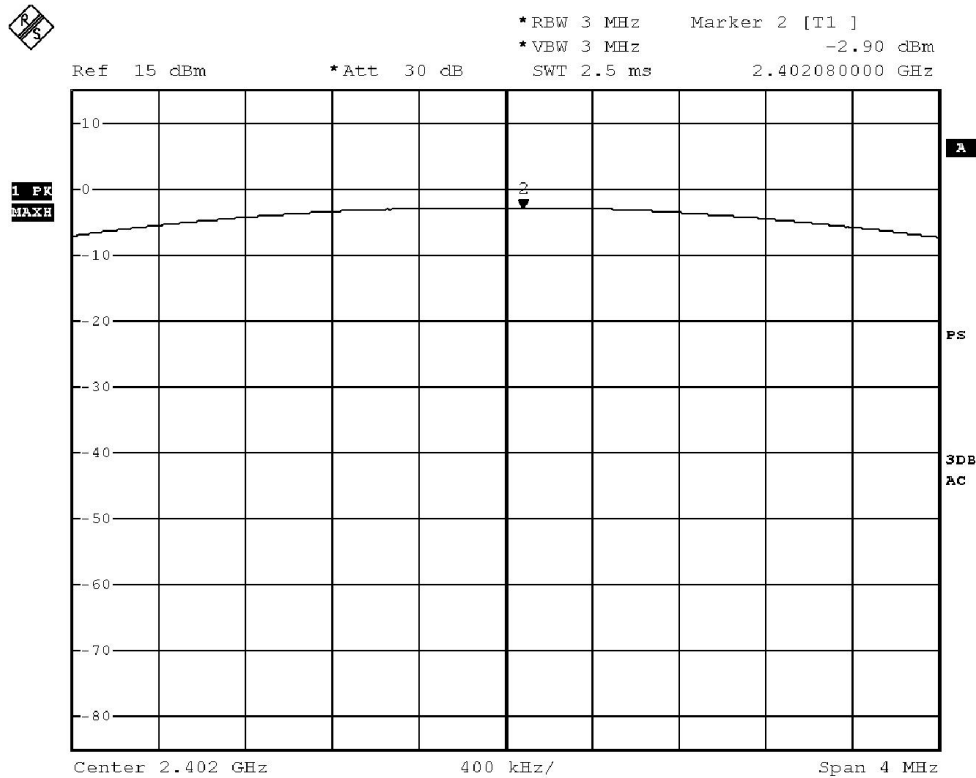

The Hong Kong Standards and Testing Centre Limited

10 Dai Wang Street, Taipo Industrial Estate, Tai Po, N.T., Hong Kong

Tel: +852 2666 1888 Fax: +852 2664 4353 Email: hkstc@stc.group Website: www.stc.group

This report shall not be reproduced unless with prior written approval from The Hong Kong Standards and Testing Centre Limited.

For Conditions of Issuance of this test report, please refer to "Conditions of Issuance of Test Reports" section or Website.



# Test Report

Date : 2020-07-30  
No. : HMD20070008

Page 10 of 74

## Bluetooth Communication mode (GFSK, 2441MHz)

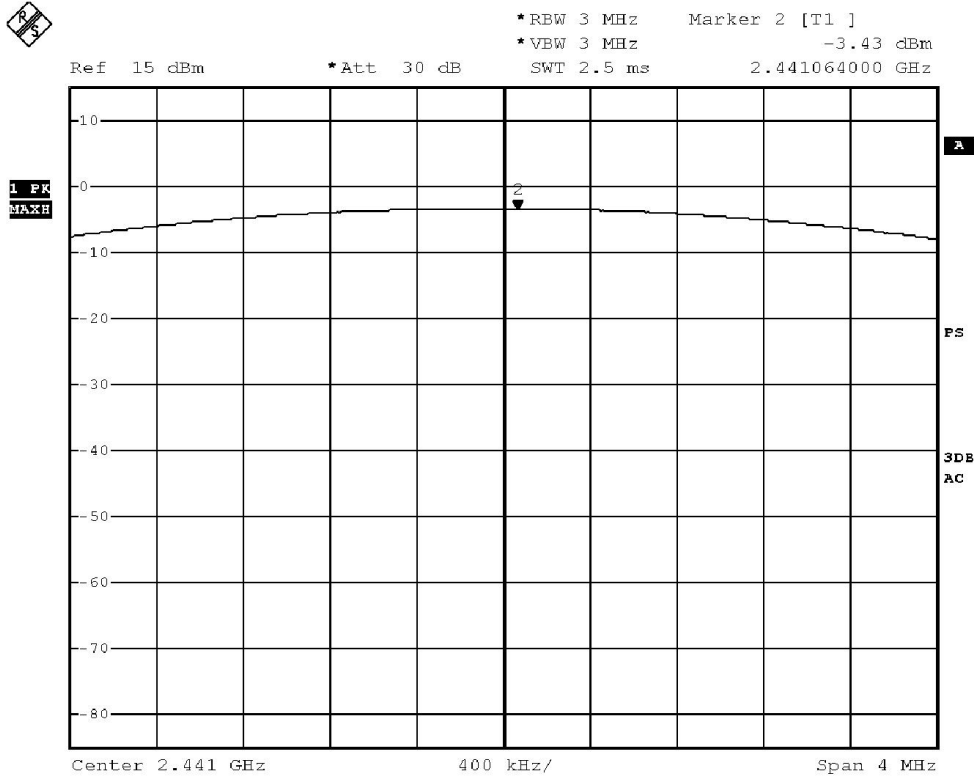

The Hong Kong Standards and Testing Centre Limited

10 Dai Wang Street, Taipo Industrial Estate, Tai Po, N.T., Hong Kong

Tel: +852 2666 1888 Fax: +852 2664 4353 Email: [hkstc@stc.group](mailto:hkstc@stc.group) Website: [www.stc.group](http://www.stc.group)

This report shall not be reproduced unless with prior written approval from The Hong Kong Standards and Testing Centre Limited.

For Conditions of Issuance of this test report, please refer to "Conditions of Issuance of Test Reports" section or Website.



# Test Report

Date : 2020-07-30  
No. : HMD20070008

Page 11 of 74

## Bluetooth Communication mode (GFSK, 2480MHz)

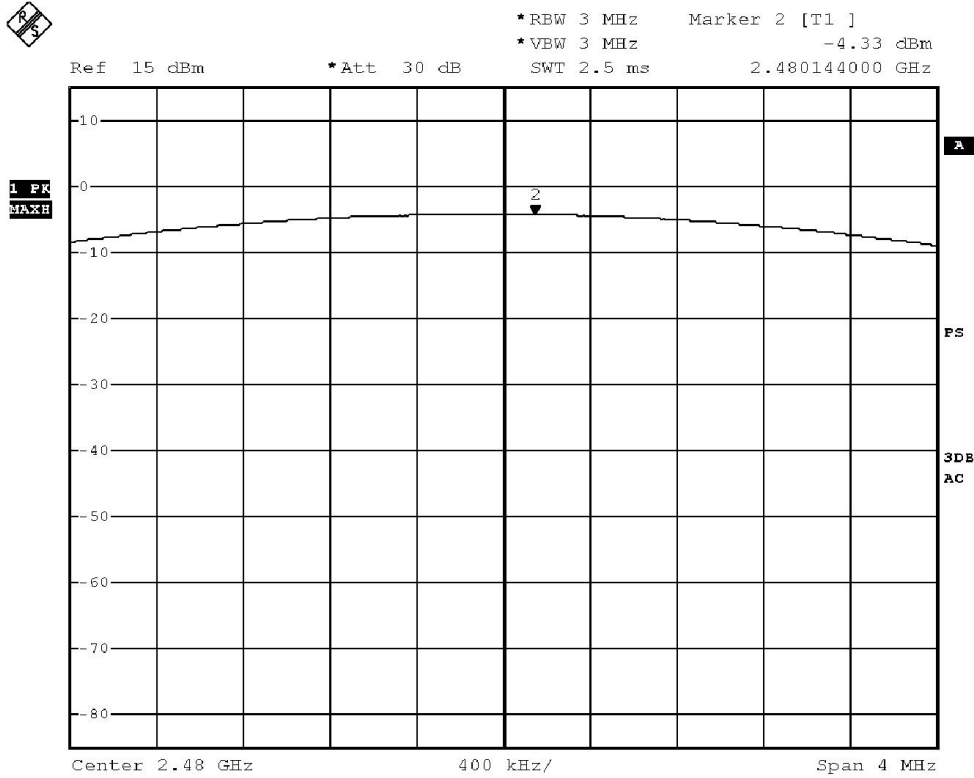

The Hong Kong Standards and Testing Centre Limited

10 Dai Wang Street, Taipo Industrial Estate, Tai Po, N.T., Hong Kong

Tel: +852 2666 1888 Fax: +852 2664 4353 Email: [hkstc@stc.group](mailto:hkstc@stc.group) Website: [www.stc.group](http://www.stc.group)

This report shall not be reproduced unless with prior written approval from The Hong Kong Standards and Testing Centre Limited.

For Conditions of Issuance of this test report, please refer to "Conditions of Issuance of Test Reports" section or Website.



# Test Report

Date : 2020-07-30  
No. : HMD20070008

Page 12 of 74

Bluetooth Communication mode ( $\pi/4$  DQPSK, 2402MHz)

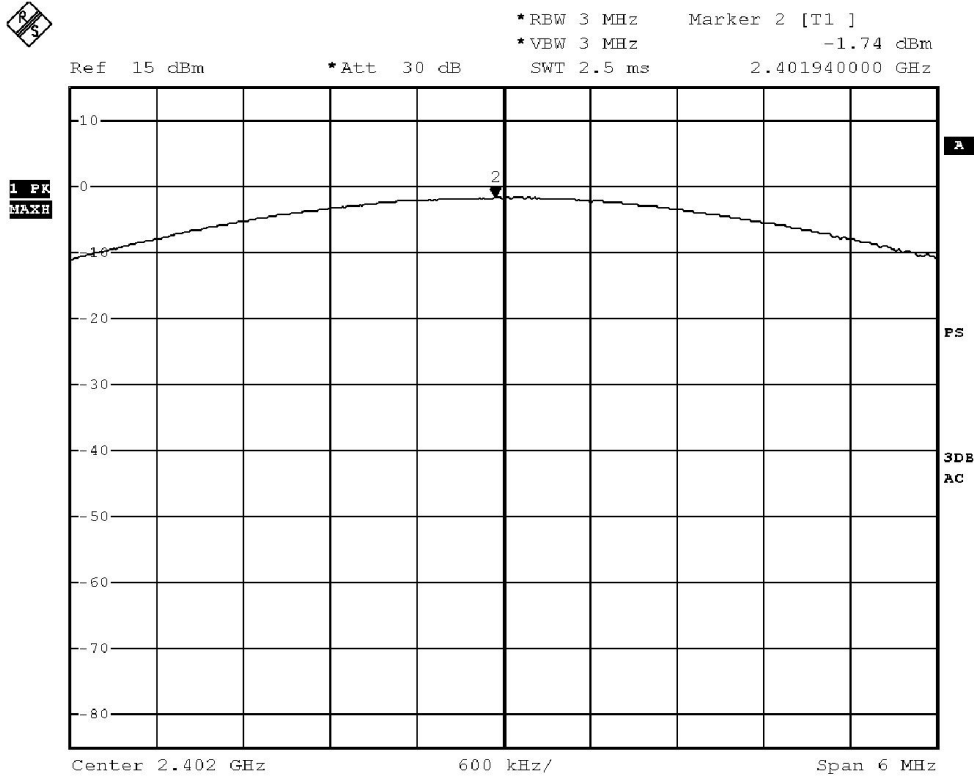

The Hong Kong Standards and Testing Centre Limited

10 Dai Wang Street, Tai Po Industrial Estate, Tai Po, N.T., Hong Kong

Tel: +852 2666 1888 Fax: +852 2664 4353 Email: hkstc@stc.group Website: www.stc.group

This report shall not be reproduced unless with prior written approval from The Hong Kong Standards and Testing Centre Limited.

For Conditions of Issuance of this test report, please refer to "Conditions of Issuance of Test Reports" section or Website.



## Test Report

Date : 2020-07-30  
No. : HMD20070008

Page 13 of 74

Bluetooth Communication mode ( $\pi/4$  DQPSK, 2441MHz)

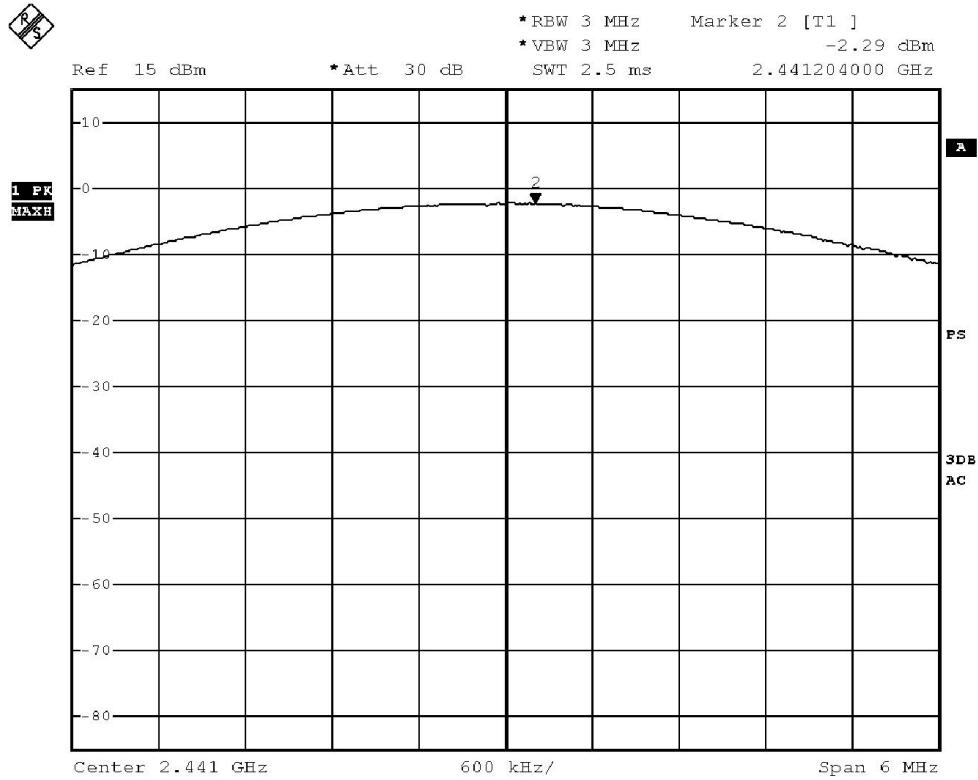

The Hong Kong Standards and Testing Centre Limited

10 Dai Wang Street, Taipo Industrial Estate, Tai Po, N.T., Hong Kong

Tel: +852 2666 1888 Fax: +852 2664 4353 Email: [hkstc@stc.group](mailto:hkstc@stc.group) Website: [www.stc.group](http://www.stc.group)

This report shall not be reproduced unless with prior written approval from The Hong Kong Standards and Testing Centre Limited.

For Conditions of Issuance of this test report, please refer to "Conditions of Issuance of Test Reports" section or Website.



# Test Report

Date : 2020-07-30  
No. : HMD20070008

Page 14 of 74

Bluetooth Communication mode ( $\pi/4$  DQPSK, 2480MHz)

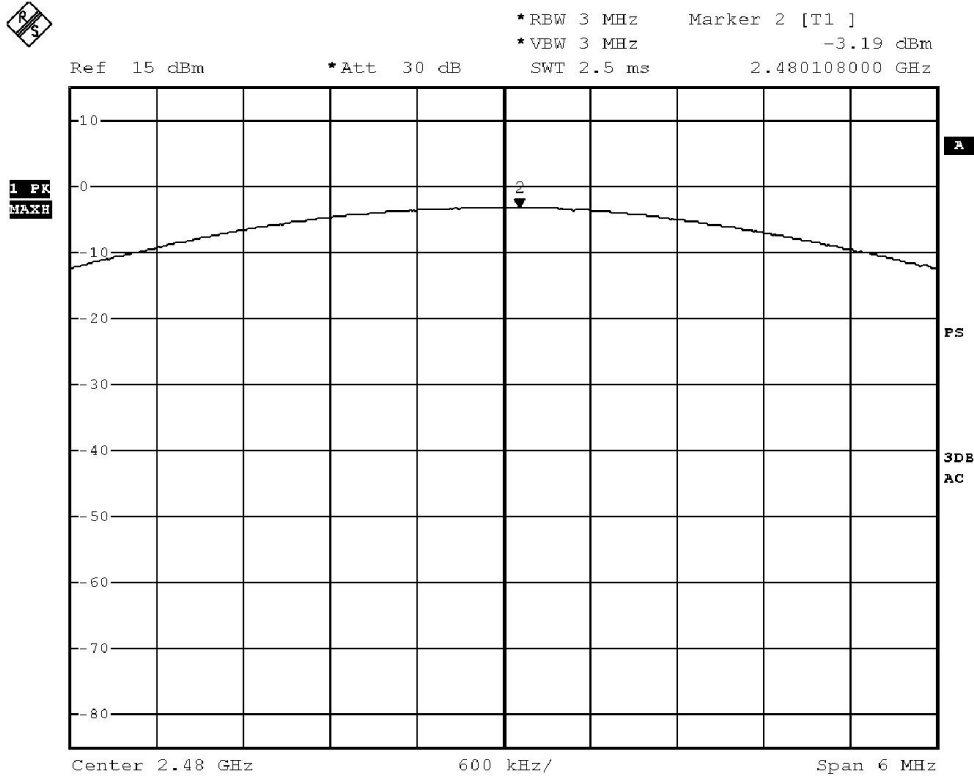

The Hong Kong Standards and Testing Centre Limited

10 Dai Wang Street, Taipo Industrial Estate, Tai Po, N.T., Hong Kong

Tel: +852 2666 1888 Fax: +852 2664 4353 Email: hkstc@stc.group Website: www.stc.group

This report shall not be reproduced unless with prior written approval from The Hong Kong Standards and Testing Centre Limited.

For Conditions of Issuance of this test report, please refer to "Conditions of Issuance of Test Reports" section or Website.



## Test Report

Date : 2020-07-30  
No. : HMD20070008

Page 15 of 74

### 3.1.2 Radiated Spurious Emissions

Test Requirement:	FCC 47CFR 15.209
Test Method:	ANSI C63.10:2013
Test Date:	2020-07-20 to 2020-07-23
Mode of Operation:	Tx mode / Bluetooth play mode (GFSK)

Ambient Temperature: 26.8°C      Relative Humidity: 43.9%      Atmospheric Pressure: 100.8 kPa

#### **Test Method:**

For emission measurements at or below 1 GHz, the sample was placed 0.8m above the ground plane of semi-anechoic Chamber\*. For emission measurements above 1 GHz, the sample was placed 1.5m above the ground plane of semi-anechoic Chamber\*. Measurements in both horizontal and vertical polarities were performed. During the test, each emission was maximized by: having the EUT continuously working, investigated all operating modes, rotated about all 3 axis (X, Y & Z) and considered typical configuration to obtain worst position, manipulating interconnecting cables, rotating turntable, varying antenna height from 1m to 4m in both horizontal and vertical polarizations. The emissions worst-case are shown in Test Results of the following pages.

\* Semi-Anechoic chamber located on the G/F of The Hong Kong Standards and Testing Centre Ltd. with a metal ground plane filed with the FCC pursuant to section 2.948 of the FCC rules, with Registration Number: 607756.

The Hong Kong Standards and Testing Centre Limited

10 Dai Wang Street, Taipo Industrial Estate, Tai Po, N.T., Hong Kong

Tel: +852 2666 1888 Fax: +852 2664 4353 Email: [hkstc@stc.group](mailto:hkstc@stc.group) Website: [www.stc.group](http://www.stc.group)

This report shall not be reproduced unless with prior written approval from The Hong Kong Standards and Testing Centre Limited.

For Conditions of Issuance of this test report, please refer to "Conditions of Issuance of Test Reports" section or Website.

## Test Report

Date : 2020-07-30  
No. : HMD20070008

Page 16 of 74

### Spectrum Analyzer Setting:

9KHz – 30MHz (Pk & Av)	RBW: 10kHz VBW: 30kHz Sweep: Auto Span: Fully capture the emissions being measured Trace: Max. hold
30MHz – 1GHz (QP)	RBW: 120kHz VBW: 120kHz Sweep: Auto Span: Fully capture the emissions being measured Trace: Max. hold
Above 1GHz (Pk)	RBW: 1MHz VBW: 1MHz Sweep: Auto Span: Fully capture the emissions being measured Trace: Max. hold
Above 1GHz (Av)	RBW: 1MHz VBW: 10Hz Sweep: Auto Span: Fully capture the emissions being measured Trace: Max. hold

### Test Setup:

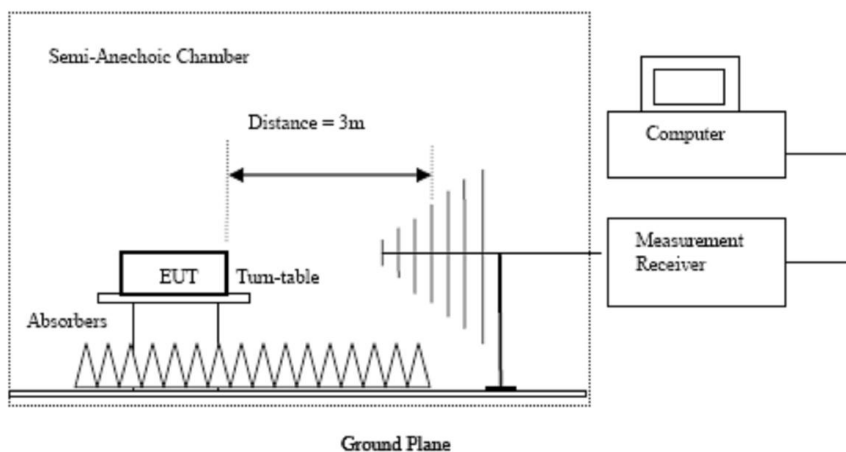

- Absorbers placed on top of the ground plane are for measurements above 1000MHz only.
- Measurements between 30MHz to 1000MHz made with Bi-log antennas, above 1000MHz horn antennas are used, 9kHz to 30MHz loop antennas are used.

The Hong Kong Standards and Testing Centre Limited  
10 Dai Wang Street, Taipo Industrial Estate, Tai Po, N.T., Hong Kong

Tel: +852 2666 1888 Fax: +852 2664 4353 Email: [hkstc@stc.group](mailto:hkstc@stc.group) Website: [www.stc.group](http://www.stc.group)

This report shall not be reproduced unless with prior written approval from The Hong Kong Standards and Testing Centre Limited.

For Conditions of Issuance of this test report, please refer to "Conditions of Issuance of Test Reports" section or Website.





## Test Report

Date : 2020-07-30  
 No. : HMD20070008

Page 17 of 74

**Limits for Radiated Emissions FCC 47 CFR 15.247 Class B]:**

Frequency Range [MHz]	Quasi-Peak Limits [ $\mu$ V/m]
0.009-0.490	2400/F (kHz)
0.490-1.705	24000/F (kHz)
1.705-30	30
30-88	100
88-216	150
216-960	200
Above960	500

The emission limits shown in the above table are based on measurement employing a CISPR quasi-peak detector and above 1000MHz are based on measurements employing an average detector.

**Result of Tx mode (2402.0 MHz) (GFSK) (9kHz – 30MHz): Pass**

Field Strength of Spurious Emissions Peak Value						
Frequency MHz	Measured Level dB $\mu$ V	Correction Factor dB/m	Field Strength dB $\mu$ V/m	Field Strength $\mu$ V/m	Limit uV/m	E-Field Polarity
<b>Emissions detected are more than 20 dB below the FCC Limits</b>						

**Result of Tx mode (2402.0 MHz) (GFSK) (Above 1GHz): Pass**

Field Strength of Spurious Emissions Peak Value						
Frequency MHz	Measured Level @3m dB $\mu$ V	Correction Factor dB/m	Field Strength dB $\mu$ V/m	Limit @3m dB $\mu$ V/m	Margin dB	E-Field Polarity
4804.0	15.7	41.5	57.2	74.0	16.8	Vertical
4804.0	14.6	42.4	57.0	74.0	17.0	Horizontal
7206.0	11.6	45.1	56.7	74.0	17.3	Vertical
7206.0	10.4	46.2	56.6	74.0	17.4	Horizontal
9608.0	7.2	48.0	55.2	74.0	18.8	Vertical
9608.0	6.9	48.8	55.7	74.0	18.3	Horizontal
12010.0	4.3	51.5	55.8	74.0	18.2	Vertical
12010.0	3.8	52.4	56.2	74.0	17.8	Horizontal

The Hong Kong Standards and Testing Centre Limited

10 Dai Wang Street, Taipo Industrial Estate, Tai Po, N.T., Hong Kong

Tel: +852 2666 1888 Fax: +852 2664 4353 Email: hkstc@stc.group Website: www.stc.group

This report shall not be reproduced unless with prior written approval from The Hong Kong Standards and Testing Centre Limited.

For Conditions of Issuance of this test report, please refer to "Conditions of Issuance of Test Reports" section or Website.



## Test Report

Date : 2020-07-30  
No. : HMD20070008

Page 18 of 74

<b>Field Strength of Spurious Emissions</b>						
<b>Average Value</b>						
Frequency MHz	Measured Level @3m dB $\mu$ V	Correction Factor dB/m	Field Strength dB $\mu$ V/m	Limit @3m dB $\mu$ V/m	Margin dB	E-Field Polarity
4804.0	0.6	41.5	42.1	54.0	11.9	Vertical
4804.0	-0.6	42.4	41.8	54.0	12.2	Horizontal
7206.0	-2.7	45.1	42.4	54.0	11.6	Vertical
7206.0	-4.5	46.2	41.7	54.0	12.3	Horizontal
9608.0	-7.4	48.0	40.6	54.0	13.4	Vertical
9608.0	-7.5	48.8	41.3	54.0	12.7	Horizontal
12010.0	-10.6	51.5	40.9	54.0	13.1	Vertical
12010.0	-10.3	52.4	42.1	54.0	11.9	Horizontal

**Result of Tx mode (2441.0 MHz) (GFSK) (9kHz – 30MHz): Pass**

<b>Field Strength of Spurious Emissions</b>						
<b>Peak Value</b>						
Frequency MHz	Measured Level dBuV	Correction Factor dB/m	Field Strength dBuV/m	Field Strength uV/m	Limit uV/m	E-Field Polarity
<b>Emissions detected are more than 20 dB below the FCC Limits</b>						

**Result of Tx mode (2441.0 MHz) (GFSK) (Above 1GHz): Pass**

<b>Field Strength of Spurious Emissions</b>						
<b>Peak Value</b>						
Frequency MHz	Measured Level @3m dB $\mu$ V	Correction Factor dB/m	Field Strength dB $\mu$ V/m	Limit @3m dB $\mu$ V/m	Margin dB	E-Field Polarity
4882.0	16.2	41.6	57.8	74.0	16.2	Vertical
4882.0	15.1	42.5	57.6	74.0	16.4	Horizontal
7323.0	11.5	45.2	56.7	74.0	17.3	Vertical
7323.0	10.2	46.3	56.5	74.0	17.5	Horizontal
9764.0	7.5	48.1	55.6	74.0	18.4	Vertical
9764.0	6.9	48.9	55.8	74.0	18.2	Horizontal
12205.0	4.4	51.6	56.0	74.0	18.0	Vertical
12205.0	3.8	52.5	56.3	74.0	17.7	Horizontal

The Hong Kong Standards and Testing Centre Limited

10 Dai Wang Street, Taipo Industrial Estate, Tai Po, N.T., Hong Kong

Tel: +852 2666 1888 Fax: +852 2664 4353 Email: hkstc@stc.group Website: www.stc.group

This report shall not be reproduced unless with prior written approval from The Hong Kong Standards and Testing Centre Limited.

For Conditions of Issuance of this test report, please refer to "Conditions of Issuance of Test Reports" section or Website.



## Test Report

Date : 2020-07-30  
 No. : HMD20070008

Page 19 of 74

<b>Field Strength of Spurious Emissions</b>						
<b>Average Value</b>						
Frequency MHz	Measured Level @3m dBuV	Correction Factor dB/m	Field Strength dBuV/m	Limit @3m dBuV/m	Margin dB	E-Field Polarity
4882.0	1.2	41.6	42.8	54.0	11.2	Vertical
4882.0	-0.1	42.5	42.4	54.0	11.6	Horizontal
7323.0	-4.1	45.2	41.1	54.0	12.9	Vertical
7323.0	-4.4	46.3	41.9	54.0	12.1	Horizontal
9764.0	-6.7	48.1	41.4	54.0	12.6	Vertical
9764.0	-8.9	48.9	40.0	54.0	14.0	Horizontal
12205.0	-9.6	51.6	42.0	54.0	12.0	Vertical
12205.0	-10.7	52.5	41.8	54.0	12.2	Horizontal

**Result of Tx mode (2480.0 MHz) (GFSK) (9kHz – 30MHz): Pass**

<b>Field Strength of Spurious Emissions</b>						
<b>Peak Value</b>						
Frequency MHz	Measured Level dBuV	Correction Factor dB/m	Field Strength dBuV/m	Field Strength uV/m	Limit uV/m	E-Field Polarity
<b>Emissions detected are more than 20 dB below the FCC Limits</b>						

**Result of Tx mode (2480.0 MHz) (GFSK) (Above 1GHz): Pass**

<b>Field Strength of Spurious Emissions</b>						
<b>Peak Value</b>						
Frequency MHz	Measured Level @3m dBμV	Correction Factor dB/m	Field Strength dBμV/m	Limit @3m dBμV/m	Margin dB	E-Field Polarity
4960.0	16.5	41.4	57.9	74.0	16.1	Vertical
4960.0	14.6	42.7	57.3	74.0	16.7	Horizontal
7440.0	11.2	45.6	56.8	74.0	17.2	Vertical
7440.0	10.5	46.5	57.0	74.0	17.0	Horizontal
9920.0	6.5	48.6	55.1	74.0	18.9	Vertical
9920.0	5.8	49.7	55.5	74.0	18.5	Horizontal
12400.0	4.4	51.7	56.1	74.0	17.9	Vertical
12400.0	3.1	52.7	55.8	74.0	18.2	Horizontal

The Hong Kong Standards and Testing Centre Limited

10 Dai Wang Street, Taipo Industrial Estate, Tai Po, N.T., Hong Kong

Tel: +852 2666 1888 Fax: +852 2664 4353 Email: hkstc@stc.group Website: www.stc.group

This report shall not be reproduced unless with prior written approval from The Hong Kong Standards and Testing Centre Limited.

For Conditions of Issuance of this test report, please refer to "Conditions of Issuance of Test Reports" section or Website.



## Test Report

Date : 2020-07-30  
 No. : HMD20070008

Page 20 of 74

Field Strength of Spurious Emissions						
Average Value						
Frequency MHz	Measured Level @3m dB $\mu$ V	Correction Factor dB/m	Field Strength dB $\mu$ V/m	Limit @3m dB $\mu$ V/m	Margin dB	E-Field Polarity
4960.0	0.9	41.4	42.3	54.0	11.7	Vertical
4960.0	-0.8	42.7	41.9	54.0	12.1	Horizontal
7440.0	-3.4	45.6	42.2	54.0	11.8	Vertical
7440.0	-4.8	46.5	41.7	54.0	12.3	Horizontal
9920.0	-8.3	48.6	40.3	54.0	13.7	Vertical
9920.0	-9.8	49.7	39.9	54.0	14.1	Horizontal
12400.0	-9.9	51.7	41.8	54.0	12.2	Vertical
12400.0	-12.5	52.7	40.2	54.0	13.8	Horizontal

**Result of Tx mode (2402.0 MHz) ( $\pi/4$ -DQPSK) (9kHz – 30MHz): Pass**

Field Strength of Spurious Emissions						
Peak Value						
Frequency MHz	Measured Level dB $\mu$ V	Correction Factor dB/m	Field Strength dB $\mu$ V/m	Field Strength uV/m	Limit uV/m	E-Field Polarity
<b>Emissions detected are more than 20 dB below the FCC Limits</b>						

**Result of Tx mode (2402.0 MHz) ( $\pi/4$ -DQPSK) (Above 1GHz): Pass**

Field Strength of Spurious Emissions						
Peak Value						
Frequency MHz	Measured Level @3m dB $\mu$ V	Correction Factor dB/m	Field Strength dB $\mu$ V/m	Limit @3m dB $\mu$ V/m	Margin dB	E-Field Polarity
4804.0	16.3	41.5	57.8	74.0	16.2	Vertical
4804.0	15.7	42.4	58.1	74.0	15.9	Horizontal
7206.0	12.6	45.1	57.7	74.0	16.3	Vertical
7206.0	11.2	46.2	57.4	74.0	16.6	Horizontal
9608.0	7.4	48.0	55.4	74.0	18.6	Vertical
9608.0	6.5	48.8	55.3	74.0	18.7	Horizontal
12010.0	4.4	51.5	55.9	74.0	18.1	Vertical
12010.0	3.7	52.4	56.1	74.0	17.9	Horizontal

The Hong Kong Standards and Testing Centre Limited

10 Dai Wang Street, Taipo Industrial Estate, Tai Po, N.T., Hong Kong

Tel: +852 2666 1888 Fax: +852 2664 4353 Email: hkstc@stc.group Website: www.stc.group

This report shall not be reproduced unless with prior written approval from The Hong Kong Standards and Testing Centre Limited.

For Conditions of Issuance of this test report, please refer to "Conditions of Issuance of Test Reports" section or Website.



## Test Report

Date : 2020-07-30  
 No. : HMD20070008

Page 21 of 74

Field Strength of Spurious Emissions						
Average Value						
Frequency MHz	Measured Level @3m dB $\mu$ V	Correction Factor dB/m	Field Strength dB $\mu$ V/m	Limit @3m dB $\mu$ V/m	Margin dB	E-Field Polarity
4804.0	0.8	41.5	42.3	54.0	11.7	Vertical
4804.0	0.7	42.4	43.1	54.0	10.9	Horizontal
7206.0	-3.6	45.1	41.5	54.0	12.5	Vertical
7206.0	-3.3	46.2	42.9	54.0	11.1	Horizontal
9608.0	-6.3	48.0	41.7	54.0	12.3	Vertical
9608.0	-7.7	48.8	41.1	54.0	12.9	Horizontal
12010.0	-9.4	51.5	42.1	54.0	11.9	Vertical
12010.0	-10.7	52.4	41.7	54.0	12.3	Horizontal

**Result of Tx mode (2441.0 MHz) ( $\pi/4$ -DQPSK) (9kHz – 30MHz): Pass**

Field Strength of Spurious Emissions						
Peak Value						
Frequency MHz	Measured Level dBuV	Correction Factor dB/m	Field Strength dBuV/m	Field Strength uV/m	Limit uV/m	E-Field Polarity
<b>Emissions detected are more than 20 dB below the FCC Limits</b>						

**Result of Tx mode (2441.0 MHz) ( $\pi/4$ -DQPSK) (Above 1GHz): Pass**

Field Strength of Spurious Emissions						
Peak Value						
Frequency MHz	Measured Level @3m dB $\mu$ V	Correction Factor dB/m	Field Strength dB $\mu$ V/m	Limit @3m dB $\mu$ V/m	Margin dB	E-Field Polarity
4882.0	16.5	41.6	58.1	74.0	15.9	Vertical
4882.0	15.1	42.5	57.6	74.0	16.4	Horizontal
7323.0	12.7	45.2	57.9	74.0	16.1	Vertical
7323.0	11.2	46.3	57.5	74.0	16.5	Horizontal
9764.0	6.8	48.1	54.9	74.0	19.1	Vertical
9764.0	5.7	48.9	54.6	74.0	19.4	Horizontal
12205.0	4.7	51.6	56.3	74.0	17.7	Vertical
12205.0	3.6	52.5	56.1	74.0	17.9	Horizontal

The Hong Kong Standards and Testing Centre Limited

10 Dai Wang Street, Taipo Industrial Estate, Tai Po, N.T., Hong Kong

Tel: +852 2666 1888 Fax: +852 2664 4353 Email: hkstc@stc.group Website: www.stc.group

This report shall not be reproduced unless with prior written approval from The Hong Kong Standards and Testing Centre Limited.

For Conditions of Issuance of this test report, please refer to "Conditions of Issuance of Test Reports" section or Website.



## Test Report

Date : 2020-07-30  
 No. : HMD20070008

Page 22 of 74

Field Strength of Spurious Emissions						
Average Value						
Frequency MHz	Measured Level @3m dBuV	Correction Factor dB/m	Field Strength dBuV/m	Limit @3m dBuV/m	Margin dB	E-Field Polarity
4882.0	1.2	41.6	42.8	54.0	11.2	Vertical
4882.0	-0.4	42.5	42.1	54.0	11.9	Horizontal
7323.0	-2.6	45.2	42.6	54.0	11.4	Vertical
7323.0	-4.2	46.3	42.1	54.0	11.9	Horizontal
9764.0	-7.4	48.1	40.7	54.0	13.3	Vertical
9764.0	-8.8	48.9	40.1	54.0	13.9	Horizontal
12205.0	-9.7	51.6	41.9	54.0	12.1	Vertical
12205.0	-11.3	52.5	41.2	54.0	12.8	Horizontal

**Result of Tx mode (2480.0 MHz) ( $\pi/4$ -DQPSK) (9kHz – 30MHz): Pass**

Field Strength of Spurious Emissions						
Peak Value						
Frequency MHz	Measured Level dBuV	Correction Factor dB/m	Field Strength dBuV/m	Field Strength uV/m	Limit uV/m	E-Field Polarity
<b>Emissions detected are more than 20 dB below the FCC Limits</b>						

**Result of Tx mode (2480.0 MHz) ( $\pi/4$ -DQPSK) (Above 1GHz): Pass**

Field Strength of Spurious Emissions						
Peak Value						
Frequency MHz	Measured Level @3m dB $\mu$ V	Correction Factor dB/m	Field Strength dB $\mu$ V/m	Limit @3m dB $\mu$ V/m	Margin dB	E-Field Polarity
4960.0	15.9	41.4	57.3	74.0	16.7	Vertical
4960.0	14.9	42.7	57.6	74.0	16.4	Horizontal
7440.0	11.4	45.6	57.0	74.0	17.0	Vertical
7440.0	10.3	46.5	56.8	74.0	17.2	Horizontal
9920.0	6.9	48.6	55.5	74.0	18.5	Vertical
9920.0	5.3	49.7	55.0	74.0	19.0	Horizontal
12400.0	4.5	51.7	56.2	74.0	17.8	Vertical
12400.0	3.3	52.7	56.0	74.0	18.0	Horizontal

The Hong Kong Standards and Testing Centre Limited

10 Dai Wang Street, Taipo Industrial Estate, Tai Po, N.T., Hong Kong

Tel: +852 2666 1888 Fax: +852 2664 4353 Email: hkstc@stc.group Website: www.stc.group

This report shall not be reproduced unless with prior written approval from The Hong Kong Standards and Testing Centre Limited.

For Conditions of Issuance of this test report, please refer to "Conditions of Issuance of Test Reports" section or Website.



## Test Report

Date : 2020-07-30  
No. : HMD20070008

Page 23 of 74

Field Strength of Spurious Emissions Average Value						
Frequency MHz	Measured Level @3m dB $\mu$ V	Correction Factor dB/m	Field Strength dB $\mu$ V/m	Limit @3m dB $\mu$ V/m	Margin dB	E-Field Polarity
4960.0	1.1	41.4	42.5	54.0	11.5	Vertical
4960.0	-0.5	42.7	42.2	54.0	11.8	Horizontal
7440.0	-3.4	45.6	42.2	54.0	11.8	Vertical
7440.0	-5.1	46.5	41.4	54.0	12.6	Horizontal
9920.0	-7.0	48.6	41.6	54.0	12.4	Vertical
9920.0	-8.9	49.7	40.8	54.0	13.2	Horizontal
12400.0	-9.4	51.7	42.3	54.0	11.7	Vertical
12400.0	-11.0	52.7	41.7	54.0	12.3	Horizontal

### Remarks:

No additional spurious emissions found between lowest internal used/generated frequency and 30 MHz

\* Denotes restricted band of operation.

Measurements were made using a peak detector. Any emission less than 1000MHz and falling within the restricted bands of FCC Rules Part 15 Section 15.205 and the limits of FCC Rules Part 15 Section 15.209 were applied.

Correction Factor included Antenna Factor and Cable Attenuation.

Calculated measurement uncertainty (9kHz-30MHz): 2.0dB  
(30MHz -1GHz): 4.9dB  
(1GHz -6GHz): 4.02dB  
(6GHz -26.5GHz): 4.03dB

Emissions in the vertical and horizontal polarizations have been investigated and the worst-case test results are recorded in this report.

The Hong Kong Standards and Testing Centre Limited

10 Dai Wang Street, Taipo Industrial Estate, Tai Po, N.T., Hong Kong

Tel: +852 2666 1888 Fax: +852 2664 4353 Email: hkstc@stc.group Website: www.stc.group

This report shall not be reproduced unless with prior written approval from The Hong Kong Standards and Testing Centre Limited.

For Conditions of Issuance of this test report, please refer to "Conditions of Issuance of Test Reports" section or Website.



## Test Report

Date : 2020-07-30  
 No. : HMD20070008

Page 24 of 74

**Radiated Emissions Measurement:**

**Limit :**

In any 100 kHz bandwidth outside the frequency band in which the spread spectrum or digitally modulated intentional radiator is operating, the radio frequency power that is produced by the intentional radiator shall be at least 20 dB below that in the 100 kHz bandwidth within the band that contains the highest level of the desired power, based on either an RF conducted or a radiated measurement. Attenuation below the general limits specified in Section 15.209(a) is not required. In addition, radiated emissions which fall in the restricted bands, as defined in Section 15.205(a), must also comply with the radiated emission limits specified in Section 15.209(a) (see Section 5.205(c)).

**Result: RF Radiated Emissions (Lowest)-GFSK**

Field Strength of Band-edge Compliance Peak Value						
Frequency MHz	Measured Level @3m dB $\mu$ V	Correction Factor dB/m	Field Strength dB $\mu$ V/m	Limit @3m dB $\mu$ V/m	Margin dB	E-Field Polarity
2390.0	18.4	36.8	55.2	74.0	18.8	Vertical

Field Strength of Band-edge Compliance Average Value						
Frequency MHz	Measured Level @3m dB $\mu$ V	Correction Factor dB/m	Field Strength dB $\mu$ V/m	Limit @3m dB $\mu$ V/m	Margin dB	E-Field Polarity
2390.0	4.5	36.8	41.3	54.0	12.7	Vertical

**Result: RF Radiated Emissions (Highest) -GFSK**

Field Strength of Band-edge Compliance Peak Value						
Frequency MHz	Measured Level @3m dB $\mu$ V	Correction Factor dB/m	Field Strength dB $\mu$ V/m	Limit @3m dB $\mu$ V/m	Margin dB	E-Field Polarity
2483.5	24.0	36.4	60.4	74.0	13.6	Horizontal

Field Strength of Band-edge Compliance Average Value						
Frequency MHz	Measured Level @3m dB $\mu$ V	Correction Factor dB/m	Field Strength dB $\mu$ V/m	Limit @3m dB $\mu$ V/m	Margin dB	E-Field Polarity
2483.5	7.4	36.4	43.8	54.0	10.2	Horizontal





## Test Report

Date : 2020-07-30  
 No. : HMD20070008

Page 25 of 74

**Result: RF Radiated Emissions (Lowest)-  $\pi/4$ -DQPSK**

Field Strength of Band-edge Compliance Peak Value						
Frequency	Measured Level @3m	Correction Factor	Field Strength	Limit @3m	Margin	E-Field Polarity
MHz	dB $\mu$ V	dB/m	dB $\mu$ V/m	dB $\mu$ V/m	dB	
2390.0	18.7	36.8	55.5	74.0	18.5	Vertical

Field Strength of Band-edge Compliance Average Value						
Frequency	Measured Level @3m	Correction Factor	Field Strength	Limit @3m	Margin	E-Field Polarity
MHz	dB $\mu$ V	dB/m	dB $\mu$ V/m	dB $\mu$ V/m	dB	
2390.0	5.1	36.8	41.9	54.0	12.1	Vertical

**Result: RF Radiated Emissions (Highest) - $\pi/4$ -DQPSK**

Field Strength of Band-edge Compliance Peak Value						
Frequency	Measured Level @3m	Correction Factor	Field Strength	Limit @3m	Margin	E-Field Polarity
MHz	dB $\mu$ V	dB/m	dB $\mu$ V/m	dB $\mu$ V/m	dB	
2483.5	24.9	36.4	61.3	74.0	12.7	Horizontal

Field Strength of Band-edge Compliance Average Value						
Frequency	Measured Level @3m	Correction Factor	Field Strength	Limit @3m	Margin	E-Field Polarity
MHz	dB $\mu$ V	dB/m	dB $\mu$ V/m	dB $\mu$ V/m	dB	
2483.5	7.0	36.4	43.4	54.0	10.6	Horizontal

## Test Report

Date : 2020-07-30  
 No. : HMD20070008

Page 26 of 74

**Limits for Radiated Emissions FCC 47 CFR 15.247 Class B]:**

Frequency Range [MHz]	Quasi-Peak Limits [μV/m]
0.009-0.490	2400/F (kHz)
0.490-1.705	24000/F (kHz)
1.705-30	30
30-88	100
88-216	150
216-960	200
Above960	500

The emission limits shown in the above table are based on measurement employing a CISPR quasi-peak detector and above 1000MHz are based on measurements employing an average detector.

**Results of Bluetooth play mode (GFSK 2402.0 MHz) (30MHz – 1GHz): Pass**

Horizontal

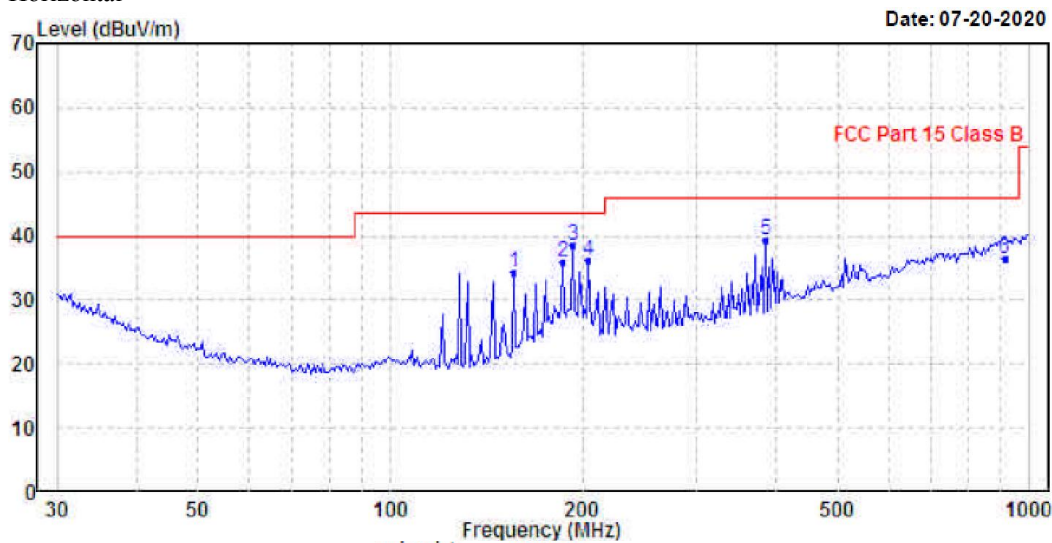

	Limit	Over			
Freq	Level	Line	Limit	Remark	Pol/Phase
MHz	dBuV/m	dBuV/m	dB		
1	155.910	34.24	43.50	-9.26 QP	Horizontal
2	185.788	35.90	43.50	-7.60 QP	Horizontal
3	192.419	38.48	43.50	-5.02 QP	Horizontal
4	203.523	36.29	43.50	-7.21 QP	Horizontal
5	385.281	39.29	46.00	-6.71 QP	Horizontal
6	912.862	36.55	46.00	-9.45 QP	Horizontal

The Hong Kong Standards and Testing Centre Limited

10 Dai Wang Street, Taipo Industrial Estate, Tai Po, N.T., Hong Kong

Tel: +852 2666 1888 Fax: +852 2664 4353 Email: hkstc@stc.group Website: www.stc.group

This report shall not be reproduced unless with prior written approval from The Hong Kong Standards and Testing Centre Limited.

For Conditions of Issuance of this test report, please refer to "Conditions of Issuance of Test Reports" section or Website.

## Test Report

Date : 2020-07-30  
 No. : HMD20070008

Page 27 of 74

### Limits for Radiated Emissions FCC 47 CFR 15.247 Class B]:

Frequency Range [MHz]	Quasi-Peak Limits [ $\mu$ V/m]
0.009-0.490	2400/F (kHz)
0.490-1.705	24000/F (kHz)
1.705-30	30
30-88	100
88-216	150
216-960	200
Above960	500

The emission limits shown in the above table are based on measurement employing a CISPR quasi-peak detector and above 1000MHz are based on measurements employing an average detector.

### Results of Bluetooth play mode (GFSK 2402.0 MHz) (30MHz – 1GHz): Pass

Vertical

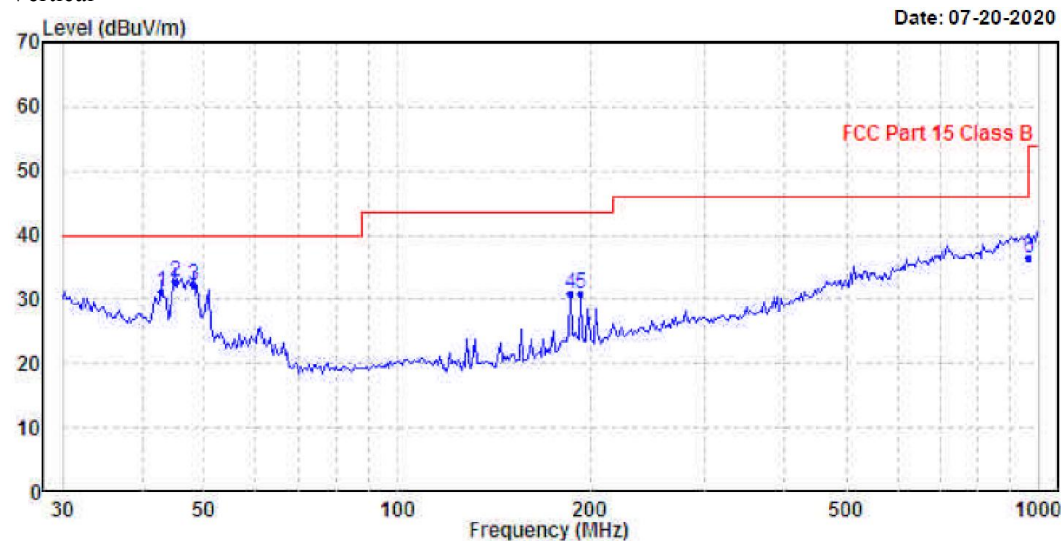

	Freq	Level	Limit	Over	Limit	Remark	Pol/Phase
	MHz	dBuV/m	dBuV/m	dB			
1	42.900	31.19	40.00	-8.81	QP		Vertical
2	45.058	32.83	40.00	-7.17	QP		Vertical
3	47.994	32.20	40.00	-7.80	QP		Vertical
4	185.788	30.87	43.50	-12.63	QP		Vertical
5	192.419	31.00	43.50	-12.50	QP		Vertical
6	958.794	36.53	46.00	-9.47	QP		Vertical

Remarks: Calculated measurement uncertainty (30MHz – 1GHz): 4.9dB

Emissions in the vertical and horizontal polarizations have been investigated and the worst-case test results are recorded in this report.

The Hong Kong Standards and Testing Centre Limited

10 Dai Wang Street, Taipo Industrial Estate, Tai Po, N.T., Hong Kong

Tel: +852 2666 1888 Fax: +852 2664 4353 Email: hkstc@stc.group Website: www.stc.group

This report shall not be reproduced unless with prior written approval from The Hong Kong Standards and Testing Centre Limited.

For Conditions of Issuance of this test report, please refer to "Conditions of Issuance of Test Reports" section or Website.

## Test Report

Date : 2020-07-30  
No. : HMD20070008

Page 28 of 74

### 3.1.3 AC Mains Conducted Emissions (0.15MHz to 30MHz)

Test Requirement:	FCC 47CFR 15.207
Test Method:	ANSI C63.10:2013
Test Date:	2020-07-23
Mode of Operation:	Bluetooth play mode
Test Voltage:	120V a.c. 60Hz

Ambient Temperature: 25°C      Relative Humidity: 51%      Atmospheric Pressure: 101 kPa

#### Test Method:

The test was performed in accordance with ANSI C63.10:2013, with the following: an initial measurement was performed in peak and average detection mode on the live line, any emissions recorded within 30dB of the relevant limit line were re-measured using quasi-peak and average detection on the live and neutral lines with the worst case recorded in the table of results.

#### Receiver Setting:

Bandw. = 9 kHz, Meas. Time= 10.0 ms, Step Width = 5.0kHz  
Detector = MaxPeak and CISPR AV

#### Test Setup:

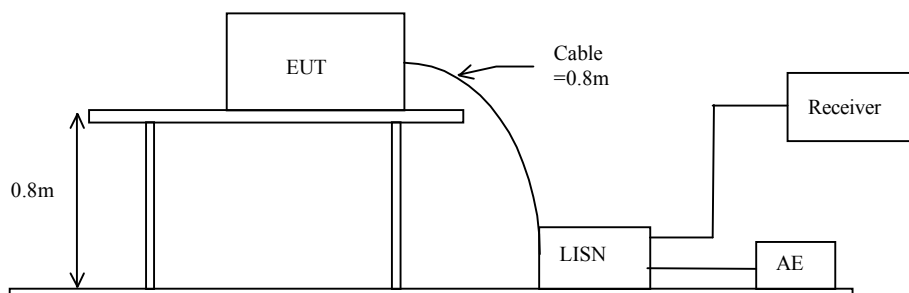



## Test Report

Date : 2020-07-30  
 No. : HMD20070008

Page 29 of 74

**Limits for Conducted Emissions (FCC 47 CFR 15.207):**

Frequency Range [MHz]	Quasi-Peak Limits [dBμV]	Average [dBμV]
0.15-0.5	66 to 56*	56 to 46*
0.5-5.0	56	46
5.0-30.0	60	50

\* Decreases with the logarithm of the frequency.

**Results of Bluetooth play mode (L): PASS**

Please refer to the following diagram for individual results.

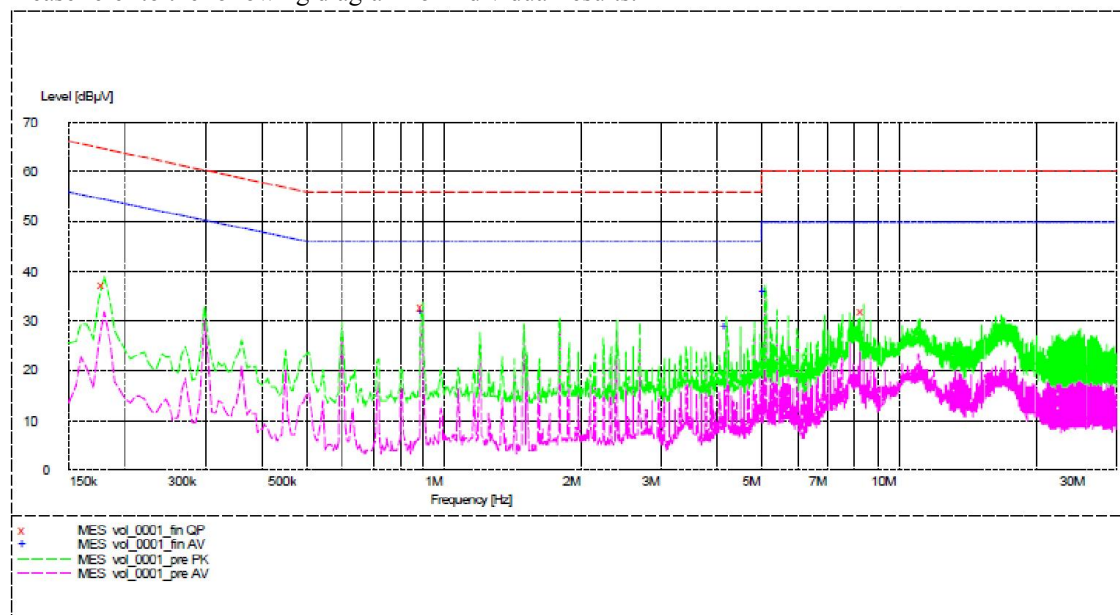

MEASUREMENT RESULT: "vol\_0001\_fin AV"

7/23/2020 7:16PM

Frequency MHz	Level dBμV	Transd dB	Limit dBμV	Margin dB	Line	PE
0.900000	32.00	9.7	46	14.0	L1	GND
4.195000	28.80	9.7	46	17.2	L1	GND
5.095000	35.90	9.7	50	14.1	L1	GND

MEASUREMENT RESULT: "vol\_0001\_fin QP"

7/23/2020 7:16PM

Frequency MHz	Level dBμV	Transd dB	Limit dBμV	Margin dB	Line	PE
0.180000	37.30	9.6	65	27.2	L1	GND
0.900000	33.00	9.7	56	23.0	L1	GND
8.395000	32.20	9.8	60	27.8	L1	GND

The Hong Kong Standards and Testing Centre Limited

10 Dai Wang Street, Taipo Industrial Estate, Tai Po, N.T., Hong Kong

Tel: +852 2666 1888 Fax: +852 2664 4353 Email: hkstc@stc.group Website: www.stc.group

This report shall not be reproduced unless with prior written approval from The Hong Kong Standards and Testing Centre Limited.

For Conditions of Issuance of this test report, please refer to "Conditions of Issuance of Test Reports" section or Website.



## Test Report

Date : 2020-07-30  
 No. : HMD20070008

Page 30 of 74

Frequency Range [MHz]	Quasi-Peak Limits [dB $\mu$ V]	Average [dB $\mu$ V]
0.15-0.5	66 to 56*	56 to 46*
0.5-5.0	56	46
5.0-30.0	60	50

\* Decreases with the logarithm of the frequency.

**Results of Bluetooth play mode (N): PASS**

Please refer to the following diagram for individual results.

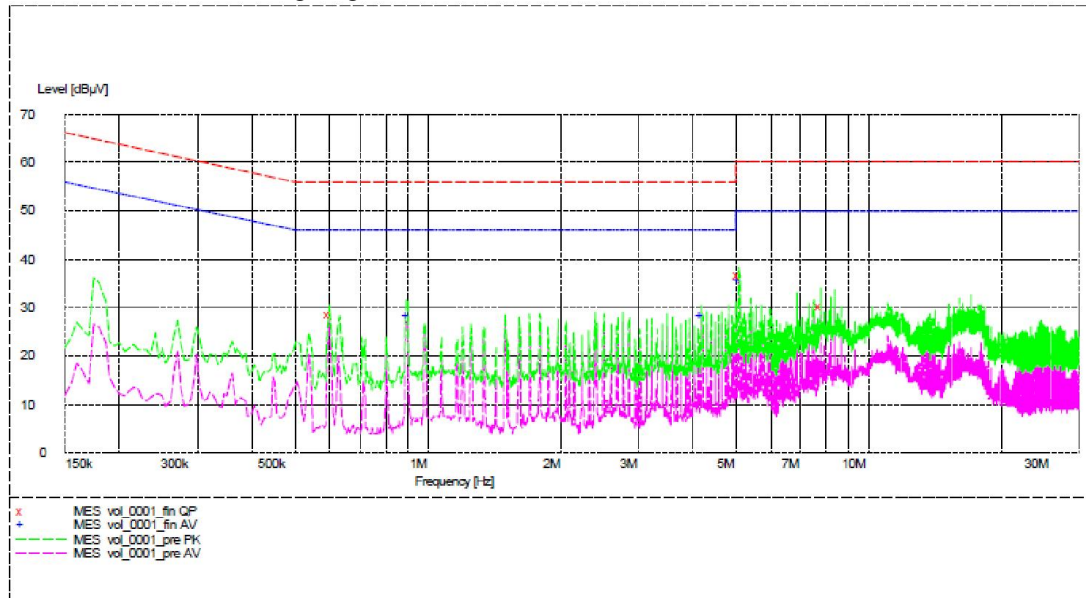

MEASUREMENT RESULT: "vol\_0001\_fin AV"

7/23/2020 7:14PM

Frequency MHz	Level dB $\mu$ V	Transd dB	Limit dB $\mu$ V	Margin dB	Line	PE
0.900000	28.30	9.7	46	17.7	N	GND
4.195000	28.40	9.7	46	17.6	N	GND
5.095000	35.60	9.7	50	14.4	N	GND

MEASUREMENT RESULT: "vol\_0001\_fin QP"

7/23/2020 7:14PM

Frequency MHz	Level dB $\mu$ V	Transd dB	Limit dB $\mu$ V	Margin dB	Line	PE
0.600000	28.50	9.7	56	27.5	N	GND
5.095000	36.80	9.7	60	23.2	N	GND
7.790000	30.50	9.8	60	29.5	N	GND

**Remarks:**

Calculated measurement uncertainty (0.15MHz – 30MHz): 3.25dB

-\*- Emission(s) that is far below the corresponding limit line.

The Hong Kong Standards and Testing Centre Limited

10 Dai Wang Street, Taipo Industrial Estate, Tai Po, N.T., Hong Kong

Tel: +852 2666 1888 Fax: +852 2664 4353 Email: hkstc@stc.group Website: www.stc.group

This report shall not be reproduced unless with prior written approval from The Hong Kong Standards and Testing Centre Limited.

For Conditions of Issuance of this test report, please refer to "Conditions of Issuance of Test Reports" section or Website.





## Test Report

Date : 2020-07-30  
No. : HMD20070008

Page 31 of 74

### 3.1.4 Number of Hopping Frequency

Ambient Temperature: 25°C      Relative Humidity: 51%      Atmospheric Pressure: 101 kPa

#### Limit of Number of Hopping Frequency

Frequency hopping systems in the 2400–2483.5 MHz band shall use at least 15 channels

#### Test Method:

The RF output of the EUT was connected to the spectrum analyzer by a low loss cable.

#### Spectrum Analyzer Setting:

RBW = 300kHz, VBW  $\geq$  RBW, Sweep = Auto, Span = the frequency band of operation  
Detector = Peak, Trace = Max. hold

#### Test Setup:

As Test Setup of clause 3.1.1 in this test report.

#### Measurement Data:

##### GFSK: 79 of 79 Channel

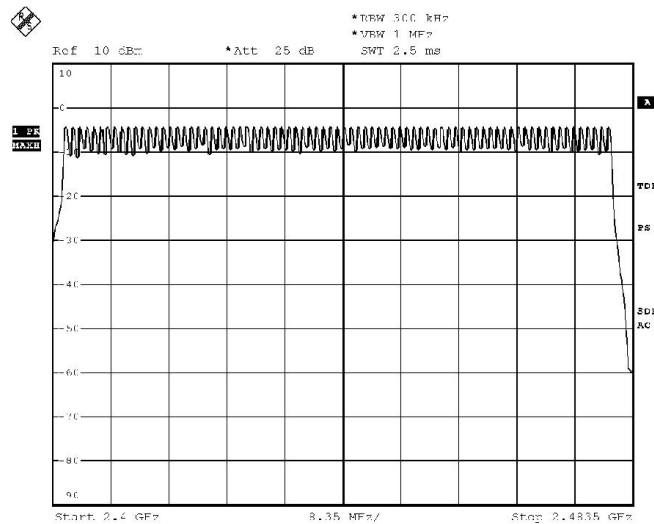

The Hong Kong Standards and Testing Centre Limited

10 Dai Wang Street, Taipo Industrial Estate, Tai Po, N.T., Hong Kong

Tel: +852 2666 1888 Fax: +852 2664 4353 Email: hkstc@stc.group Website: www.stc.group

This report shall not be reproduced unless with prior written approval from The Hong Kong Standards and Testing Centre Limited.

For Conditions of Issuance of this test report, please refer to "Conditions of Issuance of Test Reports" section or Website.

## Test Report

Date : 2020-07-30  
 No. : HMD20070008

Page 32 of 74

$\pi/4$ -DQPSK: 79 of 79 Channel



\*RBW 300 kHz  
 \*VBW 1 MHz  
 SWT 2.5 ms

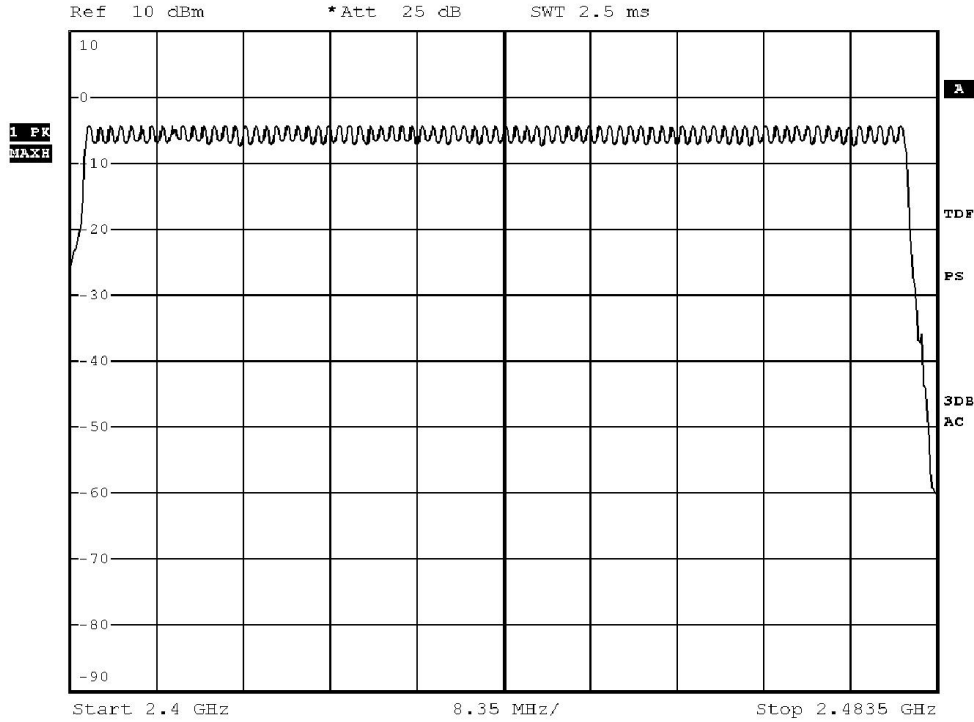

The Hong Kong Standards and Testing Centre Limited

10 Dai Wang Street, Taipo Industrial Estate, Tai Po, N.T., Hong Kong

Tel: +852 2666 1888 Fax: +852 2664 4353 Email: [hkstc@stc.group](mailto:hkstc@stc.group) Website: [www.stc.group](http://www.stc.group)

This report shall not be reproduced unless with prior written approval from The Hong Kong Standards and Testing Centre Limited.

For Conditions of Issuance of this test report, please refer to "Conditions of Issuance of Test Reports" section or Website.





## Test Report

Date : 2020-07-30  
No. : HMD20070008

Page 33 of 74

### 3.1.5 20dB Bandwidth

Test Requirement: FCC 47CFR 15.247(a)(1)  
Test Method: ANSI C63.10:2013  
Test Date: 2020-07-22  
Mode of Operation: Tx mode

Ambient Temperature: 25°C      Relative Humidity: 51%      Atmospheric Pressure: 101 kPa

#### **Remark:**

The result has been done on all the possible configurations for searching the worst cases.

#### **Test Method:**

The bandwidth is measured at an amplitude level reduced from the reference level by a specified ratio. The reference level is the level of the highest amplitude signal observed from the transmitter at the fundamental frequency. Once the reference level is established, the equipment is conditioned with typical modulating signal to produce the worst-case (i.e. the widest) bandwidth.

#### **Spectrum Analyzer Setting:**

RBW = 30kHz, VBW  $\geq$  RBW, Sweep = Auto, Span = two times and five times the OBW  
Detector = Peak, Trace = Max. hold

#### **Test Setup:**

As Test Setup of clause 3.1.1 in this test report.

The Hong Kong Standards and Testing Centre Limited

10 Dai Wang Street, Taipo Industrial Estate, Tai Po, N.T., Hong Kong

Tel: +852 2666 1888 Fax: +852 2664 4353 Email: [hkstc@stc.group](mailto:hkstc@stc.group) Website: [www.stc.group](http://www.stc.group)

This report shall not be reproduced unless with prior written approval from The Hong Kong Standards and Testing Centre Limited.

For Conditions of Issuance of this test report, please refer to "Conditions of Issuance of Test Reports" section or Website.





## Test Report

Date : 2020-07-30  
 No. : HMD20070008

Page 35 of 74

Fundamental Frequency [MHz]	20dB Bandwidth [kHz]	FCC Limits [MHz]
2441	795.0	Within 2400-2483.5

### (Middle Operating Frequency) - (GFSK)

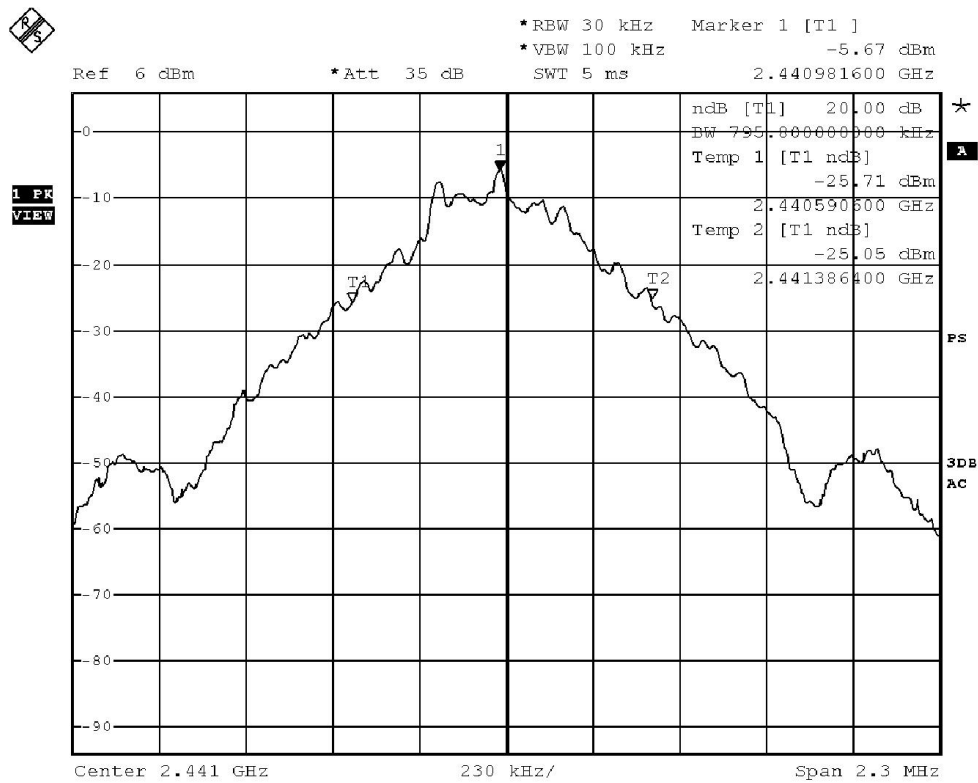

The Hong Kong Standards and Testing Centre Limited

10 Dai Wang Street, Taipo Industrial Estate, Tai Po, N.T., Hong Kong

Tel: +852 2666 1888 Fax: +852 2664 4353 Email: hkstc@stc.group Website: www.stc.group

This report shall not be reproduced unless with prior written approval from The Hong Kong Standards and Testing Centre Limited.

For Conditions of Issuance of this test report, please refer to "Conditions of Issuance of Test Reports" section or Website.



## Test Report

Date : 2020-07-30  
 No. : HMD20070008

Page 36 of 74

Fundamental Frequency [MHz]	20dB Bandwidth [kHz]	FCC Limits [MHz]
2480	791.2	Within 2400-2483.5

### (Highest Operating Frequency) - (GFSK)

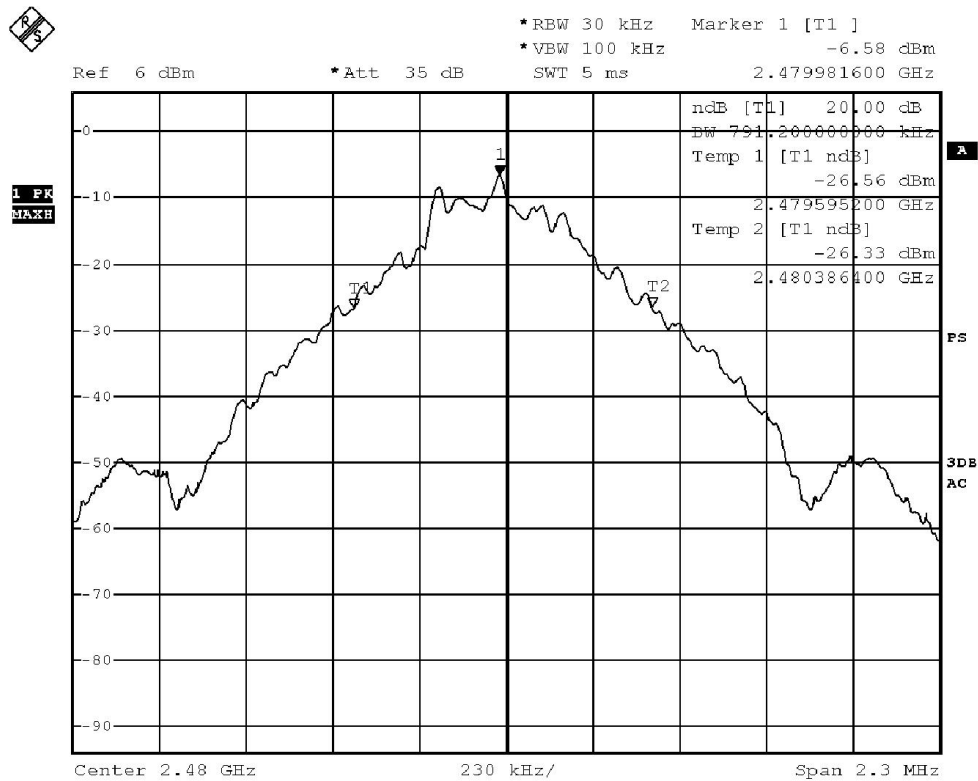

The Hong Kong Standards and Testing Centre Limited

10 Dai Wang Street, Taipo Industrial Estate, Tai Po, N.T., Hong Kong

Tel: +852 2666 1888 Fax: +852 2664 4353 Email: hkstc@stc.group Website: www.stc.group

This report shall not be reproduced unless with prior written approval from The Hong Kong Standards and Testing Centre Limited.

For Conditions of Issuance of this test report, please refer to "Conditions of Issuance of Test Reports" section or Website.



## Test Report

Date : 2020-07-30  
 No. : HMD20070008

Page 37 of 74

Fundamental Frequency [MHz]	20dB Bandwidth [MHz]	FCC Limits [MHz]
2402	1.200	Within 2400-2483.5

**(Lowest Operating Frequency) - ( $\pi/4$  DQPSK)**

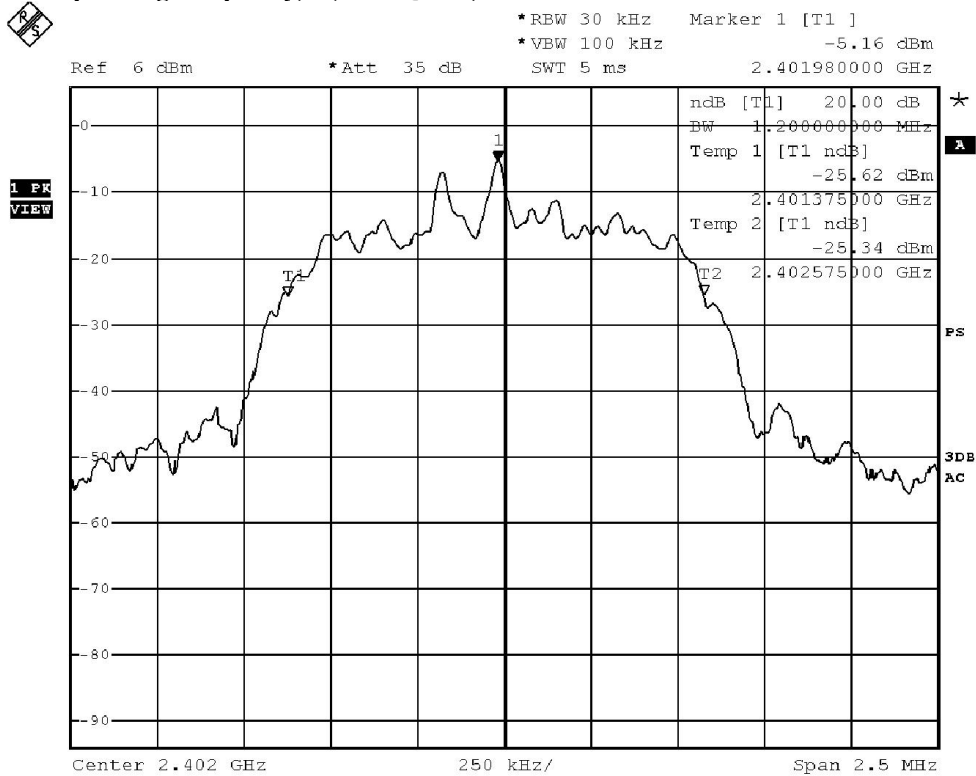



## Test Report

Date : 2020-07-30  
 No. : HMD20070008

Page 38 of 74

Fundamental Frequency [MHz]	20dB Bandwidth [MHz]	FCC Limits [MHz]
2441	1.200	Within 2400-2483.5

(Middle Operating Frequency) - ( $\pi/4$  DQPSK)

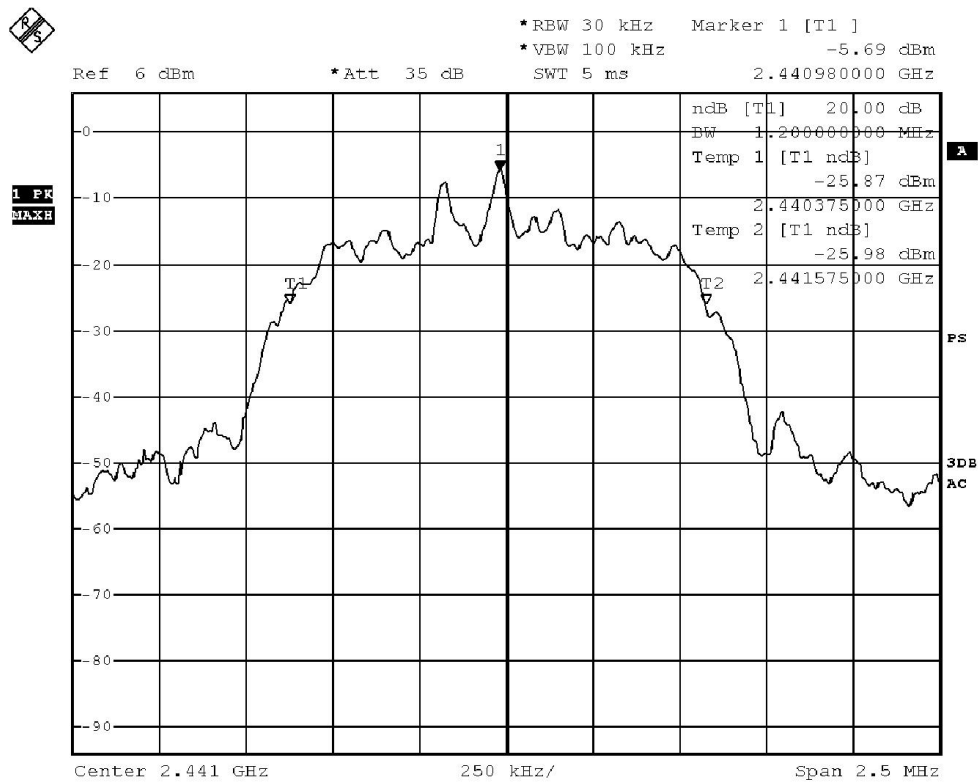

The Hong Kong Standards and Testing Centre Limited

10 Dai Wang Street, Taipo Industrial Estate, Tai Po, N.T., Hong Kong

Tel: +852 2666 1888 Fax: +852 2664 4353 Email: hkstc@stc.group Website: www.stc.group

This report shall not be reproduced unless with prior written approval from The Hong Kong Standards and Testing Centre Limited.

For Conditions of Issuance of this test report, please refer to "Conditions of Issuance of Test Reports" section or Website.



## Test Report

Date : 2020-07-30  
 No. : HMD20070008

Page 39 of 74

Fundamental Frequency [MHz]	20dB Bandwidth [MHz]	FCC Limits [MHz]
2480	1.200	Within 2400-2483.5

**(Highest Operating Frequency) - ( $\pi/4$  DQPSK)**

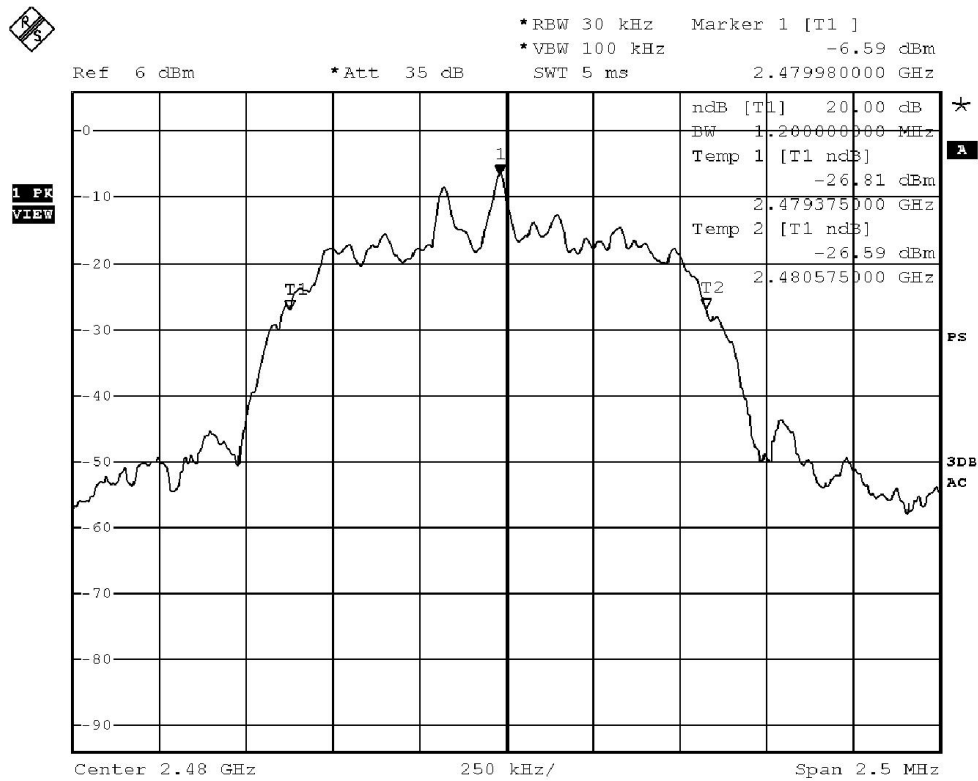



## Test Report

Date : 2020-07-30  
No. : HMD20070008

Page 40 of 74

### 3.1.6 Hopping Channel Separation

Ambient Temperature: 25°C

Relative Humidity: 51%

Atmospheric Pressure: 101 kPa

#### Requirements:

Frequency hopping systems operating in the 2400-2483.5 MHz band may have hopping channel carrier frequencies that are separated by 25 kHz or two-thirds of the 20 dB bandwidth of the hopping channel, whichever is greater, provided the systems operate with an output power no greater than 125 mW.

#### Spectrum Analyzer Setting:

RBW = 300kHz, VBW  $\geq$  RBW, Sweep = Auto,  
Span = Wide enough to capture the peaks of two adjacent channels  
Detector = Peak, Trace = Max. hold

#### Limit:

The measured maximum bandwidth \* 2/3 = 1.2MHz \* 2/3 = 800kHz

The Hong Kong Standards and Testing Centre Limited

10 Dai Wang Street, Taipo Industrial Estate, Tai Po, N.T., Hong Kong

Tel: +852 2666 1888 Fax: +852 2664 4353 Email: [hkstc@stc.group](mailto:hkstc@stc.group) Website: [www.stc.group](http://www.stc.group)

This report shall not be reproduced unless with prior written approval from The Hong Kong Standards and Testing Centre Limited.

For Conditions of Issuance of this test report, please refer to "Conditions of Issuance of Test Reports" section or Website.





# Test Report

Date : 2020-07-30  
No. : HMD20070008

Page 41 of 74

Channel separation = 1MHz (>800kHz) (Lowest) (GFSK)

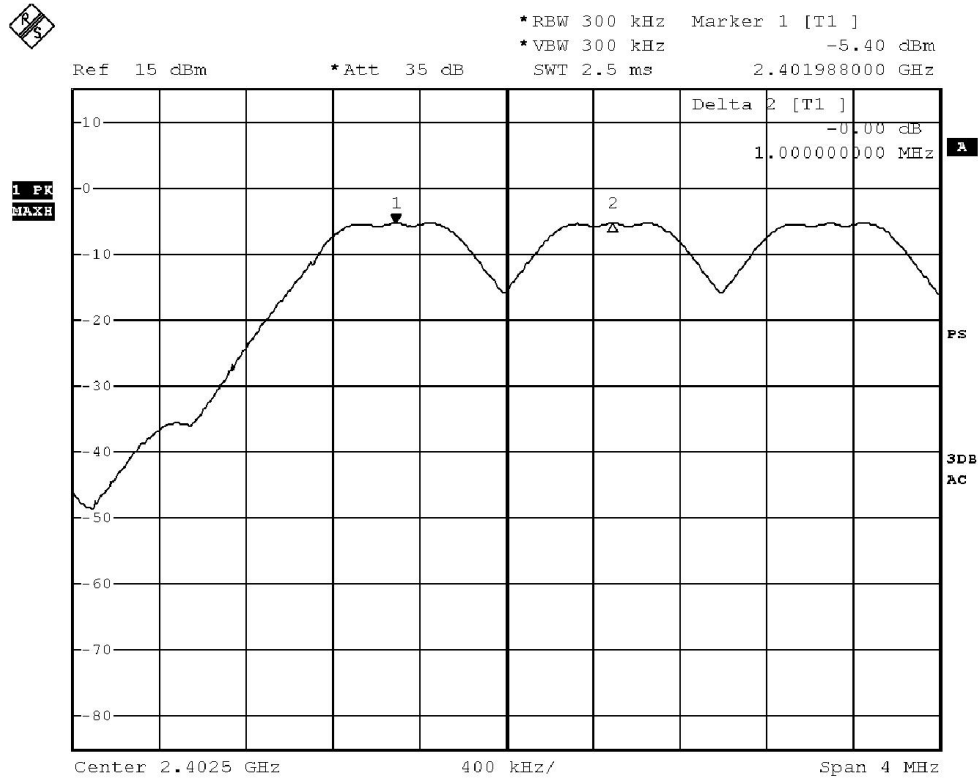

The Hong Kong Standards and Testing Centre Limited

10 Dai Wang Street, Taipo Industrial Estate, Tai Po, N.T., Hong Kong

Tel: +852 2666 1888 Fax: +852 2664 4353 Email: hkstc@stc.group Website: www.stc.group

This report shall not be reproduced unless with prior written approval from The Hong Kong Standards and Testing Centre Limited.

For Conditions of Issuance of this test report, please refer to "Conditions of Issuance of Test Reports" section or Website.



# Test Report

Date : 2020-07-30  
No. : HMD20070008

Page 42 of 74

## Channel separation = 1MHz (>800kHz) (Mid) (GFSK)



\*RBW 300 kHz Marker 1 [T1 ]  
\*VBW 300 kHz -5.91 dBm  
SWT 2.5 ms 2.440988000 GHz

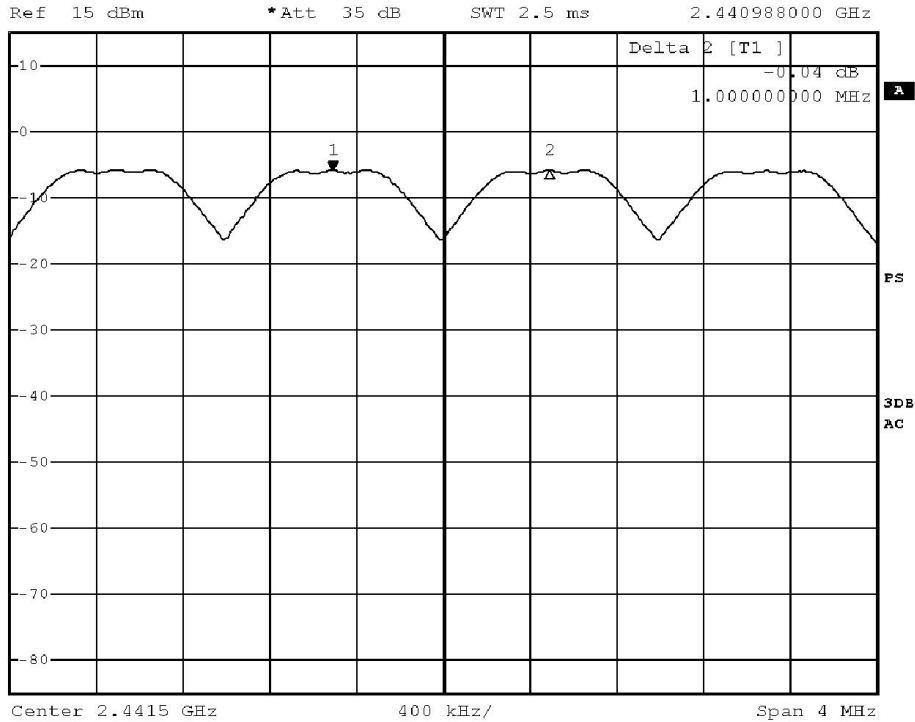

The Hong Kong Standards and Testing Centre Limited

10 Dai Wang Street, Taipo Industrial Estate, Tai Po, N.T., Hong Kong

Tel: +852 2666 1888 Fax: +852 2664 4353 Email: hkstc@stc.group Website: www.stc.group

This report shall not be reproduced unless with prior written approval from The Hong Kong Standards and Testing Centre Limited.

For Conditions of Issuance of this test report, please refer to "Conditions of Issuance of Test Reports" section or Website.



# Test Report

Date : 2020-07-30  
No. : HMD20070008

Page 43 of 74

Channel separation = 1MHz (>800kHz) (Highest) (GFSK)

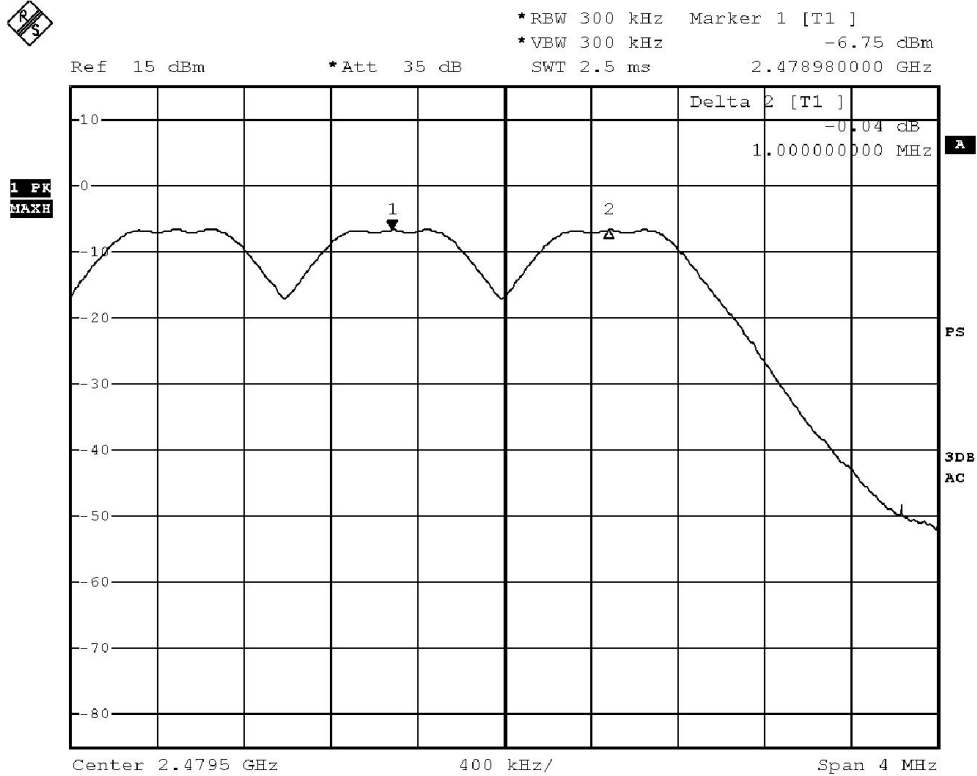



# Test Report

Date : 2020-07-30  
No. : HMD20070008

Page 44 of 74

Channel separation = 1MHz (>800kHz) (Lowest) ( $\pi/4$  DQPSK)

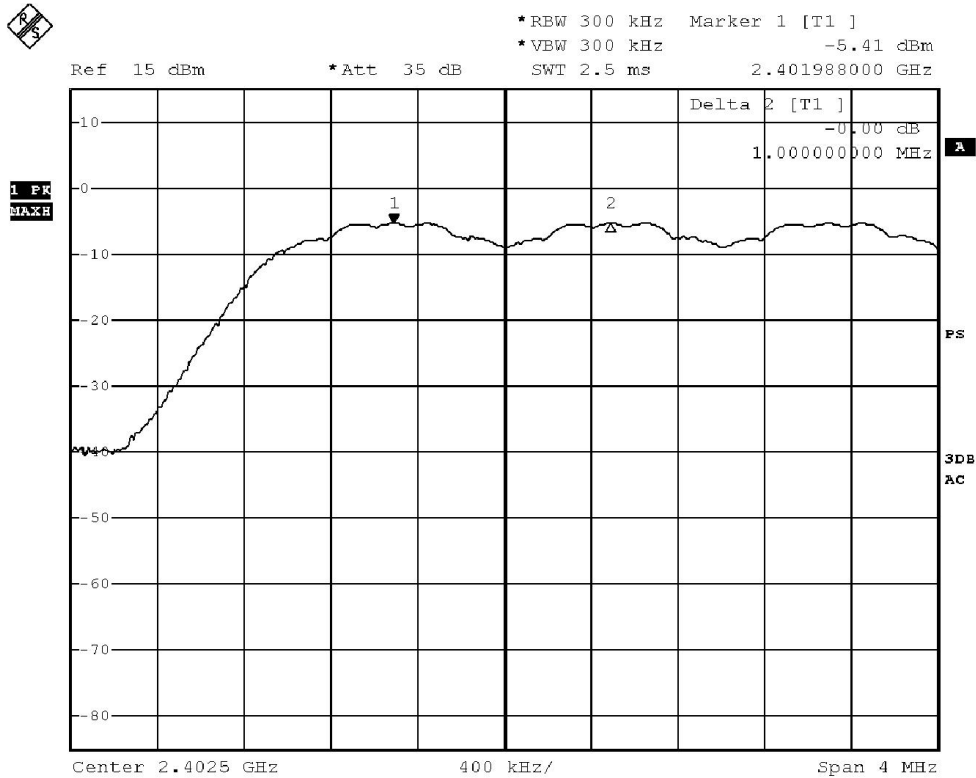

The Hong Kong Standards and Testing Centre Limited

10 Dai Wang Street, Taipo Industrial Estate, Tai Po, N.T., Hong Kong

Tel: +852 2666 1888 Fax: +852 2664 4353 Email: hkstc@stc.group Website: www.stc.group

This report shall not be reproduced unless with prior written approval from The Hong Kong Standards and Testing Centre Limited.

For Conditions of Issuance of this test report, please refer to "Conditions of Issuance of Test Reports" section or Website.



# Test Report

Date : 2020-07-30  
No. : HMD20070008

Page 45 of 74

Channel separation = 1MHz (>800kHz) (Mid) ( $\pi/4$  DQPSK)

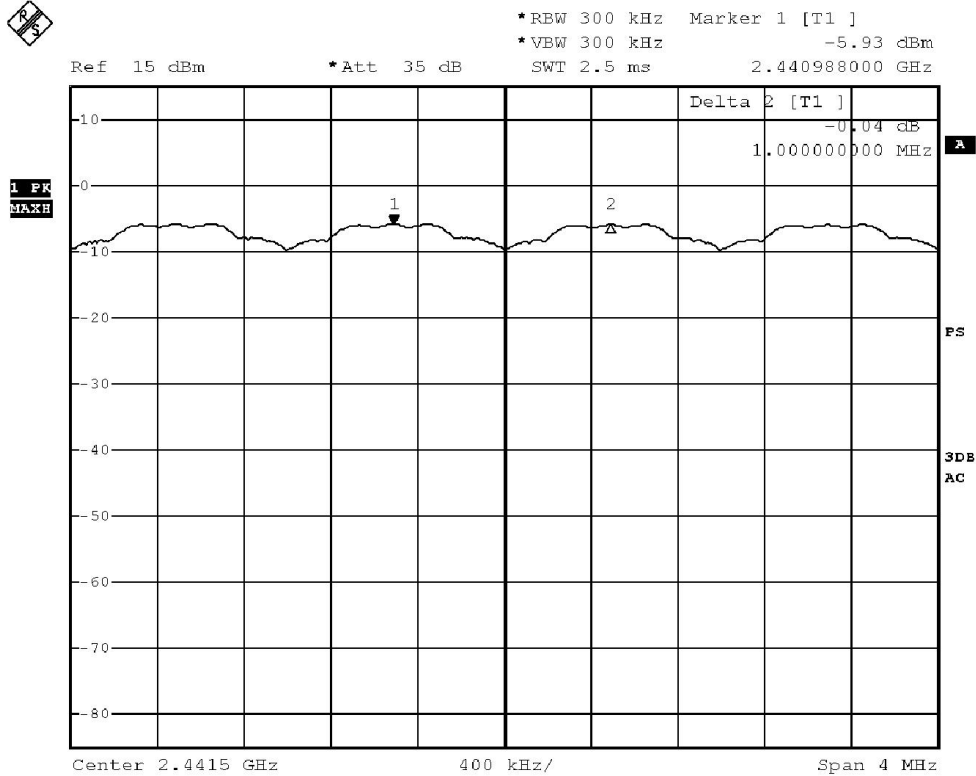

The Hong Kong Standards and Testing Centre Limited

10 Dai Wang Street, Taipo Industrial Estate, Tai Po, N.T., Hong Kong

Tel: +852 2666 1888 Fax: +852 2664 4353 Email: hkstc@stc.group Website: www.stc.group

This report shall not be reproduced unless with prior written approval from The Hong Kong Standards and Testing Centre Limited.

For Conditions of Issuance of this test report, please refer to "Conditions of Issuance of Test Reports" section or Website.



# Test Report

Date : 2020-07-30  
No. : HMD20070008

Page 46 of 74

Channel separation = 1MHz (>800kHz) (Highest) ( $\pi/4$  DQPSK)



\*RBW 300 kHz Marker 1 [T1 ]  
\*VBW 300 kHz -6.76 dBm  
SWT 2.5 ms 2.478980000 GHz

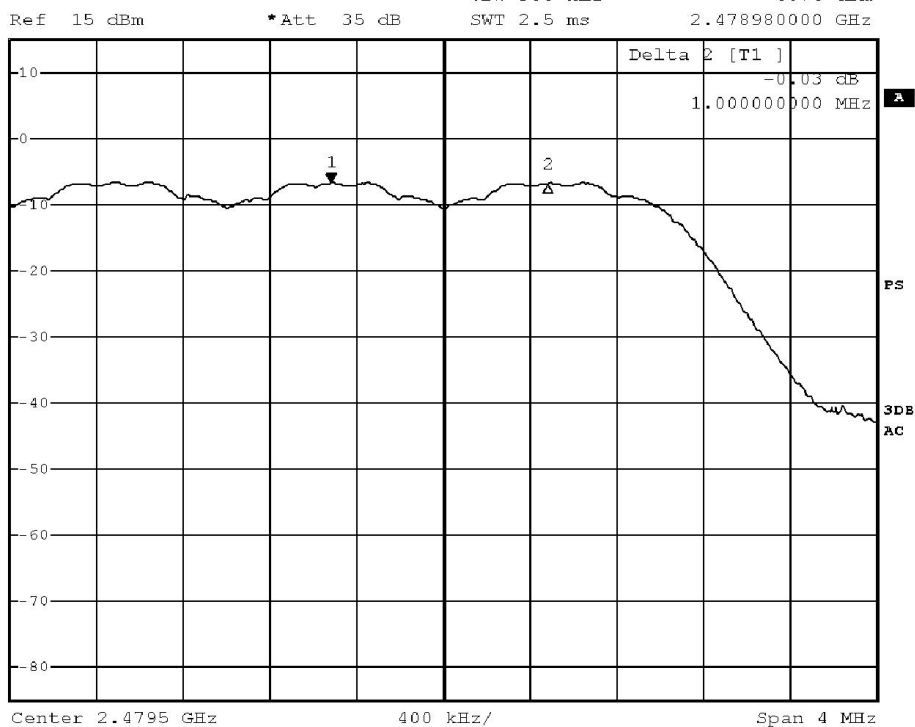

The Hong Kong Standards and Testing Centre Limited

10 Dai Wang Street, Taipo Industrial Estate, Tai Po, N.T., Hong Kong

Tel: +852 2666 1888 Fax: +852 2664 4353 Email: [hkstc@stc.group](mailto:hkstc@stc.group) Website: [www.stc.group](http://www.stc.group)

This report shall not be reproduced unless with prior written approval from The Hong Kong Standards and Testing Centre Limited.

For Conditions of Issuance of this test report, please refer to "Conditions of Issuance of Test Reports" section or Website.



## Test Report

Date : 2020-07-30  
No. : HMD20070008

Page 47 of 74

### 3.1.7 Band-edge Compliance of RF Conducted Emissions Measurement:

Ambient Temperature: 25°C      Relative Humidity: 51%      Atmospheric Pressure: 101 kPa

#### Limit :

In any 100 kHz bandwidth outside the frequency band in which the spread spectrum or digitally modulated intentional radiator is operating, the radio frequency power that is produced by the intentional radiator shall be at least 20 dB below that in the 100 kHz bandwidth within the band that contains the highest level of the desired power, based on either an RF conducted or a radiated measurement. Attenuation below the general limits specified in Section 15.209(a) is not required.

According to the test method DA 00-705.

#### Spectrum Analyzer Setting:

RBW = 100kHz, VBW= 300kHz, Sweep = Coupled,

Span = Wide enough to capture the peak level of the emission operating on the channel closest to the band edge, as well as any modulation products that fall outside of the authorized band of operation.

Detector = Peak, Trace = Max. hold

Remark: Emissions under the fixed frequency mode and hopping mode have been investigated, the worst-case measurement results were recorded in the test report

The Hong Kong Standards and Testing Centre Limited

10 Dai Wang Street, Taipo Industrial Estate, Tai Po, N.T., Hong Kong

Tel: +852 2666 1888 Fax: +852 2664 4353 Email: [hkstc@stc.group](mailto:hkstc@stc.group) Website: [www.stc.group](http://www.stc.group)

This report shall not be reproduced unless with prior written approval from The Hong Kong Standards and Testing Centre Limited.

For Conditions of Issuance of this test report, please refer to "Conditions of Issuance of Test Reports" section or Website.

## Test Report

Date : 2020-07-30  
 No. : HMD20070008

Page 48 of 74

**Band-edge Compliance of RF Conducted Emissions Measurement:**

Frequency Range [MHz]	Reference level [dB $\mu$ V]	Limit [dB $\mu$ V]	The highest conducted band edge emission [dB $\mu$ V]	Result
2400 – Lowest Fundamental (2402)	101.9	81.9	71.57	PASS

**Band-edge Compliance of RF Emissions – Lowest (GFSK) (Hopping on)**

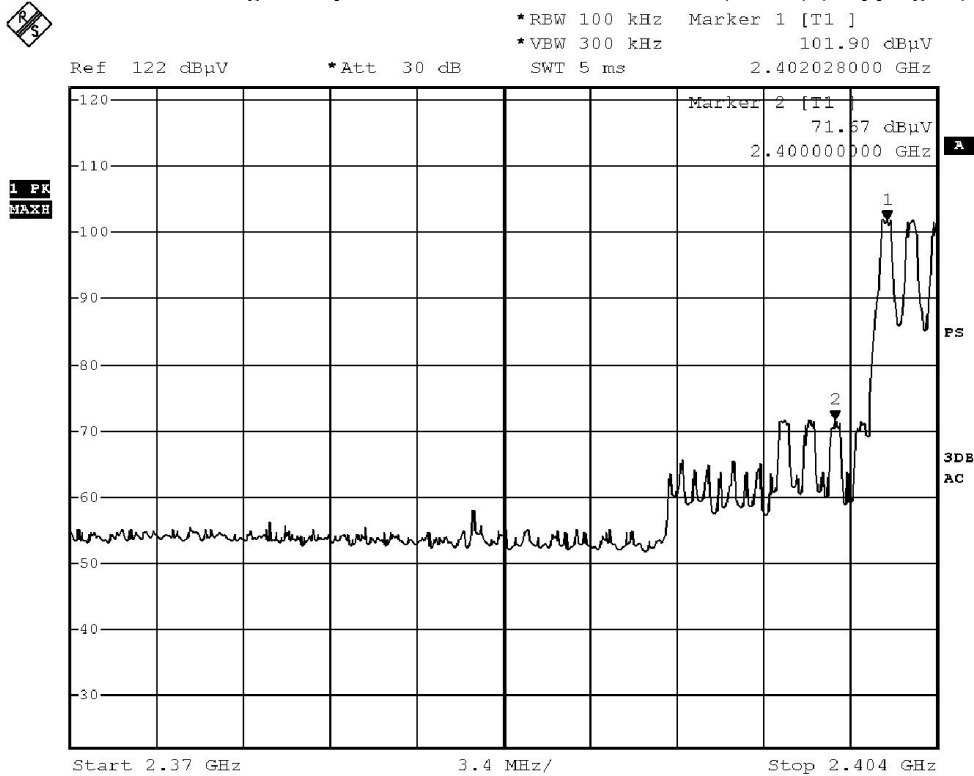



## Test Report

Date : 2020-07-30  
 No. : HMD20070008

**Band-edge Compliance of RF Conducted Emissions Measurement:**

Frequency Range [MHz]	Reference level [dB $\mu$ V]	Limit [dB $\mu$ V]	The highest conducted band edge emission [dB $\mu$ V]	Result
2400 – Lowest Fundamental (2402)	101.9	81.9	71.57	PASS

**Band-edge Compliance of RF Emissions – Lowest (GFSK) (Hopping off)**

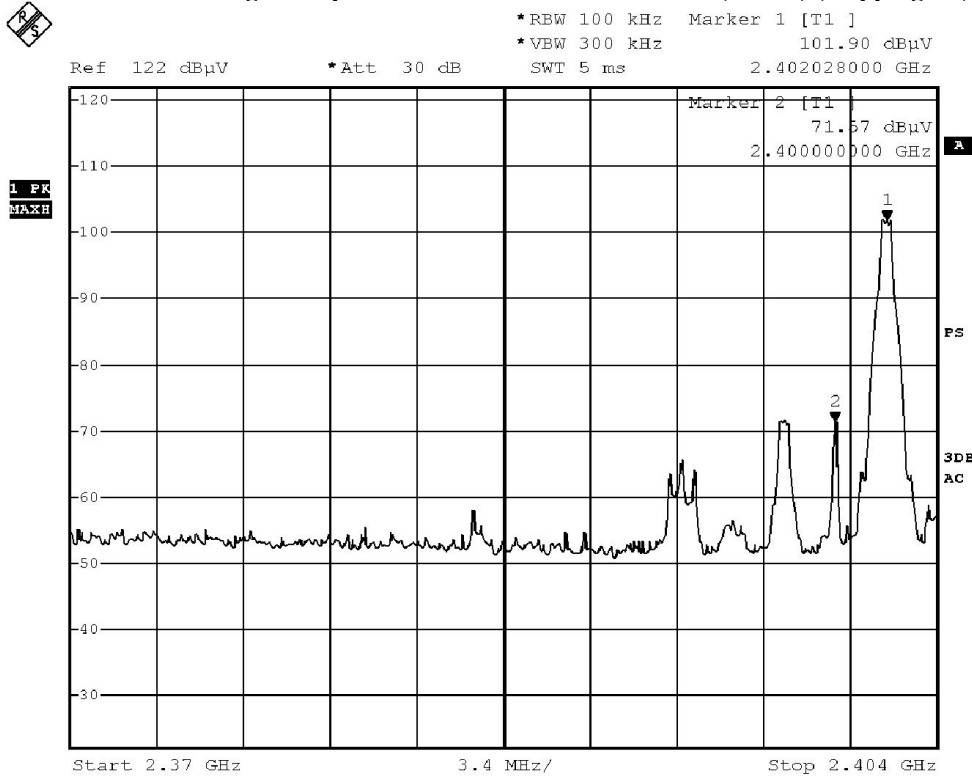





## Test Report

Date : 2020-07-30  
 No. : HMD20070008

Page 51 of 74

**Band-edge Compliance of RF Conducted Emissions Measurement:**

Frequency Range [MHz]	Reference level [dB $\mu$ V]	Limit [dB $\mu$ V]	The highest conducted band edge emission [dB $\mu$ V]	Result
2483.5 - Highest Fundamental (2480)	100.61	80.61	53.05	PASS

**Band-edge Compliance of RF Emissions – Highest (GFSK) (Hopping off)**

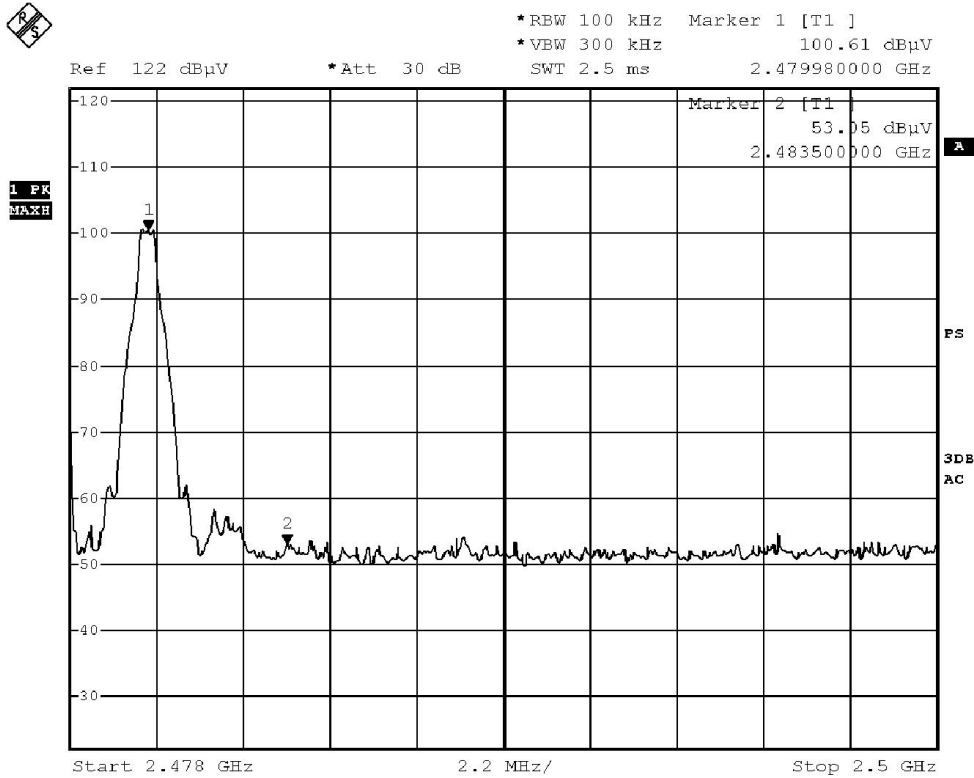

The Hong Kong Standards and Testing Centre Limited

10 Dai Wang Street, Taipo Industrial Estate, Tai Po, N.T., Hong Kong

Tel: +852 2666 1888 Fax: +852 2664 4353 Email: hkstc@stc.group Website: www.stc.group

This report shall not be reproduced unless with prior written approval from The Hong Kong Standards and Testing Centre Limited.

For Conditions of Issuance of this test report, please refer to "Conditions of Issuance of Test Reports" section or Website.









## Test Report

Date : 2020-07-30  
 No. : HMD20070008

Page 55 of 74

**Band-edge Compliance of RF Conducted Emissions Measurement:**

Frequency Range [MHz]	Reference level [dB $\mu$ V]	Limit [dB $\mu$ V]	The highest conducted band edge emission [dB $\mu$ V]	Result
2483.5 - Highest Fundamental (2480)	100.63	80.63	52.60	PASS

**Band-edge Compliance of RF Emissions – Highest ( $\pi/4$  DQPSK) (Hopping off)**

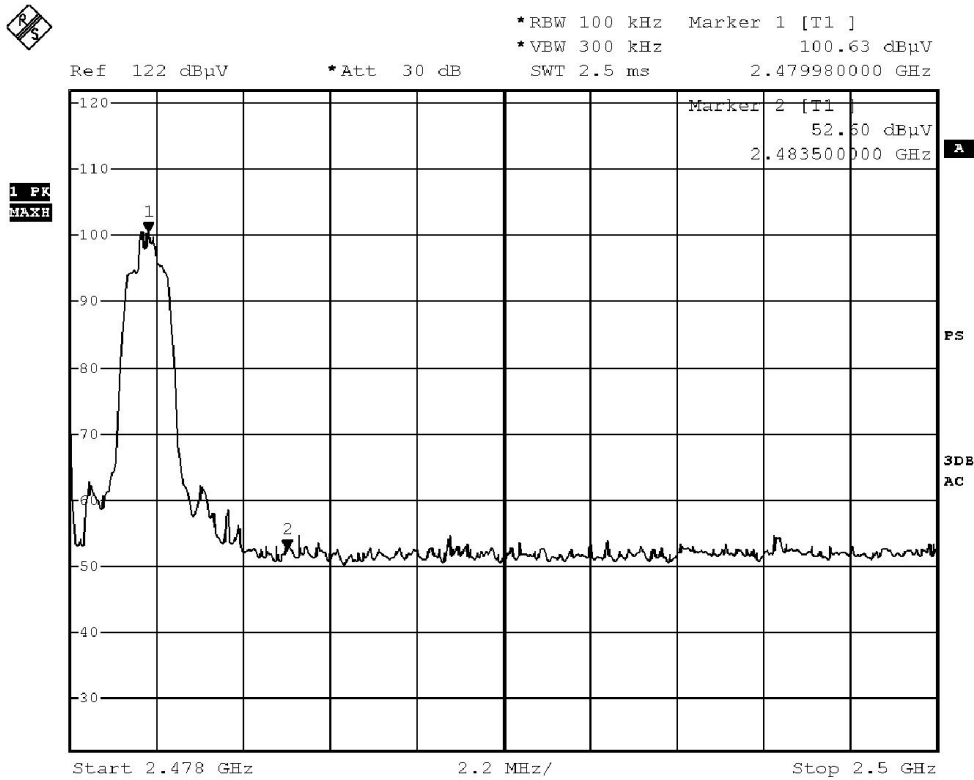

## Test Report

Date : 2020-07-30  
 No. : HMD20070008

Page 56 of 74

**Compliance of RF Conducted Emissions Measurement:**

**Limit :**

In any 100 kHz bandwidth outside the frequency band in which the spread spectrum or digitally modulated intentional radiator is operating, the radio frequency power that is produced by the intentional radiator shall be at least 20 dB below that in the 100 kHz bandwidth within the band that contains the highest level of the desired power, based on either an RF conducted or a radiated measurement. Attenuation below the general limits specified in Section 15.209(a) is not required.

Remark: Emissions under the fixed frequency mode and hopping mode have been investigated, the worst-case measurement results were recorded in the test report

**Compliance of RF Emissions – (GFSK 2402MHz) (the worst case)**

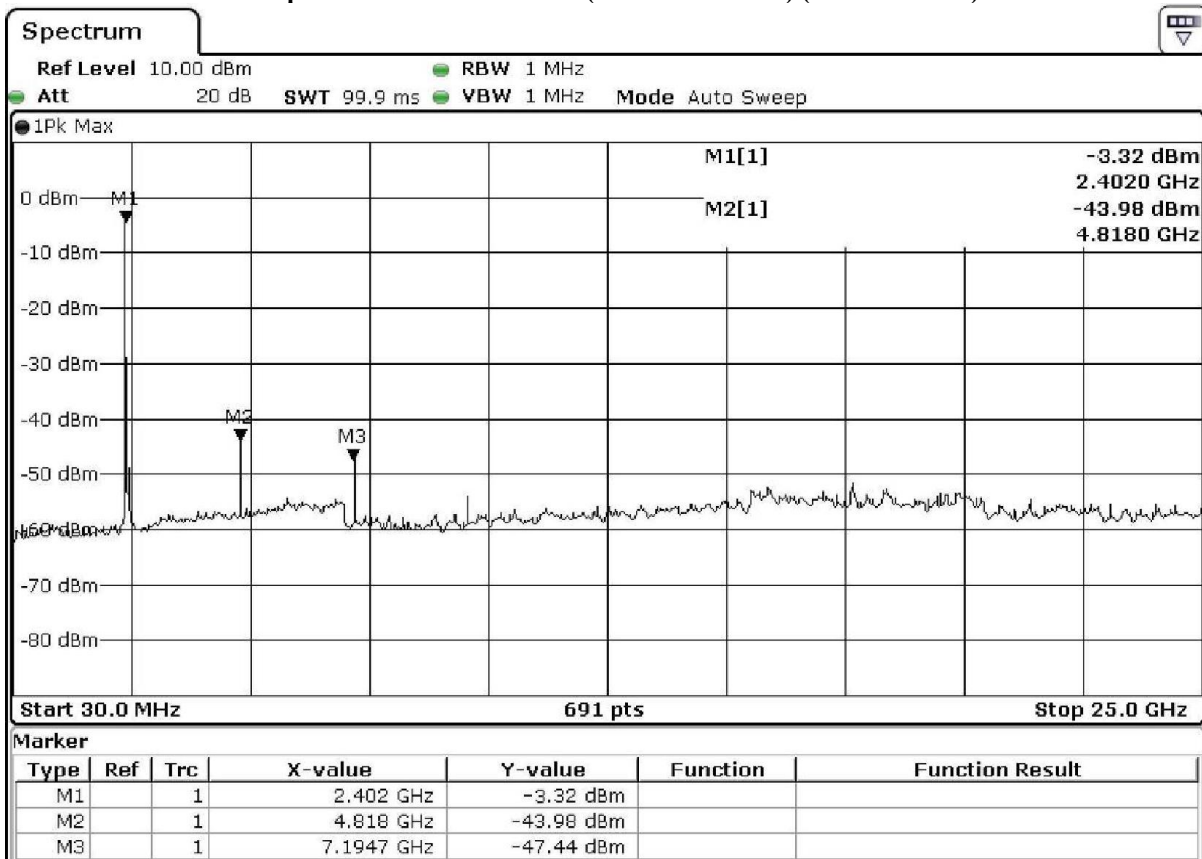





## Test Report

Date : 2020-07-30  
 No. : HMD20070008

Page 57 of 74

### Compliance of RF Emissions – ( $\pi/4$ -DQPSK 2402MHz) (the worst case)

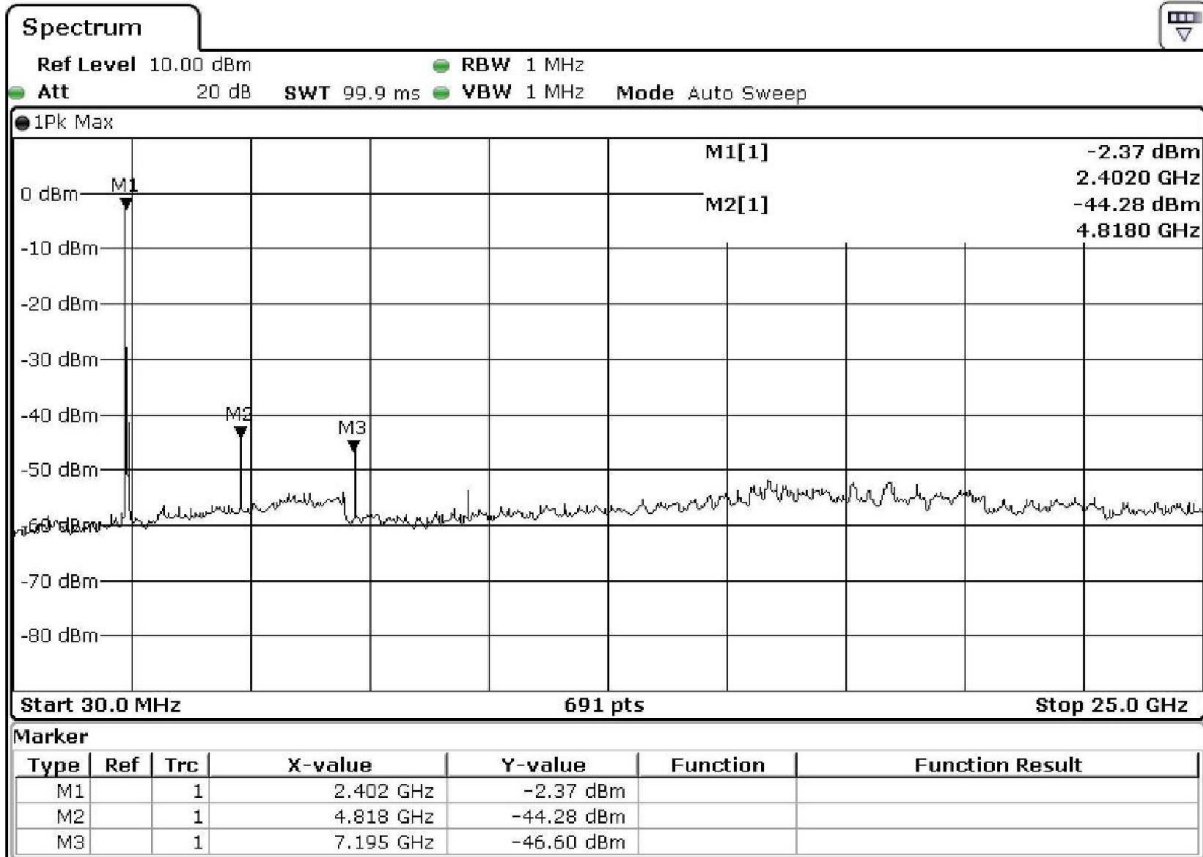

## Test Report

Date : 2020-07-30  
 No. : HMD20070008

Page 58 of 74

### 3.1.8 Time of Occupancy (Dwell Time)

Ambient Temperature: 25°C      Relative Humidity: 51%      Atmospheric Pressure: 101 kPa

**Requirements:**

The average time of occupancy on any channel shall not be greater than 0.4 seconds within a period of 0.4 seconds multiplied by the number of hopping channel employed.

No requirements for Digital Transmission System.

**Spectrum Analyzer Setting:**

RBW = 300kHz, VBW ≥ RBW,

Sweep = A longer sweep time to show two successive hops on a channel,

Span = Zero, Detector = Peak, Trace = Max. hold

Dwell Time = Pulse Duration \* hop rate / number of channel \* observation duration

Observed duration: 0.4s x 79 = 31.6s

**Measurement Data:**

**Channel Occupied in  $\pi/4$ -DQPSK: 79 of 79 Channel**

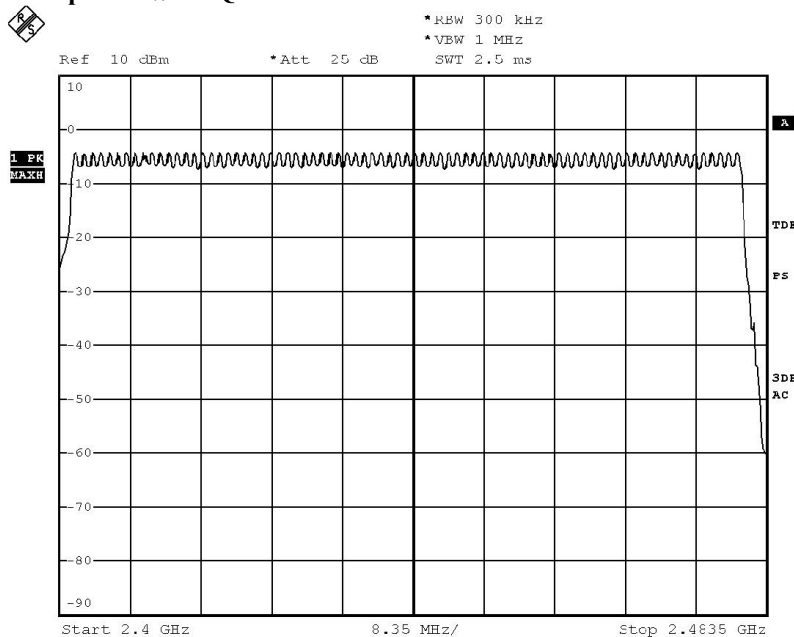





## Test Report

Date : 2020-07-30  
No. : HMD20070008

Page 61 of 74

**Fig. C**  
**[Pulse duration of Highest Channel]**

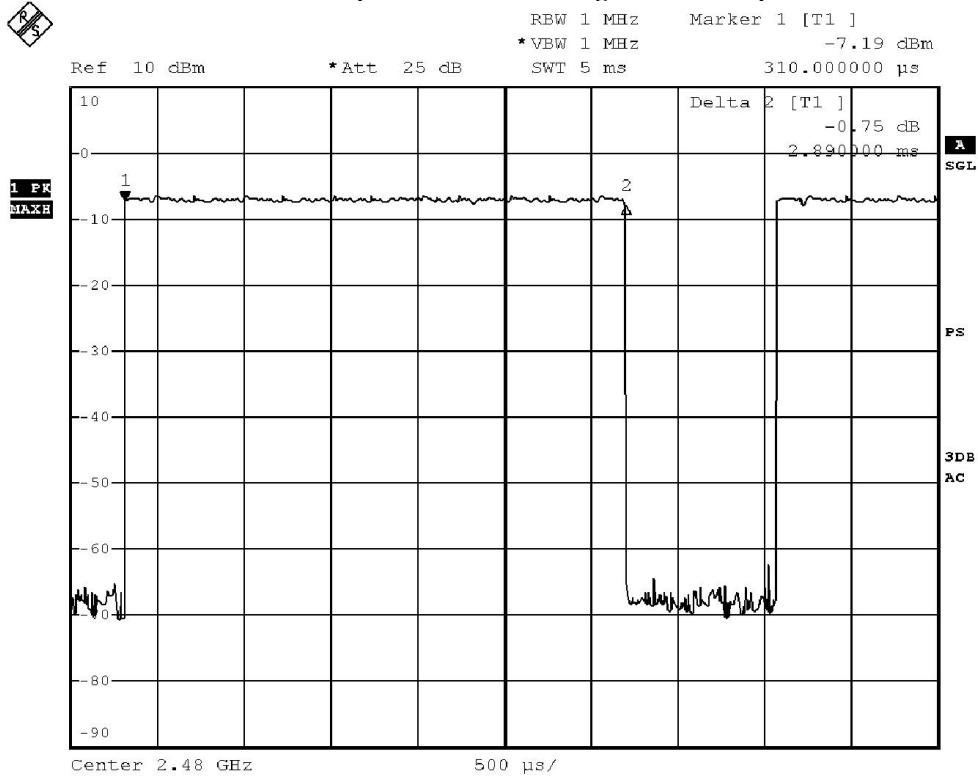

## Test Report

Date : 2020-07-30  
 No. : HMD20070008

Page 62 of 74

**DH3 Packet:**

DH3 Packet permit maximum  $1600/79/4 = 5.06$  hops per second in each channel (3 time slots RX, 1 time slot TX). The Dwell time is the time duration of the pulse times  $5.06 \times 31.6 = 160$  within 31.6 seconds

**Fig. D**  
**[Pulse duration of Lowest Channel]**

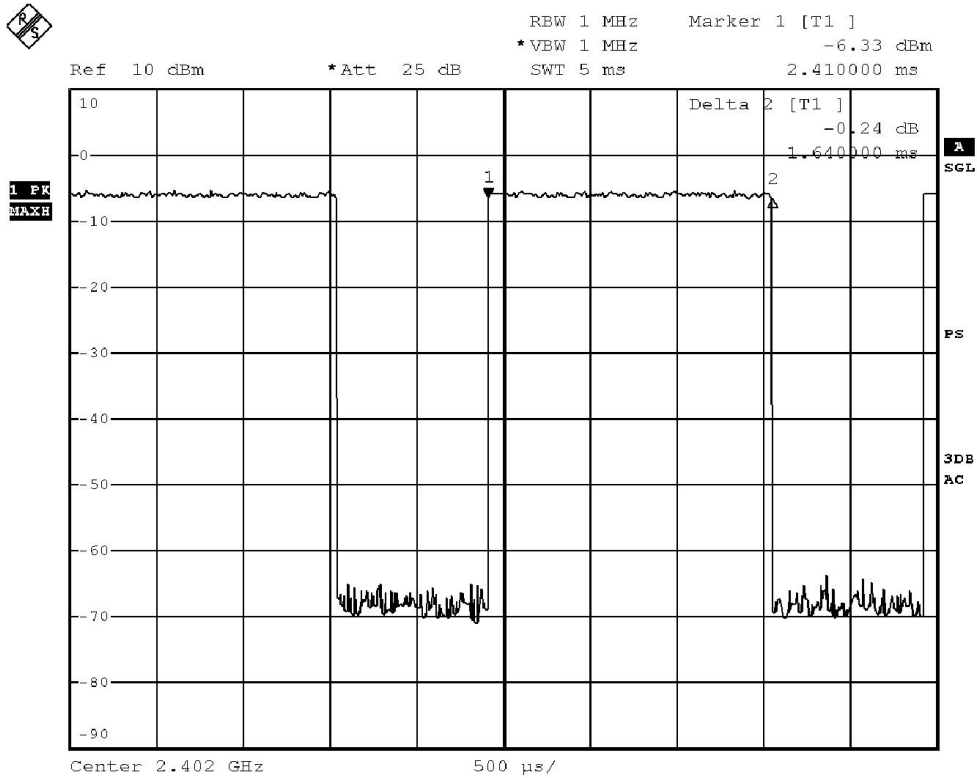

The Hong Kong Standards and Testing Centre Limited

10 Dai Wang Street, Taipo Industrial Estate, Tai Po, N.T., Hong Kong

Tel: +852 2666 1888 Fax: +852 2664 4353 Email: [hkstc@stc.group](mailto:hkstc@stc.group) Website: [www.stc.group](http://www.stc.group)

This report shall not be reproduced unless with prior written approval from The Hong Kong Standards and Testing Centre Limited.

For Conditions of Issuance of this test report, please refer to "Conditions of Issuance of Test Reports" section or Website.

## Test Report

Date : 2020-07-30  
 No. : HMD20070008

Page 63 of 74

**Fig. E**  
**[Pulse duration of Middle Channel]**

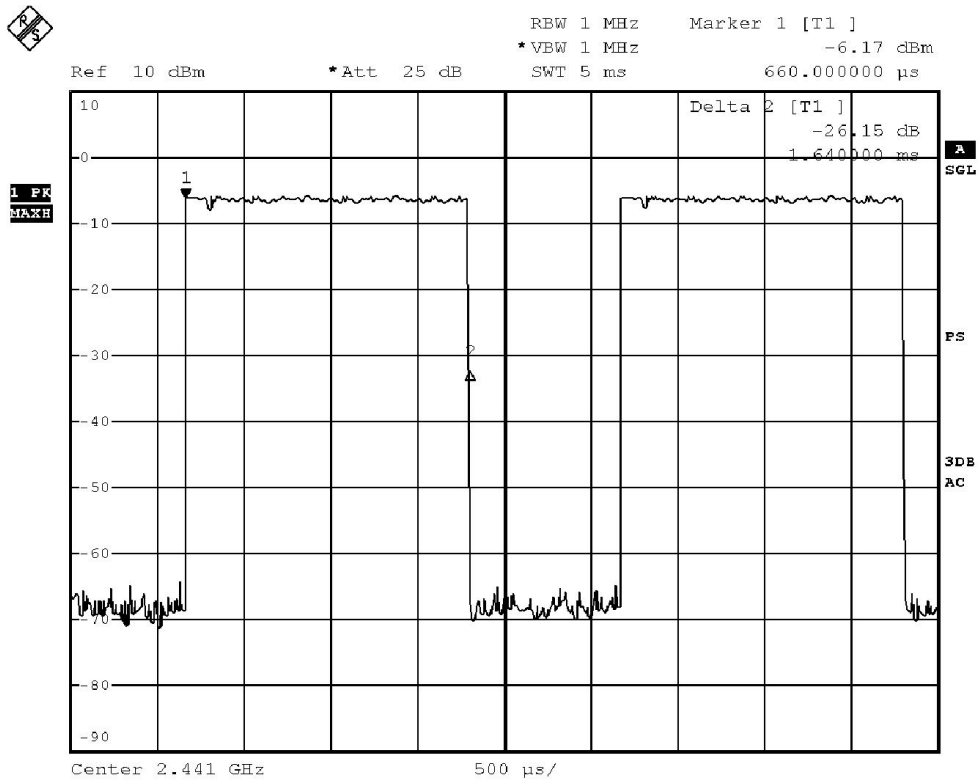

## Test Report

Date : 2020-07-30  
 No. : HMD20070008

Page 64 of 74

**Fig. F**  
**[Pulse duration of Highest Channel]**

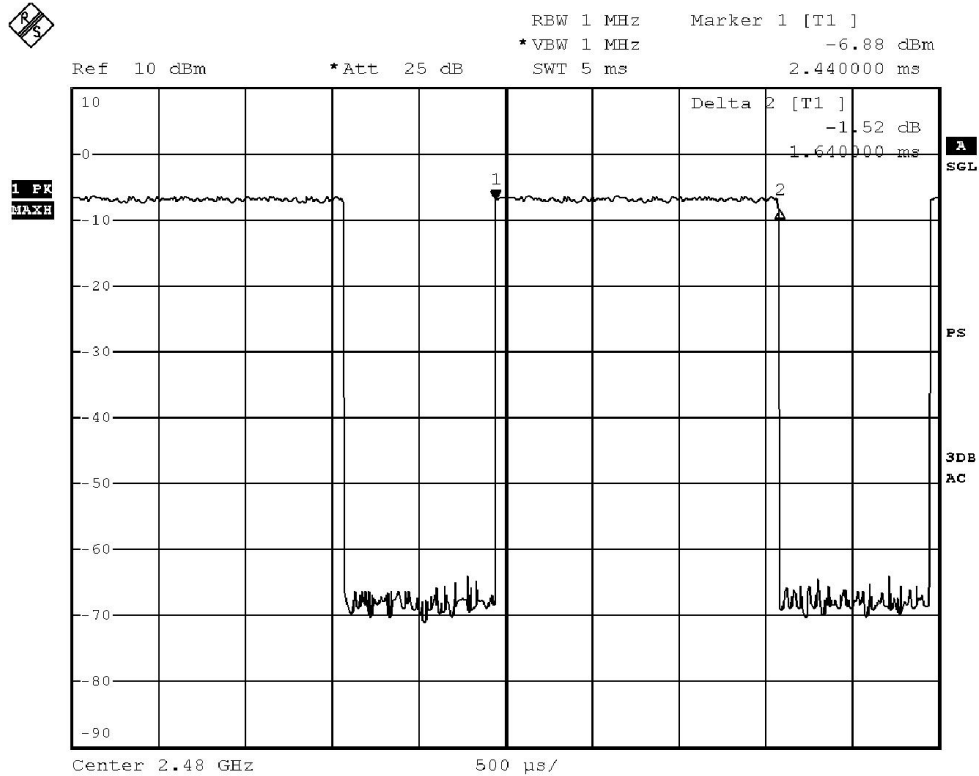

The Hong Kong Standards and Testing Centre Limited

10 Dai Wang Street, Taipo Industrial Estate, Tai Po, N.T., Hong Kong

Tel: +852 2666 1888 Fax: +852 2664 4353 Email: [hkstc@stc.group](mailto:hkstc@stc.group) Website: [www.stc.group](http://www.stc.group)

This report shall not be reproduced unless with prior written approval from The Hong Kong Standards and Testing Centre Limited.

For Conditions of Issuance of this test report, please refer to "Conditions of Issuance of Test Reports" section or Website.



## Test Report

Date : 2020-07-30  
 No. : HMD20070008

**DH1 Packet:**

DH1 Packet permit maximum  $1600/79/2 = 10.12$  hops per second in each channel (3 time slots RX, 1 time slot TX). The Dwell time is the time duration of the pulse times  $10.12 \times 31.6 = 320$  within 31.6 seconds

**Fig. G**  
**[Pulse duration of Lowest Channel]**

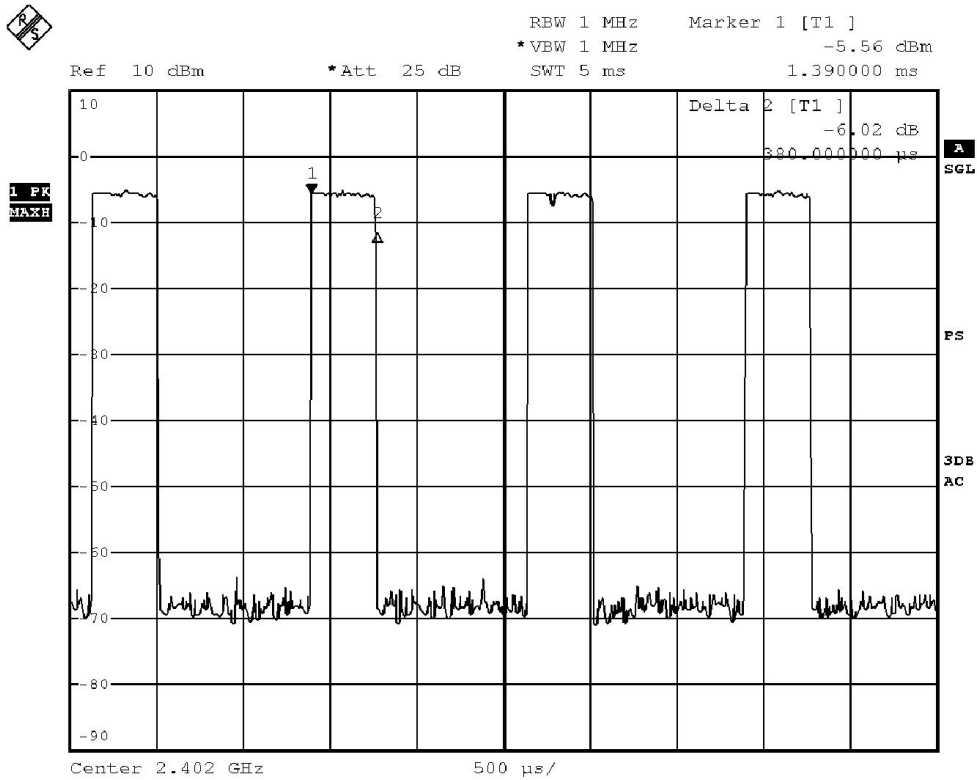

## Test Report

Date : 2020-07-30  
 No. : HMD20070008

Page 66 of 74

**Fig. H**  
**[Pulse duration of Middle Channel]**

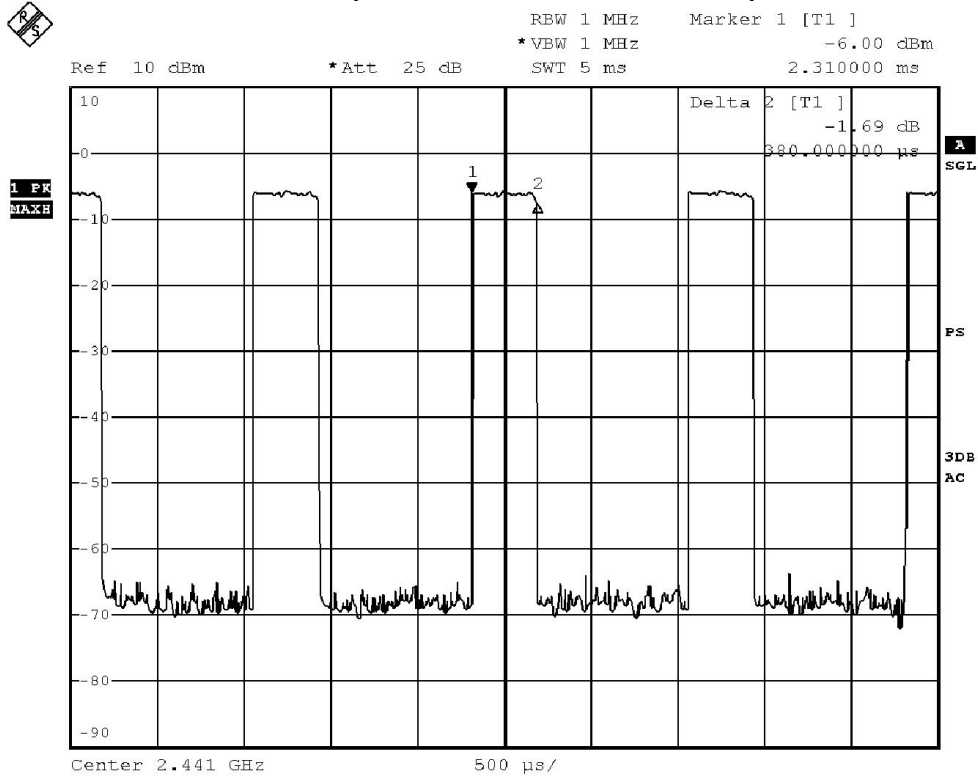

## Test Report

Date : 2020-07-30  
 No. : HMD20070008

Page 67 of 74

**Fig. I**  
**[Pulse duration of Highest Channel]**

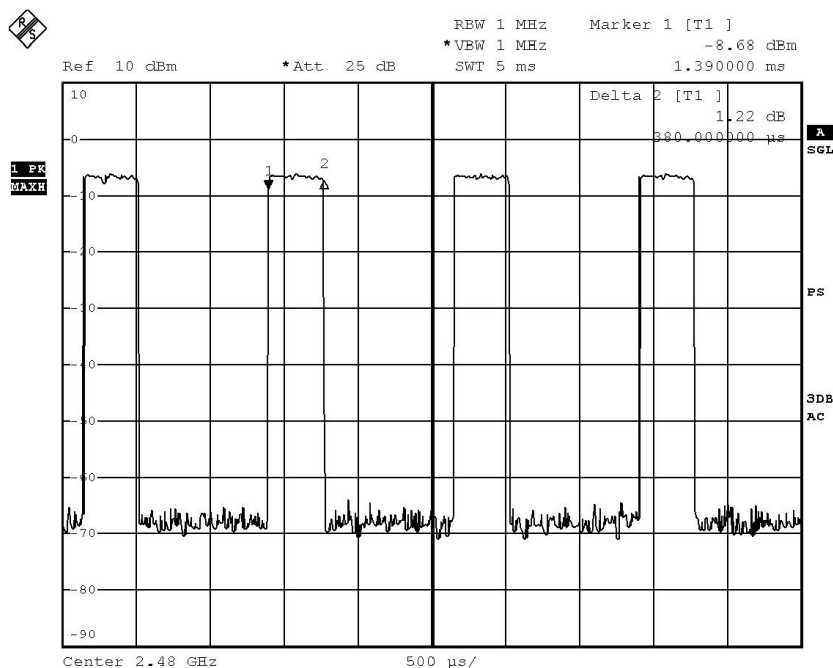

**Time of occupancy (Dwell Time):**

Data Packet	Frequency (MHz)	Pulse Duration (ms)	Dwell Time (s)	Limits (s)	Test Results
2DH5	2402	2.890	0.308	0.400	Complies
2DH5	2441	2.900	0.309	0.400	Complies
2DH5	2480	2.890	0.308	0.400	Complies
2DH3	2402	1.640	0.262	0.400	Complies
2DH3	2441	1.640	0.262	0.400	Complies
2DH3	2480	1.640	0.262	0.400	Complies
2DH1	2402	0.380	0.122	0.400	Complies
2DH1	2441	0.380	0.122	0.400	Complies
2DH1	2480	0.380	0.122	0.400	Complies



## Test Report

Date : 2020-07-30  
No. : HMD20070008

Page 68 of 74

### 3.1.9 Channel Centre Frequency

Ambient Temperature: 25°C

Relative Humidity: 51%

Atmospheric Pressure: 101 kPa

#### **Requirements:**

Frequency hopping system in the 2400-2483.5MHz band shall use at least 79 (Channel 1 to 79) non-overlapping channels.

The EUT operates in according with the Bluetooth system specification within the 2400 - 2483.5 MHz frequency band.

RF channels for Bluetooth systems are spaced 1 MHz and are ordered in channel number k. In order to comply with out-of-band regulations, a lower frequency guard band of 2.0 MHz and a higher frequency guard band of 3.5MHz is used.

The operating frequencies of each channel are as follows:

First RF channel start from 2400MHz + 2MHz guard band = 2402MHz

Frequency of RF Channel = 2402+k MHz, k = 0,...,78 (Channel separation = 1MHz)

The Hong Kong Standards and Testing Centre Limited

10 Dai Wang Street, Taipo Industrial Estate, Tai Po, N.T., Hong Kong

Tel: +852 2666 1888 Fax: +852 2664 4353 Email: [hkstc@stc.group](mailto:hkstc@stc.group) Website: [www.stc.group](http://www.stc.group)

This report shall not be reproduced unless with prior written approval from The Hong Kong Standards and Testing Centre Limited.

For Conditions of Issuance of this test report, please refer to "Conditions of Issuance of Test Reports" section or Website.



## Test Report

Date : 2020-07-30  
No. : HMD20070008

Page 69 of 74

### 3.1.10 Pseudorandom Hopping Algorithm

Ambient Temperature: 25°C

Relative Humidity: 51%

Atmospheric Pressure: 101 kPa

#### **Requirements:**

The channel frequencies shall be selected from a pseudorandom ordered list of hopping frequencies. Each frequency must be used equally by the transmitter.

#### **EUT Pseudorandom Hopping Algorithm**

The EUT is a Bluetooth device, the Pseudo-random hopping pattern; hopping characteristics and algorithm are based on the Bluetooth specification.

The Hong Kong Standards and Testing Centre Limited

10 Dai Wang Street, Taipo Industrial Estate, Tai Po, N.T., Hong Kong

Tel: +852 2666 1888 Fax: +852 2664 4353 Email: [hkstc@stc.group](mailto:hkstc@stc.group) Website: [www.stc.group](http://www.stc.group)

This report shall not be reproduced unless with prior written approval from The Hong Kong Standards and Testing Centre Limited.

For Conditions of Issuance of this test report, please refer to "Conditions of Issuance of Test Reports" section or Website.



## Test Report

Date : 2020-07-30  
No. : HMD20070008

Page 70 of 74

### 3.1.11 Antenna Requirement

Ambient Temperature: 25°C

Relative Humidity: 51%

Atmospheric Pressure: 101 kPa

**Test Requirements:** § 15.203

#### **Test Specification:**

An intentional radiator shall be designed to ensure that no antenna other than that furnished by the responsible party shall be used with the device. The use of a permanently attached antenna or of an antenna that uses a unique coupling to the intentional radiator shall be considered sufficient to comply with the provisions of this section. The manufacturer may design the unit so that a broken antenna can be replaced by the user, but the use of a standard antenna jack or electrical connector is prohibited.

#### **Test Results:**

This is PCB antenna. There is no external antenna, the antenna gain = 0dBi. User is unable to remove or changed the Antenna.

The Hong Kong Standards and Testing Centre Limited

10 Dai Wang Street, Taipo Industrial Estate, Tai Po, N.T., Hong Kong

Tel: +852 2666 1888 Fax: +852 2664 4353 Email: [hkstc@stc.group](mailto:hkstc@stc.group) Website: [www.stc.group](http://www.stc.group)

This report shall not be reproduced unless with prior written approval from The Hong Kong Standards and Testing Centre Limited.

For Conditions of Issuance of this test report, please refer to "Conditions of Issuance of Test Reports" section or Website.



## Test Report

Date : 2020-07-30  
No. : HMD20070008

Page 71 of 74

### Appendix A

#### List of Measurement Equipment

##### Radiated Emission

EQP NO.	DESCRIPTION	MANUFACTURER	MODEL NO.	SERIAL NO.	LAST CAL	DUE CAL
EM215	MULTIDEVICE CONTROLLER	EMCO	2090	00024676	N/A	N/A
EM217	ELECTRIC POWERED TURNTABLE	EMCO	2088	00029144	N/A	N/A
EM218	ANECHOIC CHAMBER	ETS-LINDGREN	FACT-3	--	2020/04/20	2021/04/20
EM356	ANTENNA POSITIONING TOWER	ETS-LINDGREN	2171B	00150346	N/A	N/A
EM219	BICONILOG ANTENNA	EMCO	3142C	00029071	2019/11/07	2021/11/07
EM229	EMI TEST RECEIVER	R&S	ESIB40	100248	2020/05/13	2021/05/13
EM276	BROADBAND HORN ANTENNA	A-INFOMW	JXTXLB-10180-SF	J2031090903007	2019/03/20	2021/03/29
EM300	PYRAMIDAL STANDARD GAIN HORN ANTENNA	ETS-LINDGREN	3160-09	00130130	2020/04/28	2022/04/28
EM301	PYRAMIDAL STANDARD GAIN HORN ANTENNA	ETS-LINDGREN	3160-10	00130988	2020/04/28	2022/04/28
EM022	LOOP ANTENNA	ETS_LINDGREN	6502	00206533	2019/11/30	2021/11/30
EM200	DUAL CHANNEL POWER METER	R & S	NRVD	100592	2019/10/11	2021/10/11

##### Line Conducted

EQP NO.	DESCRIPTION	MANUFACTURER	MODEL NO.	SERIAL NO.	LAST CAL	DUE CAL
EM119	LISN	R & S	ESH3-Z5	0831.5518.52	2020/06/30	2021/06/30
EM145	EMI TEST RECEIVER	R & S	ESIB7	100072	2020/05/13	2021/05/13
EM179	IMPULSE LIMITER	ROHDE & SCHWARZ	ESH3-Z2	357-8810.52/54	2020/01/13	2021/01/11
EM154	SHIELDING ROOM	SIEMENS MATSUSHITA COMPONENTS	N/A	803-740-057-99A	2017/02/02	2022/02/02
N/A	MEASUREMENT AND EVALUATION SOFTWARE	ROHDE & SCHWARZ	BSIB-K1	V1.20	N/A	N/A

Remarks:-

CM Corrective Maintenance  
N/A Not Applicable  
TBD To Be Determined

The Hong Kong Standards and Testing Centre Limited  
10 Dai Wang Street, Taipo Industrial Estate, Tai Po, N.T., Hong Kong

Tel: +852 2666 1888 Fax: +852 2664 4353 Email: hkstc@stc.group Website: www.stc.group

This report shall not be reproduced unless with prior written approval from The Hong Kong Standards and Testing Centre Limited.

For Conditions of Issuance of this test report, please refer to "Conditions of Issuance of Test Reports" section or Website.

## Test Report

Date : 2020-07-30  
No. : HMD20070008

Page 72 of 74

### Appendix B

#### Photographs of EUT

View of the product



View of the product



Inner Circuit Top View



Inner Circuit Bottom View





## Test Report

Date : 2020-07-30  
No. : HMD20070008

Page 73 of 74

### Photographs of EUT

**Measurement of Radiated Emission Test Set Up (9kHz – 30MHz)**

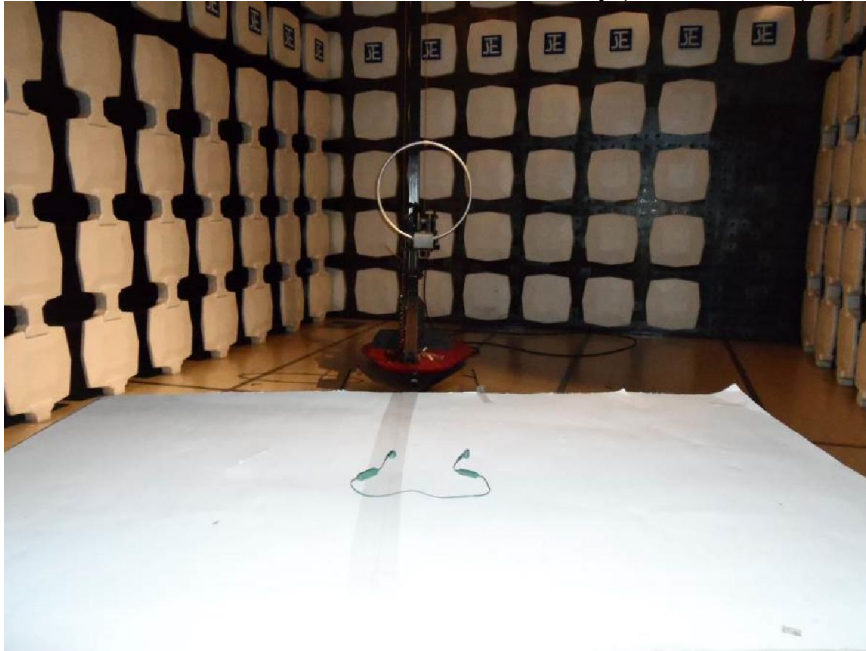

**Measurement of Radiated Emission Test Set Up (30MHz to 1000MHz)**

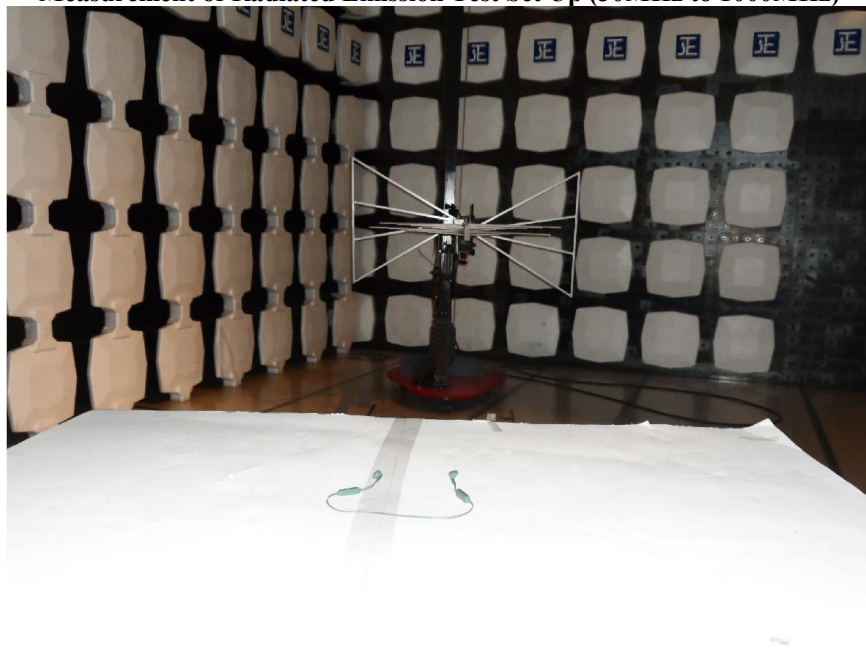

The Hong Kong Standards and Testing Centre Limited

10 Dai Wang Street, Taipo Industrial Estate, Tai Po, N.T., Hong Kong

Tel: +852 2666 1888 Fax: +852 2664 4353 Email: [hkstc@stc.group](mailto:hkstc@stc.group) Website: [www.stc.group](http://www.stc.group)

This report shall not be reproduced unless with prior written approval from The Hong Kong Standards and Testing Centre Limited.

For Conditions of Issuance of this test report, please refer to "Conditions of Issuance of Test Reports" section or Website.

## Test Report

Date : 2020-07-30  
No. : HMD20070008

Page 74 of 74

### Photographs of EUT

Measurement of Radiated Emission Test Set Up (Above 1000MHz)

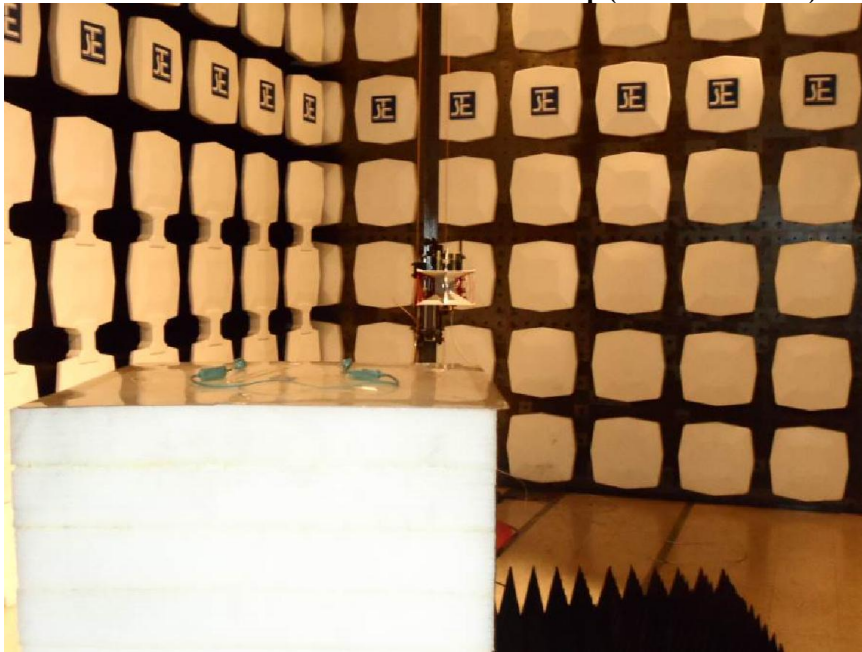

Measurement of Conducted Emission Test Set Up



\*\*\*\*\* End of Test Report \*\*\*\*\*

## Conditions of Issuance of Test Reports

1. All samples and goods are accepted by The Hong Kong Standards & Testing Centre Limited (the "Company") solely for testing and reporting in accordance with the following terms and conditions. The Company provides its services on the basis that such terms and conditions constitute express agreement between the Company and any person, firm or company requesting its services (the "Clients").
2. Any report issued by the Company as a result of this application for testing service (the "Report") shall be issued in confidence to the Clients and the Report will be strictly treated as such by the Company. It may not be reproduced either in its entirety or in part and it may not be used for advertising or other unauthorized purposes without the written consent of the Company. The Clients to whom the Report is issued may, however, show or send it, or a certified copy thereof prepared by the Company to his customer, supplier or other persons directly concerned. Subject to clause 3, the Company will not, without the consent of the Clients, enter into any discussion or correspondence with any third party concerning the contents of the Report, unless required by the relevant governmental authorities, laws or court orders.
3. The Company shall be at liberty to disclose the testing-related documents and/or files anytime to any third-party accreditation and/or recognition bodies for audit or other related purposes. No liabilities whatsoever shall attach to the Company's act of disclosure.
4. The Company shall not be called or be liable to be called to give evidence or testimony on the Report in a court of law without its prior written consent, unless required by the relevant governmental authorities, laws or court orders.
5. The results in Report apply only to the sample as received and do not apply to the bulk, unless the sampling has been carried out by the Company and is stated as such in the Report.
6. When a statement of conformity to a specification or standard is provided, the ILAC-G8 Guidance document (and/or IEC Guide 115 in the electrotechnical sector) will be adopted as a decision rule for the determination of conformity unless it is inherent in the requested specification or standard, or otherwise specified in the Report.
7. In the event of the improper use the report as determined by the Company, the Company reserves the right to withdraw it, and to adopt any other additional remedies which may be appropriate.
8. Sample submitted for testing are accepted on the understanding that the Report issued cannot form the basis of, or be the instrument for, any legal action against the Company.
9. The Company will not be liable for or accept responsibility for any loss or damage howsoever arising from the use of information contained in any of its Reports or in any communication whatsoever about its said tests or investigations.
10. Clients wishing to use the Report in court proceedings or arbitration shall inform the Company to that effect prior to submitting the sample for testing.
11. Subject to the variable length of retention time for test data and report stored hereinto as to otherwise specifically required by individual accreditation authorities, the Company will only keep the supporting test data and information of this test report for a period of three years. The data and information will be disposed of after the aforementioned retention period has elapsed. Under no circumstances shall we provide any data and information which has been disposed of after the retention period. Under no circumstances shall we be liable for damages of any kind, including (but not limited to) compensatory damages, lost profits, lost data, or any form of special, incidental, indirect, consequential or punitive damages of any kind, whether based on breach of contract of warranty, tort (including negligence), product liability or otherwise, even if we are informed in advance of the possibility of such damages.
12. Issuance records of the Report are available on the internet at [www.stc.group](http://www.stc.group). Further enquiry of validity or verification of the Reports should be addressed to the Company.