



TEST REPORT

Report No. : **CHTEW20050084** Report Verification: 

Project No...... : **SHT2005029401EW**

FCC ID..... : **2AVTH-LO14WB**

Applicant's name..... : **Hyundai Technology Group, Inc.**

Address..... : 2601 Walnut Ave. Tustin, CA, USA

Manufacturer..... : Hyundai Technology Group, Inc.

Address..... : 2601 Walnut Ave. Tustin, CA, USA

Test item description : **Notebook**

Trade Mark : HYUNDAI

Model/Type reference..... : Hyundai Onnyx III Plus

Listed Model(s) : LO14WA1BK, LO14WA1B, LO14WB1B, LO14WA1S, LO14WA1RG, LO14WB1S, Hyundai Onnyx III

Standard : **FCC CFR Title 47 Part 15 Subpart C Section 15.247**

Date of receipt of test sample..... : May 13, 2020

Date of testing..... : May 13, 2020- May 20, 2020

Date of issue..... : May 21, 2020

Result..... : **PASS**

Compiled by
 (Position+Printed name+Signature): File administrator Echo Wei

Echo Wei

Supervised by
 (Position+Printed name+Signature): Project Engineer Cheng Xiao

Cheng Xiao

Approved by
 (Position+Printed name+Signature): RF Manager Hans Hu

Hans Hu

Testing Laboratory Name : **Shenzhen Huatongwei International Inspection Co., Ltd.**

Address..... : 1/F, Bldg 3, Hongfa Hi-tech Industrial Park, Genyu Road, Tianliao, Gongming, Shenzhen, China

Shenzhen Huatongwei International Inspection Co., Ltd. All rights reserved.

This publication may be reproduced in whole or in part for non-commercial purposes as long as the Shenzhen Huatongwei International Inspection Co., Ltd. is acknowledged as copyright owner and source of the material. Shenzhen Huatongwei International Inspection Co., Ltd. takes no responsibility for and will not assume liability for damages resulting from the reader's interpretation of the reproduced material due to its placement and context.

The test report merely correspond to the test sample.

Contents

| | | |
|-----------|--|-----------|
| 1. | TEST STANDARDS AND REPORT VERSION | 3 |
| 1.1. | Test Standards | 3 |
| 1.2. | Report version | 3 |
| 2. | TEST DESCRIPTION | 4 |
| 3. | SUMMARY | 5 |
| 3.1. | Client Information | 5 |
| 3.2. | Product Description | 5 |
| 3.3. | Radio Specification Description | 5 |
| 3.4. | Testing Laboratory Information | 6 |
| 4. | TEST CONFIGURATION | 7 |
| 4.1. | Test frequency list | 7 |
| 4.2. | Descriptions of Test mode | 7 |
| 4.3. | Test mode | 7 |
| 4.4. | Support unit used in test configuration and system | 8 |
| 4.5. | Testing environmental condition | 8 |
| 4.6. | Measurement uncertainty | 8 |
| 4.7. | Equipment Used during the Test | 9 |
| 5. | TEST CONDITIONS AND RESULTS | 11 |
| 5.1. | Antenna Requirement | 11 |
| 5.2. | AC Conducted Emission | 12 |
| 5.3. | Peak Output Power | 15 |
| 5.4. | 20 dB Bandwidth | 16 |
| 5.5. | 99% Occupied Bandwidth | 17 |
| 5.6. | Carrier Frequencies Separation | 18 |
| 5.7. | Hopping Channel Number | 19 |
| 5.8. | Dwell Time | 20 |
| 5.9. | Duty Cycle Correction Factor (DCCF) | 21 |
| 5.10. | Pseudorandom Frequency Hopping Sequence | 22 |
| 5.11. | Conducted Band edge and Spurious Emission | 23 |
| 5.12. | Radiated Band edge Emission | 25 |
| 5.13. | Radiated Spurious Emission | 27 |
| 6. | TEST SETUP PHOTOS | 32 |
| 7. | EXTERANAL AND INTERNAL PHOTOS | 34 |
| 8. | APPENDIX REPORT | 34 |

1. TEST STANDARDS AND REPORT VERSION

1.1. Test Standards

The tests were performed according to following standards:

- [FCC Rules Part 15.247](#): Frequency Hopping, Direct Spread Spectrum and Hybrid Systems that are in operation within the bands of 902-928 MHz, 2400-2483.5 MHz, and 5725-5850 MHz
- [ANSI C63.10:2013](#): American National Standard for Testing Unlicensed Wireless Devices
- [KDB 558074 D01 15.247 Meas Guidance v05r02](#): Guidance for Compliance Measurements on Digital Transmission System, Frequency Hopping Spread Spectrum System, and Hybrid System Devices Operating under Section 15.247 of The FCC Rules

1.2. Report version

| Revision No. | Date of issue | Description |
|--------------|---------------|-------------|
| N/A | 2020-05-21 | Original |
| | | |
| | | |
| | | |
| | | |

2. TEST DESCRIPTION

| Report clause | Test Items | Standard Requirement | Result |
|---------------|---|-------------------------|--------------------|
| 5.1 | Antenna Requirement | 15.203/15.247 (c) | PASS |
| 5.2 | AC Conducted Emission | 15.207 | PASS |
| 5.3 | Peak Output Power | 15.247 (b)(1) | PASS |
| 5.4 | 20 dB Bandwidth | 15.247 (a)(1) | PASS |
| 5.5 | 99% Occupied Bandwidth | - | PASS ^{*1} |
| 5.6 | Carrier Frequency Separation | 15.247 (a)(1) | PASS |
| 5.7 | Hopping Channel Number | 15.247 (a)(1) | PASS |
| 5.8 | Dwell Time | 15.247 (a)(1) | PASS |
| 5.9 | Duty Cycle Correction Factor | - | PASS ^{*1} |
| 5.10 | Pseudorandom Frequency Hopping Sequence | 15.247(b)(4) | PASS |
| 5.11 | Conducted Band Edge and Spurious Emission | 15.247(d)/15.205 | PASS |
| 5.12 | Radiated Band Edge Emission | 15.205/15.209 | PASS |
| 5.13 | Radiated Spurious Emission | 15.247(d)/15.205/15.209 | PASS |

Note:

- The measurement uncertainty is not included in the test result.
- *1: No requirement on standard, only report these test data.

3. SUMMARY

3.1. Client Information

| | |
|---------------|----------------------------------|
| Applicant: | Hyundai Technology Group, Inc. |
| Address: | 2601 Walnut Ave. Tustin, CA, USA |
| Manufacturer: | Hyundai Technology Group, Inc. |
| Address: | 2601 Walnut Ave. Tustin, CA, USA |

3.2. Product Description

| | |
|-------------------|---|
| Name of EUT: | Notebook |
| Trade Mark: | HYUNDAI |
| Model No.: | Hyundai Onnyx III Plus |
| Listed Model(s): | LO14WA1BK, LO14WA1B, LO14WB1B, LO14WA1S, LO14WA1RG, LO14WB1S, Hyundai Onnyx III |
| Power supply: | DC 7.6V |
| Hardware version: | EM_A8316C_366B_V1.0 |
| Software version: | 1909 |

3.3. Radio Specification Description

| | |
|----------------------------------|----------------------------|
| Bluetooth version: | V2.1 |
| Support function ^{*2} : | EDR |
| Modulation: | GFSK, $\pi/4$ DQPSK, 8DPSK |
| Operation frequency: | 2402MHz~2480MHz |
| Channel number: | 79 |
| Channel separation: | 1MHz |
| Antenna type: | FPC+Coaxial line |
| Antenna gain: | 1.28dBi |

Note:

*2: only show the RF function associated with this report.

3.4. Testing Laboratory Information

| | | |
|---------------------|--|----------------------|
| Laboratory Name | Shenzhen Huatongwei International Inspection Co., Ltd. | |
| Laboratory Location | 1/F, Bldg 3, Hongfa Hi-tech Industrial Park, Genyu Road, Tianliao, Gongming, Shenzhen, China | |
| Qualifications | Type | Accreditation Number |
| | CNAS | L1225 |
| | A2LA | 3902.01 |
| | FCC | 762235 |
| | Canada | 5377A |

4. TEST CONFIGURATION

4.1. Test frequency list

According to section 15.31(m), regards to the operating frequency range over 10 MHz, must select three channels which were tested. The Lowest frequency, the middle frequency, and the highest frequency of channel were selected to perform the test, please see the below blue front.

| Channel | Frequency (MHz) |
|---------|-----------------|
| 00 | 2402 |
| 01 | 2403 |
| ⋮ | ⋮ |
| 39 | 2441 |
| ⋮ | ⋮ |
| 77 | 2479 |
| 78 | 2480 |

4.2. Descriptions of Test mode

Preliminary tests were performed in different data rates and recorded the RF output power in the clause 5.3

Note:

- 1) The manufacturer declare that the maximum power value of the product is set as a default value in the enter test mode software.
- 2) All the test data for each data rate were verified, found GFSK Modulation which is worse case mode

4.3. Test mode

| For RF test items: | | | |
|---|------------------------|------------------------|----------------|
| The engineering test program was provided and enabled to make EUT continuous transmitting. | | | |
| Test Item | Modulation / Data Rate | | |
| | GFSK 1Mbps | $\pi/4$ DQPSK 2Mbps | 8DPSK 3Mbps |
| Conducted test item | ✓ | ✓ | ✓ |
| Radiated test item | ✓ | - | |
| Remark: | | | |
| <ul style="list-style-type: none"> - For radiated test item, the worst mode data rate 3Mbps was reported only, because this data rate has the highest RF output power at preliminary tests. - The EUT in each of three orthogonal axis emissions had been tested, but only the worst case (X axis) data recorded in the report. | | | |

4.4. Support unit used in test configuration and system

The EUT has been associated with peripherals and configuration operated in a manner tended to maximize its emission characteristics in a typical application.

The following peripheral devices and interface cables were connected during the measurement:

| Whether support unit is used? | | | | | |
|-------------------------------|------------|------------|-----------|--------|------------|
| ✓ No | | | | | |
| Item | Equipement | Trade Name | Model No. | FCC ID | Power cord |
| 1 | | | | | |
| 2 | | | | | |

4.5. Testing environmental condition

| Type | Requirement | Actual |
|--------------------|--------------|----------|
| Temperature: | 15~35°C | 25°C |
| Relative Humidity: | 25~75% | 50% |
| Air Pressure: | 860~1060mbar | 1000mbar |

4.6. Measurement uncertainty

| Test Item | Measurement Uncertainty |
|--------------------------------------|-------------------------|
| AC Conducted Emission (150kHz~30MHz) | 3.02 dB |
| Radiated Emission (30MHz~1000MHz) | 4.90 dB |
| Radiated Emissions (1GHz~25GHz) | 4.96 dB |
| Peak Output Power | 0.51 dB |
| Power Spectral Density | 0.51 dB |
| Conducted Spurious Emission | 0.51 dB |
| 6dB Bandwidth | 70 Hz |

This uncertainty represents an expanded uncertainty expressed at approximately the 95% confidence level using a coverage factor of k=1.96.

4.7. Equipment Used during the Test

| ● Conducted Emission | | | | | | | |
|----------------------|---------------------|--------------------|---------------|-----------------|---------------|---------------------------|---------------------------|
| Used | Test Equipment | Manufacturer | Equipment No. | Model No. | Serial No. | Last Cal. Date (YY-MM-DD) | Next Cal. Date (YY-MM-DD) |
| ● | Shielded Room | Albatross projects | HTWE0114 | N/A | N/A | 2018/09/28 | 2023/09/27 |
| ● | EMI Test Receiver | R&S | HTWE0111 | ESCI | 101247 | 2019/10/26 | 2020/10/25 |
| ● | Artificial Mains | SCHWARZBECK | HTWE0113 | NNLK 8121 | 573 | 2019/10/23 | 2020/10/22 |
| ● | Pulse Limiter | R&S | HTWE0033 | ESH3-Z2 | 100499 | 2019/10/23 | 2020/10/22 |
| ● | RF Connection Cable | HUBER+SUHNER | HTWE0113-02 | ENVIROFLE X_142 | EF-NM-BNCM-2M | 2019/10/23 | 2020/10/22 |
| ● | Test Software | R&S | N/A | ES-K1 | N/A | N/A | N/A |

| ● Radiated emission-6th test site | | | | | | | |
|-----------------------------------|-------------------------|--------------------|---------------|--------------|------------|---------------------------|---------------------------|
| Used | Test Equipment | Manufacturer | Equipment No. | Model No. | Serial No. | Last Cal. Date (YY-MM-DD) | Next Cal. Date (YY-MM-DD) |
| ● | Semi-Anechoic Chamber | Albatross projects | HTWE0127 | SAC-3m-02 | C11121 | 2018/09/30 | 2021/09/29 |
| ● | EMI Test Receiver | R&S | HTWE0099 | ESCI | 100900 | 2019/10/26 | 2020/10/25 |
| ● | Loop Antenna | R&S | HTWE0170 | HFH2-Z2 | 100020 | 2018/04/02 | 2021/04/01 |
| ● | Ultra-Broadband Antenna | SCHWARZBECK | HTWE0123 | VULB9163 | 538 | 2018/04/04 | 2021/04/03 |
| ● | Pre-Amplifier | SCHWARZBECK | HTWE0295 | BBV 9742 | N/A | 2019/11/14 | 2020/11/13 |
| ● | RF Connection Cable | HUBER+SUHNER | HTWE0062-01 | N/A | N/A | 2019/08/21 | 2020/08/20 |
| ● | RF Connection Cable | HUBER+SUHNER | HTWE0062-02 | SUCOFLEX 104 | 501184/4 | 2019/05/27 | 2020/05/26 |
| ● | Test Software | R&S | N/A | ES-K1 | N/A | N/A | N/A |

| ● Radiated emission-7th test site | | | | | | | |
|-----------------------------------|-------------------------|--------------------|---------------|-------------------|-------------|---------------------------|---------------------------|
| Used | Test Equipment | Manufacturer | Equipment No. | Model No. | Serial No. | Last Cal. Date (YY-MM-DD) | Next Cal. Date (YY-MM-DD) |
| ● | Semi-Anechoic Chamber | Albatross projects | HTWE0122 | SAC-3m-01 | N/A | 2018/09/27 | 2021/09/26 |
| ● | Spectrum Analyzer | R&S | HTWE0098 | FSP40 | 100597 | 2019/10/26 | 2020/10/25 |
| ● | Horn Antenna | SCHWARZBECK | HTWE0126 | 9120D | 1011 | 2020/04/01 | 2023/03/31 |
| ● | Horn Antenna | SCHWARZBECK | HTWE0103 | BBHA9170 | 25841 | 2018/10/11 | 2021/10/10 |
| ● | Broadband Horn Antenna | SCHWARZBECK | HTWE0103 | BBHA9170 | BBHA9170472 | 2018/10/11 | 2021/10/10 |
| ● | Pre-amplifier | CD | HTWE0071 | PAP-0102 | 12004 | 2019/11/14 | 2020/11/13 |
| ● | Broadband Pre-amplifier | SCHWARZBECK | HTWE0201 | BBV 9718 | 9718-248 | 2019/05/23 | 2020/05/22 |
| ● | RF Connection Cable | HUBER+SUHNER | HTWE0120-01 | 6m 18GHz S Serisa | N/A | 2020/05/08 | 2021/05/07 |
| ● | RF Connection Cable | HUBER+SUHNER | HTWE0120-02 | 6m 3GHz RG Serisa | N/A | 2020/05/08 | 2021/05/07 |
| ● | RF Connection Cable | HUBER+SUHNER | HTWE0120-03 | 6m 3GHz RG Serisa | N/A | 2020/05/08 | 2021/05/07 |
| ● | RF Connection Cable | HUBER+SUHNER | HTWE0120-04 | 6m 3GHz RG Serisa | N/A | 2020/05/08 | 2021/05/07 |
| ● | RF Connection Cable | HUBER+SUHNER | HTWE0121-01 | 6m 18GHz S Serisa | N/A | 2020/05/08 | 2021/05/07 |
| ● | Test Software | Audix | N/A | E3 | N/A | N/A | N/A |

| ● RF Conducted Method | | | | | | |
|-----------------------|------------------------------|--------------|-----------|------------|---------------------------|---------------------------|
| Used | Test Equipment | Manufacturer | Model No. | Serial No. | Last Cal. Date (YY-MM-DD) | Next Cal. Date (YY-MM-DD) |
| ● | Signal and spectrum Analyzer | R&S | FSV40 | 100048 | 2019/10/26 | 2020/10/25 |
| ● | Spectrum Analyzer | Agilent | N9020A | MY50510187 | 2019/10/26 | 2020/10/25 |
| ○ | Power Meter | Anritsu | ML249A | N/A | 2019/10/26 | 2020/10/25 |
| ○ | Radio communication tester | R&S | CMW500 | 137688-Lv | 2019/10/26 | 2020/10/25 |

5. TEST CONDITIONS AND RESULTS

5.1. Antenna Requirement

Requirement

FCC CFR Title 47 Part 15 Subpart C Section 15.203:

An intentional radiator shall be designed to ensure that no antenna other than that furnished by the responsible party shall be used with the device. The use of a permanently attached antenna or of an antenna that uses a unique coupling to the intentional radiator, the manufacturer may design the unit so that a broken antenna can be replaced by the user, but the use of a standard antenna jack or electrical connector is prohibited.

FCC CFR Title 47 Part 15 Subpart C Section 15.247(c) (1)(i):

(i) Systems operating in the 2400-2483.5 MHz band that is used exclusively for fixed. Point-to-point operations may employ transmitting antennas with directional gain greater than 6 dBi provided the maximum conducted output power of the intentional radiator is reduced by 1 dB for every 3 dB that the directional gain of the antenna exceeds 6 dBi.

TEST RESULT

Passed **Not Applicable**

The antenna type is a FPC+Coaxial line antenna, the directional gain of the antenna less than 6 dBi, please refer to the below antenna photo.

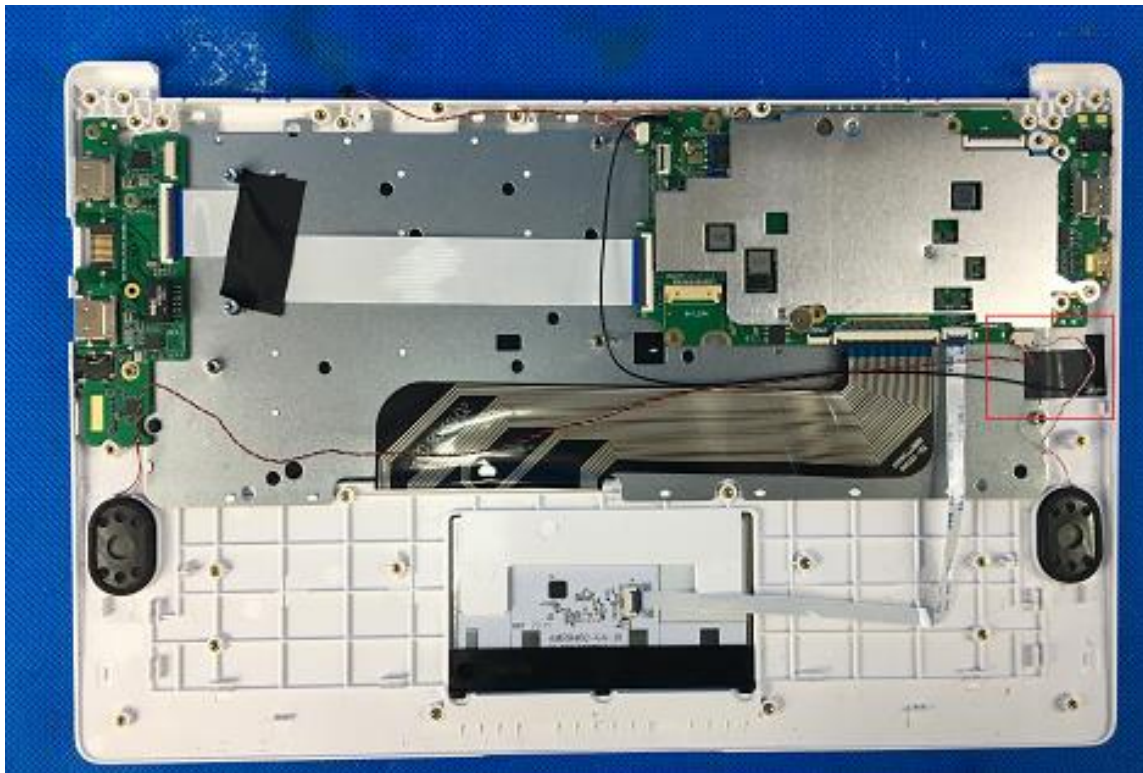

5.2. AC Conducted Emission

LIMIT

FCC CFR Title 47 Part 15 Subpart C Section 15.207

| Frequency range (MHz) | Limit (dBuV) | |
|-----------------------|--------------|-----------|
| | Quasi-peak | Average |
| 0.15-0.5 | 66 to 56* | 56 to 46* |
| 0.5-5 | 56 | 46 |
| 5-30 | 60 | 50 |

* Decreases with the logarithm of the frequency.

TEST CONFIGURATION

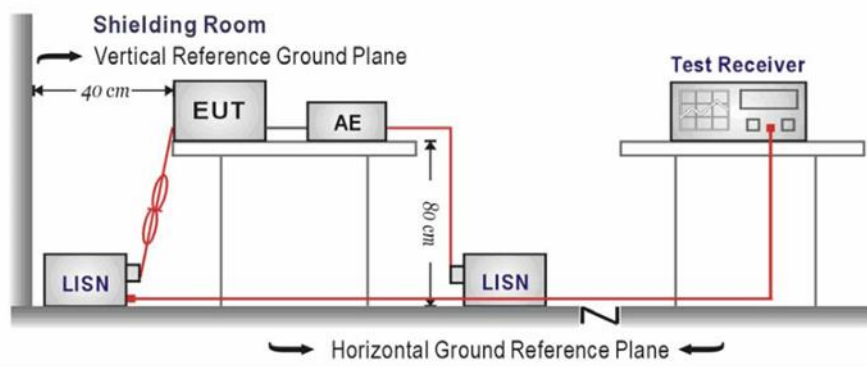

TEST PROCEDURE

1. The EUT was setup according to ANSI C63.10 requirements.
2. The EUT was placed on a platform of nominal size, 1 m by 1.5 m, raised 80 cm above the conducting ground plane. The vertical conducting plane was located 40 cm to the rear of the EUT. All other surfaces of EUT were at least 80 cm from any other grounded conducting surface.
3. The EUT and simulators are connected to the main power through a line impedances stabilization network (LISN). The LISN provides a 50 ohm /50uH coupling impedance for the measuring equipment.
4. The peripheral devices are also connected to the main power through a LISN. (Please refer to the block diagram of the test setup and photographs)
5. Each current-carrying conductor of the EUT power cord, except the ground (safety) conductor, was individually connected through a LISN to the input power source.
6. The excess length of the power cord between the EUT and the LISN receptacle were folded back and forth at the center of the lead to form a bundle not exceeding 40 cm in length.
7. Conducted emissions were investigated over the frequency range from 0.15MHz to 30MHz using a receiver bandwidth of 9 kHz.
8. During the above scans, the emissions were maximized by cable manipulation.

TEST MODE:

Please refer to the clause 4.3

TEST RESULT

Passed Not Applicable

Test Line:

L

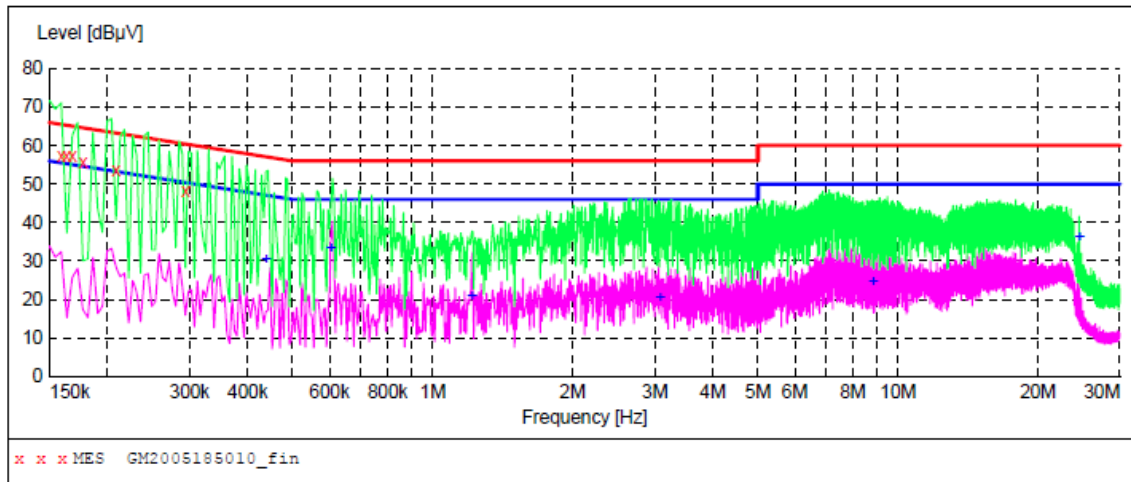

MEASUREMENT RESULT: "GM2005185010_fin"

5/18/2020 10:13AM

| Frequency MHz | Level dBµV | Transd dB | Limit dBµV | Margin dB | Detector | Line | PE |
|------------------|---------------|--------------|---------------|--------------|----------|------|-----|
| 0.159000 | 57.40 | 10.0 | 66 | 8.1 | QP | L1 | GND |
| 0.163500 | 57.20 | 10.0 | 65 | 8.1 | QP | L1 | GND |
| 0.168000 | 57.40 | 10.0 | 65 | 7.7 | QP | L1 | GND |
| 0.177000 | 55.80 | 10.0 | 65 | 8.8 | QP | L1 | GND |
| 0.208500 | 53.40 | 10.0 | 63 | 9.9 | QP | L1 | GND |
| 0.294000 | 48.10 | 10.1 | 60 | 12.3 | QP | L1 | GND |

MEASUREMENT RESULT: "GM2005185010_fin2"

5/18/2020 10:13AM

| Frequency MHz | Level dBµV | Transd dB | Limit dBµV | Margin dB | Detector | Line | PE |
|------------------|---------------|--------------|---------------|--------------|----------|------|-----|
| 0.438000 | 30.40 | 10.1 | 47 | 16.7 | AV | L1 | GND |
| 0.604500 | 33.10 | 10.1 | 46 | 12.9 | AV | L1 | GND |
| 1.212000 | 21.00 | 10.1 | 46 | 25.0 | AV | L1 | GND |
| 3.079500 | 20.40 | 10.2 | 46 | 25.6 | AV | L1 | GND |
| 8.830500 | 24.50 | 10.3 | 50 | 25.5 | AV | L1 | GND |
| 24.576000 | 36.10 | 10.6 | 50 | 13.9 | AV | L1 | GND |

Test Line:

N

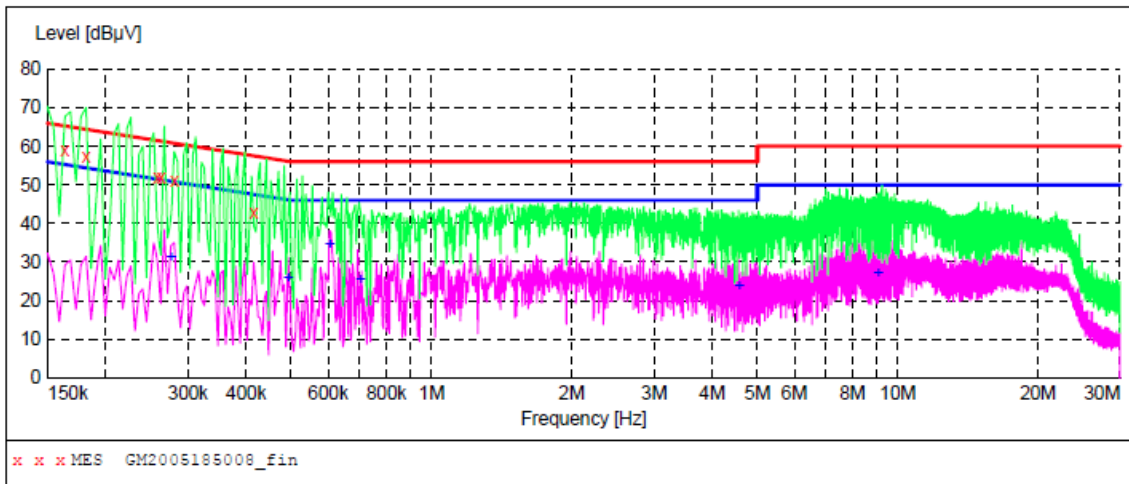

MEASUREMENT RESULT: "GM2005185008_fin"

5/18/2020 10:05AM

| Frequency MHz | Level dBµV | Transd dB | Limit dBµV | Margin dB | Detector | Line | PE |
|------------------|---------------|--------------|---------------|--------------|----------|------|-----|
| 0.163500 | 58.80 | 10.0 | 65 | 6.5 | QP | N | GND |
| 0.181500 | 57.40 | 10.0 | 64 | 7.0 | QP | N | GND |
| 0.258000 | 52.00 | 10.0 | 62 | 9.5 | QP | N | GND |
| 0.262500 | 51.90 | 10.0 | 61 | 9.5 | QP | N | GND |
| 0.280500 | 51.10 | 10.1 | 61 | 9.7 | QP | N | GND |
| 0.415500 | 42.90 | 10.1 | 58 | 14.6 | QP | N | GND |

MEASUREMENT RESULT: "GM2005185008_fin2"

5/18/2020 10:05AM

| Frequency MHz | Level dBµV | Transd dB | Limit dBµV | Margin dB | Detector | Line | PE |
|------------------|---------------|--------------|---------------|--------------|----------|------|-----|
| 0.276000 | 31.10 | 10.1 | 51 | 19.8 | AV | N | GND |
| 0.492000 | 25.90 | 10.1 | 46 | 20.2 | AV | N | GND |
| 0.604500 | 34.40 | 10.1 | 46 | 11.6 | AV | N | GND |
| 0.703500 | 25.20 | 10.1 | 46 | 20.8 | AV | N | GND |
| 4.569000 | 23.70 | 10.2 | 46 | 22.3 | AV | N | GND |
| 9.073500 | 27.20 | 10.3 | 50 | 22.8 | AV | N | GND |

5.3. Peak Output Power

LIMIT

FCC CFR Title 47 Part 15 Subpart C Section 15.247 (b)(1):

For frequency hopping systems operating in the 2400-2483.5 MHz band employing at least 75 non-overlapping hopping channels, and all frequency hopping systems in the 5725-5850 MHz band: 1 watt.
For all other frequency hopping systems in the 2400-2483.5 MHz band: 0.125 watts.

TEST CONFIGURATION

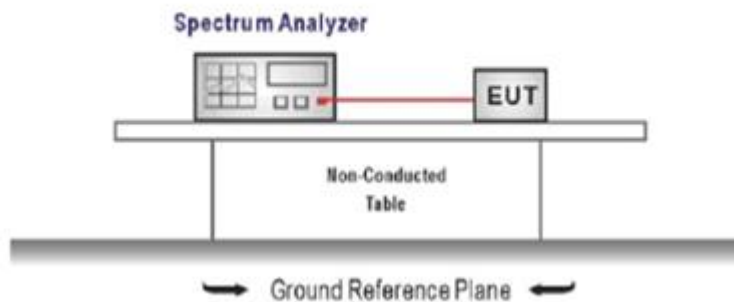

TEST PROCEDURE

1. The transmitter output was connected to the spectrum analyzer through an attenuator, the pathloss was compensated to the results for each measurement.
2. Set to the maximum power setting and enable the EUT transmit continuously
3. Use the following spectrum analyzer settings:
Span = approximately 5 times the 20 dB bandwidth, centered on a hopping channel
RBW \geq the 20 dB bandwidth of the emission being measured, VBW \geq RBW
Sweep = auto, Detector function = peak, Trace = max hold
4. Measure and record the results in the test report.

TEST MODE:

Please refer to the clause 4.3

TEST RESULT

Passed Not Applicable

TEST Data

Please refer to appendix A on the appendix report

5.4. 20 dB Bandwidth

LIMIT

N/A

TEST CONFIGURATION

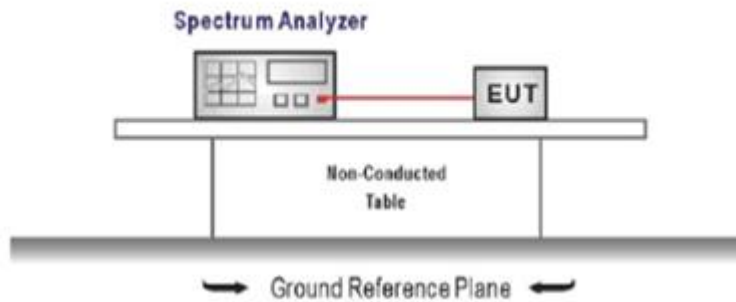

TEST PROCEDURE

1. The transmitter output was connected to the spectrum analyzer through an attenuator, the path loss was compensated to the results for each measurement.
2. Set to the maximum power setting and enable the EUT transmit continuously
3. Use the following spectrum analyzer settings:
Span = approximately 2 to 3 times the 20 dB bandwidth, centered on a hopping channel
RBW \geq 1% of the 20 dB bandwidth, VBW \geq RBW
Sweep = auto, Detector function = peak, Trace = max hold
4. Measure and record the results in the test report.

TEST MODE:

Please refer to the clause 4.3

TEST RESULT

Passed Not Applicable

TEST Data

Please refer to appendix B on the appendix report

5.5. 99% Occupied Bandwidth

LIMIT

N/A

TEST CONFIGURATION

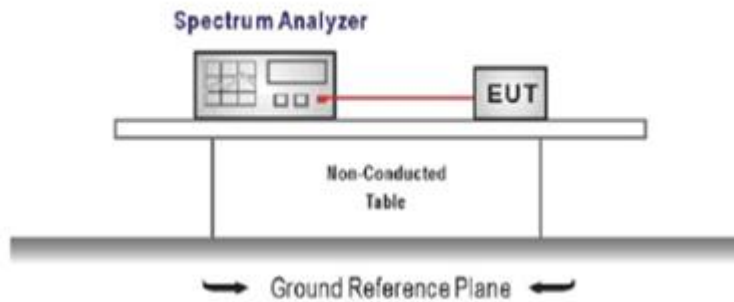

TEST PROCEDURE

1. Connect the antenna port(s) to the spectrum analyzer input.
2. Configure the spectrum analyzer as shown below (enter all losses between the transmitter output and the spectrum analyzer).
Center Frequency = channel center frequency
Span $\geq 1.5 \times$ OBW
RBW = 1%~5%OBW
VBW $\geq 3 \times$ RBW
Sweep time = auto couple
Detector = Peak
Trace mode = max hold
3. Place the radio in continuous transmit mode, allow the trace to stabilize, view the transmitter waveform on the spectrum analyzer.

TEST MODE:

Please refer to the clause 4.3

TEST RESULT

Passed Not Applicable

TEST Data

Please refer to appendix C on the appendix report

5.6. Carrier Frequencies Separation

LIMIT

FCC CFR Title 47 Part 15 Subpart C Section 15.247 (a)(1):

Frequency hopping systems shall have hopping channel carrier frequencies separated by a minimum of 25kHz or the 20 dB bandwidth of the hopping channel, whichever is greater. Alternatively, Frequency hopping systems operating in the 2400-2483.5 MHz band may have hopping channel carrier frequencies that are separated by 25 kHz or two-thirds of the 20 dB bandwidth of the hopping channel, whichever is greater, provided the systems operate with an output power no greater than 125 mW.

TEST CONFIGURATION

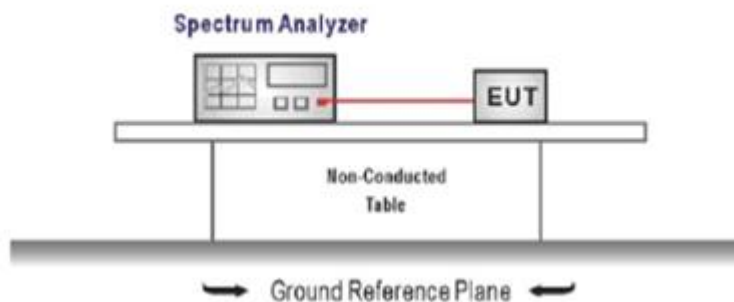

TEST PROCEDURE

1. The transmitter output was connected to the spectrum analyzer through an attenuator, the path loss was compensated to the results for each measurement.
2. Set to the maximum power setting and enable the EUT transmit continuously
3. Use the following spectrum analyzer settings:
 - Span = wide enough to capture the peaks of two adjacent channels
 - RBW \geq 1% of the span, VBW \geq RBW
 - Sweep = auto, Detector function = peak, Trace = max hold
4. Measure and record the results in the test report.

TEST MODE:

Please refer to the clause 4.3

TEST RESULTS

Passed Not Applicable

TEST Data

Please refer to appendix D on the appendix report

5.7. Hopping Channel Number

LIMIT

FCC CFR Title 47 Part 15 Subpart C Section 15.247 (a)(1):

Frequency hopping systems in the 2400–2483.5 MHz band shall use at least **15** channels.

TEST CONFIGURATION

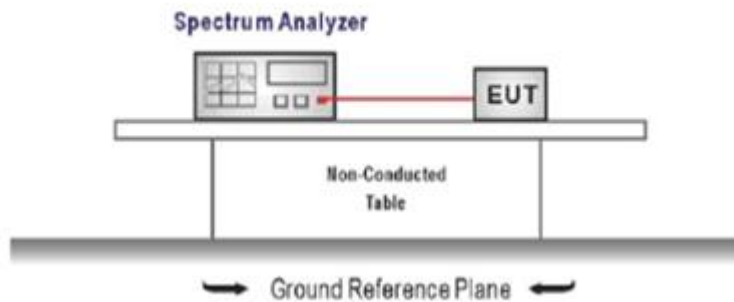

TEST PROCEDURE

1. The transmitter output was connected to the spectrum analyzer through an attenuator, the path loss was compensated to the results for each measurement.
2. Set to the maximum power setting and enable the EUT transmit continuously
3. Use the following spectrum analyzer settings:
Span = the frequency band of operation
RBW \geq 1% of the span, VBW \geq RBW
Sweep = auto, Detector function = peak, Trace = max hold
4. Measure and record the results in the test report.

TEST MODE:

Please refer to the clause 4.3

TEST RESULTS

Passed Not Applicable

TEST Data

Please refer to appendix E on the appendix report

5.8. Dwell Time

LIMIT

FCC CFR Title 47 Part 15 Subpart C Section 15.247 (a)(1):The average time of occupancy on any channel shall not be greater than 0.4 seconds within a pe-riod of 0.4 seconds multiplied by the number of hopping channels employed.

TEST CONFIGURATION

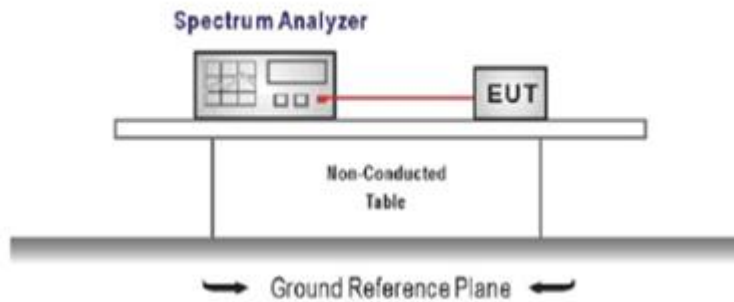

TEST PROCEDURE

1. The transmitter output was connected to the spectrum analyzer through an attenuator, the path loss was compensated to the results for each measurement.
2. Set to the maximum power setting and enable the EUT transmit continuously
3. Use the following spectrum analyzer settings:
Span = zero span, centered on a hopping channel, RBW= 1 MHz, VBW \geq RBW
Sweep = as necessary to capture the entire dwell time per hopping channel,
Detector function = peak, Trace = max hold
4. Measure and record the results in the test report.

TEST MODE:

Please refer to the clause 4.3

TEST RESULTS

Passed Not Applicable

TEST Data

Please refer to appendix F on the appendix report

5.9. Duty Cycle Correction Factor (DCCF)

LIMIT

N/A

TEST CONFIGURATION

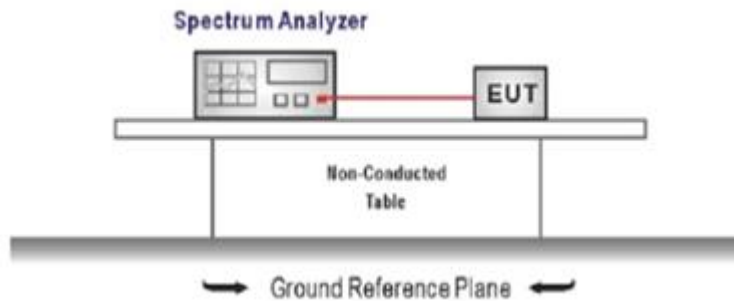

TEST PROCEDURE

1. The transmitter output was connected to the spectrum analyzer through an attenuator, the path loss was compensated to the results for each measurement.
2. Set to the maximum power setting and enable the EUT transmit continuously
3. Use the following spectrum analyzer settings:
Span = zero span, centered on a hopping channel, RBW= 1 MHz, VBW \geq RBW
Sweep = as necessary to capture the entire dwell time per hopping channel,
Detector function = peak, Trigger mode
4. Measure and record the duty cycle data

TEST MODE:

Please refer to the clause 4.3

TEST Data

Please refer to appendix G on the appendix report

5.10. Pseudorandom Frequency Hopping Sequence

LIMIT

FCC CFR Title 47 Part 15 Subpart C Section 15.247 (a)(1): Frequency hopping systems shall have hopping channel carrier frequencies separated by a minimum of 25 kHz or the 20 dB bandwidth of the hopping channel, whichever is greater. Alternatively, frequency hopping systems operating in the 2400–2483.5 MHz band may have hopping channel carrier frequencies that are separated by 25 kHz or two-thirds of the 20 dB bandwidth of the hopping channel, whichever is greater, provided the systems operate with an output power no greater than 125 mW. The system shall hop to channel frequencies that are selected at the system hopping rate from a pseudo-randomly ordered list of hopping frequencies. Each frequency must be used equally on the average by each transmitter. The system receivers shall have input bandwidths that match the hopping channel bandwidths of their corresponding transmitters and shall shift frequencies in synchronization with the transmitted signals.

TEST RESULTS

The pseudorandom frequency hopping sequence may be generated in a nine-stage shift register whose 5th and 9th stage outputs are added in a modulo-two addition stage. And the result is fed back to the input of the first stage. The sequence begins with the first one of 9 consecutive ones, for example: the shift register is initialized with nine ones.

- Number of shift register stages: 9
- Length of pseudo-random sequence: $2^9 - 1 = 511$ bits
- Longest sequence of zeros: 8 (non-inverted signal)

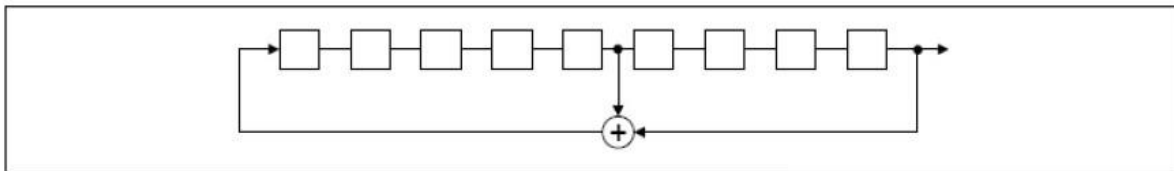

Linear Feedback Shift Register for Generation of the PRBS sequence

An example of pseudorandom frequency hopping sequence as follows:

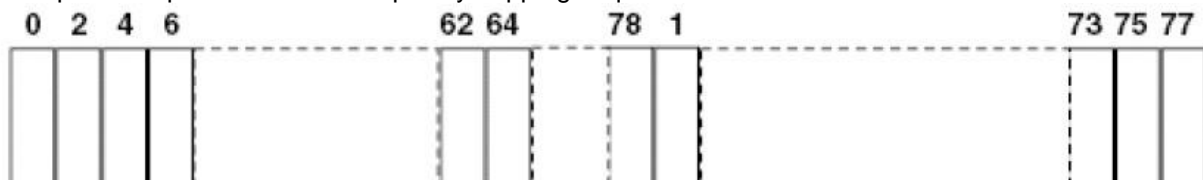

Each frequency used equally on the average by each transmitter.

The system receiver has input bandwidths that match the hopping channel bandwidths of their corresponding transmitter and shifts frequencies in synchronization with the transmitted signals.

5.11. Conducted Band edge and Spurious Emission

LIMIT

FCC CFR Title 47 Part 15 Subpart C Section 15.247 (d): In any 100 kHz bandwidth outside the frequency band in which the spread spectrum intentional radiator is operating, the radio frequency power that is produced by the intentional radiator shall be at least 20 dB below that in the 100 kHz bandwidth within the band that contains the highest level of the desired power, based on either an RF conducted or a radiated measurement.

TEST CONFIGURATION

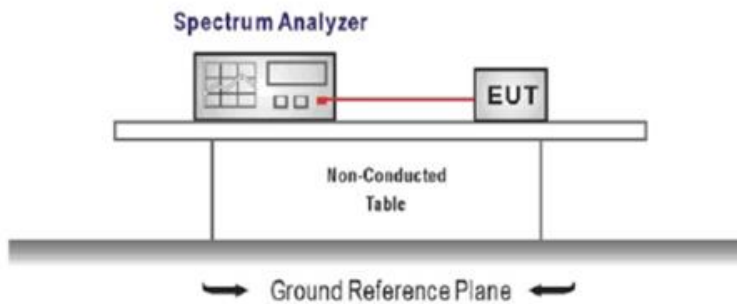

TEST PROCEDURE

1. Connect the antenna port(s) to the spectrum analyzer input.
2. Establish a reference level by using the following procedure
Center frequency=DTS channel center frequency
The span = 1.5 times the DTS bandwidth.
RBW = 100 kHz, VBW $\geq 3 \times$ RBW
Detector = peak, Sweep time = auto couple, Trace mode = max hold
Allow trace to fully stabilize
Use the peak marker function to determine the maximum PSD level

Note that the channel found to contain the maximum PSD level can be used to establish the reference level.

3. Emission level measurement
Set the center frequency and span to encompass frequency range to be measured
RBW = 100 kHz, VBW $\geq 3 \times$ RBW
Detector = peak, Sweep time = auto couple, Trace mode = max hold
Allow trace to fully stabilize
Use the peak marker function to determine the maximum amplitude level.
4. Place the radio in continuous transmit mode, allow the trace to stabilize, view the transmitter waveform on the spectrum analyzer.
5. Ensure that the amplitude of all unwanted emission outside of the authorized frequency band excluding restricted frequency bands) are attenuated by at least the minimum requirements specified (at least 20 dB relative to the maximum in-band peak PSD level in 100 kHz). Report the three highest emission relative to the limit.

TEST MODE:

Please refer to the clause 4.3

TEST RESULT

Passed **Not Applicable**

TEST Data

Please refer to appendix H on the appendix report

5.12. Radiated Band edge Emission

LIMIT

FCC CFR Title 47 Part 15 Subpart C Section 15.247 (d):

In any 100 kHz bandwidth outside the frequency band in which the spread spectrum or digitally modulated intentional radiator is operating, Radiated Emissions which fall in the restricted bands, as defined in §15.205(a), must also comply with the Radiated Emissions limits specified in §15.209(a) (see §15.205(c)).

TEST CONFIGURATION

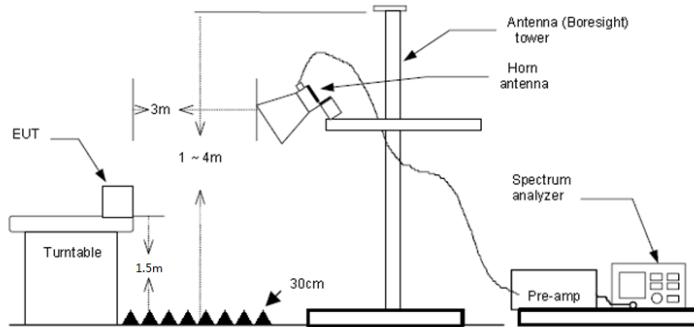

TEST PROCEDURE

1. The EUT was setup and tested according to ANSI C63.10 .
2. The EUT is placed on a turn table which is 1.5 meter above ground. The turn table is rotated 360 degrees to determine the position of the maximum emission level.
3. The EUT was positioned such that the distance from antenna to the EUT was 3 meters.
4. The antenna is scanned from 1 meter to 4 meters to find out the maximum emission level. This is repeated for both horizontal and vertical polarization of the antenna. In order to find the maximum emission, all of the interface cables were manipulated according to ANSI C63.10 on radiated measurement.
5. Use the following spectrum analyzer settings:
 - a) Span shall wide enough to fully capture the emission being measured
 - b) Set RBW=100kHz for <1GHz, VBW=3*RBW, Sweep time=auto, Detector=peak, Trace=max hold
 - c) Set RBW=1MHz, VBW=3MHz for >1GHz, Sweep time=auto, Detector=peak, Trace=max hold for Peak measurement

For average measurement: use duty cycle correction factor method (DCCF)
 Averager level = Peak level + DCCF

TEST MODE:

Please refer to the clause 4.3

TEST RESULT

Passed Not Applicable

Note:

- 1) Level= Reading + Factor; Factor =Antenna Factor+ Cable Loss- Preamp Factor
- 2) Margin = Limit – Level
- 3) Average measurement was not performed if peak level is lower than average limit(54 dBuV/m).

| Test channel: | | | | | CH00 | | | | |
|-----------------|-------------------|-----------------------|-----------------|--------------------------|----------------|---------------------|-----------------|--------------|------------|
| Frequency (MHz) | Read Level (dBuV) | Antenna Factor (dB/m) | Cable Loss (dB) | Preamplifier Factor (dB) | Level (dBuV/m) | Limit Line (dBuV/m) | Over Limit (dB) | Polarization | Test value |
| 2310.00 | 40.23 | 27.96 | 7.73 | 38.17 | 37.75 | 74.00 | -36.25 | Horizontal | Peak |
| 2390.03 | 39.76 | 27.72 | 7.84 | 37.97 | 37.35 | 74.00 | -36.65 | Horizontal | Peak |
| 2310.00 | 36.31 | 27.96 | 7.73 | 38.17 | 33.83 | 74.00 | -40.17 | Vertical | Peak |
| 2390.03 | 40.39 | 27.72 | 7.84 | 37.97 | 37.98 | 74.00 | -36.02 | Vertical | Peak |

| Test channel: | | | | | | CH78 | | | | |
|-----------------|-------------------|-----------------------|-----------------|--------------------------|-----------|----------------|---------------------|-----------------|--------------|------------|
| Frequency (MHz) | Read Level (dBuV) | Antenna Factor (dB/m) | Cable Loss (dB) | Preamplifier Factor (dB) | DCCF (dB) | Level (dBuV/m) | Limit Line (dBuV/m) | Over Limit (dB) | Polarization | Test value |
| 2483.50 | 59.67 | 27.43 | 8.04 | 37.59 | 0.00 | 57.55 | 74.00 | -16.45 | Horizontal | Peak |
| 2500.00 | 37.85 | 27.40 | 8.08 | 37.38 | 0.00 | 35.95 | 74.00 | -38.05 | Horizontal | Peak |
| 2483.50 | 59.67 | 27.43 | 8.04 | 37.59 | -30.46 | 27.09 | 54.00 | -26.91 | Horizontal | Average |
| 2500.00 | 37.85 | 27.40 | 8.08 | 37.38 | -30.46 | 5.49 | 54.00 | -48.51 | Horizontal | Average |
| 2483.50 | 59.60 | 27.43 | 8.04 | 37.59 | 0.00 | 57.48 | 74.00 | -16.52 | Vertical | Peak |
| 2500.00 | 38.13 | 27.40 | 8.08 | 37.38 | 0.00 | 36.23 | 74.00 | -37.77 | Vertical | Peak |
| 2483.50 | 59.60 | 27.43 | 8.04 | 37.59 | -30.46 | 27.02 | 54.00 | -26.98 | Vertical | Average |
| 2500.00 | 38.13 | 27.40 | 8.08 | 37.38 | -30.46 | 5.77 | 54.00 | -48.23 | Vertical | Average |

5.13. Radiated Spurious Emission

LIMIT

FCC CFR Title 47 Part 15 Subpart C Section 15.209

| Frequency | Limit (dBuV/m) | Value |
|----------------------|-------------------|------------|
| 0.009 MHz ~0.49 MHz | 2400/F(kHz) @300m | Quasi-peak |
| 0.49 MHz ~ 1.705 MHz | 24000/F(kHz) @30m | Quasi-peak |
| 1.705 MHz ~30 MHz | 30 @30m | Quasi-peak |

Note: Limit dBuV/m @3m = Limit dBuV/m @300m + 40*log(300/3)= Limit dBuV/m @300m +80,

Limit dBuV/m @3m = Limit dBuV/m @30m +40*log(30/3)= Limit dBuV/m @30m + 40.

| Frequency | Limit (dBuV/m @3m) | Value |
|---------------|--------------------|------------|
| 30MHz~88MHz | 40.00 | Quasi-peak |
| 88MHz~216MHz | 43.50 | Quasi-peak |
| 216MHz~960MHz | 46.00 | Quasi-peak |
| 960MHz~1GHz | 54.00 | Quasi-peak |
| Above 1GHz | 54.00 | Average |
| | 74.00 | Peak |

TEST CONFIGURATION

- 9 kHz ~ 30 MHz

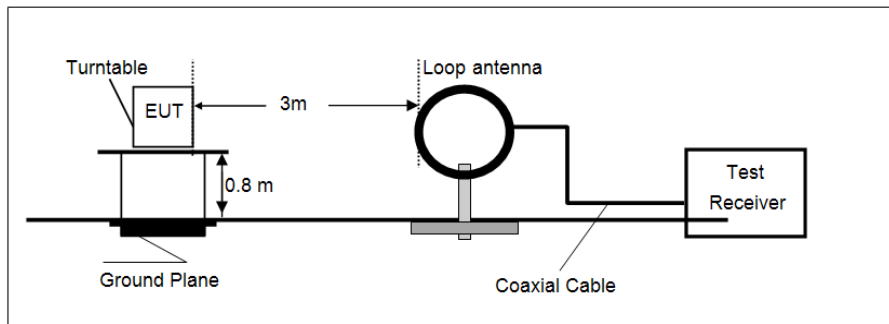

- 30 MHz ~ 1 GHz

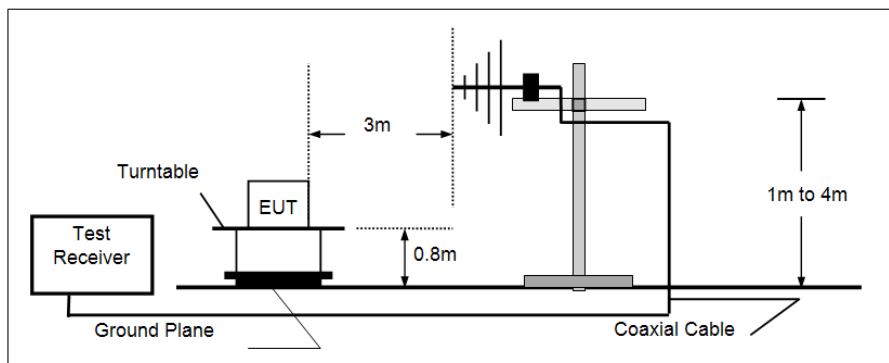

- Above 1 GHz

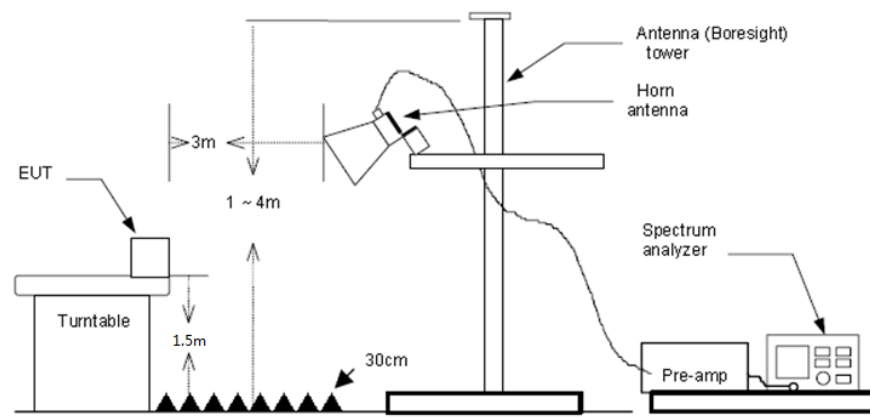

TEST PROCEDURE

1. The EUT was setup and tested according to ANSI C63.10 .
2. The EUT is placed on a turn table which is 0.8 meter above ground for below 1 GHz, and 1.5 m for above 1 GHz. The turn table is rotated 360 degrees to determine the position of the maximum emission level.
3. The EUT was set 3 meters from the receiving antenna, which was mounted on the top of a variable height antenna tower.
4. For each suspected emission, the EUT was arranged to its worst case and then tune the Antenna tower (from 1 m to 4 m) and turntable (from 0 degree to 360 degrees) to find the maximum reading. A pre-amp and a high pass filter are used for the test in order to get better signal level to comply with the guidelines.
5. Set to the maximum power setting and enable the EUT transmit continuously.
6. Use the following spectrum analyzer settings
 - a) Span shall wide enough to fully capture the emission being measured;
 - b) Below 1 GHz:
 - RBW=120 kHz, VBW=300 kHz, Sweep=auto, Detector function=peak, Trace=max hold;
 - If the emission level of the EUT measured by the peak detector is 3 dB lower than the applicable limit, the peak emission level will be reported. Otherwise, the emission measurement will be repeated using the quasi-peak detector and reported.
 - c) Set RBW=1MHz, VBW=3MHz for >1GHz, Sweep time=auto, Detector=peak, Trace=max hold for Peak measurement

For average measurement: use duty cycle correction factor method (DCCF)
 Averager level = Peak level + DCCF

TEST MODE:

Please refer to the clause 4.3

TEST RESULT

Passed **Not Applicable**

Note:

- 1) Level= Reading + Factor/Transd; Factor/Transd =Antenna Factor+ Cable Loss- Preamp Factor
- 2) Margin = Limit – Level
- 3) Average measurement was not performed if peak level is lower than average limit(54 dBuV/m) for above 1GHz.

TEST DATA FOR 9 kHz ~ 30 MHz

The EUT was pre-scanned this frequency band, found the radiated level 20dB lower than the limit, so don't show data on this report.

TEST DATA FOR 30 MHz ~ 1000 MHz

Have pre-scan all test channel, found CH39 which it was worst case, so only show the worst case's data on this report.

Polarization:

Horizontal

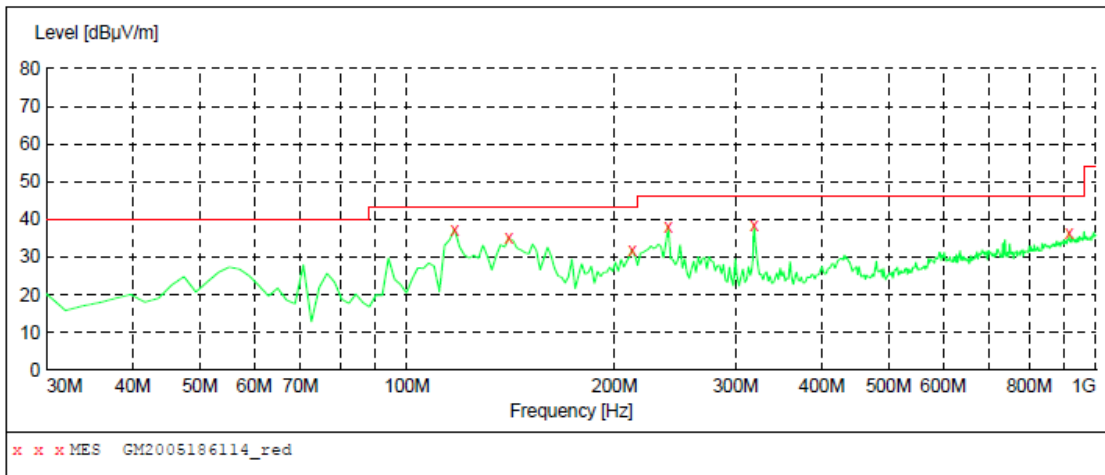

MEASUREMENT RESULT: "GM2005186114_red"

5/18/2020 11:19PM

| Frequency MHz | Level dBµV/m | Transd dB | Limit dBµV/m | Margin dB | Det. | Height cm | Azimuth deg | Polarization |
|------------------|-----------------|--------------|-----------------|--------------|------|--------------|----------------|--------------|
| 117.300000 | 37.40 | -11.3 | 43.5 | 6.1 | QP | 100.0 | 316.00 | HORIZONTAL |
| 140.580000 | 35.00 | -13.6 | 43.5 | 8.5 | QP | 100.0 | 208.00 | HORIZONTAL |
| 212.360000 | 32.00 | -9.8 | 43.5 | 11.5 | QP | 100.0 | 300.00 | HORIZONTAL |
| 239.520000 | 38.10 | -8.5 | 46.0 | 7.9 | QP | 100.0 | 168.00 | HORIZONTAL |
| 319.060000 | 38.30 | -6.1 | 46.0 | 7.7 | QP | 100.0 | 196.00 | HORIZONTAL |
| 914.640000 | 36.50 | 7.5 | 46.0 | 9.5 | QP | 100.0 | 12.00 | HORIZONTAL |

Polarization:

Vertical

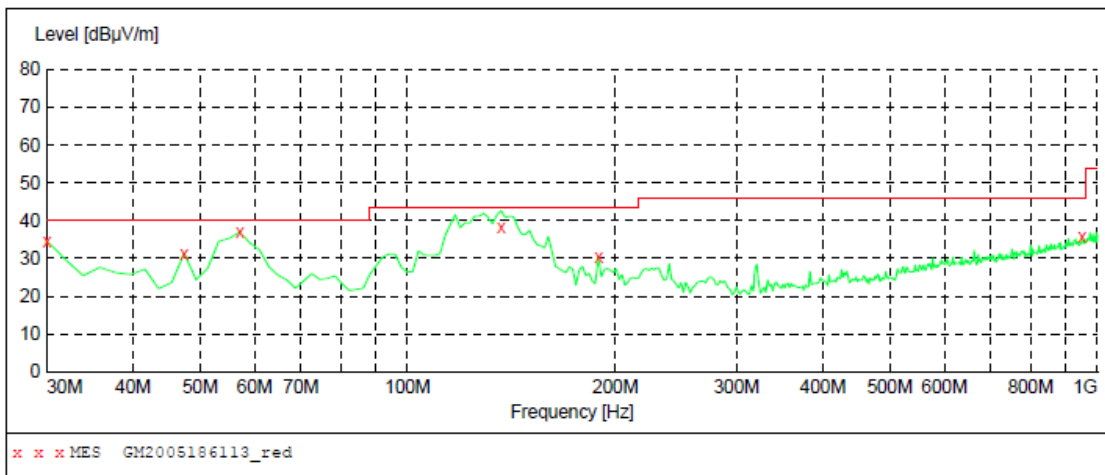

MEASUREMENT RESULT: "GM2005186113_red"

5/18/2020 11:16PM

| Frequency MHz | Level dBµV/m | Transd dB | Limit dBµV/m | Margin dB | Det. | Height cm | Azimuth deg | Polarization |
|------------------|-----------------|--------------|-----------------|--------------|------|--------------|----------------|--------------|
| 30.000000 | 34.70 | -12.8 | 40.0 | 5.3 | QP | 100.0 | 22.00 | VERTICAL |
| 47.460000 | 31.40 | -8.6 | 40.0 | 8.6 | QP | 100.0 | 314.00 | VERTICAL |
| 57.160000 | 37.00 | -8.7 | 40.0 | 3.0 | QP | 100.0 | 148.00 | VERTICAL |
| 136.700000 | 38.40 | -13.4 | 43.5 | 5.1 | QP | 100.0 | 250.00 | VERTICAL |
| 189.080000 | 30.40 | -10.6 | 43.5 | 13.1 | QP | 100.0 | 148.00 | VERTICAL |
| 949.560000 | 35.60 | 8.1 | 46.0 | 10.4 | QP | 100.0 | 119.00 | VERTICAL |

TEST DATA FOR 1 GHz ~ 25 GHz

| Test channel: | | | | | CH00 | | | | |
|-----------------|-------------------|-----------------------|-----------------|--------------------|----------------|---------------------|-----------------|--------------|------------|
| Frequency (MHz) | Read Level (dBuV) | Antenna Factor (dB/m) | Cable Loss (dB) | Preamp Factor (dB) | Level (dBuV/m) | Limit Line (dBuV/m) | Over Limit (dB) | Polarization | Test value |
| 1472.44 | 36.91 | 26.01 | 5.21 | 37.08 | 31.05 | 74.00 | -42.95 | Vertical | Peak |
| 3308.19 | 40.25 | 28.48 | 7.85 | 37.30 | 39.28 | 74.00 | -34.72 | Vertical | Peak |
| 5086.52 | 33.87 | 32.20 | 9.74 | 35.21 | 40.60 | 74.00 | -33.40 | Vertical | Peak |
| 8104.56 | 33.00 | 37.18 | 12.55 | 33.04 | 49.69 | 74.00 | -24.31 | Vertical | Peak |
| 1593.34 | 37.19 | 25.41 | 5.55 | 37.18 | 30.97 | 74.00 | -43.03 | Horizontal | Peak |
| 3308.19 | 40.25 | 28.48 | 7.85 | 37.30 | 39.28 | 74.00 | -34.72 | Horizontal | Peak |
| 5191.17 | 34.23 | 31.75 | 9.82 | 35.00 | 40.80 | 74.00 | -33.20 | Horizontal | Peak |
| 7099.75 | 31.90 | 36.10 | 11.85 | 33.70 | 46.15 | 74.00 | -27.85 | Horizontal | Peak |

| Test channel: | | | | | CH39 | | | | |
|-----------------|-------------------|-----------------------|-----------------|--------------------|----------------|---------------------|-----------------|--------------|------------|
| Frequency (MHz) | Read Level (dBuV) | Antenna Factor (dB/m) | Cable Loss (dB) | Preamp Factor (dB) | Level (dBuV/m) | Limit Line (dBuV/m) | Over Limit (dB) | Polarization | Test value |
| 1577.20 | 37.03 | 25.45 | 5.51 | 37.16 | 30.83 | 74.00 | -43.17 | Vertical | Peak |
| 2092.18 | 36.79 | 27.01 | 6.35 | 37.60 | 32.55 | 74.00 | -41.45 | Vertical | Peak |
| 4971.32 | 33.20 | 31.67 | 9.65 | 35.43 | 39.09 | 74.00 | -34.91 | Vertical | Peak |
| 6992.14 | 31.31 | 35.35 | 11.84 | 33.88 | 44.62 | 74.00 | -29.38 | Vertical | Peak |
| 1399.35 | 36.38 | 26.10 | 5.00 | 37.12 | 30.36 | 74.00 | -43.64 | Horizontal | Peak |
| 3258.04 | 39.95 | 28.67 | 7.79 | 37.34 | 39.07 | 74.00 | -34.93 | Horizontal | Peak |
| 6125.24 | 33.06 | 32.65 | 10.88 | 34.01 | 42.58 | 74.00 | -31.42 | Horizontal | Peak |
| 7961.43 | 31.62 | 36.95 | 12.49 | 33.07 | 47.99 | 74.00 | -26.01 | Horizontal | Peak |

| Test channel: | | | | | CH78 | | | | |
|-----------------|-------------------|-----------------------|-----------------|--------------------|----------------|---------------------|-----------------|--------------|------------|
| Frequency (MHz) | Read Level (dBuV) | Antenna Factor (dB/m) | Cable Loss (dB) | Preamp Factor (dB) | Level (dBuV/m) | Limit Line (dBuV/m) | Over Limit (dB) | Polarization | Test value |
| 1270.33 | 37.59 | 25.94 | 4.78 | 37.18 | 31.13 | 74.00 | -42.87 | Vertical | Peak |
| 3359.10 | 38.60 | 28.44 | 7.91 | 37.26 | 37.69 | 74.00 | -36.31 | Vertical | Peak |
| 4202.50 | 36.81 | 30.11 | 8.94 | 36.56 | 39.30 | 74.00 | -34.70 | Vertical | Peak |
| 5747.59 | 33.37 | 31.90 | 10.51 | 34.28 | 41.50 | 74.00 | -32.50 | Vertical | Peak |
| 1182.94 | 38.15 | 25.53 | 4.62 | 37.23 | 31.07 | 74.00 | -42.93 | Horizontal | Peak |
| 3200.50 | 41.46 | 28.90 | 7.72 | 37.40 | 40.68 | 74.00 | -33.32 | Horizontal | Peak |
| 5099.49 | 34.88 | 32.20 | 9.75 | 35.18 | 41.65 | 74.00 | -32.35 | Horizontal | Peak |
| 7135.98 | 32.26 | 36.24 | 11.86 | 33.64 | 46.72 | 74.00 | -27.28 | Horizontal | Peak |

Remark:

1. Final Level = Receiver Read level + Antenna Factor + Cable Loss – Preamplifier Factor
2. The peak level is lower than average limit(54 dBuV/m), this data is the too weak instrument of signal is unable to test.
3. The emission levels of other frequencies are very lower than the limit and not show in test report.

6. TEST SETUP PHOTOS

Radiated Emission

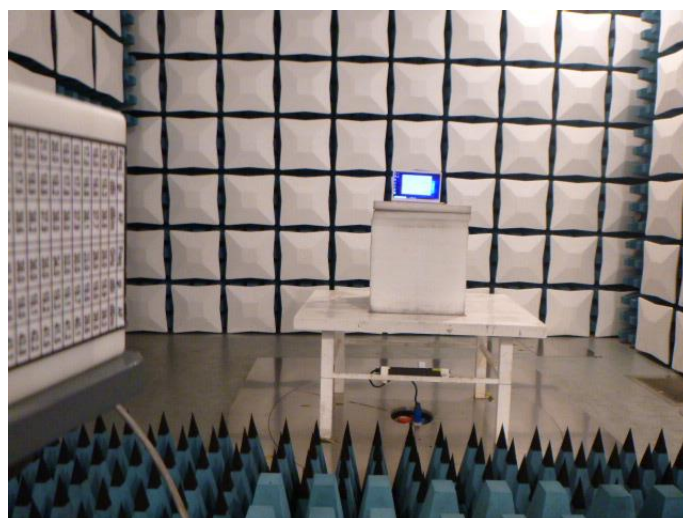
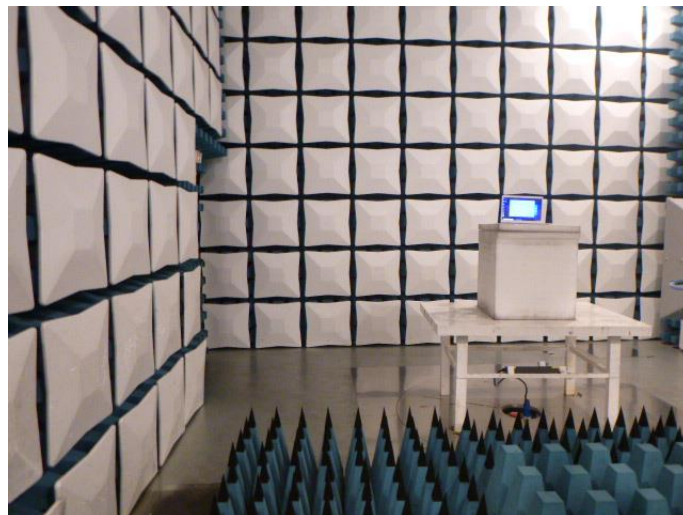

AC Conducted Emission



7. EXTERANAL AND INTERNAL PHOTOS

Reference to the test report No. : CHTEW20050082.

8. APPENDIX REPORT

APPENDIX REPORT

| | | | |
|-----------------|-----------------|---------------------|---------------------|
| Project No. | SHT2005029401EW | Radio Specification | Bluetooth EDR |
| Test sample No. | YPHT20050294003 | Model No. | L14WB2BK |
| Start test date | 2020/5/19 | Finish date | 2020/5/19 |
| Temperature | 25°C | Humidity | 50% |
| Test Engineer | JiongSheng.Feng | Auditor | <i>William.wang</i> |

| Appendix clause | Test item | Result |
|-----------------|--|--------|
| A | Peak Output Power | PASS |
| B | 20 dB Bandwidth | PASS |
| C | 99% Occupied Bandwidth | PASS |
| D | Carrier Frequencies Separation | PASS |
| E | Hopping Channel Number | PASS |
| F | Dwell Time | PASS |
| G | Duty Cycle Correction Factor (DCCF) | PASS |
| H | Band edge and Spurious Emissions(coducted) | PASS |

Appendix A: Peak Output Power

| Modulation type | Channel | Output power (dBm) | Average Output power (dBm) | Limit (dBm) | Result |
|-----------------|---------|--------------------|----------------------------|-------------|--------|
| GFSK | 00 | 4.09 | 3.82 | ≤ 30.00 | Pass |
| | 39 | 3.93 | 3.66 | | |
| | 78 | 3.11 | 2.98 | | |
| π/4DQPSK | 00 | 5.47 | 4.91 | ≤ 21.00 | Pass |
| | 39 | 5.34 | 4.73 | | |
| | 78 | 4.75 | 4.12 | | |
| 8DPSK | 00 | 5.73 | 5.00 | ≤ 21.00 | Pass |
| | 39 | 5.54 | 4.81 | | |
| | 78 | 4.93 | 4.18 | | |

| Modulation Type: | | GFSK |
|------------------|--|------|
| CH00 | | |
| CH39 | | |
| CH78 | | |

Modulation Type: $\pi/4$ QPSK

CH00

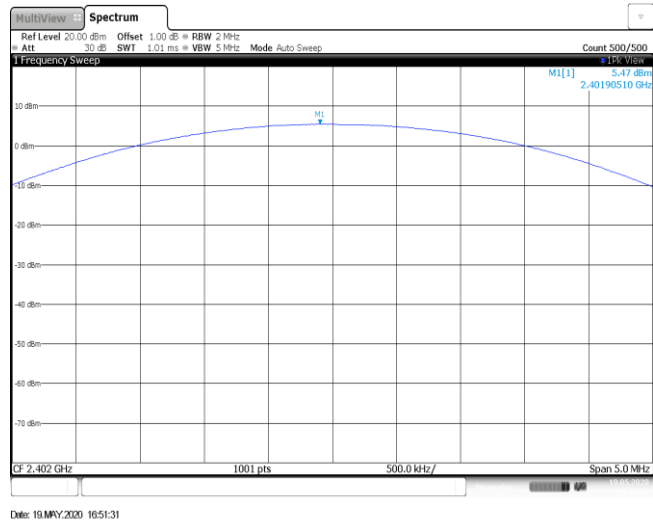

CH39

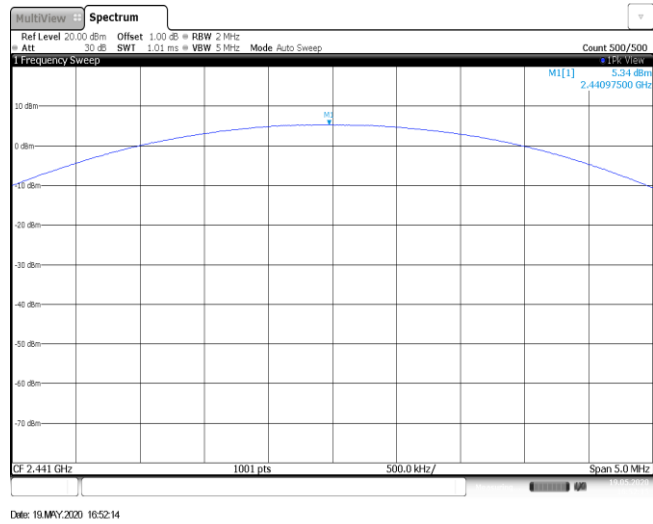

CH78

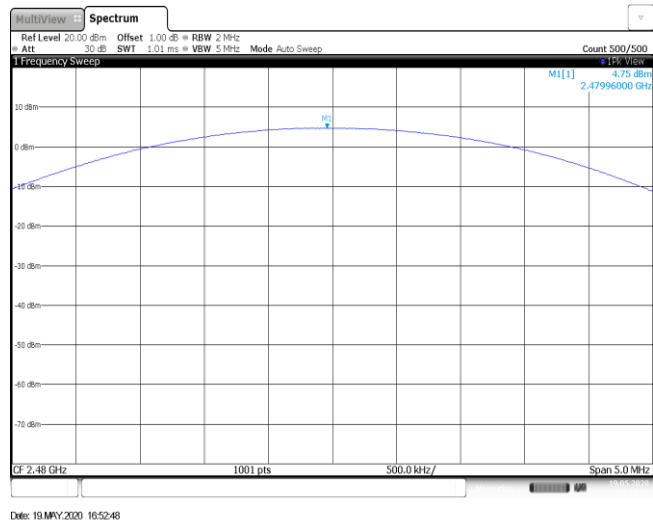

Modulation Type: 8DPSK

CH00

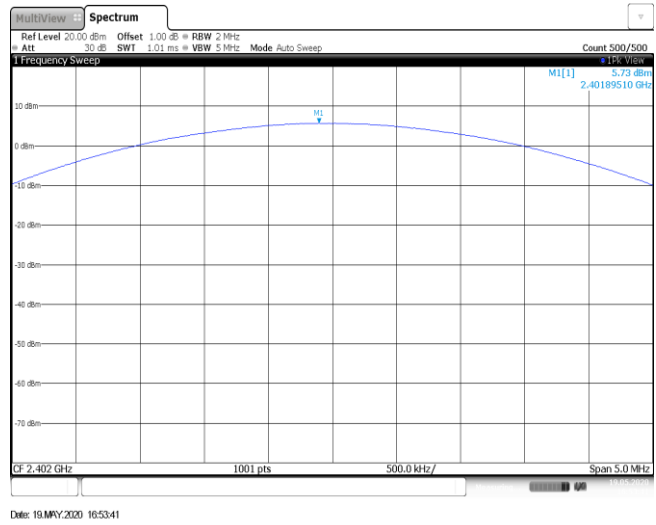

CH39

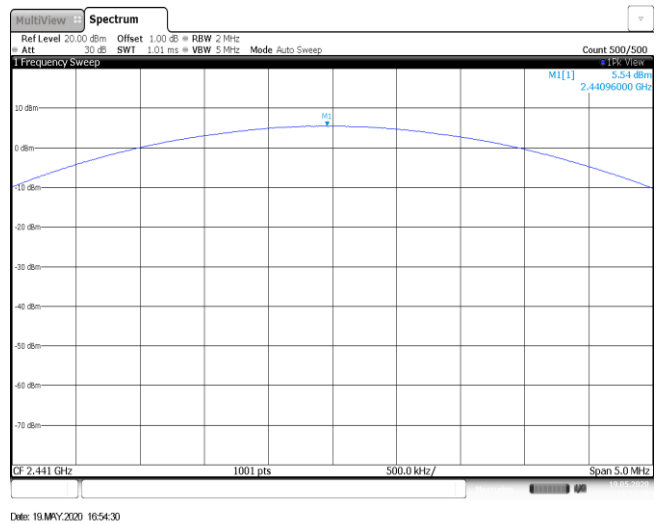

CH78

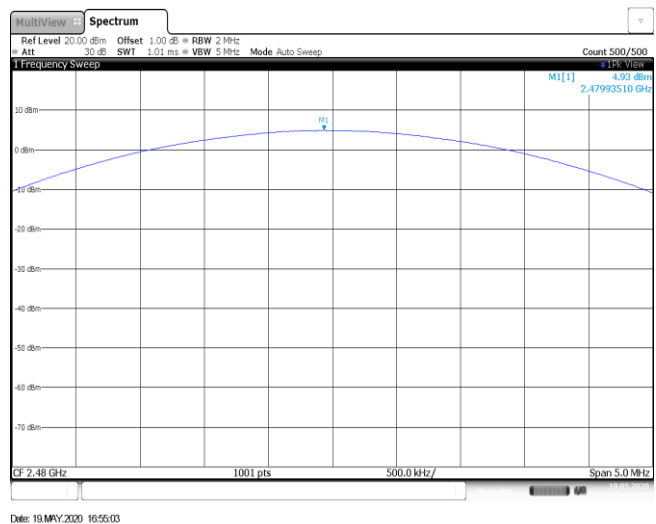

Appendix B : 20 dB Bandwidth

| Modulation type | Channel | 20 dB Bandwidth (kHz) | Limit (kHz) | Result |
|-----------------|---------|-----------------------|-------------|--------|
| GFSK | 00 | 699.30 | - | Pass |
| | 39 | 784.20 | | |
| | 78 | 784.20 | | |
| $\pi/4$ DQPSK | 00 | 1350.00 | - | Pass |
| | 39 | 1352.50 | | |
| | 78 | 1350.00 | | |
| 8DPSK | 00 | 1297.50 | - | Pass |
| | 39 | 1297.50 | | |
| | 78 | 1297.50 | | |

| Modulation Type: | | GFSK | | | | | | | | | | | | | | | | | | | | | | | | | | | | |
|------------------|---|------|---------------|------------|------------|-----------------|---------|----------|-----------------|----|---|--|-------------|-----------|----|---------|----|---|--|--------------|------------|------------|------------|----|---|--|---------------|------------|----------|--------|
| CH00 | <p>Ref Level 11.00 dBm Offset 20.00 dB SWI 419 us (-0.3 ms) @ VSW 30 kHz Mode Auto FFT</p> <p>CF 2.402 GHz 1001 pts 250.0 kHz/ Span 2.5 MHz</p> <table border="1"> <thead> <tr> <th>Type</th> <th>Ref</th> <th>Trc</th> <th>X-Value</th> <th>Y-Value</th> <th>Function</th> <th>Function Result</th> </tr> </thead> <tbody> <tr> <td>M1</td> <td>1</td> <td></td> <td>2.40202 GHz</td> <td>-6.92 dBm</td> <td>nB</td> <td>26.1185</td> </tr> <tr> <td>T1</td> <td>1</td> <td></td> <td>2.401628 GHz</td> <td>-27.51 dBm</td> <td>nB down BW</td> <td>699.30 kHz</td> </tr> <tr> <td>T2</td> <td>1</td> <td></td> <td>2.4023621 GHz</td> <td>-26.89 dBm</td> <td>Q Factor</td> <td>3434.9</td> </tr> </tbody> </table> <p>Date: 20 MAY 2020 09:24:33</p> | | Type | Ref | Trc | X-Value | Y-Value | Function | Function Result | M1 | 1 | | 2.40202 GHz | -6.92 dBm | nB | 26.1185 | T1 | 1 | | 2.401628 GHz | -27.51 dBm | nB down BW | 699.30 kHz | T2 | 1 | | 2.4023621 GHz | -26.89 dBm | Q Factor | 3434.9 |
| Type | Ref | Trc | X-Value | Y-Value | Function | Function Result | | | | | | | | | | | | | | | | | | | | | | | | |
| M1 | 1 | | 2.40202 GHz | -6.92 dBm | nB | 26.1185 | | | | | | | | | | | | | | | | | | | | | | | | |
| T1 | 1 | | 2.401628 GHz | -27.51 dBm | nB down BW | 699.30 kHz | | | | | | | | | | | | | | | | | | | | | | | | |
| T2 | 1 | | 2.4023621 GHz | -26.89 dBm | Q Factor | 3434.9 | | | | | | | | | | | | | | | | | | | | | | | | |
| CH39 | <p>Ref Level 11.00 dBm Offset 20.00 dB SWI 419 us (-0.3 ms) @ VSW 30 kHz Mode Auto FFT</p> <p>CF 2.441 GHz 1001 pts 250.0 kHz/ Span 2.5 MHz</p> <table border="1"> <thead> <tr> <th>Type</th> <th>Ref</th> <th>Trc</th> <th>X-Value</th> <th>Y-Value</th> <th>Function</th> <th>Function Result</th> </tr> </thead> <tbody> <tr> <td>M1</td> <td>1</td> <td></td> <td>2.44102 GHz</td> <td>-6.92 dBm</td> <td>nB</td> <td>26.0485</td> </tr> <tr> <td>T1</td> <td>1</td> <td></td> <td>2.440628 GHz</td> <td>-27.50 dBm</td> <td>nB down BW</td> <td>784.20 kHz</td> </tr> <tr> <td>T2</td> <td>1</td> <td></td> <td>2.4414471 GHz</td> <td>-26.71 dBm</td> <td>Q Factor</td> <td>3112.7</td> </tr> </tbody> </table> <p>Date: 20 MAY 2020 09:23:59</p> | | Type | Ref | Trc | X-Value | Y-Value | Function | Function Result | M1 | 1 | | 2.44102 GHz | -6.92 dBm | nB | 26.0485 | T1 | 1 | | 2.440628 GHz | -27.50 dBm | nB down BW | 784.20 kHz | T2 | 1 | | 2.4414471 GHz | -26.71 dBm | Q Factor | 3112.7 |
| Type | Ref | Trc | X-Value | Y-Value | Function | Function Result | | | | | | | | | | | | | | | | | | | | | | | | |
| M1 | 1 | | 2.44102 GHz | -6.92 dBm | nB | 26.0485 | | | | | | | | | | | | | | | | | | | | | | | | |
| T1 | 1 | | 2.440628 GHz | -27.50 dBm | nB down BW | 784.20 kHz | | | | | | | | | | | | | | | | | | | | | | | | |
| T2 | 1 | | 2.4414471 GHz | -26.71 dBm | Q Factor | 3112.7 | | | | | | | | | | | | | | | | | | | | | | | | |
| CH78 | <p>Ref Level 11.00 dBm Offset 20.00 dB SWI 419 us (-0.3 ms) @ VSW 30 kHz Mode Auto FFT</p> <p>CF 2.48 GHz 1001 pts 250.0 kHz/ Span 2.5 MHz</p> <table border="1"> <thead> <tr> <th>Type</th> <th>Ref</th> <th>Trc</th> <th>X-Value</th> <th>Y-Value</th> <th>Function</th> <th>Function Result</th> </tr> </thead> <tbody> <tr> <td>M1</td> <td>1</td> <td></td> <td>2.48002 GHz</td> <td>-7.66 dBm</td> <td>nB</td> <td>25.0485</td> </tr> <tr> <td>T1</td> <td>1</td> <td></td> <td>2.479628 GHz</td> <td>-27.67 dBm</td> <td>nB down BW</td> <td>784.20 kHz</td> </tr> <tr> <td>T2</td> <td>1</td> <td></td> <td>2.4804471 GHz</td> <td>-27.60 dBm</td> <td>Q Factor</td> <td>3162.4</td> </tr> </tbody> </table> <p>Date: 20 MAY 2020 09:23:19</p> | | Type | Ref | Trc | X-Value | Y-Value | Function | Function Result | M1 | 1 | | 2.48002 GHz | -7.66 dBm | nB | 25.0485 | T1 | 1 | | 2.479628 GHz | -27.67 dBm | nB down BW | 784.20 kHz | T2 | 1 | | 2.4804471 GHz | -27.60 dBm | Q Factor | 3162.4 |
| Type | Ref | Trc | X-Value | Y-Value | Function | Function Result | | | | | | | | | | | | | | | | | | | | | | | | |
| M1 | 1 | | 2.48002 GHz | -7.66 dBm | nB | 25.0485 | | | | | | | | | | | | | | | | | | | | | | | | |
| T1 | 1 | | 2.479628 GHz | -27.67 dBm | nB down BW | 784.20 kHz | | | | | | | | | | | | | | | | | | | | | | | | |
| T2 | 1 | | 2.4804471 GHz | -27.60 dBm | Q Factor | 3162.4 | | | | | | | | | | | | | | | | | | | | | | | | |

Modulation Type: $\pi/4$ DQPSK

CH00

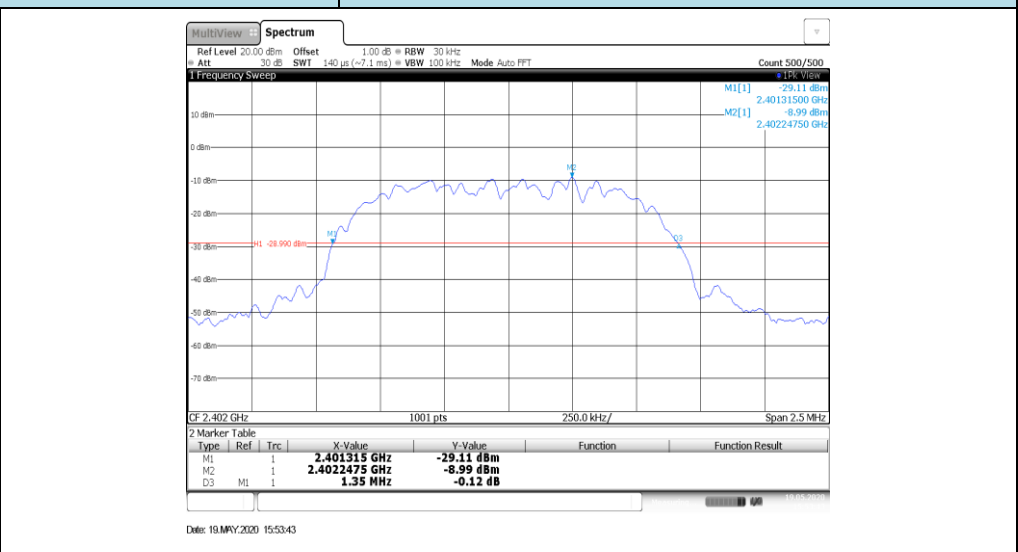

CH39

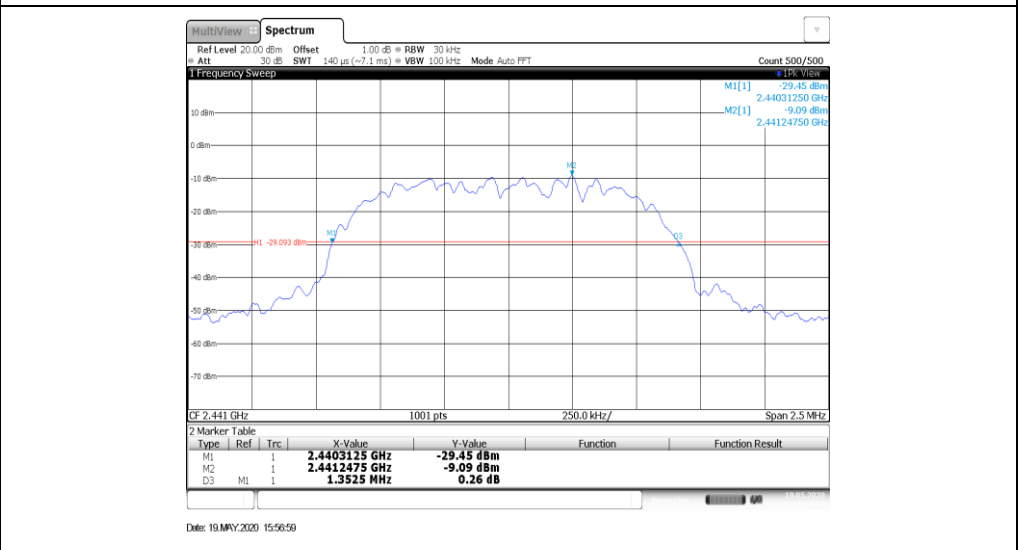

CH78

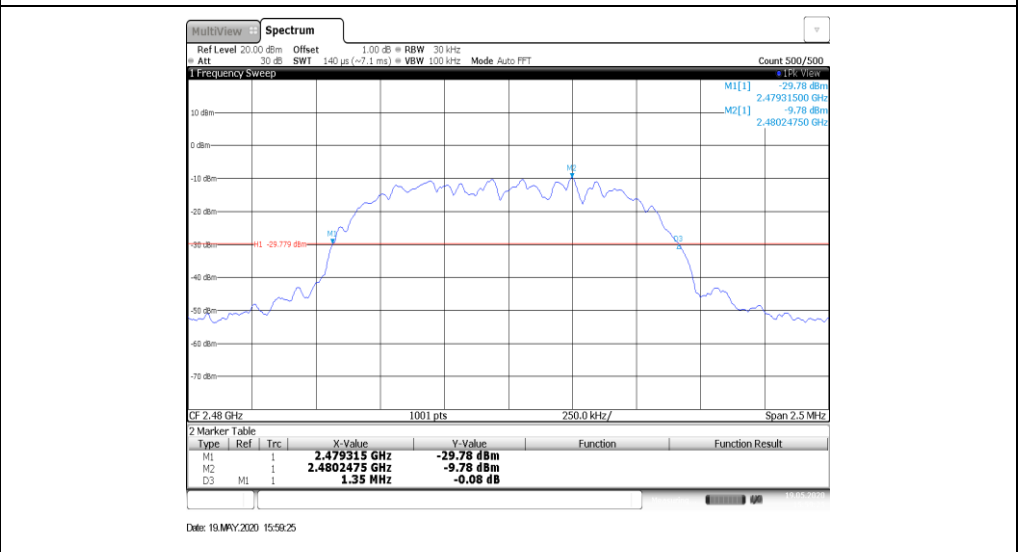

Modulation Type: 8DPSK

CH00

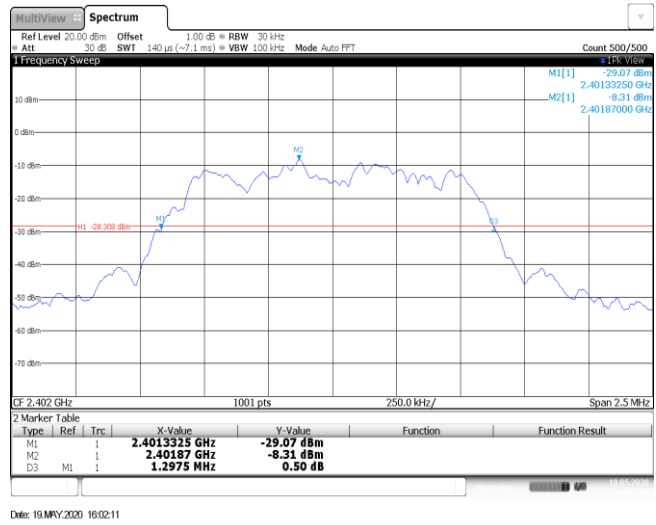

CH39

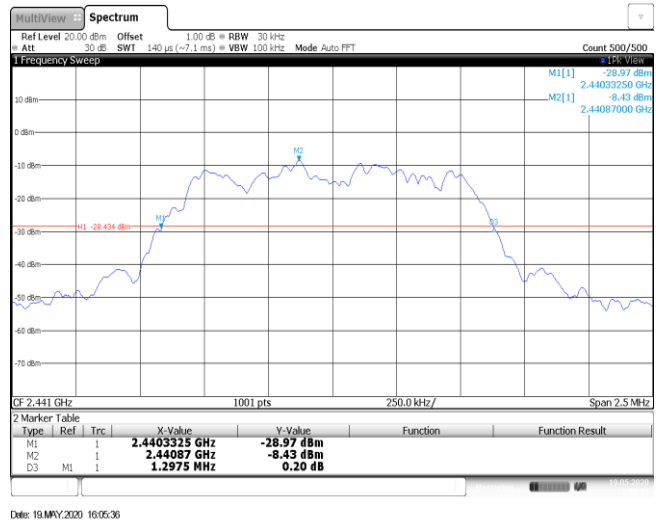

CH78

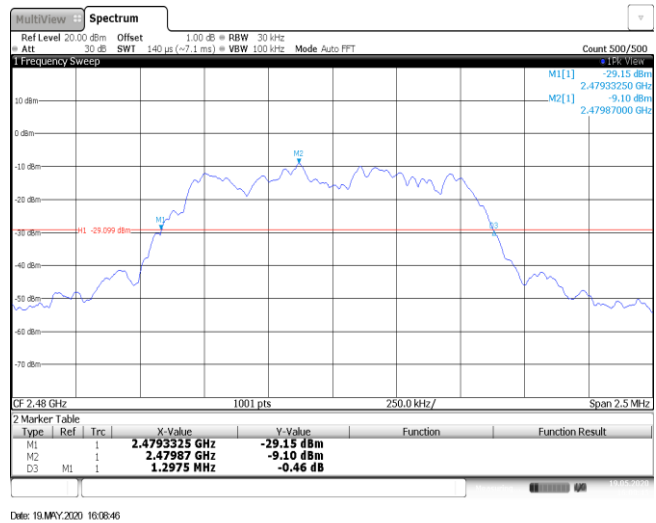

Appendix C: 99% Occupied Bandwidth

| Modulation type | Channel | 99% Occupied Bandwidth (MHz) | Limit (MHz) | Result |
|-----------------|---------|------------------------------|-------------|--------|
| GFSK | 00 | 0.93 | - | Pass |
| | 39 | 0.93 | | |
| | 78 | 0.93 | | |
| $\pi/4$ DQPSK | 00 | 1.19 | - | Pass |
| | 39 | 1.19 | | |
| | 78 | 1.19 | | |
| 8DPSK | 00 | 1.17 | - | Pass |
| | 39 | 1.17 | | |
| | 78 | 1.18 | | |

Modulation Type: GFSK

CH00



CH39

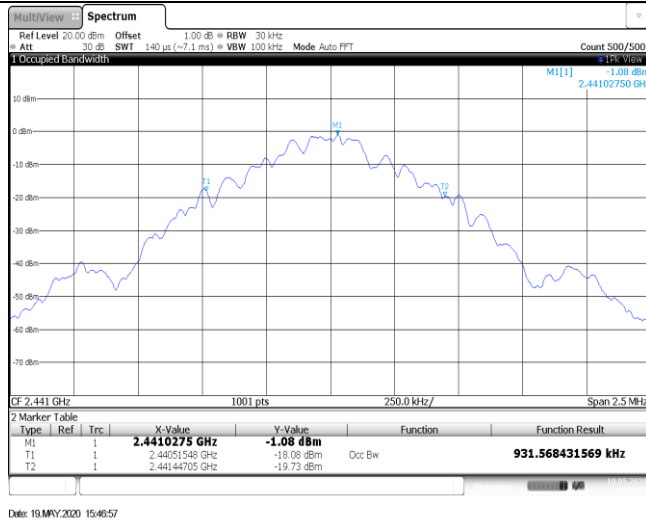

CH78



Modulation Type: $\pi/4$ DQPSK

CH00

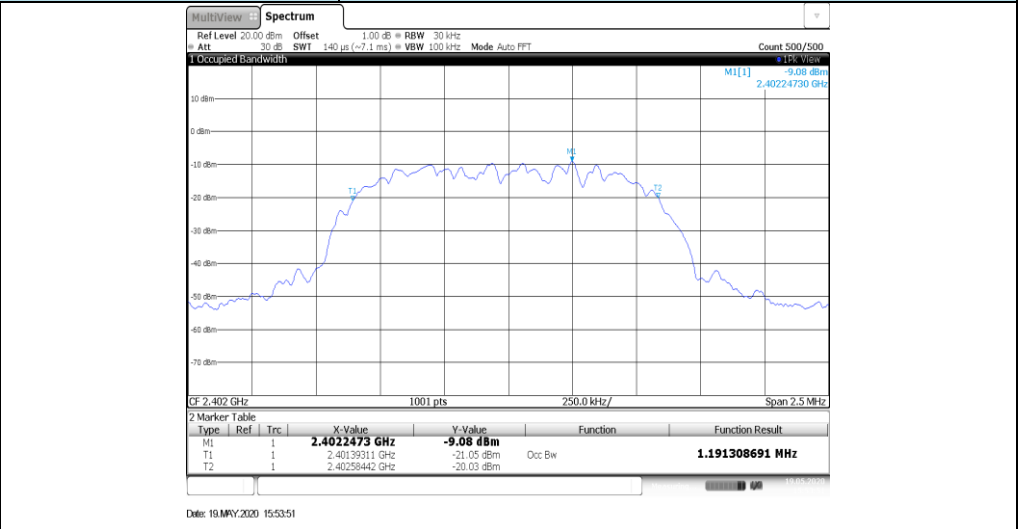

CH39

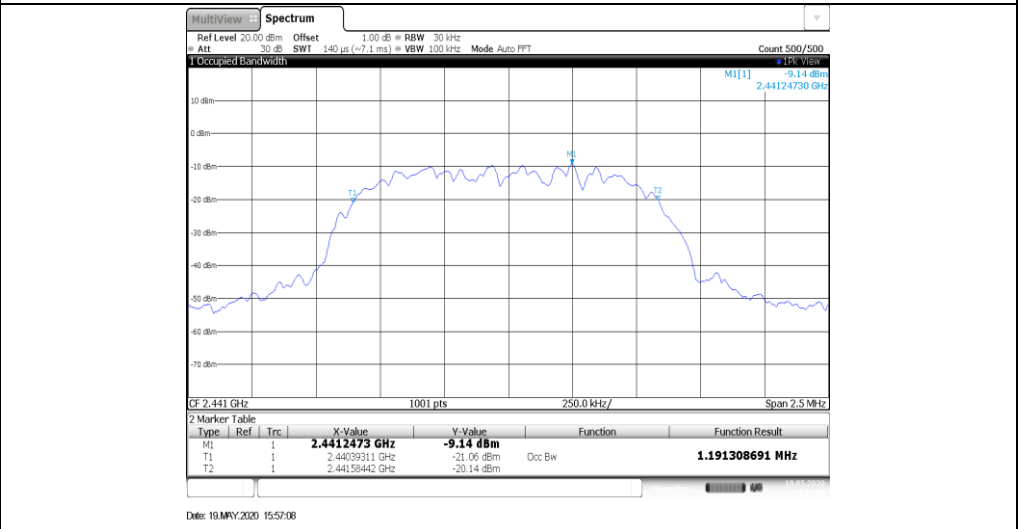

CH78

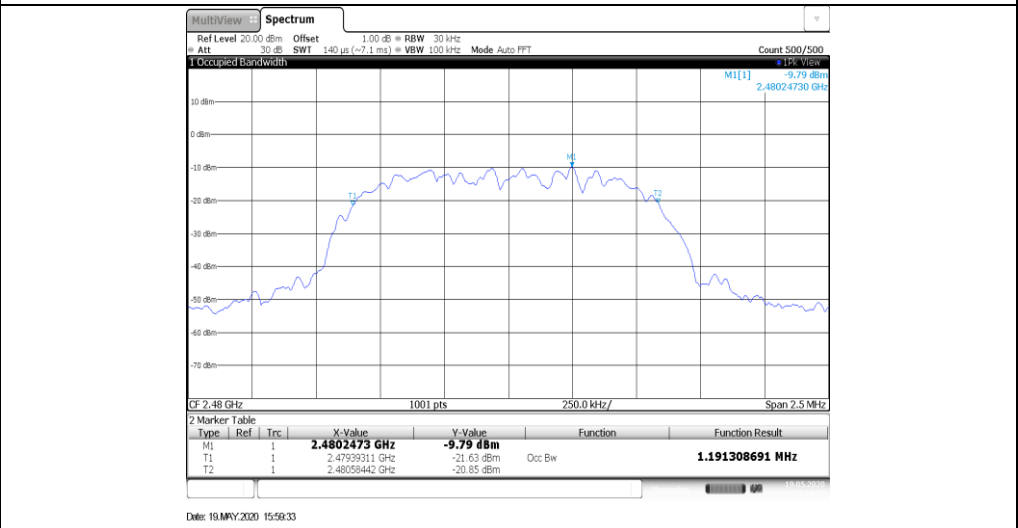

Modulation Type: 8DPSK

CH00



CH39

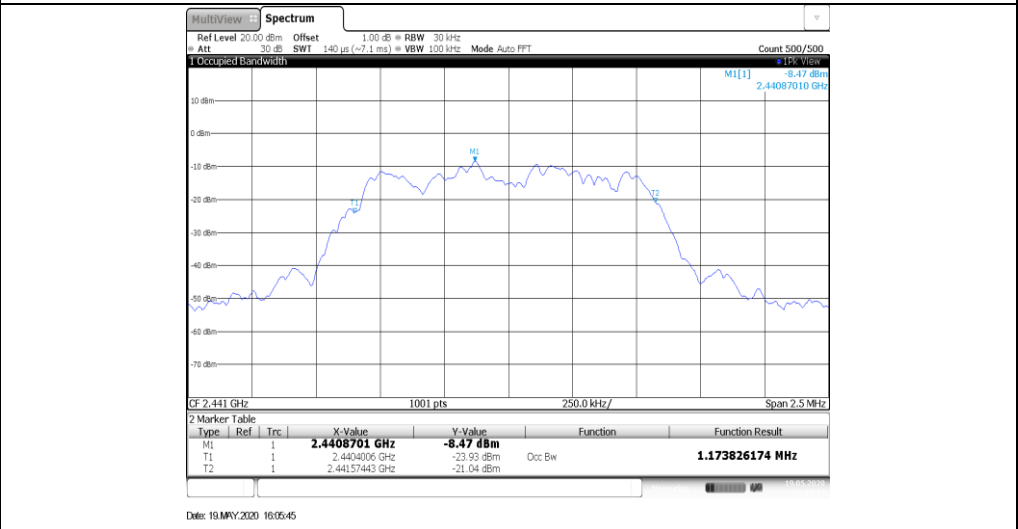

CH78

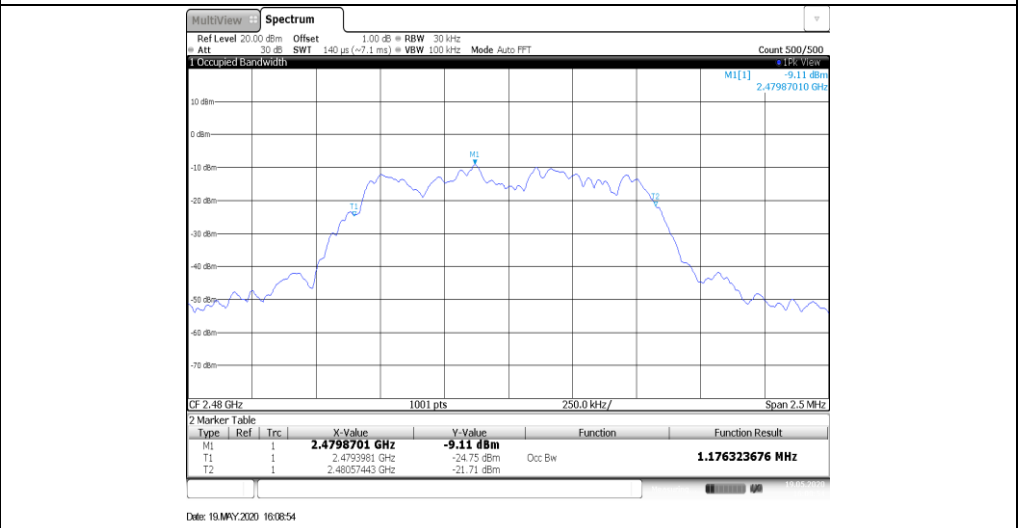

Appendix D: Carrier Frequencies Separation

| Modulation type | Channel | Carrier Frequencies Separation (MHz) | Limit (kHz) * | Result |
|-----------------|---------|--------------------------------------|---------------|--------|
| GFSK | 39 | 1.00 | ≥784.20 | Pass |
| $\pi/4$ DQPSK | 39 | 1.00 | ≥901.67 | Pass |
| 8DPSK | 39 | 1.00 | ≥865.00 | Pass |

Note:

*: GFSK limit = The maximum 20 dB Bandwidth for GFSK modulation on the appendix B.

$\pi/4$ DQPSK limit = $2/3$ * The maximum 20 dB Bandwidth for $\pi/4$ DQPSK modulation on the appendix B.

8DPSK limit = $2/3$ * The maximum 20 dB Bandwidth for 8DPSK modulation on the appendix B

| | |
|--|--|
| <p style="text-align: center;">GFSK</p> | |
| <p style="text-align: center;">$\pi/4$DQPSK</p> | |
| <p style="text-align: center;">8DPSK</p> | |

Appendix E: Hopping Channel Number

| Modulation type | Channel number | Limit | Result |
|-----------------|----------------|-------|--------|
| GFSK | 79 | ≥15 | Pass |
| π/4DQPSK | 79 | | |
| 8DPSK | 79 | | |

GFSK

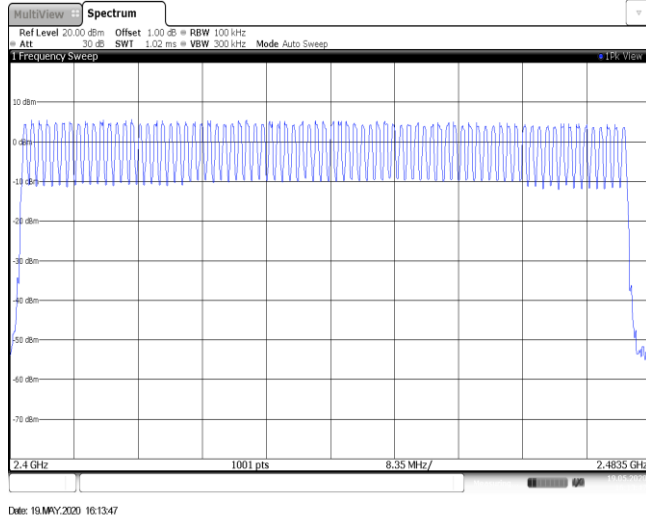

$\pi/4$ DQPSK

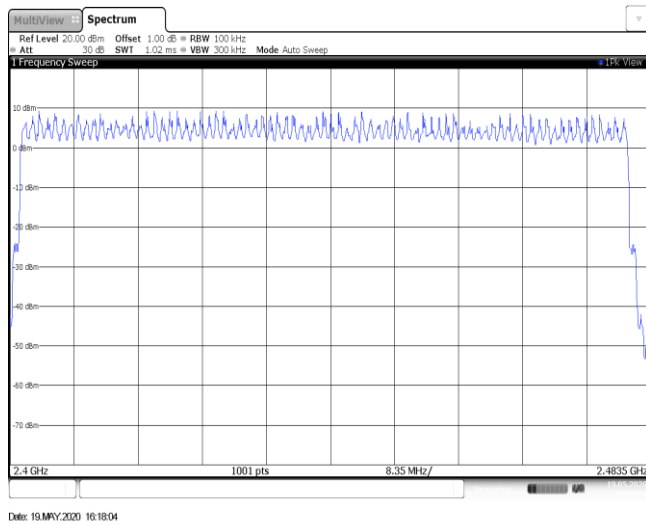

8DPSK

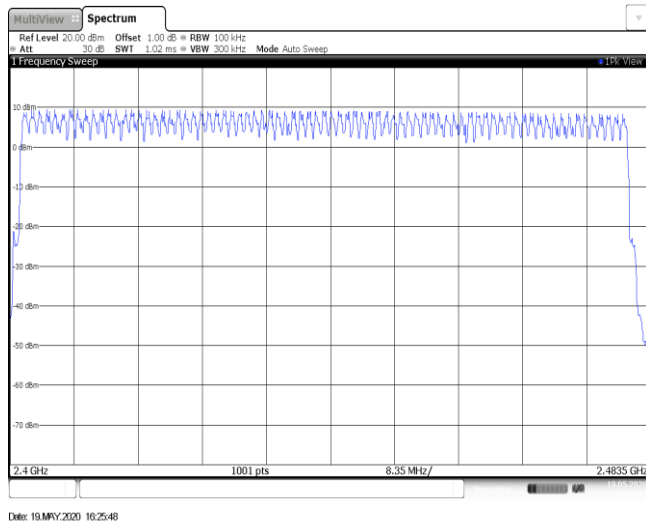

Appendix F: Dwell Time

| Modulation type | Packet | Burst Width [ms] | Total Hops[hop*ch] | Dwell time (Second) | Limit (Second) | Result |
|-----------------|--------|------------------|--------------------|---------------------|----------------|--------|
| GFSK | DH1 | 0.39 | 315 | 0.12 | ≤ 0.40 | Pass |
| | DH3 | 1.65 | 161 | 0.27 | | |
| | DH5 | 2.90 | 112 | 0.32 | | |
| π/4DQPSK | 2DH1 | 0.40 | 318 | 0.13 | ≤ 0.40 | Pass |
| | 2DH3 | 1.66 | 159 | 0.26 | | |
| | 2DH5 | 2.90 | 100 | 0.29 | | |
| 8DPSK | 3DH1 | 0.40 | 319 | 0.13 | ≤ 0.40 | Pass |
| | 3DH3 | 1.65 | 154 | 0.26 | | |
| | 3DH5 | 2.91 | 93 | 0.27 | | |

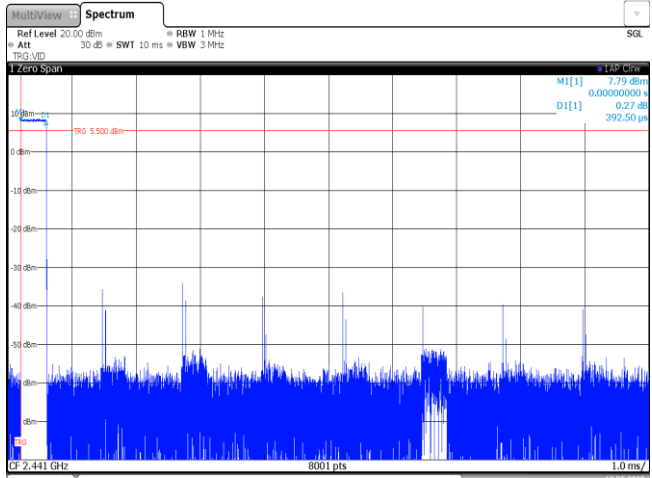
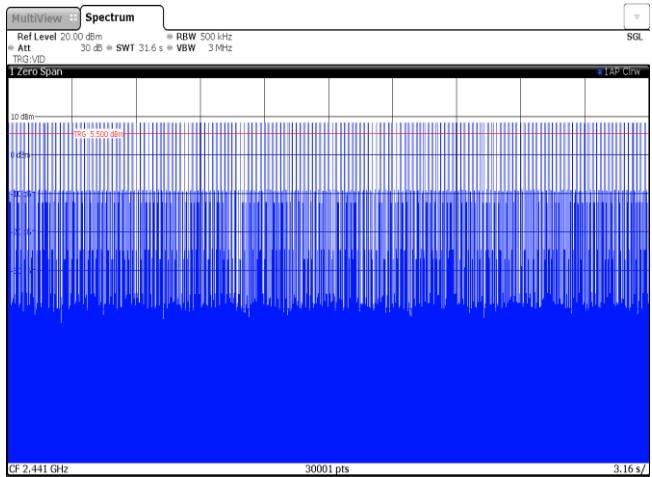
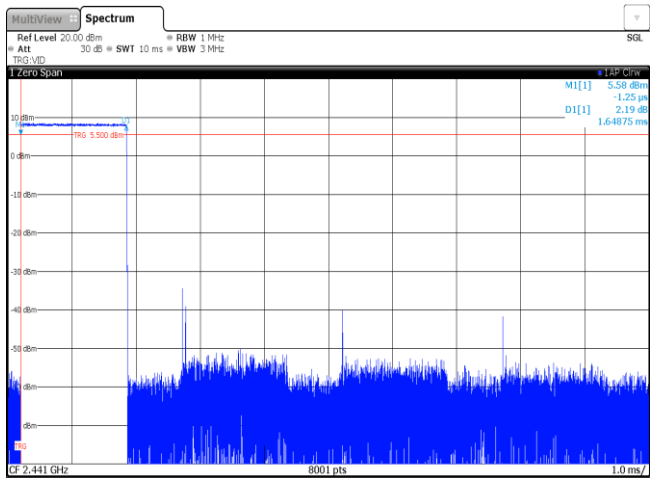
| Modulation Type: | GFSK |
|-----------------------------|---|
| <p>DH1 Burst width</p> |  <p>The plot shows a spectrum with a peak at 7.79 dBm and a noise floor at -50 dBm. The bandwidth is 392.50 MHz. The plot is titled 'Spectrum' and includes parameters: Ref Level 20.00 dBm, Att 30 dB, SWT 10 ms, RBW 1 MHz, VBW 3 MHz. The x-axis is centered at 2.441 GHz with 8001 points and a 1.0 ms scale. A red trigger line is set at 5.500 dBm. The date is 19.MAY.2020 16:28:12.</p> |
| <p>DH1 Burst number</p> |  <p>The plot shows a dense spectrum with a peak at 5.58 dBm and a noise floor at -50 dBm. The bandwidth is 1.64875 MHz. The plot is titled 'Spectrum' and includes parameters: Ref Level 20.00 dBm, Att 30 dB, SWT 31.6 s, RBW 500 kHz, VBW 3 MHz. The x-axis is centered at 2.441 GHz with 30001 points and a 3.16 s scale. A red trigger line is set at 5.500 dBm. The date is 19.MAY.2020 16:28:46.</p> |
| <p>DH3 Burst width</p> |  <p>The plot shows a spectrum with a peak at 5.58 dBm and a noise floor at -50 dBm. The bandwidth is 1.64875 MHz. The plot is titled 'Spectrum' and includes parameters: Ref Level 20.00 dBm, Att 30 dB, SWT 10 ms, RBW 1 MHz, VBW 3 MHz. The x-axis is centered at 2.441 GHz with 8001 points and a 1.0 ms scale. A red trigger line is set at 5.500 dBm. The date is 19.MAY.2020 16:29:42.</p> |

DH3
Burst number

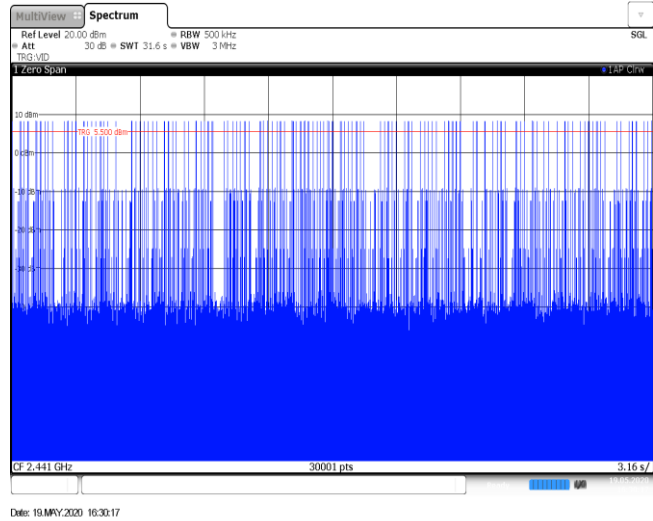

DH5
Burst width

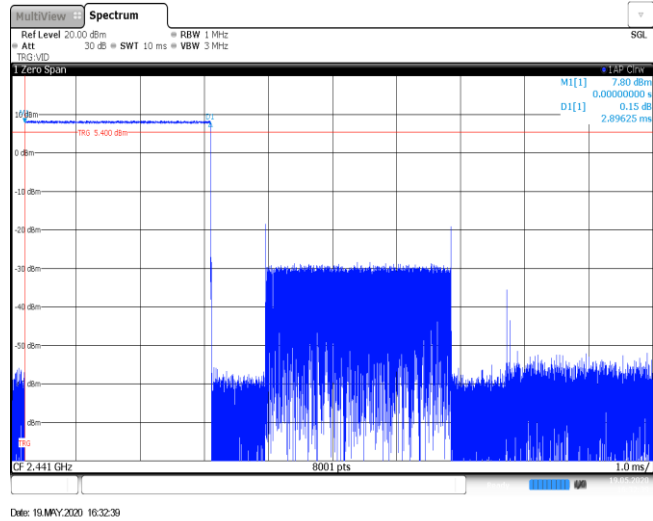

DH5
Burst number

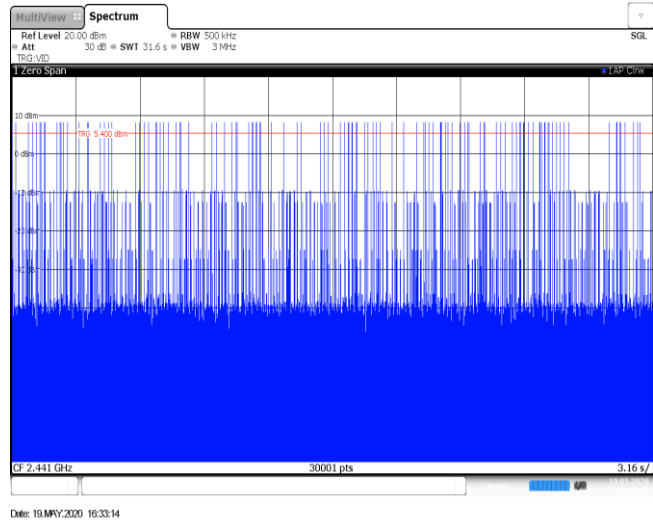

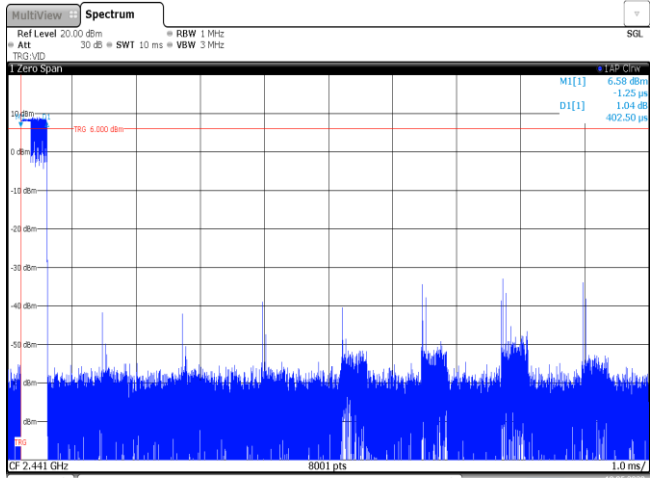
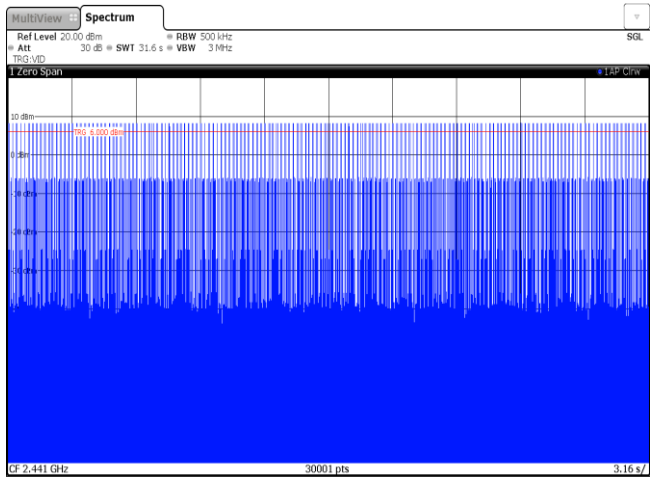
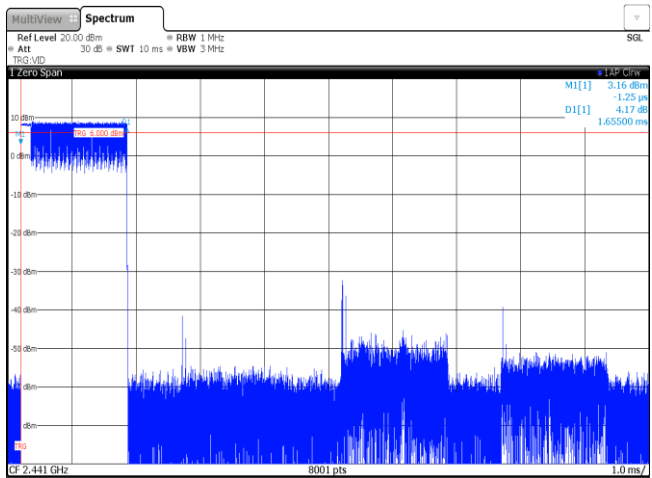
| Modulation Type: | $\pi/4$ DQPSK |
|------------------------------|--|
| <p>2DH1 Burst width</p> |  <p>The spectrum plot shows a signal burst at 2.441 GHz. The y-axis represents power in dBm, ranging from -60 to 10. The x-axis represents time in ms, ranging from 0 to 1.0. A red horizontal line indicates a threshold at 5.000 dBm. The signal peak is at approximately 6.59 dBm. The plot shows a burst of signal activity followed by a period of low power.</p> <p>Ref Level 20.00 dBm Att 30 dB RBW 1 MHz SWT 10 ms VBW 3 MHz</p> <p>M[1] 6.59 dBm D1[1] -1.25 μs 1.04 dB 402.50 μs</p> <p>CF 2.441 GHz 8001 pts 1.0 ms/</p> <p>Date: 19.MAY.2020 16:34:59</p> |
| <p>2DH1 Burst number</p> |  <p>The spectrum plot shows a signal burst at 2.441 GHz. The y-axis represents power in dBm, ranging from -60 to 10. The x-axis represents time in s, ranging from 0 to 3.16. A red horizontal line indicates a threshold at 5.000 dBm. The plot shows a dense burst of signal activity.</p> <p>Ref Level 20.00 dBm Att 30 dB RBW 500 kHz SWT 31.6 s VBW 3 MHz</p> <p>CF 2.441 GHz 30001 pts 3.16 s/</p> <p>Date: 19.MAY.2020 16:35:33</p> |
| <p>2DH3 Burst width</p> |  <p>The spectrum plot shows a signal burst at 2.441 GHz. The y-axis represents power in dBm, ranging from -60 to 10. The x-axis represents time in ms, ranging from 0 to 1.0. A red horizontal line indicates a threshold at 5.000 dBm. The signal peak is at approximately 3.16 dBm. The plot shows a burst of signal activity followed by a period of low power.</p> <p>Ref Level 20.00 dBm Att 30 dB RBW 1 MHz SWT 10 ms VBW 3 MHz</p> <p>M[1] 3.16 dBm D1[1] -1.25 μs 4.17 dB 1.65500 ms</p> <p>CF 2.441 GHz 8001 pts 1.0 ms/</p> <p>Date: 19.MAY.2020 16:36:04</p> |

2DH3
Burst number

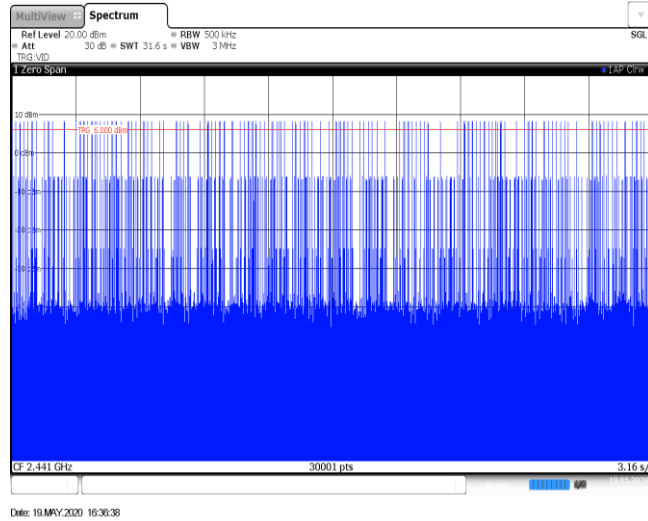

2DH5
Burst width

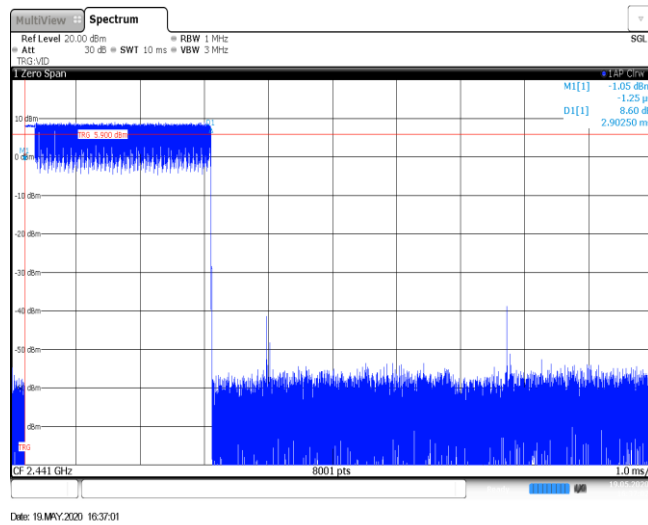

2DH5
Burst number

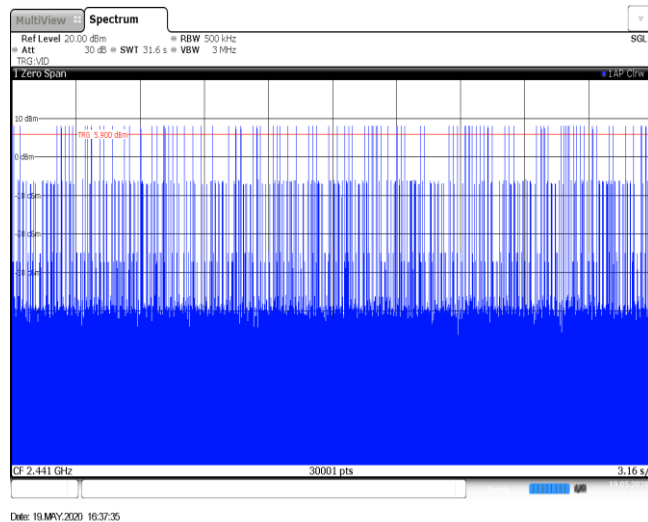

| Modulation Type: 8DPSK | |
|------------------------|--|
| 3DH1 Burst width | |
| 3DH1 Burst number | |
| 3DH3 Burst width | |

3DH3
Burst number

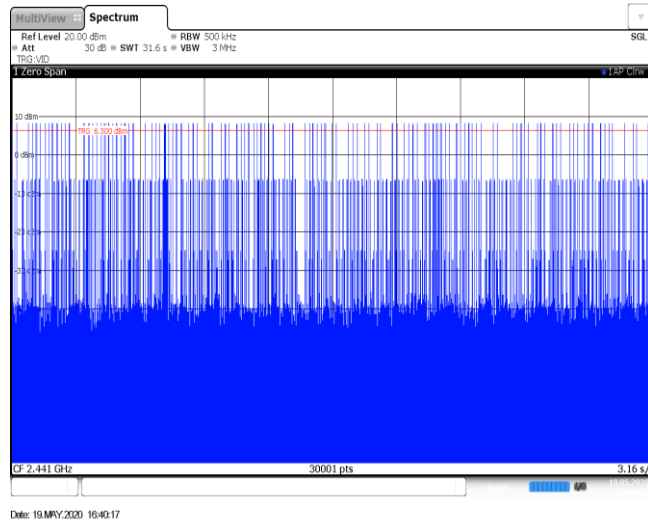

3DH5
Burst width

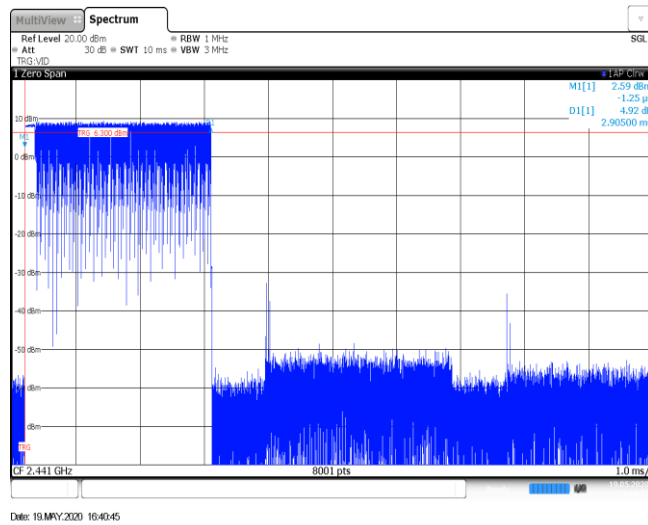

3DH5
Burst number

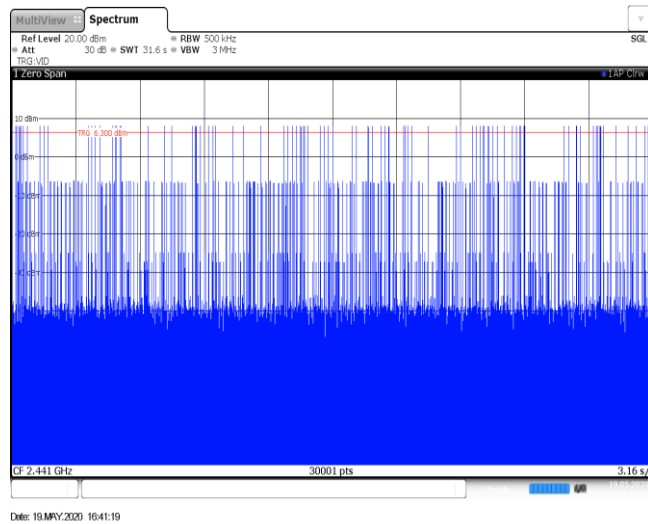

Appendix G: Duty Cycle Correction Factor (DCCF)

| DCCF Calculate Formula | | | | | |
|---|----------------------|--------------------------------------|-------------------|----------------|-----------|
| DCCF=20 * Log(duty cycle) = 20 * Log($T_{on\ time} / T_{period}$) | | | | | |
| Modulation type | Test Frequency (MHz) | $T_{on\ time}$ for single burst [ms] | T_{period} [ms] | Burst Quantity | DCCF [dB] |
| GFSK | 2441 | 1 | 100 | 3 | -30.46 |
| $\pi/4$ DQPSK | 2441 | 1 | 100 | 2 | -33.98 |
| 8DPSK | 2441 | 1 | 100 | 2 | -33.98 |

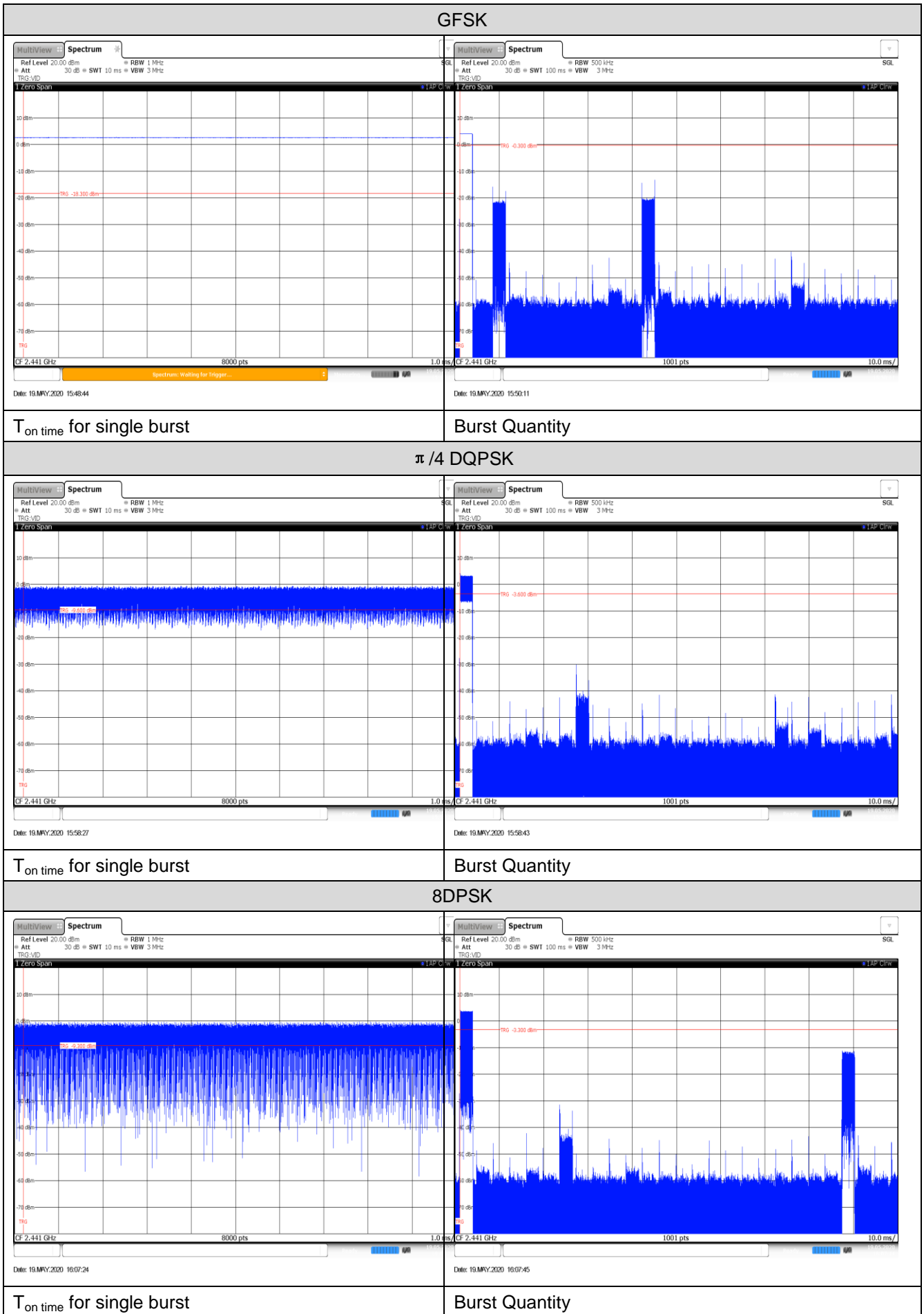

Appendix H: Band edge and Spurious Emissions (conducted)

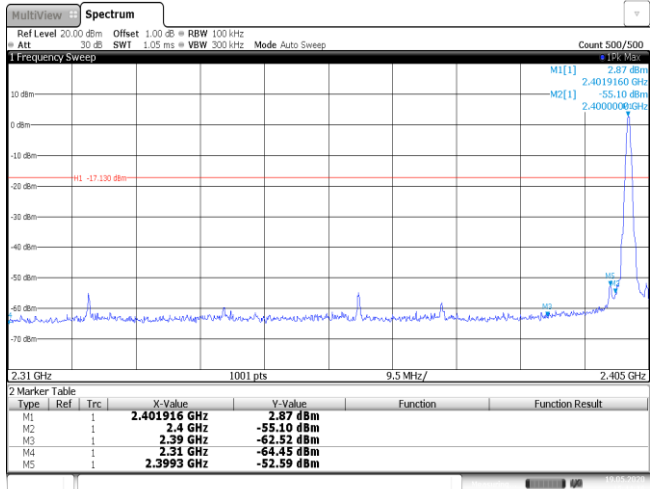
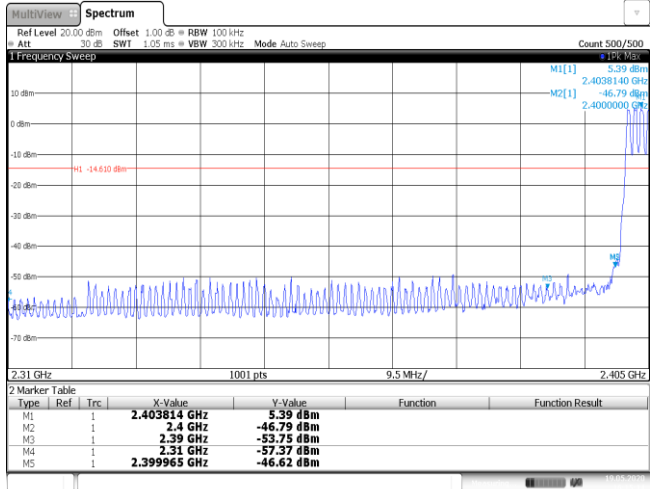
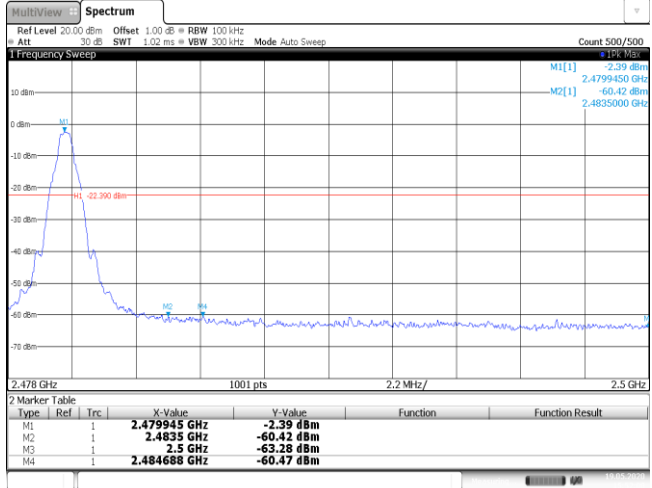
| Test Item: | Band edge | Modulation type: | GFSK | | | | | | | | | | | | | | | | | | | | | | | | | | | | | | | | | | | | | | | | | | |
|---------------------------------|--|------------------|--------------|------------|----------|-----------------|---------|---------|----------|-----------------|----|---|--|--------------|-----------|--|--|----|---|--|------------|------------|--|--|----|---|--|----------|------------|--|--|----|---|--|--------------|------------|--|--|----|---|--|--------------|------------|--|--|
| <p>CH00 No hopping mode</p> |  <p>2 Marker Table</p> <table border="1"> <thead> <tr> <th>Type</th> <th>Ref</th> <th>Trc</th> <th>X-Value</th> <th>Y-Value</th> <th>Function</th> <th>Function Result</th> </tr> </thead> <tbody> <tr> <td>M1</td> <td>1</td> <td></td> <td>2.401916 GHz</td> <td>2.87 dBm</td> <td></td> <td></td> </tr> <tr> <td>M2</td> <td>1</td> <td></td> <td>2.4 GHz</td> <td>-55.10 dBm</td> <td></td> <td></td> </tr> <tr> <td>M3</td> <td>1</td> <td></td> <td>2.39 GHz</td> <td>-62.52 dBm</td> <td></td> <td></td> </tr> <tr> <td>M4</td> <td>1</td> <td></td> <td>2.31 GHz</td> <td>-64.85 dBm</td> <td></td> <td></td> </tr> <tr> <td>M5</td> <td>1</td> <td></td> <td>2.3993 GHz</td> <td>-52.59 dBm</td> <td></td> <td></td> </tr> </tbody> </table> <p>Date: 19.MAY.2020 15:44:17</p> | | | Type | Ref | Trc | X-Value | Y-Value | Function | Function Result | M1 | 1 | | 2.401916 GHz | 2.87 dBm | | | M2 | 1 | | 2.4 GHz | -55.10 dBm | | | M3 | 1 | | 2.39 GHz | -62.52 dBm | | | M4 | 1 | | 2.31 GHz | -64.85 dBm | | | M5 | 1 | | 2.3993 GHz | -52.59 dBm | | |
| Type | Ref | Trc | X-Value | Y-Value | Function | Function Result | | | | | | | | | | | | | | | | | | | | | | | | | | | | | | | | | | | | | | | |
| M1 | 1 | | 2.401916 GHz | 2.87 dBm | | | | | | | | | | | | | | | | | | | | | | | | | | | | | | | | | | | | | | | | | |
| M2 | 1 | | 2.4 GHz | -55.10 dBm | | | | | | | | | | | | | | | | | | | | | | | | | | | | | | | | | | | | | | | | | |
| M3 | 1 | | 2.39 GHz | -62.52 dBm | | | | | | | | | | | | | | | | | | | | | | | | | | | | | | | | | | | | | | | | | |
| M4 | 1 | | 2.31 GHz | -64.85 dBm | | | | | | | | | | | | | | | | | | | | | | | | | | | | | | | | | | | | | | | | | |
| M5 | 1 | | 2.3993 GHz | -52.59 dBm | | | | | | | | | | | | | | | | | | | | | | | | | | | | | | | | | | | | | | | | | |
| <p>CH00 Hopping mode</p> |  <p>2 Marker Table</p> <table border="1"> <thead> <tr> <th>Type</th> <th>Ref</th> <th>Trc</th> <th>X-Value</th> <th>Y-Value</th> <th>Function</th> <th>Function Result</th> </tr> </thead> <tbody> <tr> <td>M1</td> <td>1</td> <td></td> <td>2.403814 GHz</td> <td>5.39 dBm</td> <td></td> <td></td> </tr> <tr> <td>M2</td> <td>1</td> <td></td> <td>2.4 GHz</td> <td>-46.79 dBm</td> <td></td> <td></td> </tr> <tr> <td>M3</td> <td>1</td> <td></td> <td>2.39 GHz</td> <td>-53.75 dBm</td> <td></td> <td></td> </tr> <tr> <td>M4</td> <td>1</td> <td></td> <td>2.31 GHz</td> <td>-57.37 dBm</td> <td></td> <td></td> </tr> <tr> <td>M5</td> <td>1</td> <td></td> <td>2.399965 GHz</td> <td>-46.62 dBm</td> <td></td> <td></td> </tr> </tbody> </table> <p>Date: 19.MAY.2020 16:15:14</p> | | | Type | Ref | Trc | X-Value | Y-Value | Function | Function Result | M1 | 1 | | 2.403814 GHz | 5.39 dBm | | | M2 | 1 | | 2.4 GHz | -46.79 dBm | | | M3 | 1 | | 2.39 GHz | -53.75 dBm | | | M4 | 1 | | 2.31 GHz | -57.37 dBm | | | M5 | 1 | | 2.399965 GHz | -46.62 dBm | | |
| Type | Ref | Trc | X-Value | Y-Value | Function | Function Result | | | | | | | | | | | | | | | | | | | | | | | | | | | | | | | | | | | | | | | |
| M1 | 1 | | 2.403814 GHz | 5.39 dBm | | | | | | | | | | | | | | | | | | | | | | | | | | | | | | | | | | | | | | | | | |
| M2 | 1 | | 2.4 GHz | -46.79 dBm | | | | | | | | | | | | | | | | | | | | | | | | | | | | | | | | | | | | | | | | | |
| M3 | 1 | | 2.39 GHz | -53.75 dBm | | | | | | | | | | | | | | | | | | | | | | | | | | | | | | | | | | | | | | | | | |
| M4 | 1 | | 2.31 GHz | -57.37 dBm | | | | | | | | | | | | | | | | | | | | | | | | | | | | | | | | | | | | | | | | | |
| M5 | 1 | | 2.399965 GHz | -46.62 dBm | | | | | | | | | | | | | | | | | | | | | | | | | | | | | | | | | | | | | | | | | |
| <p>CH78 No hopping mode</p> |  <p>2 Marker Table</p> <table border="1"> <thead> <tr> <th>Type</th> <th>Ref</th> <th>Trc</th> <th>X-Value</th> <th>Y-Value</th> <th>Function</th> <th>Function Result</th> </tr> </thead> <tbody> <tr> <td>M1</td> <td>1</td> <td></td> <td>2.479945 GHz</td> <td>-2.39 dBm</td> <td></td> <td></td> </tr> <tr> <td>M2</td> <td>1</td> <td></td> <td>2.4833 GHz</td> <td>-60.42 dBm</td> <td></td> <td></td> </tr> <tr> <td>M3</td> <td>1</td> <td></td> <td>2.5 GHz</td> <td>-63.28 dBm</td> <td></td> <td></td> </tr> <tr> <td>M4</td> <td>1</td> <td></td> <td>2.484688 GHz</td> <td>-60.47 dBm</td> <td></td> <td></td> </tr> </tbody> </table> <p>Date: 19.MAY.2020 15:52:07</p> | | | Type | Ref | Trc | X-Value | Y-Value | Function | Function Result | M1 | 1 | | 2.479945 GHz | -2.39 dBm | | | M2 | 1 | | 2.4833 GHz | -60.42 dBm | | | M3 | 1 | | 2.5 GHz | -63.28 dBm | | | M4 | 1 | | 2.484688 GHz | -60.47 dBm | | | | | | | | | |
| Type | Ref | Trc | X-Value | Y-Value | Function | Function Result | | | | | | | | | | | | | | | | | | | | | | | | | | | | | | | | | | | | | | | |
| M1 | 1 | | 2.479945 GHz | -2.39 dBm | | | | | | | | | | | | | | | | | | | | | | | | | | | | | | | | | | | | | | | | | |
| M2 | 1 | | 2.4833 GHz | -60.42 dBm | | | | | | | | | | | | | | | | | | | | | | | | | | | | | | | | | | | | | | | | | |
| M3 | 1 | | 2.5 GHz | -63.28 dBm | | | | | | | | | | | | | | | | | | | | | | | | | | | | | | | | | | | | | | | | | |
| M4 | 1 | | 2.484688 GHz | -60.47 dBm | | | | | | | | | | | | | | | | | | | | | | | | | | | | | | | | | | | | | | | | | |

CH78
Hopping mode

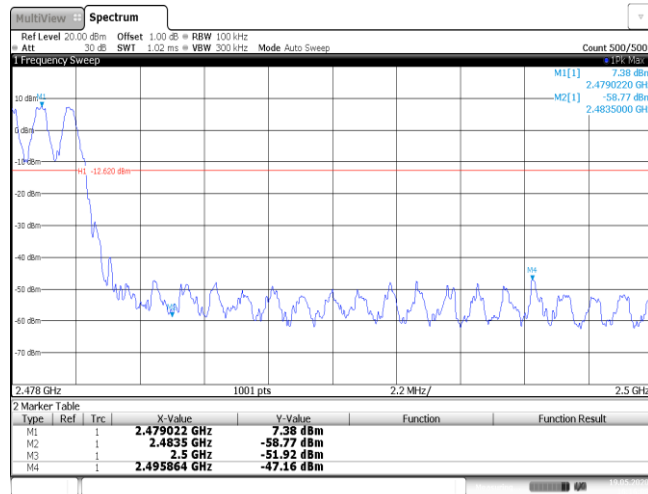

Date: 19.MAY.2020 16:16:08

| Test Item: | Band edge | Modulation type: | π/4DQPSK | | | | | | | | | | | | | | | | | | | | | | | | | | | | | | | | | | | | | | | | | | |
|---------------------------------|---|------------------|--------------|------------|----------|-----------------|---------|---------|----------|-----------------|----|---|--|--------------|-----------|--|--|----|---|--|------------|------------|--|--|----|---|--|----------|------------|--|--|----|---|--|--------------|------------|--|--|----|---|--|--------------|------------|--|--|
| <p>CH00 No hopping mode</p> | <table border="1"> <thead> <tr> <th>Type</th> <th>Ref</th> <th>Trc</th> <th>X-Value</th> <th>Y-Value</th> <th>Function</th> <th>Function Result</th> </tr> </thead> <tbody> <tr> <td>M1</td> <td>1</td> <td></td> <td>2.401631 GHz</td> <td>-3.92 dBm</td> <td></td> <td></td> </tr> <tr> <td>M2</td> <td>1</td> <td></td> <td>2.4 GHz</td> <td>-56.15 dBm</td> <td></td> <td></td> </tr> <tr> <td>M3</td> <td>1</td> <td></td> <td>2.39 GHz</td> <td>-60.62 dBm</td> <td></td> <td></td> </tr> <tr> <td>M4</td> <td>1</td> <td></td> <td>2.31 GHz</td> <td>-63.54 dBm</td> <td></td> <td></td> </tr> <tr> <td>M5</td> <td>1</td> <td></td> <td>2.399775 GHz</td> <td>-56.28 dBm</td> <td></td> <td></td> </tr> </tbody> </table> <p>Date: 19.MAY.2020 15:54:15</p> | | | Type | Ref | Trc | X-Value | Y-Value | Function | Function Result | M1 | 1 | | 2.401631 GHz | -3.92 dBm | | | M2 | 1 | | 2.4 GHz | -56.15 dBm | | | M3 | 1 | | 2.39 GHz | -60.62 dBm | | | M4 | 1 | | 2.31 GHz | -63.54 dBm | | | M5 | 1 | | 2.399775 GHz | -56.28 dBm | | |
| Type | Ref | Trc | X-Value | Y-Value | Function | Function Result | | | | | | | | | | | | | | | | | | | | | | | | | | | | | | | | | | | | | | | |
| M1 | 1 | | 2.401631 GHz | -3.92 dBm | | | | | | | | | | | | | | | | | | | | | | | | | | | | | | | | | | | | | | | | | |
| M2 | 1 | | 2.4 GHz | -56.15 dBm | | | | | | | | | | | | | | | | | | | | | | | | | | | | | | | | | | | | | | | | | |
| M3 | 1 | | 2.39 GHz | -60.62 dBm | | | | | | | | | | | | | | | | | | | | | | | | | | | | | | | | | | | | | | | | | |
| M4 | 1 | | 2.31 GHz | -63.54 dBm | | | | | | | | | | | | | | | | | | | | | | | | | | | | | | | | | | | | | | | | | |
| M5 | 1 | | 2.399775 GHz | -56.28 dBm | | | | | | | | | | | | | | | | | | | | | | | | | | | | | | | | | | | | | | | | | |
| <p>CH00 Hopping mode</p> | <table border="1"> <thead> <tr> <th>Type</th> <th>Ref</th> <th>Trc</th> <th>X-Value</th> <th>Y-Value</th> <th>Function</th> <th>Function Result</th> </tr> </thead> <tbody> <tr> <td>M1</td> <td>1</td> <td></td> <td>2.404763 GHz</td> <td>9.35 dBm</td> <td></td> <td></td> </tr> <tr> <td>M2</td> <td>1</td> <td></td> <td>2.4 GHz</td> <td>-40.59 dBm</td> <td></td> <td></td> </tr> <tr> <td>M3</td> <td>1</td> <td></td> <td>2.39 GHz</td> <td>-54.57 dBm</td> <td></td> <td></td> </tr> <tr> <td>M4</td> <td>1</td> <td></td> <td>2.31 GHz</td> <td>-58.06 dBm</td> <td></td> <td></td> </tr> <tr> <td>M5</td> <td>1</td> <td></td> <td>2.399965 GHz</td> <td>-40.30 dBm</td> <td></td> <td></td> </tr> </tbody> </table> <p>Date: 19.MAY.2020 16:19:10</p> | | | Type | Ref | Trc | X-Value | Y-Value | Function | Function Result | M1 | 1 | | 2.404763 GHz | 9.35 dBm | | | M2 | 1 | | 2.4 GHz | -40.59 dBm | | | M3 | 1 | | 2.39 GHz | -54.57 dBm | | | M4 | 1 | | 2.31 GHz | -58.06 dBm | | | M5 | 1 | | 2.399965 GHz | -40.30 dBm | | |
| Type | Ref | Trc | X-Value | Y-Value | Function | Function Result | | | | | | | | | | | | | | | | | | | | | | | | | | | | | | | | | | | | | | | |
| M1 | 1 | | 2.404763 GHz | 9.35 dBm | | | | | | | | | | | | | | | | | | | | | | | | | | | | | | | | | | | | | | | | | |
| M2 | 1 | | 2.4 GHz | -40.59 dBm | | | | | | | | | | | | | | | | | | | | | | | | | | | | | | | | | | | | | | | | | |
| M3 | 1 | | 2.39 GHz | -54.57 dBm | | | | | | | | | | | | | | | | | | | | | | | | | | | | | | | | | | | | | | | | | |
| M4 | 1 | | 2.31 GHz | -58.06 dBm | | | | | | | | | | | | | | | | | | | | | | | | | | | | | | | | | | | | | | | | | |
| M5 | 1 | | 2.399965 GHz | -40.30 dBm | | | | | | | | | | | | | | | | | | | | | | | | | | | | | | | | | | | | | | | | | |
| <p>CH78 No hopping mode</p> | <table border="1"> <thead> <tr> <th>Type</th> <th>Ref</th> <th>Trc</th> <th>X-Value</th> <th>Y-Value</th> <th>Function</th> <th>Function Result</th> </tr> </thead> <tbody> <tr> <td>M1</td> <td>1</td> <td></td> <td>2.479681 GHz</td> <td>-4.69 dBm</td> <td></td> <td></td> </tr> <tr> <td>M2</td> <td>1</td> <td></td> <td>2.4835 GHz</td> <td>-62.17 dBm</td> <td></td> <td></td> </tr> <tr> <td>M3</td> <td>1</td> <td></td> <td>2.5 GHz</td> <td>-63.27 dBm</td> <td></td> <td></td> </tr> <tr> <td>M4</td> <td>1</td> <td></td> <td>2.483742 GHz</td> <td>-61.20 dBm</td> <td></td> <td></td> </tr> </tbody> </table> <p>Date: 19.MAY.2020 16:00:30</p> | | | Type | Ref | Trc | X-Value | Y-Value | Function | Function Result | M1 | 1 | | 2.479681 GHz | -4.69 dBm | | | M2 | 1 | | 2.4835 GHz | -62.17 dBm | | | M3 | 1 | | 2.5 GHz | -63.27 dBm | | | M4 | 1 | | 2.483742 GHz | -61.20 dBm | | | | | | | | | |
| Type | Ref | Trc | X-Value | Y-Value | Function | Function Result | | | | | | | | | | | | | | | | | | | | | | | | | | | | | | | | | | | | | | | |
| M1 | 1 | | 2.479681 GHz | -4.69 dBm | | | | | | | | | | | | | | | | | | | | | | | | | | | | | | | | | | | | | | | | | |
| M2 | 1 | | 2.4835 GHz | -62.17 dBm | | | | | | | | | | | | | | | | | | | | | | | | | | | | | | | | | | | | | | | | | |
| M3 | 1 | | 2.5 GHz | -63.27 dBm | | | | | | | | | | | | | | | | | | | | | | | | | | | | | | | | | | | | | | | | | |
| M4 | 1 | | 2.483742 GHz | -61.20 dBm | | | | | | | | | | | | | | | | | | | | | | | | | | | | | | | | | | | | | | | | | |

CH78
Hopping mode

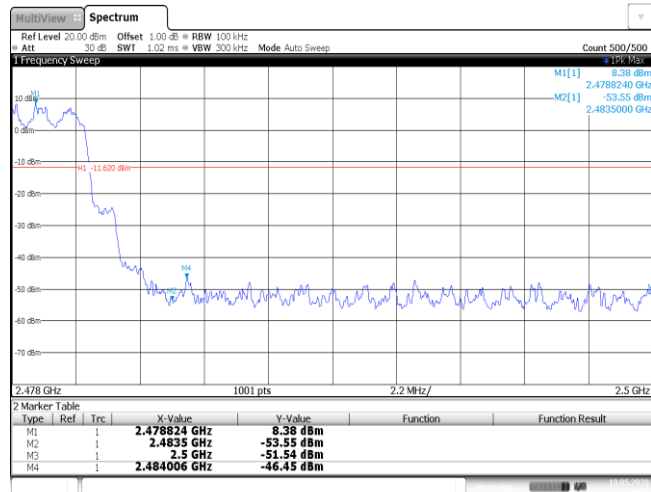

Date: 19.MAY.2020 16:20:26

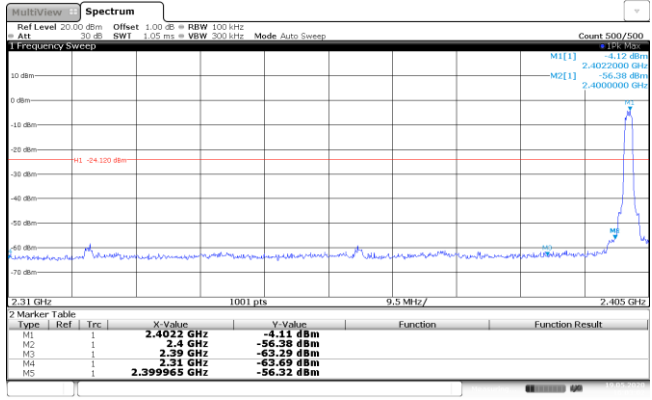
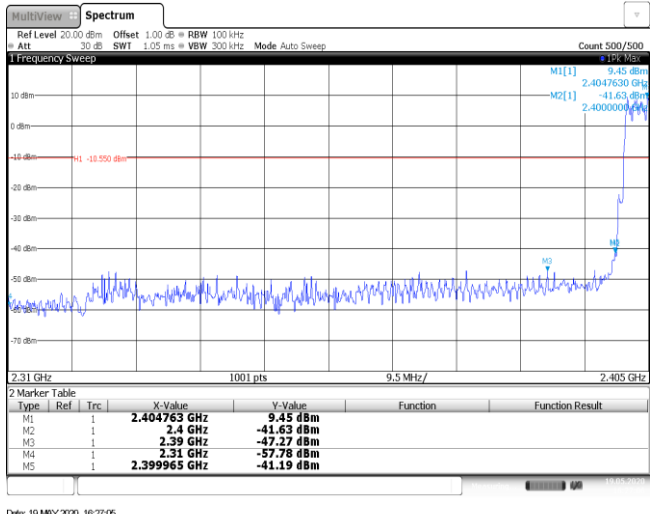
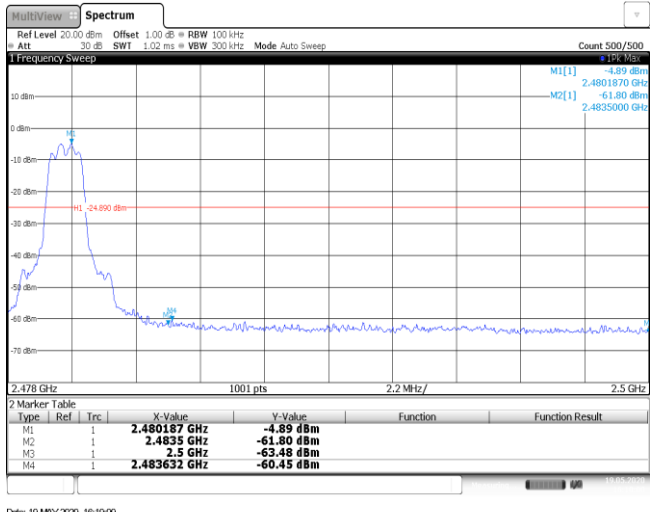
| Test Item: | Band edge | Modulation type: | 8DPSK |
|---------------------------------|--|------------------|-------|
| <p>CH00 No hopping mode</p> |  <p>MultiView Spectrum Ref Level 20.00 dBm Offset 1.00 dB RBW 100 kHz Att 30 dB SWI 1.05 ms VBW 300 kHz Mode Auto Sweep Count 500/500 1 Frequency Sweep 10 dBm 0 dBm -10 dBm -20 dBm -30 dBm -40 dBm -50 dBm -60 dBm -70 dBm 2.31 GHz 1001 pts 9.5 MHz/ 2.405 GHz 2 Marker Table Type Ref Trc X-Value Y-Value Function Function Result M1 1 2.4022 GHz -4.11 dBm M2 1 2.4 GHz -56.38 dBm M3 1 2.39 GHz -63.29 dBm M4 1 2.31 GHz -63.69 dBm M5 1 2.399965 GHz -56.32 dBm Date: 19.MAY.2020 16:03:02</p> | | |
| <p>CH00 Hopping mode</p> |  <p>MultiView Spectrum Ref Level 20.00 dBm Offset 1.00 dB RBW 100 kHz Att 30 dB SWI 1.05 ms VBW 300 kHz Mode Auto Sweep Count 500/500 1 Frequency Sweep 10 dBm 0 dBm -10 dBm -20 dBm -30 dBm -40 dBm -50 dBm -60 dBm -70 dBm 2.31 GHz 1001 pts 9.5 MHz/ 2.405 GHz 2 Marker Table Type Ref Trc X-Value Y-Value Function Function Result M1 1 2.404763 GHz 9.45 dBm M2 1 2.4 GHz -41.63 dBm M3 1 2.39 GHz -47.27 dBm M4 1 2.31 GHz -57.78 dBm M5 1 2.399965 GHz -41.19 dBm Date: 19.MAY.2020 16:27:05</p> | | |
| <p>CH78 No hopping mode</p> |  <p>MultiView Spectrum Ref Level 20.00 dBm Offset 1.00 dB RBW 100 kHz Att 30 dB SWI 1.02 ms VBW 300 kHz Mode Auto Sweep Count 500/500 1 Frequency Sweep 10 dBm 0 dBm -10 dBm -20 dBm -30 dBm -40 dBm -50 dBm -60 dBm -70 dBm 2.478 GHz 1001 pts 2.2 MHz/ 2.5 GHz 2 Marker Table Type Ref Trc X-Value Y-Value Function Function Result M1 1 2.480187 GHz -4.89 dBm M2 1 2.4835 GHz -61.80 dBm M3 1 2.5 GHz -63.48 dBm M4 1 2.483632 GHz -60.45 dBm Date: 19.MAY.2020 16:10:00</p> | | |

CH78
Hoppig mode

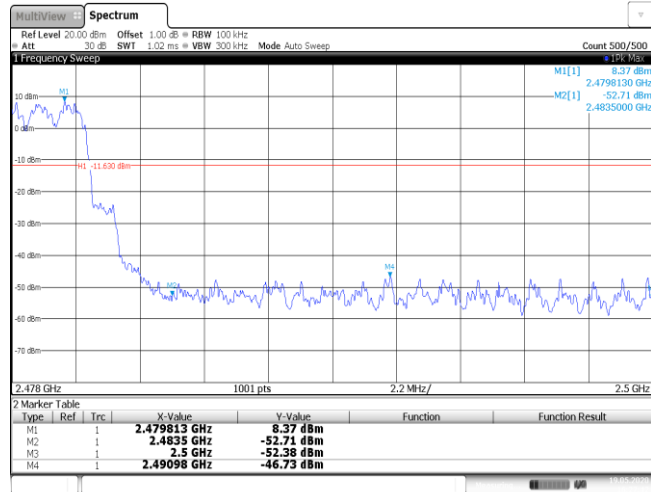

| Test Item: | Spurious Emission | Modulation type: | GFSK |
|---------------------------------|--|------------------|------|
| <p>CH00 Reference level</p> | <p>MultiView Spectrum Ref Level 30.00 dBm Offset 1.00 dB RBW 100 kHz Att 30 dB SWI 1.04 ms VBW 300 kHz Mode Auto Sweep Count 100/100 Frequency Sweep M1[1] 9.00 dBm 2.4019400 GHz CF 2.402 GHz 1001 pts 3.0 MHz/ Span 30.0 MHz Date: 19.MAY.2020 15:44:24</p> | | |
| <p>CH00 30MHz~1000MHz</p> | <p>MultiView Spectrum Ref Level 20.00 dBm Offset 1.00 dB RBW 100 kHz Att 30 dB SWI 30.1 ms VBW 300 kHz Mode Auto Sweep Count 10/10 Frequency Sweep M1[1] -61.14 dBm 541.5120 MHz H1 -17.000 dBm 30.0 MHz 30001 pts 97.0 MHz/ 1.0 GHz Date: 19.MAY.2020 15:44:40</p> | | |
| <p>CH00 1GHz~26GHz</p> | <p>MultiView Spectrum Ref Level 20.00 dBm Offset 1.00 dB RBW 100 kHz Att 36 dB SWI 250 ms VBW 300 kHz Mode Auto Sweep Count 10/10 Frequency Sweep M1[1] -45.82 dBm 25.960000 GHz H1 -17.000 dBm 1.0 GHz 30001 pts 2.5 GHz/ 26.0 GHz Date: 19.MAY.2020 15:44:56</p> | | |

| | |
|---------------------------------|--|
| <p>CH39 Reference level</p> | <p>Ref Level 30.00 dBm Offset 1.00 dB RBW 100 kHz Att 30 dB SWF 1.04 ms VBW 300 kHz Mode Auto Sweep Count 100/100 M1[1] 2.76 dBm 2.4409400 GHz CF 2.441 GHz 1001 pts 3.0 MHz/ Span 30.0 MHz Date: 19.MAY.2020 15:47:13</p> |
| <p>CH39 30MHz~1000MHz</p> | <p>Ref Level 20.00 dBm Offset 1.00 dB RBW 100 kHz Att 30 dB SWF 30.1 ms VBW 300 kHz Mode Auto Sweep Count 10/10 M1[1] -60.60 dBm 545.4250 MHz 30.0 MHz 30001 pts 97.0 MHz/ 1.0 GHz Date: 19.MAY.2020 15:47:29</p> |
| <p>CH39 1GHz~26GHz</p> | <p>Ref Level 26.00 dBm Offset 1.00 dB RBW 100 kHz Att 36 dB SWF 250 ms VBW 300 kHz Mode Auto Sweep Count 10/10 M1[1] -46.90 dBm 25.879167 GHz 1.0 GHz 30001 pts 2.5 GHz/ 26.0 GHz Date: 19.MAY.2020 15:47:45</p> |

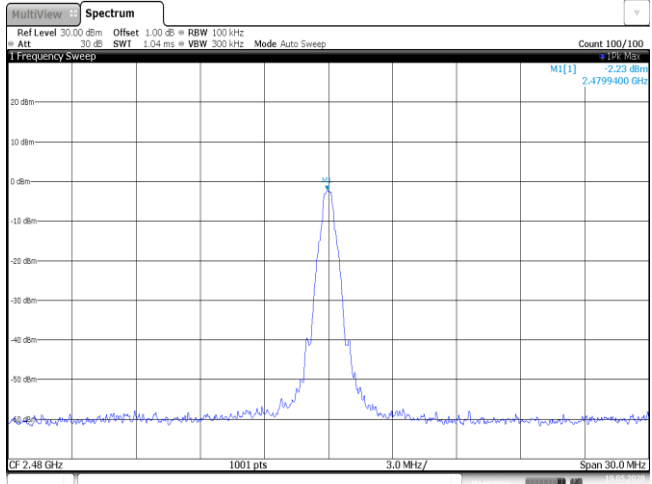
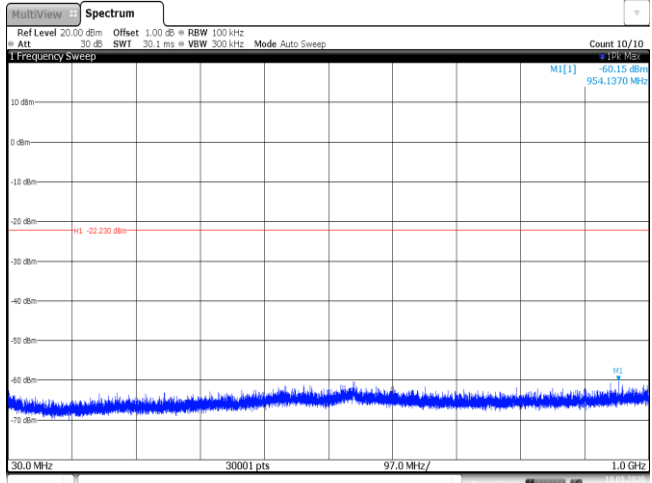
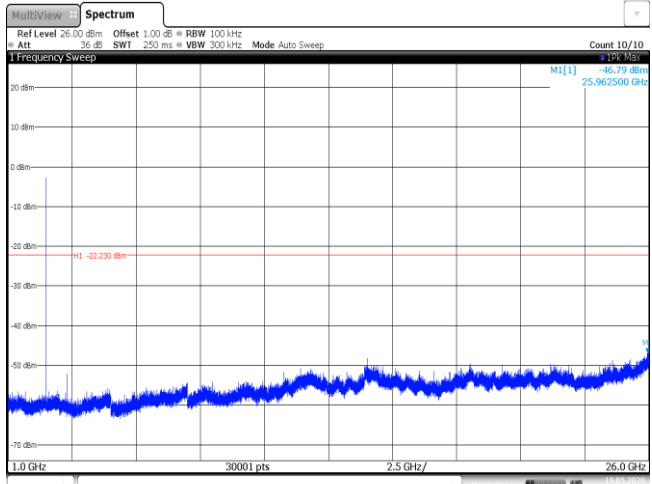
| | |
|---------------------------------|--|
| <p>CH78 Reference level</p> |  <p>MultiView Spectrum Ref Level 30.00 dBm Offset 1.00 dB RBW 100 kHz Att 30 dB SWF 1.04 ms VBW 300 kHz Mode Auto Sweep Count 100/100 1 Frequency Sweep MI[1] -2.23 dBm 2.4799400 GHz CF 2.48 GHz 1001 pts 3.0 MHz/ Span 30.0 MHz Date: 19.MAY.2020 15:52:14</p> |
| <p>CH78 30MHz~1000MHz</p> |  <p>MultiView Spectrum Ref Level 20.00 dBm Offset 1.00 dB RBW 100 kHz Att 30 dB SWF 30.1 ms VBW 300 kHz Mode Auto Sweep Count 10/10 1 Frequency Sweep MI[1] -60.15 dBm 954.1370 MHz MI -22.230 dBm 30.0 MHz 30001 pts 97.0 MHz/ 1.0 GHz Date: 19.MAY.2020 15:52:31</p> |
| <p>CH78 1GHz~26GHz</p> |  <p>MultiView Spectrum Ref Level 26.00 dBm Offset 1.00 dB RBW 100 kHz Att 36 dB SWF 250 ms VBW 300 kHz Mode Auto Sweep Count 10/10 1 Frequency Sweep MI[1] -46.79 dBm 25.962500 GHz MI -22.230 dBm 1.0 GHz 30001 pts 2.5 GHz/ 26.0 GHz Date: 19.MAY.2020 15:52:47</p> |

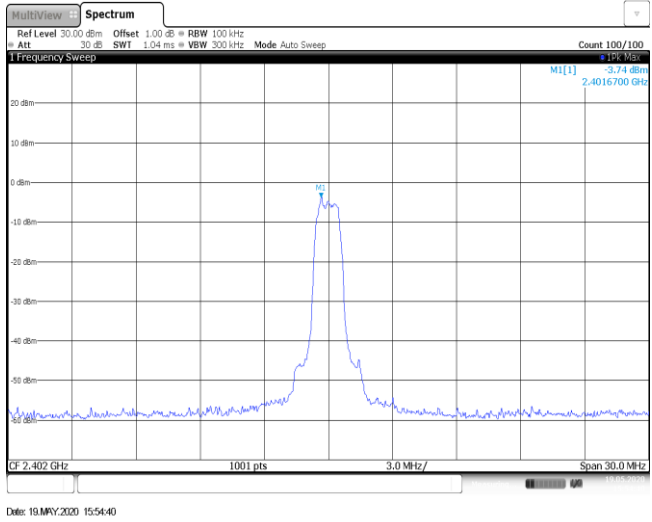
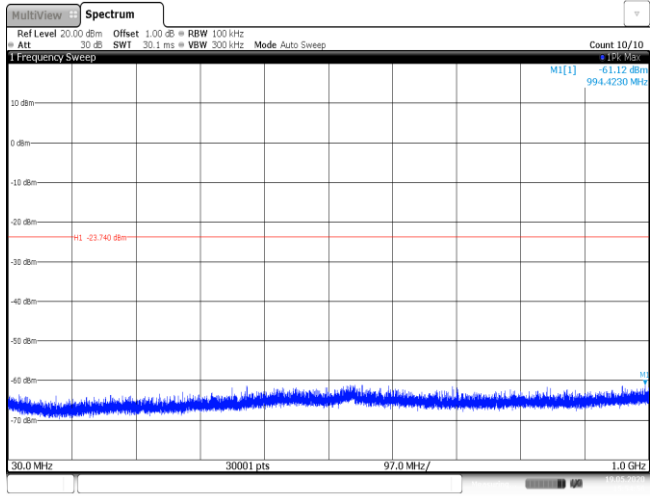
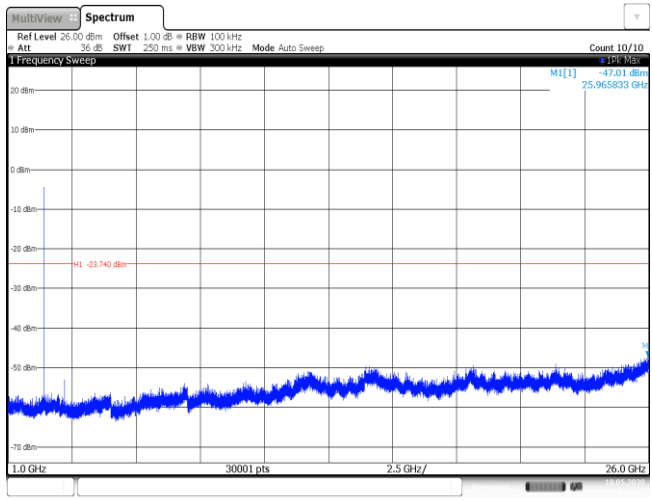
| Test Item: | Spurious Emission | Modulation type: | $\pi/4$ DQPSK |
|---------------------------------|--|------------------|---------------|
| <p>CH00 Reference level</p> |  | | |
| <p>CH00 30MHz~1000MHz</p> |  | | |
| <p>CH00 1GHz~26GHz</p> |  | | |

CH39
Reference level

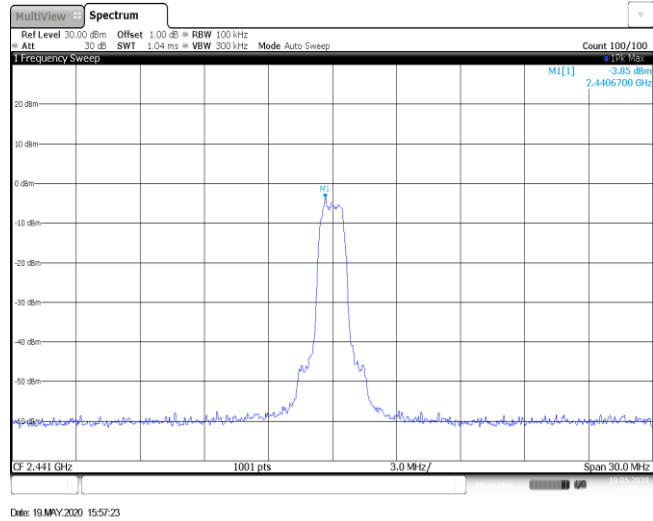

CH39
30MHz~1000MHz

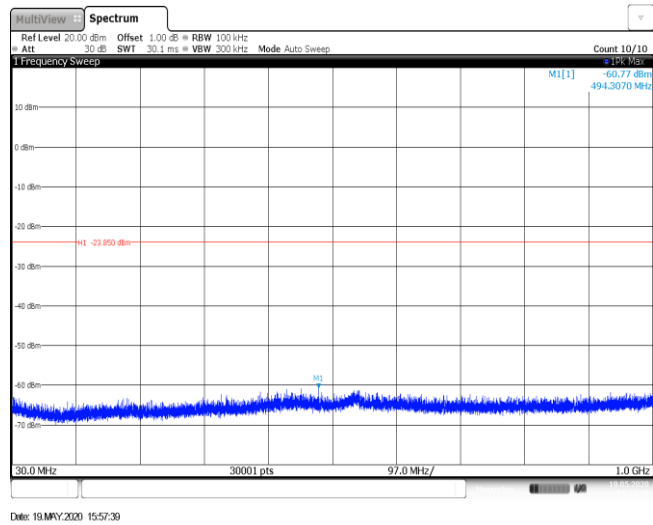

CH39
1GHz~26GHz

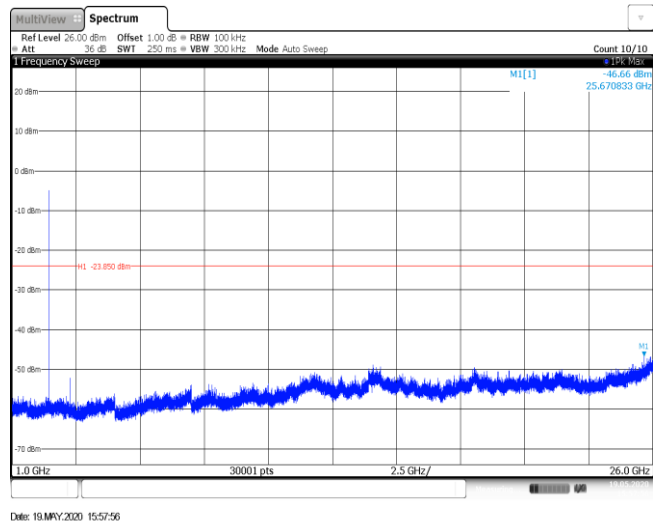

| | |
|---------------------------------|-----------------------------------|
| <p>CH78 Reference level</p> | <p>Date: 19.MAY.2020 16:00:42</p> |
| <p>CH78 30MHz~1000MHz</p> | <p>Date: 19.MAY.2020 16:00:58</p> |
| <p>CH78 1GHz~26GHz</p> | <p>Date: 19.MAY.2020 16:01:14</p> |

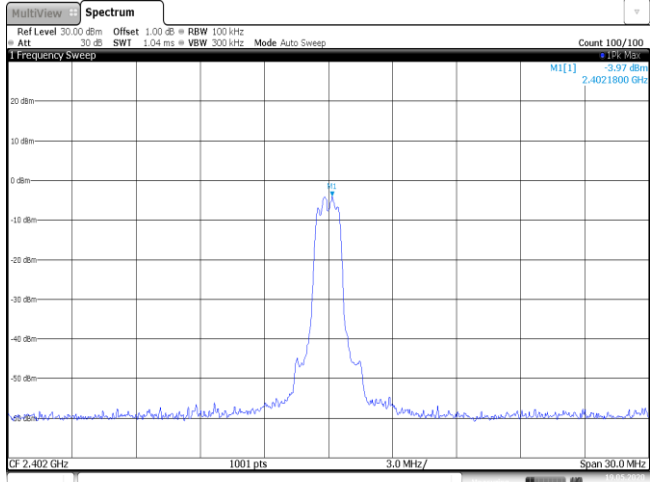
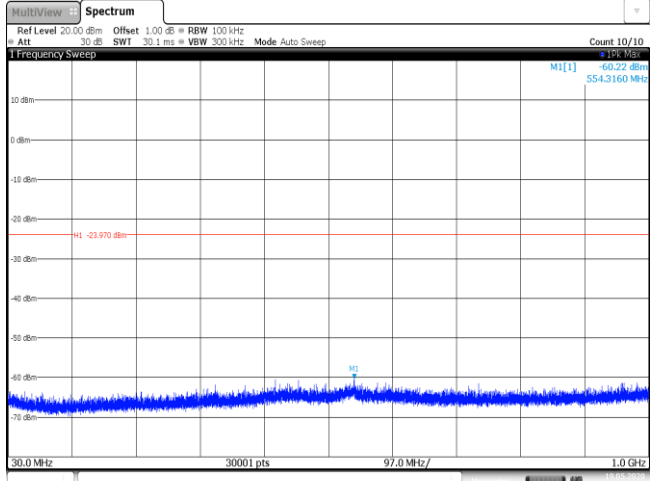
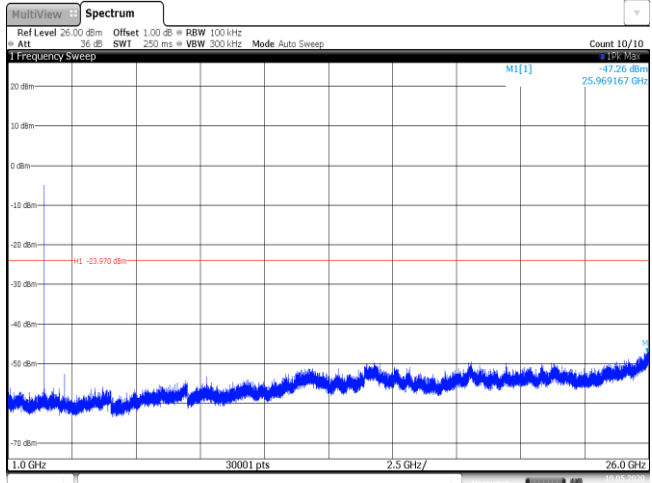
| Test Item: | Spurious Emission | Modulation type: | 8DPSK |
|---------------------------------|--|------------------|-------|
| <p>CH00 Reference level</p> |  <p>Date: 19.MAY.2020 16:03:09</p> | | |
| <p>CH00 30MHz~1000MHz</p> |  <p>Date: 19.MAY.2020 16:03:25</p> | | |
| <p>CH00 1GHz~26GHz</p> |  <p>Date: 19.MAY.2020 16:03:41</p> | | |

| | |
|---------------------------------|---|
| <p>CH39 Reference level</p> | <p>Ref Level 30.00 dBm Offset 1.00 dB RBW 100 kHz Att 30 dB SWF 1.04 ms VBW 300 kHz Mode Auto Sweep Count 100/100 M1[1] -4.08 dBm 2.4411800 GHz CF 2.441 GHz 1001 pts 3.0 MHz/ Span 30.0 MHz Date: 19.MAY.2020 16:06:21</p> |
| <p>CH39 30MHz~1000MHz</p> | <p>Ref Level 20.00 dBm Offset 1.00 dB RBW 100 kHz Att 30 dB SWF 30.1 ms VBW 300 kHz Mode Auto Sweep Count 10/10 M1[1] -60.60 dBm 549.5630 MHz 30.0 MHz 30001 pts 97.0 MHz/ 1.0 GHz Date: 19.MAY.2020 16:06:37</p> |
| <p>CH39 1GHz~26GHz</p> | <p>Ref Level 26.00 dBm Offset 1.00 dB RBW 100 kHz Att 36 dB SWF 250 ms VBW 300 kHz Mode Auto Sweep Count 10/10 M1[1] -46.05 dBm 25.919167 GHz 1.0 GHz 30001 pts 2.5 GHz/ 26.0 GHz Date: 19.MAY.2020 16:06:54</p> |

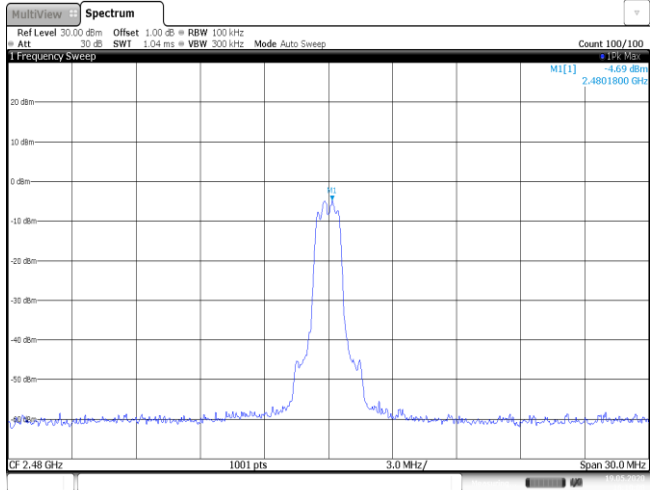
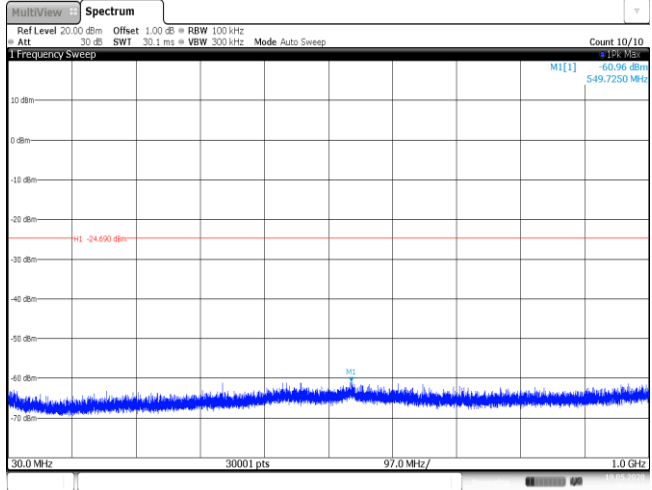
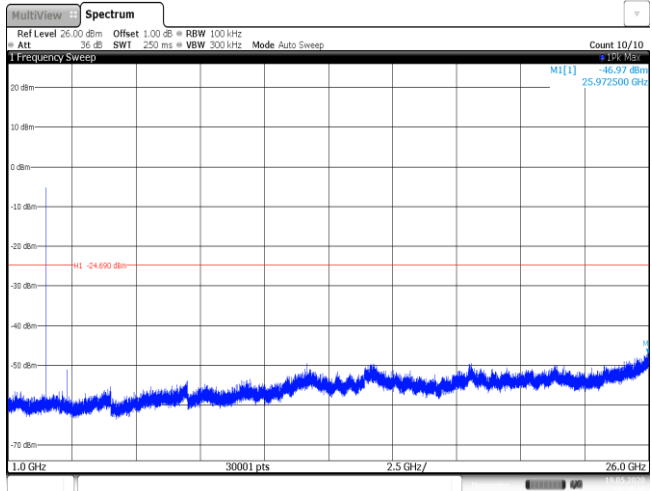
| | |
|---------------------------------|--|
| <p>CH78 Reference level</p> |  <p>MultiView Spectrum Ref Level 30.00 dBm Offset 1.00 dB RBW 100 kHz Att 30 dB SWF 1.04 ms VBW 300 kHz Mode Auto Sweep Count 100/100 1 Frequency Sweep MI[1] -46.9 dBm 2.4801800 GHz CF 2.48 GHz 1001 pts 3.0 MHz/ Span 30.0 MHz Date: 19.MAY.2020 16:10:07</p> |
| <p>CH78 30MHz~1000MHz</p> |  <p>MultiView Spectrum Ref Level 20.00 dBm Offset 1.00 dB RBW 100 kHz Att 30 dB SWF 30.1 ms VBW 300 kHz Mode Auto Sweep Count 10/10 1 Frequency Sweep MI[1] -60.96 dBm 549.7250 MHz H1 -24.600 dBm M1 30.0 MHz 30001 pts 97.0 MHz/ 1.0 GHz Date: 19.MAY.2020 16:10:23</p> |
| <p>CH78 1GHz~26GHz</p> |  <p>MultiView Spectrum Ref Level 26.00 dBm Offset 1.00 dB RBW 100 kHz Att 36 dB SWF 250 ms VBW 300 kHz Mode Auto Sweep Count 10/10 1 Frequency Sweep MI[1] -46.97 dBm 25.972500 GHz H1 -24.600 dBm M1 1.0 GHz 30001 pts 2.5 GHz/ 26.0 GHz Date: 19.MAY.2020 16:10:40</p> |

-----End of Report-----