



TEST REPORT

Report No. : **CHEW20060007** Report Verification: 

Project No...... : **SHT2005070601EW**

FCC ID..... : **2AVTH-LO14WA**

Applicant's name..... : **Hyundai Technology Group, Inc.**

Address..... : 2601 Walnut Ave. Tustin, CA, USA

Manufacturer..... : Hyundai Technology Group, Inc.

Address..... : 2601 Walnut Ave. Tustin, CA, USA

Test item description : **Notebook**

Trade Mark : HYUNDAI

Model/Type reference..... : Hyundai Onnyx III

Listed Model(s) : LO14WA1BK,LO14WA1B,LO14WB1B,LO14WA1S,LO14WA1R
 G,LO14WB1S,Hyundai Onnyx III Plus

Standard : **FCC CFR Title 47 Part 15 Subpart C Section 15.247**

Date of receipt of test sample..... : May 18, 2020

Date of testing..... : May 19, 2020-Jun.01, 2020

Date of issue..... : Jun.01, 2020

Result..... : **PASS**

Compiled by
 (Position+Printed name+Signature): File administrator Fanghui Zhu 

Supervised by
 (Position+Printed name+Signature): Project Engineer Kiki Kong 

Approved by
 (Position+Printed name+Signature): RF Manager Hans Hu 

Testing Laboratory Name : **Shenzhen Huatongwei International Inspection Co., Ltd.**

Address..... : 1/F, Bldg 3, Hongfa Hi-tech Industrial Park, Genyu Road,
 Tianliao, Gongming, Shenzhen, China

Shenzhen Huatongwei International Inspection Co., Ltd. All rights reserved.

This publication may be reproduced in whole or in part for non-commercial purposes as long as the Shenzhen Huatongwei International Inspection Co., Ltd. is acknowledged as copyright owner and source of the material. Shenzhen Huatongwei International Inspection Co., Ltd. takes no responsibility for and will not assume liability for damages resulting from the reader's interpretation of the reproduced material due to its placement and context.

The test report merely correspond to the test sample.

Contents

1.	<u>TEST STANDARDS AND REPORT VERSION</u>	3
1.1.	Test Standards	3
1.2.	Report version	3
2.	<u>TEST DESCRIPTION</u>	4
3.	<u>SUMMARY</u>	5
3.1.	Client Information	5
3.2.	Product Description	5
3.3.	Radio Specification Description	5
3.4.	Testing Laboratory Information	6
4.	<u>TEST CONFIGURATION</u>	7
4.1.	Test frequency list	7
4.2.	Descriptions of Test mode	7
4.3.	Test mode	7
4.4.	Support unit used in test configuration and system	8
4.5.	Testing environmental condition	8
4.6.	Measurement uncertainty	8
4.7.	Equipment Used during the Test	9
5.	<u>TEST CONDITIONS AND RESULTS</u>	11
5.1.	Antenna Requirement	11
5.2.	AC Conducted Emission	12
5.3.	Peak Output Power	15
5.4.	20 dB Bandwidth	16
5.5.	99% Occupied Bandwidth	17
5.6.	Carrier Frequencies Separation	18
5.7.	Hopping Channel Number	19
5.8.	Dwell Time	20
5.9.	Duty Cycle Correction Factor (DCCF)	21
5.10.	Pseudorandom Frequency Hopping Sequence	22
5.11.	Conducted Band edge and Spurious Emission	23
5.12.	Radiated Band edge Emission	25
5.13.	Radiated Spurious Emission	27
6.	<u>TEST SETUP PHOTOS</u>	32
7.	<u>EXTERANAL AND INTERNAL PHOTOS</u>	33
8.	<u>APPENDIX REPORT</u>	33

1. TEST STANDARDS AND REPORT VERSION

1.1. Test Standards

The tests were performed according to following standards:

- [FCC Rules Part 15.247](#): Frequency Hopping, Direct Spread Spectrum and Hybrid Systems that are in operation within the bands of 902-928 MHz, 2400-2483.5 MHz, and 5725-5850 MHz
- [ANSI C63.10:2013](#): American National Standard for Testing Unlicensed Wireless Devices
- [KDB 558074 D01 15.247 Meas Guidance v05r02](#): Guidance for Compliance Measurements on Digital Transmission System, Frequency Hopping Spread Spectrum System, and Hybrid System Devices Operating under Section 15.247 of The FCC Rules

1.2. Report version

Revision No.	Date of issue	Description
N/A	2020-06-01	Original

2. TEST DESCRIPTION

Report clause	Test Items	Standard Requirement	Result
5.1	Antenna Requirement	15.203/15.247 (c)	PASS
5.2	AC Conducted Emission	15.207	PASS
5.3	Peak Output Power	15.247 (b)(1)	PASS
5.4	20 dB Bandwidth	15.247 (a)(1)	PASS
5.5	99% Occupied Bandwidth	-	PASS ^{*1}
5.6	Carrier Frequency Separation	15.247 (a)(1)	PASS
5.7	Hopping Channel Number	15.247 (a)(1)	PASS
5.8	Dwell Time	15.247 (a)(1)	PASS
5.9	Duty Cycle Correction Factor	-	PASS ^{*1}
5.10	Pseudorandom Frequency Hopping Sequence	15.247(b)(4)	PASS
5.11	Conducted Band Edge and Spurious Emission	15.247(d)/15.205	PASS
5.12	Radiated Band Edge Emission	15.205/15.209	PASS
5.13	Radiated Spurious Emission	15.247(d)/15.205/15.209	PASS

Note:

- The measurement uncertainty is not included in the test result.
- *1: No requirement on standard, only report these test data.

3. SUMMARY

3.1. Client Information

Applicant:	Hyundai Technology Group, Inc.
Address:	2601 Walnut Ave. Tustin, CA, USA
Manufacturer:	Hyundai Technology Group, Inc.
Address:	2601 Walnut Ave. Tustin, CA, USA

3.2. Product Description

Name of EUT:	Notebook
Trade Mark:	HYUNDAI
Model No.:	Hyundai Onnyx III
Listed Model(s):	LO14WA1BK,LO14WA1B,LO14WB1B,LO14WA1S,LO14WA1RG, LO14WB1S,Hyundai Onnyx III Plus
Power supply:	DC 7.6V
Hardware version:	IP3_AN10F MB_V30
Software version:	1909
Adapter Information:	Model: RY-24A120200VU Input: AC 100-240V~ 50/60Hz 0.8A Output: DC 12V 2.0A
Battery Information:	Model: NV-3285128-2S NOM 7.6V 5000mAh 38Wh Max Voltage: 8.7V

3.3. Radio Specification Description

Bluetooth version:	V4.0
Support function ^{*2} :	EDR
Modulation:	GFSK, $\pi/4$ DQPSK, 8DPSK
Operation frequency:	2402MHz~2480MHz
Channel number:	79
Channel separation:	1MHz
Antenna type:	FPC Antenna
Antenna gain:	1.28 dBi

Note:

*2: only show the RF function associated with this report.

3.4. Testing Laboratory Information

Laboratory Name	Shenzhen Huatongwei International Inspection Co., Ltd.	
Laboratory Location	1/F, Bldg 3, Hongfa Hi-tech Industrial Park, Genyu Road, Tianliao, Gongming, Shenzhen, China	
Qualifications	Type	Accreditation Number
	CNAS	L1225
	A2LA	3902.01
	FCC	762235
	Canada	5377A

4. TEST CONFIGURATION

4.1. Test frequency list

According to section 15.31(m), regards to the operating frequency range over 10 MHz, must select three channels which were tested. The Lowest frequency, the middle frequency, and the highest frequency of channel were selected to perform the test, please see the below blue front.

Channel	Frequency (MHz)
00	2402
01	2403
⋮	⋮
39	2441
⋮	⋮
77	2479
78	2480

4.2. Descriptions of Test mode

Preliminary tests were performed in different data rates and recorded the RF output power in the clause 5.3

Note:

- 1) The manufacturer declare that the maximum power value of the product is set as a default value in the enter test mode software.
- 2) All the test data for each data rate were verified, found $\pi/4$ DQPSK Modulation which is worse case mode

4.3. Test mode

For RF test items:			
The engineering test program was provided and enabled to make EUT continuous transmitting.			
Test Item	Modulation / Data Rate		
	GFSK 1Mbps	$\pi/4$ DQPSK 2Mbps	8DPSK 3Mbps
Conducted test item	✓	✓	✓
Radiated test item	-	✓	-
Remark:			
<ul style="list-style-type: none"> - For radiated test item, the worst mode data rate 3Mbps was reported only, because this data rate has the highest RF output power at preliminary tests. - The EUT in each of three orthogonal axis emissions had been tested, but only the worst case (X axis) data recorded in the report. 			

4.4. Support unit used in test configuration and system

The EUT has been associated with peripherals and configuration operated in a manner tended to maximize its emission characteristics in a typical application.

The following peripheral devices and interface cables were connected during the measurement:

Whether support unit is used?					
✓ No					
Item	Equipement	Trade Name	Model No.	FCC ID	Power cord
1					
2					

4.5. Testing environmental condition

Type	Requirement	Actual
Temperature:	15~35°C	25°C
Relative Humidity:	25~75%	50%
Air Pressure:	860~1060mbar	1000mbar

4.6. Measurement uncertainty

Test Item	Measurement Uncertainty
AC Conducted Emission (150kHz~30MHz)	3.02 dB
Radiated Emission (30MHz~1000MHz)	4.90 dB
Radiated Emissions (1GHz~25GHz)	4.96 dB
Peak Output Power	0.51 dB
Power Spectral Density	0.51 dB
Conducted Spurious Emission	0.51 dB
6dB Bandwidth	70 Hz

This uncertainty represents an expanded uncertainty expressed at approximately the 95% confidence level using a coverage factor of k=1.96.

4.7. Equipment Used during the Test

● Conducted Emission							
Used	Test Equipment	Manufacturer	Equipment No.	Model No.	Serial No.	Last Cal. Date (YY-MM-DD)	Next Cal. Date (YY-MM-DD)
●	Shielded Room	Albatross projects	HTWE0114	N/A	N/A	2018/09/28	2023/09/27
●	EMI Test Receiver	R&S	HTWE0111	ESCI	101247	2019/10/26	2020/10/25
●	Artificial Mains	SCHWARZBECK	HTWE0113	NNLK 8121	573	2019/10/23	2020/10/22
●	Pulse Limiter	R&S	HTWE0033	ESH3-Z2	100499	2019/10/23	2020/10/22
●	RF Connection Cable	HUBER+SUHNER	HTWE0113-02	ENVIROFLE X_142	EF-NM-BNCM-2M	2019/10/23	2020/10/22
●	Test Software	R&S	N/A	ES-K1	N/A	N/A	N/A

● Radiated emission-6th test site							
Used	Test Equipment	Manufacturer	Equipment No.	Model No.	Serial No.	Last Cal. Date (YY-MM-DD)	Next Cal. Date (YY-MM-DD)
●	Semi-Anechoic Chamber	Albatross projects	HTWE0127	SAC-3m-02	C11121	2018/09/30	2021/09/29
●	EMI Test Receiver	R&S	HTWE0099	ESCI	100900	2019/10/26	2020/10/25
●	Loop Antenna	R&S	HTWE0170	HFH2-Z2	100020	2018/04/02	2021/04/01
●	Ultra-Broadband Antenna	SCHWARZBECK	HTWE0119	VULB9163	538	2018/04/04	2021/04/03
●	Pre-Amplifier	SCHWARZBECK	HTWE0295	BBV 9742	N/A	2019/11/14	2020/11/13
●	RF Connection Cable	HUBER+SUHNER	HTWE0062-01	N/A	N/A	2019/08/21	2020/08/20
●	RF Connection Cable	HUBER+SUHNER	HTWE0062-02	SUCOFLEX 104	501184/4	2020/05/27	2021/05/26
●	Test Software	R&S	N/A	ES-K1	N/A	N/A	N/A

● Radiated emission-7th test site							
Used	Test Equipment	Manufacturer	Equipment No.	Model No.	Serial No.	Last Cal. Date (YY-MM-DD)	Next Cal. Date (YY-MM-DD)
●	Semi-Anechoic Chamber	Albatross projects	HTWE0122	SAC-3m-01	N/A	2018/09/27	2021/09/26
●	Spectrum Analyzer	R&S	HTWE0098	FSP40	100597	2019/10/26	2020/10/25
●	Horn Antenna	SCHWARZBECK	HTWE0126	9120D	1011	2017/04/01	2020/03/31
●	Horn Antenna	SCHWARZBECK	HTWE0103	BBHA9170	25841	2018/10/11	2021/10/10
●	Broadband Horn Antenna	SCHWARZBECK	HTWE0103	BBHA9170	BBHA9170472	2018/10/11	2021/10/11
●	Pre-amplifier	CD	HTWE0071	PAP-0102	12004	2019/11/14	2020/11/13
●	Broadband Pre-amplifier	SCHWARZBECK	HTWE0201	BBV 9718	9718-248	2020/05/23	2021/05/22
●	RF Connection Cable	HUBER+SUHNER	HTWE0120-01	6m 18GHz S Serisa	N/A	2020/05/10	2021/05/09
●	RF Connection Cable	HUBER+SUHNER	HTWE0120-02	6m 3GHz RG Serisa	N/A	2020/05/10	2021/05/09
●	RF Connection Cable	HUBER+SUHNER	HTWE0120-03	6m 3GHz RG Serisa	N/A	2020/05/10	2021/05/09
●	RF Connection Cable	HUBER+SUHNER	HTWE0120-04	6m 3GHz RG Serisa	N/A	2020/05/10	2021/05/09
●	RF Connection Cable	HUBER+SUHNER	HTWE0121-01	6m 18GHz S Serisa	N/A	2020/05/10	2021/05/09
●	Test Software	Audix	N/A	E3	N/A	N/A	N/A

● RF Conducted Method						
Used	Test Equipment	Manufacturer	Model No.	Serial No.	Last Cal. Date (YY-MM-DD)	Next Cal. Date (YY-MM-DD)
●	Signal and spectrum Analyzer	R&S	FSV40	100048	2019/10/26	2020/10/25
●	Spectrum Analyzer	Agilent	N9020A	MY50510187	2019/10/26	2020/10/25
○	Power Meter	Anritsu	ML249A	N/A	2019/10/26	2020/10/25
○	Radio communication tester	R&S	CMW500	137688-Lv	2019/10/26	2020/10/25

5. TEST CONDITIONS AND RESULTS

5.1. Antenna Requirement

Requirement

FCC CFR Title 47 Part 15 Subpart C Section 15.203:

An intentional radiator shall be designed to ensure that no antenna other than that furnished by the responsible party shall be used with the device. The use of a permanently attached antenna or of an antenna that uses a unique coupling to the intentional radiator, the manufacturer may design the unit so that a broken antenna can be replaced by the user, but the use of a standard antenna jack or electrical connector is prohibited.

FCC CFR Title 47 Part 15 Subpart C Section 15.247(c) (1)(i):

(i) Systems operating in the 2400-2483.5 MHz band that is used exclusively for fixed. Point-to-point operations may employ transmitting antennas with directional gain greater than 6 dBi provided the maximum conducted output power of the intentional radiator is reduced by 1 dB for every 3 dB that the directional gain of the antenna exceeds 6 dBi.

TEST RESULT

Passed Not Applicable

The antenna type is a FPC antenna, the directional gain of the antenna less than 6 dBi, please refer to the below antenna photo.

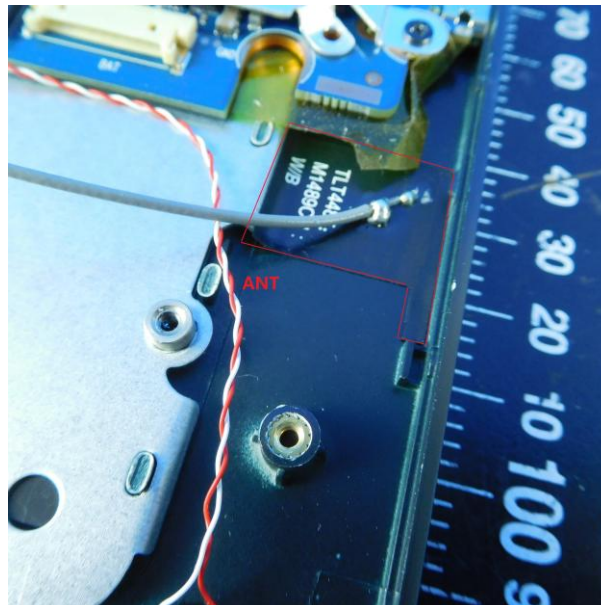

5.2. AC Conducted Emission

LIMIT

FCC CFR Title 47 Part 15 Subpart C Section 15.207

Frequency range (MHz)	Limit (dBuV)	
	Quasi-peak	Average
0.15-0.5	66 to 56*	56 to 46*
0.5-5	56	46
5-30	60	50

* Decreases with the logarithm of the frequency.

TEST CONFIGURATION

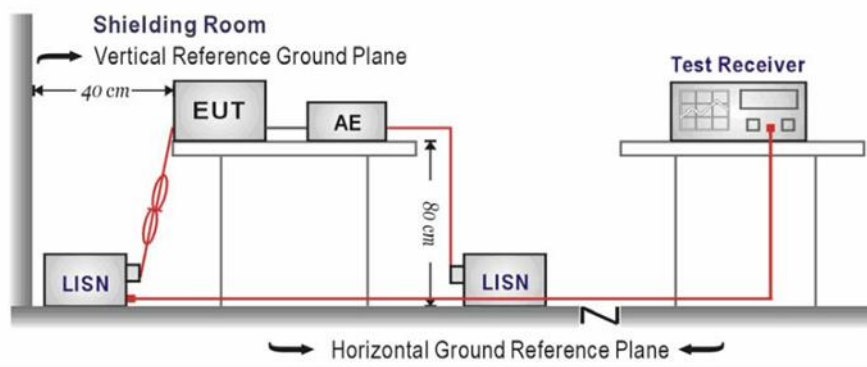

TEST PROCEDURE

1. The EUT was setup according to ANSI C63.10 requirements.
2. The EUT was placed on a platform of nominal size, 1 m by 1.5 m, raised 80 cm above the conducting ground plane. The vertical conducting plane was located 40 cm to the rear of the EUT. All other surfaces of EUT were at least 80 cm from any other grounded conducting surface.
3. The EUT and simulators are connected to the main power through a line impedances stabilization network (LISN). The LISN provides a 50 ohm /50uH coupling impedance for the measuring equipment.
4. The peripheral devices are also connected to the main power through a LISN. (Please refer to the block diagram of the test setup and photographs)
5. Each current-carrying conductor of the EUT power cord, except the ground (safety) conductor, was individually connected through a LISN to the input power source.
6. The excess length of the power cord between the EUT and the LISN receptacle were folded back and forth at the center of the lead to form a bundle not exceeding 40 cm in length.
7. Conducted emissions were investigated over the frequency range from 0.15MHz to 30MHz using a receiver bandwidth of 9 kHz.
8. During the above scans, the emissions were maximized by cable manipulation.

TEST MODE:

Please refer to the clause 4.3

TEST RESULT

Passed Not Applicable

Test Line:

L

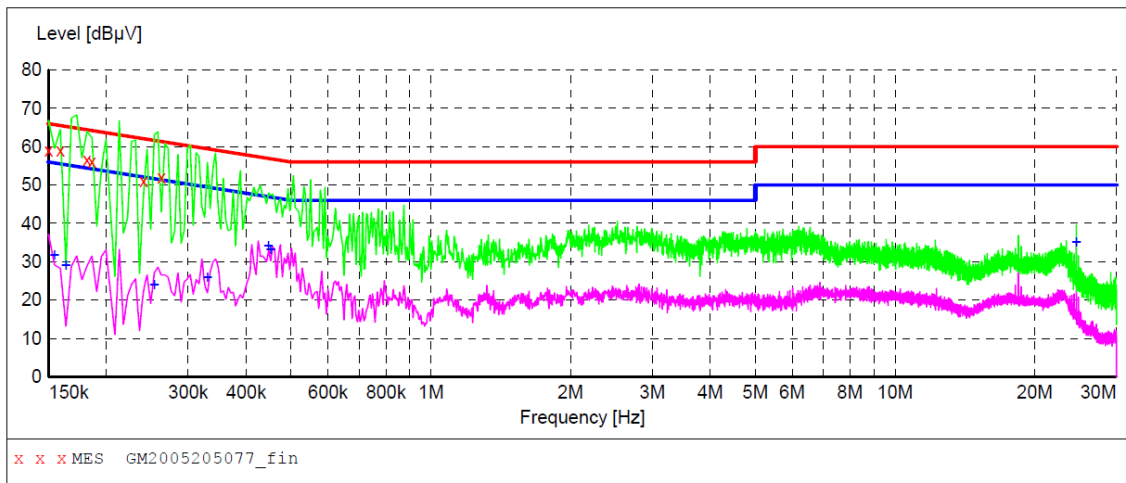

MEASUREMENT RESULT: "GM2005205077_fin"

5/20/2020 5:39PM

Frequency MHz	Level dBµV	Transd dB	Limit dBµV	Margin dB	Detector	Line	PE
0.150000	58.90	10.0	66	7.1	QP	L1	GND
0.159000	58.90	10.0	66	6.6	QP	L1	GND
0.181500	56.70	10.0	64	7.7	QP	L1	GND
0.186000	56.20	10.0	64	8.0	QP	L1	GND
0.240000	51.10	10.0	62	11.0	QP	L1	GND
0.262500	52.10	10.0	61	9.3	QP	L1	GND

MEASUREMENT RESULT: "GM2005205077_fin2"

5/20/2020 5:39PM

Frequency MHz	Level dBµV	Transd dB	Limit dBµV	Margin dB	Detector	Line	PE
0.154500	31.80	10.0	56	24.0	AV	L1	GND
0.163500	29.10	10.0	55	26.2	AV	L1	GND
0.253500	23.90	10.0	52	27.7	AV	L1	GND
0.330000	25.80	10.1	50	23.7	AV	L1	GND
0.447000	34.20	10.1	47	12.7	AV	L1	GND
0.451500	33.20	10.1	47	13.6	AV	L1	GND
24.576000	35.20	10.6	50	14.8	AV	L1	GND

Test Line:

N

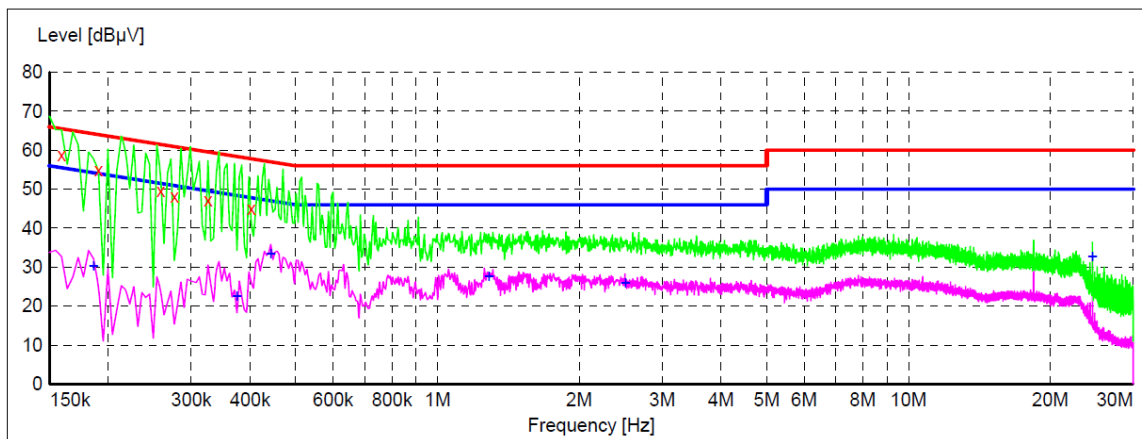

x x x MES GM2005205076_fin

MEASUREMENT RESULT: "GM2005205076_fin"

5/20/2020 5:35PM

Frequency MHz	Level dBµV	Transd dB	Limit dBµV	Margin dB	Detector	Line	PE
0.159000	58.80	10.0	66	6.7	QP	N	GND
0.190500	54.80	10.0	64	9.2	QP	N	GND
0.258000	49.70	10.0	62	11.8	QP	N	GND
0.276000	48.20	10.1	61	12.7	QP	N	GND
0.325500	47.20	10.1	60	12.4	QP	N	GND
0.402000	44.90	10.1	58	12.9	QP	N	GND

MEASUREMENT RESULT: "GM2005205076_fin2"

5/20/2020 5:35PM

Frequency MHz	Level dBµV	Transd dB	Limit dBµV	Margin dB	Detector	Line	PE
0.186000	30.30	10.0	54	23.9	AV	N	GND
0.375000	22.60	10.1	48	25.8	AV	N	GND
0.442500	33.40	10.1	47	13.6	AV	N	GND
1.284000	27.50	10.1	46	18.5	AV	N	GND
2.503500	26.00	10.2	46	20.0	AV	N	GND
24.576000	32.70	10.6	50	17.3	AV	N	GND

5.3. Peak Output Power

LIMIT

FCC CFR Title 47 Part 15 Subpart C Section 15.247 (b)(1):

For frequency hopping systems operating in the 2400-2483.5 MHz band employing at least 75 non-overlapping hopping channels, and all frequency hopping systems in the 5725-5850 MHz band: 1 watt.
For all other frequency hopping systems in the 2400-2483.5 MHz band: 0.125 watts.

TEST CONFIGURATION

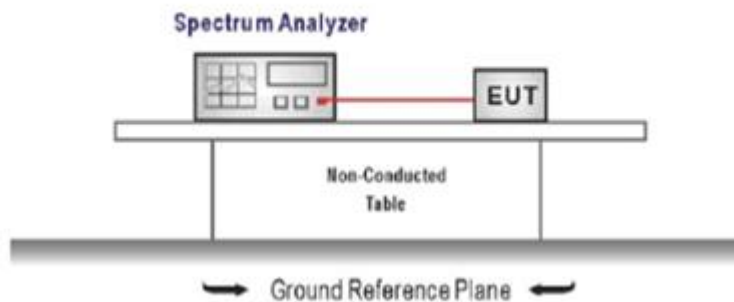

TEST PROCEDURE

1. The transmitter output was connected to the spectrum analyzer through an attenuator, the pathloss was compensated to the results for each measurement.
2. Set to the maximum power setting and enable the EUT transmit continuously
3. Use the following spectrum analyzer settings:
Span = approximately 5 times the 20 dB bandwidth, centered on a hopping channel
RBW \geq the 20 dB bandwidth of the emission being measured, VBW \geq RBW
Sweep = auto, Detector function = peak, Trace = max hold
4. Measure and record the results in the test report.

TEST MODE:

Please refer to the clause 4.3

TEST RESULT

Passed Not Applicable

TEST Data

Please refer to appendix A on the appendix report

5.4. 20 dB Bandwidth

LIMIT

N/A

TEST CONFIGURATION

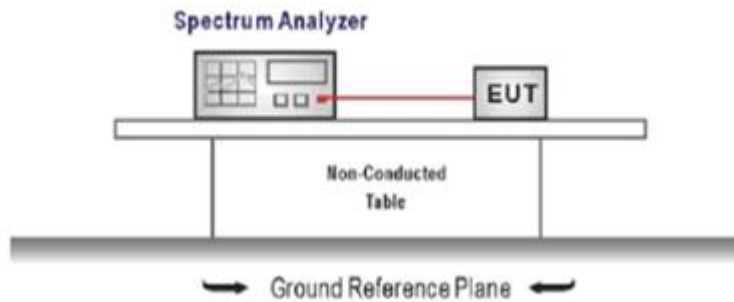

TEST PROCEDURE

1. The transmitter output was connected to the spectrum analyzer through an attenuator, the path loss was compensated to the results for each measurement.
2. Set to the maximum power setting and enable the EUT transmit continuously
3. Use the following spectrum analyzer settings:
Span = approximately 2 to 3 times the 20 dB bandwidth, centered on a hopping channel
RBW \geq 1% of the 20 dB bandwidth, VBW \geq RBW
Sweep = auto, Detector function = peak, Trace = max hold
4. Measure and record the results in the test report.

TEST MODE:

Please refer to the clause 4.3

TEST RESULT

Passed Not Applicable

TEST Data

Please refer to appendix B on the appendix report

5.5. 99% Occupied Bandwidth

LIMIT

N/A

TEST CONFIGURATION

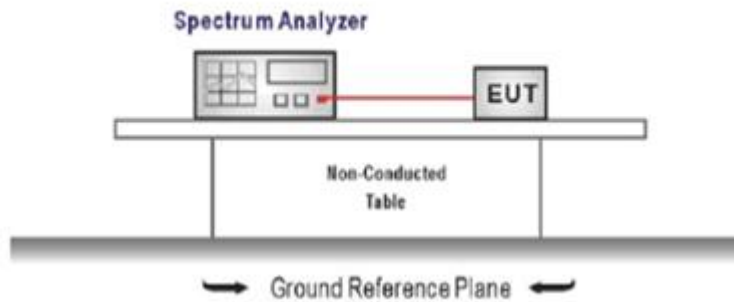

TEST PROCEDURE

1. Connect the antenna port(s) to the spectrum analyzer input.
2. Configure the spectrum analyzer as shown below (enter all losses between the transmitter output and the spectrum analyzer).
Center Frequency = channel center frequency
Span $\geq 1.5 \times$ OBW
RBW = 1%~5%OBW
VBW $\geq 3 \times$ RBW
Sweep time = auto couple
Detector = Peak
Trace mode = max hold
3. Place the radio in continuous transmit mode, allow the trace to stabilize, view the transmitter waveform on the spectrum analyzer.

TEST MODE:

Please refer to the clause 4.3

TEST RESULT

Passed Not Applicable

TEST Data

Please refer to appendix C on the appendix report

5.6. Carrier Frequencies Separation

LIMIT

FCC CFR Title 47 Part 15 Subpart C Section 15.247 (a)(1):

Frequency hopping systems shall have hopping channel carrier frequencies separated by a minimum of 25kHz or the 20 dB bandwidth of the hopping channel, whichever is greater. Alternatively, Frequency hopping systems operating in the 2400-2483.5 MHz band may have hopping channel carrier frequencies that are separated by 25 kHz or two-thirds of the 20 dB bandwidth of the hopping channel, whichever is greater, provided the systems operate with an output power no greater than 125 mW.

TEST CONFIGURATION

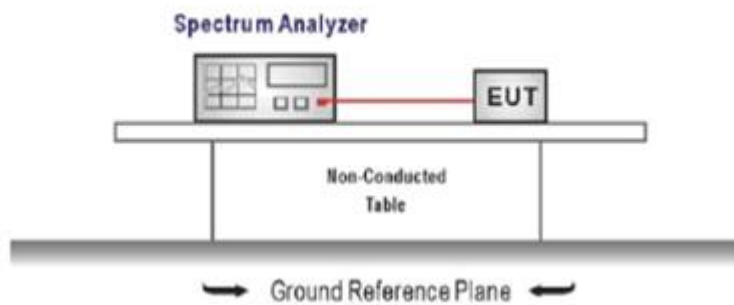

TEST PROCEDURE

1. The transmitter output was connected to the spectrum analyzer through an attenuator, the path loss was compensated to the results for each measurement.
2. Set to the maximum power setting and enable the EUT transmit continuously
3. Use the following spectrum analyzer settings:
 - Span = wide enough to capture the peaks of two adjacent channels
 - RBW \geq 1% of the span, VBW \geq RBW
 - Sweep = auto, Detector function = peak, Trace = max hold
4. Measure and record the results in the test report.

TEST MODE:

Please refer to the clause 4.3

TEST RESULTS

Passed Not Applicable

TEST Data

Please refer to appendix D on the appendix report

5.7. Hopping Channel Number

LIMIT

FCC CFR Title 47 Part 15 Subpart C Section 15.247 (a)(1):

Frequency hopping systems in the 2400–2483.5 MHz band shall use at least **15** channels.

TEST CONFIGURATION

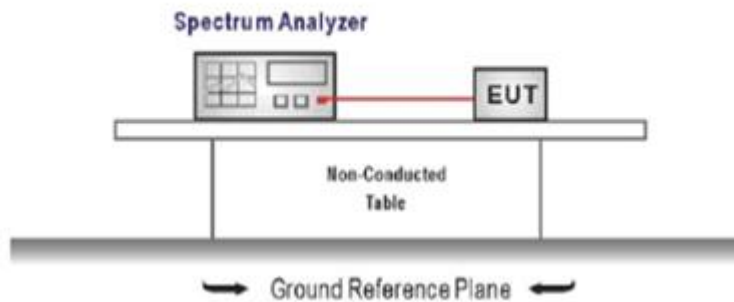

TEST PROCEDURE

1. The transmitter output was connected to the spectrum analyzer through an attenuator, the path loss was compensated to the results for each measurement.
2. Set to the maximum power setting and enable the EUT transmit continuously
3. Use the following spectrum analyzer settings:
Span = the frequency band of operation
RBW \geq 1% of the span, VBW \geq RBW
Sweep = auto, Detector function = peak, Trace = max hold
4. Measure and record the results in the test report.

TEST MODE:

Please refer to the clause 4.3

TEST RESULTS

Passed Not Applicable

TEST Data

Please refer to appendix E on the appendix report

5.8. Dwell Time

LIMIT

FCC CFR Title 47 Part 15 Subpart C Section 15.247 (a)(1):The average time of occupancy on any channel shall not be greater than 0.4 seconds within a pe-riod of 0.4 seconds multiplied by the number of hopping channels employed.

TEST CONFIGURATION

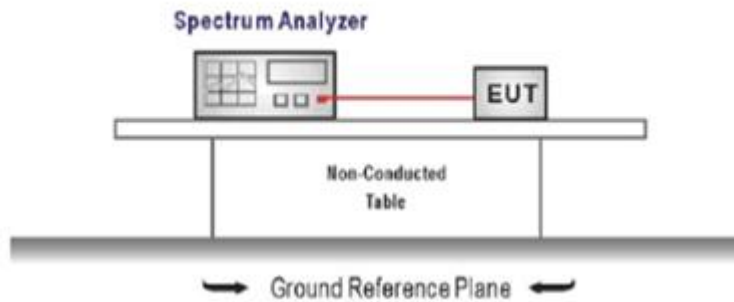

TEST PROCEDURE

1. The transmitter output was connected to the spectrum analyzer through an attenuator, the path loss was compensated to the results for each measurement.
2. Set to the maximum power setting and enable the EUT transmit continuously
3. Use the following spectrum analyzer settings:
Span = zero span, centered on a hopping channel, RBW= 1 MHz, VBW \geq RBW
Sweep = as necessary to capture the entire dwell time per hopping channel,
Detector function = peak, Trace = max hold
4. Measure and record the results in the test report.

TEST MODE:

Please refer to the clause 4.3

TEST RESULTS

Passed Not Applicable

TEST Data

Please refer to appendix F on the appendix report

5.9. Duty Cycle Correction Factor (DCCF)

LIMIT

N/A

TEST CONFIGURATION

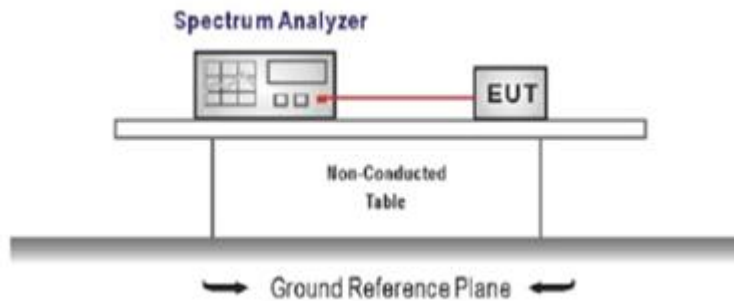

TEST PROCEDURE

1. The transmitter output was connected to the spectrum analyzer through an attenuator, the path loss was compensated to the results for each measurement.
2. Set to the maximum power setting and enable the EUT transmit continuously
3. Use the following spectrum analyzer settings:
Span = zero span, centered on a hopping channel, RBW= 1 MHz, VBW \geq RBW
Sweep = as necessary to capture the entire dwell time per hopping channel,
Detector function = peak, Trigger mode
4. Measure and record the duty cycle data

TEST MODE:

Please refer to the clause 4.3

TEST Data

Please refer to appendix G on the appendix report

5.10. Pseudorandom Frequency Hopping Sequence

LIMIT

FCC CFR Title 47 Part 15 Subpart C Section 15.247 (a)(1):Frequency hopping systems shall have hopping channel carrier frequencies separated by a minimum of 25 kHz or the 20 dB bandwidth of the hopping channel, whichever is greater. Alternatively, frequency hopping systems operating in the 2400–2483.5 MHz band may have hopping channel carrier frequencies that are separated by 25 kHz or two-thirds of the 20 dB bandwidth of the hopping channel, whichever is greater, provided the systems operate with an output power no greater than 125 mW. The system shall hop to channel frequencies that are selected at the system hopping rate from a pseudo randomly ordered list of hopping frequencies. Each frequency must be used equally on the average by each transmitter. The system receivers shall have input bandwidths that match the hopping channel bandwidths of their corresponding transmitters and shall shift frequencies in synchronization with the transmitted signals.

TEST RESULTS

The pseudorandom frequency hopping sequence may be generated in a nine-stage shift register whose 5th and 9th stage outputs are added in a modulo-two addition stage. And the result is fed back to the input of the first stage. The sequence begins with the first one of 9 consecutive ones, for example: the shift register is initialized with nine ones.

- Number of shift register stages: 9
- Length of pseudo-random sequence: $2^9 - 1 = 511$ bits
- Longest sequence of zeros: 8 (non-inverted signal)

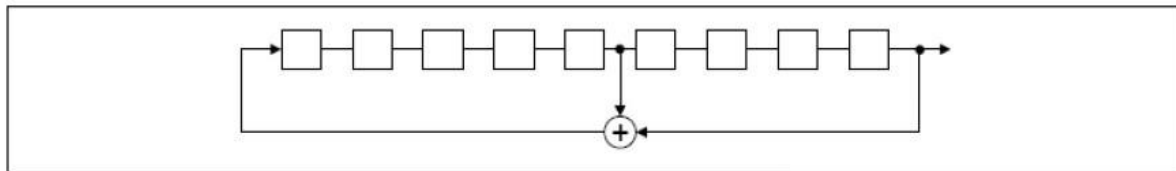

Linear Feedback Shift Register for Generation of the PRBS sequence

An example of pseudorandom frequency hopping sequence as follows:

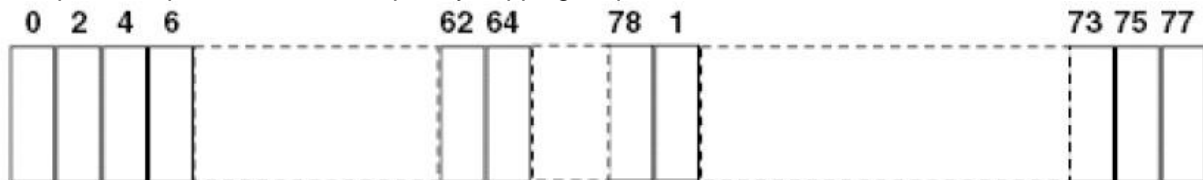

Each frequency used equally on the average by each transmitter. The system receiver has input bandwidths that match the hopping channel bandwidths of their corresponding transmitter and shifts frequencies in synchronization with the transmitted signals.

5.11. Conducted Band edge and Spurious Emission

LIMIT

FCC CFR Title 47 Part 15 Subpart C Section 15.247 (d): In any 100 kHz bandwidth outside the frequency band in which the spread spectrum intentional radiator is operating, the radio frequency power that is produced by the intentional radiator shall be at least 20 dB below that in the 100 kHz bandwidth within the band that contains the highest level of the desired power, based on either an RF conducted or a radiated measurement.

TEST CONFIGURATION

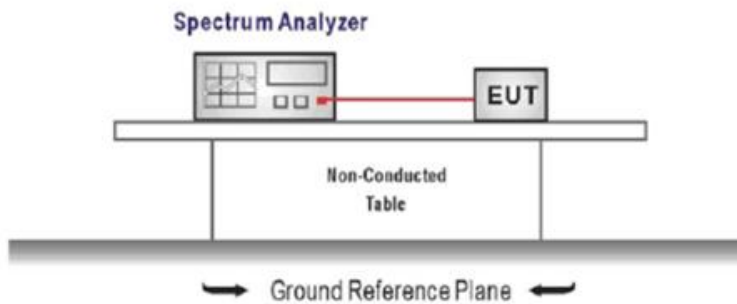

TEST PROCEDURE

1. Connect the antenna port(s) to the spectrum analyzer input.
2. Establish a reference level by using the following procedure
Center frequency=DTS channel center frequency
The span = 1.5 times the DTS bandwidth.
RBW = 100 kHz, VBW $\geq 3 \times$ RBW
Detector = peak, Sweep time = auto couple, Trace mode = max hold
Allow trace to fully stabilize
Use the peak marker function to determine the maximum PSD level

Note that the channel found to contain the maximum PSD level can be used to establish the reference level.

3. Emission level measurement
Set the center frequency and span to encompass frequency range to be measured
RBW = 100 kHz, VBW $\geq 3 \times$ RBW
Detector = peak, Sweep time = auto couple, Trace mode = max hold
Allow trace to fully stabilize
Use the peak marker function to determine the maximum amplitude level.
4. Place the radio in continuous transmit mode, allow the trace to stabilize, view the transmitter waveform on the spectrum analyzer.
5. Ensure that the amplitude of all unwanted emission outside of the authorized frequency band excluding restricted frequency bands) are attenuated by at least the minimum requirements specified (at least 20 dB relative to the maximum in-band peak PSD level in 100 kHz). Report the three highest emission relative to the limit.

TEST MODE:

Please refer to the clause 4.3

TEST RESULT

Passed **Not Applicable**

TEST Data

Please refer to appendix H on the appendix report

5.12. Radiated Band edge Emission

LIMIT

FCC CFR Title 47 Part 15 Subpart C Section 15.247 (d):

In any 100 kHz bandwidth outside the frequency band in which the spread spectrum or digitally modulated intentional radiator is operating, Radiated Emissions which fall in the restricted bands, as defined in §15.205(a), must also comply with the Radiated Emissions limits specified in §15.209(a) (see §15.205(c)).

TEST CONFIGURATION

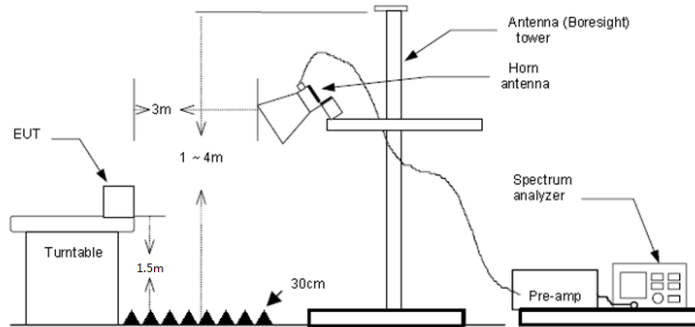

TEST PROCEDURE

1. The EUT was setup and tested according to ANSI C63.10 .
2. The EUT is placed on a turn table which is 1.5 meter above ground. The turn table is rotated 360 degrees to determine the position of the maximum emission level.
3. The EUT was positioned such that the distance from antenna to the EUT was 3 meters.
4. The antenna is scanned from 1 meter to 4 meters to find out the maximum emission level. This is repeated for both horizontal and vertical polarization of the antenna. In order to find the maximum emission, all of the interface cables were manipulated according to ANSI C63.10 on radiated measurement.
5. Use the following spectrum analyzer settings:
 - a) Span shall wide enough to fully capture the emission being measured
 - b) Set RBW=100kHz for <1GHz, VBW=3*RBW, Sweep time=auto, Detector=peak, Trace=max hold
 - c) Set RBW=1MHz, VBW=3MHz for >1GHz, Sweep time=auto, Detector=peak, Trace=max hold for Peak measurement

For average measurement: use duty cycle correction factor method (DCCF)
 Averager level = Peak level + DCCF

TEST MODE:

Please refer to the clause 4.3

TEST RESULT

Passed Not Applicable

Note:

- 1) Level= Reading + Factor; Factor =Antenna Factor+ Cable Loss- Preamp Factor
- 2) Over Limit = Level - Limit
- 3) Average measurement was not performed if peak level is lower than average limit(54 dBuV/m).

Test channel					CH00				
Frequency (MHz)	Read Level (dBuV)	Antenna Factor (dB/m)	Cable Loss (dB)	Preamp Factor (dB)	Level (dBuV/m)	Limit Line (dBuV/m)	Over Limit (dB)	Polarization	Test value
2310.00	34.51	27.96	7.73	38.17	32.03	74.00	-41.97	Vertical	Peak
2390.03	33.68	27.72	7.84	37.97	31.27	74.00	-42.73	Vertical	Peak
2310.00	34.38	27.96	7.73	38.17	31.90	74.00	-42.10	Horizontal	Peak
2390.03	33.34	27.72	7.84	37.97	30.93	74.00	-43.07	Horizontal	Peak

Test channel					CH78				
Frequency (MHz)	Read Level (dBuV)	Antenna Factor (dB/m)	Cable Loss (dB)	Preamp Factor (dB)	Level (dBuV/m)	Limit Line (dBuV/m)	Over Limit (dB)	Polarization	Test value
2483.50	33.83	27.43	8.04	37.59	31.71	74.00	-42.29	Vertical	Peak
2500.00	33.80	27.40	8.08	37.38	31.90	74.00	-42.10	Vertical	Peak
2483.50	34.69	27.43	8.04	37.59	32.57	74.00	-41.43	Horizontal	Peak
2500.00	34.52	27.40	8.08	37.38	32.62	74.00	-41.38	Horizontal	Peak

5.13. Radiated Spurious Emission

LIMIT

FCC CFR Title 47 Part 15 Subpart C Section 15.209

Frequency	Limit (dBuV/m)	Value
0.009 MHz ~0.49 MHz	2400/F(kHz) @300m	Quasi-peak
0.49 MHz ~ 1.705 MHz	24000/F(kHz) @30m	Quasi-peak
1.705 MHz ~30 MHz	30 @30m	Quasi-peak

Note: Limit dBuV/m @3m = Limit dBuV/m @300m + 40*log(300/3)= Limit dBuV/m @300m +80,

Limit dBuV/m @3m = Limit dBuV/m @30m +40*log(30/3)= Limit dBuV/m @30m + 40.

Frequency	Limit (dBuV/m @3m)	Value
30MHz~88MHz	40.00	Quasi-peak
88MHz~216MHz	43.50	Quasi-peak
216MHz~960MHz	46.00	Quasi-peak
960MHz~1GHz	54.00	Quasi-peak
Above 1GHz	54.00	Average
	74.00	Peak

TEST CONFIGURATION

- 9 kHz ~ 30 MHz

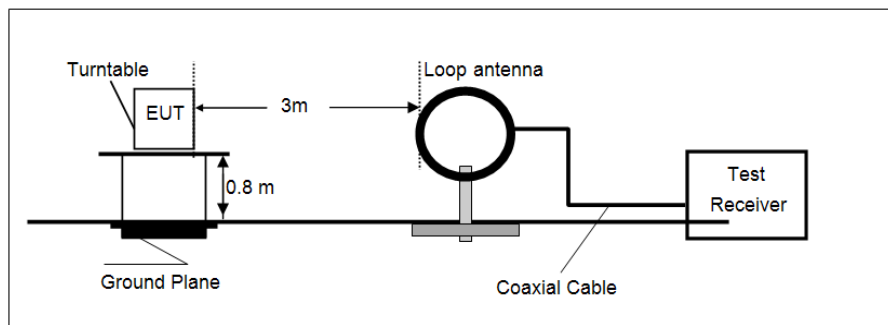

- 30 MHz ~ 1 GHz

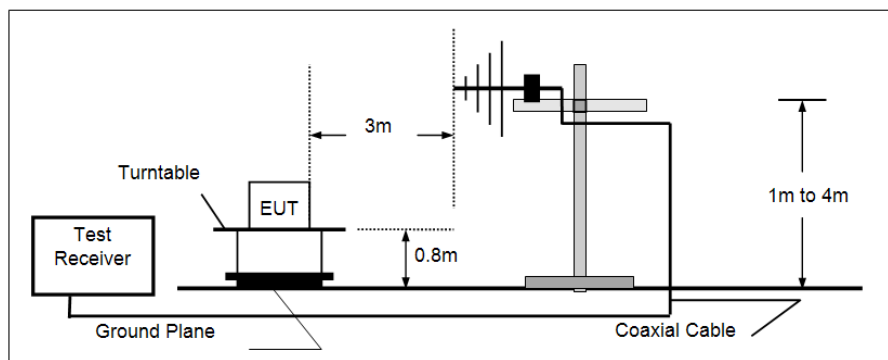

- Above 1 GHz

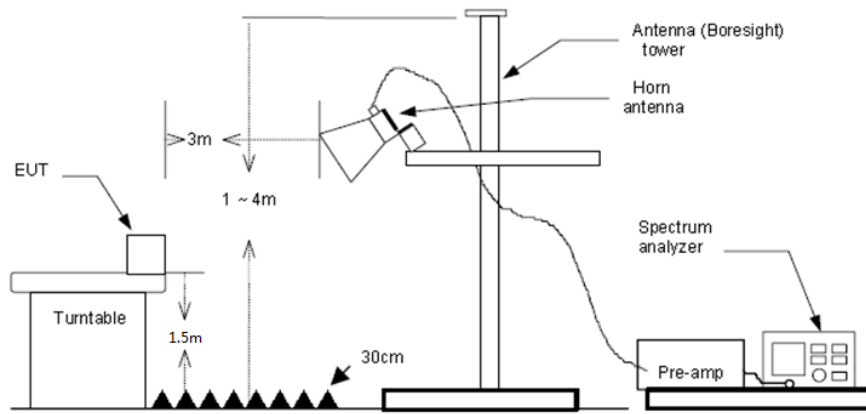

TEST PROCEDURE

1. The EUT was setup and tested according to ANSI C63.10 .
2. The EUT is placed on a turn table which is 0.8 meter above ground for below 1 GHz, and 1.5 m for above 1 GHz. The turn table is rotated 360 degrees to determine the position of the maximum emission level.
3. The EUT was set 3 meters from the receiving antenna, which was mounted on the top of a variable height antenna tower.
4. For each suspected emission, the EUT was arranged to its worst case and then tune the Antenna tower (from 1 m to 4 m) and turntable (from 0 degree to 360 degrees) to find the maximum reading. A pre-amp and a high pass filter are used for the test in order to get better signal level to comply with the guidelines.
5. Set to the maximum power setting and enable the EUT transmit continuously.
6. Use the following spectrum analyzer settings
 - a) Span shall wide enough to fully capture the emission being measured;
 - b) Below 1 GHz:
 - RBW=120 kHz, VBW=300 kHz, Sweep=auto, Detector function=peak, Trace=max hold;
 - If the emission level of the EUT measured by the peak detector is 3 dB lower than the applicable limit, the peak emission level will be reported. Otherwise, the emission measurement will be repeated using the quasi-peak detector and reported.
 - c) Set RBW=1MHz, VBW=3MHz for >1GHz, Sweep time=auto, Detector=peak, Trace=max hold for Peak measurement

For average measurement: use duty cycle correction factor method (DCCF)
 Averager level = Peak level + DCCF

TEST MODE:

Please refer to the clause 4.3

TEST RESULT

Passed **Not Applicable**

Note:

- 1) Above 1GHz Final Level = Read level + Antenna Factor + Cable Loss – Preamplifier Factor
- 2) Over Limit = Level - Limit
- 3) Average measurement was not performed if peak level is lower than average limit(54 dBuV/m) for above 1GHz.

TEST DATA FOR 9 kHz ~ 30 MHz

The EUT was pre-scanned this frequency band, found the radiated level 20dB lower than the limit, so don't show data on this report.

TEST DATA FOR 30 MHz ~ 1000 MHz

Have pre-scan all test channel, found CH39 which it was worst case, so only show the worst case's data on this report.

Polarization:

Horizontal

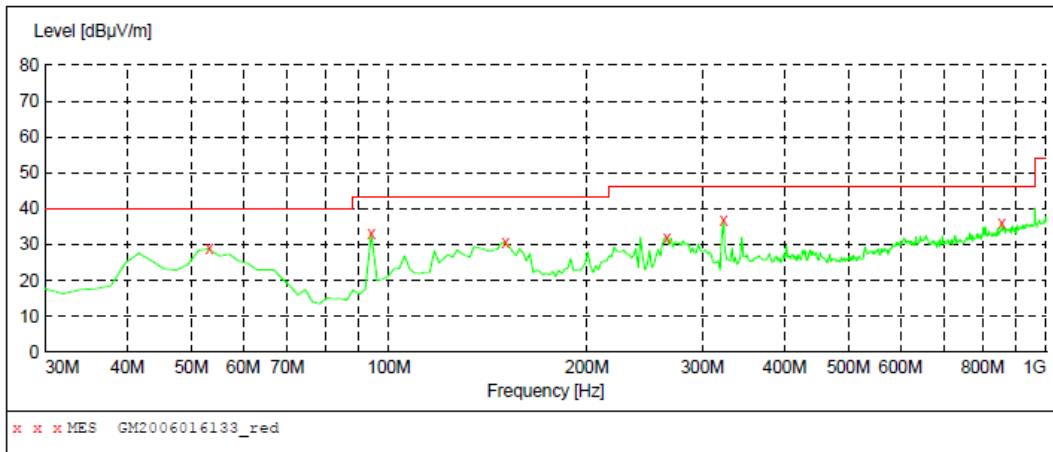

MEASUREMENT RESULT: "GM2006016133_red"

6/2/2020 12:48AM

Frequency MHz	Level dBµV/m	Transd dB	Limit dBµV/m	Margin dB	Det.	Height cm	Azimuth deg	Polarization
53.280000	28.90	-8.3	40.0	11.1	QP	300.0	295.00	HORIZONTAL
94.020000	33.10	-10.9	43.5	10.4	QP	300.0	260.00	HORIZONTAL
150.280000	30.60	-13.3	43.5	12.9	QP	100.0	127.00	HORIZONTAL
264.740000	32.00	-7.3	46.0	14.0	QP	100.0	155.00	HORIZONTAL
322.940000	36.70	-5.7	46.0	9.3	QP	100.0	0.00	HORIZONTAL
856.440000	36.10	6.9	46.0	9.9	QP	100.0	333.00	HORIZONTAL

Polarization:

Vertical

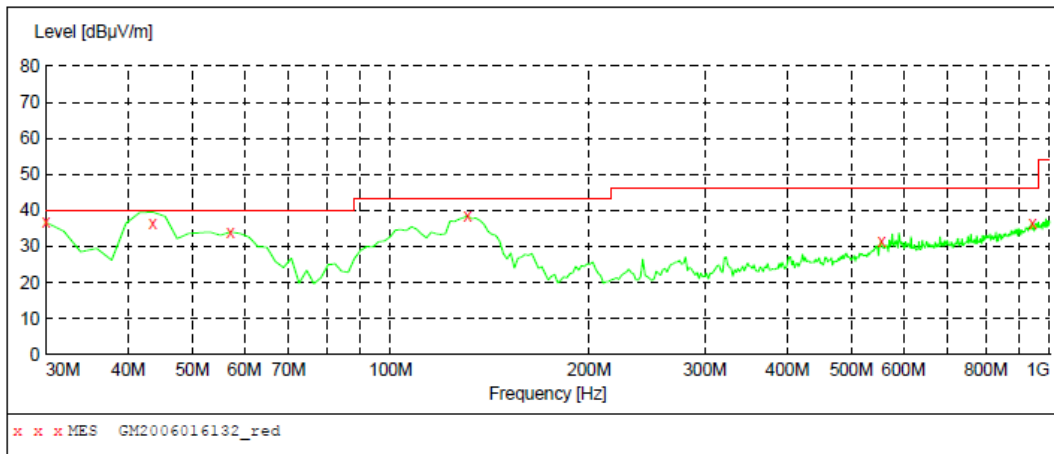

MEASUREMENT RESULT: "GM2006016132_red"

6/2/2020 12:44AM

Frequency MHz	Level dBµV/m	Transd dB	Limit dBµV/m	Margin dB	Det.	Height cm	Azimuth deg	Polarization
30.000000	36.80	-11.8	40.0	3.2	QP	100.0	272.00	VERTICAL
43.580000	36.60	-8.6	40.0	3.4	QP	100.0	89.00	VERTICAL
57.160000	34.10	-8.5	40.0	5.9	QP	100.0	357.00	VERTICAL
130.880000	38.60	-13.0	43.5	4.9	QP	100.0	206.00	VERTICAL
555.740000	31.40	0.7	46.0	14.6	QP	100.0	0.00	VERTICAL
941.800000	36.50	8.5	46.0	9.5	QP	100.0	156.00	VERTICAL

TEST DATA FOR 1 GHz ~ 25 GHz

Test channel					CH00				
Frequency (MHz)	Read Level (dBuV)	Antenna Factor (dB/m)	Cable Loss (dB)	Preamp Factor (dB)	Level (dBuV/m)	Limit Line (dBuV/m)	Over Limit (dB)	Polarization	Test value
1273.57	36.77	25.95	5.72	37.62	30.82	74.00	-43.18	Vertical	Peak
3200.50	34.93	28.90	9.44	37.40	35.87	74.00	-38.13	Vertical	Peak
5125.52	31.82	32.10	12.04	35.02	40.94	74.00	-33.06	Vertical	Peak
8063.40	31.41	37.20	15.69	34.35	49.95	74.00	-24.05	Vertical	Peak
1483.73	36.09	25.96	6.19	37.62	30.62	74.00	-43.38	Horizontal	Peak
3176.16	35.47	28.95	9.37	37.56	36.23	74.00	-37.77	Horizontal	Peak
5217.66	32.20	31.59	12.11	34.69	41.21	74.00	-32.79	Horizontal	Peak
8571.38	31.62	37.23	15.92	34.40	50.37	74.00	-23.63	Horizontal	Peak

Test channel					CH39				
Frequency (MHz)	Read Level (dBuV)	Antenna Factor (dB/m)	Cable Loss (dB)	Preamp Factor (dB)	Level (dBuV/m)	Limit Line (dBuV/m)	Over Limit (dB)	Polarization	Test value
1364.18	34.94	26.24	5.95	37.37	29.76	74.00	-44.24	Vertical	Peak
3112.13	36.21	29.00	9.19	37.70	36.70	74.00	-37.30	Vertical	Peak
4501.49	33.62	30.80	11.24	36.58	39.08	74.00	-34.92	Vertical	Peak
9204.60	32.33	38.82	15.95	35.87	51.23	74.00	-22.77	Vertical	Peak
1663.80	36.85	25.10	6.50	37.81	30.64	74.00	-43.36	Horizontal	Peak
3104.22	35.76	29.00	9.17	37.66	36.27	74.00	-37.73	Horizontal	Peak
5151.68	31.89	31.99	12.05	34.86	41.07	74.00	-32.93	Horizontal	Peak
8950.44	32.51	37.80	16.02	35.08	51.25	74.00	-22.75	Horizontal	Peak

Test channel					CH78				
Frequency (MHz)	Read Level (dBuV)	Antenna Factor (dB/m)	Cable Loss (dB)	Preamp Factor (dB)	Level (dBuV/m)	Limit Line (dBuV/m)	Over Limit (dB)	Polarization	Test value
1630.26	36.04	25.22	6.44	37.68	30.02	74.00	-43.98	Vertical	Peak
2839.61	35.01	28.56	8.91	35.97	36.51	74.00	-37.49	Vertical	Peak
5112.49	33.30	32.15	12.04	35.07	42.42	74.00	-31.58	Vertical	Peak
8063.40	31.49	37.20	15.69	34.35	50.03	74.00	-23.97	Vertical	Peak
1634.42	37.35	25.19	6.45	37.70	31.29	74.00	-42.71	Horizontal	Peak
3176.16	35.03	28.95	9.37	37.56	35.79	74.00	-38.21	Horizontal	Peak
5112.49	32.04	32.15	12.04	35.07	41.16	74.00	-32.84	Horizontal	Peak
7981.72	31.53	37.03	15.44	34.44	49.56	74.00	-24.44	Horizontal	Peak

6. TEST SETUP PHOTOS

Radiated Emission

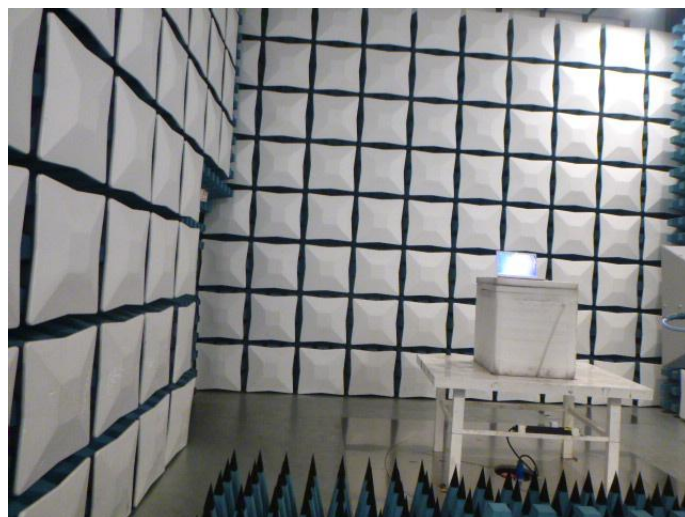

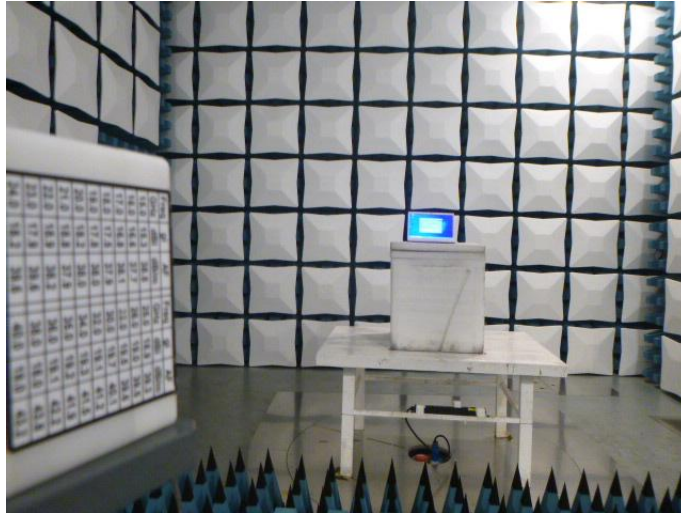

AC Conducted Emission

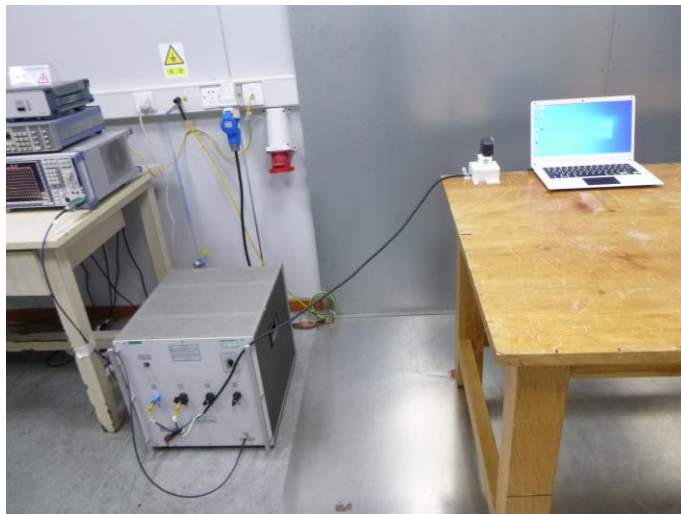

7. EXTERANAL AND INTERNAL PHOTOS

Reference to the test report No. : CHTEW20060006

8. APPENDIX REPORT

APPENDIX REPORT

Project No.	SHT2005070601EW	Radio Specification	Bluetooth EDR
Test sample No.	YPHT20050706001	Model No.	LO14WA1S
Start test date	2020/5/25	Finish date	2020/5/25
Temperature	25°C	Humidity	50%
Test Engineer	Jiongsheng.Feng	Auditor	<i>William.wang</i>

Appendix clause	Test item	Result
A	Peak Output Power	PASS
B	20 dB Bandwidth	PASS
C	99% Occupied Bandwidth	PASS
D	Carrier Frequencies Separation	PASS
E	Hopping Channel Number	PASS
F	Dwell Time	PASS
G	Duty Cycle Correction Factor (DCCF)	PASS
H	Band edge and Spurious Emissions(coducted)	PASS

Appendix A: Peak Output Power

Modulation type	Channel	Output power (dBm)	Average Output power (dBm)	Limit (dBm)	Result
GFSK	00	-5.77	-6.62	≤ 30.00	Pass
	39	-6.28	-7.10		
	78	-6.87	-7.74		
π/4DQPSK	00	-4.83	-5.94	≤ 21.00	Pass
	39	-5.12	-6.05		
	78	-5.52	-6.48		
8DPSK	00	-4.75	-5.68	≤ 21.00	Pass
	39	-5.00	-6.05		
	78	-5.46	-6.32		

Modulation Type: GFSK

CH00

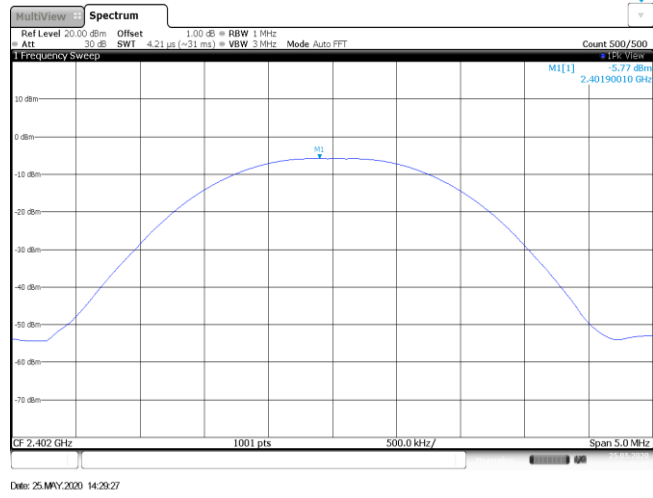

CH39

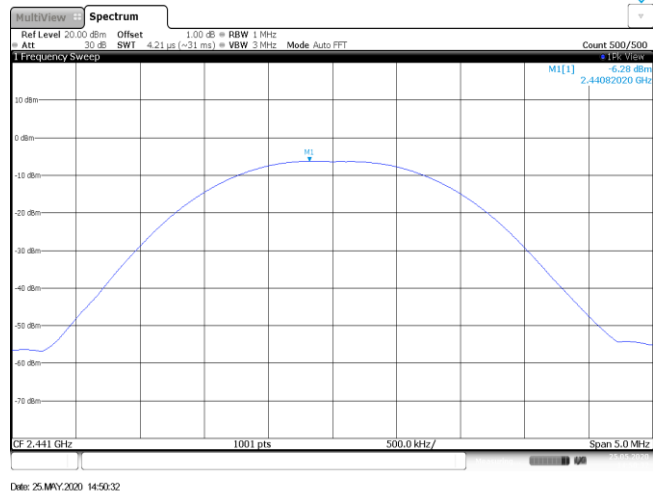

CH78

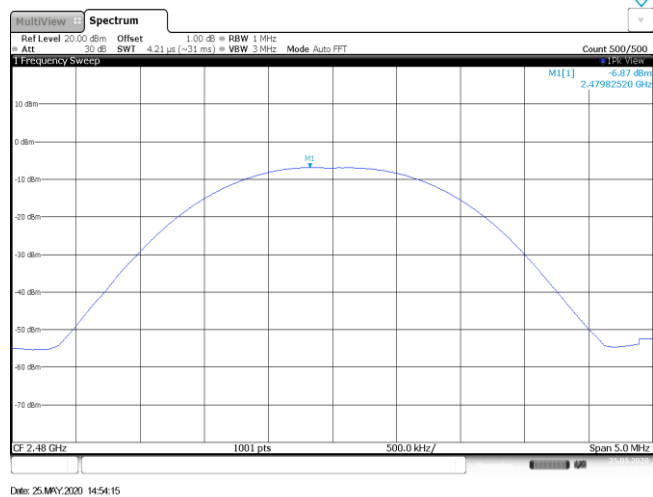

Modulation Type: $\pi/4$ DQPSK

CH00

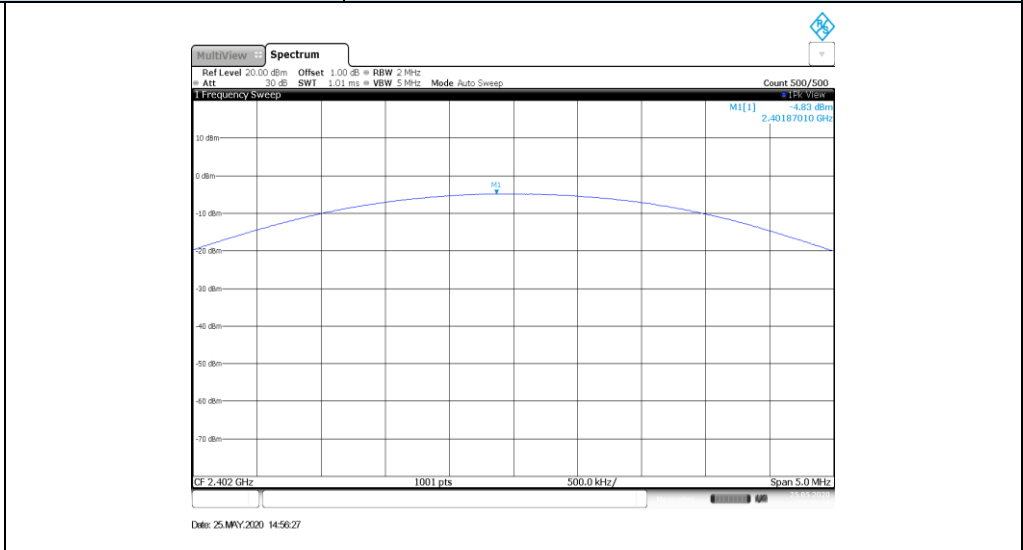

CH39

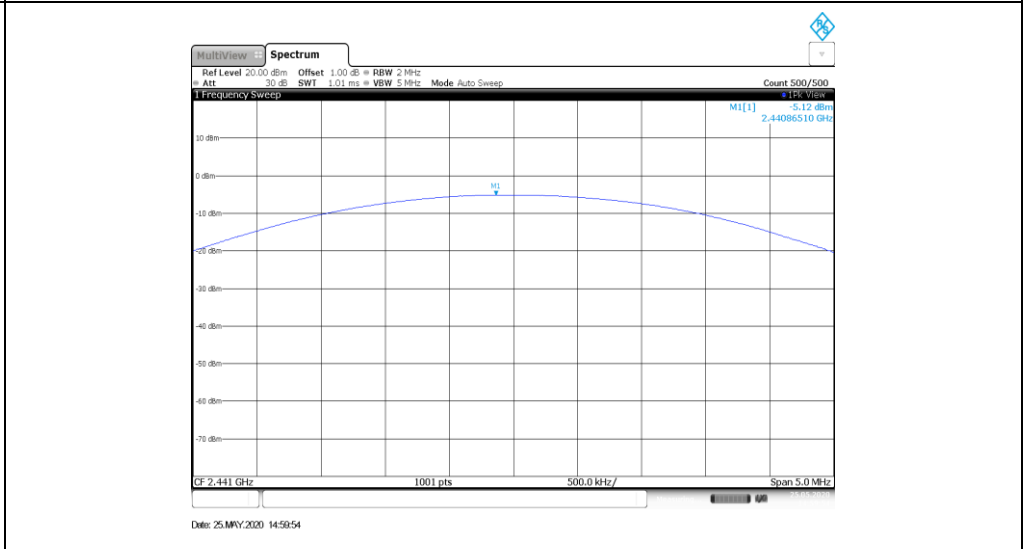

CH78

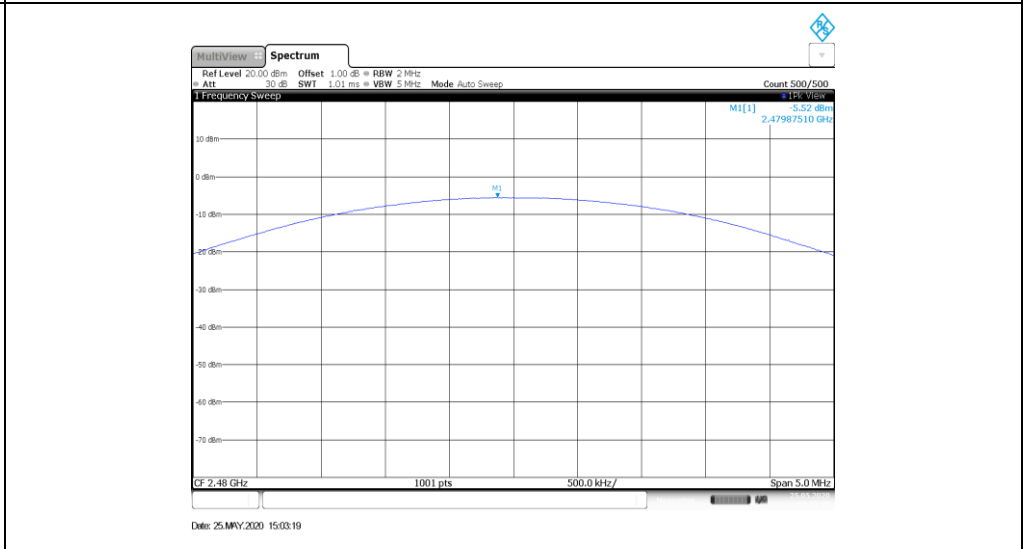

Modulation Type: 8DPSK

CH00

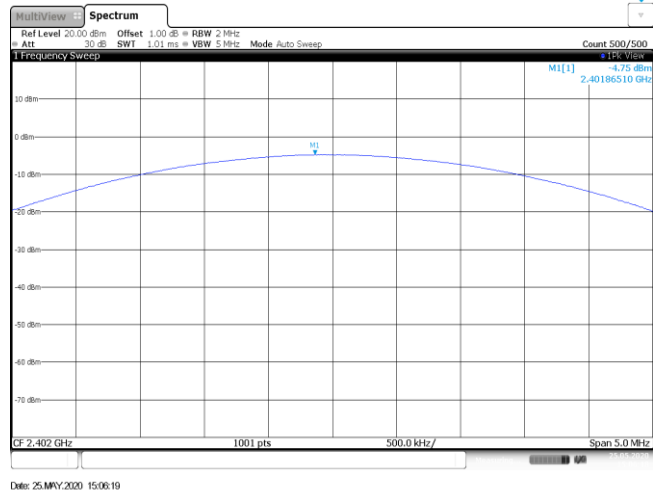

CH39

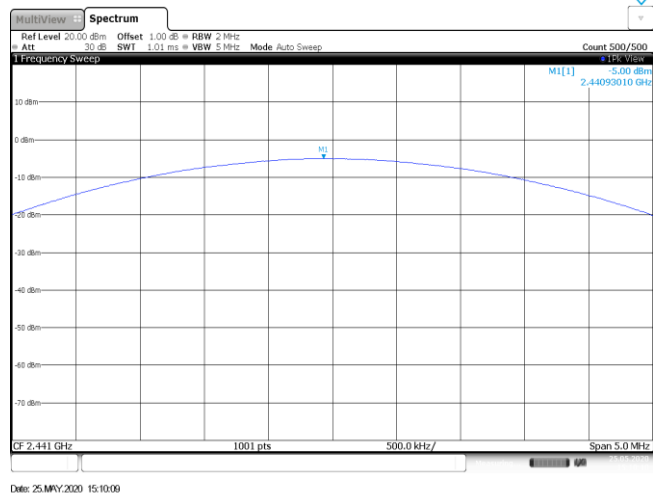

CH78

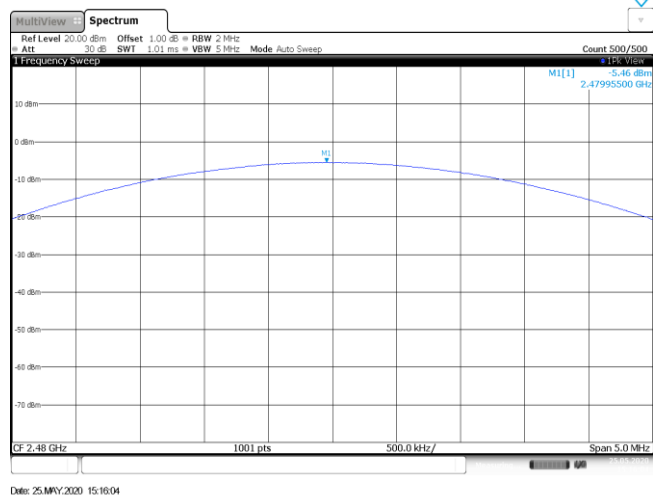

Appendix B : 20 dB Bandwidth

Modulation type	Channel	20 dB Bandwidth (kHz)	Limit (kHz)	Result
GFSK	00	786.70	-	Pass
	39	784.20		
	78	784.20		
$\pi/4$ DQPSK	00	1372.50	-	Pass
	39	1372.50		
	78	1375.00		
8DPSK	00	1327.50	-	Pass
	39	1327.50		
	78	1332.50		

Modulation Type: GFSK

CH00

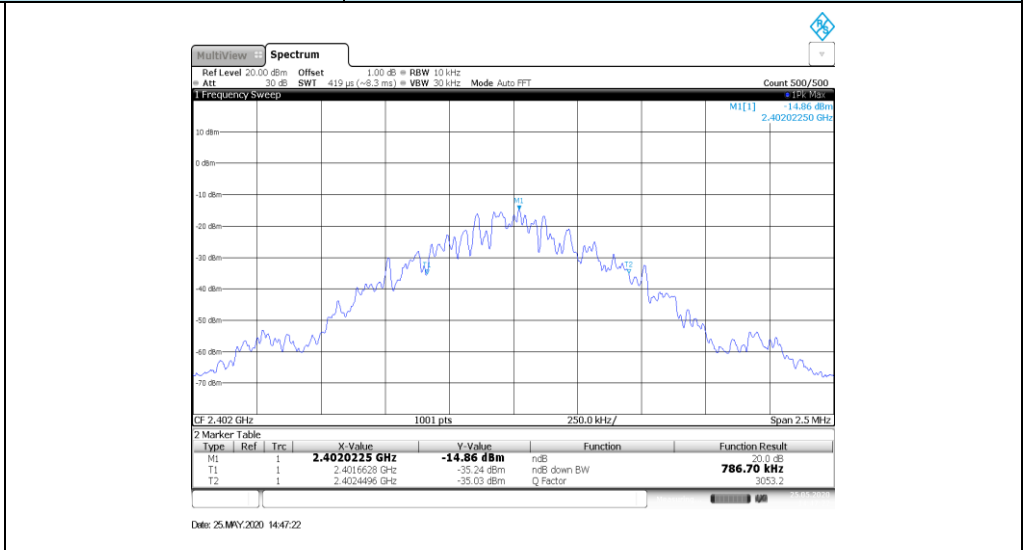

CH39

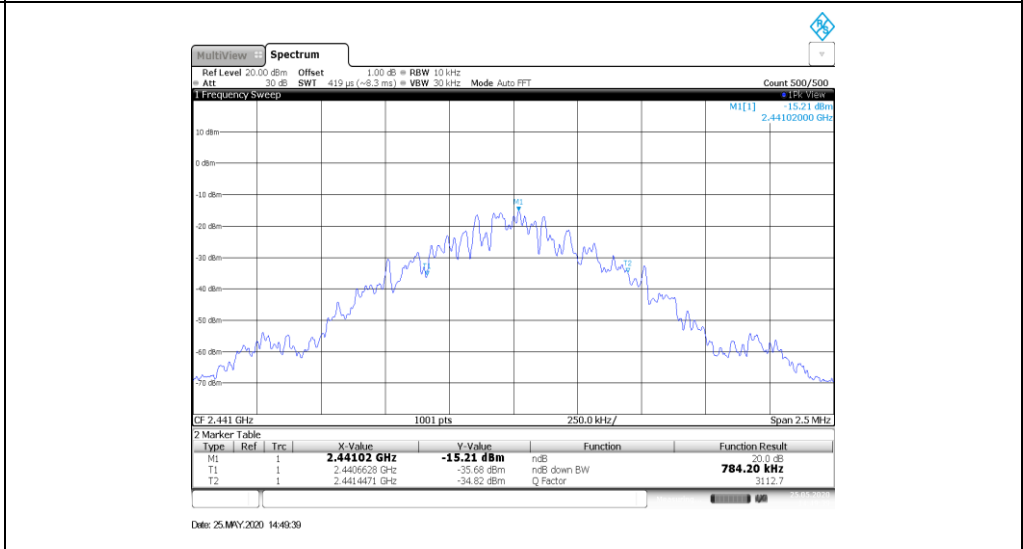

CH78

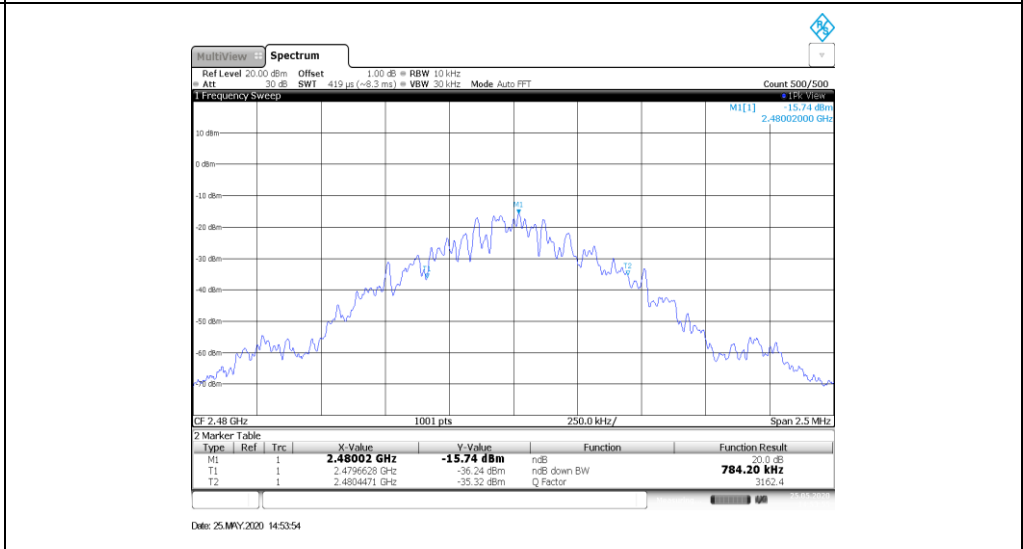

Modulation Type: **$\pi/4$ DQPSK**

CH00

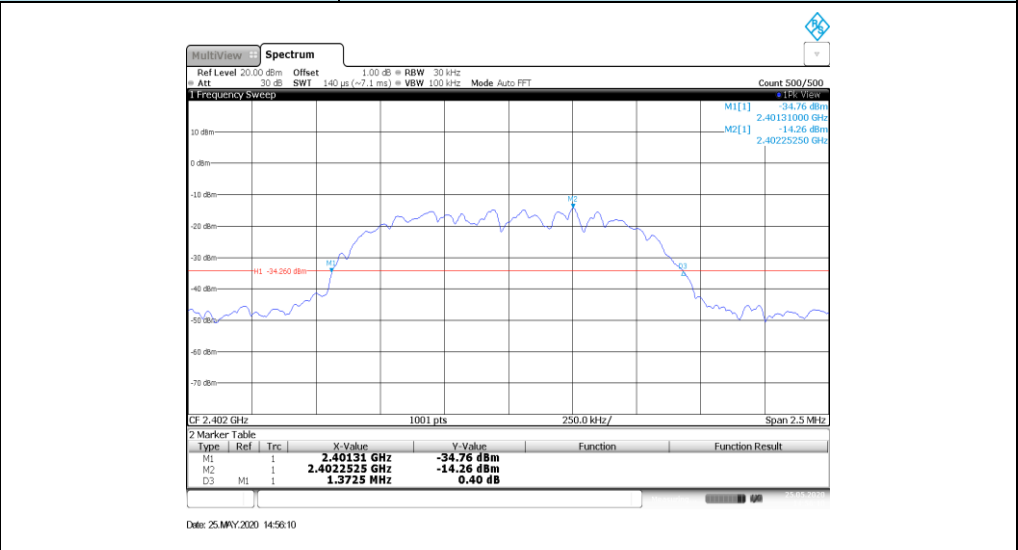

CH39

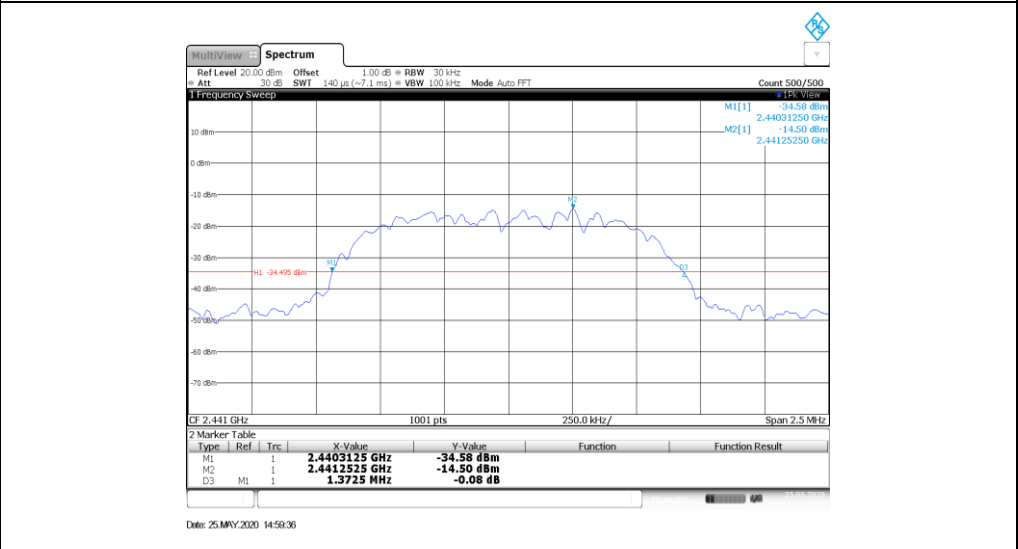

CH78

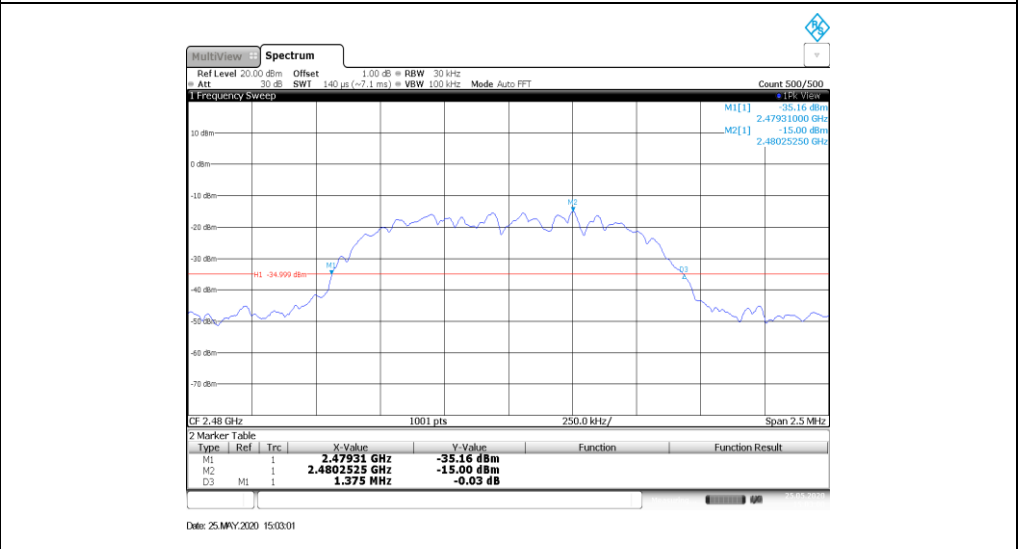

Modulation Type: 8DPSK

CH00

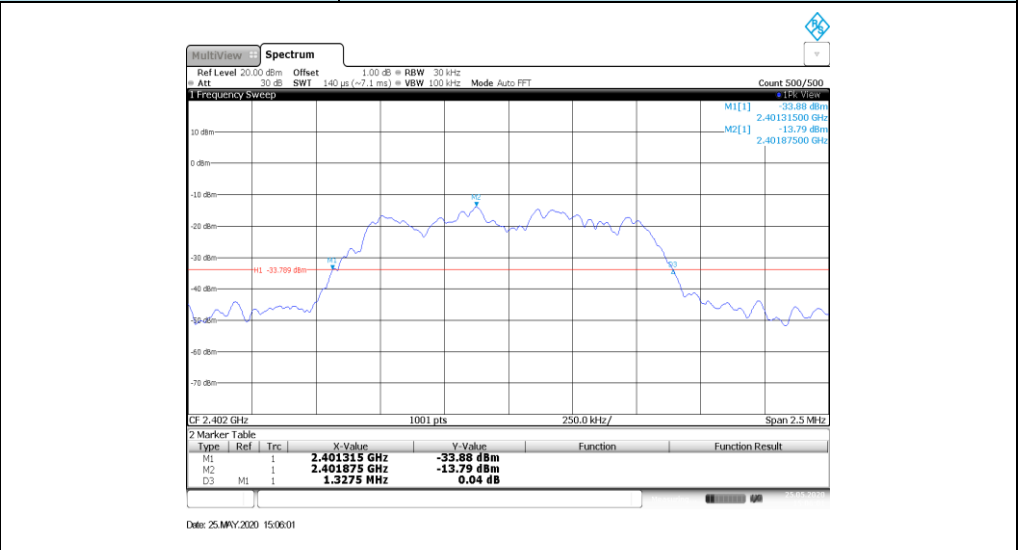

CH39

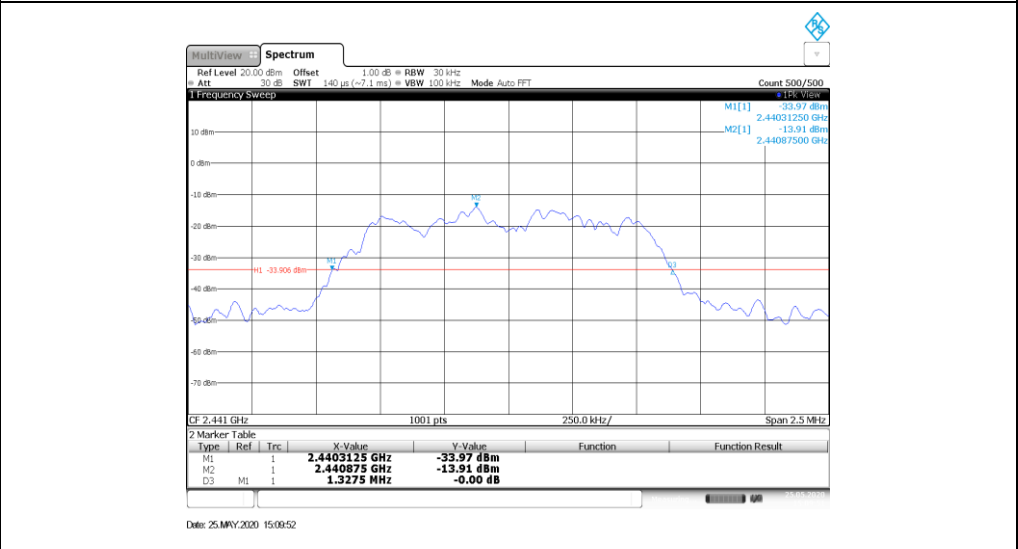

CH78

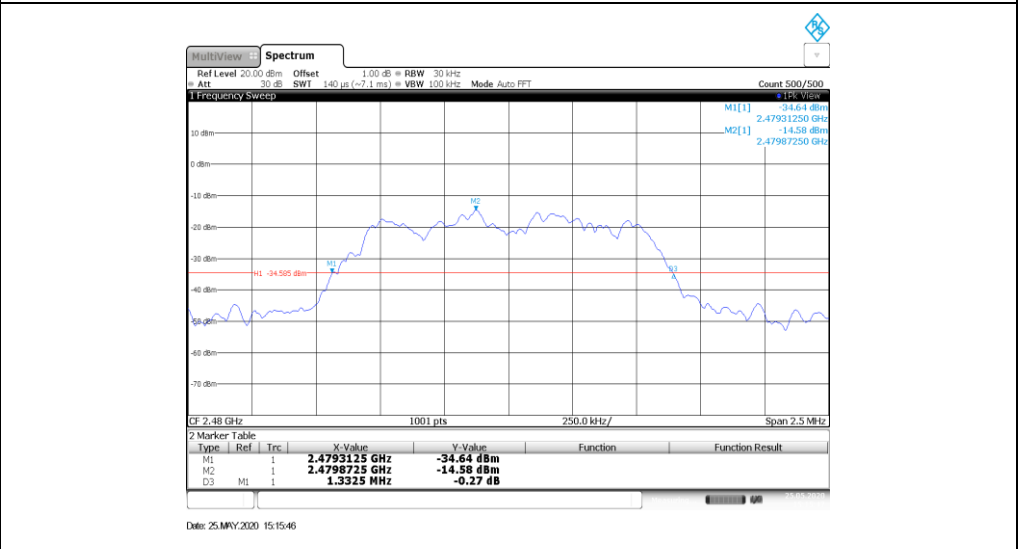

Appendix C: 99% Occupied Bandwidth

Modulation type	Channel	99% Occupied Bandwidth (MHz)	Limit (MHz)	Result
GFSK	00	0.93	-	Pass
	39	0.93		
	78	0.94		
$\pi/4$ DQPSK	00	1.21	-	Pass
	39	1.21		
	78	1.21		
8DPSK	00	1.20	-	Pass
	39	1.20		
	78	1.20		

Modulation Type: GFSK

CH00

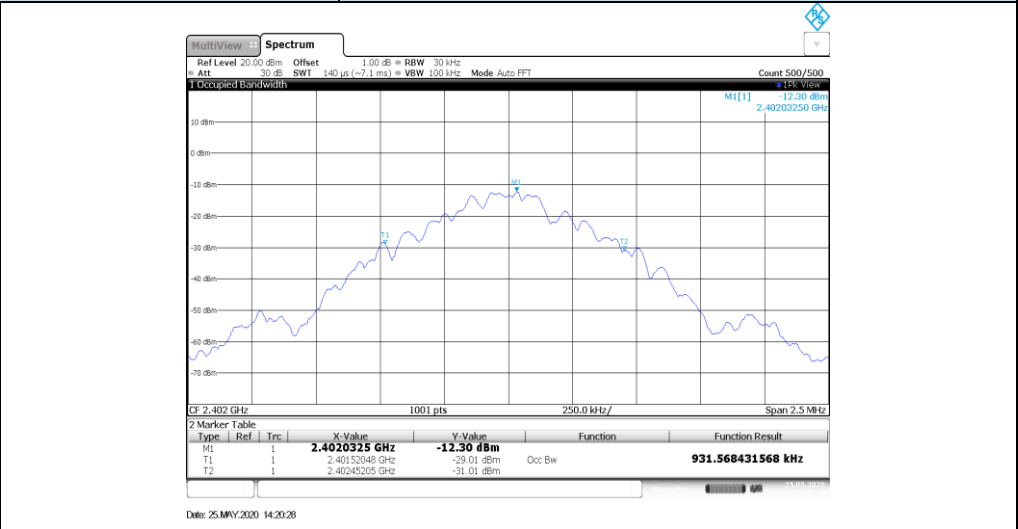

CH39

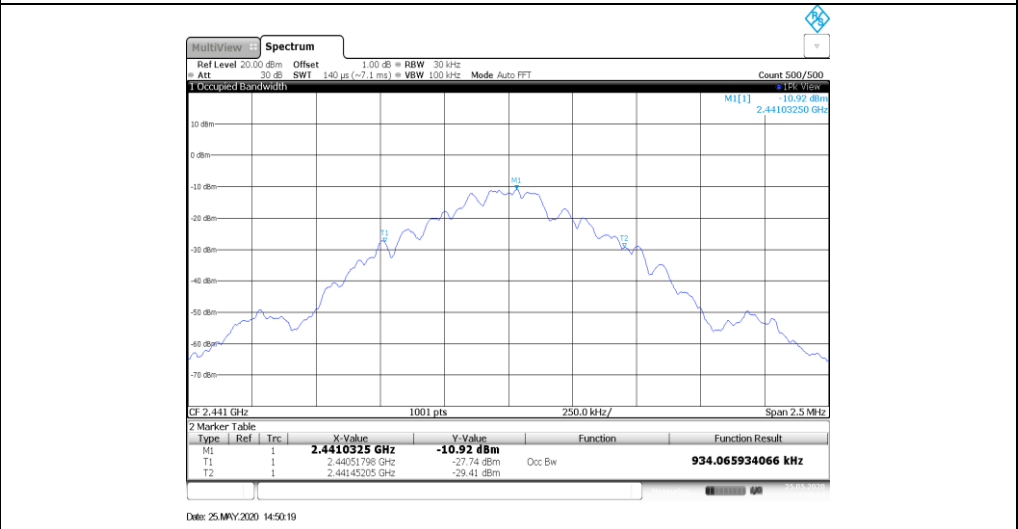

CH78

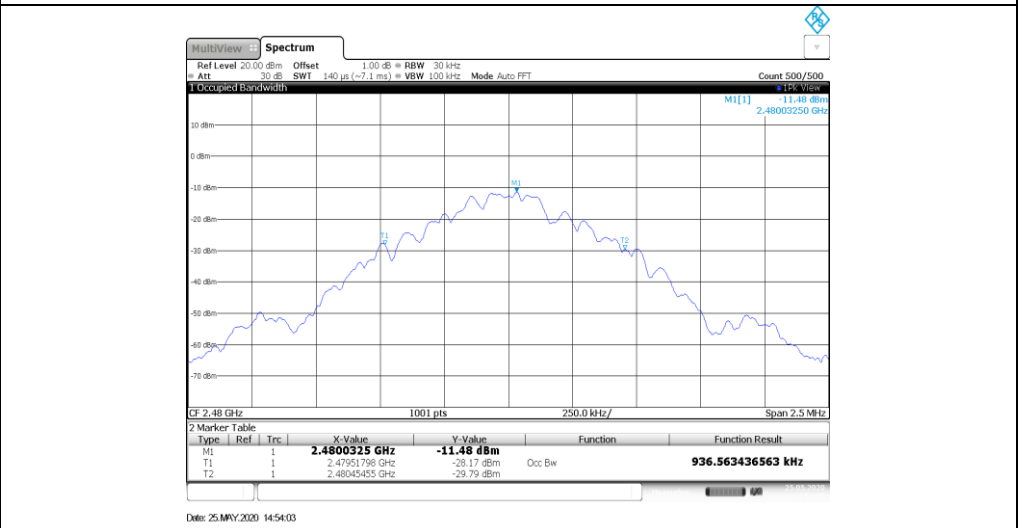

Modulation Type: $\pi/4$ QPSK

CH00

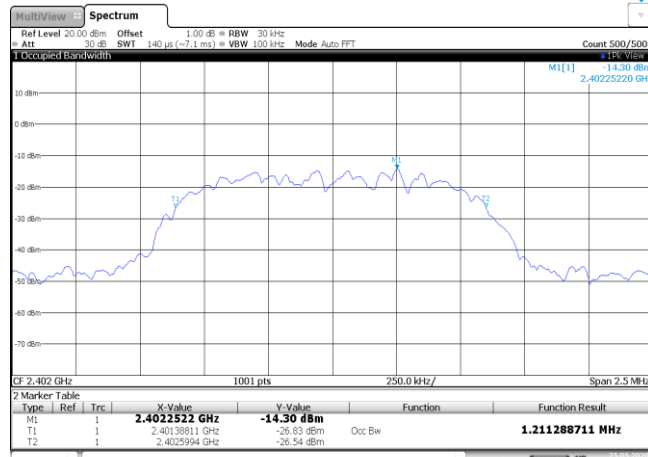

Date: 25.MAY.2010 14:56:18

CH39

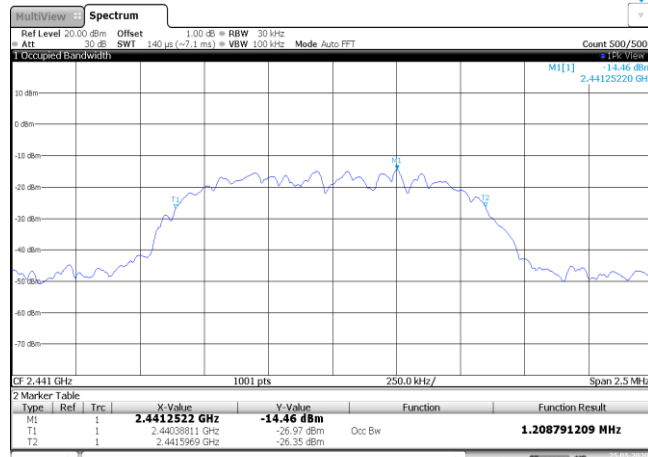

Date: 25.MAY.2010 14:50:44

CH78

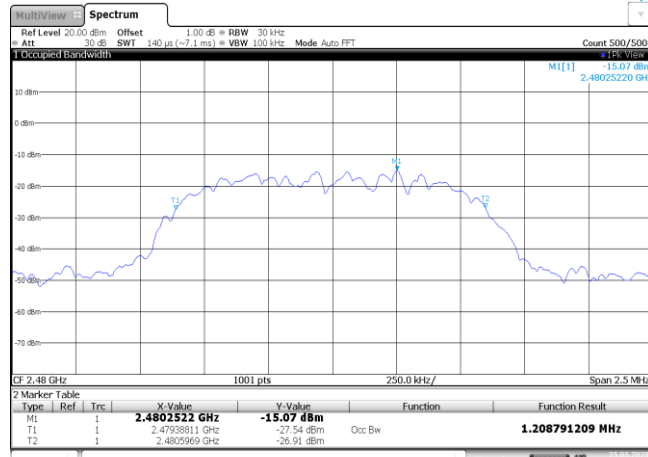

Date: 25.MAY.2010 15:03:09

Modulation Type: 8DPSK

CH00

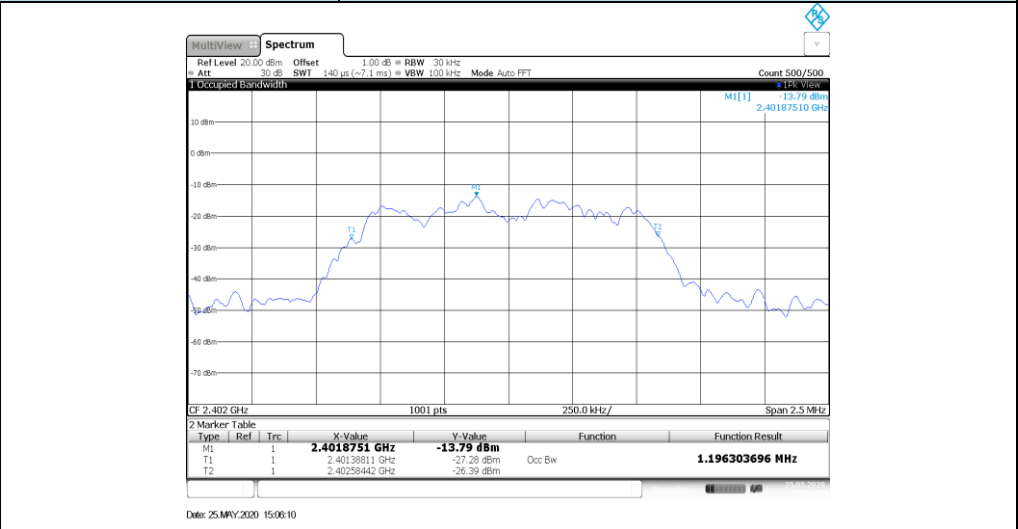

CH39

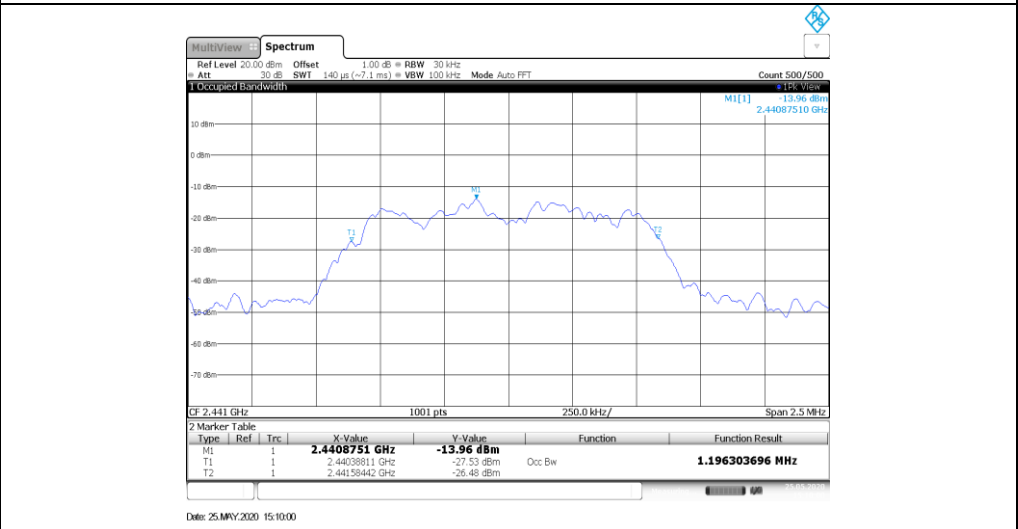

CH78

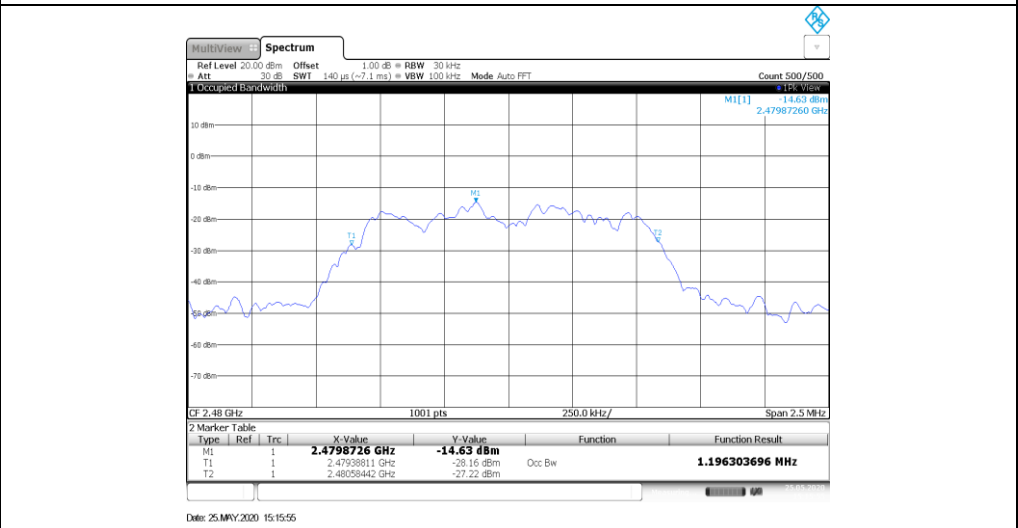

Appendix D: Carrier Frequencies Separation

Modulation type	Channel	Carrier Frequencies Separation (MHz)	Limit (kHz) *	Result
GFSK	39	1.00	≥786.70	Pass
π/4DQPSK	39	1.00	≥916.67	Pass
8DPSK	39	1.00	≥888.33	Pass

Note:

*: GFSK limit = The maximum 20 dB Bandwidth for GFSK modulation on the appendix B.

π/4DQPSK limit = 2/3 * The maximum 20 dB Bandwidth for π/4DQPSK modulation on the appendix B.

8DPSK limit = 2/3 * The maximum 20 dB Bandwidth for 8DPSK modulation on the appendix B

<p>GFSK</p>	
<p>$\pi/4$DQPSK</p>	
<p>8DPSK</p>	

Appendix E: Hopping Channel Number

Modulation type	Channel number	Limit	Result
GFSK	79	≥15.00	Pass
π/4DQPSK	79		
8DPSK	79		

GFSK

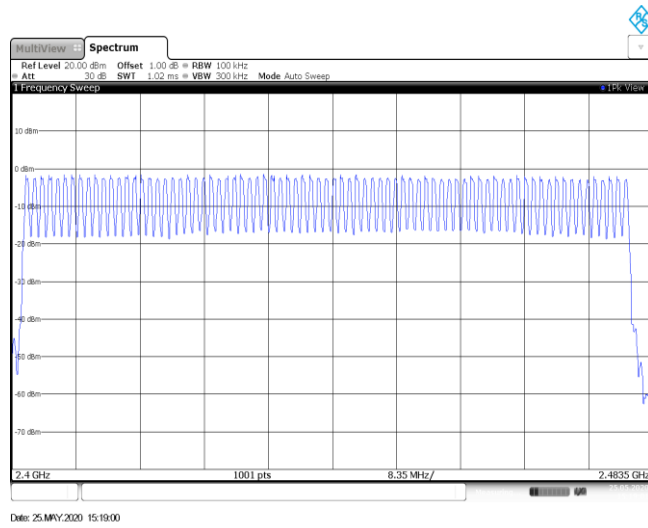

$\pi/4$ DQPSK

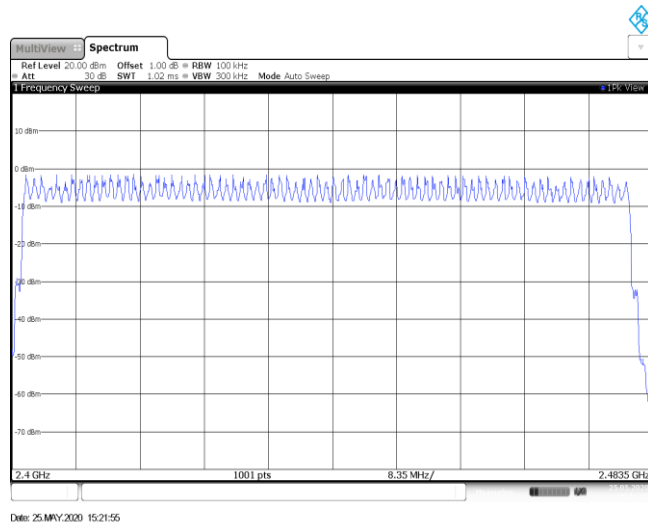

8DPSK

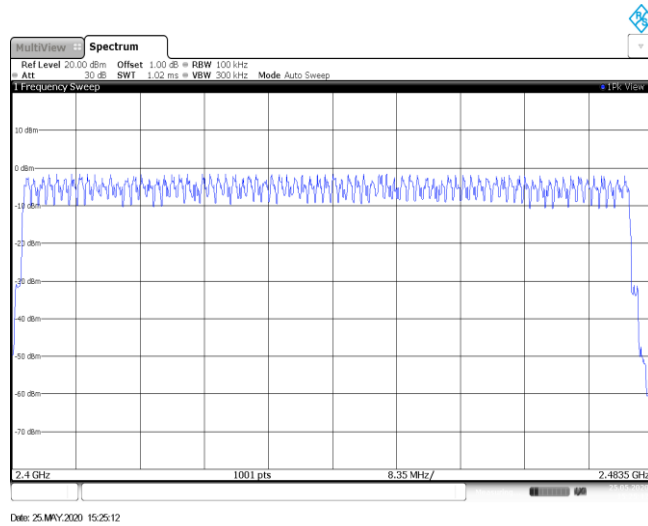

Appendix F: Dwell Time

Modulation type	Packet	Burst Width [ms]	Total Hops[hop*ch]	Dwell time (Second)	Limit (Second)	Result
GFSK	DH1	0.39	316	0.12	≤ 0.40	Pass
	DH3	1.65	158	0.26		
	DH5	2.90	112	0.33		
π/4DQPSK	2DH1	0.40	314	0.13	≤ 0.40	Pass
	2DH3	1.66	160	0.27		
	2DH5	2.90	121	0.35		
8DPSK	3DH1	0.40	316	0.13	≤ 0.40	Pass
	3DH3	1.65	161	0.27		
	3DH5	2.90	106	0.31		

Modulation Type: GFSK	
DH1 Burst width	
DH1 Burst number	
DH3 Burst width	

DH3
Burst number

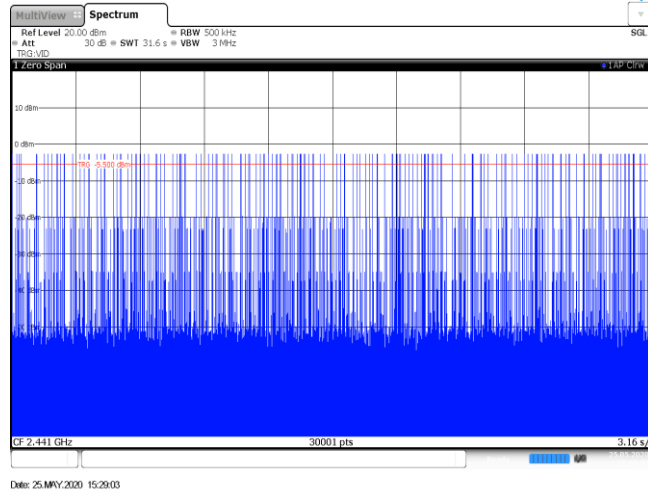

DH5
Burst width

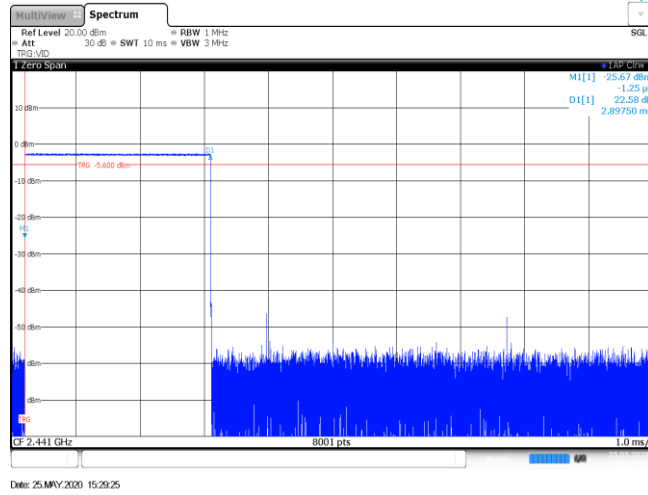

DH5
Burst number

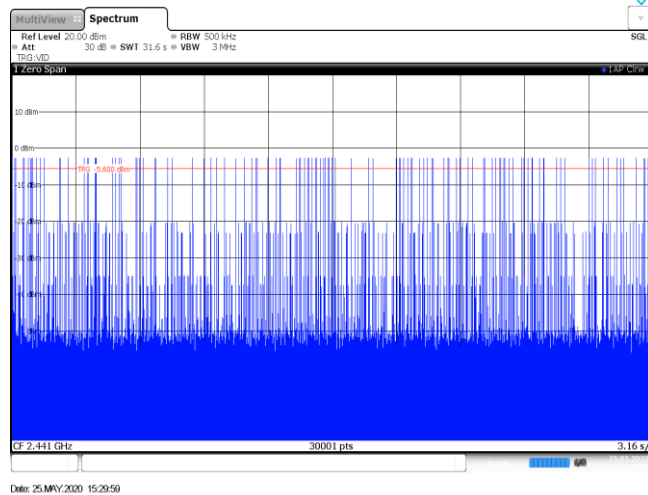

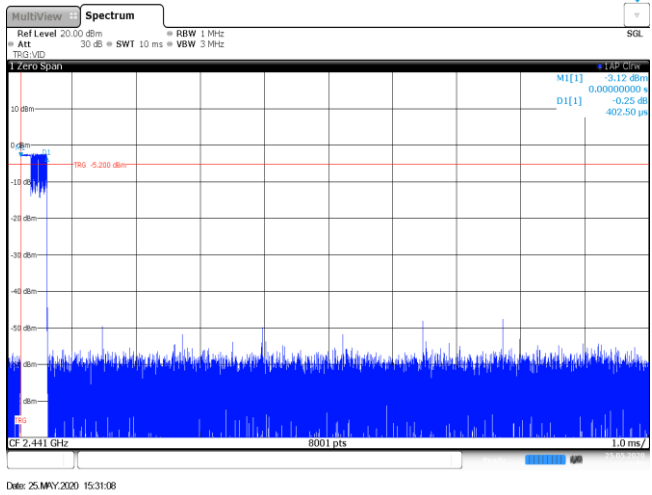
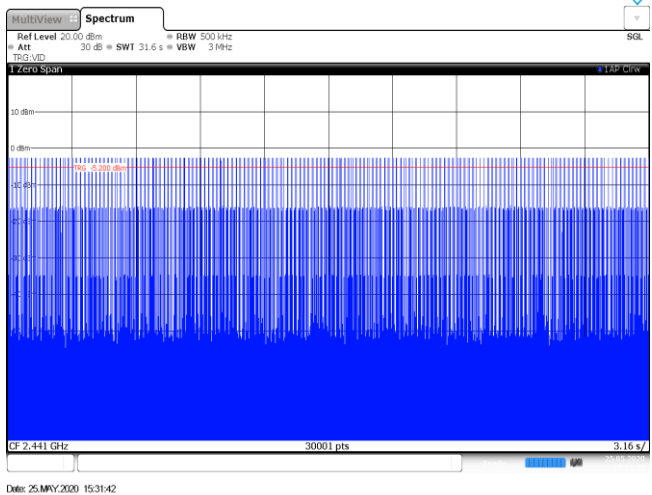
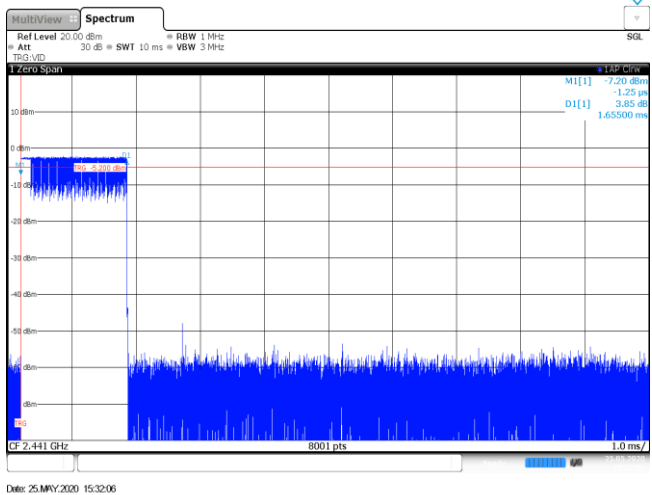
Modulation Type:	$\pi/4$ DQPSK
<p>2DH1 Burst width</p>	 <p>The spectrum plot shows a signal burst at 2.441 GHz. The y-axis represents power in dBm, ranging from -60 to 10. The x-axis represents frequency in MHz, with a 1.0 ms time scale. A red horizontal line indicates a threshold at -5.000 dBm. The signal peak is at approximately -1.25 dBm. The plot shows a sharp peak at the carrier frequency, followed by a rapid decay into the noise floor. The noise floor is around -50 dBm. The plot is titled 'Spectrum' and includes parameters: Ref Level 20.00 dBm, Att 30 dB, SWT 10 ms, RBW 1 MHz, VBW 3 MHz. The date is 25.MAY.2020 15:31:08.</p>
<p>2DH1 Burst number</p>	 <p>The spectrum plot shows a continuous signal burst at 2.441 GHz. The y-axis represents power in dBm, ranging from -60 to 10. The x-axis represents frequency in MHz, with a 3.16 s time scale. A red horizontal line indicates a threshold at -5.000 dBm. The signal is a dense, continuous line of blue vertical bars, indicating a long burst of data. The plot is titled 'Spectrum' and includes parameters: Ref Level 20.00 dBm, Att 30 dB, SWT 31.6 s, RBW 500 kHz, VBW 3 MHz. The date is 25.MAY.2020 15:31:42.</p>
<p>2DH3 Burst width</p>	 <p>The spectrum plot shows a signal burst at 2.441 GHz. The y-axis represents power in dBm, ranging from -60 to 10. The x-axis represents frequency in MHz, with a 1.0 ms time scale. A red horizontal line indicates a threshold at -5.000 dBm. The signal peak is at approximately -1.25 dBm. The plot shows a sharp peak at the carrier frequency, followed by a rapid decay into the noise floor. The noise floor is around -50 dBm. The plot is titled 'Spectrum' and includes parameters: Ref Level 20.00 dBm, Att 30 dB, SWT 10 ms, RBW 1 MHz, VBW 3 MHz. The date is 25.MAY.2020 15:32:06.</p>

2DH3
Burst number

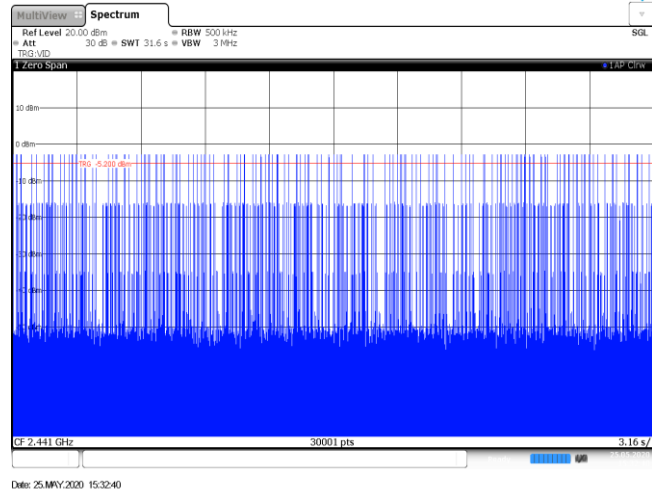

2DH5
Burst width

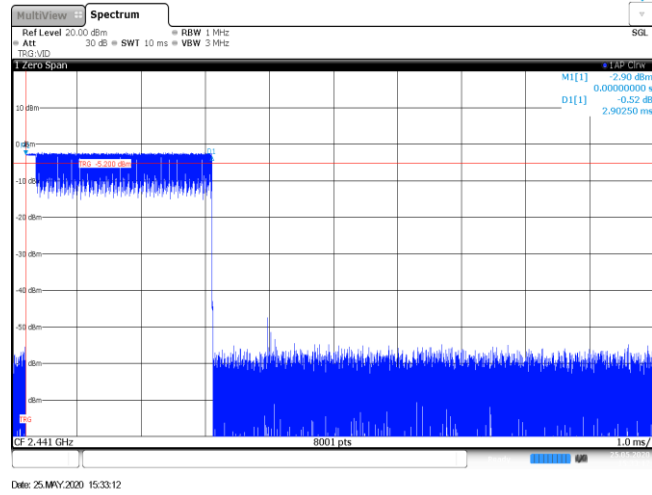

2DH5
Burst number

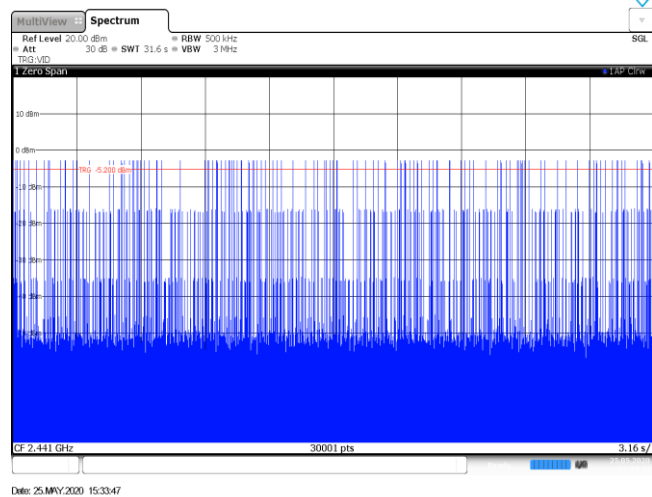

Modulation Type: 8DPSK

3DH1
Burst width

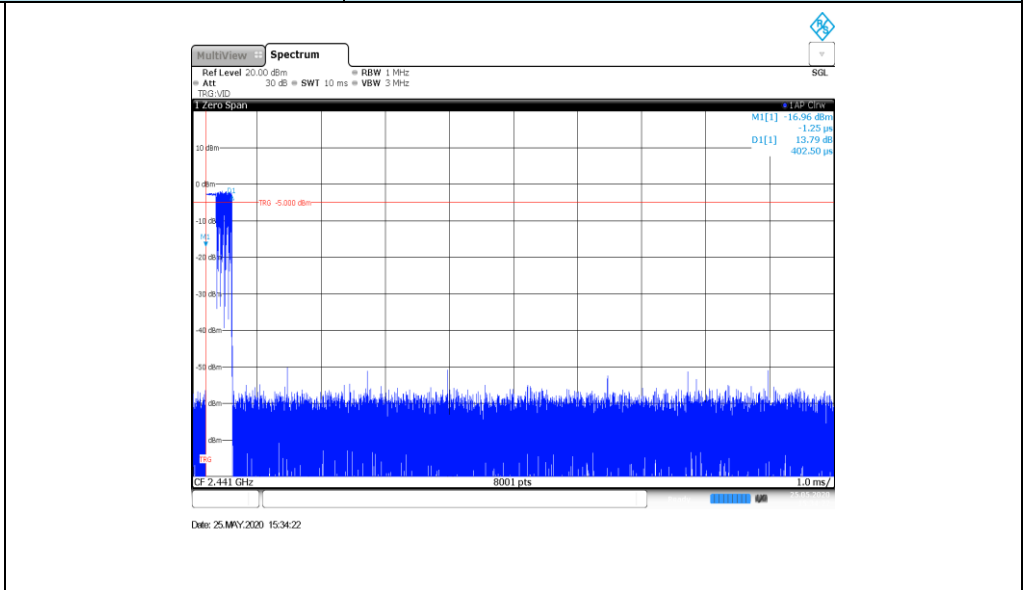

3DH1
Burst number

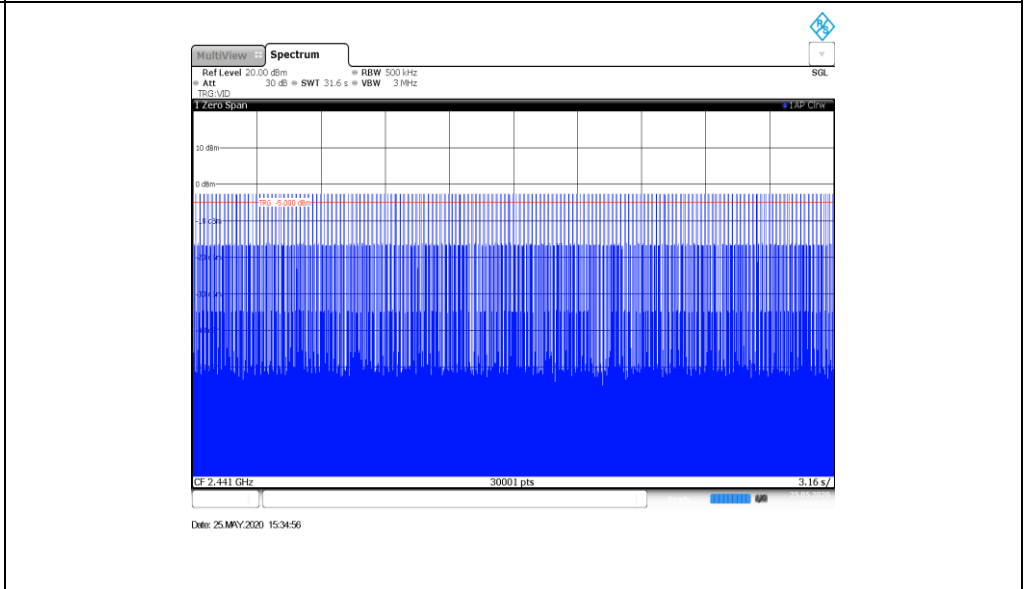

3DH3
Burst width

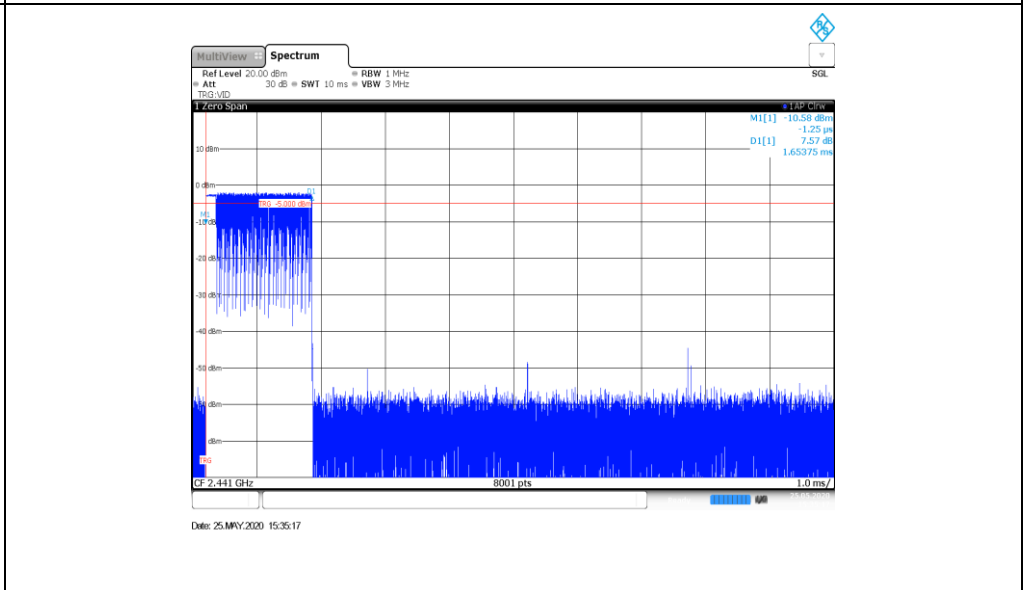

3DH3
Burst number

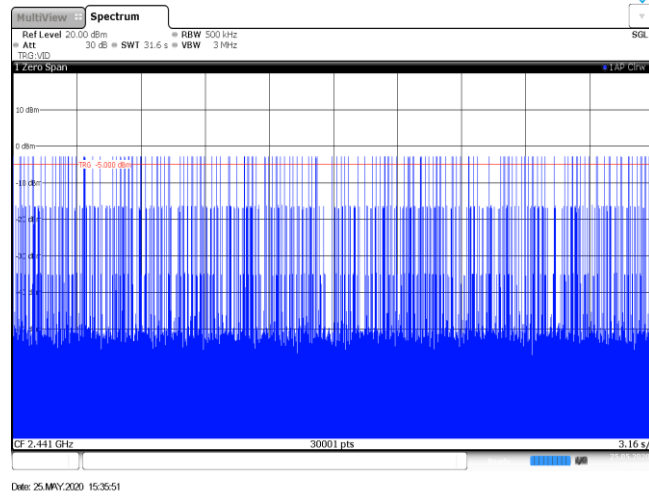

3DH5
Burst width

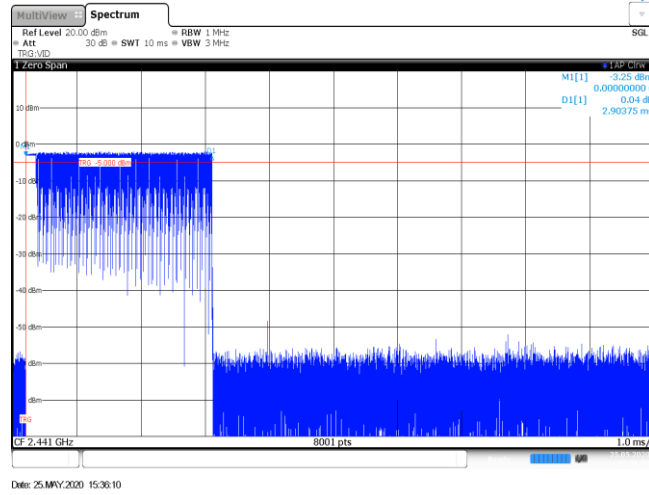

3DH5
Burst number

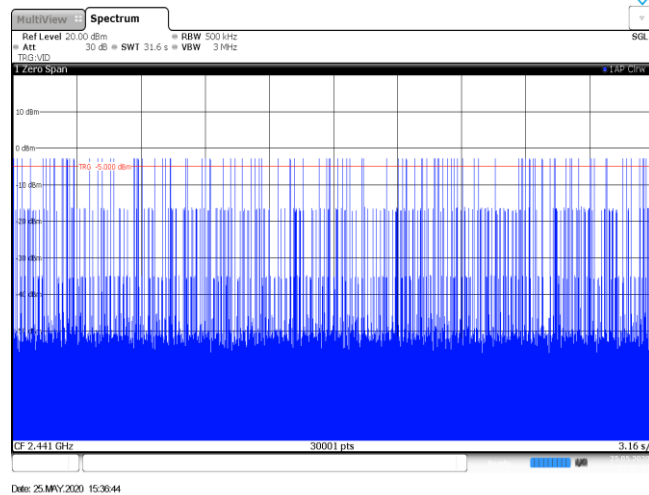

Appendix G: Duty Cycle Correction Factor (DCCF)**DCCF Calculate Formula**

$$\text{DCCF} = 20 * \text{Log}(\text{duty cycle}) = 20 * \text{Log}(T_{\text{on time}} / T_{\text{period}})$$

Modulation type	Test Frequency (MHz)	T _{on time} for single burst [ms]	T _{period} [ms]	Burst Quantity	DCCF [dB]
GFSK	2441	1.00	100	2.00	-33.98
$\pi/4$ DQPSK	2441	1.00	100	1.00	-40.00
8DPSK	2441	1.00	100	1.00	-40.00

GFSK

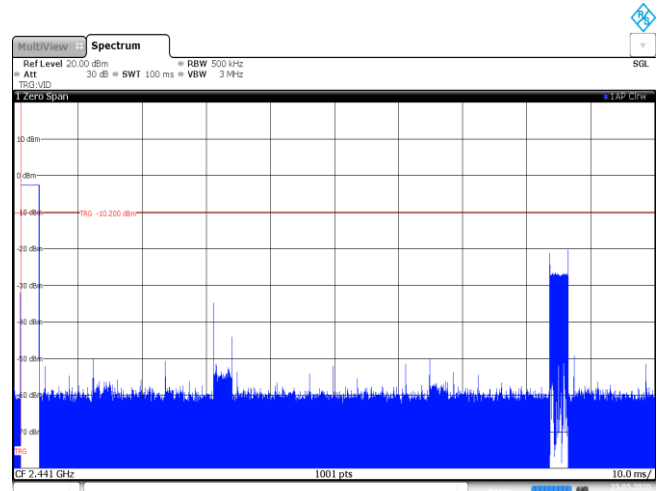
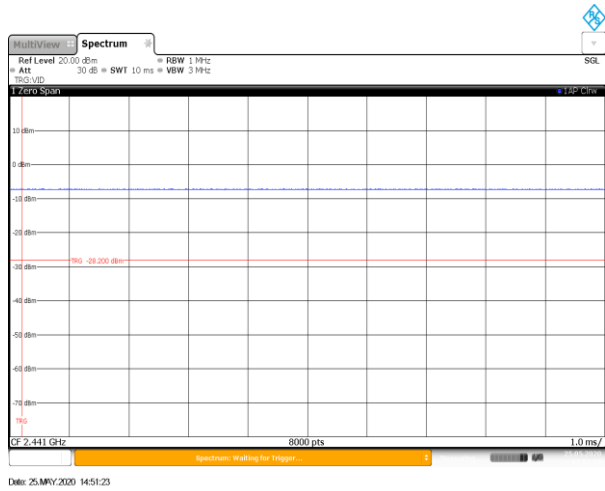

T_{on} time for single burst

Burst Quantity

$\pi/4$ DQPSK

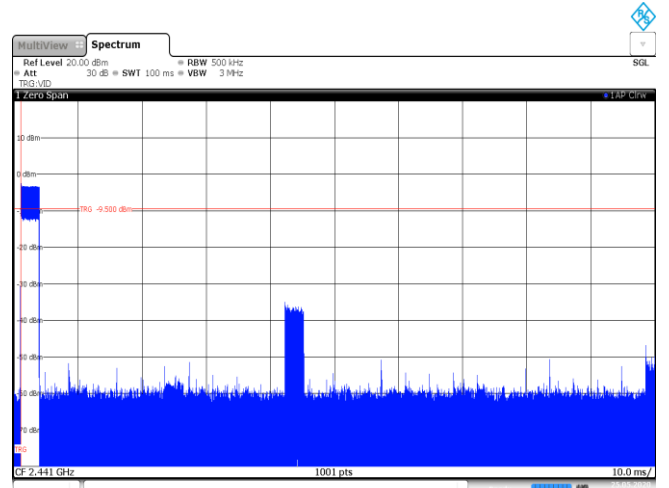
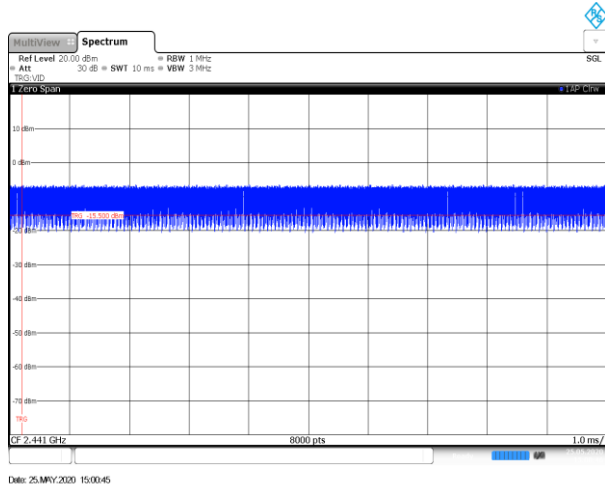

T_{on} time for single burst

Burst Quantity

8DPSK

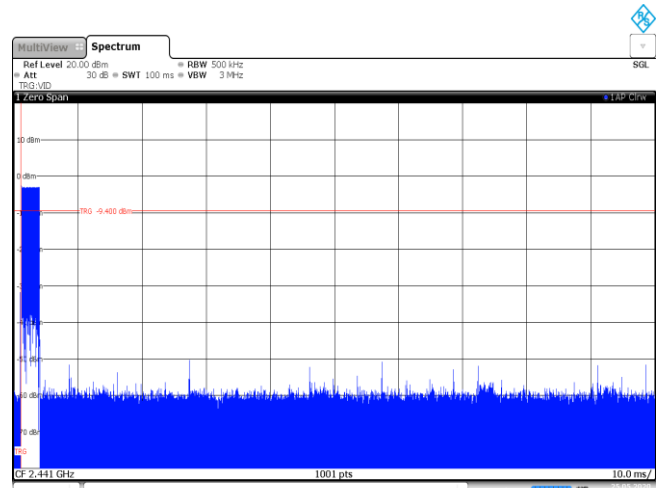
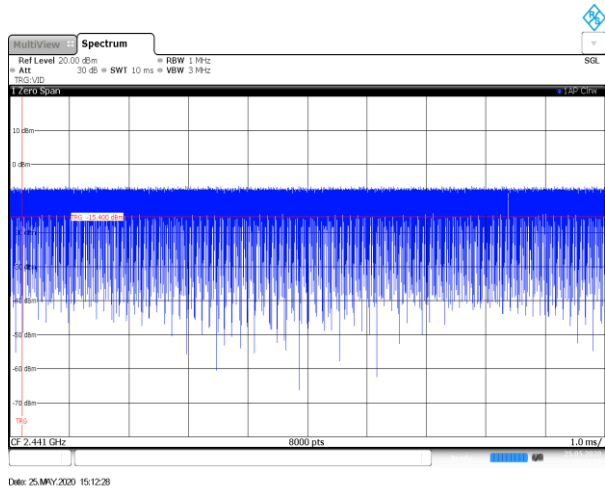

T_{on} time for single burst

Burst Quantity

Appendix H: Band edge and Spurious Emissions (conducted)

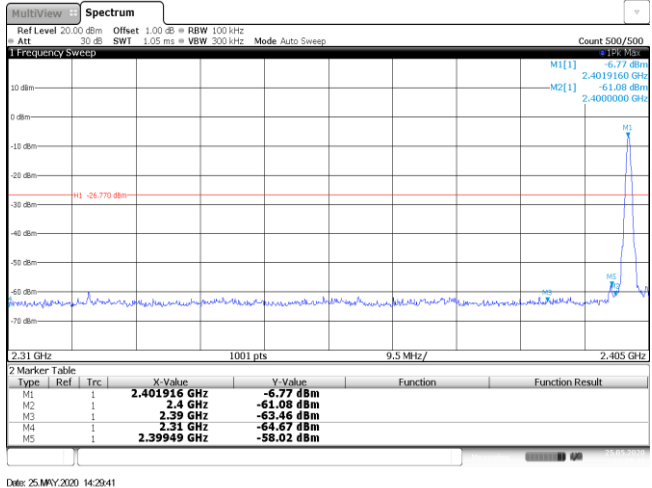
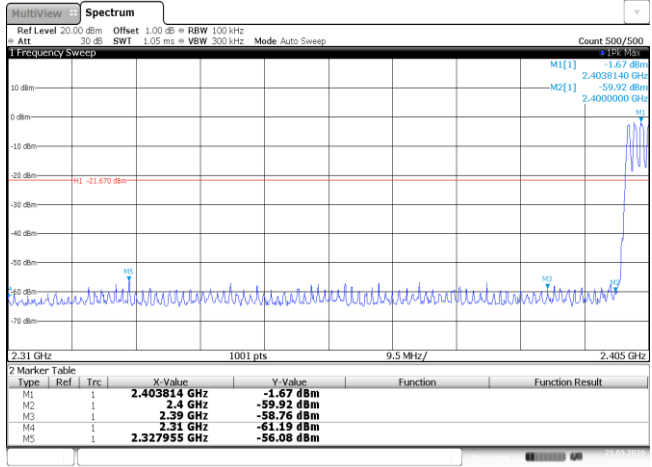
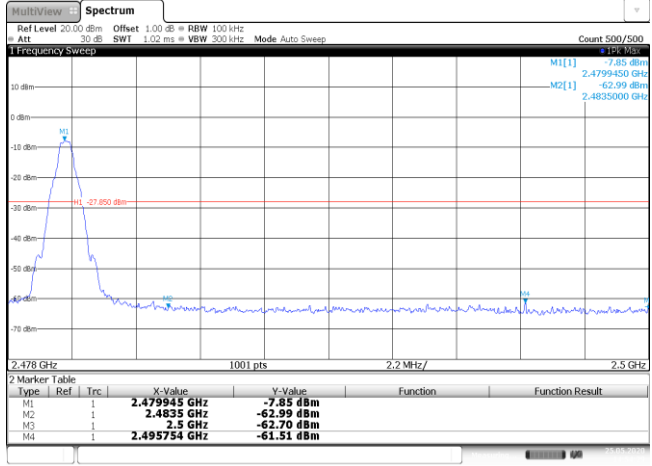
Test Item:	Band edge	Modulation type:	GFSK																																										
<p>CH00 No hopping mode</p>	 <p>2 Marker Table</p> <table border="1"> <thead> <tr> <th>Type</th> <th>Ref</th> <th>Trc</th> <th>X-Value</th> <th>Y-Value</th> <th>Function</th> <th>Function Result</th> </tr> </thead> <tbody> <tr> <td>M1</td> <td>1</td> <td></td> <td>2.401916 GHz</td> <td>-6.77 dBm</td> <td></td> <td></td> </tr> <tr> <td>M2</td> <td>1</td> <td></td> <td>2.4 GHz</td> <td>-61.08 dBm</td> <td></td> <td></td> </tr> <tr> <td>M3</td> <td>1</td> <td></td> <td>2.39 GHz</td> <td>-63.46 dBm</td> <td></td> <td></td> </tr> <tr> <td>M4</td> <td>1</td> <td></td> <td>2.31 GHz</td> <td>-64.67 dBm</td> <td></td> <td></td> </tr> <tr> <td>M5</td> <td>1</td> <td></td> <td>2.39949 GHz</td> <td>-58.02 dBm</td> <td></td> <td></td> </tr> </tbody> </table> <p>Date: 25.MAY.2020 14:29:41</p>			Type	Ref	Trc	X-Value	Y-Value	Function	Function Result	M1	1		2.401916 GHz	-6.77 dBm			M2	1		2.4 GHz	-61.08 dBm			M3	1		2.39 GHz	-63.46 dBm			M4	1		2.31 GHz	-64.67 dBm			M5	1		2.39949 GHz	-58.02 dBm		
Type	Ref	Trc	X-Value	Y-Value	Function	Function Result																																							
M1	1		2.401916 GHz	-6.77 dBm																																									
M2	1		2.4 GHz	-61.08 dBm																																									
M3	1		2.39 GHz	-63.46 dBm																																									
M4	1		2.31 GHz	-64.67 dBm																																									
M5	1		2.39949 GHz	-58.02 dBm																																									
<p>CH00 Hopping mode</p>	 <p>2 Marker Table</p> <table border="1"> <thead> <tr> <th>Type</th> <th>Ref</th> <th>Trc</th> <th>X-Value</th> <th>Y-Value</th> <th>Function</th> <th>Function Result</th> </tr> </thead> <tbody> <tr> <td>M1</td> <td>1</td> <td></td> <td>2.403814 GHz</td> <td>-1.67 dBm</td> <td></td> <td></td> </tr> <tr> <td>M2</td> <td>1</td> <td></td> <td>2.4 GHz</td> <td>-59.92 dBm</td> <td></td> <td></td> </tr> <tr> <td>M3</td> <td>1</td> <td></td> <td>2.39 GHz</td> <td>-58.76 dBm</td> <td></td> <td></td> </tr> <tr> <td>M4</td> <td>1</td> <td></td> <td>2.31 GHz</td> <td>-61.19 dBm</td> <td></td> <td></td> </tr> <tr> <td>M5</td> <td>1</td> <td></td> <td>2.327955 GHz</td> <td>-56.08 dBm</td> <td></td> <td></td> </tr> </tbody> </table> <p>Date: 25.MAY.2020 15:19:19</p>			Type	Ref	Trc	X-Value	Y-Value	Function	Function Result	M1	1		2.403814 GHz	-1.67 dBm			M2	1		2.4 GHz	-59.92 dBm			M3	1		2.39 GHz	-58.76 dBm			M4	1		2.31 GHz	-61.19 dBm			M5	1		2.327955 GHz	-56.08 dBm		
Type	Ref	Trc	X-Value	Y-Value	Function	Function Result																																							
M1	1		2.403814 GHz	-1.67 dBm																																									
M2	1		2.4 GHz	-59.92 dBm																																									
M3	1		2.39 GHz	-58.76 dBm																																									
M4	1		2.31 GHz	-61.19 dBm																																									
M5	1		2.327955 GHz	-56.08 dBm																																									
<p>CH78 No hopping mode</p>	 <p>2 Marker Table</p> <table border="1"> <thead> <tr> <th>Type</th> <th>Ref</th> <th>Trc</th> <th>X-Value</th> <th>Y-Value</th> <th>Function</th> <th>Function Result</th> </tr> </thead> <tbody> <tr> <td>M1</td> <td>1</td> <td></td> <td>2.479945 GHz</td> <td>-7.85 dBm</td> <td></td> <td></td> </tr> <tr> <td>M2</td> <td>1</td> <td></td> <td>2.479450 GHz</td> <td>-62.99 dBm</td> <td></td> <td></td> </tr> <tr> <td>M3</td> <td>1</td> <td></td> <td>2.5 GHz</td> <td>-62.70 dBm</td> <td></td> <td></td> </tr> <tr> <td>M4</td> <td>1</td> <td></td> <td>2.495754 GHz</td> <td>-61.51 dBm</td> <td></td> <td></td> </tr> </tbody> </table> <p>Date: 25.MAY.2020 14:54:29</p>			Type	Ref	Trc	X-Value	Y-Value	Function	Function Result	M1	1		2.479945 GHz	-7.85 dBm			M2	1		2.479450 GHz	-62.99 dBm			M3	1		2.5 GHz	-62.70 dBm			M4	1		2.495754 GHz	-61.51 dBm									
Type	Ref	Trc	X-Value	Y-Value	Function	Function Result																																							
M1	1		2.479945 GHz	-7.85 dBm																																									
M2	1		2.479450 GHz	-62.99 dBm																																									
M3	1		2.5 GHz	-62.70 dBm																																									
M4	1		2.495754 GHz	-61.51 dBm																																									

CH78
Hopping mode

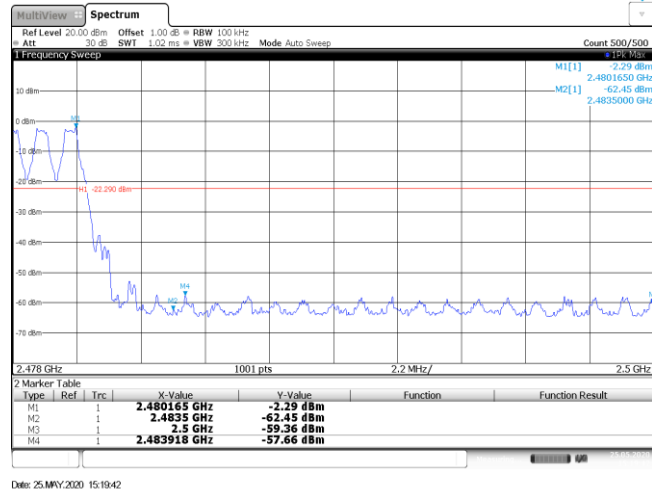

Test Item:	Band edge	Modulation type:	$\pi/4$DQPSK
-------------------	------------------	-------------------------	--------------------------------

CH00
No hopping mode

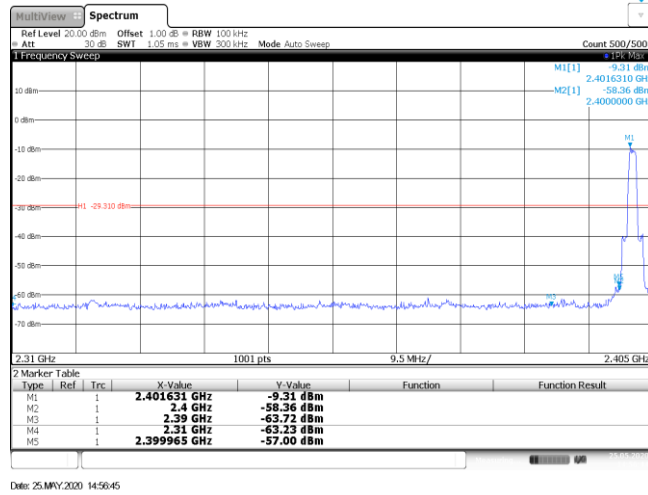

CH00
Hopping mode

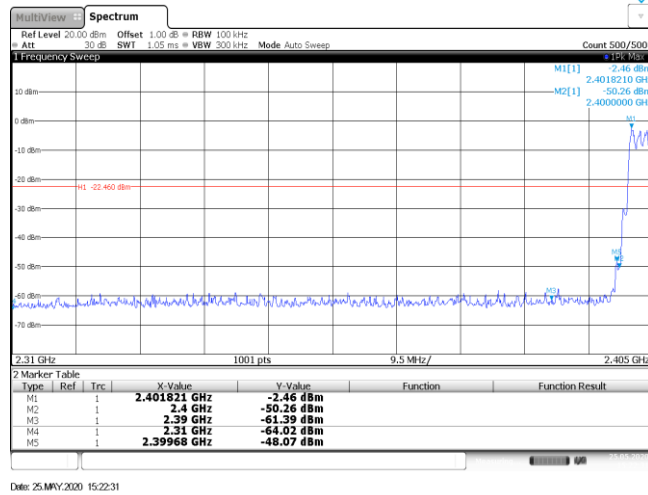

CH78
No hopping mode

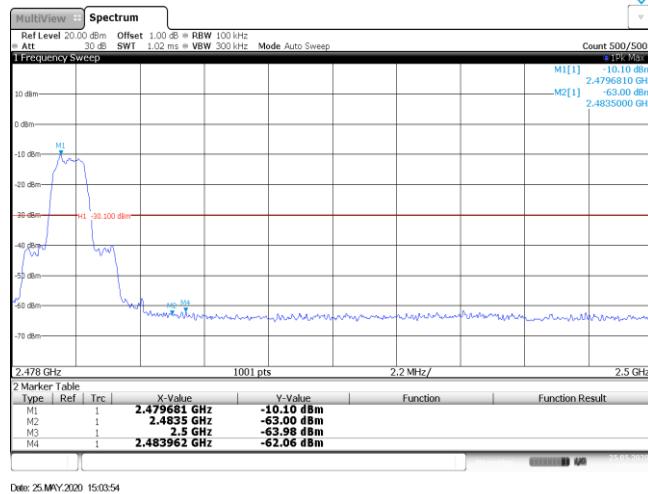

CH78
Hopping mode

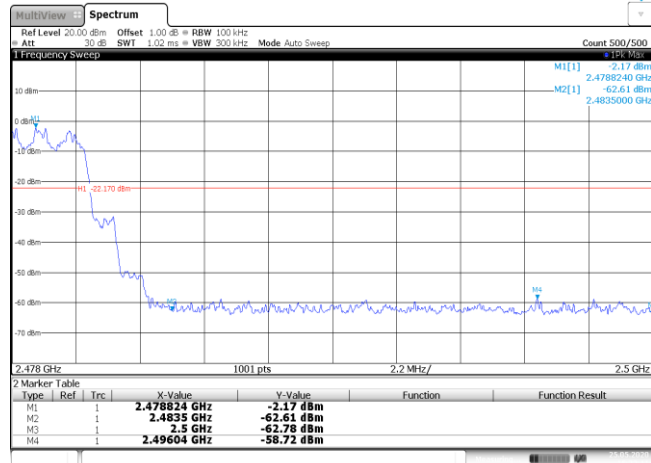

Date: 25.MAY.2020 15:23:11

Test Item:	Band edge	Modulation type:	8DPSK																																										
<p>CH00 No hopping mode</p>	<p>2 Marker Table</p> <table border="1"> <thead> <tr> <th>Type</th> <th>Ref</th> <th>Trc</th> <th>X-Value</th> <th>Y-Value</th> <th>Function</th> <th>Function Result</th> </tr> </thead> <tbody> <tr> <td>M1</td> <td>1</td> <td></td> <td>2.4022 GHz</td> <td>-9.55 dBm</td> <td></td> <td></td> </tr> <tr> <td>M2</td> <td>1</td> <td></td> <td>2.4 GHz</td> <td>-58.68 dBm</td> <td></td> <td></td> </tr> <tr> <td>M3</td> <td>1</td> <td></td> <td>2.39 GHz</td> <td>-63.89 dBm</td> <td></td> <td></td> </tr> <tr> <td>M4</td> <td>1</td> <td></td> <td>2.31 GHz</td> <td>-63.46 dBm</td> <td></td> <td></td> </tr> <tr> <td>M5</td> <td>1</td> <td></td> <td>2.399585 GHz</td> <td>-55.42 dBm</td> <td></td> <td></td> </tr> </tbody> </table> <p>Date: 25.MAY.2020 15:07:02</p>			Type	Ref	Trc	X-Value	Y-Value	Function	Function Result	M1	1		2.4022 GHz	-9.55 dBm			M2	1		2.4 GHz	-58.68 dBm			M3	1		2.39 GHz	-63.89 dBm			M4	1		2.31 GHz	-63.46 dBm			M5	1		2.399585 GHz	-55.42 dBm		
Type	Ref	Trc	X-Value	Y-Value	Function	Function Result																																							
M1	1		2.4022 GHz	-9.55 dBm																																									
M2	1		2.4 GHz	-58.68 dBm																																									
M3	1		2.39 GHz	-63.89 dBm																																									
M4	1		2.31 GHz	-63.46 dBm																																									
M5	1		2.399585 GHz	-55.42 dBm																																									
<p>CH00 Hopping mode</p>	<p>2 Marker Table</p> <table border="1"> <thead> <tr> <th>Type</th> <th>Ref</th> <th>Trc</th> <th>X-Value</th> <th>Y-Value</th> <th>Function</th> <th>Function Result</th> </tr> </thead> <tbody> <tr> <td>M1</td> <td>1</td> <td></td> <td>2.40277 GHz</td> <td>-1.75 dBm</td> <td></td> <td></td> </tr> <tr> <td>M2</td> <td>1</td> <td></td> <td>2.4 GHz</td> <td>-49.67 dBm</td> <td></td> <td></td> </tr> <tr> <td>M3</td> <td>1</td> <td></td> <td>2.39 GHz</td> <td>-61.55 dBm</td> <td></td> <td></td> </tr> <tr> <td>M4</td> <td>1</td> <td></td> <td>2.31 GHz</td> <td>-63.44 dBm</td> <td></td> <td></td> </tr> <tr> <td>M5</td> <td>1</td> <td></td> <td>2.399585 GHz</td> <td>-46.13 dBm</td> <td></td> <td></td> </tr> </tbody> </table> <p>Date: 25.MAY.2020 15:25:53</p>			Type	Ref	Trc	X-Value	Y-Value	Function	Function Result	M1	1		2.40277 GHz	-1.75 dBm			M2	1		2.4 GHz	-49.67 dBm			M3	1		2.39 GHz	-61.55 dBm			M4	1		2.31 GHz	-63.44 dBm			M5	1		2.399585 GHz	-46.13 dBm		
Type	Ref	Trc	X-Value	Y-Value	Function	Function Result																																							
M1	1		2.40277 GHz	-1.75 dBm																																									
M2	1		2.4 GHz	-49.67 dBm																																									
M3	1		2.39 GHz	-61.55 dBm																																									
M4	1		2.31 GHz	-63.44 dBm																																									
M5	1		2.399585 GHz	-46.13 dBm																																									
<p>CH78 No hopping mode</p>	<p>2 Marker Table</p> <table border="1"> <thead> <tr> <th>Type</th> <th>Ref</th> <th>Trc</th> <th>X-Value</th> <th>Y-Value</th> <th>Function</th> <th>Function Result</th> </tr> </thead> <tbody> <tr> <td>M1</td> <td>1</td> <td></td> <td>2.480187 GHz</td> <td>-10.36 dBm</td> <td></td> <td></td> </tr> <tr> <td>M2</td> <td>1</td> <td></td> <td>2.4835 GHz</td> <td>-62.73 dBm</td> <td></td> <td></td> </tr> <tr> <td>M3</td> <td>1</td> <td></td> <td>2.5 GHz</td> <td>-64.38 dBm</td> <td></td> <td></td> </tr> <tr> <td>M4</td> <td>1</td> <td></td> <td>2.48757 GHz</td> <td>-61.88 dBm</td> <td></td> <td></td> </tr> </tbody> </table> <p>Date: 25.MAY.2020 15:18:44</p>			Type	Ref	Trc	X-Value	Y-Value	Function	Function Result	M1	1		2.480187 GHz	-10.36 dBm			M2	1		2.4835 GHz	-62.73 dBm			M3	1		2.5 GHz	-64.38 dBm			M4	1		2.48757 GHz	-61.88 dBm									
Type	Ref	Trc	X-Value	Y-Value	Function	Function Result																																							
M1	1		2.480187 GHz	-10.36 dBm																																									
M2	1		2.4835 GHz	-62.73 dBm																																									
M3	1		2.5 GHz	-64.38 dBm																																									
M4	1		2.48757 GHz	-61.88 dBm																																									

CH78
Hoppig mode

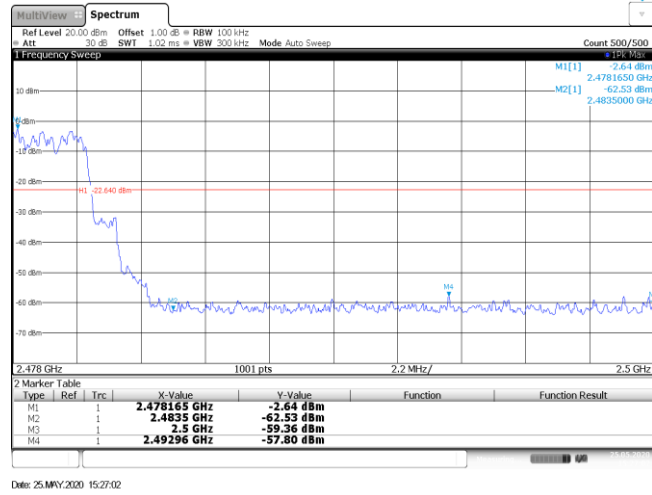

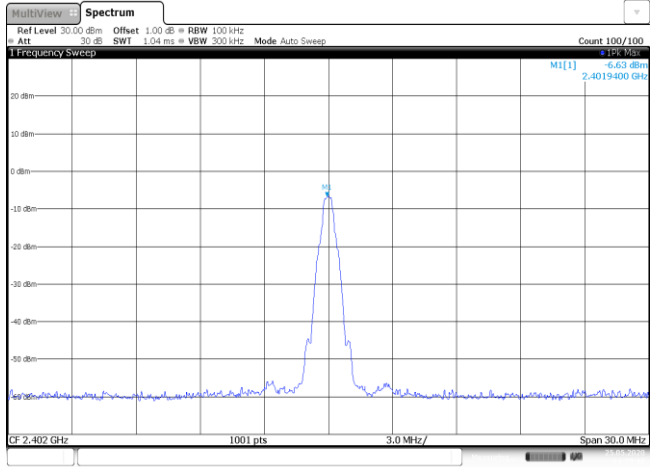
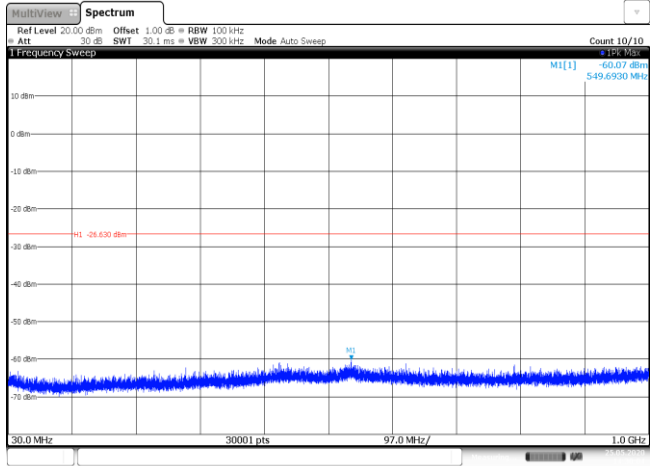
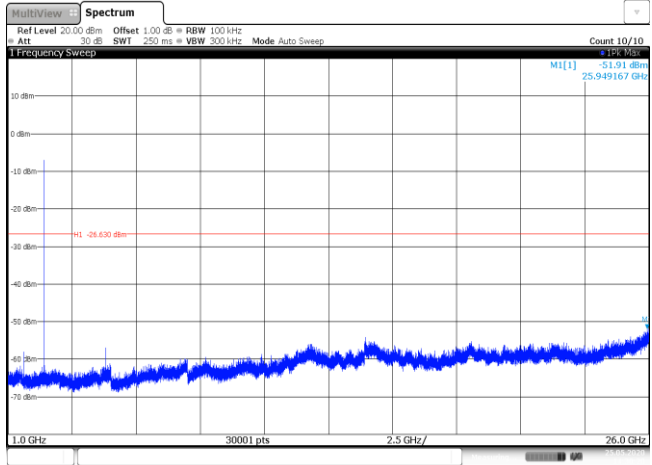
Test Item:	Spurious Emission	Modulation type:	GFSK
<p>CH00 Reference level</p>	 <p>Date: 25.MAY.2020 14:29:48</p>		
<p>CH00 30MHz~1000MHz</p>	 <p>Date: 25.MAY.2020 14:30:04</p>		
<p>CH00 1GHz~26GHz</p>	 <p>Date: 25.MAY.2020 14:30:20</p>		

<p>CH39 Reference level</p>	<p>Ref Level 30.00 dBm Offset 1.00 dB BW 100 kHz Att 30 dB SWI 1.04 ms VBW 300 kHz Mode Auto Sweep Count 100/100 M1[1] -1.07 dBm 2.4409400 GHz CF 2.441 GHz 1001 pts 3.0 MHz/ Span 30.0 MHz Date: 25.MAY.2020 14:52:33</p>
<p>CH39 30MHz~1000MHz</p>	<p>Ref Level 20.00 dBm Offset 1.00 dB BW 100 kHz Att 30 dB SWI 30.1 ms VBW 300 kHz Mode Auto Sweep Count 10/10 M1[1] -60.56 dBm 554.3160 MHz H1 -27.07 dBm 30.0 MHz 30001 pts 97.0 MHz/ 1.0 GHz Date: 25.MAY.2020 14:52:49</p>
<p>CH39 1GHz~26GHz</p>	<p>Ref Level 20.00 dBm Offset 1.00 dB BW 100 kHz Att 30 dB SWI 250 ms VBW 300 kHz Mode Auto Sweep Count 10/10 M1[1] -61.29 dBm 25.909167 GHz H1 -27.07 dBm 1.0 GHz 30001 pts 2.5 GHz/ 26.0 GHz Date: 25.MAY.2020 14:53:06</p>

CH78
Reference level

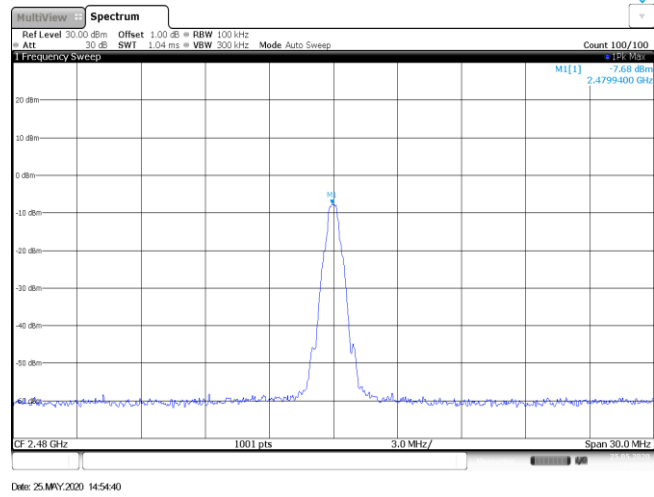

CH78
30MHz~1000MHz

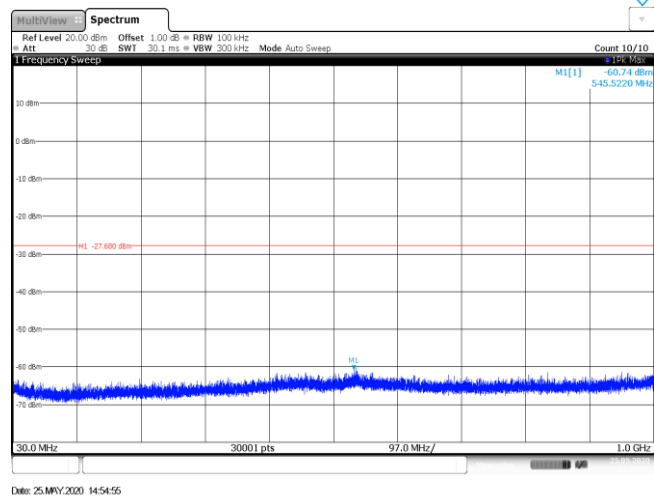

CH78
1GHz~26GHz

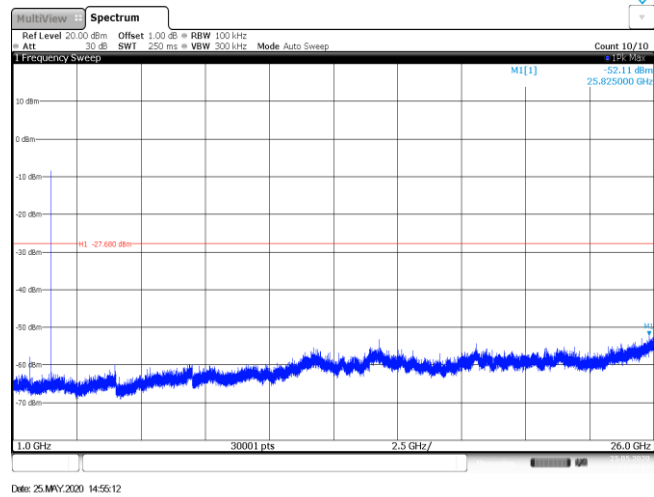

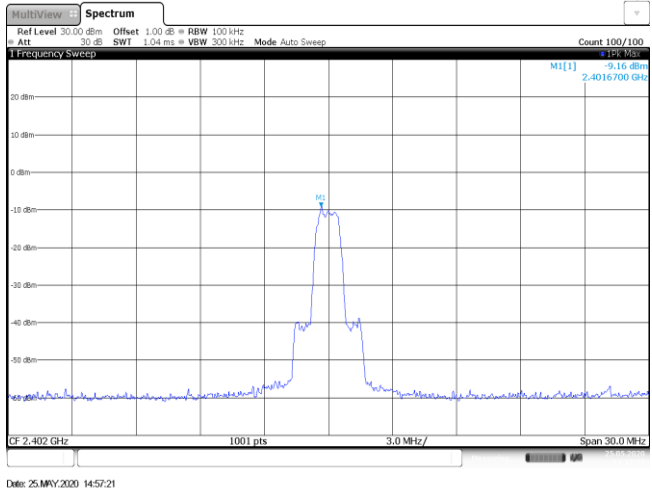
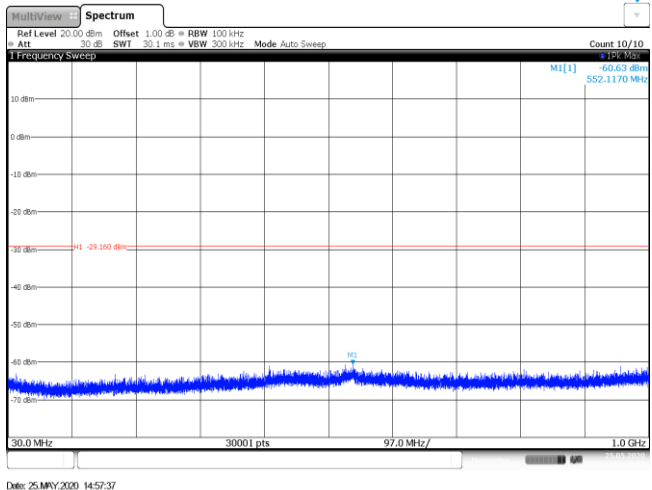
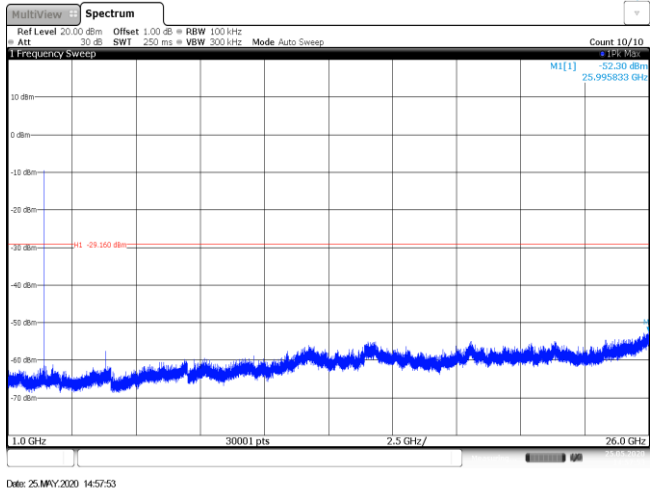
Test Item:	Spurious Emission	Modulation type:	π/4DQPSK
<p>CH00 Reference level</p>	 <p>Date: 25.MAY.2020 14:57:21</p>		
<p>CH00 30MHz~1000MHz</p>	 <p>Date: 25.MAY.2020 14:57:37</p>		
<p>CH00 1GHz~26GHz</p>	 <p>Date: 25.MAY.2020 14:57:53</p>		

CH39
Reference level

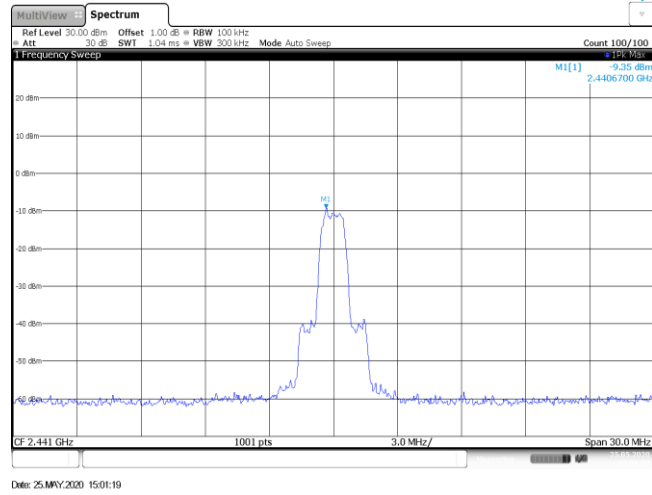

CH39
30MHz~1000MHz

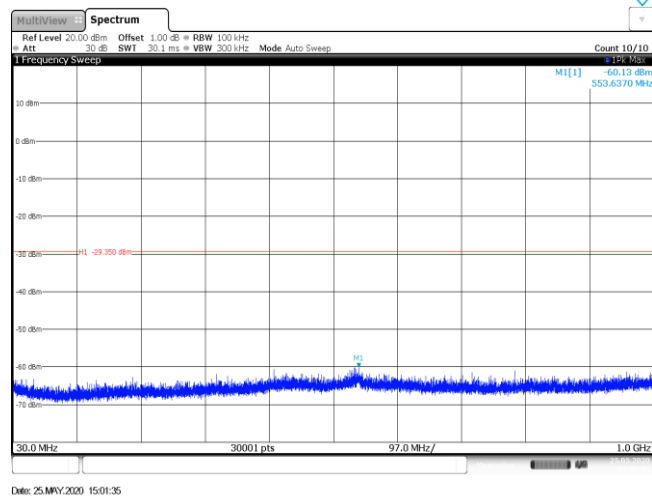

CH39
1GHz~26GHz

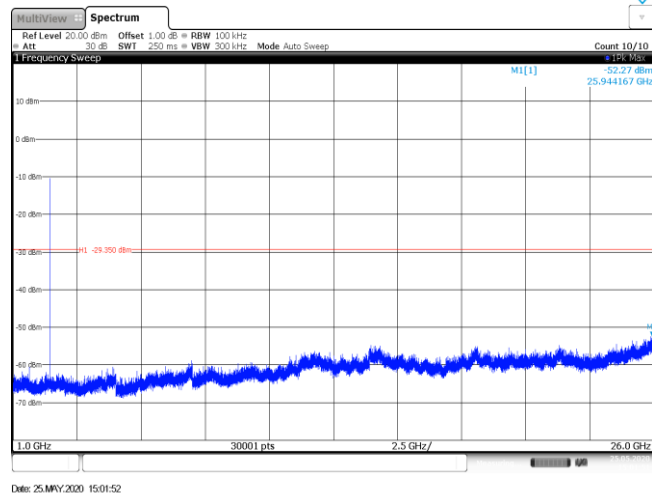

CH78
Reference level

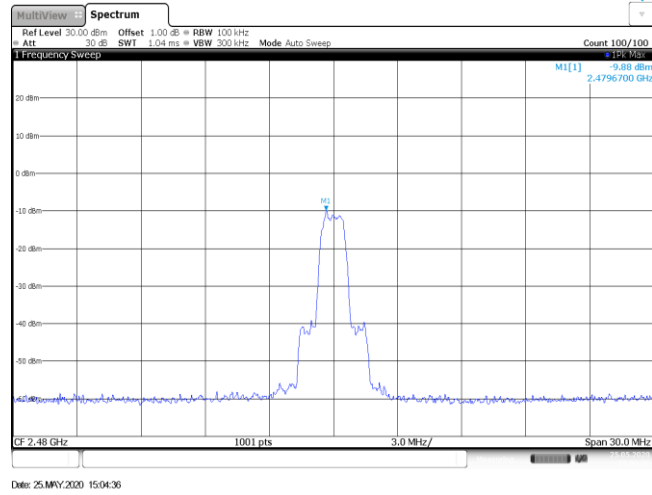

CH78
30MHz~1000MHz

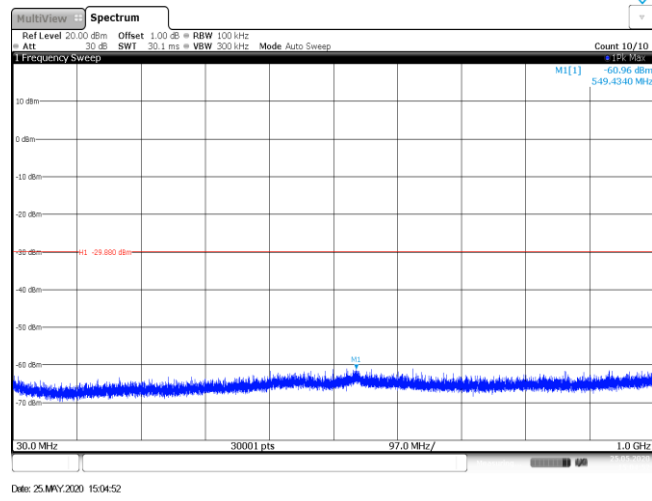

CH78
1GHz~26GHz

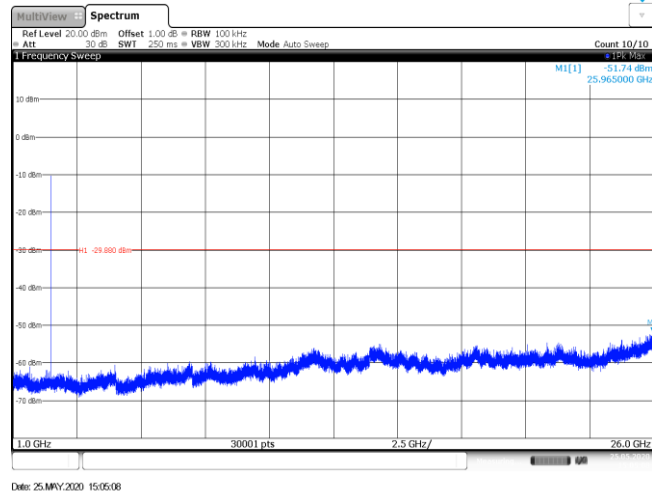

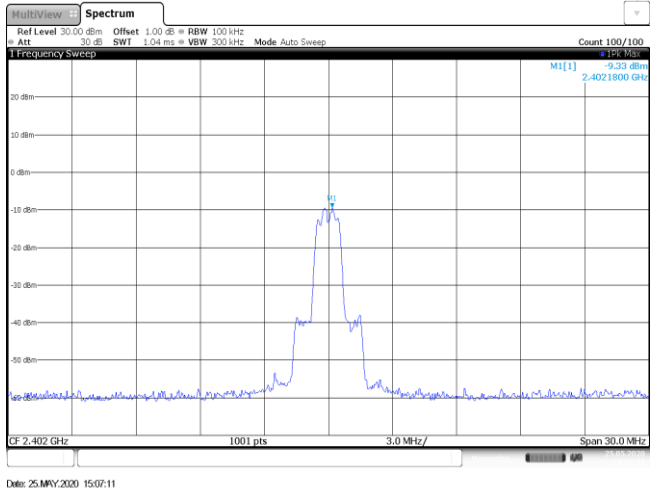
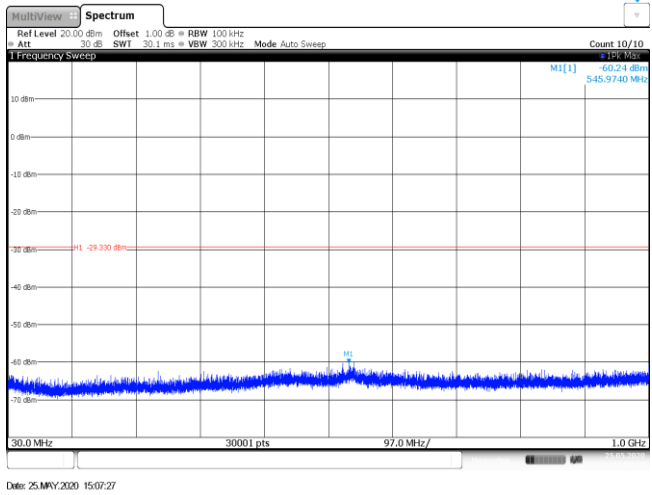
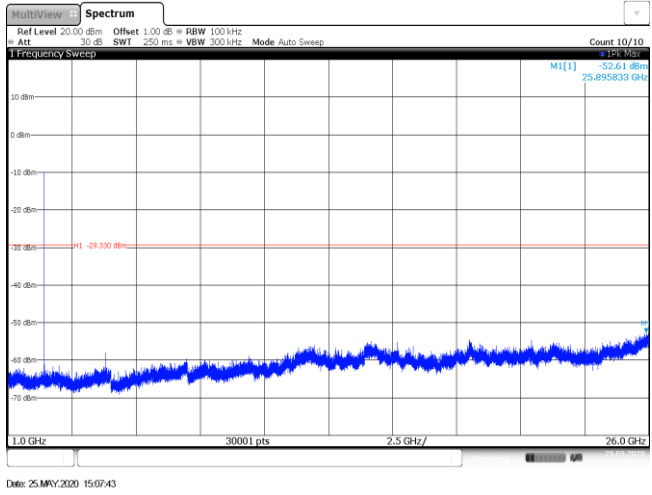
Test Item:	Spurious Emission	Modulation type:	8DPSK
<p>CH00 Reference level</p>	 <p>MultiView Spectrum Ref Level 30.00 dBm Offset 1.00 dB RBW 100 kHz Att 30 dB SWI 1.04 ms VBW 300 kHz Mode Auto Sweep Count 100/100 Frequency Sweep M1[1] -9.53 dBm 2.402180 GHz CF 2.402 GHz 1001 pts 3.0 MHz/ Span 30.0 MHz Date: 25.MAY.2020 15:07:11</p>		
<p>CH00 30MHz~1000MHz</p>	 <p>MultiView Spectrum Ref Level 20.00 dBm Offset 1.00 dB RBW 100 kHz Att 30 dB SWI 30.1 ms VBW 300 kHz Mode Auto Sweep Count 10/10 Frequency Sweep M1[1] -60.24 dBm 545.9740 MHz M1 -29.330 dBm M2 30.0 MHz 30001 pts 97.0 MHz/ 1.0 GHz Date: 25.MAY.2020 15:07:27</p>		
<p>CH00 1GHz~26GHz</p>	 <p>MultiView Spectrum Ref Level 20.00 dBm Offset 1.00 dB RBW 100 kHz Att 30 dB SWI 250 ms VBW 300 kHz Mode Auto Sweep Count 10/10 Frequency Sweep M1[1] -52.61 dBm 25.895833 GHz M1 -29.330 dBm 1.0 GHz 30001 pts 2.5 GHz/ 26.0 GHz Date: 25.MAY.2020 15:07:43</p>		

CH39
Reference level

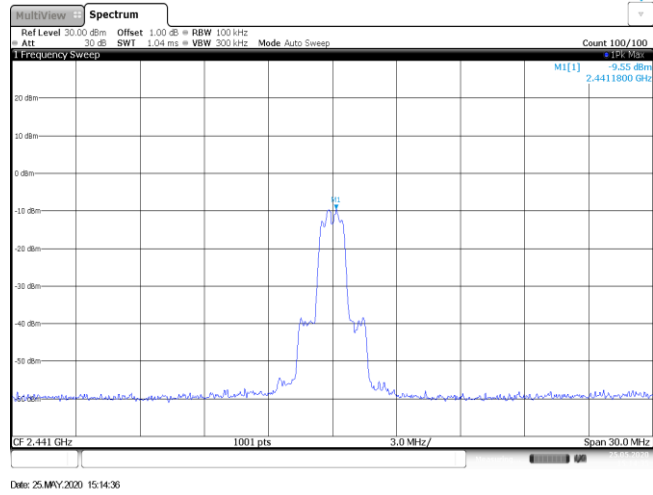

CH39
30MHz~1000MHz

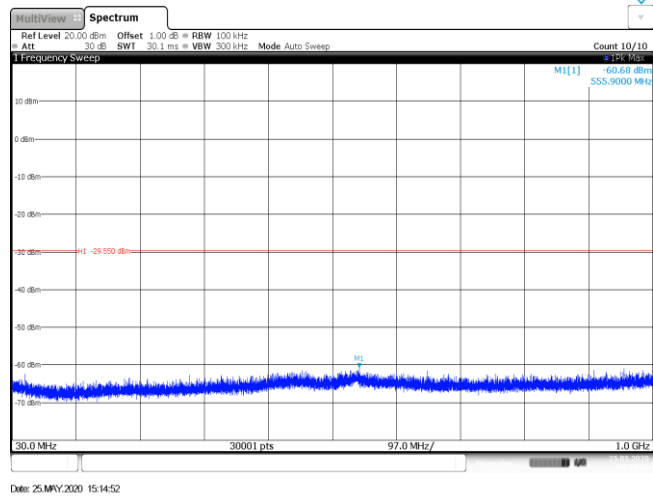

CH39
1GHz~26GHz

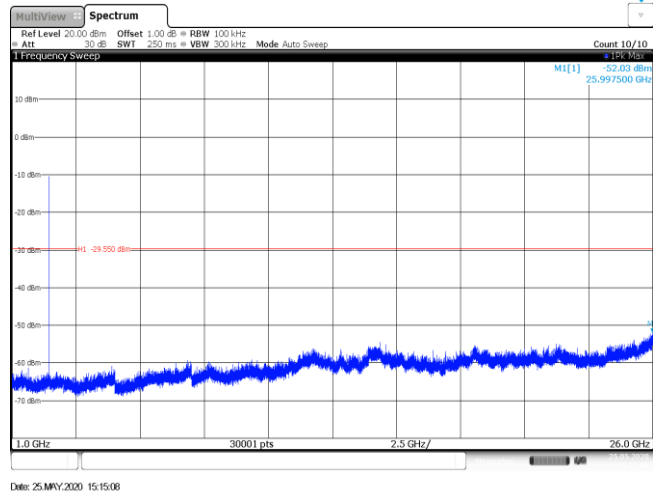

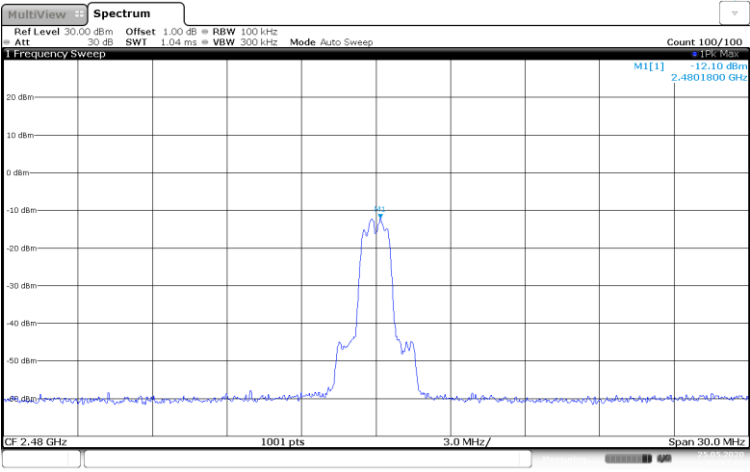
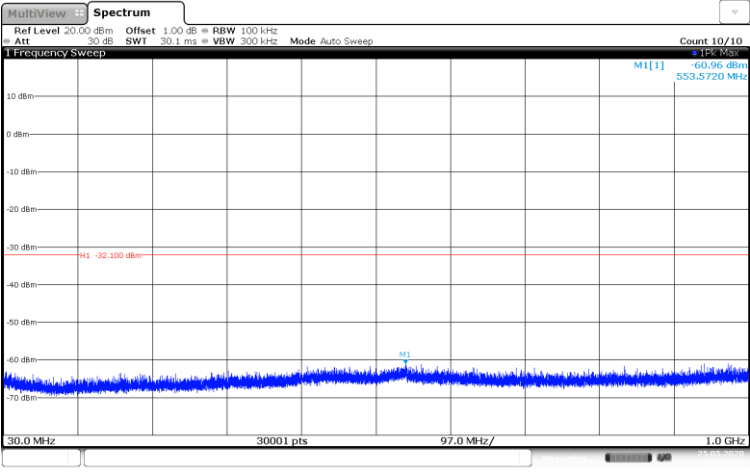
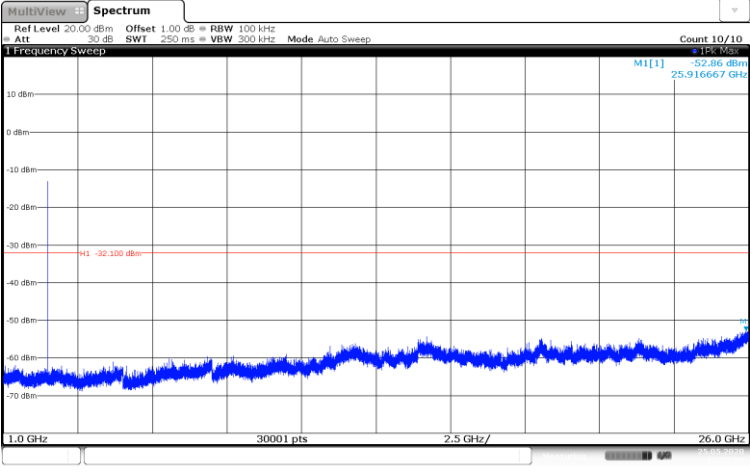
<p>CH78 Reference level</p>	 <p>MultiView Spectrum Ref Level 30.00 dBm Offset 1.00 dB RBW 100 kHz Att 30 dB SWI 1.04 ms VBW 300 kHz Mode Auto Sweep Count 100/100 Frequency Sweep M1[1] 12.10 dBm 2.4801800 GHz CF 2.48 GHz 1001 pts 3.0 MHz/ Span 30.0 MHz Date: 25.MAY.2020 15:57:07</p>
<p>CH78 30MHz~1000MHz</p>	 <p>MultiView Spectrum Ref Level 20.00 dBm Offset 1.00 dB RBW 100 kHz Att 30 dB SWI 30.1 ms VBW 300 kHz Mode Auto Sweep Count 10/10 Frequency Sweep M1[1] 60.96 dBm 553.5720 MHz M1 -32.100 dBm 30.0 MHz 30001 pts 97.0 MHz/ 1.0 GHz Date: 25.MAY.2020 15:57:23</p>
<p>CH78 1GHz~26GHz</p>	 <p>MultiView Spectrum Ref Level 20.00 dBm Offset 1.00 dB RBW 100 kHz Att 30 dB SWI 250 ms VBW 300 kHz Mode Auto Sweep Count 10/10 Frequency Sweep M1[1] -52.86 dBm 25.916667 GHz M1 -32.100 dBm 1.0 GHz 30001 pts 2.5 GHz/ 26.0 GHz Date: 25.MAY.2020 15:57:39</p>

-----End of Report-----