



TEST REPORT

Report No. : **CHTEW20050076** Report Verification: 

Project No...... : **SHT2004155101EW**

FCC ID..... : **2AVTH-HTN4000MPC**

Applicant's name..... : **Hyundai Technology Group, Inc.**

Address..... : 2601 Walnut Ave. Tustin, CA, USA

Manufacturer..... : Hyundai Technology Group, Inc.

Address..... : 2601 Walnut Ave. Tustin, CA, USA

Test item description : **HYUNDAI Mini PC**

Trade Mark : HYUNDAI

Model/Type reference..... : HTN4000MPC

Listed Model(s) : -

Standard : **FCC CFR Title 47 Part 15 Subpart E Section 15.407**

Date of receipt of test sample..... : May 09, 2020

Date of testing..... : May 09, 2020- May 19, 2020

Date of issue..... : May 20, 2020

Result..... : **PASS**

Compiled by
 (Position+Printed name+Signature): File administrator Echo Wei 

Supervised by
 (Position+Printed name+Signature): Project Engineer Kiki Kong 

Approved by
 (Position+Printed name+Signature): RF Manager Hans Hu 

Testing Laboratory Name : **Shenzhen Huatongwei International Inspection Co., Ltd.**

Address..... : 1/F, Bldg 3, Hongfa Hi-tech Industrial Park, Genyu Road, Tianliao, Gongming, Shenzhen, China

Shenzhen Huatongwei International Inspection Co., Ltd. All rights reserved.

This publication may be reproduced in whole or in part for non-commercial purposes as long as the Shenzhen Huatongwei International Inspection Co., Ltd. is acknowledged as copyright owner and source of the material. Shenzhen Huatongwei International Inspection Co., Ltd. takes no responsibility for and will not assume liability for damages resulting from the reader's interpretation of the reproduced material due to its placement and context. The test report merely correspond to the test sample.

Contents

1.	<u>TEST STANDARDS AND REPORT VERSION</u>	3
1.1.	Test Standards	3
1.2.	Report version	3
2.	<u>TEST DESCRIPTION</u>	4
3.	<u>SUMMARY</u>	5
3.1.	Client Information	5
3.2.	Product Description	5
3.3.	Radio Specification Description	5
3.4.	Testing Laboratory Information	6
4.	<u>TEST CONFIGURATION</u>	7
4.1.	Test frequency list	7
4.2.	Descriptions of Test mode	7
4.3.	Test mode	7
4.4.	Support unit used in test configuration and system	8
4.5.	Testing environmental condition	8
4.6.	Measurement uncertainty	8
4.7.	Equipment Used during the Test	9
5.	<u>TEST CONDITIONS AND RESULTS</u>	11
5.1.	Antenna Requirement	11
5.2.	AC Conducted Emission	12
5.3.	Maximum Conducted Output Power	15
5.4.	Power Spectral Density	16
5.5.	26dB bandwidth and 99% Occupy bandwidth	18
5.6.	6dB Bandwidth	19
5.7.	Band edge	20
5.8.	Radiated Spurious Emissions	23
5.9.	Frequency stability	29
6.	<u>TEST SETUP PHOTOS</u>	30
7.	<u>EXTERANAL AND INTERNAL PHOTOS</u>	32
8.	<u>APPENDIX REPORT</u>	32

1. TEST STANDARDS AND REPORT VERSION

1.1. Test Standards

The tests were performed according to following standards:

- [FCC Rules Part 15.407](#): General technical requirements.
- [ANSI C63.10:2013](#): American National Standard for Testing Unlicensed Wireless Devices
- [KDB789033 D02 v02r01](#): GUIDELINES FOR COMPLIANCE TESTING OF UNLICENSED NATIONAL INFORMATION INFRASTRUCTURE (U-NII) DEVICES PART 15, SUBPART E

1.2. Report version

Revision No.	Date of issue	Description
N/A	2020-05-20	Original

2. TEST DESCRIPTION

Report clause	Test Items	Standard Requirement	Result
5.1	Antenna Requirement	15.203/15.247(c)	PASS
5.2	AC Conducted Emission	15.207	PASS
5.3	Maximum Conducted Output Power	15.407(a)	PASS
5.4	Maximum Power Spectral Density	15.407(a)	PASS
5.5	26dB Bandwidth and 99% Occupancy bandwidth	15.407(a)	PASS
5.6	6dB Bandwidth	15.407(a)	PASS
5.7	Band edge	15.407(b)	PASS
5.8	Radiated Spurious Emissions	15.209	PASS
5.9	Frequency Stability	15.407(g)	PASS

Note:

- The measurement uncertainty is not included in the test result.

3. SUMMARY

3.1. Client Information

Applicant:	Hyundai Technology Group, Inc.
Address:	2601 Walnut Ave. Tustin, CA, USA
Manufacturer:	Hyundai Technology Group, Inc.
Address:	2601 Walnut Ave. Tustin, CA, USA

3.2. Product Description

Name of EUT:	HYUNDAI Mini PC
Trade Mark:	HYUNDAI
Model No.:	HTN4000MPC
Listed Model(s):	-
Power supply:	AC 120V
Hardware version:	IP3-GB3-MB-V30
Software version:	GB3V35

3.3. Radio Specification Description

Support type ^{*1}	<input checked="" type="checkbox"/> 802.11a	<input checked="" type="checkbox"/> 802.11n(HT20)	<input checked="" type="checkbox"/> 802.11n(HT40)
	<input checked="" type="checkbox"/> 802.11ac(HT20)	<input checked="" type="checkbox"/> 802.11ac(HT40)	<input checked="" type="checkbox"/> 802.11ac(HT80)
Function:	<input type="checkbox"/> Outdoor AP	<input type="checkbox"/> Indoor AP	<input type="checkbox"/> Fixed P2P
	<input checked="" type="checkbox"/> Client		
Modulation:	BPSK, QPSK, 16QAM, 64QAM		
Operation frequency:	<input checked="" type="checkbox"/> Band I: 5150MHz~5250MHz		
	<input checked="" type="checkbox"/> Band IV: 5725MHz~5850MHz		
Supported Bandwidth	20MHz:	802.11ac,802.11n, 802.11a	
	40MHz:	802.11ac,802.11n	
	80MHz:	802.11ac	
Antenna type:	FPC Antenna		
Antenna gain:	1.28dBi		

Note:

*1: only show the RF function associated with this report.

3.4. Testing Laboratory Information

Laboratory Name	Shenzhen Huatongwei International Inspection Co., Ltd.	
Laboratory Location	1/F, Bldg 3, Hongfa Hi-tech Industrial Park, Genyu Road, Tianliao, Gongming, Shenzhen, China	
Qualifications	Type	Accreditation Number
	CNAS	L1225
	A2LA	3902.01
	FCC	762235
	Canada	5377A

4. TEST CONFIGURATION

4.1. Test frequency list

According to section 15.31(m), regards to the operating frequency range over 10 MHz, must select three channels which were tested. The Lowest frequency, the middle frequency, and the highest frequency of channel were selected to perform the test, please see the below .

Band	Test Channel	20MHz		40MHz		80MHz	
		Channel	Frequency (MHz)	Channel	Frequency (MHz)	Channel	Frequency (MHz)
I	CH _L	36	5180	38	5190	-	-
	CH _M	44	5220	-	-	42	5210
	CH _H	48	5240	46	5230	-	-
IV	CH _L	149	5745	151	5755	-	-
	CH _M	157	5785	-	-	155	5775
	CH _H	165	5825	159	5795	-	-

4.2. Descriptions of Test mode

Preliminary tests were performed in different data rates, final test modes are considering the modulation and worse data rates as below table.

Modulation	Data rate
802.11a	6Mbps
802.11n(HT20)/ 802.11ac(HT20)	MCS0
802.11n(HT40)/ 802.11ac(HT40)	MCS0
802.11ac(HT80)	MCS0

4.3. Test mode

For RF test items
The engineering test program was provided and enabled to make EUT continuous transmit.
For AC power line conducted emissions:
The EUT was set to connect with the WLAN AP under large package sizes transmission.
For Radiated spurious emissions test item:
The engineering test program was provided and enabled to make EUT continuous transmit. The EUT in each of three orthogonal axis emissions had been tested, but only the worst case (X axis) data Recorded in the report.

4.4. Support unit used in test configuration and system

The EUT has been associated with peripherals and configuration operated in a manner tended to maximize its emission characteristics in a typical application.

The following peripheral devices and interface cables were connected during the measurement:

Whether support unit is used?					
✓ No					
Item	Equipment	Trade Name	Model No.	FCC ID	Power cord
1					
2					

4.5. Testing environmental condition

Type	Requirement	Actual
Temperature:	15~35°C	25°C
Relative Humidity:	25~75%	50%
Air Pressure:	860~1060mbar	1000mbar

4.6. Measurement uncertainty

Test Item	Measurement Uncertainty
AC Conducted Emission (150kHz~30MHz)	3.02 dB
Radiated Emission (30MHz~1000MHz)	4.90 dB
Radiated Emissions (1GHz~25GHz)	4.96 dB
Peak Output Power	0.51 dB
Power Spectral Density	0.51 dB
Conducted Spurious Emission	0.51 dB
6dB Bandwidth	70 Hz
Frequency error	70 Hz

This uncertainty represents an expanded uncertainty expressed at approximately the 95% confidence level using a coverage factor of k=1.96.

4.7. Equipment Used during the Test

● Conducted Emission							
Used	Test Equipment	Manufacturer	Equipment No.	Model No.	Serial No.	Last Cal. Date (YY-MM-DD)	Next Cal. Date (YY-MM-DD)
●	Shielded Room	Albatross projects	HTWE0114	N/A	N/A	2018/09/28	2023/09/27
●	EMI Test Receiver	R&S	HTWE0111	ESCI	101247	2019/10/26	2020/10/25
●	Artificial Mains	SCHWARZBECK	HTWE0113	NNLK 8121	573	2019/10/23	2020/10/22
●	Pulse Limiter	R&S	HTWE0033	ESH3-Z2	100499	2019/10/23	2020/10/22
●	RF Connection Cable	HUBER+SUHNER	HTWE0113-02	ENVIROFLE X_142	EF-NM-BNCM-2M	2019/10/23	2020/10/22
●	Test Software	R&S	N/A	ES-K1	N/A	N/A	N/A

● Radiated emission-6th test site							
Used	Test Equipment	Manufacturer	Equipment No.	Model No.	Serial No.	Last Cal. Date (YY-MM-DD)	Next Cal. Date (YY-MM-DD)
●	Semi-Anechoic Chamber	Albatross projects	HTWE0127	SAC-3m-02	C11121	2018/09/30	2021/09/29
●	EMI Test Receiver	R&S	HTWE0099	ESCI	100900	2019/10/26	2020/10/25
●	Loop Antenna	R&S	HTWE0170	HFH2-Z2	100020	2018/04/02	2021/04/01
●	Ultra-Broadband Antenna	SCHWARZBECK	HTWE0123	VULB9163	538	2018/04/04	2021/04/03
●	Pre-Amplifier	SCHWARZBECK	HTWE0295	BBV 9742	N/A	2019/11/14	2020/11/13
●	RF Connection Cable	HUBER+SUHNER	HTWE0062-01	N/A	N/A	2019/08/21	2020/08/20
●	RF Connection Cable	HUBER+SUHNER	HTWE0062-02	SUCOFLEX 104	501184/4	2019/05/27	2020/05/26
●	Test Software	R&S	N/A	ES-K1	N/A	N/A	N/A

● Radiated emission-7th test site							
Used	Test Equipment	Manufacturer	Equipment No.	Model No.	Serial No.	Last Cal. Date (YY-MM-DD)	Next Cal. Date (YY-MM-DD)
●	Semi-Anechoic Chamber	Albatross projects	HTWE0122	SAC-3m-01	N/A	2018/09/27	2021/09/26
●	Spectrum Analyzer	R&S	HTWE0098	FSP40	100597	2019/10/26	2020/10/25
●	Horn Antenna	SCHWARZBECK	HTWE0126	9120D	1011	2020/04/01	2023/03/31
●	Horn Antenna	SCHWARZBECK	HTWE0103	BBHA9170	25841	2018/10/11	2021/10/10
●	Broadband Horn Antenna	SCHWARZBECK	HTWE0103	BBHA9170	BBHA9170472	2018/10/11	2021/10/10
●	Pre-amplifier	CD	HTWE0071	PAP-0102	12004	2019/11/14	2020/11/13
●	Broadband Pre-amplifier	SCHWARZBECK	HTWE0201	BBV 9718	9718-248	2019/05/23	2020/05/22
●	RF Connection Cable	HUBER+SUHNER	HTWE0120-01	6m 18GHz S Serisa	N/A	2020/05/10	2021/05/09
●	RF Connection Cable	HUBER+SUHNER	HTWE0120-02	6m 3GHz RG Serisa	N/A	2020/05/10	2021/05/09
●	RF Connection Cable	HUBER+SUHNER	HTWE0120-03	6m 3GHz RG Serisa	N/A	2020/05/10	2021/05/09
●	RF Connection Cable	HUBER+SUHNER	HTWE0120-04	6m 3GHz RG Serisa	N/A	2020/05/10	2021/05/09
●	RF Connection Cable	HUBER+SUHNER	HTWE0121-01	6m 18GHz S Serisa	N/A	2020/05/10	2021/05/09
●	Test Software	Audix	N/A	E3	N/A	N/A	N/A

● RF Conducted Method						
Used	Test Equipment	Manufacturer	Model No.	Serial No.	Last Cal. Date (YY-MM-DD)	Next Cal. Date (YY-MM-DD)
●	Signal and spectrum Analyzer	R&S	FSV40	100048	2019/10/26	2020/10/25
●	Spectrum Analyzer	Agilent	N9020A	MY50510187	2019/10/26	2020/10/25
●	Power Meter	Anritsu	ML249A	N/A	2019/10/26	2020/10/25
○	Radio communication tester	R&S	CMW500	137688-Lv	2019/10/26	2020/10/25

5. TEST CONDITIONS AND RESULTS

5.1. Antenna Requirement

Requirement

FCC CFR Title 47 Part 15 Subpart C Section 15.203:

An intentional radiator shall be designed to ensure that no antenna other than that furnished by the responsible party shall be used with the device. The use of a permanently attached antenna or of an antenna that uses a unique coupling to the intentional radiator, the manufacturer may design the unit so that a broken antenna can be replaced by the user, but the use of a standard antenna jack or electrical connector is prohibited.

TEST RESULT

Passed Not Applicable

The antenna type is a FPC antenna, the directional gain of the antenna less than 6 dBi, please refer to the below antenna photo.

|



5.2. AC Conducted Emission

LIMIT

FCC CFR Title 47 Part 15 Subpart C Section 15.207

Frequency range (MHz)	Limit (dBuV)	
	Quasi-peak	Average
0.15-0.5	66 to 56*	56 to 46*
0.5-5	56	46
5-30	60	50

* Decreases with the logarithm of the frequency.

TEST CONFIGURATION

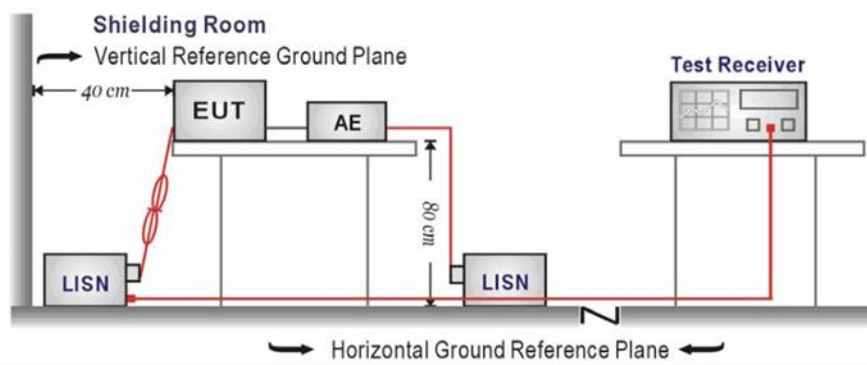

TEST PROCEDURE

1. The EUT was setup according to ANSI C63.10 requirements.
2. The EUT was placed on a platform of nominal size, 1 m by 1.5 m, raised 80 cm above the conducting ground plane. The vertical conducting plane was located 40 cm to the rear of the EUT. All other surfaces of EUT were at least 80 cm from any other grounded conducting surface.
3. The EUT and simulators are connected to the main power through a line impedances stabilization network (LISN). The LISN provides a 50 ohm /50uH coupling impedance for the measuring equipment.
4. The peripheral devices are also connected to the main power through a LISN. (Please refer to the block diagram of the test setup and photographs)
5. Each current-carrying conductor of the EUT power cord, except the ground (safety) conductor, was individually connected through a LISN to the input power source.
6. The excess length of the power cord between the EUT and the LISN receptacle were folded back and forth at the center of the lead to form a bundle not exceeding 40 cm in length.
7. Conducted emissions were investigated over the frequency range from 0.15MHz to 30MHz using a receiver bandwidth of 9 kHz.
8. During the above scans, the emissions were maximized by cable manipulation.

TEST MODE:

Please refer to the clause 4.3

TEST RESULT

Passed Not Applicable

Test Line:

L

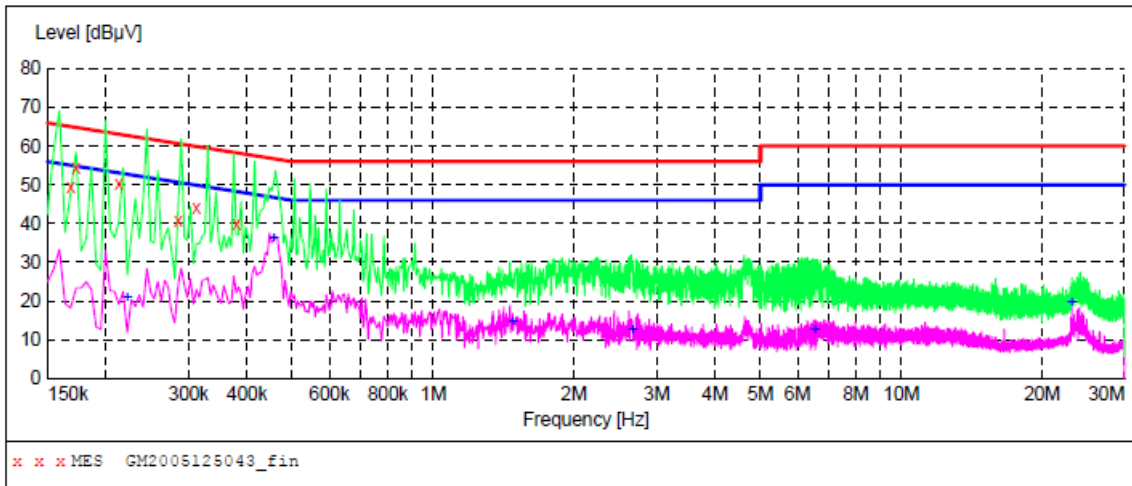

MEASUREMENT RESULT: "GM2005125043_fin"

5/12/2020 8:34PM

Frequency MHz	Level dBµV	Transd dB	Limit dBµV	Margin dB	Detector	Line	PE
0.168000	49.60	10.0	65	15.5	QP	L1	GND
0.172500	54.40	10.0	65	10.4	QP	L1	GND
0.213000	50.10	10.0	63	13.0	QP	L1	GND
0.285000	40.90	10.1	61	19.8	QP	L1	GND
0.312000	44.10	10.1	60	15.8	QP	L1	GND
0.379500	39.80	10.1	58	18.5	QP	L1	GND

MEASUREMENT RESULT: "GM2005125043_fin2"

5/12/2020 8:34PM

Frequency MHz	Level dBµV	Transd dB	Limit dBµV	Margin dB	Detector	Line	PE
0.222000	20.70	10.0	53	32.0	AV	L1	GND
0.456000	36.30	10.1	47	10.5	AV	L1	GND
1.477500	14.50	10.1	46	31.5	AV	L1	GND
2.665500	12.70	10.2	46	33.3	AV	L1	GND
6.535500	12.70	10.2	50	37.3	AV	L1	GND
23.127000	19.50	10.5	50	30.5	AV	L1	GND

Test Line:

N

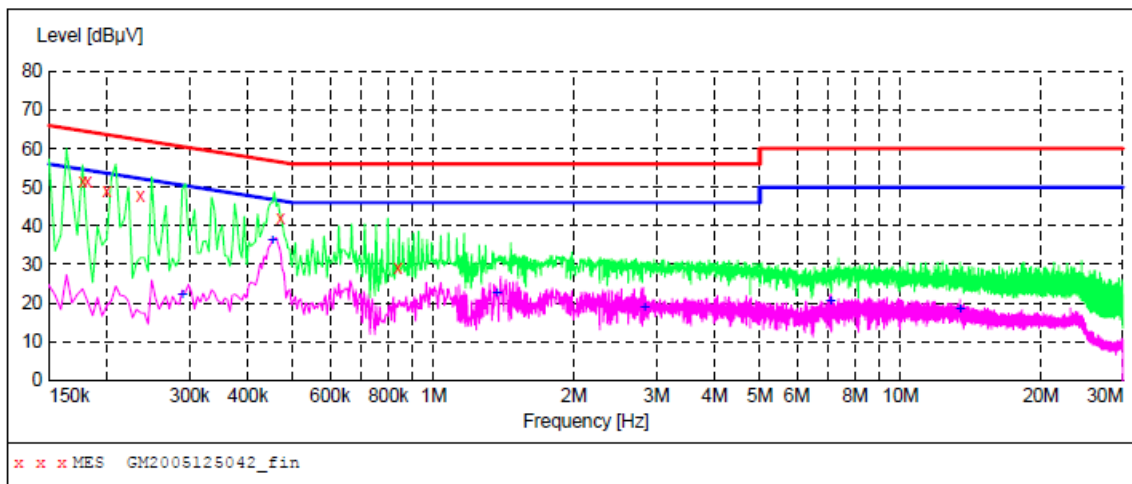

MEASUREMENT RESULT: "GM2005125042_fin"

5/12/2020 8:30PM

Frequency MHz	Level dBµV	Transd dB	Limit dBµV	Margin dB	Detector	Line	PE
0.177000	51.40	10.0	65	13.2	QP	N	GND
0.181500	51.50	10.0	64	12.9	QP	N	GND
0.199500	49.20	10.0	64	14.4	QP	N	GND
0.235500	47.80	10.0	62	14.5	QP	N	GND
0.469500	41.90	10.1	57	14.6	QP	N	GND
0.838500	28.90	10.1	56	27.1	QP	N	GND

MEASUREMENT RESULT: "GM2005125042_fin2"

5/12/2020 8:30PM

Frequency MHz	Level dBµV	Transd dB	Limit dBµV	Margin dB	Detector	Line	PE
0.289500	22.00	10.1	51	28.5	AV	N	GND
0.451500	36.10	10.1	47	10.7	AV	N	GND
1.365000	22.40	10.1	46	23.6	AV	N	GND
2.832000	18.60	10.2	46	27.4	AV	N	GND
7.084500	20.50	10.3	50	29.5	AV	N	GND
13.420500	18.30	10.4	50	31.7	AV	N	GND

5.3. Maximum Conducted Output Power

LIMIT

FCC CFR Title 47 Part 15 Subpart E Section 15.407(a):

For the 5.15~5.25GHz band:

- Outdoor AP
The maximum conducted output power (P_{out}) shall not exceed the lesser of 1W (30dBm).
if $G_{TX} > 6\text{dBi}$, then $P_{out} = 30 - (G_{TX} - 6)$. e.i.r.p. at any elevation angle above 30 degrees $\leq 125\text{mW}$ (21dBm)
- Indoor AP
The maximum conducted output power (P_{out}) shall not exceed the lesser of 1W (30dBm).
if $G_{TX} > 6\text{dBi}$, then $P_{out} = 30 - (G_{TX} - 6)$.
- Point-to-point AP
The maximum conducted output power (P_{out}) shall not exceed the lesser of 1W (30dBm).
if $G_{TX} > 23\text{dBi}$, then $P_{out} = 30 - (G_{TX} - 23)$.
- Client devices
The maximum conducted output power (P_{out}) shall not exceed the lesser of 250W (24dBm).
if $G_{TX} > 6\text{dBi}$, then $P_{out} = 24 - (G_{TX} - 6)$.

For the 5.725~5.85GHz band:

- Point-to-multipoint systems (P2M)
The maximum conducted output power (P_{out}) shall not exceed the lesser of 1W (30dBm).
if $G_{TX} > 6\text{dBi}$, then $P_{out} = 30 - (G_{TX} - 6)$.
- Point-to-point systems (P2P)
The maximum conducted output power (P_{out}) shall not exceed the lesser of 1W (30dBm).

TEST CONFIGURATION

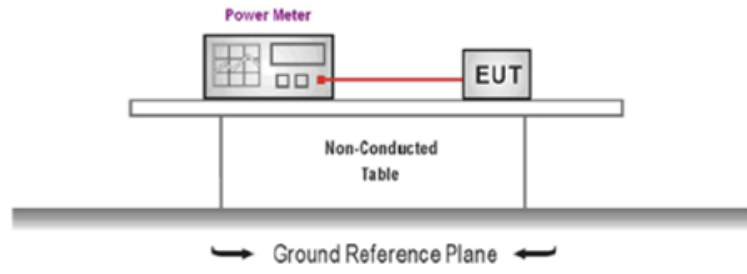

TEST PROCEDURE

1. The EUT was tested according to KDB789033 Section E-3-b)
2. The maximum conducted output power may be measured using a broadband AVG RF power meter.
3. Average power measurements were performed only when the EUT was transmitting at its maximum power control level using a broadband power meter with a pulse sensor.
4. The power meter implemented triggering and gating capabilities which were set up such that power measurements were recorded only during the ON time of the transmitter.
5. Record the measurement data.

6. TEST MODE:

Please refer to the clause 4.3

TEST RESULT

Passed Not Applicable

TEST Data

Please refer to appendix A on the appendix report

5.4. Power Spectral Density

LIMIT

FCC CFR Title 47 Part 15 Subpart E Section 15.407(a):

For the 5.15~5.25GHz band:

- Outdoor AP
The peak power spectral density (PSD) shall not exceed the lesser of 17dBm/MHz.
if $G_{TX} > 6\text{dBi}$, then $\text{PSD} = 17 - (G_{TX} - 6)$.
- Indoor AP
The peak power spectral density (PSD) shall not exceed the lesser of 17dBm/MHz.
if $G_{TX} > 6\text{dBi}$, then $\text{PSD} = 17 - (G_{TX} - 6)$.
- Point-to-point AP
The peak power spectral density (PSD) shall not exceed the lesser of 17dBm/MHz.
if $G_{TX} > 23\text{dBi}$, then $\text{PSD} = 17 - (G_{TX} - 23)$.
- Client devices
The peak power spectral density (PSD) shall not exceed the lesser of 11dBm/MHz.
if $G_{TX} > 6\text{dBi}$, then $\text{PSD} = 11 - (G_{TX} - 6)$.

For the 5.725~5.85GHz band:

- Point-to-multipoint systems (P2M)
The peak power spectral density (PSD) shall not exceed the lesser of 30dBm/500kHz.
if $G_{TX} > 6\text{dBi}$, then $\text{PSD} = 30 - (G_{TX} - 6)$.
- Point-to-point systems (P2P)
The peak power spectral density (PSD) shall not exceed the lesser of 30dBm/500kHz.

TEST CONFIGURATION

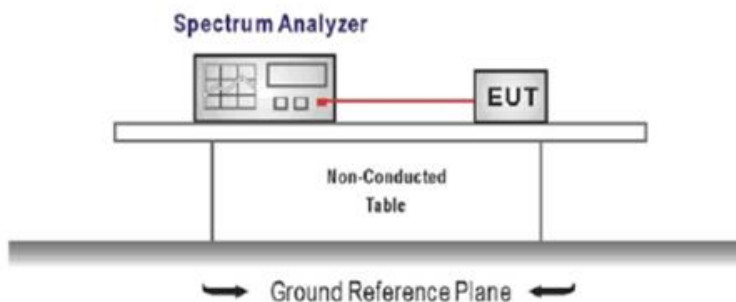

TEST PROCEDURE

1. According KDB 789033 D02 – Section F
2. Analyzer was setting as follow:
Center frequency: test channel
Span was set to encompass the entire emission bandwidth of the signal
RBW=1MHz for devices operating in the bands 5.15-5.25 GHz, 5.25-5.35 GHz, and 5.47-5.725 GHz
RBW=500kHz for devices operating in the band 5.725-5.85 GHz
VBW \geq 3 RBW
Number of sweep points $>$ 2 x (span/RBW)
Sweep time = auto
Detector = Peak
Trigger was set to free run for all modes, trace was averaged over 100 sweeps
3. The peak search function of the spectrum analyzer was used to find the peak of the spectrum.

TEST MODE:

Please refer to the clause 4.3

TEST RESULT

Passed **Not Applicable**

TEST Data

Please refer to appendix B on the appendix report

5.5. 26dB bandwidth and 99% Occupancy bandwidth

LIMIT

The bandwidth at 26dB down from the highest in-band spectral density is measured with a spectrum analyzer connected to the antenna terminal while the EUT is operating at its maximum duty cycle, at its maximum power control level, as defined in KDB 789033 D02 , and at the appropriate frequencies. The spectrum analyzer's bandwidth measurement function is configured to measure the 26dB bandwidth.

TEST CONFIGURATION

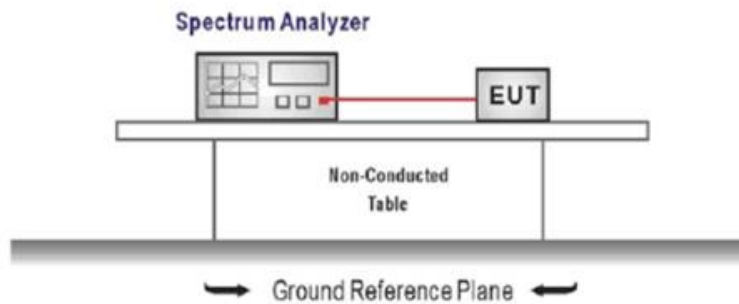

TEST PROCEDURE

1. According KDB 789033 D02 – Section C, 26dB bandwidth test as follow
 - a) Set RBW = approximately 1% of the emission bandwidth.
 - b) Set the VBW > RBW.
 - c) Detector = Peak.
 - d) Trace mode = max hold.
 - e) Measure the maximum width of the emission that is 26 dB down from the maximum of the emission. Compare this with the RBW setting of the analyzer. Readjust RBW and repeat measurement as needed until the RBW/EBW ratio is approximately 1%.
2. According KDB 789033 D02 – Section D, 99% bandwidth test as follow
 - a). Set center frequency to the nominal EUT channel center frequency.
 - b). Set span = 1.5 times to 5.0 times the OBW.
 - c). Set RBW = 1% to 5% of the OBW
 - d). Set $VBW \geq 3 \text{ RBW}$
 - e). Video averaging is not permitted. Where practical, a sample detection and single sweep mode shall be used. Otherwise, peak detection and max hold mode (until the trace stabilizes) shall be used.
 - f). Use the 99% power bandwidth function of the instrument

TEST MODE:

Please refer to the clause 4.3

TEST RESULT

Passed Not Applicable

TEST Data

Please refer to appendix C and D on the appendix report

5.6. 6dB Bandwidth

LIMIT

FCC CFR Title 47 Part 15 Subpart E Section 15.407(e)

Within the 5.725-5.85 GHz band, the minimum 6 dB bandwidth of U-NII devices shall be at least 500 kHz

TEST CONFIGURATION

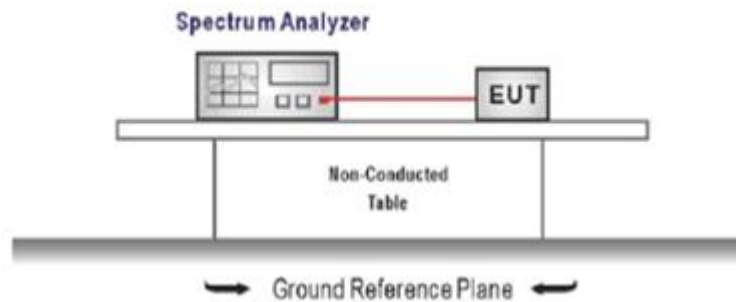

TEST PROCEDURE

1. Connect the antenna port(s) to the spectrum analyzer input.
2. Configure the spectrum analyzer as shown below (enter all losses between the transmitter output and the spectrum analyzer).
Center Frequency = test channel center frequency
Span = 2 x emission bandwidth
RBW = 100 kHz, VBW \geq 3 x RBW
Sweep time = auto couple
Detector = Peak
Trace mode = max hold
3. Place the radio in continuous transmit mode, allow the trace to stabilize, view the transmitter wave form on the spectrum analyzer.
4. Measure the maximum width of the emission that is constrained by the frequencies associated with the two outermost amplitude points (upper and lower frequencies) that are attenuated by 6 dB relative to the maximum level measured in the fundamental emission, and record the pertinent measurements.

TEST MODE:

Please refer to the clause 4.3

TEST RESULT

Passed Not Applicable

TEST Data

Please refer to appendix E on the appendix report

5.7. Band edge

LIMIT

FCC CFR Title 47 Part 15 Subpart E Section 15.407(b)

Un-restricted band emissions above 1GHz			
Operating Band	Frequency	EIRP Limit	Value
5150-5250MHz	Above 1GHz	-27dBm/MHz(68.2dBuV/m)@3m	Peak
5250-5350MHz	Above 1GHz	-27dBm/MHz(68.2dBuV/m)@3m	Peak
5470-5725MHz	Above 1GHz	-27dBm/MHz(68.2dBuV/m)@3m	Peak
5725-5850 MHz	1GHz-5.65GHz	-27 dBm/MHz(68.2dBuV/m)@3m	Peak
	5.65GHz-5.7GHz	-27*dBm/MHz to 10dBm/MHz (68.2* dBuV/m to 105.6dBuV/m)	Peak
	5.7GHz-5.72GHz	10*dBm/MHz to 15.6dBm/MHz (105.6*dBuV/m to 110.8dBuV/m)	Peak
	5.72GHz-5.725GHz	15.6*dBm/MHz to 27dBm/MHz (110.8dBuV/m to* 122.2dBuV/m)	Peak
	5.85GHz-5.855GHz	27dBm/MHz to 15.6*dBm/MHz (122.2dBuV/m to110.8* dBuV/m)	Peak
	5.855GHz-5.875GHz	15.6dBm/MHz to 10*dBm/MHz (110.8dBuV/m to 105.6* dBuV/m)	Peak
	5.875GHz-5.925GHz	10dBm/MHz to -27*dBm/MHz (105.6dBuV/m to 68.2* dBuV/m)	Peak
	Above 5.925GHz	-27 dBm/MHz(68.2dBuV/m)@3m	Peak

* Increase/Decreases with the linearity of the frequency.

For emission above 1GHz and in restricted band, according to FCC KDB 789033 D02 General UNII Test Procedure, all emission that complies with both the average and peak limits of Section 15.209 is not required to satisfy the -27 dBm/MHz peak emission limit. $E[dB\mu V/m] = EIRP[dBm] + 95.2$, for $d = 3$ meters.

TEST CONFIGURATION

Radiated:

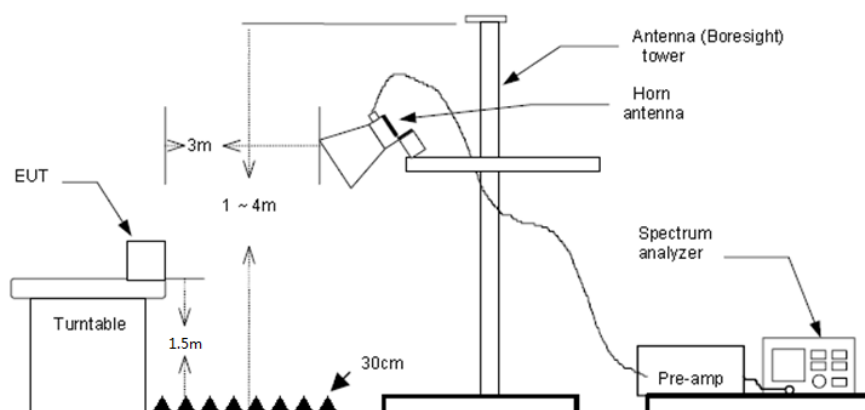

Conducted :

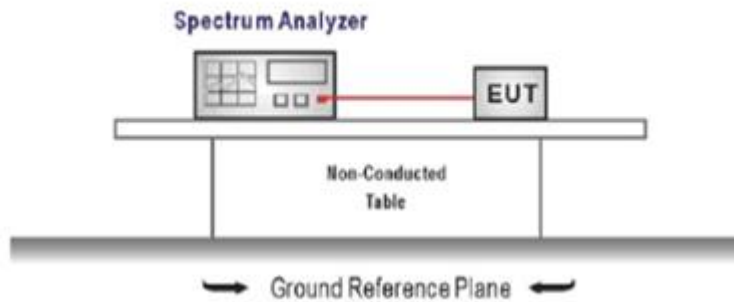

TEST PROCEDURE

1. The EUT was setup and tested according to ANSI C63.10:2013 requirements.
2. The EUT is placed on a turn table which is 1.5 meter above ground. The turn table is rotated 360 degrees to determine the position of the maximum emission level.
3. The EUT was positioned such that the distance from antenna to the EUT was 3 meters.
4. The antenna is scanned from 1 meter to 4 meters to find out the maximum emission level. This is repeated for both horizontal and vertical polarization of the antenna. In order to find the maximum emission, all of the interface cables were manipulated according to ANSI C63.10:2013 on radiated measurement.
5. The receiver set as follow:
RBW=1MHz, VBW=3MHz PEAK detector for Peak value.
RBW=1MHz, VBW=3MHz RMS detector for Average value.

TEST MODE:

Please refer to the clause 4.3

TEST RESULTS

Passed **Not Applicable**

Conducted Band Edge Test Data

Please refer to appendix F on the appendix report

Radiated Band Edge Test Data

Band: I		Worst mode: 802.11a			Test channel: CH _L		
Frequency (MHz)	Read Level (dBuV)	Level (dBuV/m)	Limit Line (dBuV/m)	Margin Limit (dB)	Factor (dB)	Test value	Polarization
5150.00	24.96	33.85	68.20	34.35	8.89	Vertical	Peak
5150.00	18.97	27.86	54.00	26.14	8.89	Vertical	Average
5150.00	26.07	34.96	68.20	33.24	8.89	Horizontal	Peak
5150.00	21.19	30.08	54.00	23.92	8.89	Horizontal	Average

Band: I		Worst mode: 802.11a			Test channel: CH _H		
Frequency (MHz)	Read Level (dBuV)	Level (dBuV/m)	Limit Line (dBuV/m)	Margin Limit (dB)	Factor (dB)	Test value	Polarization
5350.00	25.38	33.92	54.00	20.08	8.54	Vertical	Peak
5350.00	18.55	27.09	54.00	26.91	8.54	Vertical	Average
5350.00	23.91	32.45	68.20	35.75	8.54	Horizontal	Peak
5350.00	18.71	27.25	54.00	26.75	8.54	Horizontal	Average

Band: IV		Worst mode: 802.11a			Test channel: CH _L		
Frequency (MHz)	Read Level (dBuV)	Level (dBuV/m)	Limit Line (dBuV/m)	Margin Limit (dB)	Factor (dB)	Test value	Polarization
5725.00	24.26	33.26	68.20	34.94	9.00	Vertical	Peak
5725.00	19.11	28.11	54.00	25.89	9.00	Vertical	Average
5725.00	24.99	33.99	68.20	34.21	9.00	Horizontal	Peak
5725.00	18.64	27.64	54.00	26.36	9.00	Horizontal	Average

Band: IV		Worst mode: 802.11a			Test channel: CH _H		
Frequency (MHz)	Read Level (dBuV)	Level (dBuV/m)	Limit Line (dBuV/m)	Margin Limit (dB)	Factor (dB)	Test value	Polarization
5850.00	27.18	36.95	68.20	31.25	9.77	Vertical	Peak
5850.00	17.70	27.47	54.00	26.53	9.77	Vertical	Average
5850.00	24.81	34.58	68.20	33.62	9.77	Horizontal	Peak
5850.00	17.44	27.21	54.00	26.79	9.77	Horizontal	Average

Remark:

1. Final Level = Receiver Read level + Factor
2. The emission levels of other frequencies are very lower than the limit and not show in test report.
3. Test 802.11a, 802.11n, 802.11ac mode, all modulations have been tested, only worst case is reported

5.8. Radiated Spurious Emissions

LIMIT

FCC CFR Title 47 Part 15 Subpart C Section 15.209 and Part 15 Subpart E Section 15.407

Frequency	Limit (dBuV/m)	Value
0.009 MHz ~0.49 MHz	2400/F(kHz) @300m	Quasi-peak
0.49 MHz ~ 1.705 MHz	24000/F(kHz) @30m	Quasi-peak
1.705 MHz ~30 MHz	30 @30m	Quasi-peak

Note: Limit dBuV/m @3m = Limit dBuV/m @300m + 40*log(300/3)= Limit dBuV/m @300m +80,

Limit dBuV/m @3m = Limit dBuV/m @30m +40*log(30/3)= Limit dBuV/m @30m + 40.

Unwanted emissions below 1GHz and Restricted band emissions above 1GHz		
Frequency	Limit (dBuV/m @3m)	Value
30MHz-88MHz	40.00	Quasi-peak
88MHz-216MHz	43.50	Quasi-peak
216MHz-960MHz	46.00	Quasi-peak
960MHz-1GHz	54.00	Quasi-peak
Above 1GHz	54.00	Average
	74.00	Peak

TEST CONFIGURATION

- 9KHz ~30MHz

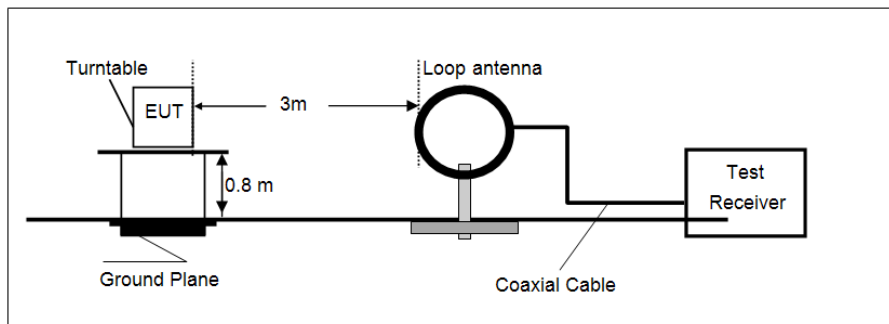

- 30MHz ~ 1GHz

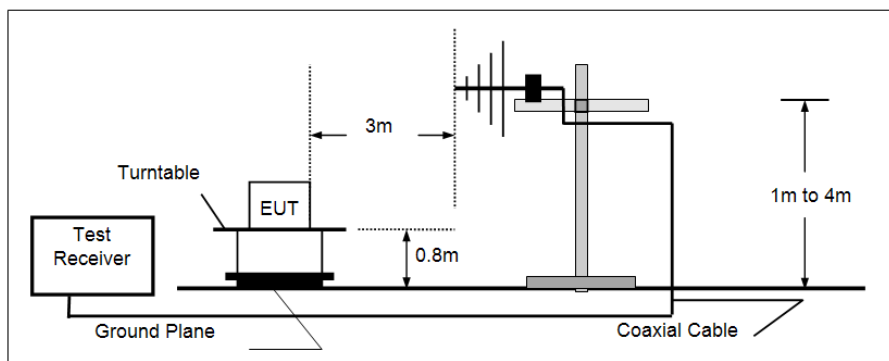

➤ Above 1GHz

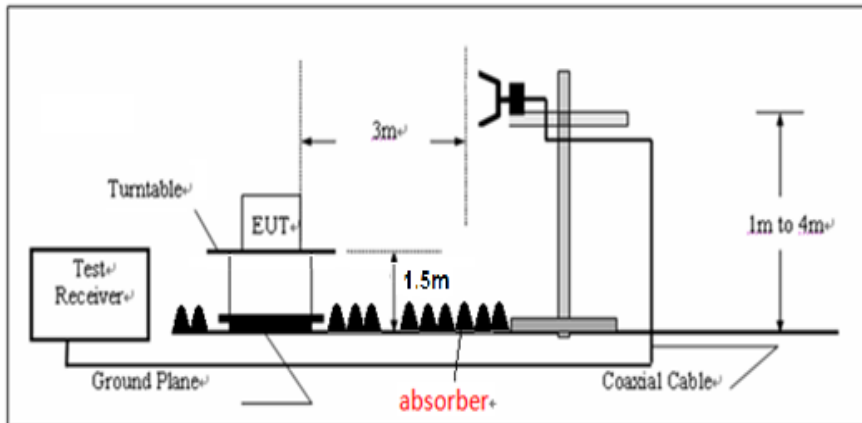
**TEST PROCEDURE**

1. The EUT was setup and tested according to ANSI C63.10:2013
2. The EUT is placed on a turn table which is 0.8 meter above ground for below 1 GHz, and 1.5 m for above 1 GHz. The turn table is rotated 360 degrees to determine the position of the maximum emission level.
3. The EUT was set 3 meters from the receiving antenna, which was mounted on the top of a variable height antenna tower.
4. For each suspected emission, the EUT was arranged to its worst case and then tune the Antenna tower (from 1 m to 4 m) and turntable (from 0 degree to 360 degrees) to find the maximum reading. A pre-amp and a high pass filter are used for the test in order to get better signal level to comply with the guidelines.
5. Set to the maximum power setting and enable the EUT transmit continuously.
6. Use the following spectrum analyzer settings
 - a) Span shall wide enough to fully capture the emission being measured;
 - b) Below 1 GHz:
RBW=120 kHz, VBW=300 kHz, Sweep=auto, Detector function=peak, Trace=max hold;
If the emission level of the EUT measured by the peak detector is 3 dB lower than the applicable limit, the peak emission level will be reported. Otherwise, the emission measurement will be repeated using the quasi-peak detector and reported.
 - c) From 1 GHz to 10th harmonic:
RBW=1MHz, VBW=3MHz Peak detector for Peak value.
RBW=1MHz, VBW=3MHz RMS detector for Average value.

TEST MODE:

Please refer to the clause 4.3

TEST RESULT

Passed Not Applicable

TEST Data**TEST DATA FOR 9 kHz ~ 30 MHz**

The low frequency, which started from 9 kHz to 30MHz, was pre-scanned and the result which was 20dB lower than the limit line per 15.31(o) was not reported.

TEST DATA FOR 30MHz-1GHz

Polarization:

Horizontal

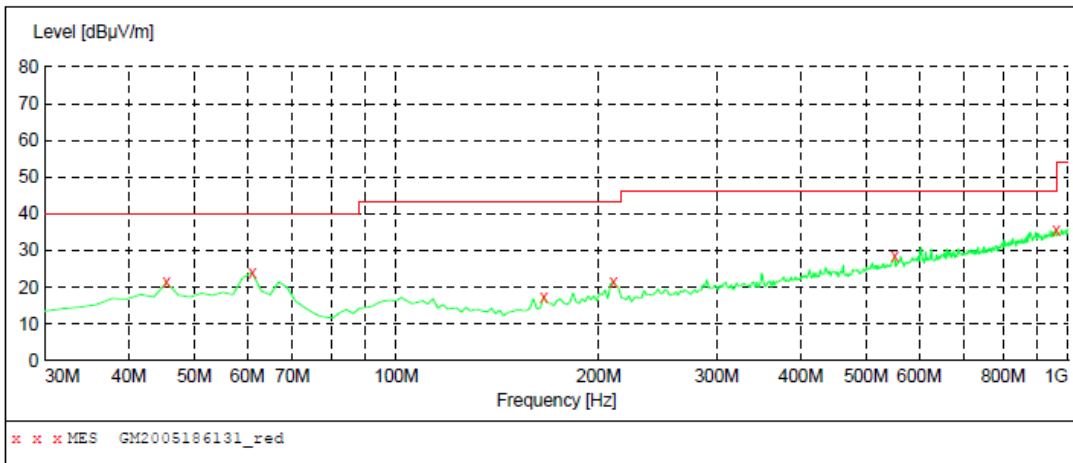

MEASUREMENT RESULT: "GM2005186131_red"

5/19/2020 1:38AM

Frequency MHz	Level dBuV/m	Transd dB	Limit dBuV/m	Margin dB	Det.	Height cm	Azimuth deg	Polarization
45.520000	21.30	-8.4	40.0	18.7	QP	100.0	76.00	HORIZONTAL
61.040000	24.00	-9.7	40.0	16.0	QP	100.0	151.00	HORIZONTAL
165.800000	17.50	-12.5	43.5	26.0	QP	100.0	185.00	HORIZONTAL
210.420000	21.40	-9.9	43.5	22.1	QP	100.0	261.00	HORIZONTAL
551.860000	28.50	0.2	46.0	17.5	QP	100.0	276.00	HORIZONTAL
959.260000	35.50	8.4	46.0	10.5	QP	100.0	65.00	HORIZONTAL

Polarization:

Vertical

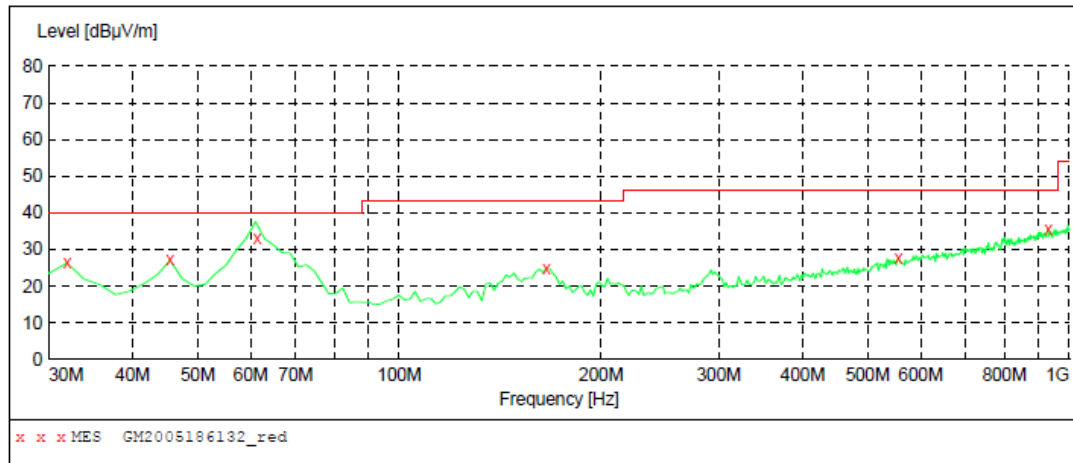

MEASUREMENT RESULT: "GM2005186132_red"

5/19/2020 1:41AM

Frequency MHz	Level dBuV/m	Transd dB	Limit dBuV/m	Margin dB	Det.	Height cm	Azimuth deg	Polarization
31.940000	26.30	-12.7	40.0	13.7	QP	100.0	257.00	VERTICAL
45.520000	27.10	-8.4	40.0	12.9	QP	100.0	12.00	VERTICAL
61.280000	33.10	-9.7	40.0	6.9	QP	100.0	321.00	VERTICAL
165.800000	24.90	-12.5	43.5	18.6	QP	100.0	0.00	VERTICAL
555.740000	27.60	0.3	46.0	18.4	QP	100.0	3.00	VERTICAL
930.160000	35.60	7.8	46.0	10.4	QP	100.0	294.00	VERTICAL

Remark:

Transd=Cable lose+ Antenna factor- Pre-amplifier; Margin=Limit -Level

TEST DATA FOR Above 1GHz

Band: I Worst mode: 802.11a Test channel: CH _L							
Frequency (MHz)	Read Level (dBuV)	Level (dBuV/m)	Limit Line (dBuV/m)	Margin Limit (dB)	Factor (dB)	Test value	Polarization
1346.63	23.39	17.82	74.00	56.18	-5.57	Vertical	Peak
3185.50	29.92	30.68	68.20	37.52	0.76	Vertical	Peak
5200.63	28.05	37.03	68.20	31.17	8.98	Vertical	Peak
7133.50	29.27	43.89	68.20	24.31	14.62	Vertical	Peak
1312.84	23.31	17.74	74.00	56.26	-5.57	Horizontal	Peak
3203.13	30.14	30.94	68.20	37.24	0.80	Horizontal	Peak
5136.00	27.70	36.56	74.00	37.44	8.86	Horizontal	Peak
7026.28	28.65	42.89	68.20	25.31	14.24	Horizontal	Peak
Band: I Worst mode: 802.11a Test channel: CH _M							
Frequency (MHz)	Read Level (dBuV)	Level (dBuV/m)	Limit Line (dBuV/m)	Margin Limit (dB)	Factor (dB)	Test value	Polarization
1223.25	23.17	17.40	74.00	56.60	-5.77	Vertical	Peak
3192.84	29.92	30.72	68.20	37.48	0.80	Vertical	Peak
5081.66	28.06	36.69	74.00	37.31	8.63	Vertical	Peak
6642.94	28.55	41.84	68.20	26.36	13.29	Vertical	Peak
1396.56	24.03	18.45	74.00	55.55	-5.58	Horizontal	Peak
3182.56	30.36	31.11	68.20	37.09	0.75	Horizontal	Peak
5153.63	27.88	36.78	68.20	31.42	8.90	Horizontal	Peak
7157.00	28.95	43.70	68.20	24.50	14.75	Horizontal	Peak
Band: I Worst mode: 802.11a Test channel: CH _H							
Frequency (MHz)	Read Level (dBuV)	Level (dBuV/m)	Limit Line (dBuV/m)	Margin Limit (dB)	Factor (dB)	Test value	Polarization
1314.31	23.09	17.52	74.00	56.48	-5.57	Vertical	Peak
3144.38	30.07	30.62	68.20	37.58	0.55	Vertical	Peak
4865.75	28.69	35.83	74.00	38.17	7.14	Vertical	Peak
6685.53	28.44	41.86	68.20	26.34	13.42	Vertical	Peak
1239.41	23.90	18.17	74.00	55.83	-5.73	Horizontal	Peak
3166.41	30.42	31.09	68.20	37.11	0.67	Horizontal	Peak
4865.75	27.92	35.06	74.00	38.94	7.14	Horizontal	Peak
6801.56	29.04	42.25	68.20	25.95	13.21	Horizontal	Peak

Remark:

1. Final Level = Receiver Read level + Antenna Factor + Cable Loss – Preamplifier Factor
2. The emission levels of other frequencies are very lower than the limit and not show in test report.
3. Measuring frequencies from 1 GHz to 40GHz.
4. Test 802.11a, 802.11n, 802.11ac mode, all modulations have been tested, only worst case is reported

Band: IV		Worst mode: 802.11a			Test channel: CH _L		
Frequency (MHz)	Read Level (dBuV)	Level (dBuV/m)	Limit Line (dBuV/m)	Margin Limit (dB)	Factor (dB)	Test value	Polarization
1251.16	23.43	17.73	68.20	50.47	-5.70	Vertical	Peak
3141.44	30.33	30.87	68.20	37.33	0.54	Vertical	Peak
5227.06	27.78	36.62	68.20	31.58	8.84	Vertical	Peak
6645.88	28.94	42.24	68.20	25.96	13.30	Vertical	Peak
1293.75	23.71	18.12	68.20	50.08	-5.59	Horizontal	Peak
3209.00	30.41	31.14	68.20	37.06	0.73	Horizontal	Peak
5089.00	27.71	36.41	74.00	37.59	8.70	Horizontal	Peak
6662.03	29.45	42.80	68.20	25.40	13.35	Horizontal	Peak
Band: IV		Worst mode: 802.11a			Test channel: CH _M		
Frequency (MHz)	Read Level (dBuV)	Level (dBuV/m)	Limit Line (dBuV/m)	Margin Limit (dB)	Factor (dB)	Test value	Polarization
1252.63	24.13	18.44	68.20	49.76	-5.69	Vertical	Peak
3125.28	30.32	30.77	68.20	37.43	0.45	Vertical	Peak
4780.56	28.47	35.39	74.00	38.61	6.92	Vertical	Peak
6710.50	29.83	43.27	68.20	24.93	13.44	Vertical	Peak
1277.59	23.90	18.27	68.20	49.93	-5.63	Horizontal	Peak
3164.94	31.61	32.27	68.20	35.93	0.66	Horizontal	Peak
5125.72	28.37	37.22	74.00	36.78	8.85	Horizontal	Peak
7187.84	28.49	43.41	68.20	24.79	14.92	Horizontal	Peak
Band: IV		Worst mode: 802.11a			Test channel: CH _H		
Frequency (MHz)	Read Level (dBuV)	Level (dBuV/m)	Limit Line (dBuV/m)	Margin Limit (dB)	Factor (dB)	Test value	Polarization
1276.13	23.36	17.73	68.20	50.47	-5.63	Vertical	Peak
3159.06	30.55	31.18	68.20	37.02	0.63	Vertical	Peak
5228.53	28.08	36.91	68.20	31.29	8.83	Vertical	Peak
7287.72	28.82	43.86	74.00	30.14	15.04	Vertical	Peak
1271.72	23.88	18.24	68.20	49.96	-5.64	Horizontal	Peak
3147.31	30.58	31.15	68.20	37.05	0.57	Horizontal	Peak
5096.34	27.66	36.43	74.00	37.57	8.77	Horizontal	Peak
6988.09	27.99	42.15	68.20	26.05	14.16	Horizontal	Peak

Remark:

1. Final Level = Receiver Read level + Antenna Factor + Cable Loss – Preamplifier Factor
2. The emission levels of other frequencies are very lower than the limit and not show in test report.
3. Measuring frequencies from 1 GHz to 40GHz.
4. Test 802.11a, 802.11n, 802.11ac mode, all modulations have been tested, only worst case is reported

5.9. Frequency stability

LIMIT

Within Operation Band

TEST CONFIGURATION

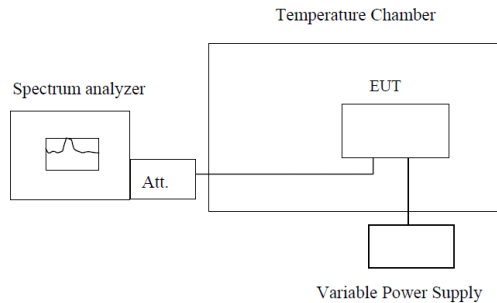

Note : Measurement setup for testing on Antenna connector

TEST PROCEDURE

1. The equipment under test was connected to an external power supply.
2. RF output was connected to a frequency counter or spectrum analyzer via feed through attenuators.
3. The EUT was placed inside the temperature chamber.
4. Set the spectrum analyzer RBW low enough to obtain the desired frequency resolution and measure EUT 25°C operating frequency as reference frequency.
5. Turn EUT off and set the chamber temperature to -20°C. After the temperature stabilized for approximately 30 minutes recorded the frequency.
6. Repeat step measure with 10°C increased per stage until the highest temperature of +50°C reached..

TEST MODE:

Please refer to the clause 4.3

TEST RESULT

Passed Not Applicable

Please refer to appendix G on the appendix report

6. TEST SETUP PHOTOS

Radiated Emission

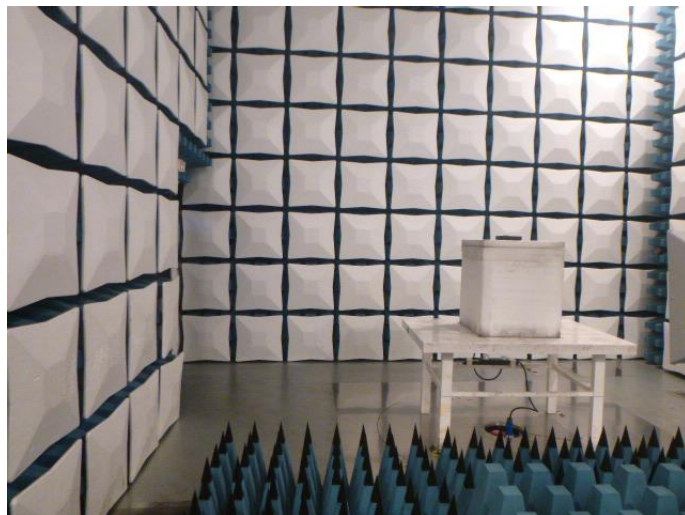

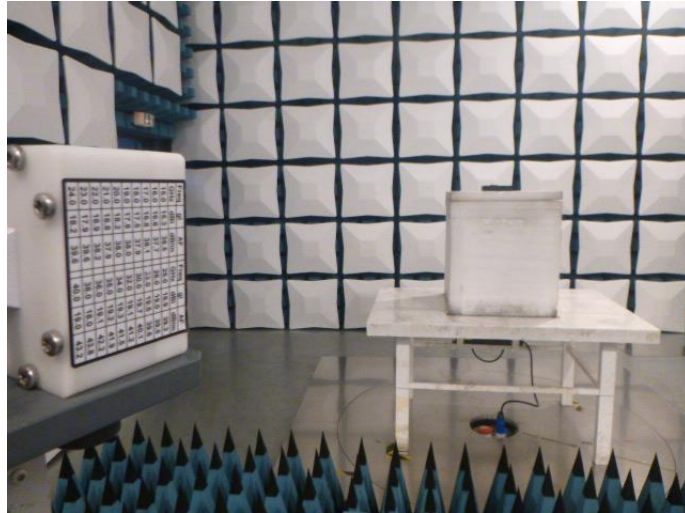

AC Conducted Emission



7. EXTERANAL AND INTERNAL PHOTOS

Reference to the test report No. : CHTEW20050073.

8. APPENDIX REPORT