



# FCC TEST REPORT

For

Hyundai Technology Group, Inc.

Tablet

Test Model: 10LB2

Additional Model No.: HT10LB2MBKLTM02

Prepared for : Hyundai Technology Group, Inc.  
Address : 2601 Walnut Ave. Tustin, California, United States

Prepared by : Shenzhen LCS Compliance Testing Laboratory Ltd.  
Address : 101, 201 Bldg A & 301 Bldg C, Juji Industrial Park Yabianxueziwei,  
Shajing Street, Baoan District, Shenzhen, 518000, China

Tel : (+86)755-82591330  
Fax : (+86)755-82591332  
Web : www.LCS-cert.com  
Mail : webmaster@LCS-cert.com

Date of receipt of test sample : July 14, 2023  
Number of tested samples : 2  
Sample No. : A062823153-1, A062823153-2  
Serial number : Prototype  
Date of Test : July 14, 2023 ~ July 26, 2023  
Date of Report : July 27, 2023





FCC TEST REPORT
FCC CFR 47 PART 15E (15.407)

Report Reference No. : LCSA062823153EE
Date of Issue : July 27, 2023

Testing Laboratory Name : Shenzhen LCS Compliance Testing Laboratory Ltd.
Address : 101, 201 Bldg A & 301 Bldg C, Juji Industrial Park Yabianxueziwei, Shajing Street, Baoan District, Shenzhen, 518000, China
Testing Location/ Procedure : Full application of Harmonised standards
Partial application of Harmonised standards
Other standard testing method

Applicant's Name : Hyundai Technology Group, Inc.
Address : 2601 Walnut Ave. Tustin, California, United States

Test Specification
Standard : FCC CFR 47 PART 15E (15.407)
Test Report Form No. : LCSEMC-1.0
TRF Originator : Shenzhen LCS Compliance Testing Laboratory Ltd.
Master TRF : Dated 2011-03

Shenzhen LCS Compliance Testing Laboratory Ltd. All rights reserved.
This publication may be reproduced in whole or in part for non-commercial purposes as long as the Shenzhen LCS Compliance Testing Laboratory Ltd. is acknowledged as copyright owner and source of the material.

EUT Description : Tablet
Trade Mark : HYUNDAI
Test Model : 10LB2
Ratings : Input: 5.0V=2.0A
For AC Adapter Input: AC 100-240V, 50/60Hz, 0.5A
Adapter Output: 5V=2.0A, 10.0W
DC 3.8V by Rechargeable Li-ion Battery, 5000mAh
Result : Positive

Compiled by:

Kevin Huang

Kevin Huang/ Administrator

Supervised by:

Cary Luo

Cary Luo/ Technique principal

Approved by:

Gavin Liang

Gavin Liang/ Manager





### FCC -- TEST REPORT

<b>Test Report No. :</b> LCSA062823153EE	July 27, 2023 Date of issue
--	--------------------------------

EUT.....	: Tablet
Test Model.....	: 10LB2
<b>Applicant.....</b>	<b>: Hyundai Technology Group, Inc.</b>
Address.....	: 2601 Walnut Ave. Tustin, California, United States
Telephone.....	: /
Fax.....	: /
<b>Manufacturer.....</b>	<b>: Hyundai Technology Group, Inc.</b>
Address.....	: 2601 Walnut Ave. Tustin, California, United States
Telephone.....	: /
Fax.....	: /
<b>Factory.....</b>	<b>: /</b>
Address.....	: /
Telephone.....	: /
Fax.....	: /

<b>Test Result:</b>	<b>Positive</b>
---------------------	-----------------

The test report merely corresponds to the test sample.  
It is not permitted to copy extracts of these test result without the written permission of the test laboratory.





### Revision History

Report Version	Issue Date	Revision Content	Revised By
000	July 27, 2023	Initial Issue	---





# TABLE OF CONTENTS

- 1. GENERAL INFORMATION ..... 6**
  - 1.1. DESCRIPTION OF DEVICE (EUT) ..... 6
  - 1.2. SUPPORT EQUIPMENT LIST ..... 9
  - 1.3. EXTERNAL I/O PORT ..... 9
  - 1.4. DESCRIPTION OF TEST FACILITY ..... 9
  - 1.5. STATEMENT OF THE MEASUREMENT UNCERTAINTY ..... 9
  - 1.6. MEASUREMENT UNCERTAINTY ..... 10
  - 1.7. DESCRIPTION OF TEST MODES ..... 10
  - 1.8. CHANNEL LIST AND FREQUENCY ..... 11
- 2. TEST METHODOLOGY ..... 12**
  - 2.1. EUT CONFIGURATION ..... 12
  - 2.2. EUT EXERCISE ..... 12
  - 2.3. GENERAL TEST PROCEDURES ..... 12
- 3. SYSTEM TEST CONFIGURATION ..... 13**
  - 3.1. JUSTIFICATION ..... 13
  - 3.2. EUT EXERCISE SOFTWARE ..... 13
  - 3.3. SPECIAL ACCESSORIES ..... 13
  - 3.4. BLOCK DIAGRAM/SCHEMATICS ..... 13
  - 3.5. EQUIPMENT MODIFICATIONS ..... 13
  - 3.6. TEST SETUP ..... 13
- 4. SUMMARY OF TEST RESULTS ..... 14**
- 5. TEST RESULT ..... 15**
  - 5.1. 26dB OCCUPIED BANDWIDTH MEASUREMENT ..... 15
  - 5.2. MAXIMUM CONDUCTED OUTPUT POWER MEASUREMENT ..... 16
  - 5.3. POWER SPECTRAL DENSITY MEASUREMENT ..... 18
  - 5.4. 99% OCCUPIED BANDWIDTH MEASUREMENT ..... 20
  - 5.5. RADIATED EMISSIONS MEASUREMENT ..... 21
  - 5.6. POWER LINE CONDUCTED EMISSIONS ..... 33
  - 5.7 EMISSIONS IN RESTRICTED BANDS ..... 36
  - 5.8. FREQUENCY STABILITY ..... 39
  - 5.9. ON TIME AND DUTY CYCLE ..... 40
  - 5.10. ANTENNA REQUIREMENTS ..... 41
- 6. LIST OF MEASURING EQUIPMENTS ..... 42**
- 7. TEST SETUP PHOTOGRAPHS OF EUT ..... 43**
- 8. EXTERIOR PHOTOGRAPHS OF THE EUT ..... 43**
- 9. INTERIOR PHOTOGRAPHS OF THE EUT ..... 43**





## 1. GENERAL INFORMATION

### 1.1. Description of Device (EUT)

EUT	: Tablet
Test Model	: 10LB2
Additional Model No.	: HT10LB2MBKLTMO2
Model Declaration	: PCB board, structure and internal of these model(s) are the same, So no additional models were tested
Power Supply	: Input: 5.0V $\overline{\text{---}}$ 2.0A For AC Adapter Input: AC 100-240V, 50/60Hz, 0.5A Adapter Output: 5V $\overline{\text{---}}$ 2.0A, 10.0W DC 3.8V by Rechargeable Li-ion Battery, 5000mAh
Hardware Version	: P612C2
Software Version	: /

#### Bluetooth

Frequency Range	: 2402MHz~2480MHz
Channel Number	: 79 channels for Bluetooth V5.0 (DSS) 40 channels for Bluetooth V5.0 (DTS)
Channel Spacing	: 1MHz for Bluetooth V5.0 (DSS) 2MHz for Bluetooth V5.0 (DTS)
Modulation Type	: GFSK, $\pi/4$ -DQPSK, 8-DPSK for Bluetooth V5.0 (DSS) GFSK for Bluetooth V5.0 (DTS)
Bluetooth Version	: V5.0
Antenna Description	: FPC Antenna, -2.71dBi (max.)

#### WIFI(2.4G Band)

Frequency Range	: 2412MHz~2462MHz
Channel Spacing	: 5MHz
Channel Number	: 11 Channels for 20MHz bandwidth (2412~2462MHz) 7 Channels for 40MHz bandwidth (2422~2452MHz)
Modulation Type	: IEEE 802.11b: DSSS (CCK, DQPSK, DBPSK) IEEE 802.11g: OFDM (64QAM, 16QAM, QPSK, BPSK) IEEE 802.11n: OFDM (64QAM, 16QAM, QPSK, BPSK)
Antenna Description	: FPC Antenna, -2.71dBi (max.)

#### 5.2G WLAN

Frequency Range	: 5180MHz~5240MHz
Channel Number	: 4 Channels for 20MHz bandwidth(5180MHz~5240MHz) 2 channels for 40MHz bandwidth(5190MHz~5230MHz) 1 channels for 80MHz bandwidth(5210MHz)
Modulation Type	: IEEE 802.11a: OFDM (64QAM, 16QAM, QPSK, BPSK)





IEEE 802.11n: OFDM (64QAM, 16QAM, QPSK, BPSK)  
 IEEE 802.11ac: OFDM (256QAM, 64QAM, 16QAM, QPSK, BPSK)  
 Antenna Description : FPC Antenna, -2.76dBi (max.)

5.8G WLAN

Frequency Range : 5745MHz~5825MHz  
 Channel Number : 5 channels for 20MHz bandwidth(5745MHz~5825MHz)  
 2 channels for 40MHz bandwidth(5755MHz~5795MHz)  
 1 channels for 80MHz bandwidth(5775MHz)

Modulation Type : IEEE 802.11a: OFDM (64QAM, 16QAM, QPSK, BPSK)  
 IEEE 802.11n: OFDM (64QAM, 16QAM, QPSK, BPSK)  
 IEEE 802.11ac: OFDM (256QAM, 64QAM, 16QAM, QPSK, BPSK)

Antenna Description : FPC Antenna, -1.27dBi (max.)

2G

Support Band : GSM 900 (EU-Band) DCS 1800 (EU-Band)  
GSM 850 (U.S.-Band) PCS 1900 (U.S.-Band)

Release Version : R99

GPRS Class : Class 12

EGPRS Class : Class 12

Type Of Modulation : GMSK for GSM/GPRS; GMSK/8PSK for EGPRS

Antenna Description : FPC Antenna  
 0.8dBi (max.) For GSM 850  
 1.3dBi (max.) For PCS 1900

3G

Support Band : WCDMA Band I (EU-Band)  
WCDMA Band II (U.S.-Band)  
WCDMA Band V (U.S.-Band)

Release Version : R9

Type Of Modulation : QPSK,16QAM

Antenna Description : FPC Antenna  
 1.3dBi (max.) For WCDMA Band II  
 0.8dBi (max.) For WCDMA Band V

LTE

Support Band : E-UTRA Band 2(U.S.-Band)  
E-UTRA Band 3(Non U.S.-Band)  
E-UTRA Band 4(U.S.-Band)  
E-UTRA Band 5(U.S.-Band)  
E-UTRA Band 7(U.S.-Band)  
E-UTRA Band 28(Non U.S.-Band)

LTE Release Version : R12

Type Of Modulation : QPSK/16QAM





Antenna Description : FPC Antenna  
1.3dBi (max.) For E-UTRA Band 2  
1.5dBi (max.) For E-UTRA Band 4  
0.8dBi (max.) For E-UTRA Band 5  
1.5dBi (max.) For E-UTRA Band 7

Power Class : Class 3

Extreme temp. : -30°C to +50°C

Tolerance

Extreme vol. Limits : 3.4VDC to 4.2VDC (nominal: 3.8VDC)







## 1.2. Support equipment List

Manufacturer	Description	Model	Serial Number	Certificate
---	Adapter	---	---	FCC

## 1.3. External I/O Port

I/O Port Description	Quantity	Cable
Type-C USB Port	1	USB Cable: 0.8m, unshielded
Earphone Jack	1	N/A
TF Card Slot	1	N/A
SIM Card Slot	1	N/A

## 1.4. Description of Test Facility

NVLAP Accreditation Code is 600167-0.  
 FCC Designation Number is CN5024.  
 CAB identifier is CN0071.  
 CNAS Registration Number is L4595.  
 Test Firm Registration Number: 254912.

The 3m-Semi anechoic test site fulfils CISPR 16-1-4 according to ANSI C63.4:2014 and CISPR 16-1-4:2010 SVSWR requirement for radiated emission above 1GHz.

## 1.5. Statement of the Measurement Uncertainty

The data and results referenced in this document are true and accurate. The reader is cautioned that there may be errors within the calibration limits of the equipment and facilities. The measurement uncertainty was calculated for all measurements listed in this test report acc. To CISPR 16 – 4 “Specification for radio disturbance and immunity measuring apparatus and methods – Part 4: Uncertainty in EMC Measurements” and is documented in the LCS quality system acc. To DIN EN ISO/IEC 17025. Furthermore, component and process variability of devices similar to that tested may result in additional deviation. The manufacturer has the sole responsibility of continued compliance of the device.





## 1.6. Measurement Uncertainty

Test Item	Frequency Range	Uncertainty	Note
Radiation Uncertainty	9KHz~30MHz	±3.10dB	(1)
	30MHz~200MHz	±2.96dB	(1)
	200MHz~1000MHz	±3.10dB	(1)
	1GHz~26.5GHz	±3.80dB	(1)
	26.5GHz~40GHz	±3.90dB	(1)
Conduction Uncertainty	150kHz~30MHz	±1.63dB	(1)
Power disturbance	30MHz~300MHz	±1.60dB	(1)
Output power	1GHz-40GHz	±0.57dB	(1)
Power Spectral Density	1GHz-40GHz	±1.2dB	(1)
Occupied Channel Bandwidth	1GHz-40GHz	±5%	(1)
Conducted RF Spurious Emission	9kHz-40GHz	±1.80dB	(1)
Emissions in Restricted Bands	1GHz-40GHz	±2.47dB	(1)
Frequency Stability	1GHz-40GHz	±25Hz	(1)

(1). This uncertainty represents an expanded uncertainty expressed at approximately the 95% confidence level using a coverage factor of k=2.

## 1.7. Description of Test Modes

The EUT has been tested under operating condition.

This test was performed with EUT in X, Y, Z position and the worst case was found when EUT in X position.

Pre-test AC conducted emission at both voltage AC 120V/60Hz and AC 240V/50Hz, recorded worst case.

AC conducted emission pre-test at power adapter modes, recorded worst case;

Worst-case mode and channel used for 150 KHz-30 MHz power line conducted emissions was determined to be IEEE 802.11a mode (Low Channel).

Worst-case mode and channel used for 9 KHz-1000 MHz radiated emissions was determined to be IEEE 802.11a mode (Low Channel).

Worst-Case data rates were utilized from preliminary testing of the Chipset, worst-case data rates used during the testing are as follows:

IEEE 802.11a Mode: 6 Mbps, OFDM.

IEEE 802.11n HT20 Mode: MCS0, OFDM.

IEEE 802.11n HT40 Mode: MCS0, OFDM.

IEEE 802.11ac VHT20 Mode: MCS0

IEEE 802.11ac VHT40 Mode: MCS0, OFDM.

IEEE 802.11ac VHT80 Mode: MCS0, OFDM.





### 1.8. Channel List and Frequency

Frequency Band	Channel No.	Frequency (MHz)	Channel No.	Frequency (MHz)
5180~5240MHz	36	5180	44	5220
	38	5190	46	5230
	40	5200	48	5240
	42	5210	/	/

For IEEE 802.11a/n HT20/ac VHT20, Channel 36, 40 and 48 were tested.

For IEEE 802.11n HT40/ac VHT40, Channel 38 and 46 were tested.

For IEEE 802.11ac VHT80, Channel 42 was tested.





## 2. TEST METHODOLOGY

All measurements contained in this report were conducted with ANSI C63.10-2013, American National Standard of Procedures for Compliance Testing of Unlicensed Wireless Devices.

The radiated testing was performed at an antenna-to-EUT distance of 3 meters. All radiated and conducted emissions measurement was performed at Shenzhen LCS Compliance Testing Laboratory Ltd.

### 2.1. EUT Configuration

The EUT configuration for testing is installed on RF field strength measurement to meet the Commissions requirement and operating in a manner that intends to maximize its emission characteristics in a continuous normal application.

### 2.2. EUT Exercise

The EUT was operated in the engineering mode to fix the TX frequency that was for the purpose of the measurements.

According to FCC's request, Test Procedure KDB789033 D02 General UNII Test Procedures New Rules v02r01 and KDB 662911 D01 Multiple Transmitter Output v02r01 are required to be used for this kind of FCC 15.407 UII device.

According to its specifications, the EUT must comply with the requirements of the Section 15.203, 15.205, 15.207, 15.209 and 15.407 under the FCC Rules Part 15 Subpart E.

### 2.3. General Test Procedures

#### 2.3.1 Conducted Emissions

The EUT is placed on the turntable, which is 0.8 m above ground plane. According to the requirements in Section 6.2.1 of ANSI C63.10-2013 Conducted emissions from the EUT measured in the frequency range between 0.15 MHz and 30MHz using Quasi-peak and average detector modes.

#### 2.3.2 Radiated Emissions

The EUT is placed on a turn table, which is 0.8 m above ground plane below 1GHz and 1.5 m above ground plane above 1GHz. The turntable shall rotate 360 degrees to determine the position of maximum emission level. EUT is set 3m away from the receiving antenna, which varied from 1m to 4m to find out the highest emission. And also, each emission was to be maximized by changing the polarization of receiving antenna both horizontal and vertical. In order to find out the maximum emissions, exploratory radiated emission measurements were made according to the requirements in Section 6.3 of ANSI C63.10-2013.





### 3. SYSTEM TEST CONFIGURATION

#### 3.1. Justification

The system was configured for testing in a continuous transmits condition.

#### 3.2. EUT Exercise Software

The system was configured for testing in a continuous transmits condition and change test channels by software (\*##83781#\*##) provided by application.

#### 3.3. Special Accessories

N/A

#### 3.4. Block Diagram/Schematics

Please refer to the related document

#### 3.5. Equipment Modifications

Shenzhen LCS Compliance Testing Laboratory Ltd. has not done any modification on the EUT.

#### 3.6. Test Setup

Please refer to the test setup photo.





#### 4. SUMMARY OF TEST RESULTS

Applied Standard: FCC Part 15 Subpart E			
FCC Rules	Description of Test	Result	Remark
§15.407(a)	26dB Bandwidth	Compliant	Appendix D.1
§15.407(a)	Maximum Conducted Output Power	Compliant	Appendix D.2
§15.407(a)	Power Spectral Density	Compliant	Appendix D.3
§15.209, §15.407(b)	Radiated Emissions	Compliant	Note 1
§15.207(a)	AC Conducted Emissions	Compliant	Note 1
§15.209, §15.407(b)	Emissions in Restricted Bands	Compliant	Appendix D.4
§15.407(g)	Frequency Stability	Compliant	Appendix D.5
/	On Time and Duty Cycle	/	Only reported; Appendix D.6
§15.203	Antenna Requirements	Compliant	Note 1
§15.407 §2.1093	RF Exposure	Compliant	Note 2

**Remark:**

1. Note 1 – Test results inside test report;
2. Note 2 – Test results in other test report (SAR Exposure report);



## 5. TEST RESULT

### 5.1. 26dB Occupied Bandwidth Measurement

#### 5.1.1. Standard Applicable

No restriction limits. But resolution bandwidth within band edge measurement is 1% of the 99% occupied bandwidth.

#### 5.1.2. Measuring Instruments and Setting

Please refer to equipment list in this report. The following table is the setting of the Spectrum Analyzer.

Spectrum Parameter	Setting
Attenuation	Auto
Span	> 26dB Bandwidth
Detector	Peak
Trace	Max Hold
Sweep Time	Auto

#### 5.1.3. Test Procedures

1. The transmitter output (antenna port) was connected to the spectrum analyzer in peak hold mode.
2. The RBW = 1% - 3% of occupied bandwidth, VBW = 3\*RBW;
3. Measured the spectrum width with power higher than 26dB below carrier.

#### 5.1.4. Test Setup Layout

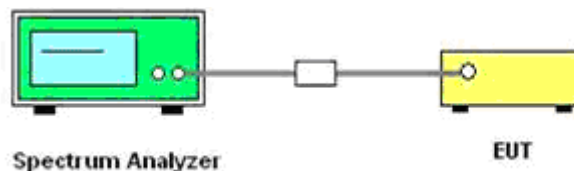

#### 5.1.5. EUT Operation during Test

The EUT was programmed to be in continuously transmitting mode.

#### 5.1.6. Test Result of 26dB Occupied Bandwidth

**PASS**

*Please refer to Appendix D.1*

*Remark:*

1. Measured 26dB bandwidth at difference data rate for each mode and recorded worst case for each mode.
2. Test results including cable loss;
3. Worst case data at IEEE 802.11a; MCS0 at IEEE 802.11n HT20, IEEE 802.11n HT40, IEEE 802.11ac VHT20, IEEE 802.11ac VHT40, IEEE 802.11ac VHT80;





## 5.2. Maximum Conducted Output Power Measurement

### 5.2.1. Standard Applicable

#### (1) For the band 5.15~5.25GHz

- (i) For an outdoor access point operating in the band 5.15-5.25 GHz, the maximum conducted output power over the frequency band of operation shall not exceed 1 W provided the maximum antenna gain does not exceed 6 dBi. If transmitting antennas of directional gain greater than 6 dBi are used, both the maximum conducted output power and the maximum power spectral density shall be reduced by the amount in dB that the directional gain of the antenna exceeds 6 dBi. The maximum e.i.r.p. at any elevation angle above 30 degrees as measured from the horizon must not exceed 125 mW (21 dBm).
- (ii) For an indoor access point operating in the band 5.15-5.25 GHz, the maximum conducted output power over the frequency band of operation shall not exceed 1 W provided the maximum antenna gain does not exceed 6 dBi. If transmitting antennas of directional gain greater than 6 dBi are used, both the maximum conducted output power and the maximum power spectral density shall be reduced by the amount in dB that the directional gain of the antenna exceeds 6 dBi.
- (iii) For fixed point-to-point access points operating in the band 5.15-5.25 GHz, the maximum conducted output power over the frequency band of operation shall not exceed 1 W. Fixed point-to-point U-NII devices may employ antennas with directional gain up to 23 dBi without any corresponding reduction in the maximum conducted output power. For fixed point-to-point transmitters that employ a directional antenna gain greater than 23 dBi, a 1dB reduction in maximum conducted output power is required for each 1 dB of antenna gain in excess of 23 dBi. Fixed, point-to-point operations exclude the use of point-to-multipoint systems, omnidirectional applications, and multiple collocated transmitters transmitting the same information. The operator of the U-NII device, or if the equipment is professionally installed, the installer, is responsible for ensuring that systems employing high gain directional antennas are used exclusively for fixed, point-to-point operations.
- (iv) For mobile and portable client devices in the 5.15-5.25 GHz band, the maximum conducted output power over the frequency band of operation shall not exceed 250 mW provided the maximum antenna gain does not exceed 6 dBi. If transmitting antennas of directional gain greater than 6 dBi are used, both the maximum conducted output power shall be reduced by the amount in dB that the directional gain of the antenna exceeds 6 dBi.

#### (2) For the band 5.25-5.35 GHz and 5.47-5.725 GHz

The maximum conducted output power over the frequency bands of operation shall not exceed the lesser of 250 mW or  $11 \text{ dBm} + 10 \log B$ , where B is the 26 dB emission bandwidth in megahertz. If transmitting antennas of directional gain greater than 6 dBi are used, both the maximum conducted output power and the maximum power spectral density shall be reduced by the amount in dB that the directional gain of the antenna exceeds 6 dBi.

### 5.2.2. Measuring Instruments and Setting

Please refer to equipment list in this report. The following table is the setting of the power meter.

### 5.2.3. Test Procedures

The transmitter output (antenna port) was connected to the power meter.

According to KDB 789033 D02 General UNII Test Procedures New Rules v02r01 Section 3 (a) Method PM (Measurement using an RF average power meter):

- (i) Measurements may be performed using a wideband RF power meter with a thermocouple detector or equivalent if all of the conditions listed below are satisfied.

- The EUT is configured to transmit continuously or to transmit with a constant duty cycle.







- At all times when the EUT is transmitting, it must be transmitting at its maximum power control level.
  - The integration period of the power meter exceeds the repetition period of the transmitted signal by at least a factor of five.
- (ii) If the transmitter does not transmit continuously, measure the duty cycle,  $x$ , of the transmitter output signal as described in section II.B.
- (iii) Measure the average power of the transmitter. This measurement is an average over both the on and off periods of the transmitter.
- (iv) Adjust the measurement in dBm by adding  $10 \log (1/x)$  where  $x$  is the duty cycle (e.g.,  $10 \log (1/0.25)$  if the duty cycle is 25%).

#### 5.2.4. Test Setup Layout

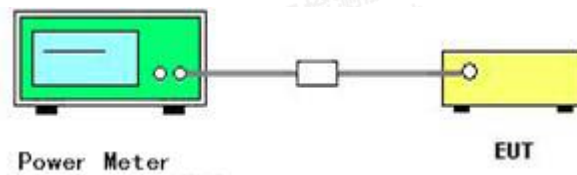

#### 5.1.5. EUT Operation during Test

The EUT was programmed to be in continuously transmitting mode.

#### 5.2.6. Test Result of Maximum Conducted Output Power

PASS

Please refer to Appendix D.2

Remark:

1. Measured output power at difference data rate for each mode and recorded worst case for each mode.
2. Test results including cable loss;
3. Worst case data at IEEE 802.11a; MCS0 at IEEE 802.11n HT20, IEEE 802.11n HT40, IEEE 802.11ac VHT20, IEEE 802.11ac VHT40, IEEE 802.11ac VHT80;
4. Report conducted power = Measured conducted average power + Duty Cycle factor;
5. For power measurements on IEEE 802.11 devices;  
Array Gain = 0 dB (i.e., no array gain) for  $NANT \leq 4$ ;  
Array Gain = 0 dB (i.e., no array gain) for channel widths  $\geq 40$  MHz for any NANT;  
Array Gain = 5 log (NANT/NSS) dB or 3 dB, whichever is less, for 20-MHz channel widths with NANT  $\geq 5$ .





## 5.3. Power Spectral Density Measurement

### 5.3.1. Standard Applicable

#### For 5.15~5.25GHz

- (i) For an outdoor access point operating in the band 5.15 - 5.25 GHz, the maximum power spectral density shall not exceed 17 dBm in any 1 MHz band.note1
- (ii) For an indoor access point operating in the band 5.15 - 5.25 GHz, the maximum power spectral density shall not exceed 17 dBm in any 1 MHz band.note1
- (iii) For fixed point-to-point access points operating in the band 5.15 - 5.25 GHz, transmitters that employ a directional antenna gain greater than 23 dBi, a 1 dB reduction in maximum power spectral density is required for each 1 dB of antenna gain in excess of 23 dBi.
- (iv) For mobile and portable client devices in the 5.15 - 5.25 GHz band, the maximum power spectral density shall not exceed 11 dBm in any 1 MHz band. note1

Note1: If transmitting antennas of directional gain greater than 6 dBi are used, the peak power spectral density shall be reduced by the amount in dB that the directional gain of the antenna exceeds 6 dBi.

#### For the band 5.25-5.35 GHz and 5.47-5.725 GHz

The maximum power spectral density shall not exceed 11 dBm in any 1 megahertz band. If transmitting antennas of directional gain greater than 6 dBi are used, the peak power spectral density shall be reduced by the amount in dB that the directional gain of the antenna exceeds 6 dBi.

### 5.3.2. Measuring Instruments and Setting

Please refer to equipment list in this report. The following table is the setting of Spectrum Analyzer.

### 5.3.3. Test Procedures

- 1). The transmitter was connected directly to a Spectrum Analyzer through a directional couple.
- 2). The power was monitored at the coupler port with a Spectrum Analyzer. The power level was set to the maximum level.
- 3). Set the RBW = 1MHz.
- 4). Set the VBW  $\geq$  3MHz
- 5). Span=Encompass the entire emissions bandwidth (EBW) of the signal (or, alternatively, the entire 99% occupied bandwidth) of the signal.
- 6). Number of points in sweep  $\geq 2 \times$  span / RBW. (This ensures that bin-to-bin spacing is  $\leq$  RBW/2, so that narrowband signals are not lost between frequency bins.)
- 7). Manually set sweep time  $\geq 10 \times$  (number of points in sweep)  $\times$  (total on/off period of the transmitted signal).
- 8). Set detector = power averaging (rms).
- 9). Sweep time = auto couple.
- 10). Trace mode = max hold.
- 11). Allow trace to fully stabilize.
- 12). Compute power by integrating the spectrum across the EBW (or, alternatively, the entire 99% occupied bandwidth) of the signal using the instrument's band power measurement function with band limits set equal to the EBW (or occupied bandwidth) band edges. If the instrument does not have a band power function, sum the spectrum levels (in power units) at 1 MHz intervals extending across the EBW (or, alternatively, levels (in power units) at 1 MHz intervals extending across the EBW (or, alternatively).
- 13). Add  $10 \log(1/x)$ , where x is the duty cycle, to the measured power in order to compute the average power during the actual transmission times (because the measurement represents an average over both the on and off times of the transmission). For example, add  $10 \log(1/0.25) = 6$  dB if the duty cycle is 25%.
- 14). Use the peak marker function to determine the maximum power level in any 1MHz band segment within the fundamental EBW.



### 5.3.4. Test Setup Layout

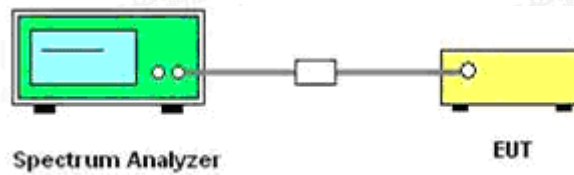

### 5.3.5. EUT Operation during Test

The EUT was programmed to be in continuously transmitting mode.

### 5.3.6. Test Result of Power Spectral Density

PASS

Please refer to Appendix D.3

#### Remark

1. Measured power spectrum density at difference data rate for each mode and recorded worst case for each mode.
2. Test results including cable loss;
3. Worst case data at IEEE 802.11a; MCS0 at IEEE 802.11n HT20, IEEE 802.11n HT40, IEEE 802.11ac VHT20, IEEE 802.11ac VHT40, IEEE 802.11ac VHT80;
4. Report conducted PSD = Measured conducted average power + Duty Cycle factor;



## 5.4. 99% Occupied Bandwidth Measurement

### 5.4.1. Standard Applicable

According to §2.1049: The occupied bandwidth, that is the frequency bandwidth such that, below its lower and above its upper frequency limits, the mean powers radiated are each equal to 0.5 percent of the total mean power radiated by a given emission shall be measured under the following conditions as applicable.

### 5.4.2. Measuring Instruments and Setting

Please refer to equipment list in this report. The following table is the setting of the Spectrum Analyzer.

Spectrum Parameter	Setting
Attenuation	Auto
Span Frequency	> RBW
Detector	Peak
Trace	Max Hold
Sweep Time	Auto

### 5.4.3. Test Procedures

1. The transmitter output (antenna port) was connected to the spectrum analyzer in peak hold mode.
2. Set RBW = 1%~5% OBW; VBW≥3\*RBW;
3. Measured the 99% occupied bandwidth by related function of the spectrum analyzer.

### 5.4.4. Test Setup Layout

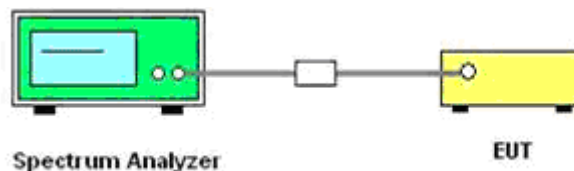

### 5.4.5. EUT Operation during Test

The EUT was programmed to be in continuously transmitting mode.

### 5.4.6. Test Result of 99% Occupied Spectrum Bandwidth

*Not Applicable*

*Remark:*

1. Measured 99% bandwidth at difference data rate for each mode and recorded worst case for each mode.
2. Test results including cable loss;
3. Worst case data at IEEE 802.11a; MCS0 at IEEE 802.11n HT20, IEEE 802.11n HT40, IEEE 802.11ac VHT20, IEEE 802.11ac VHT40, IEEE 802.11ac VHT80;





### 5.5. Radiated Emissions Measurement

#### 5.5.1. Standard Applicable

15.205 (a) Except as shown in paragraph (d) of this section, only spurious emissions are permitted in any of the frequency bands listed below:

MHz	MHz	MHz	GHz
0.090-0.110	16.42-16.423	399.9-410	4.5-5.15
\1\ 0.495-0.505	16.69475-16.69525	608-614	5.35-5.46
2.1735-2.1905	16.80425-16.80475	960-1240	7.25-7.75
4.125-4.128	25.5-25.57	1300-1427	8.025-8.5
4.17725-4.17775	37.5-38.25	1435-1626.5	9.0-9.2
4.20725-4.20775	73-74.6	1645.5-1646.5	9.3-9.5
6.215-6.218	74.8-75.2	1660-1710	10.6-12.7
6.26775-6.26825	108-121.94	1718.8-1722.2	13.25-13.4
6.31175-6.31225	123-138	2200-2300	14.47-14.5
8.291-8.294	149.9-150.05	2310-2390	15.35-16.2
8.362-8.366	156.52475-156.52525	2483.5-2500	17.7-21.4
8.37625-8.38675	156.7-156.9	2690-2900	22.01-23.12
8.41425-8.41475	162.0125-167.17	3260-3267	23.6-24.0
12.29-12.293	167.72-173.2	3332-3339	31.2-31.8
12.51975-12.52025	240-285	3345.8-3358	36.43-36.5
12.57675-12.57725	322-335.4	3600-4400	(2\)
13.36-13.41			

\1\ Until February 1, 1999, this restricted band shall be 0.490-0.510 MHz.

\2\ Above 38.6

For transmitters operating in the 5.15-5.25 GHz band: All emissions outside of the 5.15-5.35 GHz band shall not exceed an e.i.r.p. of -27 dBm/MHz (68.2dBuV/m at 3m).

In addition, In case the emission fall within the restricted band specified on 15.205(a), then the 15.209(a) limit in the table below has to be followed.

Frequencies (MHz)	Field Strength (microvolts/meter)	Measurement Distance (meters)
0.009~0.490	2400/F(KHz)	300
0.490~1.705	24000/F(KHz)	30
1.705~30.0	30	30
30~88	100	3
88~216	150	3
216~960	200	3
Above 960	500	3

#### 5.5.2. Measuring Instruments and Setting

Please refer to equipment list in this report. The following table is the setting of spectrum analyzer and receiver.

Spectrum Parameter	Setting
Attenuation	Auto
Start Frequency	1000 MHz
Stop Frequency	10 <sup>th</sup> carrier harmonic
RB / VB (Emission in restricted band)	1MHz / 1MHz for Peak, 1 MHz / 1/B kHz for Average
RB / VB (Emission in non-restricted band)	1MHz / 1MHz for Peak, 1 MHz / 1/B kHz for Average





Receiver Parameter	Setting
Attenuation	Auto
Start ~ Stop Frequency	9kHz~150kHz / RB 200Hz for QP/AVG
Start ~ Stop Frequency	150kHz~30MHz / RB 9kHz for QP/AVG
Start ~ Stop Frequency	30MHz~1000MHz / RB 120kHz for QP

### 5.5.3. Test Procedures

#### 1) Sequence of testing 9 kHz to 30 MHz

##### Setup:

- The equipment was set up to simulate a typical usage like described in the user manual or described by manufacturer.
- If the EUT is a tabletop system, a rotatable table with 0.8 m height is used.
- If the EUT is a floor standing device, it is placed on the ground.
- Auxiliary equipment and cables were positioned to simulate normal operation conditions.
- The AC power port of the EUT (if available) is connected to a power outlet below the turntable.
- The measurement distance is 3 meter.
- The EUT was set into operation.

##### Premeasurement:

- The turntable rotates from 0° to 315° using 45° steps.
- The antenna height is 1.0 meter.
- At each turntable position the analyzer sweeps with peak detection to find the maximum of all emissions

##### Final measurement:

- Identified emissions during the premeasurement the software maximizes by rotating the turntable position (0° to 360°) and by rotating the elevation axes (0° to 360°).
- The final measurement will be done in the position (turntable and elevation) causing the highest emissions with QPK detector.
- The final levels, frequency, measuring time, bandwidth, turntable position, correction factor, margin to the limit and limit will be recorded. Also a plot with the graph of the premeasurement and the limit will be stored.





## 2) Sequence of testing 30 MHz to 1 GHz

### Setup:

- The equipment was set up to simulate a typical usage like described in the user manual or described by manufacturer.
- If the EUT is a tabletop system, a table with 0.8 m height is used, which is placed on the ground plane.
- If the EUT is a floor standing device, it is placed on the ground plane with insulation between both.
- Auxiliary equipment and cables were positioned to simulate normal operation conditions
- The AC power port of the EUT (if available) is connected to a power outlet below the turntable.
- The measurement distance is 3 meter.
- The EUT was set into operation.

### Premeasurement:

- The turntable rotates from 0° to 315° using 45° steps.
- The antenna is polarized vertical and horizontal.
- The antenna height changes from 1 to 3 meter.
- At each turntable position, antenna polarization and height the analyzer sweeps three times in peak to find the maximum of all emissions.

### Final measurement:

- The final measurement will be performed with minimum the six highest peaks.
- According to the maximum antenna and turntable positions of premeasurement the software maximize the peaks by changing turntable position ( $\pm 45^\circ$ ) and antenna movement between 1 and 4 meter.
- The final measurement will be done with QP detector with an EMI receiver.
- The final levels, frequency, measuring time, bandwidth, antenna height, antenna polarization, turntable angle, correction factor, margin to the limit and limit will be recorded. Also a plot with the graph of the premeasurement with marked maximum final measurements and the limit will be stored.





### 3) Sequence of testing 1 GHz to 18 GHz

#### Setup:

- The equipment was set up to simulate a typical usage like described in the user manual or described by manufacturer.
- If the EUT is a tabletop system, a rotatable table with 1.5 m height is used.
- If the EUT is a floor standing device, it is placed on the ground plane with insulation between both.
- Auxiliary equipment and cables were positioned to simulate normal operation conditions
- The AC power port of the EUT (if available) is connected to a power outlet below the turntable.
- The measurement distance is 3 meter.
- The EUT was set into operation.

#### Premeasurement:

- The turntable rotates from 0° to 315° using 45° steps.
- The antenna is polarized vertical and horizontal.
- The antenna height scan range is 1 meter to 2.5 meter.
- At each turntable position and antenna polarization the analyzer sweeps with peak detection to find the maximum of all emissions.

#### Final measurement:

- The final measurement will be performed with minimum the six highest peaks.
- According to the maximum antenna and turntable positions of premeasurement the software maximize the peaks by changing turntable position ( $\pm 45^\circ$ ) and antenna movement between 1 and 4 meter. This procedure is repeated for both antenna polarizations.
- The final measurement will be done in the position (turntable, EUT-table and antenna polarization) causing the highest emissions with Peak and Average detector.
- The final levels, frequency, measuring time, bandwidth, turntable position, EUT-table position, antenna polarization, correction factor, margin to the limit and limit will be recorded. Also a plot with the graph of the premeasurement with marked maximum final measurements and the limit will be stored.



Shenzhen LCS Compliance Testing Laboratory Ltd.

Add: 101, 201 Bldg A & 301 Bldg C, Juji Industrial Park Yabianxueziwei, Shajing Street, Baoan District, Shenzhen, 518000, China

Tel: +(86) 0755-82591330 | E-mail: webmaster@lcs-cert.com | Web: www.lcs-cert.com

Scan code to check authenticity





#### 4) Sequence of testing above 18 GHz

##### Setup:

- The equipment was set up to simulate a typical usage like described in the user manual or described by manufacturer.
- If the EUT is a tabletop system, a rotatable table with 1.5 m height is used.
- If the EUT is a floor standing device, it is placed on the ground plane with insulation between both.
- Auxiliary equipment and cables were positioned to simulate normal operation conditions
- The AC power port of the EUT (if available) is connected to a power outlet below the turntable.
- The measurement distance is 1 meter.
- The EUT was set into operation.

##### Premeasurement:

- The antenna is moved spherical over the EUT in different polarizations of the antenna.

##### Final measurement:

- The final measurement will be performed at the position and antenna orientation for all detected emissions that were found during the premeasurements with Peak and Average detector.
- The final levels, frequency, measuring time, bandwidth, correction factor, margin to the limit and limit will be recorded. Also a plot with the graph of the premeasurement and the limit will be stored.



### 5.5.4. Test Setup Layout

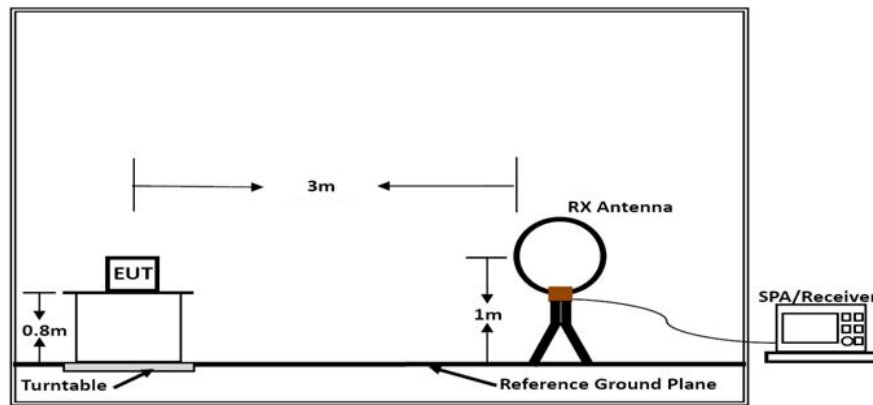

Below 30MHz

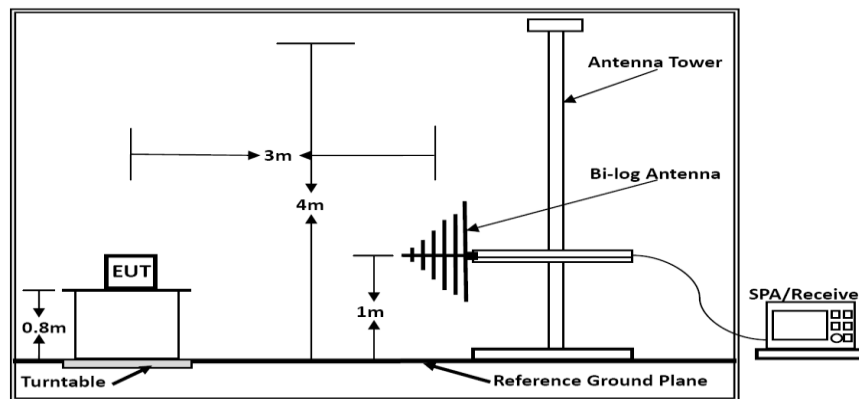

Below 1GHz

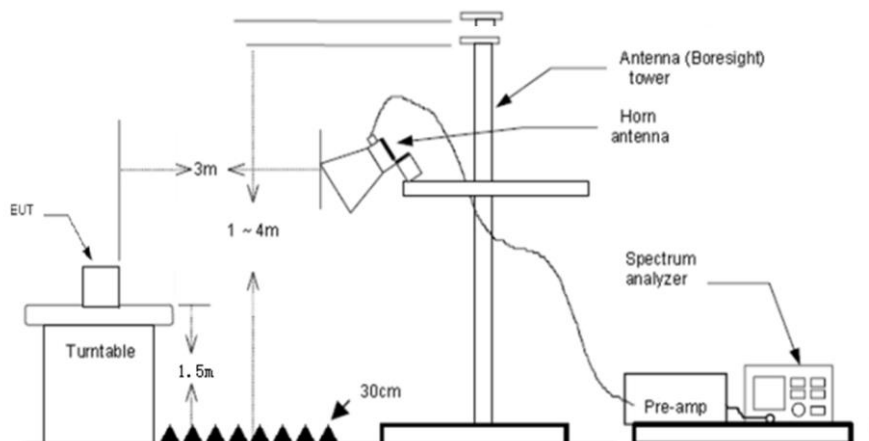

Above 18 GHz shall be extrapolated to the specified distance using an extrapolation factor of 20 dB/decade from 3m to 1m.

### 5.5.5. EUT Operation during Test

The EUT was programmed to be in continuously transmitting mode.





5.5.6. Results of Radiated Emissions (9 KHz~30MHz)

Temperature	22.8°C	Humidity	52.1%
Test Engineer	Taylor Hu	Configurations	IEEE 802.11a/n/ac

Freq. (MHz)	Level (dBuV)	Over Limit (dB)	Over Limit (dB)	Remark
-	-	-	-	See Note

Note:

The amplitude of spurious emissions which are attenuated by more than 20 dB below the permissible value has no need to be reported.

Distance extrapolation factor = 40 log (specific distance / test distance) (dB);

Limit line = specific limits (dBuV) + distance extrapolation factor.

5.5.6. Results of Radiated Emissions (30MHz~1GHz)

Temperature	22.8°C	Humidity	52.1%
Test Engineer	Taylor Hu	Configurations	IEEE 802.11a/n/ac

PASS.

The test data please refer to following page.





Horizontal

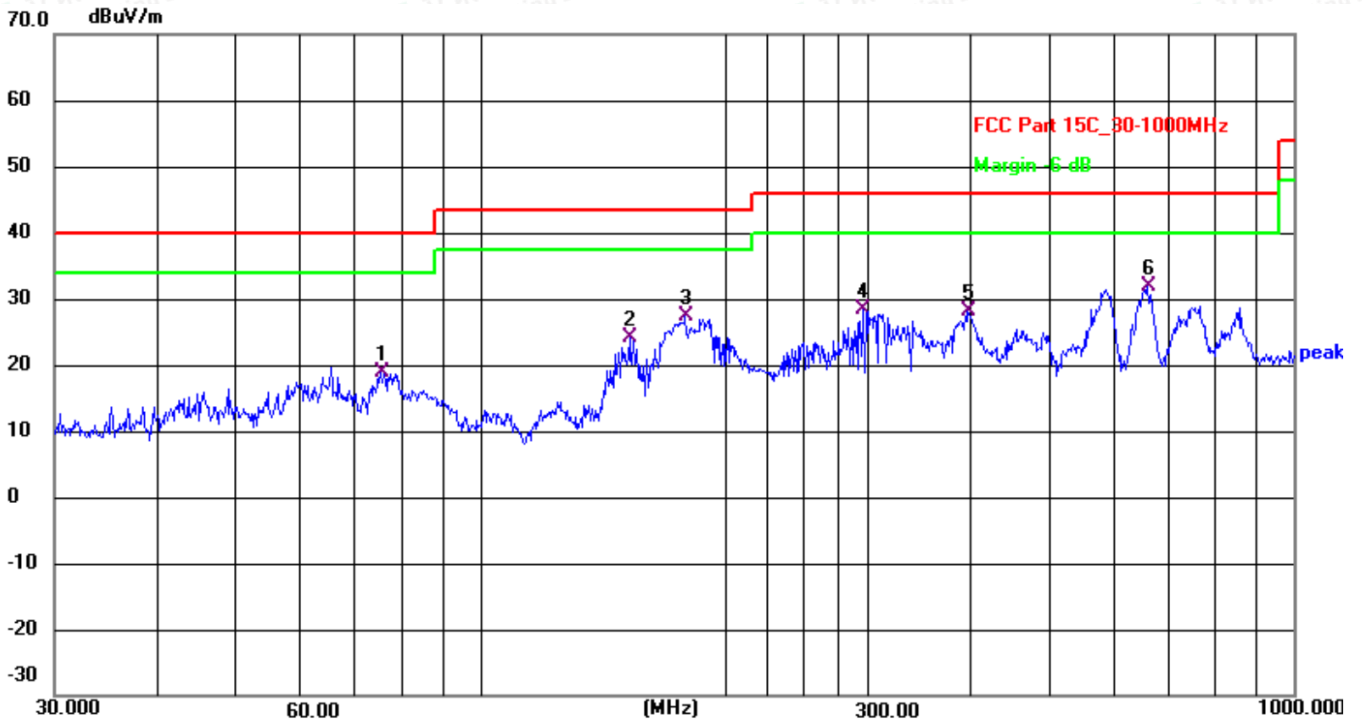

No.	Frequency (MHz)	Reading (dBuV)	Factor (dB/m)	Level (dBuV/m)	Limit (dBuV/m)	Margin (dB)	Detector
1	75.4463	38.48	-19.69	18.79	40.00	-21.21	QP
2	152.6641	44.02	-19.78	24.24	43.50	-19.26	QP
3	178.7584	46.07	-18.79	27.28	43.50	-16.22	QP
4	295.1468	43.95	-15.57	28.38	46.00	-17.62	QP
5	397.6334	42.55	-14.44	28.11	46.00	-17.89	QP
6	661.1504	42.85	-11.05	31.80	46.00	-14.20	QP





Vertical

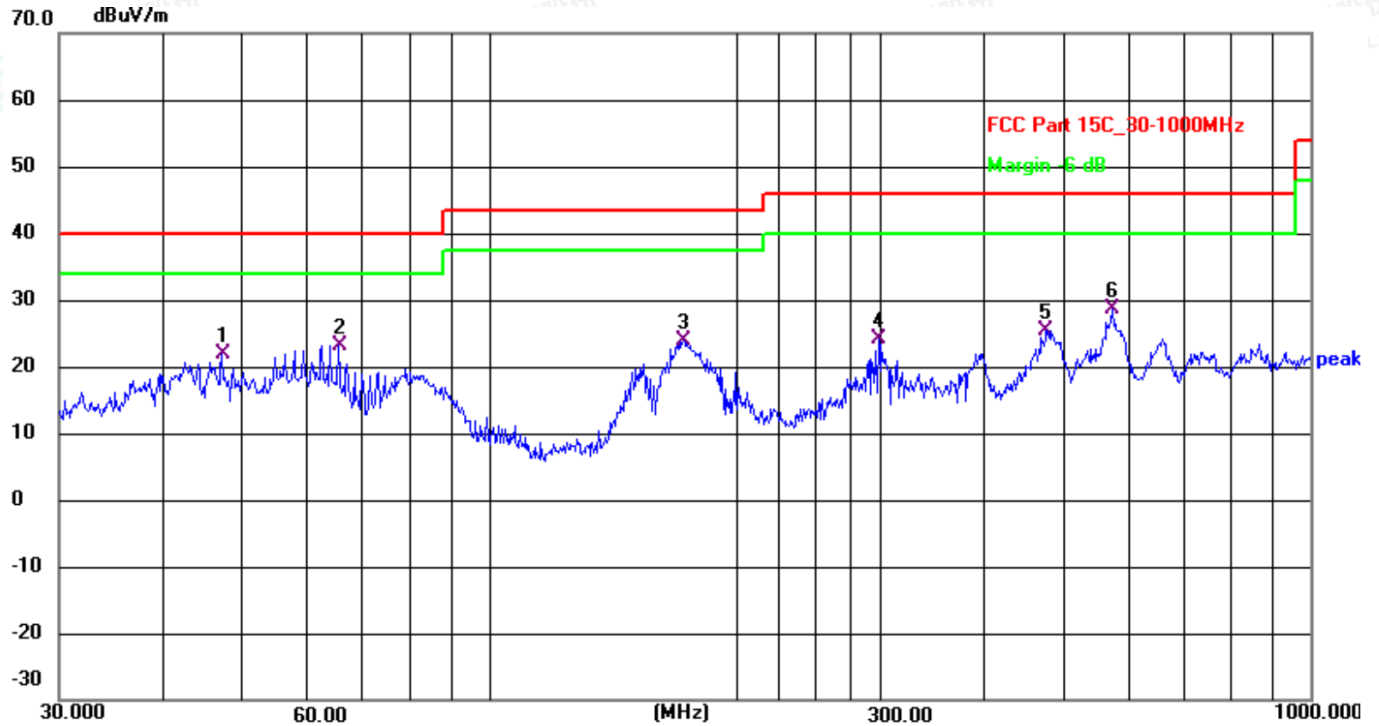

No.	Frequency (MHz)	Reading (dBuV)	Factor (dB/m)	Level (dBuV/m)	Limit (dBuV/m)	Margin (dB)	Detector
1	47.3255	38.90	-16.96	21.94	40.00	-18.06	QP
2	65.5727	42.41	-19.19	23.22	40.00	-16.78	QP
3	172.5987	43.10	-19.31	23.79	43.50	-19.71	QP
4	298.2681	39.76	-15.61	24.15	46.00	-21.85	QP
5	477.1693	39.73	-14.36	25.37	46.00	-20.63	QP
6	574.6258	39.47	-10.87	28.60	46.00	-17.40	QP

Note:

- (1). Pre-scan all modes and recorded the worst case results in this report (IEEE 802.11a mode (Low Channel)).
- 2). Emission level (dBuV/m) = 20 log Emission level (uV/m).
- 3). Level = Reading + Factor, Margin = Level - Limit, Factor = Antenna Factor + Cable Loss - Preamp Factor





## 5.5.7. Results for Radiated Emissions (1 – 40 GHz)

Note: All the modes have been tested and recorded worst mode in the report.

**UNII Band 1**

IEEE 802.11a

Channel 36 / 5180 MHz

Freq GHz	Read Level dBuV	Ant. Fac dB/m	Pre. Fac dB	Cab.Los dB	Measured Level dBuV	Limit Line dBuV/m	Over limit dB	Remark	Pol/Phase
15.54	42.38	33.21	35.82	9.52	49.29	68.20	-18.91	Peak	Horizontal
15.54	36.87	33.21	35.82	9.52	43.78	54.00	-10.22	Average	Horizontal
15.54	48.56	32.82	35.82	9.52	55.08	68.20	-13.12	Peak	Vertical
15.54	38.83	32.82	35.82	9.52	45.35	54.00	-8.65	Average	Vertical

Channel 40 / 5200 MHz

Freq GHz	Read Level dBuV	Ant. Fac dB/m	Pre. Fac dB	Cab.Los dB	Measured Level dBuV	Limit Line dBuV/m	Over limit dB	Remark	Pol/Phase
15.60	49.78	33.21	35.82	9.52	56.69	68.20	-11.51	Peak	Horizontal
15.60	29.66	33.21	35.82	9.52	36.57	54.00	-17.43	Average	Horizontal
15.60	47.30	32.82	35.82	9.52	53.82	68.20	-14.38	Peak	Vertical
15.60	28.06	32.82	35.82	9.52	34.58	54.00	-19.42	Average	Vertical

Channel 48 / 5240 MHz

Freq GHz	Read Level dBuV	Ant. Fac dB/m	Pre. Fac dB	Cab.Los dB	Measured Level dBuV	Limit Line dBuV/m	Over limit dB	Remark	Pol/Phase
15.72	44.80	33.21	35.82	9.52	51.71	68.20	-16.49	Peak	Horizontal
15.72	37.31	33.21	35.82	9.52	44.22	54.00	-9.78	Average	Horizontal
15.72	45.93	32.82	35.82	9.52	52.45	68.20	-15.75	Peak	Vertical
15.72	31.52	32.82	35.82	9.52	38.04	54.00	-15.96	Average	Vertical

IEEE 802.11n HT20

Channel 36 / 5180 MHz

Freq GHz	Read Level dBuV	Ant. Fac dB/m	Pre. Fac dB	Cab.Los dB	Measured Level dBuV	Limit Line dBuV/m	Over limit dB	Remark	Pol/Phase
15.54	46.01	33.21	35.82	9.52	52.92	68.20	-15.28	Peak	Horizontal
15.54	33.59	33.21	35.82	9.52	40.50	54.00	-13.50	Average	Horizontal
15.54	47.31	32.82	35.82	9.52	53.83	68.20	-14.37	Peak	Vertical
15.54	31.96	32.82	35.82	9.52	38.48	54.00	-15.52	Average	Vertical

Channel 40 / 5200 MHz

Freq GHz	Read Level dBuV	Ant. Fac dB/m	Pre. Fac dB	Cab.Los dB	Measured Level dBuV	Limit Line dBuV/m	Over limit dB	Remark	Pol/Phase
15.60	44.20	33.21	35.82	9.52	51.11	68.20	-17.09	Peak	Horizontal
15.60	30.93	33.21	35.82	9.52	37.84	54.00	-16.16	Average	Horizontal
15.60	49.84	32.82	35.82	9.52	56.36	68.20	-11.84	Peak	Vertical
15.60	38.40	32.82	35.82	9.52	44.92	54.00	-9.08	Average	Vertical



Shenzhen LCS Compliance Testing Laboratory Ltd.

Add: 101, 201 Bldg A &amp; 301 Bldg C, Juji Industrial Park Yabianxueziwei, Shajing Street, Baoan District, Shenzhen, 518000, China

Tel: +(86) 0755-82591330 | E-mail: webmaster@lcs-cert.com | Web: www.lcs-cert.com

Scan code to check authenticity



## Channel 48 / 5240 MHz

Freq GHz	Read Level dBuV	Ant. Fac dB/m	Pre. Fac dB	Cab.Los dB	Measured Level dBuV	Limit Line dBuV/m	Over limit dB	Remark	Pol/Phase
15.72	42.27	49.89	33.21	35.82	9.52	56.80	68.20	Peak	Horizontal
15.72	36.17	33.51	33.21	35.82	9.52	40.42	54.00	Average	Horizontal
15.72	48.51	41.05	32.82	35.82	9.52	47.57	68.20	Peak	Vertical
15.72	30.04	37.56	32.82	35.82	9.52	44.08	54.00	Average	Vertical

## IEEE 802.11ac VHT20

## Channel 36 / 5180 MHz

Freq GHz	Read Level dBuV	Ant. Fac dB/m	Pre. Fac dB	Cab.Los dB	Measured Level dBuV	Limit Line dBuV/m	Over limit dB	Remark	Pol/Phase
15.54	41.53	33.21	35.82	9.52	48.44	68.20	-19.76	Peak	Horizontal
15.54	36.47	33.21	35.82	9.52	43.38	54.00	-10.62	Average	Horizontal
15.54	46.27	32.82	35.82	9.52	52.79	68.20	-15.41	Peak	Vertical
15.54	33.29	32.82	35.82	9.52	39.81	54.00	-14.19	Average	Vertical

## Channel 40 / 5200 MHz

Freq GHz	Read Level dBuV	Ant. Fac dB/m	Pre. Fac dB	Cab.Los dB	Measured Level dBuV	Limit Line dBuV/m	Over limit dB	Remark	Pol/Phase
15.60	44.17	33.21	35.82	9.52	51.08	68.20	-17.12	Peak	Horizontal
15.60	28.67	33.21	35.82	9.52	35.58	54.00	-18.42	Average	Horizontal
15.60	46.50	32.82	35.82	9.52	53.02	68.20	-15.18	Peak	Vertical
15.60	37.42	32.82	35.82	9.52	43.94	54.00	-10.06	Average	Vertical

## Channel 48 / 5240 MHz

Freq GHz	Read Level dBuV	Ant. Fac dB/m	Pre. Fac dB	Cab.Los dB	Measured Level dBuV	Limit Line dBuV/m	Over limit dB	Remark	Pol/Phase
15.72	41.43	33.21	35.82	9.52	48.34	68.20	-19.86	Peak	Horizontal
15.72	33.93	33.21	35.82	9.52	40.84	54.00	-13.16	Average	Horizontal
15.72	47.75	32.82	35.82	9.52	54.27	68.20	-13.93	Peak	Vertical
15.72	31.43	32.82	35.82	9.52	37.95	54.00	-16.05	Average	Vertical

## IEEE 802.11n HT40

## Channel 38 / 5190 MHz

Freq GHz	Read Level dBuV	Ant. Fac dB/m	Pre. Fac dB	Cab.Los dB	Measured Level dBuV	Limit Line dBuV/m	Over limit dB	Remark	Pol/Phase
15.57	50.53	33.21	35.82	9.52	57.44	68.20	-10.76	Peak	Horizontal
15.57	34.08	33.21	35.82	9.52	40.99	54.00	-13.01	Average	Horizontal
15.57	48.25	32.82	35.82	9.52	54.77	68.20	-13.43	Peak	Vertical
15.57	37.52	32.82	35.82	9.52	44.04	54.00	-9.96	Average	Vertical

## Channel 46 / 5230 MHz

Freq GHz	Read Level dBuV	Ant. Fac dB/m	Pre. Fac dB	Cab.Los dB	Measured Level dBuV	Limit Line dBuV/m	Over limit dB	Remark	Pol/Phase
15.69	44.38	33.21	35.82	9.52	51.29	68.20	-16.91	Peak	Horizontal
15.69	37.27	33.21	35.82	9.52	44.18	54.00	-9.82	Average	Horizontal
15.69	45.81	32.82	35.82	9.52	52.33	68.20	-15.87	Peak	Vertical
15.69	33.70	32.82	35.82	9.52	40.22	54.00	-13.78	Average	Vertical



Shenzhen LCS Compliance Testing Laboratory Ltd.

Add: 101, 201 Bldg A &amp; 301 Bldg C, Juji Industrial Park Yabianxueziwei, Shajing Street, Baoan District, Shenzhen, 518000, China

Tel: +(86) 0755-82591330 | E-mail: webmaster@lcs-cert.com | Web: www.lcs-cert.com

Scan code to check authenticity



## IEEE 802.11ac VHT40

## Channel 38 / 5190 MHz

Freq GHz	Read Level dBuV	Ant. Fac dB/m	Pre. Fac dB	Cab.Los dB	Measured Level dBuV	Limit Line dBuV/m	Over limit dB	Remark	Pol/Phase
15.57	48.82	33.21	35.82	9.52	55.73	68.20	-12.47	Peak	Horizontal
15.57	37.57	33.21	35.82	9.52	44.48	54.00	-9.52	Average	Horizontal
15.57	44.22	32.82	35.82	9.52	50.74	68.20	-17.46	Peak	Vertical
15.57	38.31	32.82	35.82	9.52	44.83	54.00	-9.17	Average	Vertical

## Channel 46 / 5230 MHz

Freq GHz	Read Level dBuV	Ant. Fac dB/m	Pre. Fac dB	Cab.Los dB	Measured Level dBuV	Limit Line dBuV/m	Over limit dB	Remark	Pol/Phase
15.69	40.74	33.21	35.82	9.52	47.65	68.20	-20.55	Peak	Horizontal
15.69	33.37	33.21	35.82	9.52	40.28	54.00	-13.72	Average	Horizontal
15.69	40.05	32.82	35.82	9.52	46.57	68.20	-21.63	Peak	Vertical
15.69	34.19	32.82	35.82	9.52	40.71	54.00	-13.29	Average	Vertical

## IEEE 802.11ac VHT80

## Channel 42 / 5210 MHz

Freq GHz	Read Level dBuV	Ant. Fac dB/m	Pre. Fac dB	Cab.Los dB	Measured Level dBuV	Limit Line dBuV/m	Over limit dB	Remark	Pol
15.63	40.25	33.21	35.82	9.52	47.16	68.20	-21.04	Peak	Horizontal
15.63	31.53	33.21	35.82	9.52	38.44	54.00	-15.56	Average	Horizontal
15.63	50.60	32.82	35.82	9.52	57.12	68.20	-11.08	Peak	Vertical
15.63	32.35	32.82	35.82	9.52	38.87	54.00	-15.13	Average	Vertical

## Notes:

- 1). Measuring frequencies from 9 KHz ~ 40GHz, emissions are attenuated more than 20dB below the permissible limits generated frequency to 30MHz.
- 2). Radiated emissions measured in frequency range from 9 KHz ~ 40GHz were made with an instrument using Peak detector mode.
- 3). 18~40GHz at least have 20dB margin. No recording in the test report.
- 4). Worst case data at IEEE 802.11a; MCS0 at IEEE 802.11n HT20, IEEE 802.11n HT40, IEEE 802.11ac VHT20, IEEE 802.11ac VHT40, IEEE 802.11ac VHT80.
- 5). Data of measurement within this frequency range shown "---" in the table above means the reading of emissions are attenuated more than 20dB below the permissible limits or the field strength is too small to be measured.
- 6). Margin=Reading level+Cab loss+Ant Fac-Pre Fac-Limit





## 5.6. Power Line Conducted Emissions

### 5.6.1 Standard Applicable

According to §15.207 (a): For an intentional radiator which is designed to be connected to the public utility (AC) power line, the radio frequency voltage that is conducted back onto the AC power line on any frequency or frequencies within the band 150 kHz to 30 MHz shall not exceed 250 microvolts (The limit decreases linearly with the logarithm of the frequency in the range 0.15 MHz to 0.50 MHz). The limits at specific frequency range are listed as follows:

Frequency Range (MHz)	Limits (dB $\mu$ V)	
	Quasi-peak	Average
0.15 to 0.50	66 to 56*	56 to 46*
0.50 to 5	56	46
5 to 30	60	50

\* Decreasing linearly with the logarithm of the frequency

### 5.6.2 Block Diagram of Test Setup

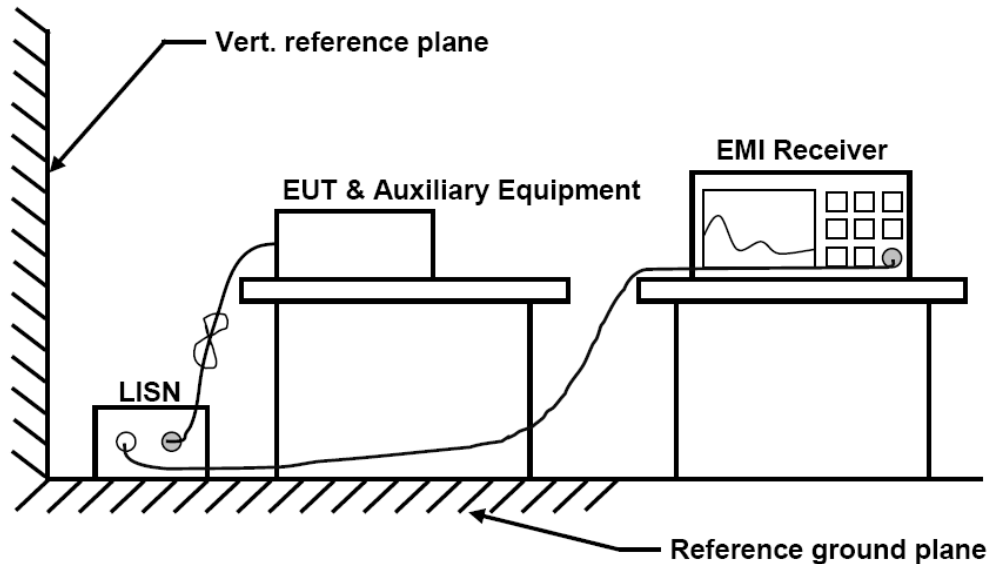

### 5.6.3 Test Results

Temperature	23.5°C	Humidity	53.6%
Test Engineer	Taylor Hu	Configurations	IEEE 802.11a/n/ac

**PASS.**

The test data please refer to following page.





Line

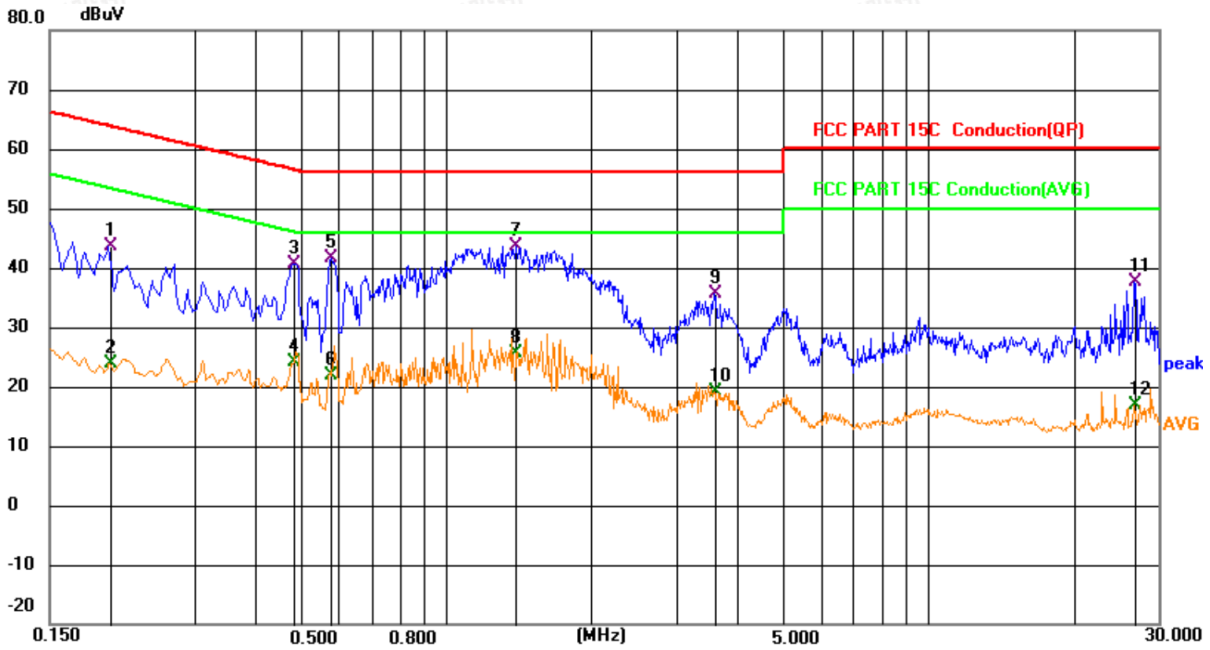

No.	Mk.	Freq. MHz	Reading Level dBuV	Correct Factor dB	Measure- ment dBuV	Limit dBuV	Margin dB	Detector	Comment
1		0.1996	23.90	19.63	43.53	63.63	-20.10	QP	
2		0.1996	4.21	19.63	23.84	53.63	-29.79	AVG	
3		0.4831	21.04	19.64	40.68	56.29	-15.61	QP	
4		0.4831	4.39	19.64	24.03	46.29	-22.26	AVG	
5		0.5775	21.89	19.66	41.55	56.00	-14.45	QP	
6		0.5775	2.16	19.66	21.82	46.00	-24.18	AVG	
7	*	1.3965	24.01	19.66	43.67	56.00	-12.33	QP	
8		1.3965	6.07	19.66	25.73	46.00	-20.27	AVG	
9		3.5881	15.89	19.70	35.59	56.00	-20.41	QP	
10		3.5881	-0.65	19.70	19.05	46.00	-26.95	AVG	
11		26.7991	17.53	20.04	37.57	60.00	-22.43	QP	
12		26.7991	-3.13	20.04	16.91	50.00	-33.09	AVG	





Neutral

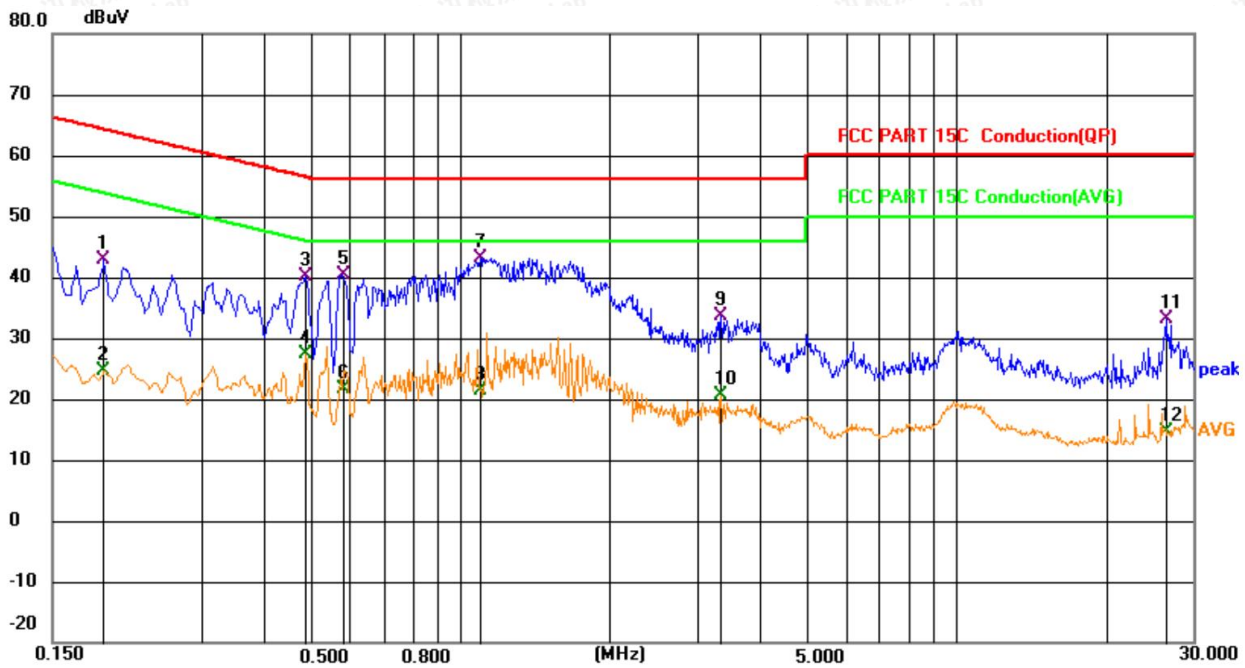

No.	Mk.	Freq. MHz	Reading Level dBuV	Correct Factor dB	Measure- ment dBuV	Limit dBuV	Margin dB	Detector	Comment
1		0.1906	23.18	19.63	42.81	64.01	-21.20	QP	
2		0.1906	5.00	19.63	24.63	54.01	-29.38	AVG	
3		0.4876	20.48	19.64	40.12	56.21	-16.09	QP	
4		0.4876	7.64	19.64	27.28	46.21	-18.93	AVG	
5		0.5776	20.67	19.66	40.33	56.00	-15.67	QP	
6		0.5776	1.92	19.66	21.58	46.00	-24.42	AVG	
7	*	1.0995	23.55	19.65	43.20	56.00	-12.80	QP	
8		1.0995	1.81	19.65	21.46	46.00	-24.54	AVG	
9		3.3496	13.78	19.77	33.55	56.00	-22.45	QP	
10		3.3496	0.87	19.77	20.64	46.00	-25.36	AVG	
11		26.5561	13.09	20.03	33.12	60.00	-26.88	QP	
12		26.5561	-5.28	20.03	14.75	50.00	-35.25	AVG	

\*\*\*Note: Pre-scan all modes and recorded the worst case results in this report (IEEE 802.11a mode (Low Channel)).

Measurement = Reading + Correct, Margin = Measurement - Limit.  
Correct Factor = Lism Factor + Cable Factor



## 5.7 Emissions in Restricted Bands

### 5.7.1 Limit

According to §15.407 (b) Undesirable emission limits. Except as shown in paragraph (b) (7) of this section, the maximum emissions outside of the frequency bands of operation shall be attenuated in accordance with the following limits:

- (a) For transmitters operating in the 5.15-5.25 GHz band: All emissions outside of the 5.15-5.35 GHz band shall not exceed an e.i.r.p. of  $-27$  dBm/MHz.
- (b) For transmitters operating in the 5.25-5.35 GHz band: All emissions outside of the 5.15-5.35 GHz band shall not exceed an e.i.r.p. of  $-27$  dBm/MHz.
- (c) For transmitters operating in the 5.47-5.725 GHz band: All emissions outside of the 5.47-5.725 GHz band shall not exceed an e.i.r.p. of  $-27$  dBm/MHz.
- (d) For transmitters operating in the 5.725-5.85 GHz band:
  - (i) All emissions shall be limited to a level of  $-27$  dBm/MHz at 75 MHz or more above or below the band edge increasing linearly to 10 dBm/MHz at 25 MHz above or below the band edge, and from 25 MHz above or below the band edge increasing linearly to a level of 15.5 dBm/MHz at 5 MHz above or below the band edge, and from 5 MHz above or below the band edge increasing linearly to a level of 27 dBm/MHz at the band edge.
  - (ii) Devices certified before March 2, 2017 with antenna gain greater than 10 dBi may demonstrate compliance with the emission limits in §15.247(d), but manufacturing, marketing and importing of devices certified under this alternative must cease by March 2, 2018. Devices certified before March 2, 2018 with antenna gain of 10 dBi or less may demonstrate compliance with the emission limits in §15.247(d), but manufacturing, marketing and importing of devices certified under this alternative must cease before March 2, 2020.
- (e) The emission measurements shall be performed using a minimum resolution bandwidth of 1 MHz. A lower resolution bandwidth may be employed near the band edge, when necessary, provided the measured energy is integrated to show the total power over 1 MHz.
- (f) Unwanted emissions below 1 GHz must comply with the general field strength limits set forth in §15.209. Further, any U-NII devices using an AC power line are required to comply also with the conducted limits set forth in §15.207.
- (g) The provisions of §15.205 apply to intentional radiators operating under this section.
- (h) When measuring the emission limits, the nominal carrier frequency shall be adjusted as close to the upper and lower frequency band edges as the design of the equipment permits.

### 5.7.2 Test Configuration

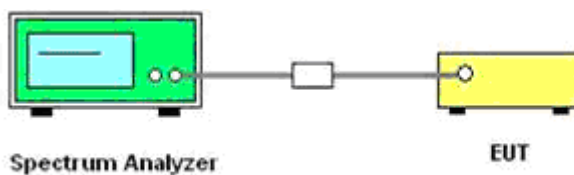

### 5.7.3 Test Procedure

According to KDB789033 D02 General UNII Test Procedures New Rules v02r01 Section G: Unwanted Emission Measurement

#### 1. Unwanted Emissions in the Restricted Bands

- a) For all measurements, follow the requirements in section II.G.3. "General Requirements for Unwanted Emissions Measurements."
- b) At frequencies below 1000 MHz, use the procedure described in section II.G.4. "Procedure for Unwanted Emissions Measurements below 1000 MHz."
- c) At frequencies above 1000 MHz, measurements performed using the peak and average measurement procedures described in sections II.G.5. and II.G.6, respectively, must satisfy the respective peak and average limits. If all peak measurements satisfy the average limit, then average measurements are not required.





- d) For conducted measurements above 1000 MHz, EIRP shall be computed as specified in section II.G.3.b) and then field strength shall be computed as follows (see KDB Publication 412172):
- $E[\text{dB}\mu\text{V}/\text{m}] = \text{EIRP}[\text{dBm}] - 20 \log(d[\text{meters}]) + 104.77$ , where  $E$  = field strength and  $d$  = distance at which field strength limit is specified in the rules;
  - $E[\text{dB}\mu\text{V}/\text{m}] = \text{EIRP}[\text{dBm}] + 95.2$ , for  $d = 3$  meters
- e) For conducted measurements below 1000 MHz, the field strength shall be computed as specified in d), above, and then an additional 4.7 dB shall be added as an upper bound on the field strength that would be observed on a test range with a ground plane for frequencies between 30 MHz and 1000 MHz, or an additional 6 dB shall be added for frequencies below 30 MHz.
2. Unwanted Emissions that fall Outside of the Restricted Bands
- a) For all measurements, follow the requirements in section II.G.3. "General Requirements for Unwanted Emissions Measurements."
- b) At frequencies below 1000 MHz, use the procedure described in section II.G.4. "Procedure for Unwanted Emissions Measurements below 1000 MHz."
- c) At frequencies above 1000 MHz, use the procedure for maximum emissions described in section II.G.5., "Procedure for Unwanted Maximum Unwanted Emissions Measurements Above 1000 MHz."
- d) Section 15.407(b) (1-3) specifies the unwanted emissions limit for the U-NII-1 and 2 bands. As specified, emissions above 1000 MHz that are outside of the restricted bands are subject to a peak emission limit of -27 dBm/MHz. However, an out-of-band emission that complies with both the average and peak limits of Section 15.209 is not required to satisfy the -27 dBm/MHz dBm/MHz peak emission limit.
- Section 15.407(b) (4) specifies the unwanted emissions limit for the U-NII-3 band. A band emissions mask is specified in Section 15.407(b) (4) (i). An alternative to the band emissions mask is specified in Section 15.407(b) (4) (ii). The alternative limits are based on the highest antenna gain specified in the filing. There are also marketing and importation restrictions for the alternative limit.
- e) If radiated measurements are performed, field strength is then converted to EIRP as follows:
- $\text{EIRP} = ((E \cdot d)^2) / 30$   
Where:
    - $E$  is the field strength in V/m;
    - $d$  is the measurement distance in meters;
    - EIRP is the equivalent isotopically radiated power in watts;
  - Working in dB units, the above equation is equivalent to:  
 $\text{EIRP} [\text{dBm}] = E [\text{dB}\mu\text{V}/\text{m}] + 20 \log(d [\text{meters}]) - 104.77$
  - Or, if  $d$  is 3 meters:  
 $\text{EIRP} [\text{dBm}] = E [\text{dB}\mu\text{V}/\text{m}] - 95.23$
- 3) Radiated versus Conducted Measurements.
- The unwanted emission limits in both the restricted and non-restricted bands are based on radiated measurements; however, as an alternative, antenna-port conducted measurements in conjunction with cabinet emissions tests will be permitted to demonstrate compliance provided that the following steps are performed:
- Cabinet emissions measurements. A radiated test shall be performed to ensure that cabinet emissions are below the emission limits. For the cabinet-emission measurements the antenna may be replaced by a termination matching the nominal impedance of the antenna.
  - Impedance matching. Conducted tests shall be performed using equipment that matches the nominal impedance of the antenna assembly used with the EUT.
  - EIRP calculation. A value representative of an upper bound on out-of-band antenna gain (in dBi) shall be added to the measured antenna-port conducted emission power to compute EIRP within the specified measurement bandwidth. (For emissions in the restricted bands, additional calculations are required to convert EIRP to field strength at the specified distance.) The upper bound on antenna gain for a device with a single RF output shall be selected as the maximum in-band gain of the antenna across all operating bands or 2 dBi, whichever is greater. However, for devices that operate in multiple bands using the same transmit antenna, the highest gain of the antenna within the operating band nearest to the out-of-band frequency being measured may be used in lieu of the overall highest gain when measuring emissions at frequencies within 20% of the absolute frequency at the nearest edge of that band, but in no case shall a value less than 2 dBi be selected.
  - EIRP adjustments for multiple outputs. For devices with multiple outputs occupying the same or overlapping frequency ranges in the same band (e.g., MIMO or beamforming devices), compute the total EIRP as follows:





- Compute EIRP for each output, as described in (iii), above.
- Follow the procedures specified in KDB Publication 662911 for summing emissions across the outputs or adjusting emission levels measured on individual outputs by  $10 \log(N_{\text{ANT}})$ , where  $N_{\text{ANT}}$  is the number of outputs.
- Add the array gain term specified in KDB Publication 662911 for out-of-band and spurious signals.  
(v) Direction of maximum emission.  
For all radiated emissions tests, measurements shall correspond to the direction of maximum emission level for each measured emission (see ANSI C63.10 for guidance).

#### 5.7.4 Test Results

PASS

Please refer to Appendix D.4

Remark:

1. Measured Undesirable emission at difference data rate for each mode and recorded worst case for each mode;
2. Test results including cable loss;
3. Worst case data at IEEE 802.11a; MCS0 at IEEE 802.11n HT20, IEEE 802.11n HT40, IEEE 802.11ac VHT20, IEEE 802.11ac VHT40, IEEE 802.11ac VHT80;
4. Covert Radiated E Level At 3m = Conducted average power + Directional Gain +  $104.77 - 20 \cdot \log(3)$ ;



## 5.8. Frequency Stability

### 5.8.1 Standard Applicable

According to FCC §15.407(g) “Manufacturers of U-NII devices are responsible for ensuring frequency stability such that an emission is maintained within the band of operation under all conditions of normal operation as specified in the users manual.”

According to FCC §2.1055(a) “The frequency stability shall be measured with variation of ambient temperature as follows:”

- (1) From  $-30^{\circ}$  to  $+50^{\circ}$  centigrade for all equipment except that specified in paragraphs (a) (2) and (3) of this section.
- (2) From  $-20^{\circ}$  to  $+50^{\circ}$  centigrade for equipment to be licensed for use in the Maritime Services under part 80 of this chapter, except for Class A, B, and S Emergency Position Indicating Radiobeacons (EPIRBS), and equipment to be licensed for use above 952 MHz at operational fixed stations in all services, stations in the Local Television Transmission Service and Point-to-Point Microwave Radio Service under part 21 of this chapter, equipment licensed for use aboard aircraft in the Aviation Services under part 87 of this chapter, and equipment authorized for use in the Family Radio Service under part 95 of this chapter.
- (3) From  $0^{\circ}$  to  $+50^{\circ}$  centigrade for equipment to be licensed for use in the Radio Broadcast Services under part 73 of this chapter.

### 5.8.2 Test Configuration

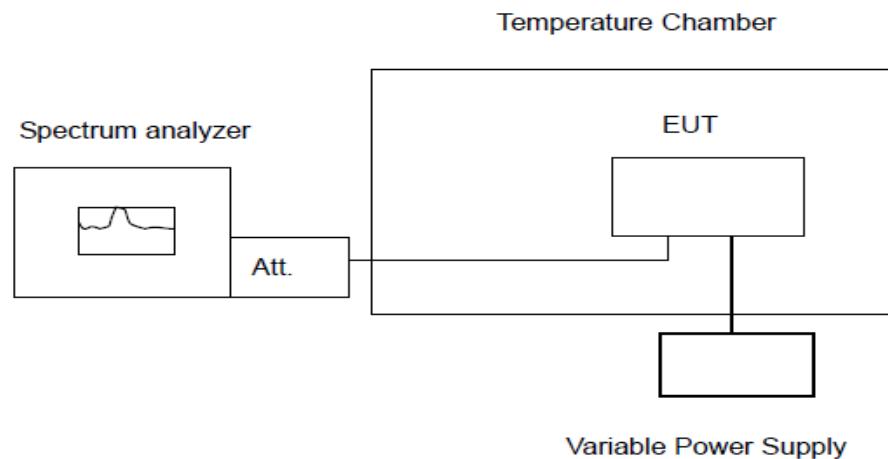

### 5.8.3 Test Procedure

The equipment under test was connected to an external AC or DC power supply and input rated voltage. RF output was connected to a frequency counter or spectrum analyzer via feed through attenuators. The EUT was placed inside the temperature chamber. Set the spectrum analyzer RBW low enough to obtain the desired frequency resolution and measure EUT 20 degree operating frequency as reference frequency. Turn EUT off and set the chamber temperature to -30 degree. After the temperature stabilized for approximately 30 minutes recorded the frequency. Repeat step measure with 10 degree increased per stage until the highest temperature of +50 degree reached.

### 5.8.4 Test Results

PASS

Please refer to Appendix D.5





## 5.9. On Time and Duty Cycle

### 5.9.1. Standard Applicable

None; for reporting purpose only

### 5.9.2. Measuring Instruments and Setting

Please refer to equipment list in this report. The following table is the setting of the spectrum analyzer.

### 5.9.3. Test Procedures

- 1). Set the Centre frequency of the spectrum analyzer to the transmitting frequency;
- 2). Set the span=0MHz, RBW=8MHz, VBW=8.0MHz, Sweep time=Auto;
- 3). Detector = peak;
- 4). Trace mode = Single hold.

### 5.9.4. Test Setup Layout



### 5.9.5. EUT Operation during Test

The EUT was programmed to be in continuously transmitting mode.

### 5.9.6. Test result

*Pass*

*Please refer to Appendix D.6*







## 5.10. Antenna Requirements

### 5.10.1 Standard Applicable

For intentional device, according to FCC 47 CFR Section 15.203:

An intentional radiator shall be designed to ensure that no antenna other than that furnished by the responsible party shall be used with the device. The use of a permanently attached antenna or of an antenna that uses a unique coupling to the intentional radiator, the manufacturer may design the unit so that a broken antenna can be replaced by the user, but the use of a standard antenna jack or electrical connector is prohibited

And according to FCC 47 CFR Section 15.407 (a), if transmitting antennas of directional gain greater than 6dBi are used, the power shall be reduced by the amount in dB that the directional gain of the antenna exceeds 6dBi.

### 5.10.2 Antenna Connected Construction

#### 5.10.2.1. Standard Applicable

According to § 15.203 & RSS-Gen, an intentional radiator shall be designed to ensure that no antenna other than that furnished by the responsible party shall be used with the device.

#### 5.10.2.2. Antenna Connector Construction

The gains of antenna used for transmitting is -2.76dBi(Max), and the antenna is FPC Antenna connect to PCB board and no consideration of replacement. Please see EUT photo for details, meet 15.203 & RSS-Gen antenna requirement.

#### 5.10.2.3. Results: Compliance.





## 6. LIST OF MEASURING EQUIPMENTS

Item	Equipment	Manufacturer	Model No.	Serial No.	Cal Date	Due Date
1	Power Meter	R&S	NRVS	100444	2023-06-15	2024-06-14
2	Power Sensor	R&S	NRV-Z81	100458	2023-06-15	2024-06-14
3	Power Sensor	R&S	NRV-Z32	10057	2023-06-15	2024-06-14
4	Test Software	Tonscend	JS1120-2	/	N/A	N/A
5	RF Control Unit	Tonscend	JS0806-2	N/A	2022-10-29	2023-10-28
6	MXA Signal Analyzer	Agilent	N9020A	MY50510140	2022-10-29	2023-10-28
7	DC Power Supply	Agilent	E3642A	N/A	2022-10-29	2023-10-28
8	EMI Test Software	AUDIX	E3	/	N/A	N/A
9	3m Semi Anechoic Chamber	SIDT FRANKONIA	SAC-3M	03CH03-HY	2023-06-15	2024-06-14
10	Positioning Controller	Max-Full	MF7802BS	MF780208586	N/A	N/A
11	Active Loop Antenna	SCHWARZBECK	FMZB 1519B	00005	2021-08-29	2024-08-28
12	By-log Antenna	SCHWARZBECK	VULB9163	9163-470	2021-09-12	2024-09-11
13	Horn Antenna	SCHWARZBECK	BBHA 9120D	9120D-1925	2021-09-05	2024-09-04
14	Broadband Horn Antenna	SCHWARZBECK	BBHA 9170	791	2021-08-29	2024-08-28
15	Broadband Preamplifier	SCHWARZBECK	BBV9719	9719-025	2023-06-15	2024-06-14
16	EMI Test Receiver	R&S	ESR 7	101181	2023-06-15	2024-06-14
17	RS SPECTRUM ANALYZER	R&S	FSP40	100503	2022-10-29	2023-10-28
18	Broadband Preamplifier	/	BP-01M18G	P190501	2023-06-15	2024-06-14
19	6dB Attenuator	/	100W/6dB	1172040	2023-06-15	2024-06-14
20	3dB Attenuator	/	2N-3dB	/	2022-10-29	2023-10-28
21	EMI Test Receiver	R&S	ESPI	101940	2022-08-18	2023-08-17
22	Artificial Mains	R&S	ENV216	101288	2023-06-15	2024-06-14
23	10dB Attenuator	SCHWARZBECK	MTS-IMP-136	261115-001-0032	2023-06-15	2024-06-14
24	EMI Test Software	Farad	EZ	/	N/A	N/A





## 7. TEST SETUP PHOTOGRAPHS OF EUT

Please refer to separated files for Test Setup Photos of the EUT.

## 8. EXTERIOR PHOTOGRAPHS OF THE EUT

Please refer to separated files for External Photos of the EUT.

## 9. INTERIOR PHOTOGRAPHS OF THE EUT

Please refer to separated files for Internal Photos of the EUT.

-----THE END OF REPORT-----

