

English

# Micro3 Slider Motor AA-E1



Manual

## Function Description

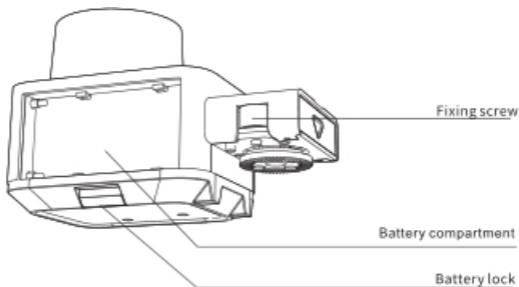
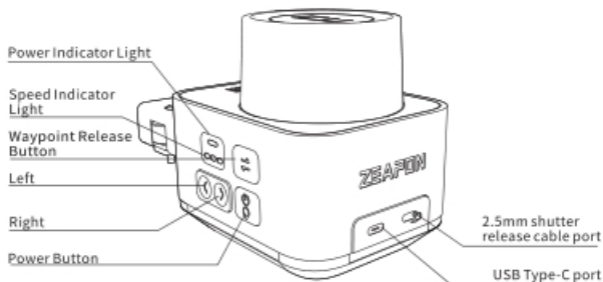

\*Micro3 slider motor is compatible with of lengths of 500/700/1000 sliders

## Function Introduction

Name	Function
Power Indicator Light	Green: full power Yellow: medium power Red: low power Blue: on
Speed Indicator Light	The number of lights from 1 to 3 represent the low, medium and high speed respectively
Waypoint Release Button	Holding the Waypoint Release Button for 1s, after the green light flashes, the motor stops, and starts to set the waypoint, you can manually drag the slider. After selecting the waypoint, press the Waypoint Release Button again, the green light is always on, the motor starts, and the waypoint setup over
Left	Slider moves to the left
Right	Slider moves to the right
Power Button	Power switch/waypoint creating
2.5mm shutter release cable port	The slider can be directly connected to the camera through the shutter cable to control the camera's photo function
USB Type-C port	Power supply to the slider motor (5V/2A)
Fixing screw	For fixing the motor on the slider
Battery compartment	Compatible with F550/F750/F970 lithium batteries
Battery lock	For fixing the battery to the battery compartment

Function	Pressing the button	Beep
Turn on the power	Long press the power button 3s	/
Turn off the power	Long press the power button 3s	/
Move left	Long press the left button	/
Move right	Long press on the right button	/
Speed Adjustment	Click the power button	/
create waypoint	Double click the power button	waypoint 1 set, beep once
		waypoint 2 set, beep twice
clear all waypoint	Long press left button + right button	One long beep
Getting Started	Double click the power button	/
Loop starts/pauses	Click (left button/right button + power button)	Beep once
Auto left/right movement	Double click left/right button	/
Setting waypoint manually	Holding the Waypoint Release Button 1s and the green light of the button flashes, Drag the slider to set up waypoints manually	/

## Slider motor installation

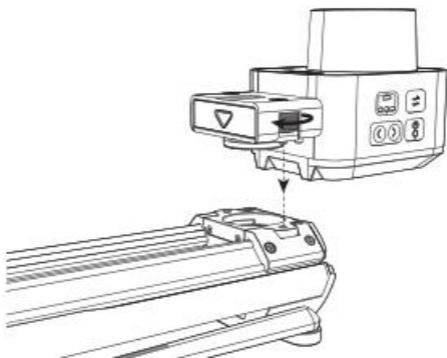
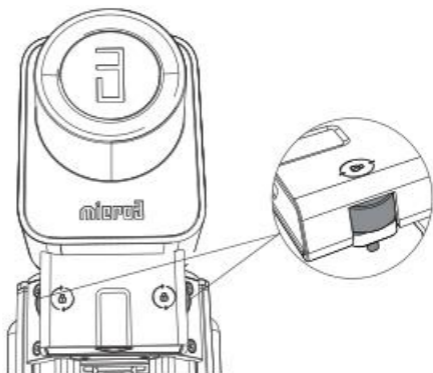

## Setting waypoint through physical buttons

1

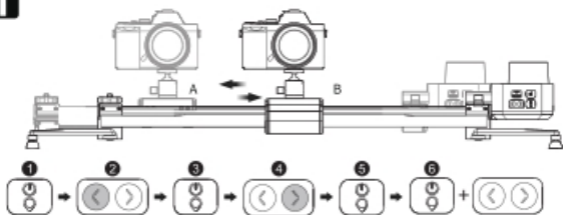

- 1 Press and hold the power button 3s to power on
- 2 Press and hold the left button to make the slider run to the desired position
- 3 Double-click the power button to set the A point
- 4 Long press the right button to make the slide run to the desired position
- 5 Double-click the power button to set point B
- 6 Double-click the power button to start or click (left button/right button + power button) to start looping

2

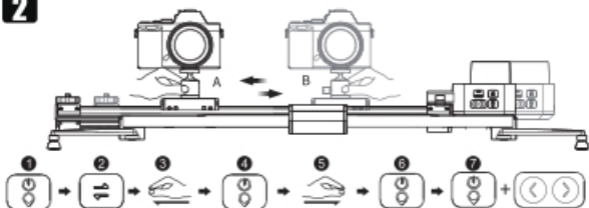

- 1 Press and hold the power button 3s to power on
- 2 Holding the Waypoint Release Button 1s and flash green light
- 3 Drag the platform on the slider to your preferred position
- 4 Double click the power button to set point A
- 5 Drag the platform on the slider to your preferred position
- 6 Double-click the power button to set point B
- 7 Double-click the power button to start or click (left button/right button + power button) to start looping

(Due to the large torque of the motor, more force is required when dragging the platform, please hold the support leg of the slider with one hand, and drag the platform with the another hand to set up waypoint)

**\* physical button can only set AB two points, cell phone APP can set multi-point track**

## Setting waypoint through APP

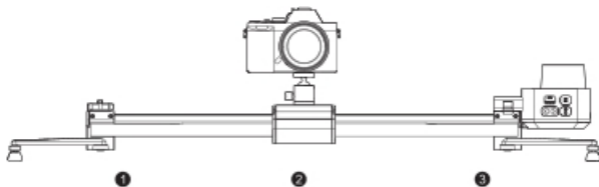

**1** Press and hold the slider motor power button 3s to power on

**2** Open the app and connect the corresponding slider

**3** Holding the Waypoint Release Button 1s and flash green light

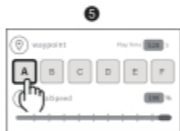
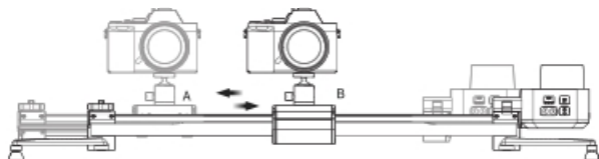

**4** Drag the platform on the slider to your preferred position

**5** Click the position to set the as point A

**6** Drag the platform on the slider to your preferred position

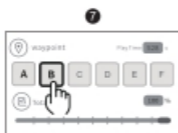
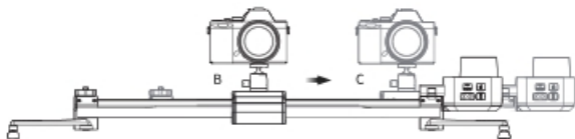

7 Click the position to set the  $\alpha$  point B

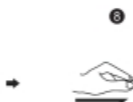

8 Drag the platform on the slider to your preferred position

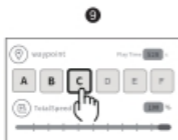

9 Click the position to set the  $\alpha$  point C



10 Click the start button, the slide will run from point C to point A

**Five waypoints from A-E can be set via the APP**

# FCC Statement

This equipment has been tested and found to comply with the limits for a Class B digital device, pursuant to Part 15 of the FCC Rules. These limits are designed to provide reasonable protection against harmful interference in a residential installation. This equipment generates, uses and can radiate radio frequency energy and, if not installed and used in accordance with the instructions, may cause harmful interference to radio communications. However, there is no guarantee that interference will not occur in a particular installation. If this equipment does cause harmful interference to radio or television reception, which can be determined by turning the equipment off and on, the user is encouraged to try to correct the interference by one or more of the following measures:

- Reorient or relocate the receiving antenna
- Increase the separation between the equipment and receiver.
- Connect the equipment into an outlet on a circuit different from that to which the receiver is connected
- Consult the dealer or an experienced radio/TV technician for help.

This device complies with Part 15 of the FCC Rules. Operation is subject to the following two conditions: (1) this device may not cause harmful interference, and (2) this device must accept any interference received, including interference that may cause undesired operation.

Changes or modifications to this unit not expressly approved by the party responsible for compliance could void the user's authority to operate the equipment.

This equipment complies with FCC radiation exposure limits set forth for an uncontrolled environment. This equipment should be installed and operated with minimum distance 20cm between the radiator & your body.



## Tips

Please go to the major application markets to search for "Zeapon Lab" or ZEAPON official website to download and install the APP!

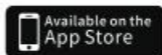

Download App from Zeapon web

Please note: this product does not provide batteries and battery chargers, if necessary, please purchase separately!

Thank you for using it!

⊗ In case of unauthorized disassembly of the internal structure of the slider motor, the warranty will not be honored!