

# Test Report

FCC ID: 2AVSB-CC60

Date of issue: Mar. 30, 2020

Report number: MTi20032002-4E1

---

Sample description: Automatic Wireless Car Charger

---

Model(s): CC-60, CC-20, CC-30, CC-40, CC-50, CC-70, CC-57, CC-58

---

Applicant: Shenzhen Mgtech Co., Ltd.

---

Address: 401, Bldg.14, No. 48-12, Fuchengao Rd., Pinghu Street, Longgang District, Shenzhen, Guangdong

---

Date of test: Mar. 25, 2020 - Mar. 30, 2020

---

Shenzhen Microtest Co., Ltd.  
<http://www.mtitest.com>

## Table of Contents

<b>1</b>	<b>GENERAL INFORMATION</b>	<b>4</b>
1.1	FEATURE OF EQUIPMENT UNDER TEST (EUT)	4
1.2	TEST MODE	4
1.3	EUT TEST SETUP	5
1.4	ANCILLARY EQUIPMENT	5
1.5	MEASUREMENT UNCERTAINTY	5
<b>2</b>	<b>SUMMARY OF TEST RESULT</b>	<b>6</b>
2.1	OPERATION CHANNEL LIST	6
2.2	TEST CHANNEL	6
<b>3</b>	<b>TEST FACILITIES AND ACCREDITATIONS</b>	<b>7</b>
3.1	TEST LABORATORY	7
3.2	ENVIRONMENTAL CONDITIONS	7
3.3	MEASUREMENT UNCERTAINTY	7
3.4	TEST SOFTWARE	7
<b>4</b>	<b>LIST OF TEST EQUIPMENT</b>	<b>8</b>
<b>5</b>	<b>TEST RESULTS</b>	<b>9</b>
5.1	ANTENNA REQUIREMENT	9
5.1.1	<i>Standard requirement</i>	9
5.1.2	<i>EUT Antenna</i>	9
5.2	CONDUCTED EMISSION	10
5.2.1	<i>Limits</i>	10
5.2.2	<i>Test Procedures</i>	10
5.2.3	<i>Test Setup</i>	10
5.2.4	<i>Test Result</i>	10
5.3	RADIATED EMISSION	15
5.3.1	<i>Limits</i>	15
5.3.2	<i>Test Procedures</i>	16
5.3.3	<i>Test Setup</i>	17
5.3.4	<i>Test Result</i>	17
5.4	OCCUPIED BANDWIDTH	22
5.4.1	<i>Test method</i>	22
5.4.2	<i>Test result</i>	22
	<b>PHOTOGRAPHS OF THE TEST SETUP</b>	<b>23</b>
	<b>PHOTOGRAPHS OF THE EUT</b>	<b>25</b>

## Test Result Certification

Applicant's name: Shenzhen Mgctech Co., Ltd.

Address: 401, Bldg.14, No. 48-12, Fuchengao Rd., Pinghu Street, Longgang District, Shenzhen, Guangdong

Manufacture's name: Shenzhen Mgctech Co., Ltd.

Address: 401, Bldg.14, No. 48-12, Fuchengao Rd., Pinghu Street, Longgang District, Shenzhen, Guangdong

Product name: Automatic Wireless Car Charger

Trademark: MGCTECH

Model name: CC-60, CC-20, CC-30, CC-40, CC-50, CC-70, CC-57, CC-58

Standards: FCC Part 15C

Test procedure: ANSI C63.10-2013

This device described above has been tested by Shenzhen Microtest Co., Ltd. and the test results show that the equipment under test (EUT) is in compliance with the FCC requirements. And it is applicable only to the tested sample identified in the report.

Tested by:   
Danny Xu Mar. 30, 2020

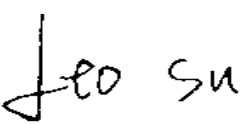
Reviewed by:   
Leo Su Mar. 30, 2020

Approved by:   
Tom Xue Mar. 30, 2020

## 1 GENERAL INFORMATION

### 1.1 Feature of equipment under test (EUT)

Product name:	Automatic Wireless Car Charger
Model name:	CC-60, CC-20, CC-30, CC-40, CC-50, CC-70, CC-57, CC-58
Model difference:	All the models are of the same circuit and RF module, except the appearance and model No..
Operation frequency:	115–205 kHz
Modulation type:	ASK modulation
Antenna type:	Coil Antenna
Power supply:	DC 9V from adapter AC 120V/60Hz
Battery:	N/A
Adapter information:	N/A

### 1.2 Test mode

To investigate the maximum EMI emission characteristics generates from EUT, the test system was pre-scanning tested base on the consideration of following EUT operation mode or test configuration mode which possible have effect on EMI emission level. Each of these EUT operation mode(s) or test configuration mode(s) mentioned above was evaluated respectively.

Test mode	Description
Mode 1	TX

Note1: The test modes were carried out for all operation modes. The final test mode of the EUT was the worst test mode for EMI, and its test data was showed.

Note2: EUT is tested under full load(10W) and belongs to the worst mode.

### 1.3 EUT test setup

See photographs of the test setup in the report for the actual setup and connections between EUT and support equipment.

### 1.4 Ancillary equipment

Equipment	Model	S/N	Manufacturer
Adapter	EQ-24BCN	/	Huizhou Dongyang Yienbi Electronics Co., Ltd.
Load	/	/	/

### 1.5 Measurement Uncertainty

Measurement Uncertainty for a Level of Confidence of 95 %,  $U=2xUc(y)$

Conducted emission(150kHz~30MHz)	$\pm 2.5$ dB
Radiated emission(30MHz~1GHz)	$\pm 4.2$ dB
Radiated emission (above 1GHz)	$\pm 4.3$ dB
Temperature	$\pm 1$ degree
Humidity	$\pm 5$ %

## 2 Summary of Test Result

Item	FCC Part No.	Description of Test	Result
1	FCC PART 15.203	Antenna requirement	Pass
2	FCC PART 15.207	Conducted emission	Pass
3	FCC PART 15.209	Radiated emission	Pass
4	FCC Part 15.215	20dB bandwidth	Pass

### 2.1 Operation channel list

Channel List

Channel	Frequency (kHz)
Low	115
Middle	150
High	205

### 2.2 Test channel

Channel	Frequency (kHz)
Middle	150

### 3 Test Facilities and Accreditations

#### 3.1 Test laboratory

Test Laboratory	Shenzhen Microtest Co., Ltd
Location	No.102A & 302A, East Block, Hengfang Industrial Park, Xingye Road, Xixiang, Bao'an District, Shenzhen, Guangdong, China
FCC Registration No.:	448573

#### 3.2 Environmental conditions

Temperature:	15°C~35°C
Humidity	20%~75%
Atmospheric pressure	98kPa~101kPa

#### 3.3 Measurement uncertainty

Measurement Uncertainty for a Level of Confidence of 95 %,  $U=2xUc(y)$

RF frequency	1 x 10 <sup>-7</sup>
RF power, conducted	± 1 dB
Conducted emission(150kHz~30MHz)	± 2.5 dB
Radiated emission(30MHz~1GHz)	± 4.2 dB
Radiated emission (above 1GHz)	± 4.3 dB
Temperature	±1 degree
Humidity	± 5 %

#### 3.4 Test software

Software Name	Manufacturer	Model	Version
RF Test System	Shenzhen JS tonscond co., ltd	JS1120-3	2.5.77.0418

#### 4 List of test equipment

Equipment No.	Equipment Name	Manufacturer	Model	Serial No.	Calibration date	Due date
MTI-E004	EMI Test Receiver	Rohde&schwarz	ESPI7	100314	2019/10/09	2020/10/08
MTI-E006	TRILOG Broadband Antenna	Schwarzbeck	VULB 9163	9163-872	2019/10/15	2020/10/14
MTI-E014	amplifier	Hewlett-Packard	8447D	3113A06150	2019/10/09	2020/10/08
MTI-E036	Single path vehicle AMN(LISN)	Schwarzbeck	NNBM 8124	01175	2019/10/09	2020/10/08
MTI-E038	Low noise active vertical monopole antenna	Schwarzbeck	VAMP 9243	#565	2019/10/16	2020/10/15
MTI-E039	Biconical antenna	Schwarzbeck	BBA 9106	#164	2019/10/15	2020/10/14
MTI-E041	MXG Vector Signal Generator	Agilent	N5182A	MY49060455	2019/04/16	2020/04/15
MTI-E042	ESG Series Analog signal generator	Agilent	E4421B	GB40051240	2019/05/21	2020/05/20
MTI-E044	Thermometer clock humidity monitor	-	HTC-1	/	2019/04/17	2020/04/16
MTI-E062	Log Periodic Antenna	Schwarzbeck	VUSLP 9111B	#312	2018/04/11	2020/04/10
MTI-E063	Log Periodic Dipole Array Antenna	ETS-LINDGREN	3148B	00224524	2018/04/11	2020/04/10
MTI-E065	Amplifier	EMtrace	RP06A	00117	2019/04/29	2020/04/28
MTI-E071	PXA Signal Analyzer	Agilent	N9030A	MY51350296	2019/10/25	2020/10/24
MTI-E076	EMI Test Receiver	Rohde&schwarz	ESIB26	100273	2019/04/16	2020/04/15
MTI-E078	Synthesized Sweeper	Agilent	83752A	3610A01957	2019/04/16	2020/04/15
MTI-E079	DC Power Supply	Agilent	E3632A	MY40027695	2019/04/16	2020/04/15
MTI-E093	Artificial mains network	3ctest	LISN J50	ES3911805	2019/04/16	2020/04/15
MTI-E096	Power amplifier	Space-Dtronics	EWLNA0118G-P40	1852001	2019/04/29	2020/04/28
MTI-E097	Current Probe	SOLAR ELECTRONICS CO.	9207-1	220095-1	2019/04/17	2020/04/16
MTI-E098	Loop Sensor	SOLAR ELECTRONICS CO.	7334-1	220095-2	2019/04/21	2020/04/20

Note: the calibration interval of the above test instruments is 12 or 24 months and the calibrations are traceable to international system unit (SI).



## **5 Test Results**

### **5.1 Antenna requirement**

#### **5.1.1 Standard requirement**

15.203 requirement: For intentional device, according to 15.203: an intentional radiator shall be designed to ensure that no antenna other than that furnished by the responsible party shall be used with the device

#### **5.1.2 EUT Antenna**

The EUT antenna is Coil Antenna. It comply with the standard requirement. In case of replacement of broken antenna the same antenna type must be used.

## 5.2 Conducted emission

### 5.2.1 Limits

For the following equipment, when designed to be connected to the public utility (AC) power line the radio frequency voltage that is conducted back onto the AC power line on any frequency or frequencies shall not exceed the limits in the following tables. Compliance with the provisions of this paragraph shall be based on the measurement of the radio frequency voltage between each power line and ground at the power terminal using a 50  $\mu$ H/50 ohms line impedance stabilization network (LISN).

Frequency (MHz)	Conducted limit (dB $\mu$ V)	
	Quasi-peak	Average
0.15 -0.5	66 - 56 *	56 - 46 *
0.5 -5	56	46
5 -30	60	50

Note: the limit of " \* " marked band means the limitation decreases linearly with the logarithm of the frequency in the range.

### 5.2.2 Test Procedures

The EUT was placed 0.8 meters from the horizontal ground plane with EUT being connected to the power mains through a line impedance stabilization network (LISN). All other support equipment powered from additional LISN(s). The LISN provide 50 Ohm/ 50uH of coupling impedance for the measuring instrument.

Interconnecting cables that hang closer than 40 cm to the ground plane shall be folded back and forth in the center forming a bundle 30 to 40 cm long.

I/O cables that are not connected to a peripheral shall be bundled in the center. The end of the cable may be terminated, if required, using the correct terminating impedance. The overall length shall not exceed 1 m.

LISN is at least 80 cm from nearest part of EUT chassis.

For the actual test configuration, please refer to the related Item – photographs of the test setup.

### 5.2.3 Test Setup

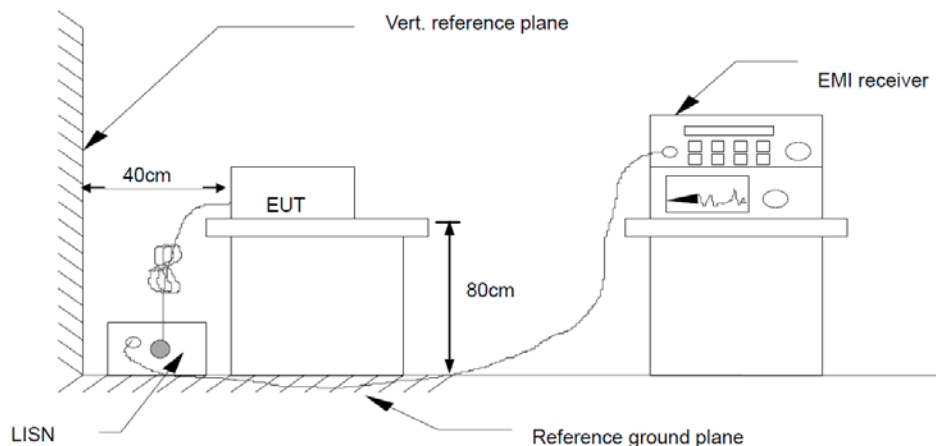

### 5.2.4 Test Result

EUT:	Automatic Wireless Car Charger	Model Name:	CC-60
Pressure:	101kPa	Phase:	L
Test voltage:	DC 9V from adapter AC 120V/60Hz	Test mode:	Mode 1

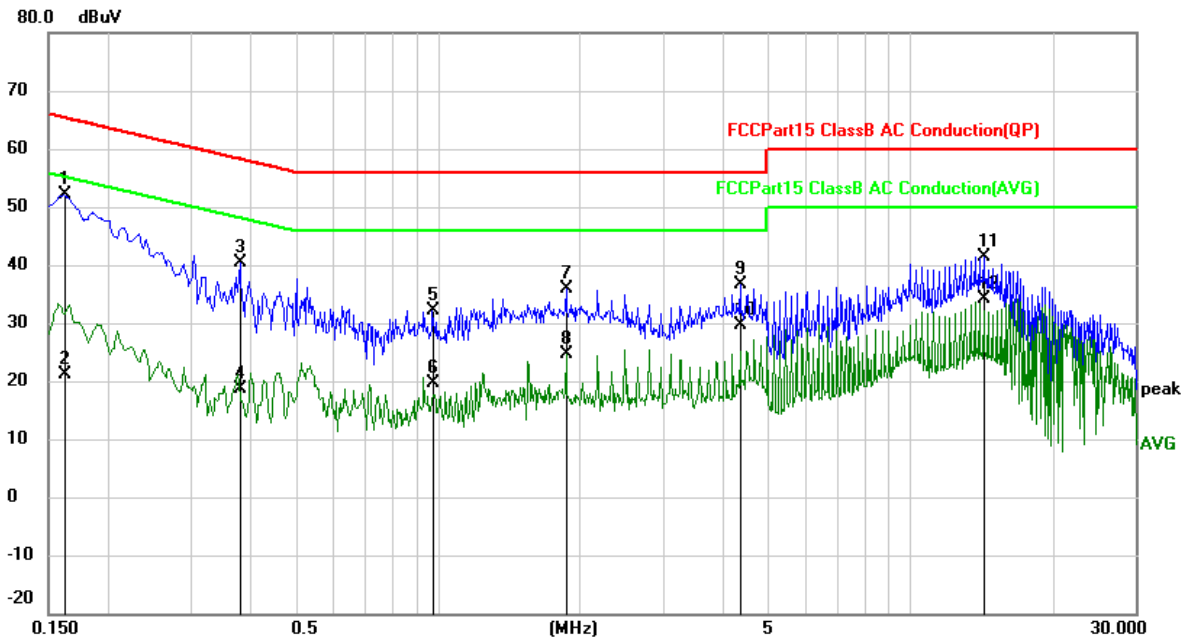

No.	Mk.	Freq.	Reading Level	Correct Factor	Measurement	Limit	Over	Detector
		MHz	dBuV	dB	dBuV	dBuV	dB	
1	*	0.1620	42.33	9.73	52.06	65.36	-13.30	QP
2		0.1620	11.45	9.73	21.18	55.36	-34.18	AVG
3		0.3820	30.45	9.83	40.28	58.24	-17.96	QP
4		0.3820	8.87	9.83	18.70	48.24	-29.54	AVG
5		0.9780	22.10	9.98	32.08	56.00	-23.92	QP
6		0.9780	9.53	9.98	19.51	46.00	-26.49	AVG
7		1.8740	25.89	10.00	35.89	56.00	-20.11	QP
8		1.8740	14.69	10.00	24.69	46.00	-21.31	AVG
9		4.3659	26.53	10.06	36.59	56.00	-19.41	QP
10		4.3659	19.51	10.06	29.57	46.00	-16.43	AVG
11		14.3500	31.06	10.28	41.34	60.00	-18.66	QP
12		14.3500	23.89	10.28	34.17	50.00	-15.83	AVG



EUT:	Automatic Wireless Car Charger	Model Name:	CC-60
Pressure:	101kPa	Phase:	N
Test voltage:	DC 9V from adapter AC 120V/60Hz	Test mode:	Mode 1

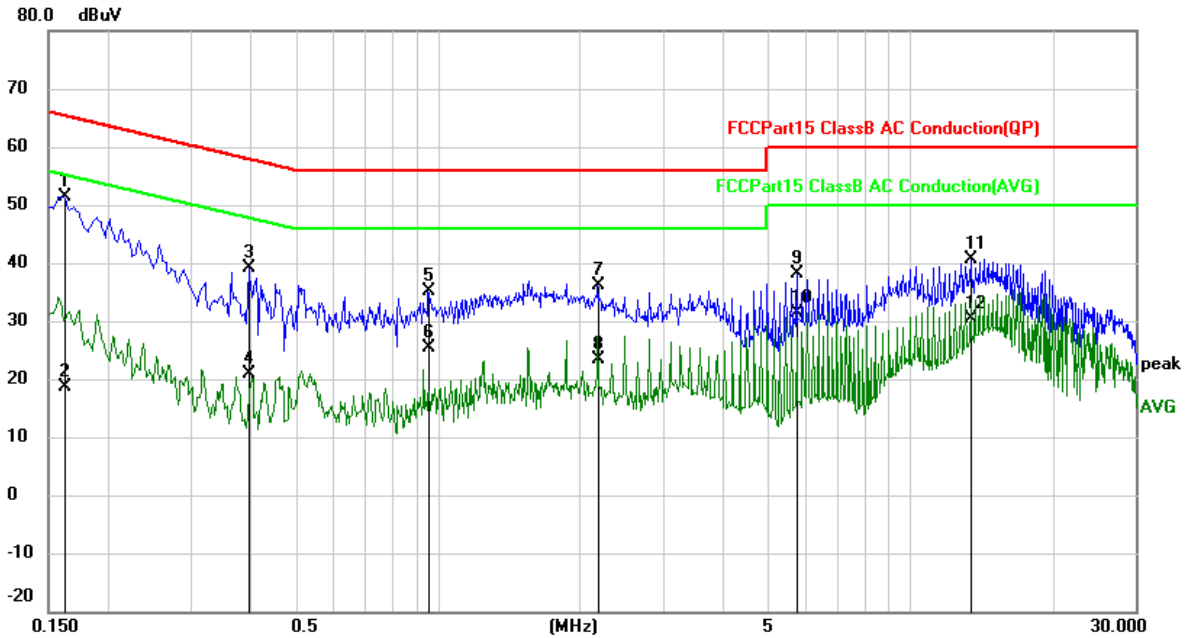

No.	Mk.	Freq.	Reading Level	Correct Factor	Measurement	Limit	Over	
		MHz	dBuV	dB	dBuV	dBuV	dB	Detector
1	*	0.1620	41.75	9.73	51.48	65.36	-13.88	QP
2		0.1620	8.81	9.73	18.54	55.36	-36.82	AVG
3		0.3980	29.17	9.84	39.01	57.90	-18.89	QP
4		0.3980	11.05	9.84	20.89	47.90	-27.01	AVG
5		0.9540	25.16	9.97	35.13	56.00	-20.87	QP
6		0.9540	15.46	9.97	25.43	46.00	-20.57	AVG
7		2.1820	26.11	10.01	36.12	56.00	-19.88	QP
8		2.1820	13.28	10.01	23.29	46.00	-22.71	AVG
9		5.7700	28.04	10.11	38.15	60.00	-21.85	QP
10		5.7700	21.20	10.11	31.31	50.00	-18.69	AVG
11		13.4140	30.35	10.29	40.64	60.00	-19.36	QP
12		13.4140	20.18	10.29	30.47	50.00	-19.53	AVG



EUT:	Automatic Wireless Car Charger	Model Name:	CC-60
Pressure:	101kPa	Phase:	L
Test voltage:	DC 9V from adapter AC 240V/60Hz	Test mode:	Mode 1

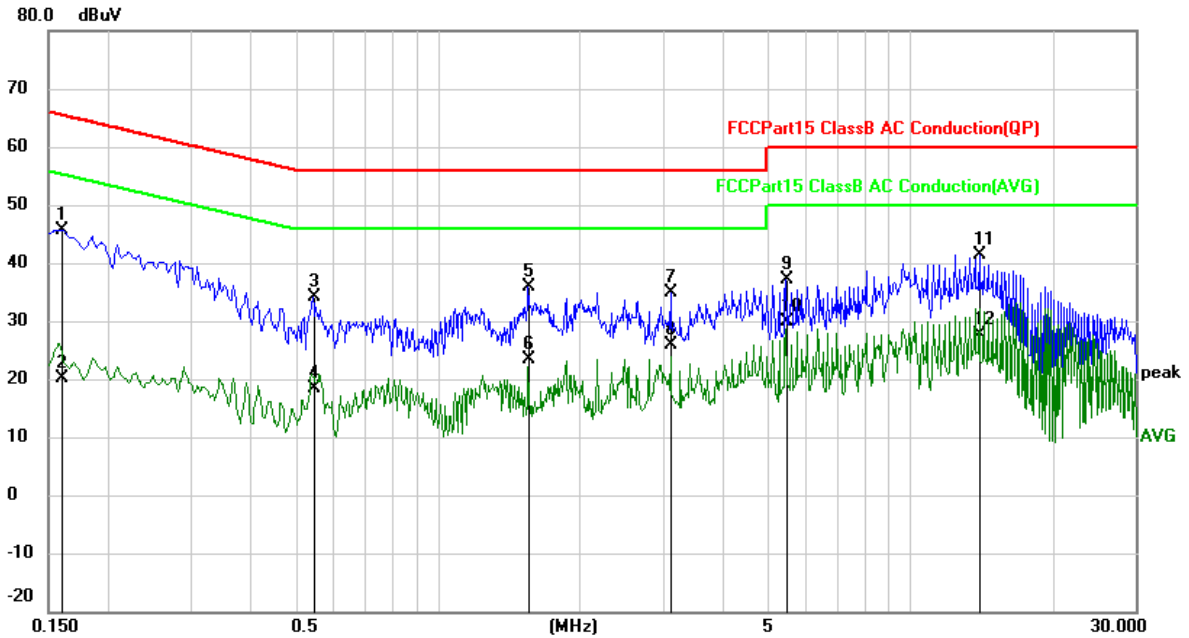

No.	Mk.	Freq. MHz	Reading Level dBuV	Correct Factor dB	Measure- ment dBuV	Limit dBuV	Over dB	Detector
1		0.1607	35.90	9.73	45.63	65.43	-19.80	QP
2		0.1607	10.36	9.73	20.09	55.43	-35.34	AVG
3		0.5460	24.11	9.93	34.04	56.00	-21.96	QP
4		0.5460	8.56	9.93	18.49	46.00	-27.51	AVG
5		1.5580	25.80	9.99	35.79	56.00	-20.21	QP
6		1.5580	13.37	9.99	23.36	46.00	-22.64	AVG
7		3.1140	24.97	10.03	35.00	56.00	-21.00	QP
8		3.1140	15.96	10.03	25.99	46.00	-20.01	AVG
9		5.4500	26.94	10.09	37.03	60.00	-22.97	QP
10		5.4500	19.71	10.09	29.80	50.00	-20.20	AVG
11	*	14.0100	31.10	10.28	41.38	60.00	-18.62	QP
12		14.0100	17.45	10.28	27.73	50.00	-22.27	AVG



EUT:	Automatic Wireless Car Charger	Model Name:	CC-60
Pressure:	101kPa	Phase:	N
Test voltage:	DC 9V from adapter AC 240V/60Hz	Test mode:	Mode 1

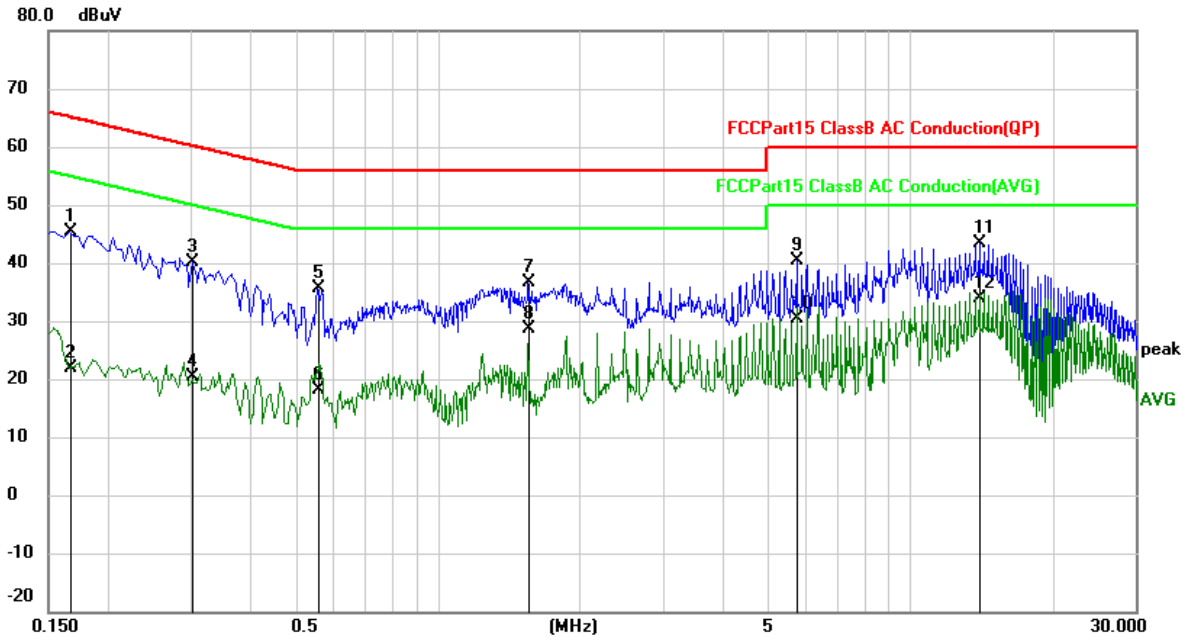

No.	Mk.	Freq.	Reading Level	Correct Factor	Measurement	Limit	Over	Detector
		MHz	dBuV	dB	dBuV	dBuV	dB	
1		0.1660	35.58	9.73	45.31	65.16	-19.85	QP
2		0.1660	12.21	9.73	21.94	55.16	-33.22	AVG
3		0.3020	30.24	9.77	40.01	60.19	-20.18	QP
4		0.3020	10.65	9.77	20.42	50.19	-29.77	AVG
5		0.5580	25.58	9.93	35.51	56.00	-20.49	QP
6		0.5580	8.15	9.93	18.08	46.00	-27.92	AVG
7		1.5580	26.61	9.99	36.60	56.00	-19.40	QP
8		1.5580	18.64	9.99	28.63	46.00	-17.37	AVG
9		5.7619	30.33	10.11	40.44	60.00	-19.56	QP
10		5.7619	20.19	10.11	30.30	50.00	-19.70	AVG
11		14.0140	33.19	10.28	43.47	60.00	-16.53	QP
12	*	14.0140	23.58	10.28	33.86	50.00	-16.14	AVG

### 5.3 Radiated emission

#### 5.3.1 Limits

In case the emission fall within the restricted band specified on 15.205(a), then the 15.209(a) limit in the table below has to be followed.

Frequencies (MHz)	Field Strength (microrvolts/meter)	Measurement Distance (meters)
0.009~0.490	2400/F(KHz)	300
0.490~1.705	24000/F(KHz)	30
1.705~30.0	30	30
30~88	100	3
88~216	150	3
216~960	200	3
Above 960	500	3

#### LIMITS OF RADIATED EMISSION MEASUREMENT (Above 1000MHz)

FREQUENCY (MHz)	Class B (dBuV/m) (at 3M)	
	PEAK	AVERAGE
Above 1000	74	54

#### Notes:

The limit for radiated test was performed according to FCC PART 15C.

The tighter limit applies at the band edges.

Emission level (dBuV/m)=20log Emission level (uV/m).

#### FREQUENCY RANGE OF RADIATED MEASUREMENT (For unintentional radiators)

Highest frequency generated or Upper frequency of measurement used in the device or on which the device operates or tunes (MHz)	Range (MHz)
Below 1.705	30
1.705 – 108	1000
108 – 500	2000
500 – 1000	5000
Above 1000	5 <sup>th</sup> harmonic of the highest frequency or 40 GHz, whichever is lower

Spectrum Parameter	Setting
Attenuation	Auto
Start Frequency	1000 MHz
Stop Frequency	10th carrier harmonic
RB / VB (emission in restricted band)	1 MHz / 1 MHz for Peak, 1 MHz / 10Hz for Average

Receiver Parameter	Setting
Attenuation	Auto
Start ~ Stop Frequency	9kHz~150kHz / RB 200Hz for QP
Start ~ Stop Frequency	150kHz~30MHz / RB 9kHz for QP
Start ~ Stop Frequency	30MHz~1000MHz / RB 120kHz for QP

### 5.3.2 Test Procedures

- a. The measuring distance of at 3 m shall be used for measurements at frequency up to 25GHz. For frequencies above 1GHz, any suitable measuring distance may be used.
- b. The EUT was placed on the top of a rotating table 0.8 meters above the ground at a 3 meter semi-chamber test. The table was rotated 360 degrees to determine the position of the highest radiation.
- c. The height of the equipment or of the substitution antenna shall be 0.8m; above 1GHz, the height was 1.5m, the height of the test antenna shall vary between 1 m to 4 m. Both horizontal and vertical polarizations of the antenna are set to make the measurement.
- d. The initial step in collecting conducted emission data is a spectrum analyzer peak detector mode pre-scanning the measurement frequency range. Significant peaks are then marked and then Quasi Peak detector mode re-measured.
- e. If the Peak Mode measured value compliance with and lower than Quasi Peak Mode Limit, the EUT shall be deemed to meet QP Limits and then no additional QP Mode measurement performed.
- f. For the actual test configuration, please refer to the related Item –EUT Test Photos.
- g. For the radiated emission test above 1GHz:  
Place the measurement antenna away from each area of the EUT determined to be a source of emissions at the specified measurement distance, while keeping the measurement antenna aimed at the source of emissions at each frequency of significant emissions, with polarization oriented for maximum response.
- h. The measurement antenna may have to be higher or lower than the EUT, depending on the radiation pattern of the emission and staying aimed at the emission source for receiving the maximum signal. The final measurement antenna elevation shall be that which maximizes the emissions. The measurement antenna elevation for maximum emissions shall be restricted to a range of heights of from 1 m to 4 m above the ground or reference ground plane.

Note: Both horizontal and vertical antenna polarities were tested and performed pretest to three orthogonal axis. The worst case emissions were reported.



### 5.3.3 Test Setup

#### Radiated Emission Test-Up Frequency Below 30MHz

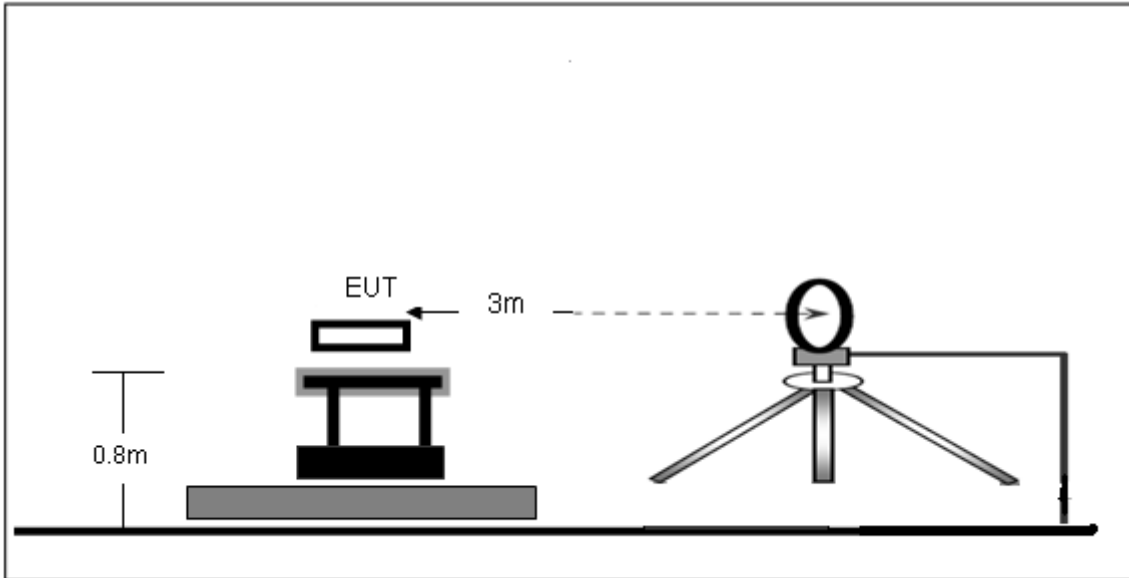

#### Radiated Emission Test-Up Frequency 30MHz~1GHz

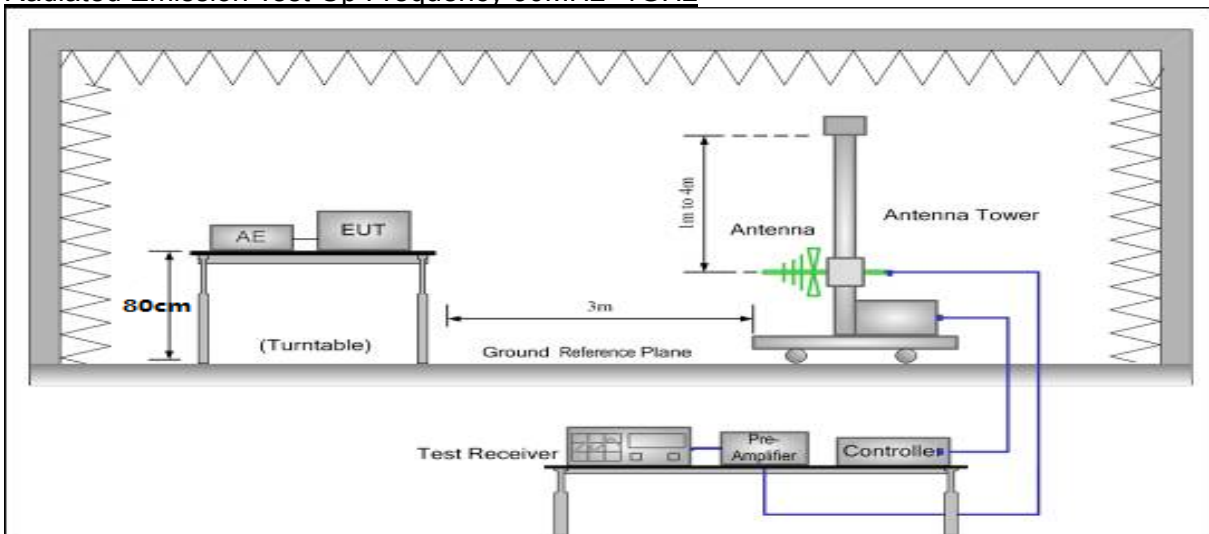

### 5.3.4 Test Result

**Frequency range (9kHz – 30MHz)**

EUT:	Automatic Wireless Car Charger	Model Name:	CC-60
Pressure:	101kPa	Test mode:	Mode 1
Test voltage:	DC 9V from adapter AC 120V/60Hz		

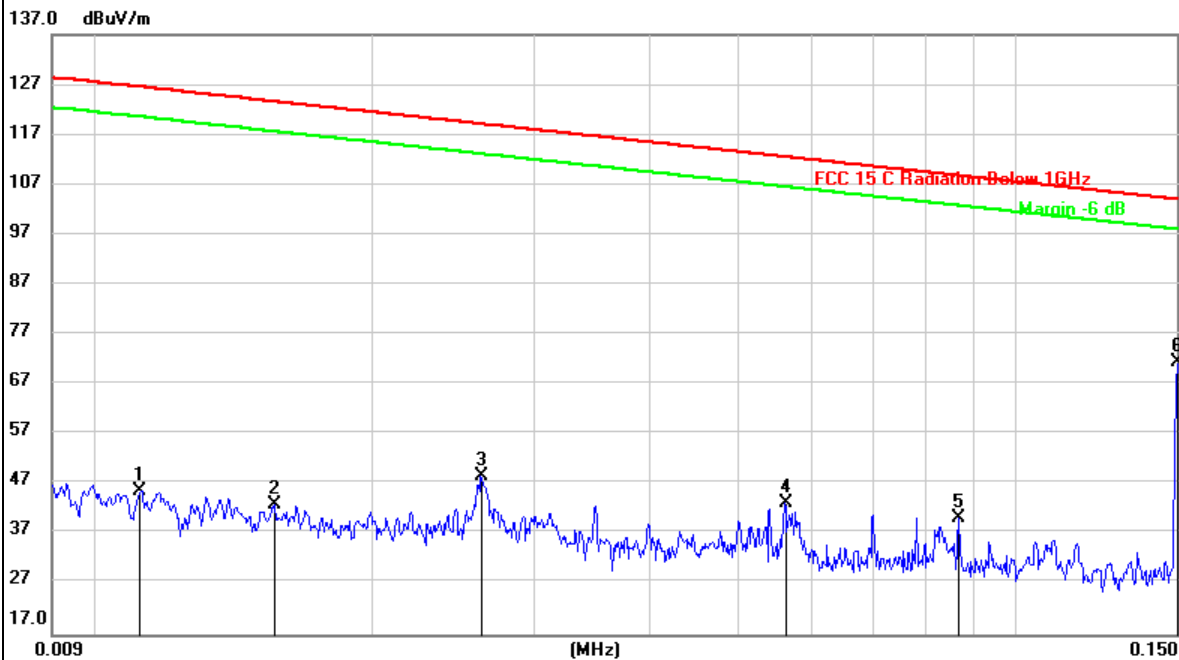

No.	Mk.	Freq.	Reading Level	Correct Factor	Measurement	Limit	Over	Detector
		MHz	dBuV	dBuV/m	dBuV/m	dBuV/m	dB	
1		0.0112	24.92	20.60	45.52	126.53	-81.01	QP
2		0.0157	22.33	20.60	42.93	123.60	-80.67	QP
3		0.0263	27.95	20.60	48.55	119.13	-70.58	QP
4		0.0562	22.33	20.77	43.10	112.56	-69.46	QP
5		0.0868	19.24	20.87	40.11	108.79	-68.68	QP
6	*	0.1500	51.25	20.30	71.55	104.05	-32.50	QP

EUT:	Automatic Wireless Car Charger	Model Name:	CC-60
Pressure:	101kPa	Test mode:	Mode 1
Test voltage:	DC 9V from adapter AC 120V/60Hz		

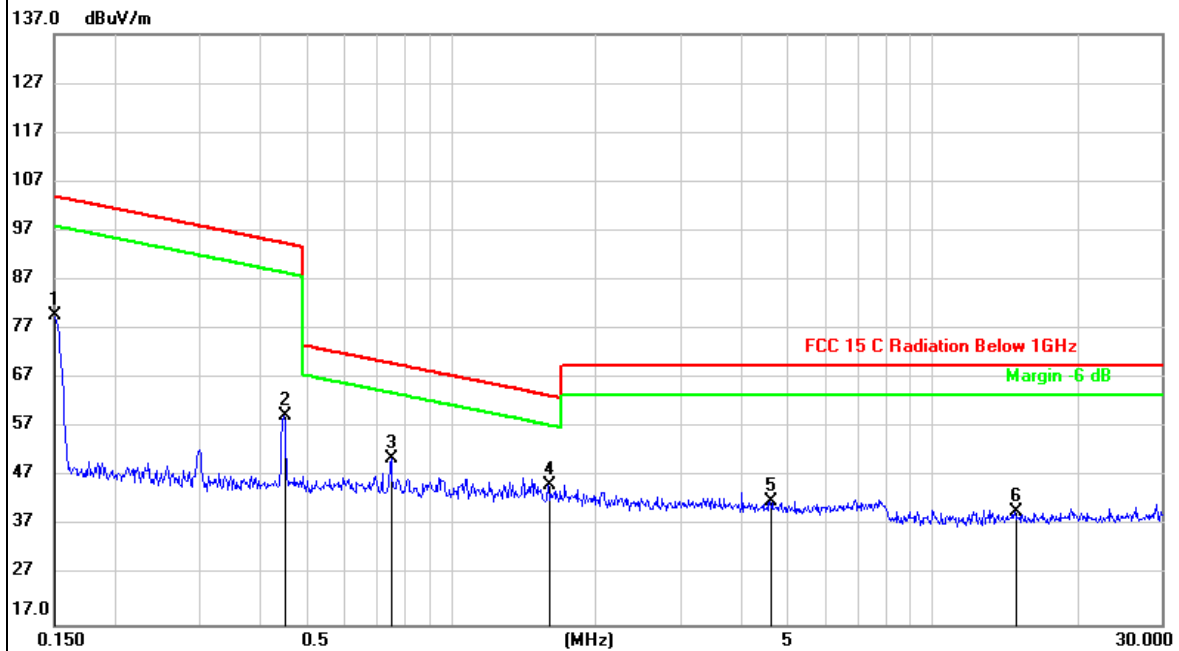

No.	Mk.	Freq. MHz	Reading Level dBuV	Correct Factor dBuV/m	Measure- ment dBuV/m	Limit dBuV/m	Over dB	Detector
1		0.1500	59.67	20.30	79.97	104.05	-24.08	QP
2		0.4492	39.07	20.51	59.58	94.55	-34.97	QP
3		0.7508	29.92	20.68	50.60	70.10	-19.50	QP
4	*	1.5935	24.70	20.69	45.39	63.59	-18.20	QP
5		4.5979	21.75	20.43	42.18	69.50	-27.32	QP
6		14.8281	20.00	20.02	40.02	69.50	-29.48	QP



Frequency range (30MHz – 1GHz)

EUT:	Automatic Wireless Car Charger	Model Name:	CC-60
Pressure:	101kPa	Polarization:	Vertical
Test voltage:	DC 9V from adapter AC 120V/60Hz	Test mode:	Mode 1

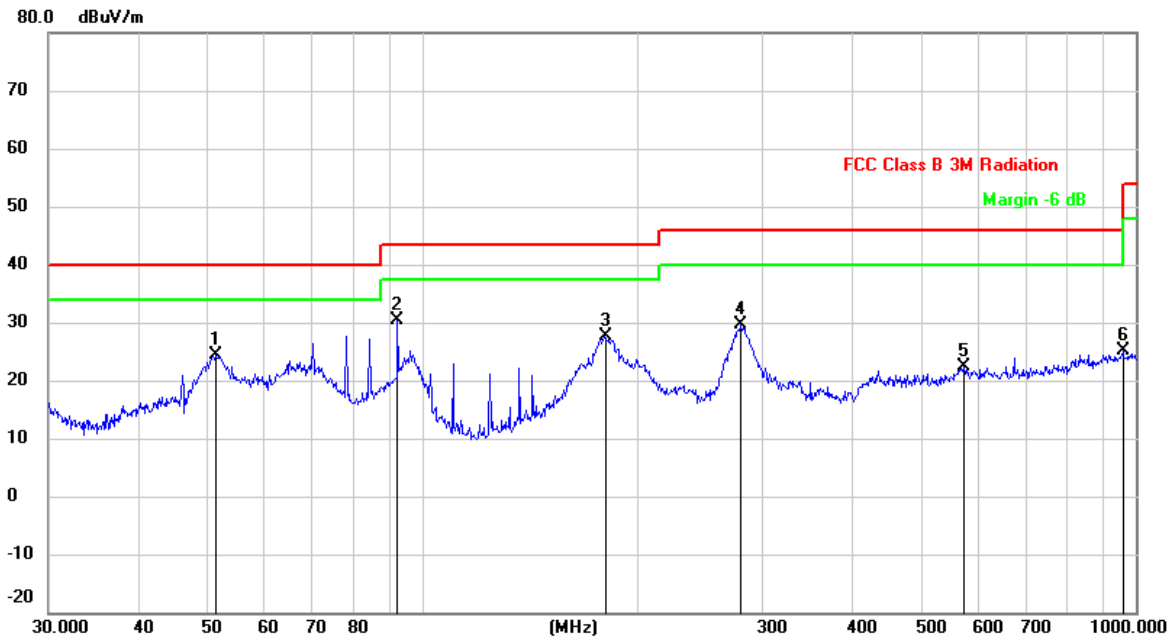

No.	Mk.	Freq. MHz	Reading Level dBuV	Correct Factor dBuV/m	Measure- ment dBuV/m	Limit dBuV/m	Over dB	Detector
1		51.4807	36.95	-12.47	24.48	40.00	-15.52	QP
2	*	92.4624	45.48	-15.10	30.38	43.50	-13.12	QP
3		180.0165	42.63	-14.89	27.74	43.50	-15.76	QP
4		280.0237	40.53	-10.85	29.68	46.00	-16.32	QP
5		574.6258	27.83	-5.44	22.39	46.00	-23.61	QP
6		958.7943	26.68	-1.60	25.08	46.00	-20.92	QP



EUT:	Automatic Wireless Car Charger	Model Name:	CC-60
Pressure:	101kPa	Polarization:	Horizontal
Test voltage:	DC 9V from adapter AC 120V/60Hz	Test mode:	Mode 1

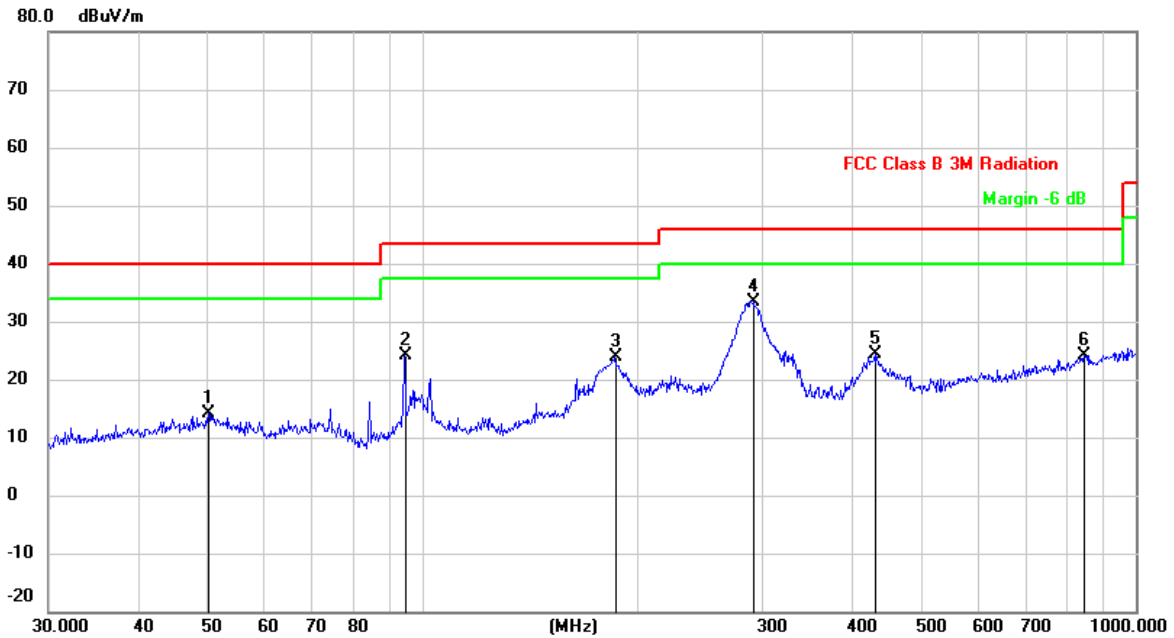

No.	Mk.	Freq. MHz	Reading Level dBuV	Correct Factor dBuV/m	Measure- ment dBuV/m	Limit dBuV/m	Over dB	Detector
1		50.2324	26.46	-12.25	14.21	40.00	-25.79	QP
2		94.4284	38.82	-14.71	24.11	43.50	-19.39	QP
3		186.4409	37.95	-13.98	23.97	43.50	-19.53	QP
4	*	291.0360	43.92	-10.44	33.48	46.00	-12.52	QP
5		431.0316	32.26	-7.93	24.33	46.00	-21.67	QP
6		845.0878	26.91	-2.67	24.24	46.00	-21.76	QP

## 5.4 Occupied bandwidth

### 5.4.1 Test method

Use the following spectrum analyzer settings:

Span = approximately 2 to 3 times the 20 dB bandwidth, centered on a hopping channel

RBW  $\geq 1\%$  of the 20 dB bandwidth

VBW  $\geq$  RBW

Sweep = auto

Detector function = peak

Trace = max hold

The EUT should be transmitting at its maximum data rate. Allow the trace to stabilize. Use the marker-to-peak function to set the marker to the peak of the emission. Use the marker-delta function to measure 20 dB down one side of the emission. Reset the marker-delta function, and move the marker to the other side of the emission, until it is (as close as possible to) even with the reference marker level. The marker-delta reading at this point is the 20 dB bandwidth and 99% occupied bandwidth of the emission.

### 5.4.2 Test result

Frequency (kHz)	20dB emission bandwidth (kHz)	99% occupied bandwidth (kHz)
150	8.140	6.972

Test plots as below:

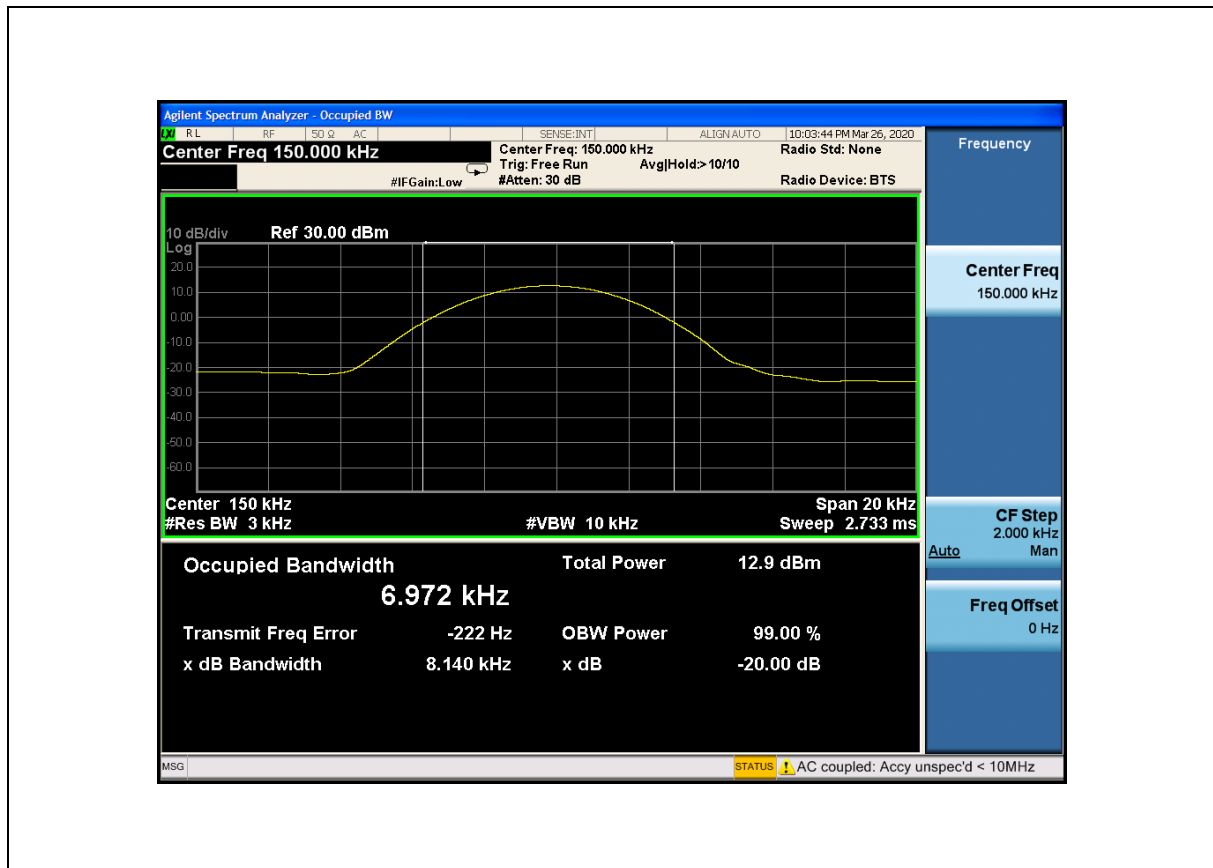

## Photographs of the Test Setup

Radiated emission

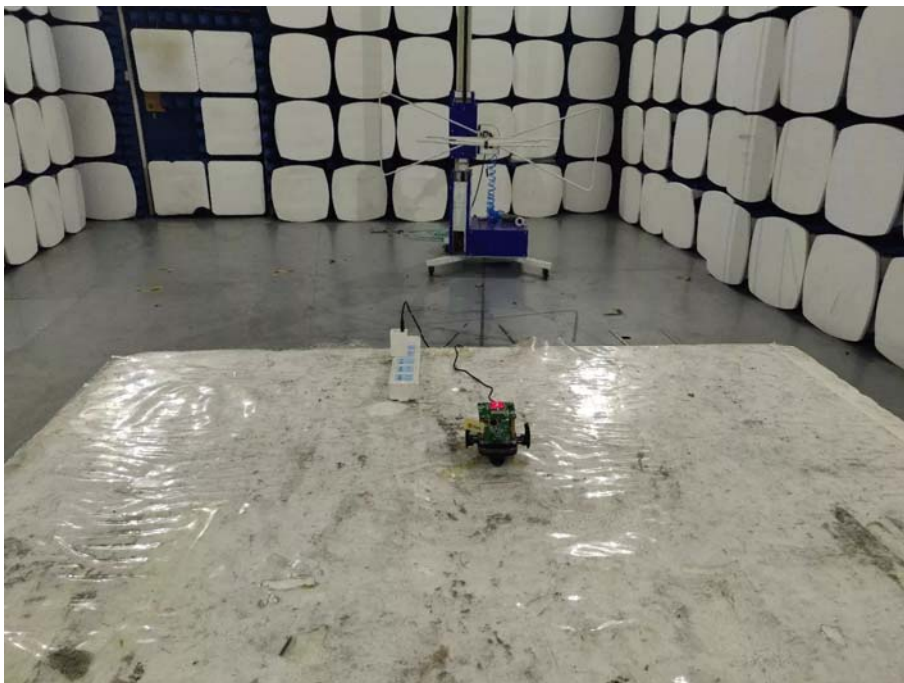
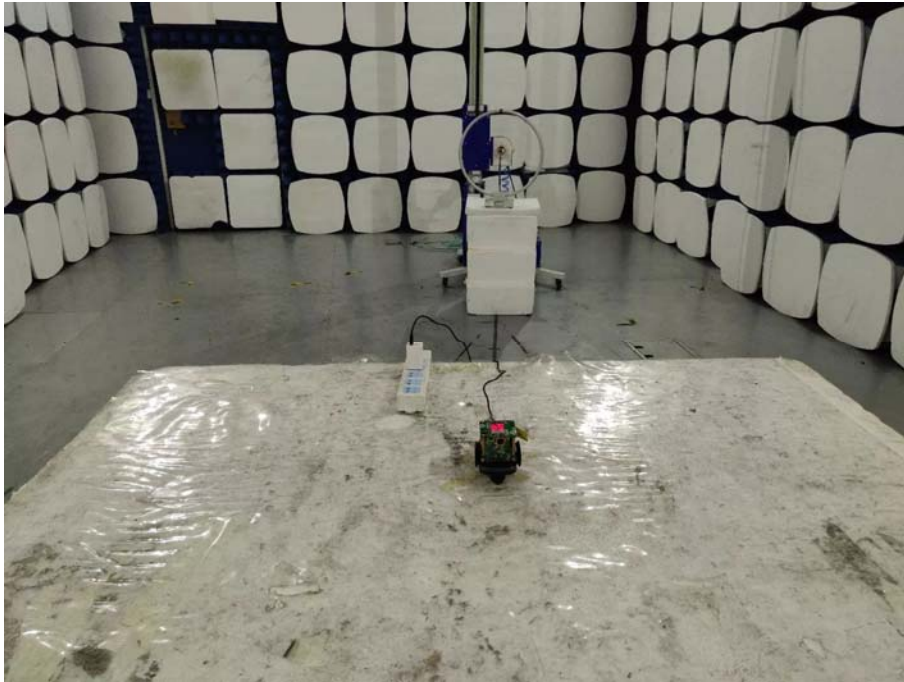

Conducted emission

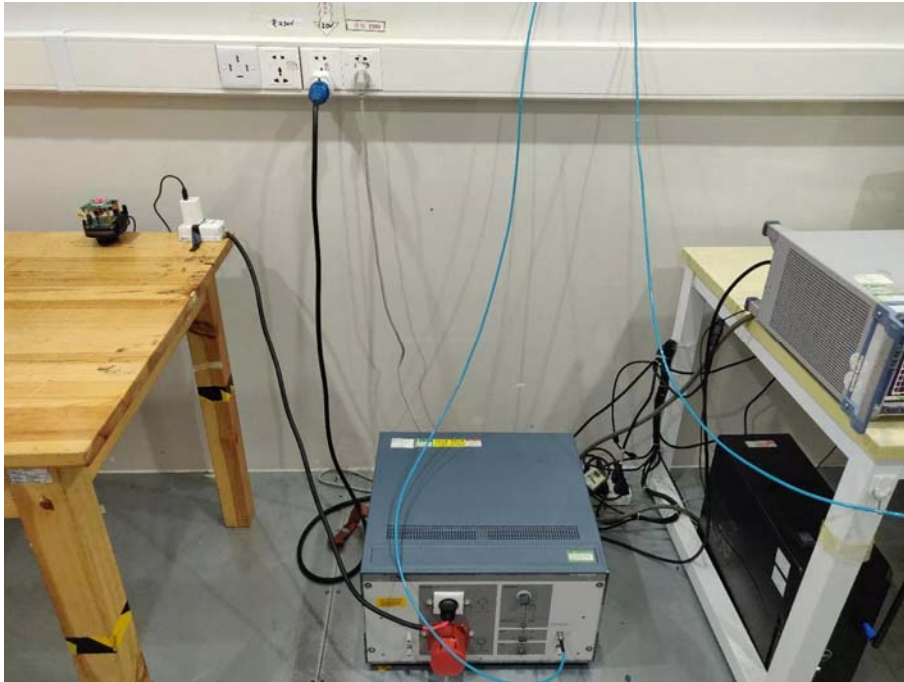





## **Photographs of the EUT**

See the APPENDIX 1: EUT PHOTOS in the report No.: MTi20032002-4E1-1.

**----END OF REPORT----**