



EMI TEST REPORT

Test Report No. : 14113269H-B

Applicant : **DAIHATSU MOTOR CO., LTD.**
Type of EUT : **Keyfree system**
Model Number of EUT : **DH19C-1**
FCC ID : **2AVSADH19C-1**
Test regulation : **FCC Part 15 Subpart B: 2021**
Test Result : **Complied (Refer to SECTION 3)**

1. This test report shall not be reproduced in full or partial, without the written approval of UL Japan, Inc.
2. The results in this report apply only to the sample tested.
3. This sample tested is in compliance with the limits of the above regulation.
4. The test results in this test report are traceable to the national or international standards.
5. This test report must not be used by the customer to claim product certification, approval, or endorsement by the A2LA accreditation body.
6. This test report covers EMC technical requirements. It does not cover administrative issues such as Manual or non-EMC test related Requirements. (if applicable)
7. The all test items in this test report are conducted by UL Japan, Inc. Ise EMC Lab.
8. The opinions and the interpretations to the result of the description in this report are outside scopes where UL Japan, Inc. has been accredited.
9. The information provided from the customer for this report is identified in SECTION 1.

Date of test: December 15 and 17, 2021

Representative test engineer:

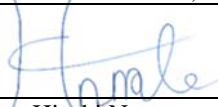
Hiroki Numata
Engineer

Approved by:

Tsubasa Takayama
Leader



CERTIFICATE 5107.02

- The testing in which "Non-accreditation" is displayed is outside the accreditation scopes in UL Japan, Inc.
 There is no testing item of "Non-accreditation".

UL Japan, Inc.
Ise EMC Lab.

4383-326 Asama-cho, Ise-shi, Mie-ken 516-0021 JAPAN
Telephone : +81 596 24 8999
Facsimile : +81 596 24 8124

REVISION HISTORY

Original Test Report No.: 14113269H-B

Revision	Test report No.	Date	Page revised	Contents
- (Original)	14113269H-B	January 14, 2022	-	-

Reference: Abbreviations (Including words undescribed in this report)

A2LA	The American Association for Laboratory Accreditation	IEEE	Institute of Electrical and Electronics Engineers
AAN	Asymmetric Artificial Network	IF	Intermediate Frequency
AC	Alternating Current	ILAC	International Laboratory Accreditation Conference
AM	Amplitude Modulation	ISED	Innovation, Science and Economic Development Canada
AMN	Artificial Mains Network	ISN	Impedance Stabilization Network
Amp, AMP	Amplifier	ISO	International Organization for Standardization
ANSI	American National Standards Institute	JAB	Japan Accreditation Board
Ant, ANT	Antenna	LAN	Local Area Network
AP	Access Point	LCL	Longitudinal Conversion Loss
ASK	Amplitude Shift Keying	LIMS	Laboratory Information Management System
Atten., ATT	Attenuator	LISN	Line Impedance Stabilization Network
AV	Average	MRA	Mutual Recognition Arrangement
BPSK	Binary Phase-Shift Keying	N/A	Not Applicable
BR	Bluetooth Basic Rate	NIST	National Institute of Standards and Technology
BT	Bluetooth	NS	No signal detect.
BT LE	Bluetooth Low Energy	NSA	Normalized Site Attenuation
BW	BandWidth	OBW	Occupied BandWidth
C.F	Correction Factor	OFDM	Orthogonal Frequency Division Multiplexing
Cal Int	Calibration Interval	PER	Packet Error Rate
CAV	CISPR AV	PK	Peak
CCK	Complementary Code Keying	PLT	long-term flicker severity
CDN	Coupling Decoupling Network	POHC(A)	Partial Odd Harmonic Current
Ch., CH	Channel	Pol., Pola.	Polarization
CISPR	Comite International Special des Perturbations Radioelectriques	PR-ASK	Phase Reversal ASK
Corr.	Correction	P _{ST}	short-term flicker severity
CPE	Customer premise equipment	QAM	Quadrature Amplitude Modulation
CW	Continuous Wave	QP	Quasi-Peak
DBPSK	Differential BPSK	QPSK	Quadrature Phase Shift Keying
DC	Direct Current	r.m.s., RMS	Root Mean Square
DET	Detector	RBW	Resolution BandWidth
D-factor	Distance factor	RE	Radio Equipment
Dmax	maximum absolute voltage change during an observation period	REV	Reverse
DQPSK	Differential QPSK	RF	Radio Frequency
DSSS	Direct Sequence Spread Spectrum	RFID	Radio Frequency Identifier
DUT	Device Under Test	RNSS	Radio Navigation Satellite Service
EDR	Enhanced Data Rate	RSS	Radio Standards Specifications
e.i.r.p., EIRP	Equivalent Isotropically Radiated Power	Rx	Receiving
EM clamp	Electromagnetic clamp	SINAD	Ratio of (Signal + Noise + Distortion) to (Noise + Distortion)
EMC	ElectroMagnetic Compatibility	S/N	Signal to Noise ratio
EMI	ElectroMagnetic Interference	SA, S/A	Spectrum Analyzer
EMS	ElectroMagnetic Susceptibility	SG	Signal Generator
EN	European Norm	SVSWR	Site-Voltage Standing Wave Ratio
e.r.p., ERP	Effective Radiated Power	THC(A)	Total Harmonic Current
ETSI	European Telecommunications Standards Institute	THD(%)	Total Harmonic Distortion
EU	European Union	TR, T/R	Test Receiver
EUT	Equipment Under Test	Tx	Transmitting
Fac.	Factor	VBW	Video BandWidth
FCC	Federal Communications Commission	Vert.	Vertical
FHSS	Frequency Hopping Spread Spectrum	WLAN	Wireless LAN
FM	Frequency Modulation	xDSL	Generic term for all types of DSL technology (DSL: Digital Subscriber Line)
Freq.	Frequency		
FSK	Frequency Shift Keying		
Fund	Fundamental		
FWD	Forward		
GFSK	Gaussian Frequency-Shift Keying		
GNSS	Global Navigation Satellite System		
GPS	Global Positioning System		
Hori.	Horizontal		
ICES	Interference-Causing Equipment Standard		
I/O	Input/Output		
IEC	International Electrotechnical Commission		

UL Japan, Inc.

Ise EMC Lab.

4383-326 Asama-cho, Ise-shi, Mie-ken 516-0021 JAPAN

Telephone : +81 596 24 8999

Facsimile : +81 596 24 8124

CONTENTS	PAGE
SECTION 1: Customer information	5
SECTION 2: Equipment under test (EUT).....	5
SECTION 3: Test specification, procedures & results	7
SECTION 4: Operation of EUT during testing.....	10
SECTION 5: Radiated Emission.....	13
APPENDIX 1: Test data	15
Radiated Emission	15
APPENDIX 2: Test instruments	19
APPENDIX 3: Photographs of test setup.....	20
Radiated Emission	20
Worst Case Position.....	24

SECTION 1: Customer information

Company Name : DAIHATSU MOTOR CO., LTD.*
Address : 2-1-1, Momozono, Ikeda-shi, Osaka, 563-8651, Japan
Telephone Number : +81-72-754-5619
Contact Person : Kouji Ozawa

***Remarks:**

DAIHATSU MOTOR CO., LTD. designates DENSO CORPORATION as manufacturer of the product (Keyfree system).

The information provided from the customer is as follows;

- Applicant, Type of EUT, Model Number of EUT, FCC ID on the cover and other relevant pages
- Operating/Test Mode(s) (Mode(s)) on all the relevant pages
- SECTION 1: Customer information
- SECTION 2: Equipment under test (EUT) other than the Receipt Date
- SECTION 4: Operation of EUT during testing

* The laboratory is exempted from liability of any test results affected from the above information in SECTION 2 and 4.

SECTION 2: Equipment under test (EUT)

2.1 Identification of EUT

Type : Keyfree system
Model Number : DH19C-1
Serial Number : Refer to SECTION 4.2
Receipt Date : November 29, 2021
Condition : Production prototype
(Not for Sale: This sample is equivalent to mass-produced items.)
Modification : No Modification by the test lab

2.2 Product Description

Model: DH19C-1 (referred to as the EUT in this report) is a Keyfree system.

General Specification

Rating : System:
DC 12.0 V
Internal:
DC 12.0 V (Transmitter)
DC 5.0 V (Receiver)
Clock Frequency (maximum) : 8 MHz (CPU)

Radio Specification

[Transmitter part]

Radio Type : LF Transmitter
Frequency of Operation : 125 kHz
Oscillator frequency : 4.0000 MHz (Ceramic)
Modulation : ASK (A1D)
Antenna type : LF Antenna (Outside Antenna D)
LF Antenna (Outside Antenna P)
LF Antenna (Outside Antenna B)
LF Antenna (Inside Antenna Fr)
LF Antenna (Inside Antenna Rr)
Immobilizer Antenna
Antenna Specification : LF antenna: Ferrite antenna coil
Immobilizer antenna: Loop antenna coil

[Receiver part]

Frequency of Operation : 433.92 MHz (Keyfree)
433.90 MHz (TPMS)
Oscillator frequency : 33.6 MHz (Crystal)
Intermediate frequency : 525 kHz (Keyfree)
1.05 MHz (TPMS)
Modulation : FSK (F1D)
Type of receiving system : Super-heterodyne
Antenna Specification : Internal antenna (Inverted F antenna)

SECTION 3: Test specification, procedures & results

3.1 Test Specification

Test Specification : FCC Part 15 Subpart B
FCC Part 15 final revised on May 3, 2021 and effective July 2, 2021
Title : FCC 47CFR Part15 Radio Frequency Device
Subpart B Unintentional Radiators

3.2 Procedures and results

Item	Test Procedure	Limits	Deviation	Worst margin	Result	Remarks
Conducted emission	FCC: ANSI C63.4: 2014 + C63.4a: 2017 7. AC power - line conducted emission measurements	FCC: Part 15 Subpart B 15.107(a)	N/A	N/A	N/A	*1)
	ISED: RSS-Gen 7.1	ISED: RSS-Gen 7.2				
Radiated emission	FCC: ANSI C63.4: 2014 + C63.4a: 2017 8. Radiated emission measurements	FCC: Part 15 Subpart B 15.109(a)	N/A	15.94 dB 432.850 MHz, Horizontal, QP <Mode 2>	Complied a)	-
	ISED: RSS-Gen 7.1	ISED: RSS-Gen 7.3				
Antenna Terminal	FCC: ANSI C63.4: 2014 + C63.4a: 2017 12. Measurement of unintentional radiators other than ITE	FCC: Part 15 Subpart B 15.111(a)	N/A	N/A	N/A	*2)
	ISED: - RSS-Gen 7.1	ISED: RSS-Gen 7.4				

*Note: UL Japan, Inc's EMI Work Procedure 13-EM-W0420.

*1) The test is not applicable since the EUT is not the device that is designed to be connected to the public utility (AC) power line.

*2) The receiving antenna (of this EUT) is installed inside the EUT and cannot be removed (permanently attached).
Therefore, Radiated emission test was performed.

a) Refer to APPENDIX 1 (data of Radiated Emission)

Symbols:

Complied The data of this test item has enough margin, more than the measurement uncertainty.

Complied# The data of this test item meets the limits unless the measurement uncertainty is taken into consideration.

3.3 Addition to standard

No addition, exclusion nor deviation has been made from the standard.

3.4 Uncertainty

There is no applicable rule of uncertainty in this applied standard. Therefore, the results are derived depending on whether or not laboratory uncertainty is applied.

The following uncertainties have been calculated to provide a confidence level of 95 % using a coverage factor $k = 2$.

Radiated emission

Measurement distance	Frequency range	Uncertainty (+/-)
3 m	30 MHz to 200 MHz (Horizontal)	4.8 dB
	(Vertical)	5.0 dB
	200 MHz to 1000 MHz (Horizontal)	5.2 dB
	(Vertical)	6.3 dB
10 m	30 MHz to 200 MHz (Horizontal)	4.8 dB
	(Vertical)	4.8 dB
	200 MHz to 1000 MHz (Horizontal)	5.0 dB
	(Vertical)	5.0 dB
3 m	1 GHz to 6 GHz	4.9 dB
	6 GHz to 18 GHz	5.2 dB
1 m	10 GHz to 26.5 GHz	5.5 dB
	26.5 GHz to 40 GHz	5.5 dB
0.5 m	26.5 GHz to 40 GHz	5.5 dB
10 m	1 GHz to 18 GHz	5.2 dB

3.5 Test Location

UL Japan, Inc. Ise EMC Lab.

*A2LA Certificate Number: 5107.02 / FCC Test Firm Registration Number: 884919

ISED Lab Company Number: 2973C / CAB identifier: JP0002

4383-326 Asama-cho, Ise-shi, Mie-ken 516-0021 JAPAN

Telephone: +81 596 24 8999, Facsimile: +81 596 24 8124

Test site	Width x Depth x Height (m)	Size of reference ground plane (m) / horizontal conducting plane	Other rooms	Maximum measurement distance
No.1 semi-anechoic chamber	19.2 x 11.2 x 7.7	7.0 x 6.0	No.1 Power source room	10 m
No.2 semi-anechoic chamber	7.5 x 5.8 x 5.2	4.0 x 4.0	-	3 m
No.3 semi-anechoic chamber	12.0 x 8.5 x 5.9	6.8 x 5.75	No.3 Preparation room	3 m
No.3 shielded room	4.0 x 6.0 x 2.7	N/A	-	-
No.4 semi-anechoic chamber	12.0 x 8.5 x 5.9	6.8 x 5.75	No.4 Preparation room	3 m
No.4 shielded room	4.0 x 6.0 x 2.7	N/A	-	-
No.5 semi-anechoic chamber	6.0 x 6.0 x 3.9	6.0 x 6.0	-	-
No.5 measurement room	6.4 x 6.4 x 3.0	6.4 x 6.4	-	-
No.6 shielded room	4.0 x 4.5 x 2.7	4.0 x 4.5	-	-
No.6 measurement room	4.75 x 5.4 x 3.0	4.75 x 4.15	-	-
No.7 shielded room	4.7 x 7.5 x 2.7	4.7 x 7.5	-	-
No.8 measurement room	3.1 x 5.0 x 2.7	3.1 x 5.0	-	-
No.9 measurement room	8.8 x 4.6 x 2.8	2.4 x 2.4	-	-
No.10 shielded room	3.8 x 2.8 x 2.8	3.8 x 2.8	-	-
No.11 measurement room	4.0 x 3.4 x 2.5	N/A	-	-
No.12 measurement room	2.6 x 3.4 x 2.5	N/A	-	-

3.6 Test data, Test instruments, and Test set up

Refer to APPENDIX.

UL Japan, Inc.

Ise EMC Lab.

4383-326 Asama-cho, Ise-shi, Mie-ken 516-0021 JAPAN

Telephone : +81 596 24 8999

Facsimile : +81 596 24 8124

SECTION 4: Operation of EUT during testing

4.1 Operating Mode(s)

Mode	Remarks
1) RKE Receiving mode	-
2) TPMS Receiving mode	
* EUT was set by the software as follows; Software: DN-2390005080-04.S Version -	

*The test signal level was confirmed to be sufficient to stabilize the local oscillator of the EUT.

* It was confirmed by using checker that the EUT receives the signal from the transmitter (pair of EUT).

4.2 Configuration and peripherals

Mode 1

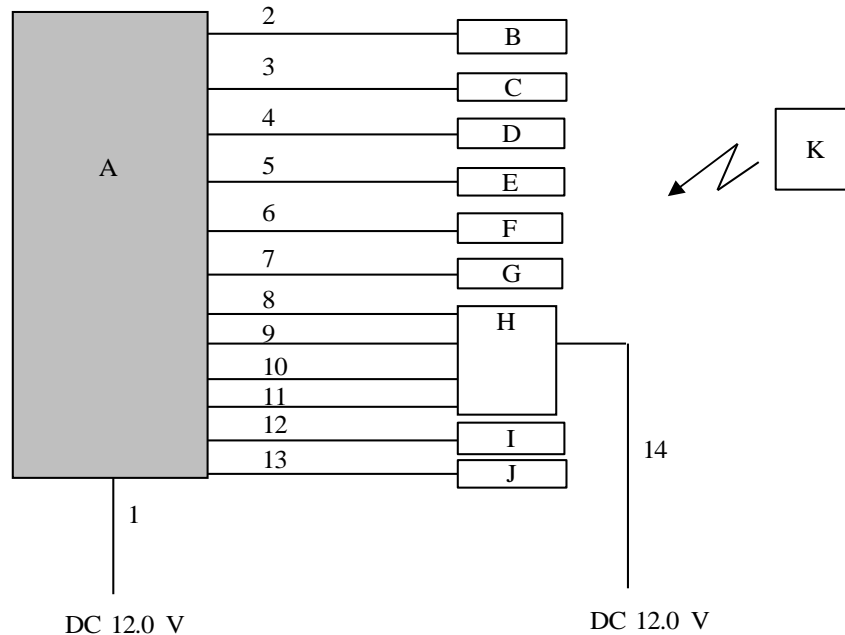

* Cabling and setup(s) were taken into consideration and test data was taken under worse case conditions.

Description of EUT and Support equipment

No.	Item	Model number	Serial number	Manufacturer	Remarks
A	Body ECU	DH19C-1	No.237	DENSO CORPORATION	EUT
B	Antenna	Outside Antenna D	No.237-1	TOKAI RIKA CO., LTD.	-
C	Antenna	Outside Antenna P	No.237-2	TOKAI RIKA CO., LTD.	-
D	Antenna	Outside Antenna B	No.237-3	TOKAI RIKA CO., LTD.	-
E	Antenna	Inside Antenna Fr	No.237-4	TOKAI RIKA CO., LTD.	-
F	Antenna	Inside Antenna Rr	No.237-5	TOKAI RIKA CO., LTD.	-
G	Antenna	Immobilizer Antenna	No.237	TOKAI RIKA CO., LTD.	-
H	Evaluation Bench	-	7	DENSO CORPORATION	-
I	LED	-	-	DENSO CORPORATION	-
J	LED	-	-	DENSO CORPORATION	-
K	Smart Key	-	237	DENSO CORPORATION	-

List of cables used

No.	Name	Length (m)	Shield		Remarks
			Cable	Connector	
1	DC Cable	3.0	Unshielded	Unshielded	-
2	Antenna Cable (AND)	3.0	Unshielded	Unshielded	-
3	Antenna Cable (ANP)	3.0	Unshielded	Unshielded	-
4	Antenna Cable (ANB)	3.0	Unshielded	Unshielded	-
5	Antenna Cable (ANF)	3.0	Unshielded	Unshielded	-
6	Antenna Cable (ANR)	3.0	Unshielded	Unshielded	-
7	Antenna Cable	3.0	Unshielded	Unshielded	-
8	Signal Cable (CN-C)	3.0	Unshielded	Unshielded	-
9	Signal Cable (CN-K)	3.0	Unshielded	Unshielded	-
10	Signal Cable (CN-M)	3.0	Unshielded	Unshielded	-
11	Signal Cable (CN-P)	3.0	Unshielded	Unshielded	-
12	Signal Cable	0.5	Unshielded	Unshielded	-
13	Signal Cable	0.5	Unshielded	Unshielded	-
14	DC Cable	3.0	Unshielded	Unshielded	-

UL Japan, Inc.

Ise EMC Lab.

4383-326 Asama-cho, Ise-shi, Mie-ken 516-0021 JAPAN

Telephone : +81 596 24 8999

Facsimile : +81 596 24 8124

Mode 2

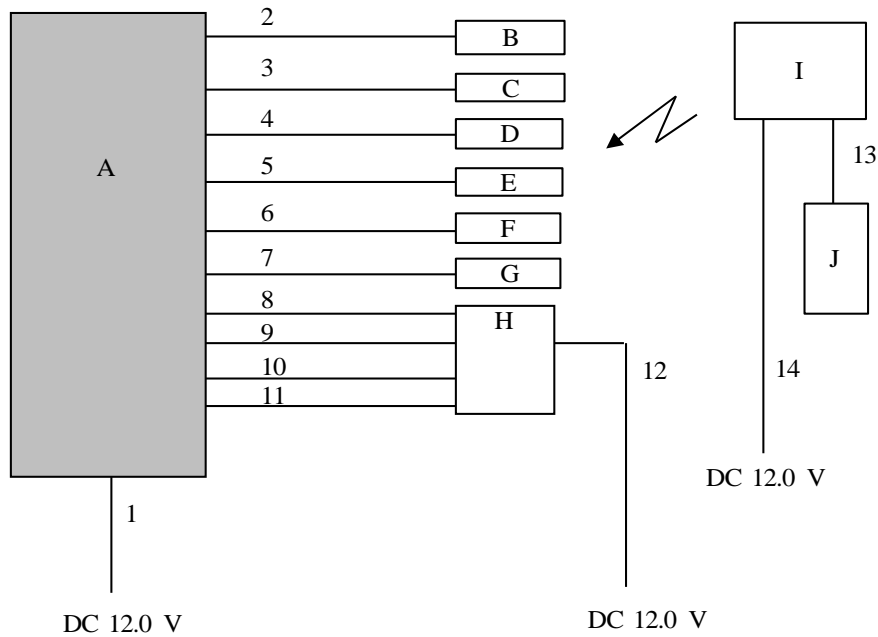

* Cabling and setup(s) were taken into consideration and test data was taken under worse case conditions.

Description of EUT and Support equipment

No.	Item	Model number	Serial number	Manufacturer	Remarks
A	Body ECU	DH19C-1	No.237	DENSO CORPORATION	EUT
B	Antenna	Outside Antenna D	No.237-1	TOKAI RIKA CO., LTD.	-
C	Antenna	Outside Antenna P	No.237-2	TOKAI RIKA CO., LTD.	-
D	Antenna	Outside Antenna B	No.237-3	TOKAI RIKA CO., LTD.	-
E	Antenna	Inside Antenna Fr	No.237-4	TOKAI RIKA CO., LTD.	-
F	Antenna	Inside Antenna Rr	No.237-5	TOKAI RIKA CO., LTD.	-
G	Antenna	Immobilizer Antenna	No.237	TOKAI RIKA CO., LTD.	-
H	Evaluation Bench	-	7	DENSO CORPORATION	-
I	TPMS bench	-	7	-	-
J	TPMS Antenna	-	-	-	-

List of cables used

No.	Name	Length (m)	Shield		Remarks
			Cable	Connector	
1	DC Cable	3.0	Unshielded	Unshielded	-
2	Antenna Cable (AND)	3.0	Unshielded	Unshielded	-
3	Antenna Cable (ANP)	3.0	Unshielded	Unshielded	-
4	Antenna Cable (ANB)	3.0	Unshielded	Unshielded	-
5	Antenna Cable (ANF)	3.0	Unshielded	Unshielded	-
6	Antenna Cable (ANR)	3.0	Unshielded	Unshielded	-
7	Antenna Cable	3.0	Unshielded	Unshielded	-
8	Signal Cable (CN-C)	3.0	Unshielded	Unshielded	-
9	Signal Cable (CN-K)	3.0	Unshielded	Unshielded	-
10	Signal Cable (CN-M)	3.0	Unshielded	Unshielded	-
11	Signal Cable (CN-P)	3.0	Unshielded	Unshielded	-
12	DC Cable	3.0	Unshielded	Unshielded	-
13	Signal Cable	1.0	Shielded	Shielded	-
14	DC Cable	0.7	Unshielded	Unshielded	-

UL Japan, Inc.

Ise EMC Lab.

4383-326 Asama-cho, Ise-shi, Mie-ken 516-0021 JAPAN

Telephone : +81 596 24 8999

Facsimile : +81 596 24 8124

SECTION 5: Radiated Emission

5.1. Operating environment

Test place : No.4 semi anechoic chamber
Temperature : See data
Humidity : See data

5.2. Test configuration

EUT was placed on a urethane platform of nominal size, 1.0 m by 1.5 m, raised 0.8 m above the conducting ground plane.

The EUT was set on the edge of the tabletop.

Test was made with the antenna positioned in both the horizontal and vertical planes of polarization. The measurement antenna was varied in height above the conducting ground plane to obtain the maximum signal strength.

Photographs of the set up are shown in Appendix 3.

5.3. Test conditions

Frequency range : 30 MHz - 200 MHz (Biconical antenna) / 200 MHz - 1000 MHz (Logperiodic antenna)
1000 MHz - 2000 MHz (Horn antenna)
Test distance : 3 m
EUT position : Table top
EUT operation mode : See Clause 4.1

5.4. Test procedure

The height of the measuring antenna varied between 1 and 4 m and EUT was rotated a full revolution in order to obtain the maximum value of the electric field intensity.

The measurements were performed for both vertical and horizontal antenna polarization with the Test Receiver, or the Spectrum Analyzer.

The radiated emission measurements were made with the following detector function of the Test Receiver and the Spectrum Analyzer.

For above 1 GHz, test antenna was aimed at the EUT for receiving the maximum signal and always kept within the illumination area of the 3 dB beamwidth of the antenna.

Frequency	Below 1GHz	Above 1GHz *1)
Instrument used	Test Receiver	Test Receiver
IF Bandwidth	QP: BW 120 kHz	PK: BW 1 MHz, CAV: BW 1 MHz

*1) The measurement data was adjusted to a 3 m distance using the following Distance Factor.

Distance Factor: See Figure 2.

Figure 1: Test Setup

Below 1 GHz

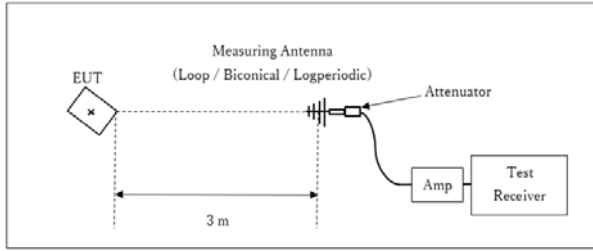

× : Center of turn table

Test Distance: 3 m

1 GHz - 2 GHz

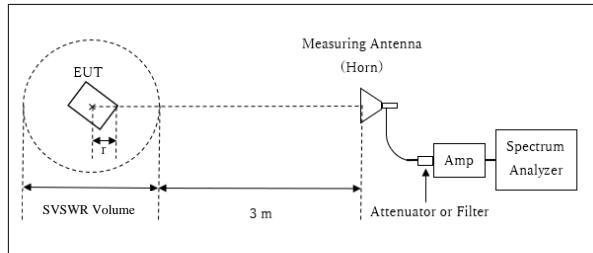

r : Radius of an outer periphery of EUT

× : Center of turn table

Distance Factor: $20 \times \log(3.40 \text{ m}^*/3.0 \text{ m}) = 1.09 \text{ dB}$
* Test Distance: $(3 + \text{SVSWR Volume} / 2) - r = 3.40 \text{ m}$

SVSWR Volume: 2 m
(SVSWR Volume has been calibrated based on CISPR 16-1-4.)
 $r = 0.6 \text{ m}$

- The noise levels were confirmed at each position of X, Y and Z axes of EUTEUT to see the position of maximum noise, and the test was made at the position that has the maximum noise.

5.5. Test result

Summary of the test results: Pass

The limit is rounded down to one decimal place.

The test result is rounded off to one or two decimal places, so some differences might be observed.

Date: December 15, 2021
December 17, 2021

Test engineer: Hiroki Numata
Junki Nagatomi

APPENDIX 1: Test data

Radiated Emission

Report No. 14113269H
Test place Ise EMC Lab.
Semi Anechoic Chamber No.4
Date December 15, 2021
Temperature / Humidity 21 deg. C / 42 % RH
Engineer Hiroki Numata
(Below 1 GHz)
Mode Mode 1

Limit : FCC_Part 15 Subpart B(15.109)_Class B

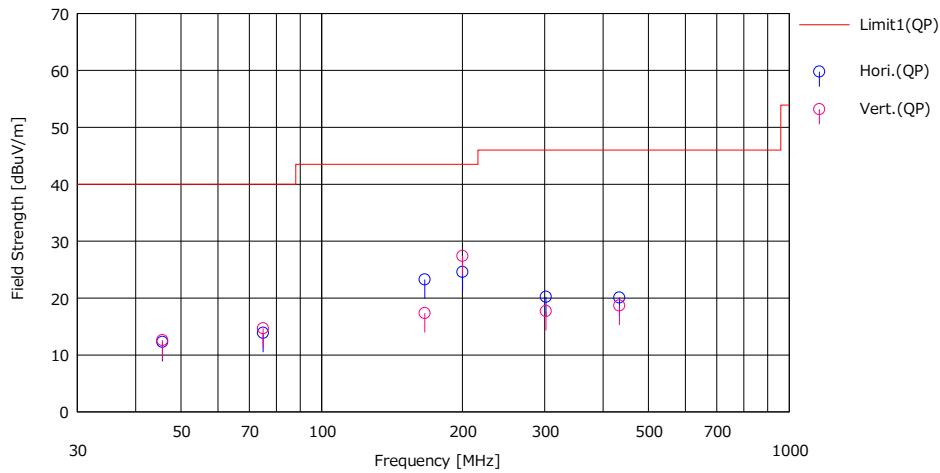

No.	Freq. [MHz]	Reading (QP) [dBuV]	Ant.Fac [dB/m]	Loss [dB]	Gain [dB]	Result (QP) [dBuV/m]	Limit (QP) [dBuV/m]	Margn (QP) [dB]	Pola [H/V]	Height [cm]	Angle [deg]	Ant. Type	Comment
1	45.660	31.00	12.77	7.24	38.72	12.29	40.00	27.71	Hori.	113	359	BA	
2	74.964	38.60	6.46	7.60	38.79	13.87	40.00	26.13	Hori.	230	359	BA	
3	166.224	38.00	15.70	8.43	38.88	23.25	43.50	20.25	Hori.	142	24	BA	
4	200.200	43.10	11.68	8.69	38.89	24.58	43.50	18.92	Hori.	100	180	LA23	
5	301.870	35.70	13.73	9.42	38.65	20.20	46.00	25.80	Hori.	100	124	LA23	
6	433.395	31.80	16.34	10.28	38.35	20.07	46.00	25.93	Hori.	100	354	LA23	
7	45.660	31.30	12.77	7.24	38.72	12.59	40.00	27.41	Vert.	145	235	BA	
8	74.964	39.40	6.46	7.60	38.79	14.67	40.00	25.33	Vert.	146	229	BA	
9	166.224	32.10	15.70	8.43	38.88	17.35	43.50	26.15	Vert.	100	345	BA	
10	200.200	45.90	11.68	8.69	38.89	27.38	43.50	16.12	Vert.	100	182	LA23	
11	301.870	33.20	13.73	9.42	38.65	17.70	46.00	28.30	Vert.	100	258	LA23	
12	433.395	30.40	16.34	10.28	38.35	18.67	46.00	27.33	Vert.	100	312	LA23	

CHART: WITH FACTOR

ANT TYPE: - 30 MHz: LOOP, 30 MHz - 200 MHz: BICONICAL, 200 MHz - 1000 MHz: LOGPERIODIC, 1000 MHz -: HORN

CALCULATION: RESULT = READING + ANT FACTOR + LOSS(CABLE + ATT) - GAIN(AMP)

Except for the above table: adequate margin data below the limits.

UL Japan, Inc.

Ise EMC Lab.

4383-326 Asama-cho, Ise-shi, Mie-ken 516-0021 JAPAN

Telephone : +81 596 24 8999

Facsimile : +81 596 24 8124

Radiated Emission

Report No. 14113269H
Test place Ise EMC Lab.
Semi Anechoic Chamber No.4
Date December 17, 2021
Temperature / Humidity 21 deg. C / 41 % RH
Engineer Junki Nagatomi
(Above 1 GHz)
Mode Mode 1

Limit : FCC_Part 15 Subpart B(15.109)_Class B

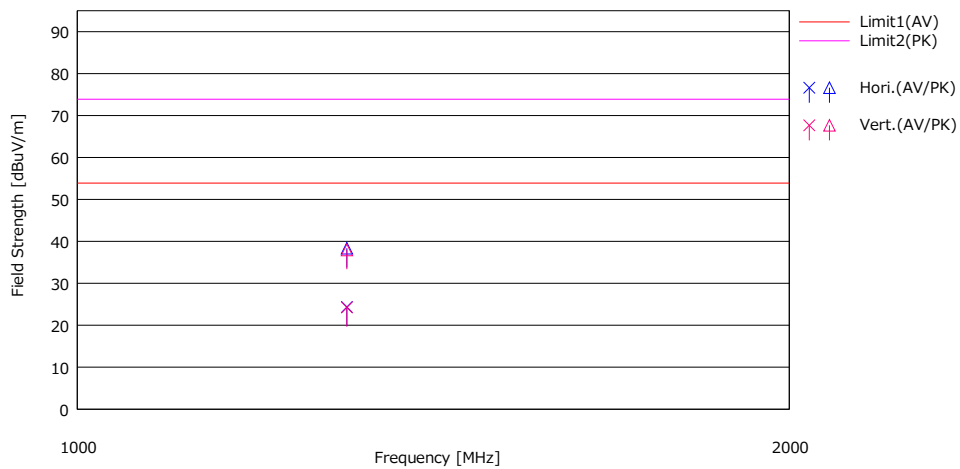

No.	Freq. [MHz]	Reading		Ant Fac [dB/m]	Loss [dB]	Gain [dB]	Result		Limit		Margin		Pola [H/V]	Height [cm]	Angle [deg]	Ant. Type	Comment
		(AV) [dBuV]	(PK) [dBuV]				(AV) [dBuV/m]	(PK) [dBuV/m]	(AV) [dB]	(PK) [dB]							
1	1300.219	30.00	44.00	25.39	2.80	33.83	24.36	38.36	53.90	73.90	29.54	35.54	Hori.	100	0	H21	
2	1300.219	29.90	43.60	25.39	2.80	33.83	24.26	37.96	53.90	73.90	29.64	35.94	Vert.	100	0	H21	

CHART: WITH FACTOR

ANT TYPE: - 30 MHz: LOOP, 30 MHz - 200 MHz: BICONICAL, 200 MHz - 1000 MHz: LOGPERIODIC, 1000 MHz -: HORN

CALCULATION: RESULT = READING + ANT FACTOR + LOSS(CABLE + D-factor) - GAIN(AMP)

Except for the above table: adequate margin data below the limits.

UL Japan, Inc.

Ise EMC Lab.

4383-326 Asama-cho, Ise-shi, Mie-ken 516-0021 JAPAN

Telephone : +81 596 24 8999

Facsimile : +81 596 24 8124

Radiated Emission

Report No. 14113269H
Test place Ise EMC Lab.
Semi Anechoic Chamber No.4
Date December 15, 2021
Temperature / Humidity 21 deg. C / 42 % RH
Engineer Hiroki Numata
(Below 1 GHz)
Mode Mode 2

Limit : FCC_Part 15 Subpart B(15.109)_Class B

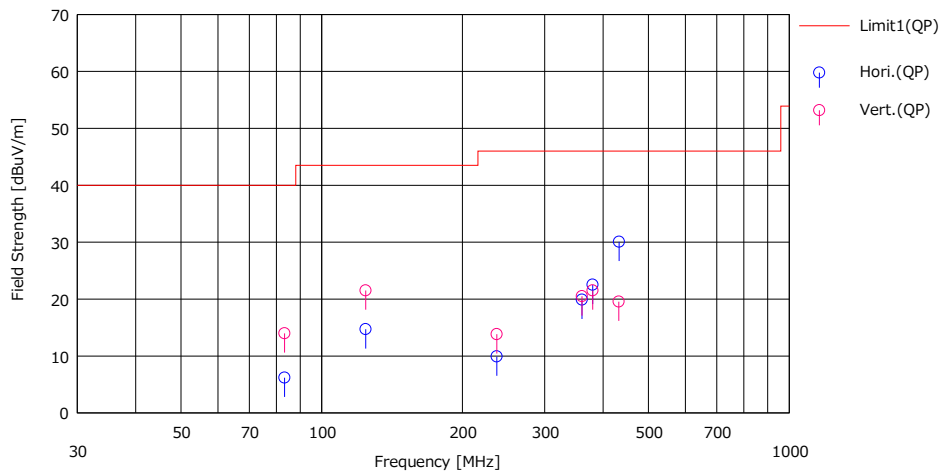

No.	Freq. [MHz]	Reading	Ant.Fac	Loss	Gain	Result	Limit	Margin	Pola	Height	Angle	Ant. Type	Comment
		(QP)				(QP)	(QP)	(QP)					
		[dBuV]	[dB/m]	[dB]	[dB]	[dBuV/m]	[dBuV/m]	[dB]	[H/V]	[cm]	[deg]		
1	83.304	29.90	7.40	7.69	38.81	6.18	40.00	33.82	Hori.	239	7	BA	
2	124.204	32.20	13.29	8.07	38.86	14.70	43.50	28.80	Hori.	156	359	BA	
3	236.840	28.00	11.75	8.96	38.79	9.92	46.00	36.08	Hori.	224	0	LA23	
4	360.484	33.40	15.17	9.81	38.49	19.89	46.00	26.11	Hori.	250	193	LA23	
5	379.917	35.70	15.31	9.93	38.44	22.50	46.00	23.50	Hori.	151	172	LA23	
6	432.850	41.80	16.34	10.27	38.35	30.06	46.00	15.94	Hori.	100	193	LA23	
7	83.304	37.70	7.40	7.69	38.81	13.98	40.00	26.02	Vert.	116	2	BA	
8	124.204	39.00	13.29	8.07	38.86	21.50	43.50	22.00	Vert.	100	272	BA	
9	236.840	31.90	11.75	8.96	38.79	13.82	46.00	32.18	Vert.	100	331	LA23	
10	360.484	34.00	15.17	9.81	38.49	20.49	46.00	25.51	Vert.	100	250	LA23	
11	379.917	34.70	15.31	9.93	38.44	21.50	46.00	24.50	Vert.	117	226	LA23	
12	432.178	31.30	16.33	10.27	38.35	19.55	46.00	26.45	Vert.	133	262	LA23	

CHART: WITH FACTOR

ANT TYPE: - 30 MHz: LOOP, 30 MHz - 200 MHz: BICONICAL, 200 MHz - 1000 MHz: LOGPERIODIC, 1000 MHz -: HORN

CALCULATION: RESULT = READING + ANT FACTOR + LOSS(CABLE + ATT) - GAIN(AMP)

Except for the above table: adequate margin data below the limits.

UL Japan, Inc.

Ise EMC Lab.

4383-326 Asama-cho, Ise-shi, Mie-ken 516-0021 JAPAN

Telephone : +81 596 24 8999

Facsimile : +81 596 24 8124

Radiated Emission

Report No. 14113269H
Test place Ise EMC Lab.
Semi Anechoic Chamber No.4
Date December 17, 2021
Temperature / Humidity 21 deg. C / 41 % RH
Engineer Junki Nagatomi
(Above 1 GHz)
Mode Mode 2

Limit : FCC_Part 15 Subpart B(15.109)_Class B

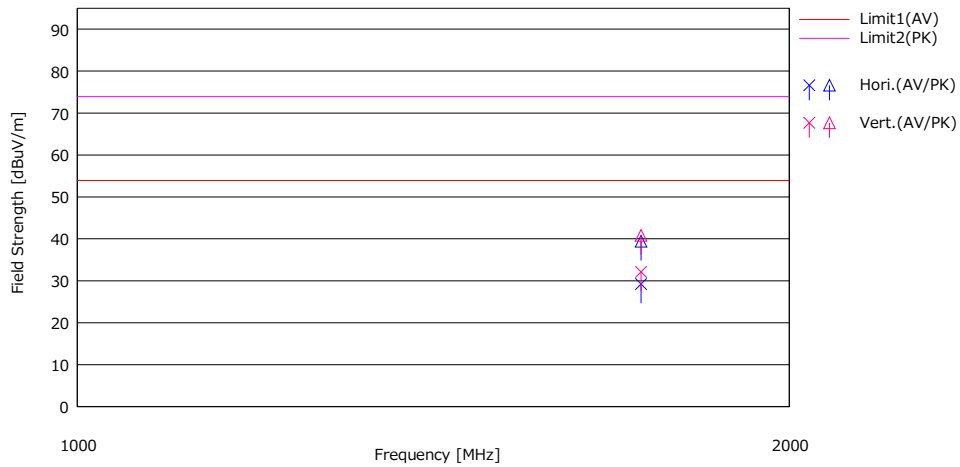

No.	Freq. [MHz]	Reading		Ant.Fac [dB/m]	Loss [dB]	Gain [dB]	Result		Limit		Margin		Pola. [H/V]	Height [cm]	Angle [deg]	Ant. Type	Comment
		(AV) [dBuV]	(PK) [dBuV]				(AV) [dBuV/m]	(PK) [dBuV/m]	(AV) [dB]	(PK) [dB]							
1	1731.394	33.80	44.00	25.02	3.08	32.67	29.23	39.43	53.90	73.90	24.67	34.47	Hori.	100	232	H21	
2	1731.394	36.70	45.40	25.02	3.08	32.67	32.13	40.83	53.90	73.90	21.77	33.07	Vert.	100	158	H21	

CHART: WITH FACTOR

ANT TYPE: - 30 MHz: LOOP, 30 MHz - 200 MHz: BICONICAL, 200 MHz - 1000 MHz: LOGPERIODIC, 1000 MHz -: HORN

CALCULATION: RESULT = READING + ANT FACTOR + LOSS(CABLE + D-factor) - GAIN(AMP)

Except for the above table: adequate margin data below the limits.

UL Japan, Inc.

Ise EMC Lab.

4383-326 Asama-cho, Ise-shi, Mie-ken 516-0021 JAPAN

Telephone : +81 596 24 8999

Facsimile : +81 596 24 8124

APPENDIX 2: Test instruments

Test equipment

Test Item	Local ID	LIMS ID	Description	Manufacturer	Model	Serial	Last Calibration Date	Cal Int
RE	MAEC-04	142011	AC4_Semi Anechoic Chamber(NSA)	TDK	Semi Anechoic Chamber 3m	DA-10005	05/25/2020	24
RE	MOS-15	141562	Thermo-Hygrometer	CUSTOM. Inc	CTH-201	0010	01/15/2021	12
RE	MMM-10	141545	DIGITAL HiTESTER	HIOKI E.E. CORPORATION	3805	51201148	01/07/2021	12
RE	MJM-29	142230	Measure	KOMELON	KMC-36	-	-	-
RE	COTS-MEMI-02	178648	EMI measurement program	TSJ (Techno Science Japan)	TEPTO-DV	-	-	-
RE	MAEC-04-SVSWR	142017	AC4_Semi Anechoic Chamber(SVSWR)	TDK	Semi Anechoic Chamber 3m	DA-10005	04/12/2021	24
RE	MHA-21	141508	Horn Antenna 1-18GHz	Schwarzbeck Mess-Elektronik OHG	BBHA9120D	557	05/10/2021	12
RE	MPA-12	141581	MicroWave System Amplifier	Keysight Technologies Inc	83017A	00650	10/07/2021	12
RE	MCC-257	208936	Microwave Cable	Huber+Suhner	SF126E/11PC35/11PC35/1000M,5000M	537061/126E / 537076/126E	07/18/2021	12
RE	MSA-03	141884	Spectrum Analyzer	Keysight Technologies Inc	E4448A	MY44020357	03/10/2021	12
RE	MTR-03	141942	Test Receiver	Rohde & Schwarz	ESCI	100300	08/05/2021	12
RE	MAT-34	141331	Attenuator(6dB)	TME	UFA-01	-	02/02/2021	12
RE	MBA-05	141425	Biconical Antenna	Schwarzbeck Mess-Elektronik OHG	VHA9103+BBA9106	VHA 91031302	08/28/2021	12
RE	MCC-50	141397	Coaxial Cable	UL Japan	-	-	11/03/2021	12
RE	MLA-23	141267	Logperiodic Antenna (200-1000MHz)	Schwarzbeck Mess-Elektronik OHG	VUSLP9111B	9111B-192	08/28/2021	12
RE	MPA-19	141585	Pre Amplifier	MITEQ	MLA-10K01-B01-35	1237616	02/18/2021	12

*Hyphens for Last Calibration Date and Cal Int (month) are instruments that Calibration is not required (e.g. software), or instruments checked in advance before use.

The expiration date of the calibration is the end of the expired month.

As for some calibrations performed after the tested dates, those test equipment have been controlled by means of an unbroken chains of calibrations.

All equipment is calibrated with valid calibrations. Each measurement data is traceable to the national or international standards.

Test item:

RE: Radiated emission

UL Japan, Inc.

Ise EMC Lab.

4383-326 Asama-cho, Ise-shi, Mie-ken 516-0021 JAPAN

Telephone : +81 596 24 8999

Facsimile : +81 596 24 8124