



Antenna Gain Test Report

Project No.: 4790794042

Client Name: SHENZHEN MIZIT TECHNOLOGY CO.,LTD

Client Address: A313 Mingyue Huadu, Gonghe Industrial Road, Gongle Community, Xixiang Street, Bao'an District, Shenzhen

Product Name: PCB Antenna

Product Model: /

Manufacture: SHENZHEN MIZIT TECHNOLOGY CO.,LTD

Antenna Type: PCB

Antenna Size: 9.8 mm * 4.5 mm

Project Engineer: James Qin

Test Engineer: Burt Hu

Test Standards: ANSI/IEEE std 149-2021

Date of Tested: 2023.5.19

Issued Date: 2023.5.19

UL Verification Services (Guangzhou) Co., Ltd, Song Shan Lake Branch

This report shall not be reproduced except in full, without the written approval of UL Verification Services (Guangzhou) Co., Ltd, Song Shan Lake Branch.



1 Test Equipment Information

Equipment	Manufacturer	Mode No.	Serial No.	Cal date	Cal Due
Test Chamber	ETS-Lindgren	8500	/	/	/
Test Software	ETS-Lindgren	EMQuest V1.12	1496	/	/
Network Analyzer	Keysight	E5071C	MY46524531	2022.10.17	2023.10.16
EXA Singal Analyzer	Keysight	N9010A	MY55150514	2022.10.17	2023.10.16

2 Setup block diagram

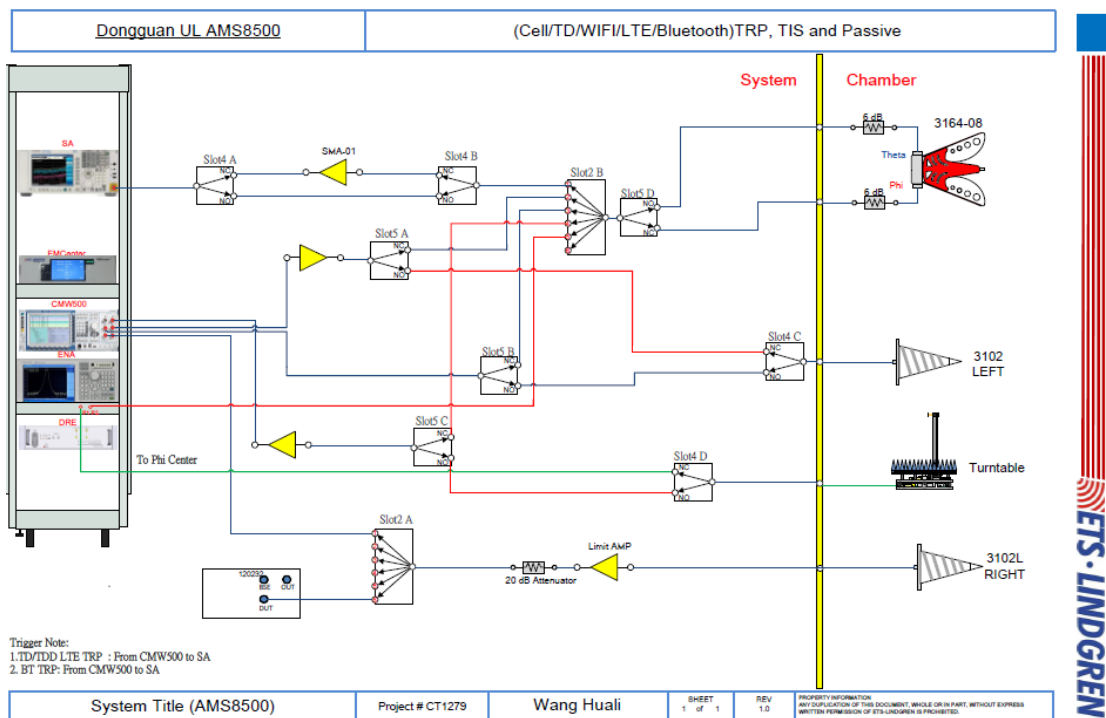

UL Verification Services (Guangzhou) Co., Ltd, Song Shan Lake Branch

This report shall not be reproduced except in full, without the written approval of UL Verification Services (Guangzhou) Co., Ltd, Song Shan Lake Branch.



3 Test Temperature and Humidity

Temperature: 23.1°C

Humidity: 63.3%

4 Test Step Flow

- 1) Maintain the test ambient temperature of 23 ± 2 C, the instrument is powered on and preheated for more than 30 minutes;
- 2) Turn on the darkroom power supply, connect the test cable, and set up the sample according to the standard;
- 3) Outline sets the test content objectives and conducts calibration tests;
- 4) Run the software, when the test is completed, export the corresponding test diagram and test data, and save to the corresponding directory.

5 Test Result

Frequency (MHz)	Efficiency (%)	Gain (dBi)
2400	55.66	2.03
2410	55.31	2.07
2420	55.02	2.06
2430	53.93	2.02
2440	52.48	1.90
2450	50.26	1.64
2460	47.68	1.38
2470	44.96	1.10
2480	42.68	0.82
2490	40.83	0.63
2500	39.16	0.41

UL Verification Services (Guangzhou) Co., Ltd, Song Shan Lake Branch

This report shall not be reproduced except in full, without the written approval of UL Verification Services (Guangzhou) Co., Ltd, Song Shan Lake Branch.



Polarization Pattern Photos

Theta Polarization(Theta Angle=90°)

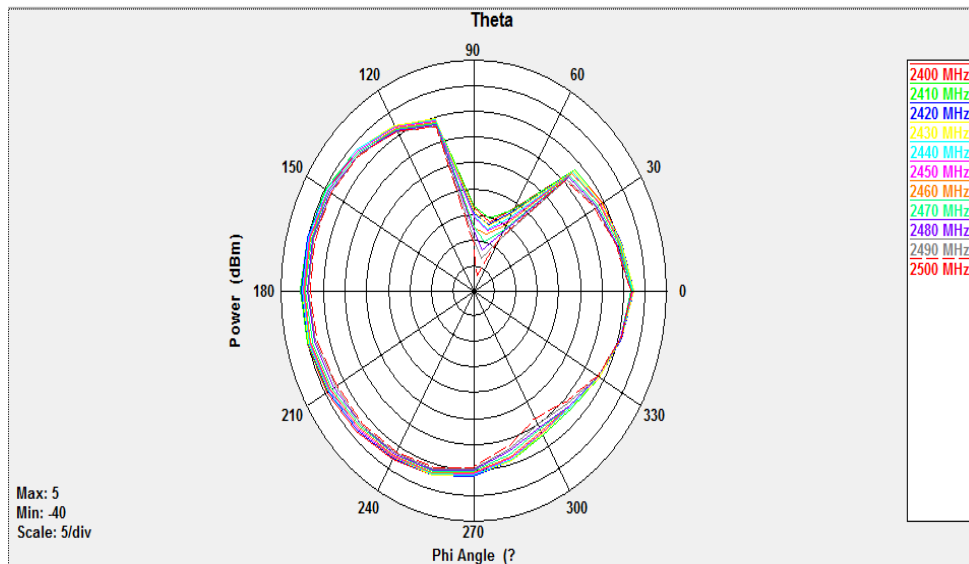

Phi Polarization(Theta Angle=90°)

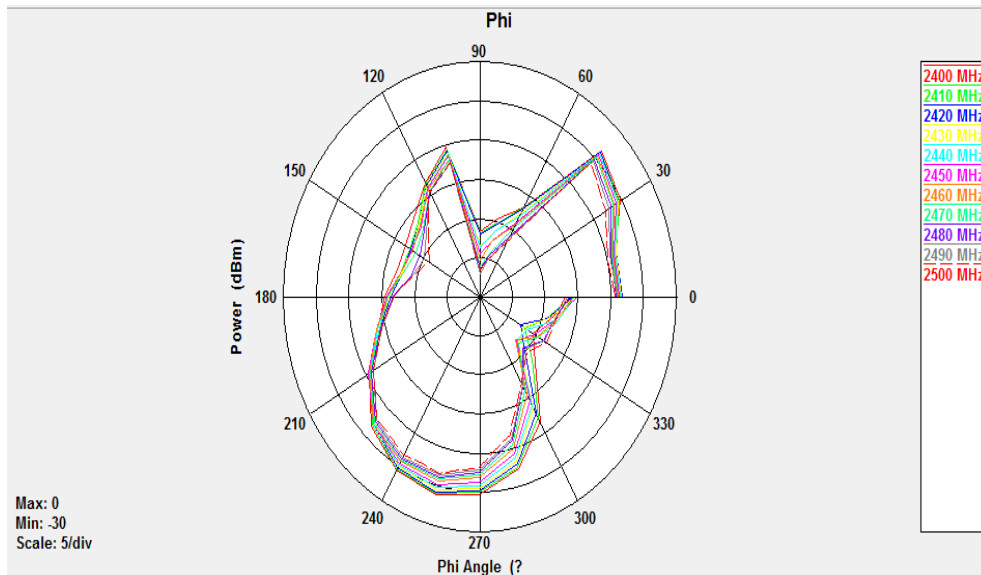

UL Verification Services (Guangzhou) Co., Ltd, Song Shan Lake Branch

This report shall not be reproduced except in full, without the written approval of UL Verification Services (Guangzhou) Co., Ltd, Song Shan Lake Branch.



Total 3D Plot(Fre.2410MHz)

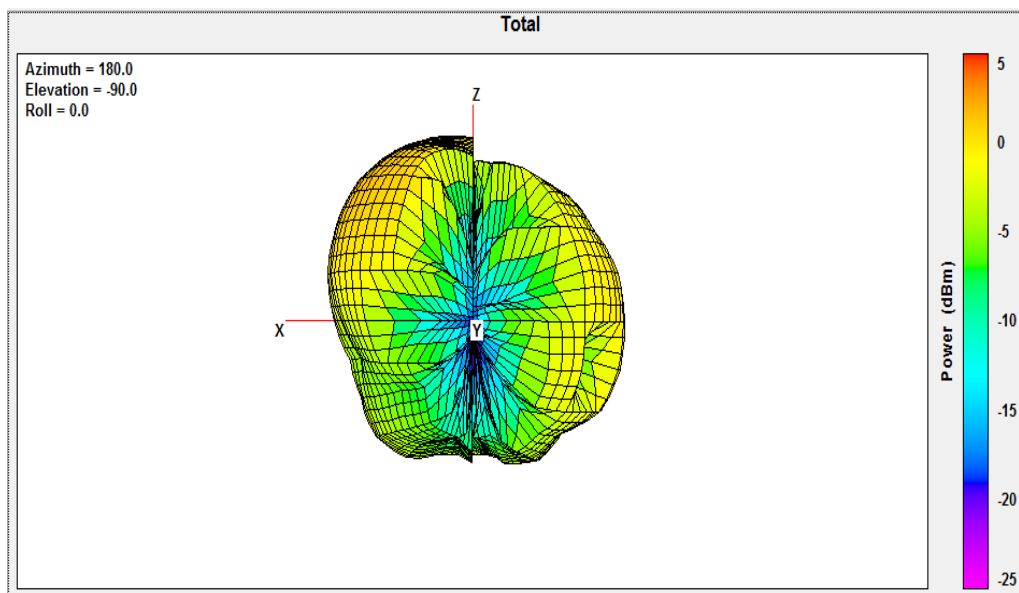
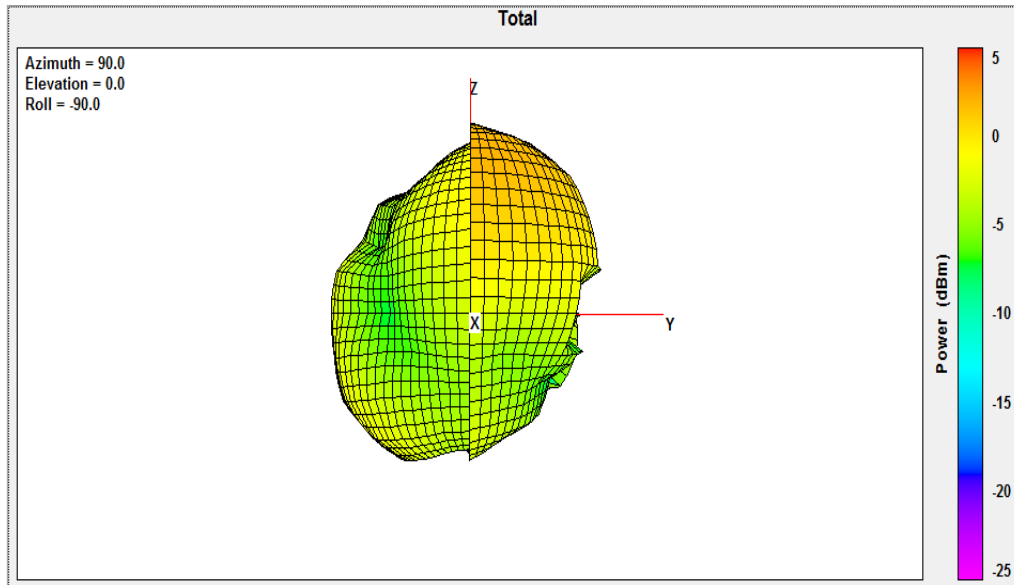

UL Verification Services (Guangzhou) Co., Ltd, Song Shan Lake Branch

This report shall not be reproduced except in full, without the written approval of UL Verification Services (Guangzhou) Co., Ltd, Song Shan Lake Branch.

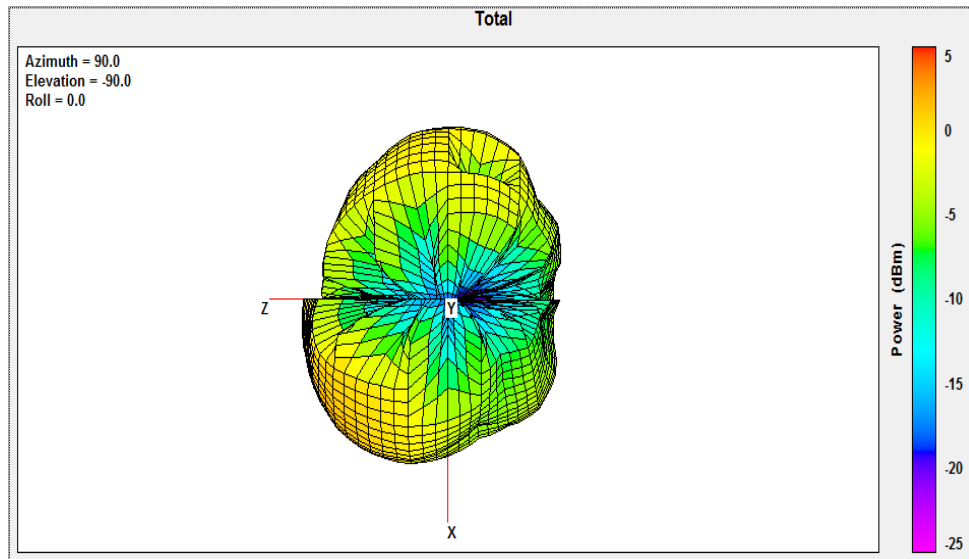

UL Verification Services (Guangzhou) Co., Ltd, Song Shan Lake Branch

This report shall not be reproduced except in full, without the written approval of UL Verification Services (Guangzhou) Co., Ltd, Song Shan Lake Branch.



6 Photo

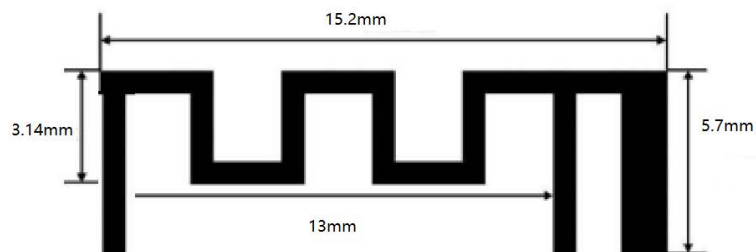

END OF REPORT

UL Verification Services (Guangzhou) Co., Ltd, Song Shan Lake Branch

*This report shall not be reproduced except in full, without the written approval of UL Verification Services (Guangzhou) Co., Ltd,
Song Shan Lake Branch.*