

Media

To enjoy content from an external hard drive (sold separately), connect your USB drive to the USB port on your TV.

Press ▼ / ▲ buttons to select Photo & Video / Photo / Video / Music

Photo and Video

View photos and videos using the Photo & Video app

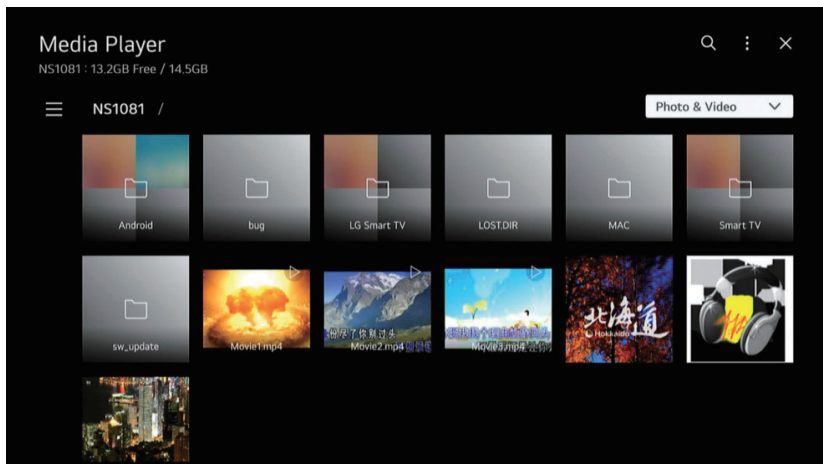
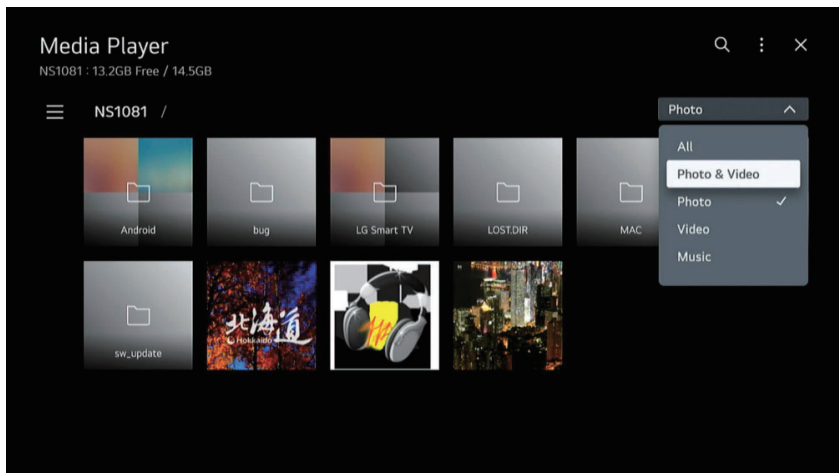

Photo

Selecting a photo in the Photo & Videos app runs the photo player. From there, you can view your saved photos.



Video

Selecting a photo in the Photo & Videos app runs the video player. From there, you can view your saved videos.



Media

Music

Play music by selecting the music files saved in the Music app or by selecting the music player icon during content playback in apps such as Photo & Video.

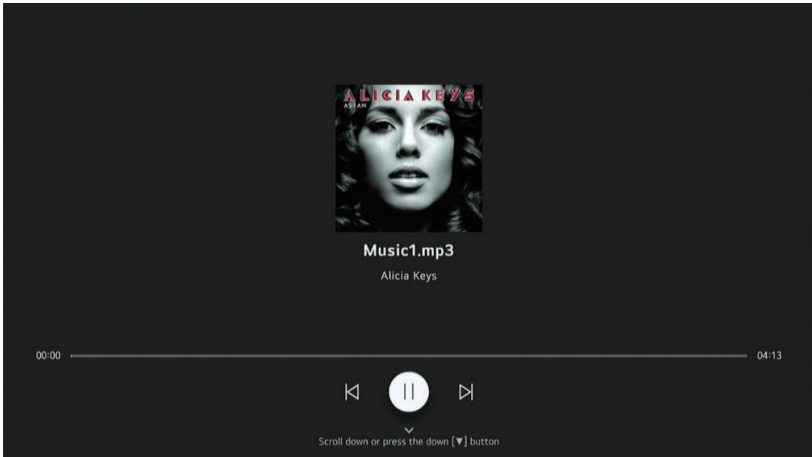

LG ThinQ

With the LG ThinQ app, you can control your home appliances (including TV, washer, air conditioner and more) remotely.

TV Remote

The ThinQ app is reborn as a TV remote.

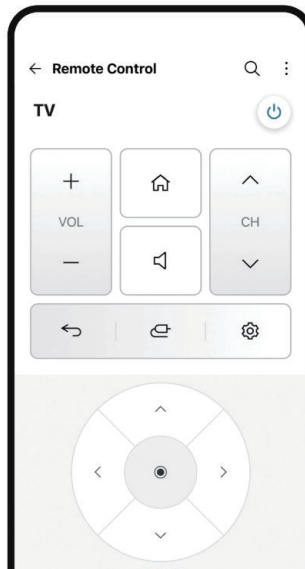

Connecting External Devices

Connecting an Antenna to Your TV

Connect your antenna's output cable to the TV's antenna input to access over-the-air channels. Refer to your antenna's user manual for further instructions. Press the TV remote's SOURCE button until you reach "TV".

1- Antenna (sold separately)

2- Amplifier Antenna (external)

3- Amplifier Antenna (internal)

4- Antenna Amplifier Power Plug

5- Plug Antenna (75 Ω)

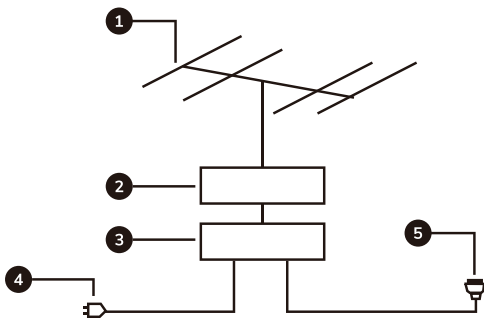

Use an RJ45 - RJ45 plug (sold separately) to connect an external modem or other network equipment.

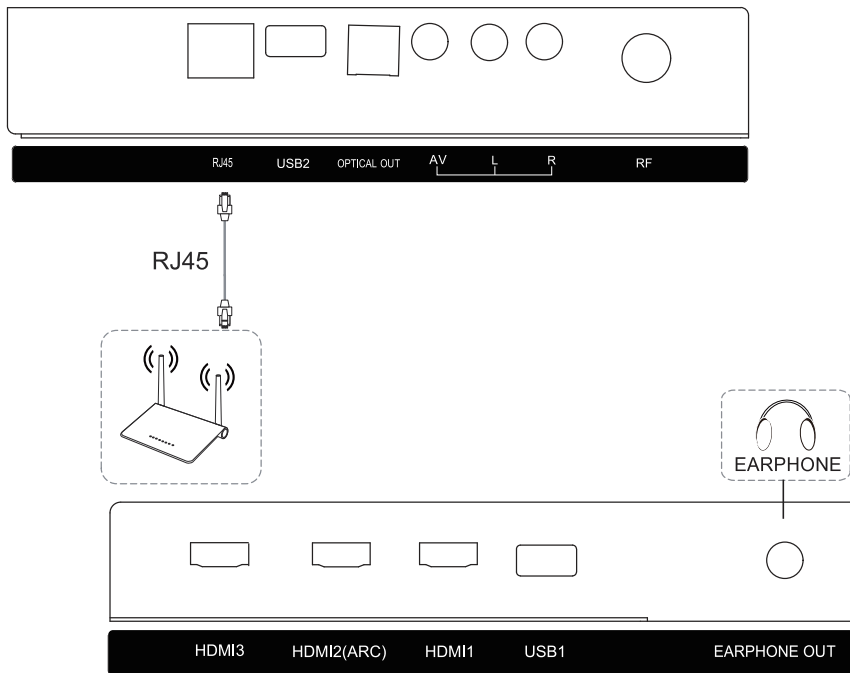

Connecting Headphones to Your TV

Connect headphones (sold separately) to your TV for private listening.

Connecting External Devices

Connecting an External Device to Your TV via HDMI®

Use an HDMI® cable (sold separately) to connect an external device, such as a laptop or DVD player, to your TV.

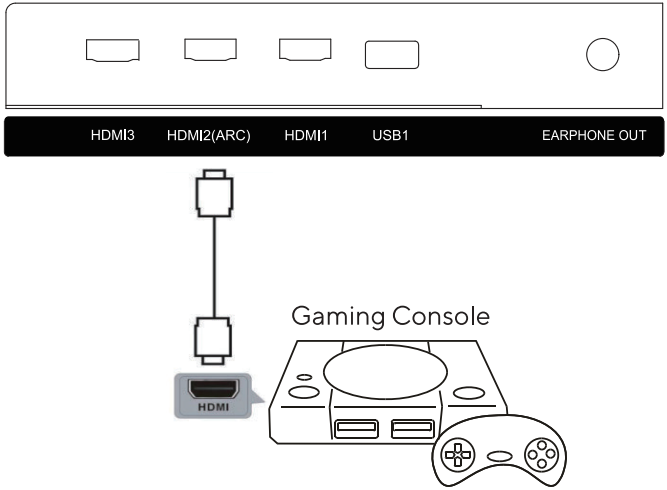

Press the TV remote’s SOURCE button until you reach “HDMI®”. Be sure to select the specific HDMI® source (HDMI® 1/2/3) that matches the input to which the cable is connected.

Connecting a Gaming Console to Your TV

Use an HDMI® cable or AV cable (sold separately) to connect a gaming console to your TV. Be sure to match the cables to the proper inputs.

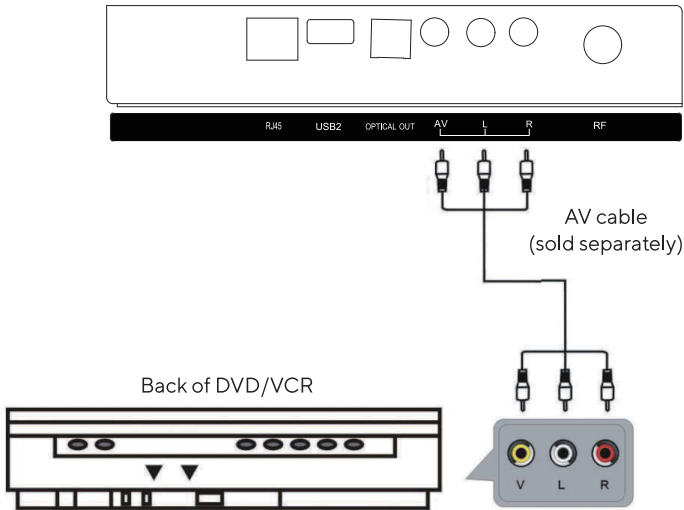

Connecting External Devices

Connecting an External Device to Your TV via AV

Use the composite L/R (white/red) and video (yellow) cables (sold separately) to connect an external device, such as a speaker, to your TV.

Press the SOURCE button on your TV's remote until you reach "AV".

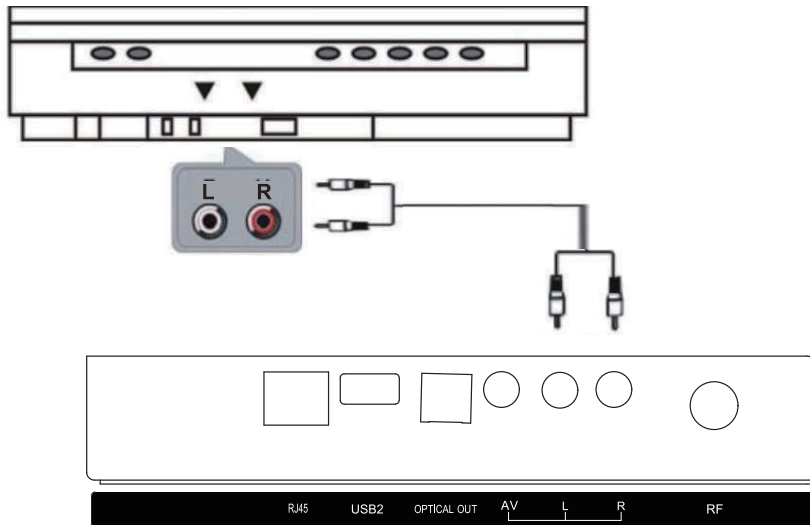

Connecting an External Device to Your TV via an Optical Cable

Use an optical cable (sold separately) to connect a soundbar or amplifier to your TV.

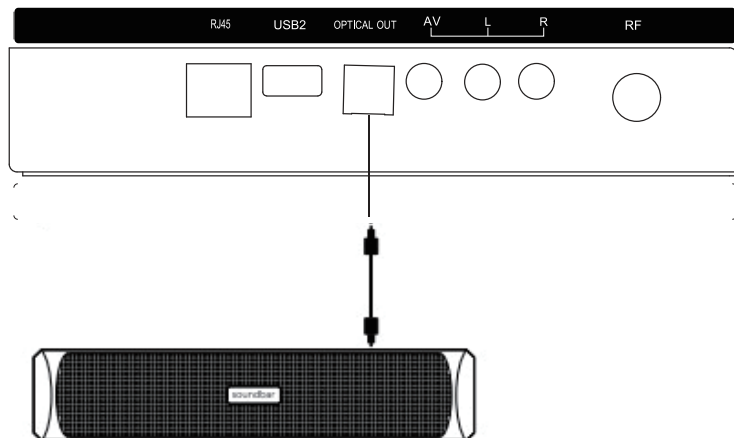

Connecting External Devices

Connecting to a New Wireless Network

Turn on the power of the router connected to the Internet.

Press the  button on the remote control.

Select the  button → General → Network → Wi-Fi® Connection.

When the network search is complete, a list of available networks will display.

Select a network to connect. If your wireless LAN router is password protected, enter the password configured for the router.



Supported Signal Modes

1. HDMI® Mode

Resolution	Horizontal Frequency (kHz)	Vertical Frequency (kHz)
480p	31.468	59.94
576p	31.2	50.00
720p	45.00	60.00
1080i	33.75	60.00
1080p (1920x1080)	67.50	60.00
2160p (3840x2160)	67.50	30.00
2160p (3840x2160)	135.00	60.00

NOTE: When a signal is received by the display and exceeds the allowed range, a warning message will pop up on the screen. You can confirm the signal on the screen.

FCC Requirement

Any changes or modifications not expressly approved by the party responsible for compliance could void the user's authority to operate the equipment. This device complies with Part 15 of the FCC Rules. Operation is subject to the following two conditions:

- (1) this device may not cause harmful interference, and
- (2) this device must accept any interference received, including interference that may cause undesired operation.

Note: This equipment has been tested and found to comply with the limits for a Class B digital device, pursuant to Part 15 of the FCC Rules. These limits are designed to provide reasonable protection against harmful interference in a residential installation. This equipment generates, uses, and can radiate radio frequency energy, and if not installed and used in accordance with the instructions, may cause harmful interference to radio communications. However, there is no guarantee that interference will not occur in a particular installation. If this equipment does cause harmful interference to radio or television reception, which can be determined by turning the equipment off and on, the user is encouraged to try to correct the interference by one or more of the following measures:

- Reorient or relocate the receiving antenna.
- Increase the separation between the equipment and receiver.
- Connect the equipment into an outlet on a circuit different from that to which the receiver is connected.
- Consult the dealer or an experienced radio/TV technician for help.

This equipment complies with FCC radiation exposure limits set forth for an uncontrolled environment. This equipment should be installed and operated with minimum distance 20cm between the radiator and your body.

Troubleshooting

Problem	Solution
TV will not power on (the power indicator does not light up)	Make sure that both ends of the power cable are plugged into the socket properly and that the wall socket is functioning. Be sure to point the remote directly at the IR sensor on the bottom right corner of the TV.
“No Input Signal” appears on the screen	<ul style="list-style-type: none">• Check that the signal line is properly connected.• Check that the connected device is powered on.• Check that the SOURCE input has been selected and matches the input signal.
The remote control does not function properly	<ul style="list-style-type: none">• Check that the battery is not drained. Replace with 2 AA batteries.• Check that the remote control is within the operating range.• Check that the remote control is pointed to the remote.• Make sure there aren't any objects obstructing the signal from the remote to the remote control window on the TV.
There are flashing spots or stripes on the screen	Try switching off sources of interference, such as appliances, baby monitors and more.
Image color or quality deteriorates	Check that picture settings (brightness, contrast, color, etc.) are adjusted appropriately.
Screen position and size are incorrect	Check that the screen position and size are adjusted appropriately.
Image or color is incorrect	<ul style="list-style-type: none">• Check that the signal line is connected properly.• When connecting a computer to the TV, you may need to change your computer's resolution to obtain the correct image. The computer's output signal may affect the image displayed.
A warning message appears on screen	Check that the screen position and size are adjusted appropriately.

Specifications

Model No.	ORTV430SM
Screen Size	43" Diagonal
VESA	200x200mm
Aspect Ratio	16:9
Power Supply	AC 100-240V (~50-60Hz)
Power Consumption	≤150W
TV System	NTSC MN, ATV
Audio Output Power	8 Ω 8W x 2
Inputs	Antenna Input x 1 USB Ports x 2 HDMI® Inputs x 3 Audio In x 1 Video In x 1 AV In x 1 RJ45 x 1
Outputs	Earphone Out x 1 Optical Out x 1
Internal Wi-Fi® Antennas	1 x 2.4G antenna 1 x 5G antenna 1 x Bluetooth receiving antenna
Operating Temperature	32°F~113°F
Operating Humidity	20%-80% non-condensing
Waterproof Rating	IP54

For more information, please visit the webOS website:

<https://webos.developer.lge.com/webos-hub>

2404W

Need Help?

For customer support regarding your device, please submit a request by emailing support@dpaudiovideo.zendesk.com. You will be provided a ticket number regarding your inquiry, which you can refer to when contacting us further.

You may also reach an OrcaTV customer service representative by calling **1-833-909-2673**. We are available Monday - Friday, 9am - 5pm PST, except on major holidays. OrcaTV strongly urges customers to email their inquiry prior to calling, as this will enable us to better assist you.

Please make sure to note the model number and a description of your inquiry.

Thank you for purchasing an OrcaTV product.

Warranty Information

Limited Warranty

OrcaTV (the "Company") warrants this new product purchased and contained in this package (the "Product") against defects in material or workmanship for 90 Days (Parts & Labor) and 1 Year (Limited). In order for the Company to honor this limited warranty, you must present a valid proof of purchase (i.e. a receipt) of this Product. IMPORTANT NOTE: The customer is encouraged to carefully inspect the Product upon receipt after purchase - especially prior to any assembly, disassembly, mounting, installation or utilizing a third-party product of any kind, such as a decorative or protective cover or case.

This warranty is void if the Company deems, in its discretion, that the Product may have been damaged when the packaging was opened, through modification, improper transport, improper storage, improper use, improper assembly or disassembly, exposure to adverse elements, mounting or other installation, end user negligence, water damage or tampering of the barcode of the Product. This warranty does not apply: (a) to cosmetic damage, including but not limited to screen damage, a cracked display, scratches, dents and broken ports; (b) to damage caused by accident, abuse, misuse, fire, water vapor exposure, excessive exposure to humidity, water or other liquid contact, earthquake or other external cause; (c) to defects caused by normal wear and tear or otherwise due to the normal aging of the product; (d) if any serial number has been removed or defaced from the product; or (e) to damage caused by installation or mounting, assembly or disassembly, use with a third party device, cable, protective or decorative cover/case, component or product that does not meet the Company's product specifications. This warranty is a limited warranty for repair of the

Warranty Information

Product or replacement of the Product with a new or refurbished product, subject to the conditions set forth herein.

The Company is not liable for consequential, indirect, incidental, special or punitive damages and the Company's total liability hereunder shall not exceed an amount greater than the retail purchase price of the product.

90 Days Parts & Labor

The Company warrants to you as the original retail purchaser of the Product, that should the Product have any warranted defect out of the packaging, under normal conditions, such defect(s) will be repaired or replaced with a new or refurbished part (at the Company's sole discretion) without charge, if the Product is submitted to the Company within a period of ninety (90) calendar days from the date of purchase of the Product. The customer is responsible for transportation cost and insurance charges (if applicable) to the Company and must be able to document a clear proof of delivery to the Company as well as proof of registered receipt by the Company. It is the customer's responsibility to retain original packaging or provide like packaging in order to facilitate the warranty repair or replacement process. The Company will incur no liability whatsoever to provide packaging for warranty items. Should the product be damaged en route to the Company due to insufficient or improper packaging or improper transport, the warranty may be voided. You must receive a return authorization number (RMA#) before sending the unit in for service. This warranty only applies to manufacturer defects, and the Product must be returned to the Company in its original condition.

1 Year Limited Parts

If determined to be covered under warranty, the one (1) year limited parts warranty gives the customer the option to return the Product to the Company for repair or replacement. The customer will be responsible for labor charges. This warranty does not cover any incidental or indirect costs incurred as a result of a defect in the Product, including any consequential, incidental or indirect damages.



OrcaTV intends to make this manual accurate and complete. However, OrcaTV makes no claim that the information contained herein covers all details and conditions. The information in this document is subject to change without notice at any time. OrcaTV assumes no responsibility for accuracy or completeness of the information contained in this manual.