

TEST REPORT

Report No.: BCTC2312786554-1E

Applicant: DP AUDIO VIDEO LLC

Product Name: Professional Wireless Thermal Printer

Test Model: CTP100LG

Tested Date: 2023-12-07 to 2023-12-19

Issued Date: 2023-12-19



Shenzhen BCTC Testing Co., Ltd.



FCC ID:2AVRVCTP100LG

Product Name: Professional Wireless Thermal Printer
Trademark: Core Innovations
Model/Type Reference: CTP100LG
Prepared For: DP AUDIO VIDEO LLC
Address: 1001 Gayley Avenue P.O. Box 24857, Los Angeles, California United States 90024
Manufacturer: GUANGDONG KAIGE TECHNOLOGY CO., LTD
Address: XiuShui Road, Laimei Industrial Park, Fengxiang Street, Chenghai District, Shantou, Guangdong, China
Prepared By: Shenzhen BCTC Testing Co., Ltd.
Address: 1-2/F., Building B, Pengzhou Industrial Park, No.158, Fuyuan 1st Road, Zhancheng, Fuhai Subdistrict, Bao'an District, Shenzhen, Guangdong, China
Sample Received Date: 2023-12-07
Sample Tested Date: 2023-12-07 to 2023-12-19
Issue Date: 2023-12-19
Report No.: BCTC2312786554-1E
Test Standards: FCC Part15.247
ANSI C63.10-2013
Test Results: PASS
Remark: This is Bluetooth Classic radio test report.

Tested by:



Kelsey Tan/ Project Handler

Approved by:



Zero Zhou/Reviewer

The test report is effective only with both signature and specialized stamp. This result(s) shown in this report refer only to the sample(s) tested. Without written approval of Shenzhen BCTC Testing Co., Ltd, this report can't be reproduced except in full. The tested sample(s) and the sample information are provided by the client.



Table Of Content

| | Page |
|---|------|
| Test Report Declaration | |
| 1. Version | 5 |
| 2. Test Summary | 6 |
| 3. Measurement Uncertainty | 7 |
| 4. Product Information And Test Setup | 8 |
| 4.1 Product Information..... | 8 |
| 4.2 Test Setup Configuration | 9 |
| 4.3 Support Equipment | 9 |
| 4.4 Channel List..... | 10 |
| 4.5 Test Mode | 10 |
| 4.6 Table Of Parameters Of Text Software Setting..... | 10 |
| 5. Test Facility And Test Instrument Used..... | 11 |
| 5.1 Test Facility..... | 11 |
| 5.2 Test Instrument Used..... | 11 |
| 6. Conducted Emissions..... | 13 |
| 6.1 Block Diagram Of Test Setup..... | 13 |
| 6.2 Limit | 13 |
| 6.3 Test procedure..... | 13 |
| 6.4 EUT operating Conditions | 13 |
| 6.5 Test Result..... | 14 |
| 7. Radiated emissions | 16 |
| 7.1 Block Diagram Of Test Setup..... | 16 |
| 7.2 Limit | 17 |
| 7.3 Test procedure..... | 18 |
| 7.4 EUT operating Conditions | 19 |
| 7.5 Test Result..... | 19 |
| 8. Radiated Band Emission Measurement And Restricted Bands Of Operation | 25 |
| 8.1 Block Diagram Of Test Setup..... | 25 |
| 8.2 Limit | 25 |
| 8.3 Test procedure..... | 26 |
| 8.4 EUT operating Conditions | 26 |
| 8.5 Test Result..... | 27 |
| 9. Spurious RF Conducted Emissions..... | 28 |
| 9.1 Block Diagram Of Test Setup..... | 28 |
| 9.2 Limit | 28 |
| 9.3 Test procedure..... | 28 |
| 9.4 Test Result..... | 29 |
| 10. 20 dB Bandwidth | 50 |
| 10.1 Block Diagram Of Test Setup..... | 50 |
| 10.2 Limit | 50 |
| 10.3 Test procedure..... | 50 |
| 10.4 Test Result..... | 50 |
| 11. Maximum Peak Output Power..... | 56 |
| 11.1 Block Diagram Of Test Setup..... | 56 |
| 11.2 Limit | 56 |
| 11.3 Test procedure..... | 56 |
| 11.4 Test Result..... | 56 |

BCTC
 BCTC
 PPR
 Report

| | |
|---------------------------------------|----|
| 12. Hopping Channel Separation | 62 |
| 12.1 Block Diagram Of Test Setup..... | 62 |
| 12.2 Limit | 62 |
| 12.3 Test procedure..... | 62 |
| 12.4 Test Result..... | 62 |
| 13. Number Of Hopping Frequency..... | 68 |
| 13.1 Block Diagram Of Test Setup..... | 68 |
| 13.2 Limit | 68 |
| 13.3 Test procedure..... | 68 |
| 13.4 Test Result..... | 68 |
| 14. Dwell Time..... | 71 |
| 14.1 Block Diagram Of Test Setup..... | 71 |
| 14.2 Limit | 71 |
| 14.3 Test procedure..... | 71 |
| 14.4 Test Result..... | 71 |
| 15. Antenna Requirement | 81 |
| 15.1 Limit | 81 |
| 15.2 Test Result..... | 81 |
| 16. EUT Photographs..... | 82 |
| 17. EUT Test Setup Photographs..... | 83 |

(Note: N/A Means Not Applicable)

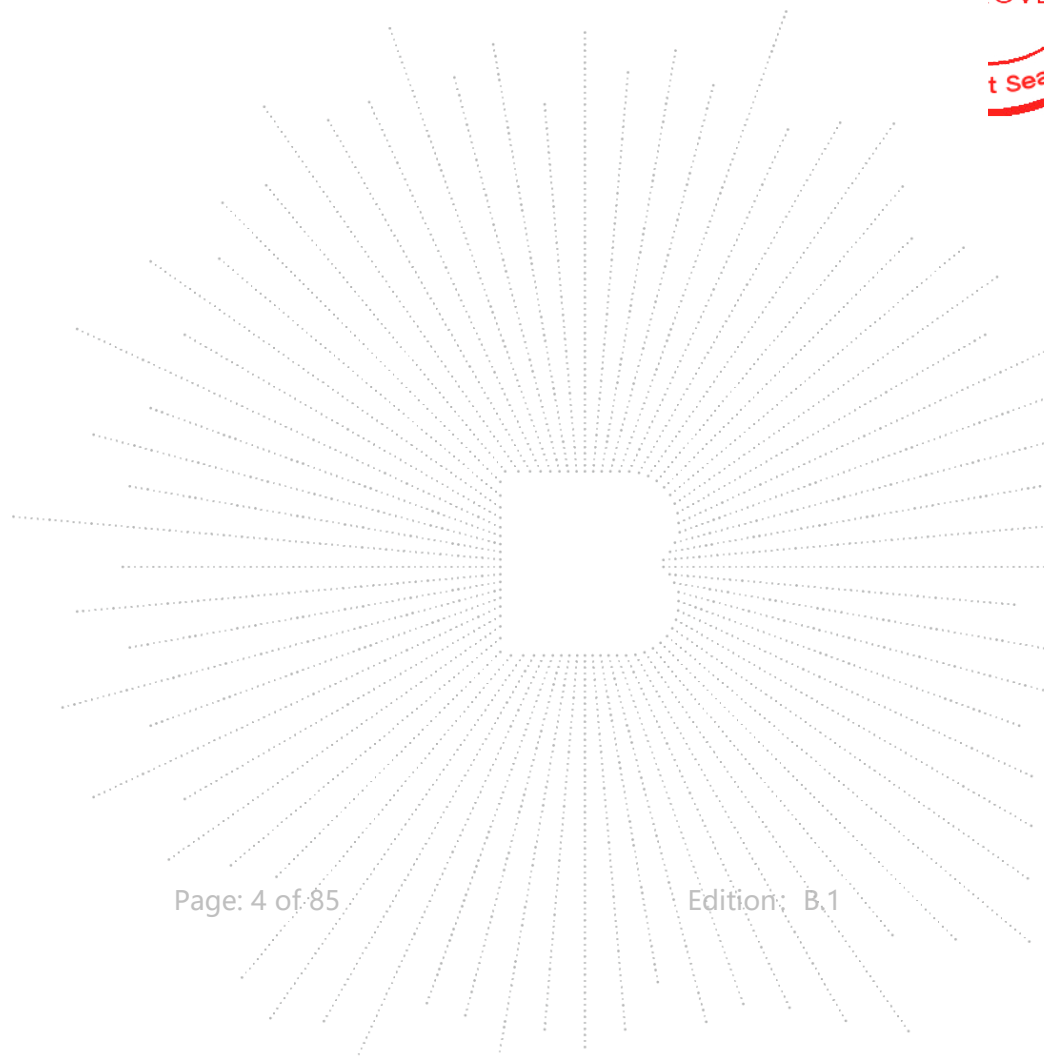

1. Version

| Report No. | Issue Date | Description | Approved |
|-------------------|------------|-------------|----------|
| BCTC2312786554-1E | 2023-12-19 | Original | Valid |
| | | | |

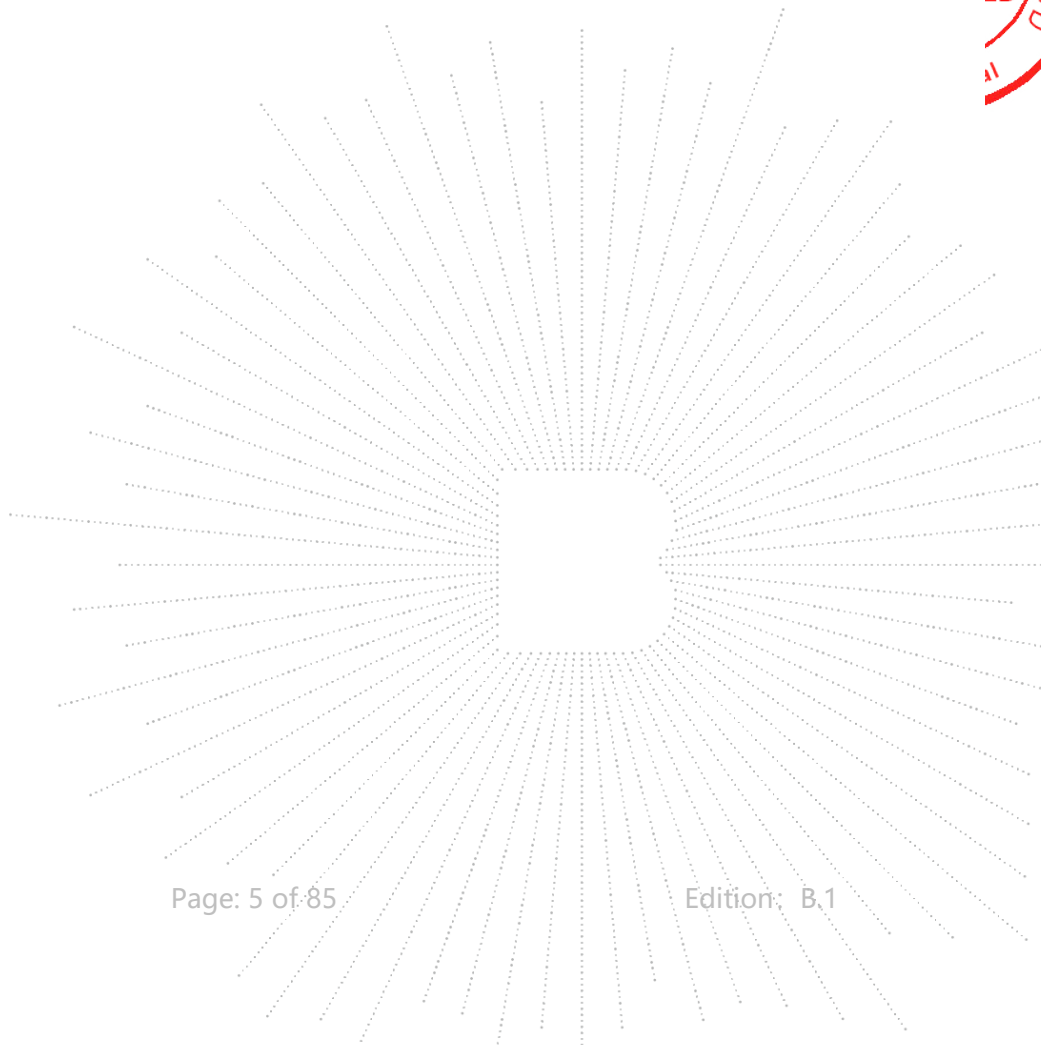

2. Test Summary

The Product has been tested according to the following specifications:

| No. | Test Parameter | Clause No | Results |
|-----|---|--------------------------------|---------|
| 1 | Conducted emission AC power port | §15.207 | PASS |
| 2 | Conducted peak output power for FHSS | §15.247(b)(1) | PASS |
| 3 | 20dB Occupied bandwidth | §15.247(a)(1) | PASS |
| 4 | Hopping channel separation | §15.247(a)(1) | PASS |
| 5 | Number of hopping frequencies | §15.247(a)(1)(iii) | PASS |
| 6 | Dwell Time | §15.247(a)(1)(iii) | PASS |
| 7 | Spurious RF conducted emissions | §15.247(d) | PASS |
| 8 | Band edge | §15.247(d) | PASS |
| 9 | Spurious radiated emissions for transmitter | §15.247(d) & §15.209 & §15.205 | PASS |
| 10 | Antenna Requirement | 15.203 | PASS |

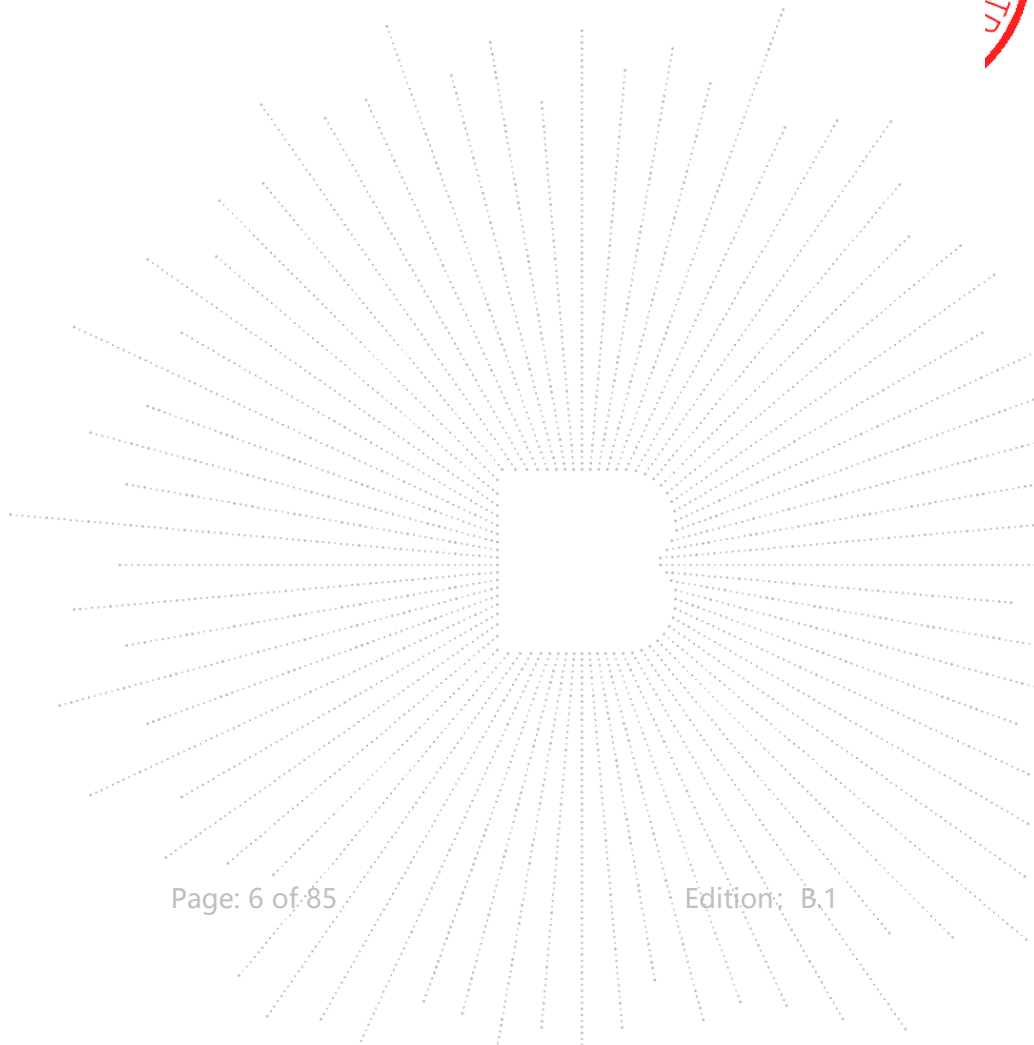
3. Measurement Uncertainty

Where relevant, the following measurement uncertainty levels have been estimated for tests performed on the Product as specified in CISPR 16-4-2. This uncertainty represents an expanded uncertainty expressed at approximately the 95% confidence level using a coverage factor of k=2.

| No. | Item | Uncertainty |
|-----|--|-------------|
| 1 | 3m chamber Radiated spurious emission(30MHz-1GHz) | U=4.3dB |
| 2 | 3m chamber Radiated spurious emission(9KHz-30MHz) | U=3.7dB |
| 3 | 3m chamber Radiated spurious emission(1GHz-18GHz) | U=4.5dB |
| 4 | 3m chamber Radiated spurious emission(18GHz-40GHz) | U=3.34dB |
| 5 | Conducted Emission (150kHz-30MHz) | U=3.20dB |
| 6 | Conducted Adjacent channel power | U=1.38dB |
| 7 | Conducted output power uncertainty Above 1G | U=1.576dB |
| 8 | Conducted output power uncertainty below 1G | U=1.28dB |
| 9 | humidity uncertainty | U=5.3% |
| 10 | Temperature uncertainty | U=0.59°C |



4. Product Information And Test Setup

4.1 Product Information

| | |
|-----------------------|--|
| Model/Type Reference: | CTP100LG |
| Model Differences: | N/A |
| Hardware Version: | N/A |
| Software Version: | N/A |
| Operation Frequency: | 2402-2480MHz |
| Type of Modulation: | GFSK, $\pi/4$ DQPSK, 8DPSK |
| Number Of Channel: | 79CH |
| Antenna installation: | Internal antenna |
| Antenna Gain: | -4.73 dBi |
| Ratings: | DC 7.4V from battery, DC 5V from USB |
| Remark: | The antenna gain of the product comes from the antenna report provided by the customer, and the test data is affected by the customer information. |



4.2 Test Setup Configuration

See test photographs attached in *EUT TEST SETUP PHOTOGRAPHS* for the actual connections between Product and support equipment.

Conducted Emission and Radiated Spurious Emission:

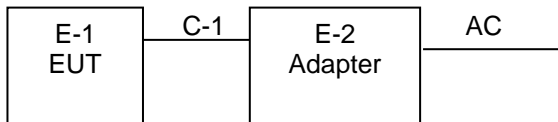

4.3 Support Equipment

| No. | Device Type | Brand | Model | Series No. | Note |
|-----|------------------|------------------|----------|------------|-----------|
| E-1 | Wireless Printer | Core Innovations | CTP100LG | N/A | EUT |
| E-2 | ADAPTER | N/A | CD226 | N/A | Auxiliary |

| Item | Shielded Type | Ferrite Core | Length | Note |
|------|---------------|--------------|--------|---------------------|
| C-1 | N/A | N/A | 0.3M | DC cable unshielded |

Notes:

1. All the equipment/cables were placed in the worst-case configuration to maximize the emission during the test.
2. Grounding was established in accordance with the manufacturer's requirements and conditions for the intended use.

4.4 Channel List

| CH | Frequency (MHz) | CH | Frequency (MHz) | CH | Frequency (MHz) | CH | Frequency (MHz) |
|----|-----------------|----|-----------------|----|-----------------|----|-----------------|
| 0 | 2402 | 1 | 2403 | 2 | 2404 | 3 | 2405 |
| 4 | 2406 | 5 | 2407 | 6 | 2408 | 7 | 2409 |
| 8 | 2410 | 9 | 2411 | 10 | 2412 | 11 | 2413 |
| 12 | 2414 | 13 | 2415 | 14 | 2416 | 15 | 2417 |
| 16 | 2418 | 17 | 2419 | 18 | 2420 | 19 | 2421 |
| 20 | 2422 | 21 | 2423 | 22 | 2424 | 23 | 2425 |
| 24 | 2426 | 25 | 2427 | 26 | 2428 | 27 | 2429 |
| 28 | 2430 | 29 | 2431 | 30 | 2432 | 31 | 2433 |
| 32 | 2434 | 33 | 2435 | 34 | 2436 | 35 | 2437 |
| 36 | 2438 | 37 | 2439 | 38 | 2440 | 39 | 2441 |
| 40 | 2442 | 41 | 2443 | 42 | 2444 | 43 | 2445 |
| 44 | 2446 | 45 | 2447 | 46 | 2448 | 47 | 2449 |
| 48 | 2450 | 49 | 2451 | 50 | 2452 | 51 | 2453 |
| 52 | 2454 | 53 | 2455 | 54 | 2456 | 55 | 2457 |
| 56 | 2458 | 57 | 2459 | 58 | 2460 | 59 | 2461 |
| 60 | 2462 | 61 | 2463 | 62 | 2464 | 63 | 2465 |
| 64 | 2466 | 65 | 2467 | 66 | 2468 | 67 | 2469 |
| 68 | 2470 | 69 | 2471 | 70 | 2472 | 71 | 2473 |
| 72 | 2474 | 73 | 2475 | 74 | 2476 | 75 | 2477 |
| 76 | 2478 | 77 | 2479 | 78 | 2480 | 79 | / |

4.5 Test Mode

To investigate the maximum EMI emission characteristics generated from EUT, the test system was pre-scanning tested based on the consideration of following EUT operation mode or test configuration mode which possibly have effect on EMI emission level. Each of these EUT operation mode(s) or test configuration mode(s) mentioned above was evaluated respectively.

| Test Mode | Test mode | Low channel | Middle channel | High channel |
|-----------|---|-------------|----------------|--------------|
| 1 | Transmitting(GFSK) | 2402MHz | 2441MHz | 2480MHz |
| 2 | Transmitting($\pi/4$ DQPSK) | 2402MHz | 2441MHz | 2480MHz |
| 3 | Transmitting(8DPSK) | 2402MHz | 2441MHz | 2480MHz |
| 4 | Transmitting (Conducted emission & Radiated emission) | | | |

Note:

- (1) The measurements are performed at the highest, middle, lowest available channels.
- (2) Fully-charged battery is used during the test.

4.6 Table Of Parameters Of Text Software Setting

During testing channel & power controlling software provided by the customer was used to control the operating channel as well as the output power level. The RF output power selection is for the setting of RF output power expected by the customer and is going to be fixed on the firmware of the final end product power parameters

| Test software Version | SecureCRT | | |
|-----------------------|-----------|----------|----------|
| Frequency | 2402 MHz | 2441 MHz | 2480 MHz |
| Parameters | DEF | DEF | DEF |

5. Test Facility And Test Instrument Used

5.1 Test Facility

All measurement facilities used to collect the measurement data are located at Shenzhen BCTC Testing Co., Ltd. Address:1-2/F., Building B, Pengzhou Industrial Park, No.158, Fuyuan 1st Road, Zhancheng, Fuhai Subdistrict, Bao'an District, Shenzhen, Guangdong, China. The site and apparatus are constructed in conformance with the requirements of ANSI C63.4 and CISPR 16-1-1 other equivalent standards.

FCC Test Firm Registration Number: 712850

FCC Designation Number: CN1212

ISED Registered No.: 23583

ISED CAB identifier: CN0017

5.2 Test Instrument Used

| Conducted Emissions Test | | | | | |
|--------------------------|--------------|------------|----------------|----------------|----------------|
| Equipment | Manufacturer | Model# | Serial# | Last Cal. | Next Cal. |
| Receiver | R&S | ESR3 | 102075 | May 15, 2023 | May 14, 2024 |
| LISN | R&S | ENV216 | 101375 | May 15, 2023 | May 14, 2024 |
| Software | Frad | EZ-EMC | EMC-CON 3A1 | \ | \ |
| Pulse limiter | Schwarzbeck | VTSD9561-F | 01323 | Sept. 22, 2023 | Sept. 21, 2024 |

| RF Conducted Test | | | | | |
|------------------------------|--------------|----------------|------------|--------------|--------------|
| Equipment | Manufacturer | Model# | Serial# | Last Cal. | Next Cal. |
| Power Metter | Keysight | E4419 | \ | May 15, 2023 | May 14, 2024 |
| Power Sensor (AV) | Keysight | E9300A | \ | May 15, 2023 | May 14, 2024 |
| Signal Analyzer20kHz-26.5GHz | Keysight | N9020A | MY49100060 | May 15, 2023 | May 14, 2024 |
| Spectrum Analyzer9kHz-40GHz | R&S | FSP40 | 100363 | May 15, 2023 | May 14, 2024 |
| Radio frequency control box | MAIWEI | MW100-RFC B | \ | \ | \ |
| Software | MAIWEI | MTS 8310 | \ | \ | \ |

| Radiated Emissions Test (966 Chamber01) | | | | | |
|---|--------------|-------------------|--------------|--------------|--------------|
| Equipment | Manufacturer | Model# | Serial# | Last Cal. | Next Cal. |
| 966 chamber | ChengYu | 966 Room | 966 | May 15, 2023 | May 14, 2026 |
| Receiver | R&S | ESR3 | 102075 | May 15, 2023 | May 14, 2024 |
| Receiver | R&S | ESRP | 101154 | May 15, 2023 | May 14, 2024 |
| Amplifier | Schwarzbeck | BBV9744 | 9744-0037 | May 15, 2023 | May 14, 2024 |
| TRILOG Broadband Antenna | Schwarzbeck | VULB9163 | 942 | May 29, 2023 | May 28, 2024 |
| Loop Antenna(9KHz -30MHz) | Schwarzbeck | FMZB1519B | 00014 | May 31, 2023 | May 30, 2024 |
| Amplifier | SKET | LAPA_01G18 G-45dB | SK2021040901 | May 15, 2023 | May 14, 2024 |
| Horn Antenna | Schwarzbeck | BBHA9120D | 1541 | May 31, 2023 | May 30, 2024 |
| Amplifier(18G Hz-40GHz) | MITEQ | TTA1840-35-HG | 2034381 | May 15, 2023 | May 14, 2024 |
| Horn Antenn(18GHz-40GHz) | Schwarzbeck | BBHA9170 | 00822 | May 31, 2023 | May 30, 2024 |
| Spectrum Analyzer9kHz-40GHz | R&S | FSP40 | 100363 | May 15, 2023 | May 14, 2024 |
| Software | Frad | EZ-EMC | FA-03A2 RE | \ | \ |

CO., LTD

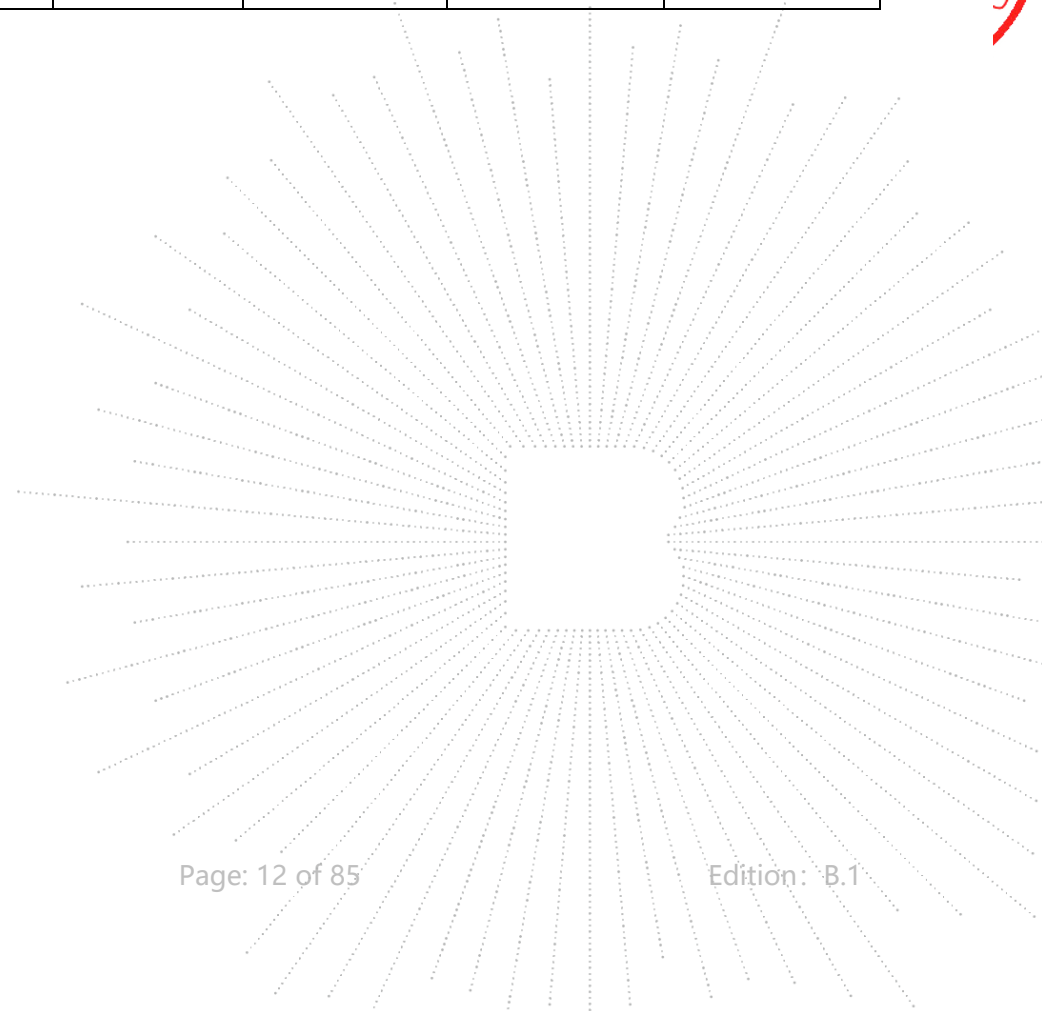

6. Conducted Emissions

6.1 Block Diagram Of Test Setup

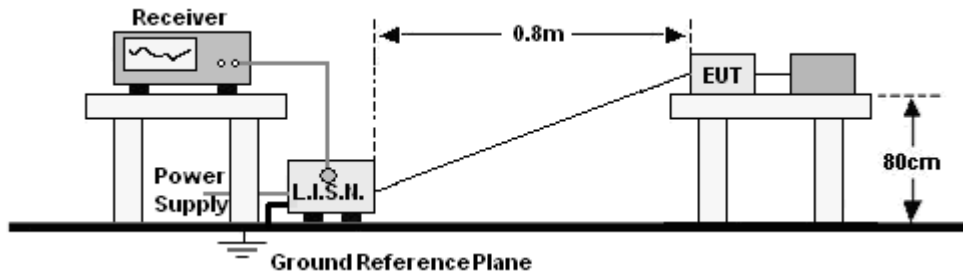

6.2 Limit

| Frequency (MHz) | Limit (dBuV) | |
|-----------------|--------------|-----------|
| | Quas-peak | Average |
| 0.15 -0.5 | 66 - 56 * | 56 - 46 * |
| 0.50 -5.0 | 56.00 | 46.00 |
| 5.0 -30.0 | 60.00 | 50.00 |

Notes:
 1. *Decreasing linearly with logarithm of frequency.
 2. The lower limit shall apply at the transition frequencies.

6.3 Test procedure

| Receiver Parameters | Setting |
|---------------------|----------|
| Attenuation | 10 dB |
| Start Frequency | 0.15 MHz |
| Stop Frequency | 30 MHz |
| IF Bandwidth | 9 kHz |

- The Product was placed on a nonconductive table 0.8 m above the horizontal ground reference plane, and 0.4 m from the vertical ground reference plane, and connected to the main through Line Impedance Stability Network (L.I.S.N).
- The RBW of the receiver was set at 9 kHz in 150 kHz ~ 30MHz with Peak and AVG detector in Max Hold mode. Run the receiver's pre-scan to record the maximum disturbance generated from Product in all power lines in the full band.
- For each frequency whose maximum record was higher or close to limit, measure its QP and AVG values and record.

6.4 EUT operating Conditions

The EUT was configured for testing in a typical fashion (as a customer would normally use it). The EUT has been programmed to continuously transmit during test. This operating condition was tested and used to collect the included data.

6.5 Test Result

| | | | |
|--------------|--------|--------------------|--------------|
| Temperature: | 26 °C | Relative Humidity: | 54% |
| Pressure: | 101KPa | Phase : | L |
| Test Mode: | Mode 4 | Test Voltage : | AC 120V/60Hz |

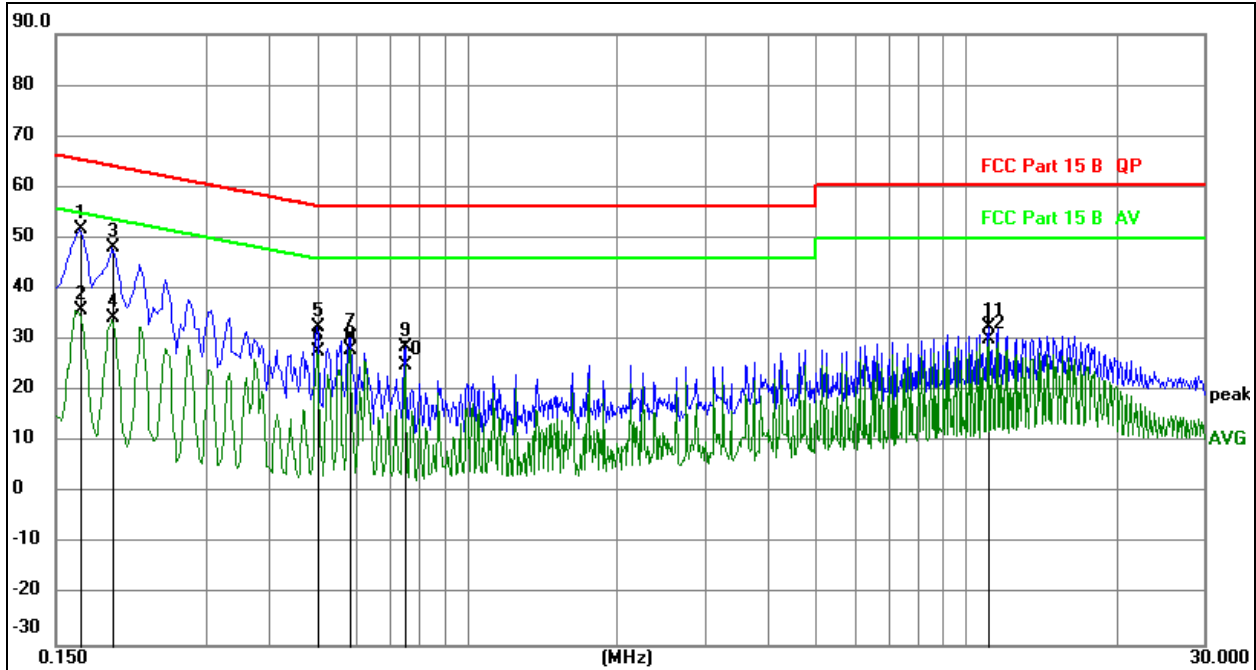

Remark:

1. All readings are Quasi-Peak and Average values.
2. Factor = Insertion Loss + Cable Loss.
3. Measurement = Reading Level + Correct Factor
4. Over = Measurement - Limit

| No. | Mk. | Freq. | Reading Level | Correct Factor | Measurement | Limit | Over | Detector |
|-----|-----|---------|---------------|----------------|-------------|-------|--------|----------|
| | | MHz | | dB | dBuV | dBuV | dB | |
| 1 | * | 0.1677 | 32.12 | 19.77 | 51.89 | 65.07 | -13.18 | QP |
| 2 | | 0.1677 | 16.05 | 19.77 | 35.82 | 55.07 | -19.25 | AVG |
| 3 | | 0.1945 | 28.36 | 19.82 | 48.18 | 63.84 | -15.66 | QP |
| 4 | | 0.1945 | 14.38 | 19.82 | 34.20 | 53.84 | -19.64 | AVG |
| 5 | | 0.4994 | 12.73 | 19.84 | 32.57 | 56.01 | -23.44 | QP |
| 6 | | 0.4994 | 8.05 | 19.84 | 27.89 | 46.01 | -18.12 | AVG |
| 7 | | 0.5854 | 10.48 | 19.84 | 30.32 | 56.00 | -25.68 | QP |
| 8 | | 0.5854 | 8.26 | 19.84 | 28.10 | 46.00 | -17.90 | AVG |
| 9 | | 0.7508 | 8.77 | 19.86 | 28.63 | 56.00 | -27.37 | QP |
| 10 | | 0.7508 | 5.26 | 19.86 | 25.12 | 46.00 | -20.88 | AVG |
| 11 | | 11.1385 | 12.58 | 19.88 | 32.46 | 60.00 | -27.54 | QP |
| 12 | | 11.1385 | 10.28 | 19.88 | 30.16 | 50.00 | -19.84 | AVG |

| | | | |
|--------------|--------|--------------------|--------------|
| Temperature: | 26 °C | Relative Humidity: | 54% |
| Pressure: | 101KPa | Phase : | N |
| Test Mode: | Mode 4 | Test Voltage : | AC 120V/60Hz |

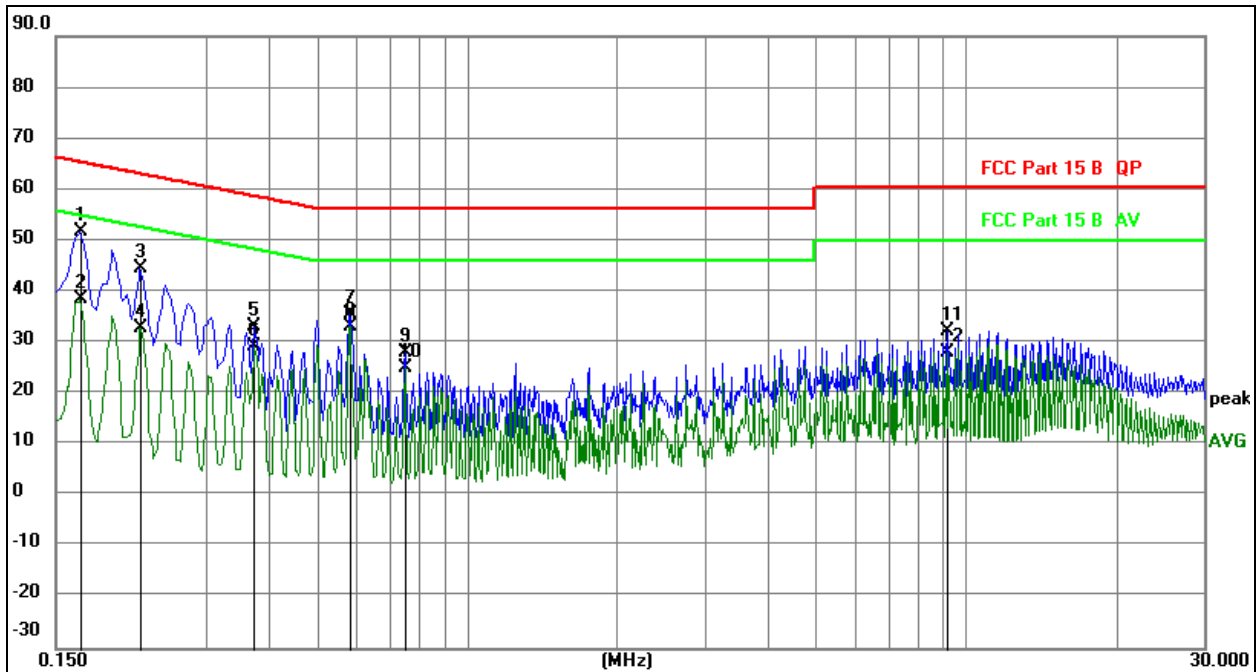
Remark:

1. All readings are Quasi-Peak and Average values.
2. Factor = Insertion Loss + Cable Loss.
3. Measurement = Reading Level + Correct Factor
4. Over = Measurement - Limit

| No. | Mk. | Freq. MHz | Reading Level | Correct Factor dB | Measure- ment dBuV | Limit dBuV | Over dB | Detector |
|-----|-----|--------------|------------------|-------------------------|--------------------------|---------------|------------|----------|
| 1 | | 0.1680 | 31.99 | 19.77 | 51.76 | 65.06 | -13.30 | QP |
| 2 | | 0.1680 | 18.92 | 19.77 | 38.69 | 55.06 | -16.37 | AVG |
| 3 | | 0.2220 | 24.62 | 19.83 | 44.45 | 62.74 | -18.29 | QP |
| 4 | | 0.2220 | 13.01 | 19.83 | 32.84 | 52.74 | -19.90 | AVG |
| 5 | | 0.3750 | 13.20 | 19.84 | 33.04 | 58.39 | -25.35 | QP |
| 6 | | 0.3750 | 9.29 | 19.84 | 29.13 | 48.39 | -19.26 | AVG |
| 7 | | 0.5820 | 15.71 | 19.84 | 35.55 | 56.00 | -20.45 | QP |
| 8 | * | 0.5820 | 13.28 | 19.84 | 33.12 | 46.00 | -12.88 | AVG |
| 9 | | 0.7530 | 8.11 | 19.86 | 27.97 | 56.00 | -28.03 | QP |
| 10 | | 0.7530 | 5.17 | 19.86 | 25.03 | 46.00 | -20.97 | AVG |
| 11 | | 9.1635 | 12.21 | 19.90 | 32.11 | 60.00 | -27.89 | QP |
| 12 | | 9.1635 | 8.23 | 19.90 | 28.13 | 50.00 | -21.87 | AVG |

7. Radiated emissions

7.1 Block Diagram Of Test Setup

(A) Radiated Emission Test-Up Frequency Below 30MHz



(B) Radiated Emission Test-Up Frequency 30MHz~1GHz

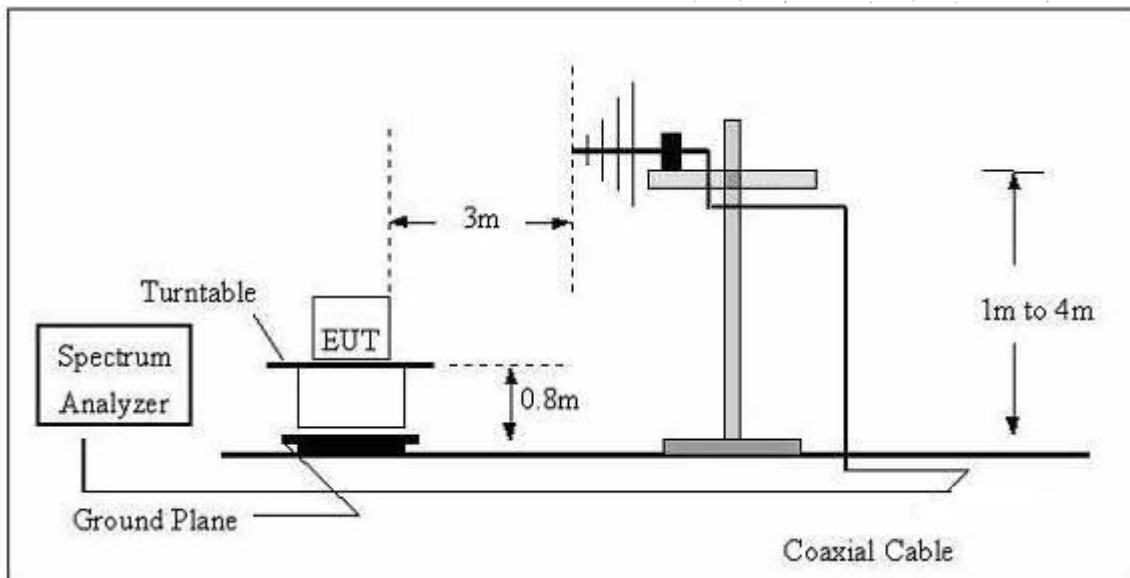

(C) Radiated Emission Test-Up Frequency Above 1GHz

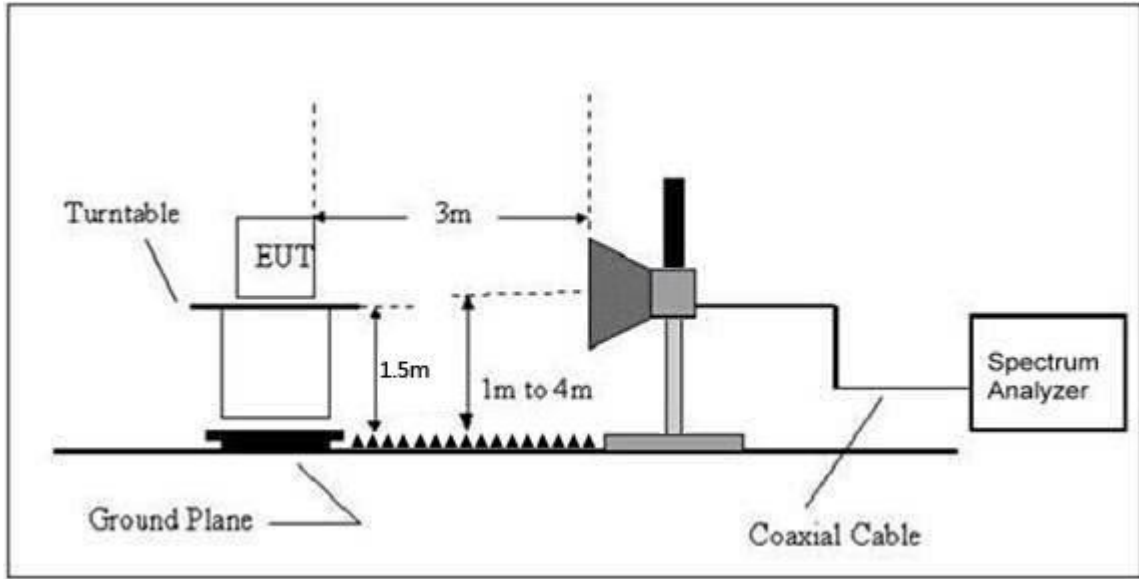
7.2 Limit

20dBc in any 100 kHz bandwidth outside the operating frequency band. In case the emission fall within the restricted band specified on 15.205(a), then the 15.209(a) limit in the table below has to be followed.

| Frequency (MHz) | Field Strength uV/m | Distance (m) | Field Strength Limit at 3m Distance | |
|-----------------|---------------------|--------------|-------------------------------------|---------------------------------------|
| | | | uV/m | dBuV/m |
| 0.009 ~ 0.490 | 2400/F(kHz) | 300 | $10000 * 2400/F(\text{kHz})$ | $20\log^{(2400/F(\text{kHz}))} + 80$ |
| 0.490 ~ 1.705 | 24000/F(kHz) | 30 | $100 * 24000/F(\text{kHz})$ | $20\log^{(24000/F(\text{kHz}))} + 40$ |
| 1.705 ~ 30 | 30 | 30 | $100 * 30$ | $20\log^{(30)} + 40$ |
| 30 ~ 88 | 100 | 3 | 100 | $20\log^{(100)}$ |
| 88 ~ 216 | 150 | 3 | 150 | $20\log^{(150)}$ |
| 216 ~ 960 | 200 | 3 | 200 | $20\log^{(200)}$ |
| Above 960 | 500 | 3 | 500 | $20\log^{(500)}$ |

Limits Of Radiated Emission Measurement (Above 1000MHz)

| Frequency (MHz) | Limit (dBuV/m) (at 3M) | |
|-----------------|------------------------|---------|
| | Peak | Average |
| Above 1000 | 74 | 54 |

Notes:

- (1) The limit for radiated test was performed according to FCC PART 15C.
- (2) The tighter limit applies at the band edges.
- (3) Emission level (dBuV/m) = $20\log$ Emission level (uV/m).

Frequency Range Of Radiated Measurement

(a) For an intentional radiator the spectrum shall be investigated from the lowest radio frequency signal generated in the device, without going below 9 kHz, up to at least the frequency shown in this paragraph:

- (1) If the intentional radiator operates below 10 GHz: to the tenth harmonic of the highest fundamental frequency or to 40 GHz, whichever is lower.
- (2) If the intentional radiator operates at or above 10 GHz and below 30 GHz: to the fifth harmonic of the highest fundamental frequency or to 100 GHz, whichever is lower.
- (3) If the intentional radiator operates at or above 30 GHz: to the fifth harmonic of the highest fundamental frequency or to 200 GHz, whichever is lower, unless specified otherwise elsewhere in the rules.
- (4) If the intentional radiator operates at or above 95 GHz: To the third harmonic of the highest fundamental frequency or to 750 GHz, whichever is lower, unless specified otherwise elsewhere in the rules.
- (5) If the intentional radiator contains a digital device, regardless of whether this digital device controls the functions of the intentional radiator or the digital device is used for additional control or function purposes other than to enable the operation of the intentional radiator, the frequency range shall be investigated up to the range specified in paragraphs (a) (1)through (4) of this section or the range applicable to the digital device, as shown in paragraph (b)(1) of this section, whichever is the higher frequency range of investigation.

7.3 Test procedure

| Receiver Parameter | Setting |
|--------------------|-------------------|
| Attenuation | Auto |
| 9kHz~150kHz | RBW 200Hz for QP |
| 150kHz~30MHz | RBW 9kHz for QP |
| 30MHz~1000MHz | RBW 120kHz for QP |

| Spectrum Parameter | Setting |
|--------------------|--|
| 1-25GHz | RBW 1 MHz /VBW 1 MHz for Peak, RBW 1 MHz / VBW 10Hz for Average |

Below 1GHz test procedure as below:

- a. The EUT was placed on the top of a rotating table 0.8 meters above the ground at a 3 meter semi-anechoic chamber. The table was rotated 360 degrees to determine the position of the highest radiation.
- b. The EUT was set 3 meters away from the interference-receiving antenna, which was mounted on the top of a variable-height antenna tower.
- c. The antenna height is varied from one meter to four meters above the ground to determine the maximum value of the field strength. Both horizontal and vertical polarizations of the antenna are set to make the measurement.
- d. For each suspected emission, the EUT was arranged to its worst case and then the antenna was tuned to heights from 1 meter to 4 meters (for the test frequency of below 30MHz, the antenna was tuned to heights 1 meter) and the rotatable table was turned from 0 degrees to 360 degrees to find the maximum reading.
- e. The test-receiver system was set to Peak Detect Function and Specified Bandwidth with Maximum Hold Mode.
- f. If the emission level of the EUT in peak mode was 10dB lower than the limit specified, then testing could be stopped and the peak values of the EUT would be reported. Otherwise the emissions that did not have 10dB margin would be re-tested one by one using peak, quasi-peak or average method as specified and then reported in a data sheet.

Above 1GHz test procedure as below:

- a. The EUT was placed on the top of a rotating table 1.5 meters above the ground at a 3 meter camber. The table was rotated 360 degrees to determine the position of the highest radiation.
- b. The EUT was set 3 meters away from the interference-receiving antenna, which was mounted on the top of a variable-height antenna tower.
- c. The antenna height is varied from one meter to four meters above the ground to determine the maximum value of the field strength. Both horizontal and vertical polarizations of the antenna are set to make the measurement.
- d. For each suspected emission, the EUT was arranged to its worst case and then the antenna was tuned to heights from 1 meter to 4 meters and the rota table was turned from 0 degrees to 360 degrees to find the maximum reading.
- e. The test-receiver system was set to Peak Detect Function and Specified Bandwidth with Maximum Hold Mode.
- f. If the emission level of the EUT in peak mode was 10dB lower than the limit specified, then testing could be stopped and the peak values of the EUT would be reported. Otherwise the emissions that did not have 10dB margin would be re-tested one by one using peak, quasi-peak or average method as specified and then reported in a data sheet.
- g. Test the EUT in the lowest channel, the middlest channel, the Highest channel.

Note:

Both horizontal and vertical antenna polarities were tested and performed pretest to three orthogonal axis. The worst case emissions were reported.

7.4 EUT operating Conditions

The EUT was configured for testing in a typical fashion (as a customer would normally use it). The EUT has been programmed to continuously transmit during test. This operating condition was tested and used to collect the included data.

7.5 Test Result

Below 30MHz

| | | | |
|--------------|--------|--------------------|--------------|
| Temperature: | 26 °C | Relative Humidity: | 54% |
| Pressure: | 101KPa | Test Voltage : | AC 120V/60Hz |
| Test Mode: | Mode 4 | | |

| Freq. | Reading | Limit | Margin | State |
|-------|----------|----------|--------|-------|
| (MHz) | (dBuV/m) | (dBuV/m) | (dB) | P/F |
| -- | -- | -- | -- | PASS |
| -- | -- | -- | -- | PASS |

Note:

The amplitude of spurious emissions which are attenuated by more than 20dB below the permissible value has no need to be reported.

Distance extrapolation factor = $40 \log(\text{specific distance/test distance})(\text{dB})$;

Limit line = specific limits(dBuv) + distance extrapolation factor.



Between 30MHz – 1GHz

| | | | |
|--------------|--------|--------------------|--------------|
| Temperature: | 26 °C | Relative Humidity: | 54% |
| Pressure: | 101KPa | Phase : | Horizontal |
| Test Mode: | Mode 4 | Test Voltage: | AC 120V/60Hz |

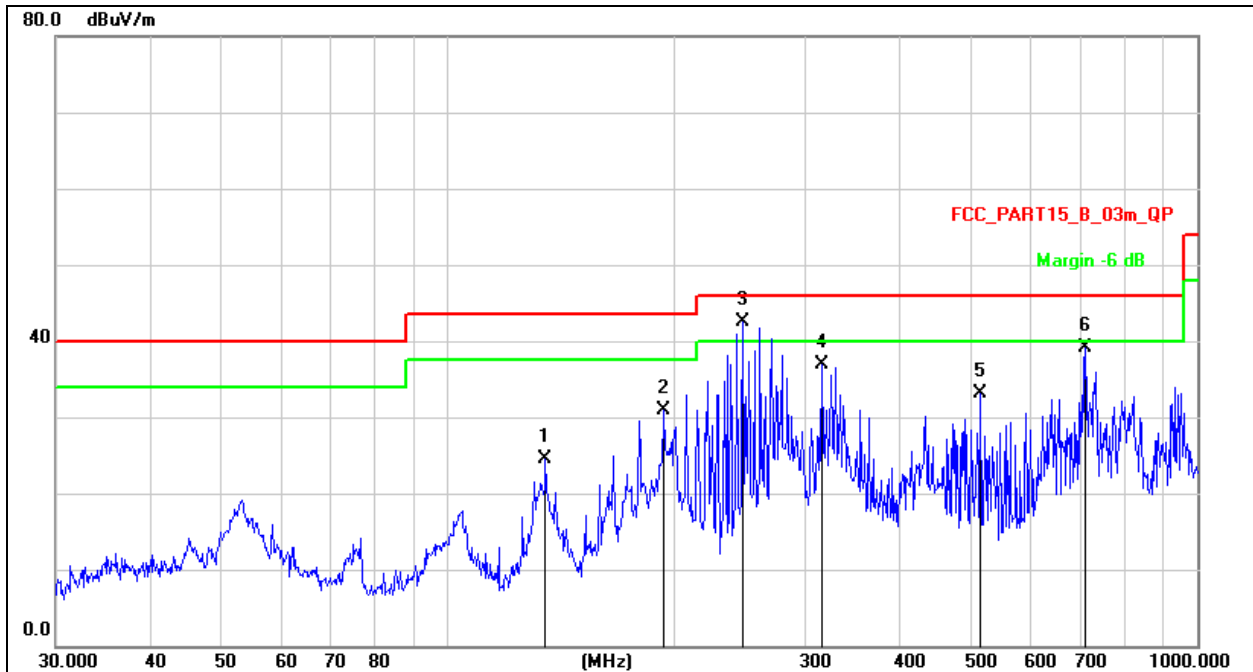
Remark:

1. Factor = Antenna Factor + Cable Loss – Pre-amplifier.
2. Measurement = Reading Level + Correct Factor
3. Over = Measurement - Limit

| No. | Mk. | Freq. | Reading Level | Correct Factor | Measurement | Limit | Over | Detector |
|-----|-----|----------|---------------|----------------|-------------|-------|--------|----------|
| | | MHz | dBuV | dB | dBuV/m | dB/m | dB | |
| 1 | | 135.0319 | 42.92 | -18.38 | 24.54 | 43.50 | -18.96 | QP |
| 2 | | 194.4534 | 47.01 | -16.13 | 30.88 | 43.50 | -12.62 | QP |
| 3 | * | 247.6819 | 56.81 | -14.36 | 42.45 | 46.00 | -3.55 | QP |
| 4 | | 315.4808 | 49.68 | -12.70 | 36.98 | 46.00 | -9.02 | QP |
| 5 | | 513.6331 | 42.20 | -9.09 | 33.11 | 46.00 | -12.89 | QP |
| 6 | | 709.1823 | 44.70 | -5.58 | 39.12 | 46.00 | -6.88 | QP |

| | | | |
|--------------|--------|--------------------|-------------|
| Temperature: | 26 °C | Relative Humidity: | 54% |
| Pressure: | 101KPa | Phase : | Vertical |
| Test Mode: | Mode 4 | Test Voltage : | AC120V/60Hz |

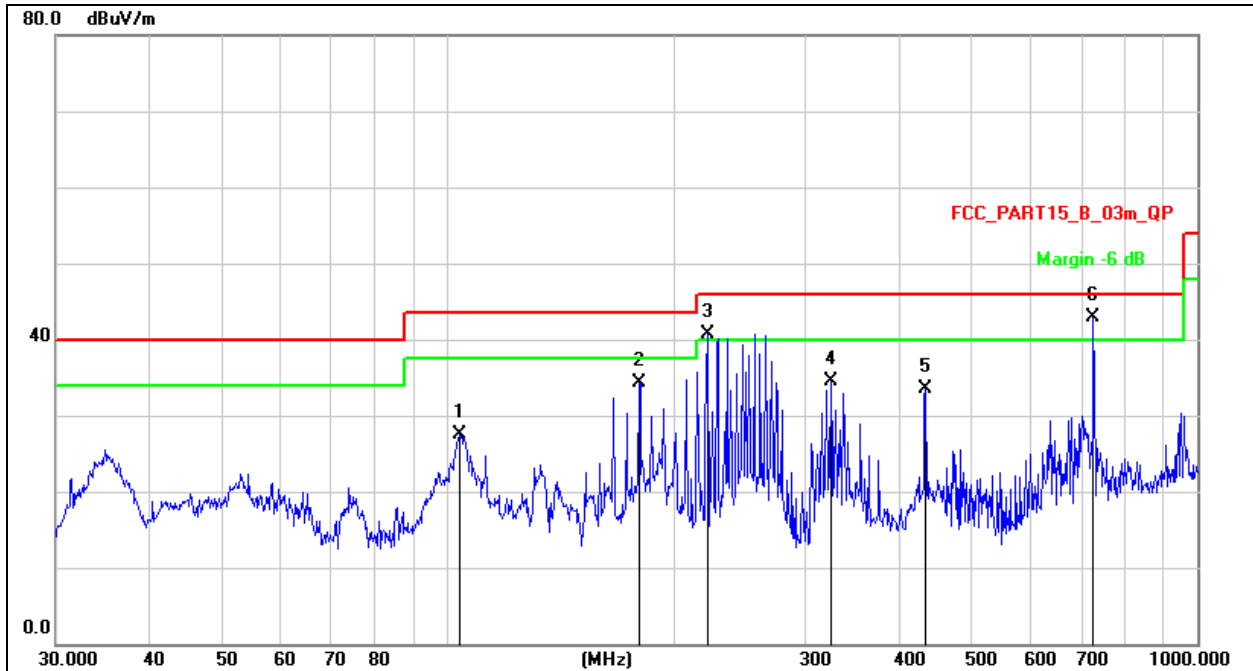
Remark:

1. Factor = Antenna Factor + Cable Loss – Pre-amplifier.
2. Measurement = Reading Level + Correct Factor
3. Over = Measurement - Limit

| No. | Mk. | Freq. MHz | Reading Level dBuV | Correct Factor dB | Measure- ment dBuV/m | Limit dB/m | Over dB | Detector |
|-----|-----|--------------|--------------------------|-------------------------|----------------------------|---------------|------------|----------|
| 1 | | 103.8055 | 43.72 | -16.20 | 27.52 | 43.50 | -15.98 | QP |
| 2 | | 180.0165 | 51.50 | -17.20 | 34.30 | 43.50 | -9.20 | QP |
| 3 | ! | 222.1698 | 55.79 | -15.09 | 40.70 | 46.00 | -5.30 | QP |
| 4 | | 324.4561 | 46.89 | -12.38 | 34.51 | 46.00 | -11.49 | QP |
| 5 | | 434.0651 | 43.73 | -10.17 | 33.56 | 46.00 | -12.44 | QP |
| 6 | * | 726.8052 | 48.21 | -5.32 | 42.89 | 46.00 | -3.11 | QP |

Between 1GHz – 25GHz

| Polar (H/V) | Frequency | Reading Level | Correct Factor | Measurement | Limits | Over | Detector Type |
|----------------------------|-----------|---------------|----------------|-------------|----------|--------|---------------|
| | (MHz) | (dBuV/m) | (dB) | (dBuV/m) | (dBuV/m) | (dB) | |
| GFSK Low channel | | | | | | | |
| V | 4804.00 | 70.89 | -19.99 | 50.90 | 74.00 | -23.10 | PK |
| V | 4804.00 | 60.26 | -19.99 | 40.27 | 54.00 | -13.73 | AV |
| V | 7206.00 | 62.16 | -14.22 | 47.94 | 74.00 | -26.06 | PK |
| V | 7206.00 | 52.81 | -14.22 | 38.59 | 54.00 | -15.41 | AV |
| H | 4804.00 | 67.16 | -19.99 | 47.17 | 74.00 | -26.83 | PK |
| H | 4804.00 | 57.59 | -19.99 | 37.60 | 54.00 | -16.40 | AV |
| H | 7206.00 | 61.02 | -14.22 | 46.80 | 74.00 | -27.20 | PK |
| H | 7206.00 | 53.47 | -14.22 | 39.25 | 54.00 | -14.75 | AV |
| GFSK Middle channel | | | | | | | |
| V | 4882.00 | 68.37 | -19.84 | 48.53 | 74.00 | -25.47 | PK |
| V | 4882.00 | 60.17 | -19.84 | 40.33 | 54.00 | -13.67 | AV |
| V | 7323.00 | 57.42 | -13.90 | 43.52 | 74.00 | -30.48 | PK |
| V | 7323.00 | 48.94 | -13.90 | 35.04 | 54.00 | -18.96 | AV |
| H | 4882.00 | 63.45 | -19.84 | 43.61 | 74.00 | -30.39 | PK |
| H | 4882.00 | 54.40 | -19.84 | 34.56 | 54.00 | -19.44 | AV |
| H | 7323.00 | 56.01 | -13.90 | 42.11 | 74.00 | -31.89 | PK |
| H | 7323.00 | 48.11 | -13.90 | 34.21 | 54.00 | -19.79 | AV |
| GFSK High channel | | | | | | | |
| V | 4960.00 | 71.13 | -19.68 | 51.45 | 74.00 | -22.55 | PK |
| V | 4960.00 | 60.25 | -19.68 | 40.57 | 54.00 | -13.43 | AV |
| V | 7440.00 | 63.74 | -13.57 | 50.17 | 74.00 | -23.83 | PK |
| V | 7440.00 | 53.65 | -13.57 | 40.08 | 54.00 | -13.92 | AV |
| H | 4960.00 | 69.95 | -19.68 | 50.27 | 74.00 | -23.73 | PK |
| H | 4960.00 | 58.96 | -19.68 | 39.28 | 54.00 | -14.72 | AV |
| H | 7440.00 | 62.62 | -13.57 | 49.05 | 74.00 | -24.95 | PK |
| H | 7440.00 | 53.92 | -13.57 | 40.35 | 54.00 | -13.65 | AV |

Remark:

1. Measurement = Reading Level + Correct Factor, Correct Factor = Antenna Factor + Cable Loss – Pre-amplifier. Over= Measurement - Limit

2.If peak below the average limit, the average emission was no test.

3. In restricted bands of operation, The spurious emissions below the permissible value more than 20dB

4. The amplitude of spurious emissions which are attenuated by more than 20dB below the permissible value has no need to be reported.

| Polar (H/V) | Frequency | Reading Level | Correct Factor | Measure- ment | Limits | Over | Detector Type |
|--|-----------|------------------|-------------------|------------------|--------------|--------|------------------|
| | (MHz) | (dBuV/m) | (dB) | (dBuV/m) | (dBuV/ m) | (dB) | |
| $\pi/4$ DQPSK Low channel | | | | | | | |
| V | 4804.00 | 71.82 | -19.99 | 51.83 | 74.00 | -22.17 | PK |
| V | 4804.00 | 63.07 | -19.99 | 43.08 | 54.00 | -10.92 | AV |
| V | 7206.00 | 64.33 | -14.22 | 50.11 | 74.00 | -23.89 | PK |
| V | 7206.00 | 53.38 | -14.22 | 39.16 | 54.00 | -14.84 | AV |
| H | 4804.00 | 66.93 | -19.99 | 46.94 | 74.00 | -27.06 | PK |
| H | 4804.00 | 56.56 | -19.99 | 36.57 | 54.00 | -17.43 | AV |
| H | 7206.00 | 61.99 | -14.22 | 47.77 | 74.00 | -26.23 | PK |
| H | 7206.00 | 54.78 | -14.22 | 40.56 | 54.00 | -13.44 | AV |
| $\pi/4$ DQPSK Middle channel | | | | | | | |
| V | 4882.00 | 69.60 | -19.84 | 49.76 | 74.00 | -24.24 | PK |
| V | 4882.00 | 62.43 | -19.84 | 42.59 | 54.00 | -11.41 | AV |
| V | 7323.00 | 62.13 | -13.90 | 48.23 | 74.00 | -25.77 | PK |
| V | 7323.00 | 52.69 | -13.90 | 38.79 | 54.00 | -15.21 | AV |
| H | 4882.00 | 68.47 | -19.84 | 48.63 | 74.00 | -25.37 | PK |
| H | 4882.00 | 58.96 | -19.84 | 39.12 | 54.00 | -14.88 | AV |
| H | 7323.00 | 61.10 | -13.90 | 47.20 | 74.00 | -26.80 | PK |
| H | 7323.00 | 53.62 | -13.90 | 39.72 | 54.00 | -14.28 | AV |
| $\pi/4$ DQPSK High channel | | | | | | | |
| V | 4960.00 | 71.35 | -19.68 | 51.67 | 74.00 | -22.33 | PK |
| V | 4960.00 | 62.05 | -19.68 | 42.37 | 54.00 | -11.63 | AV |
| V | 7440.00 | 63.11 | -13.57 | 49.54 | 74.00 | -24.46 | PK |
| V | 7440.00 | 52.34 | -13.57 | 38.77 | 54.00 | -15.23 | AV |
| H | 4960.00 | 68.52 | -19.68 | 48.84 | 74.00 | -25.16 | PK |
| H | 4960.00 | 57.57 | -19.68 | 37.89 | 54.00 | -16.11 | AV |
| H | 7440.00 | 60.22 | -13.57 | 46.65 | 74.00 | -27.35 | PK |
| H | 7440.00 | 52.77 | -13.57 | 39.20 | 54.00 | -14.80 | AV |

Remark:

1. Measurement = Reading Level + Correct Factor, Correct Factor = Antenna Factor + Cable Loss – Pre-amplifier. Over= Measurement - Limit

2.If peak below the average limit, the average emission was no test.

3. In restricted bands of operation, The spurious emissions below the permissible value more than 20dB

4. The amplitude of spurious emissions which are attenuated by more than 20dB below the permissible value has no need to be reported.



| Polar (H/V) | Frequency | Reading Level | Correct Factor | Measurement | Limits | Over | Detector Type |
|-----------------------------|-----------|---------------|----------------|-------------|----------|--------|---------------|
| | (MHz) | (dBuV/m) | (dB) | (dBuV/m) | (dBuV/m) | (dB) | |
| 8DPSK Low channel | | | | | | | |
| V | 4804.00 | 70.61 | -19.99 | 50.62 | 74.00 | -23.38 | PK |
| V | 4804.00 | 60.48 | -19.99 | 40.49 | 54.00 | -13.51 | AV |
| V | 7206.00 | 61.74 | -14.22 | 47.52 | 74.00 | -26.48 | PK |
| V | 7206.00 | 51.45 | -14.22 | 37.23 | 54.00 | -16.77 | AV |
| H | 4804.00 | 67.50 | -19.99 | 47.51 | 74.00 | -26.49 | PK |
| H | 4804.00 | 57.18 | -19.99 | 37.19 | 54.00 | -16.81 | AV |
| H | 7206.00 | 59.14 | -14.22 | 44.92 | 74.00 | -29.08 | PK |
| H | 7206.00 | 51.35 | -14.22 | 37.13 | 54.00 | -16.87 | AV |
| 8DPSK Middle channel | | | | | | | |
| V | 4882.00 | 68.79 | -19.84 | 48.95 | 74.00 | -25.05 | PK |
| V | 4882.00 | 61.11 | -19.84 | 41.27 | 54.00 | -12.73 | AV |
| V | 7323.00 | 60.42 | -13.90 | 46.52 | 74.00 | -27.48 | PK |
| V | 7323.00 | 50.75 | -13.90 | 36.85 | 54.00 | -17.15 | AV |
| H | 4882.00 | 66.28 | -19.84 | 46.44 | 74.00 | -27.56 | PK |
| H | 4882.00 | 55.28 | -19.84 | 35.44 | 54.00 | -18.56 | AV |
| H | 7323.00 | 58.83 | -13.90 | 44.93 | 74.00 | -29.07 | PK |
| H | 7323.00 | 51.35 | -13.90 | 37.45 | 54.00 | -16.55 | AV |
| 8DPSK High channel | | | | | | | |
| V | 4960.00 | 71.78 | -19.68 | 52.10 | 74.00 | -21.90 | PK |
| V | 4960.00 | 60.87 | -19.68 | 41.19 | 54.00 | -12.81 | AV |
| V | 7440.00 | 64.15 | -13.57 | 50.58 | 74.00 | -23.42 | PK |
| V | 7440.00 | 54.40 | -13.57 | 40.83 | 54.00 | -13.17 | AV |
| H | 4960.00 | 69.27 | -19.68 | 49.59 | 74.00 | -24.41 | PK |
| H | 4960.00 | 60.04 | -19.68 | 40.36 | 54.00 | -13.64 | AV |
| H | 7440.00 | 61.64 | -13.57 | 48.07 | 74.00 | -25.93 | PK |
| H | 7440.00 | 53.27 | -13.57 | 39.70 | 54.00 | -14.30 | AV |

Remark:

1. Measurement = Reading Level + Correct Factor, Correct Factor = Antenna Factor + Cable Loss – Pre-amplifier. Over= Measurement - Limit

2.If peak below the average limit, the average emission was no test.

3. In restricted bands of operation, The spurious emissions below the permissible value more than 20dB

4. The amplitude of spurious emissions which are attenuated by more than 20dB below the permissible value has no need to be reported.

8. Radiated Band Emission Measurement And Restricted Bands Of Operation

8.1 Block Diagram Of Test Setup

Radiated Emission Test-Up Frequency Above 1GHz

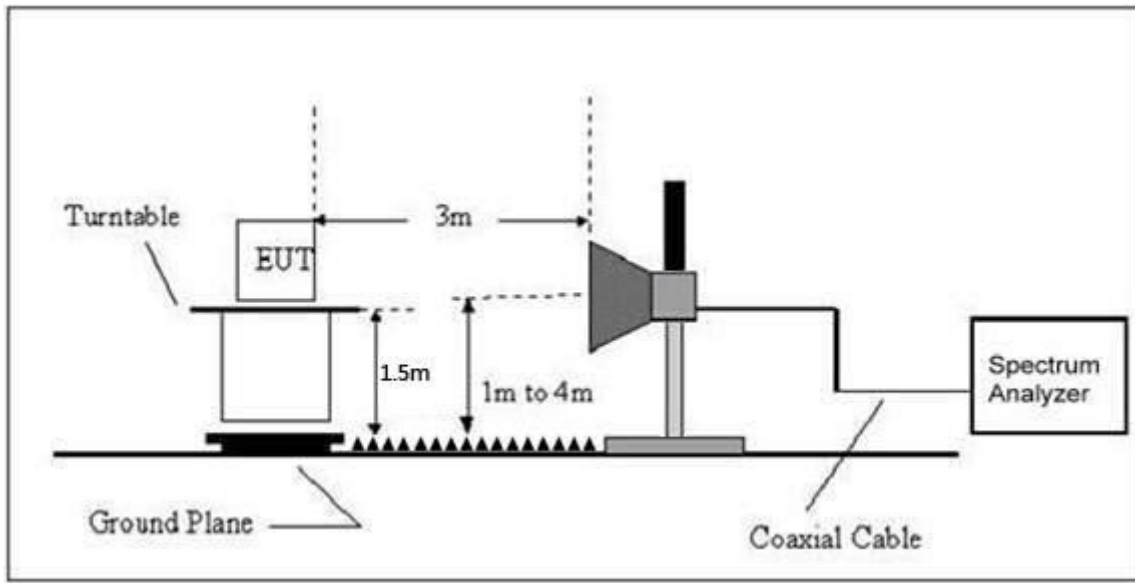

8.2 Limit

FCC Part15 C Section 15.209 and 15.205

(a) Except as shown in paragraph (d) of this section, only spurious emissions are permitted in any of the frequency bands listed below:

| MHz | MHz | MHz | GHz |
|-------------------|---------------------|---------------|------------------|
| 0.090-0.110 | 16.42-16.423 | 399.9-410 | 4.5-5.15 |
| 0.495-0.505 | 16.69475-16.69525 | 608-614 | 5.35-5.46 |
| 2.1735-2.1905 | 16.80425-16.80475 | 960-1240 | 7.25-7.75 |
| 4.125-4.128 | 25.5-25.67 | 1300-1427 | 8.025-8.5 |
| 4.17725-4.17775 | 37.5-38.25 | 1435-1626.5 | 9.0-9.2 |
| 4.20725-4.20775 | 73-74.6 | 1645.5-1646.5 | 9.3-9.5 |
| 6.215-6.218 | 74.8-75.2 | 1660-1710 | 10.6-12.7 |
| 6.26775-6.26825 | 108-121.94 | 1718.8-1722.2 | 13.25-13.4 |
| 6.31175-6.31225 | 123-138 | 2200-2300 | 14.47-14.5 |
| 8.291-8.294 | 149.9-150.05 | 2310-2390 | 15.35-16.2 |
| 8.362-8.366 | 156.52475-156.52525 | 2483.5-2500 | 17.7-21.4 |
| 8.37625-8.38675 | 156.7-156.9 | 2690-2900 | 22.01-23.12 |
| 8.41425-8.41475 | 162.0125-167.17 | 3260-3267 | 23.6-24.0 |
| 12.29-12.293 | 167.72-173.2 | 3332-3339 | 31.2-31.8 |
| 12.51975-12.52025 | 240-285 | 3345.8-3358 | 36.43-36.5 |
| 12.57675-12.57725 | 322-335.4 | 3600-4400 | (²) |
| 13.36-13.41 | | | |

Limits Of Radiated Emission Measurement (Above 1000MHz)

| Frequency (MHz) | Limit (dBuV/m) (at 3M) | |
|-----------------|------------------------|---------|
| | Peak | Average |
| Above 1000 | 74 | 54 |

Notes:

- (1)The limit for radiated test was performed according to FCC PART 15C.
- (2)The tighter limit applies at the band edges.
- (3)Emission level (dBuV/m)=20log Emission level (uV/m).

8.3 Test procedure

| Receiver Parameter | Setting |
|---------------------------------------|--|
| Attenuation | Auto |
| Start Frequency | 2300MHz |
| Stop Frequency | 2520 |
| RB / VB (Emission In Restricted Band) | 1 MHz / 1 MHz for Peak, 1 MHz / 10Hz for Average |

Above 1GHz test procedure as below:

- a.The EUT was placed on the top of a rotating table 1.5 meters above the ground at a 3 meter camber. The table was rotated 360 degrees to determine the position of the highest radiation.
- b.The EUT was set 3 meters away from the interference-receiving antenna, which was mounted on the top of a variable-height antenna tower.
- c.The antenna height is varied from one meter to four meters above the ground to determine the maximum value of the field strength. Both horizontal and vertical polarizations of the antenna are set to make the measurement.
- d.For each suspected emission, the EUT was arranged to its worst case and then the antenna was tuned to heights from 1 meter to 4 meters and the rota table was turned from 0 degrees to 360 degrees to find the maximum reading.
- e.The test-receiver system was set to Peak Detect Function and Specified Bandwidth with Maximum Hold Mode.
- f. If the emission level of the EUT in peak mode was 10dB lower than the limit specified, then testing could be stopped and the peak values of the EUT would be reported. Otherwise the emissions that did not have 10dB margin would be re-tested one by one using peak, quasi-peak or average method as specified and then reported in a data sheet.
- g. Test the EUT in the lowest channel, the Highest channel.

Note:

Both horizontal and vertical antenna polarities were tested and performed pretest to three orthogonal axis. The worst case emissions were reported.

8.4 EUT operating Conditions

The EUT was configured for testing in a typical fashion (as a customer would normally use it). The EUT has been programmed to continuously transmit during test. This operating condition was tested and used to collect the included data.



8.5 Test Result

| Test mode | Polar (H/V) | Frequency (MHz) | Reading Level (dBuV/m) | Correct Factor (dB) | Measurement (dBuV/m) | Limits (dBuV/m) | | Over | Result | |
|-----------------------------|-----------------------------|----------------------------|------------------------|---------------------|----------------------|-----------------|-------|--------|--------|------|
| | | | | | PK | PK | AV | PK | | |
| GFSK | Low Channel 2402MHz | | | | | | | | | |
| | H | 2390.00 | 72.22 | -25.43 | 46.79 | 74.00 | 54.00 | -27.21 | PASS | |
| | H | 2400.00 | 73.72 | -25.40 | 48.32 | 74.00 | 54.00 | -25.68 | PASS | |
| | V | 2390.00 | 71.73 | -25.43 | 46.30 | 74.00 | 54.00 | -27.70 | PASS | |
| | V | 2400.00 | 72.03 | -25.40 | 46.63 | 74.00 | 54.00 | -27.37 | PASS | |
| | High Channel 2480MHz | | | | | | | | | |
| | H | 2483.50 | 71.86 | -25.15 | 46.71 | 74.00 | 54.00 | -27.29 | PASS | |
| | H | 2500.00 | 68.05 | -25.10 | 42.95 | 74.00 | 54.00 | -31.05 | PASS | |
| | V | 2483.50 | 70.19 | -25.15 | 45.04 | 74.00 | 54.00 | -28.96 | PASS | |
| | V | 2500.00 | 66.78 | -25.10 | 41.68 | 74.00 | 54.00 | -32.32 | PASS | |
| | π/4DQPSK | Low Channel 2402MHz | | | | | | | | |
| | | H | 2390.00 | 72.63 | -25.43 | 47.20 | 74.00 | 54.00 | -26.80 | PASS |
| H | | 2400.00 | 73.94 | -25.40 | 48.54 | 74.00 | 54.00 | -25.46 | PASS | |
| V | | 2390.00 | 73.46 | -25.43 | 48.03 | 74.00 | 54.00 | -25.97 | PASS | |
| V | | 2400.00 | 75.13 | -25.40 | 49.73 | 74.00 | 54.00 | -24.27 | PASS | |
| High Channel 2480MHz | | | | | | | | | | |
| H | | 2483.50 | 72.78 | -25.15 | 47.63 | 74.00 | 54.00 | -26.37 | PASS | |
| H | | 2500.00 | 69.08 | -25.10 | 43.98 | 74.00 | 54.00 | -30.02 | PASS | |
| V | | 2483.50 | 73.63 | -25.15 | 48.48 | 74.00 | 54.00 | -25.52 | PASS | |
| V | | 2500.00 | 69.15 | -25.10 | 44.05 | 74.00 | 54.00 | -29.95 | PASS | |
| 8DPSK | | Low Channel 2402MHz | | | | | | | | |
| | | H | 2390.00 | 72.25 | -25.43 | 46.82 | 74.00 | 54.00 | -27.18 | PASS |
| | H | 2400.00 | 74.54 | -25.40 | 49.14 | 74.00 | 54.00 | -24.86 | PASS | |
| | V | 2390.00 | 71.98 | -25.43 | 46.55 | 74.00 | 54.00 | -27.45 | PASS | |
| | V | 2400.00 | 73.53 | -25.40 | 48.13 | 74.00 | 54.00 | -25.87 | PASS | |
| | High Channel 2480MHz | | | | | | | | | |
| | H | 2483.50 | 71.94 | -25.15 | 46.79 | 74.00 | 54.00 | -27.21 | PASS | |
| | H | 2500.00 | 67.46 | -25.10 | 42.36 | 74.00 | 54.00 | -31.64 | PASS | |
| | V | 2483.50 | 71.03 | -25.15 | 45.88 | 74.00 | 54.00 | -28.12 | PASS | |
| | V | 2500.00 | 67.04 | -25.10 | 41.94 | 74.00 | 54.00 | -32.06 | PASS | |

Remark:

1. Measurement = Reading Level + Correct Factor, Correct Factor = Antenna Factor + Cable Loss – Pre-amplifier.
2. If the PK measured levels comply with average limit, then the average level were deemed to comply with average limit.
3. In restricted bands of operation, The spurious emissions below the permissible value more than 20dB
4. The amplitude of spurious emissions which are attenuated by more than 20dB below the permissible value has no need to be reported.

9. Spurious RF Conducted Emissions

9.1 Block Diagram Of Test Setup

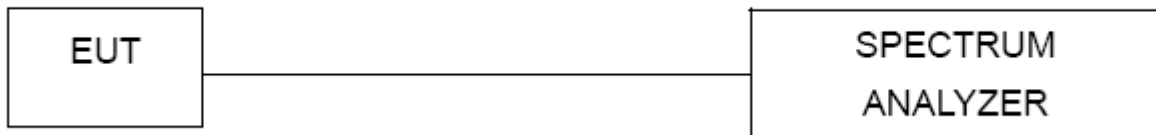

9.2 Limit

Regulation 15.247 (d), In any 100 kHz bandwidth outside the frequency band in which the spread spectrum or digitally modulated intentional radiator is operating, the radio frequency power that is produced by the intentional radiator shall be at least 20 dB below that in the 100 kHz bandwidth within the band that contains the highest level of the desired power, based on either an RF conducted or a radiated measurement, provided the transmitter demonstrates compliance with the peak conducted power limits. If the transmitter complies with the conducted power limits based on the use of RMS averaging over a time interval, as permitted under paragraph (b)(3) of this section, the attenuation required under this paragraph shall be 30 dB instead of 20 dB. Attenuation below the general limits specified in §15.209(a) is not required. In addition, radiated emissions which fall in the restricted bands, as defined in §15.205(a), must also comply with the radiated emission limits specified in §15.209(a) (see §15.205(c))

9.3 Test procedure

1. Remove the antenna from the EUT and then connect a low RF cable from the antenna port to the spectrum;
2. Set the spectrum analyzer:
RBW = 100kHz, VBW = 300kHz, Sweep = auto
Detector function = peak, Trace = max hold

9.4 Test Result

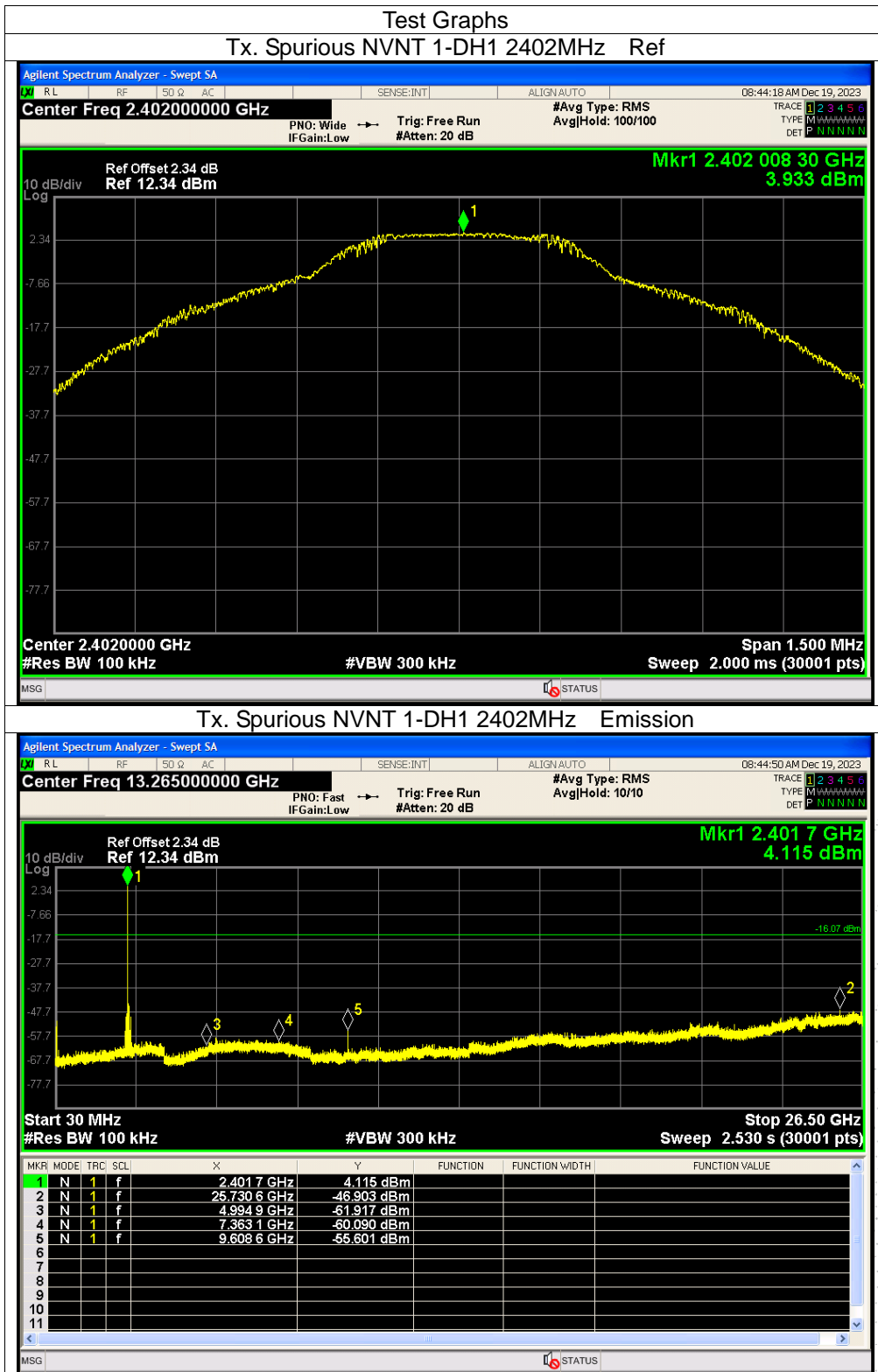

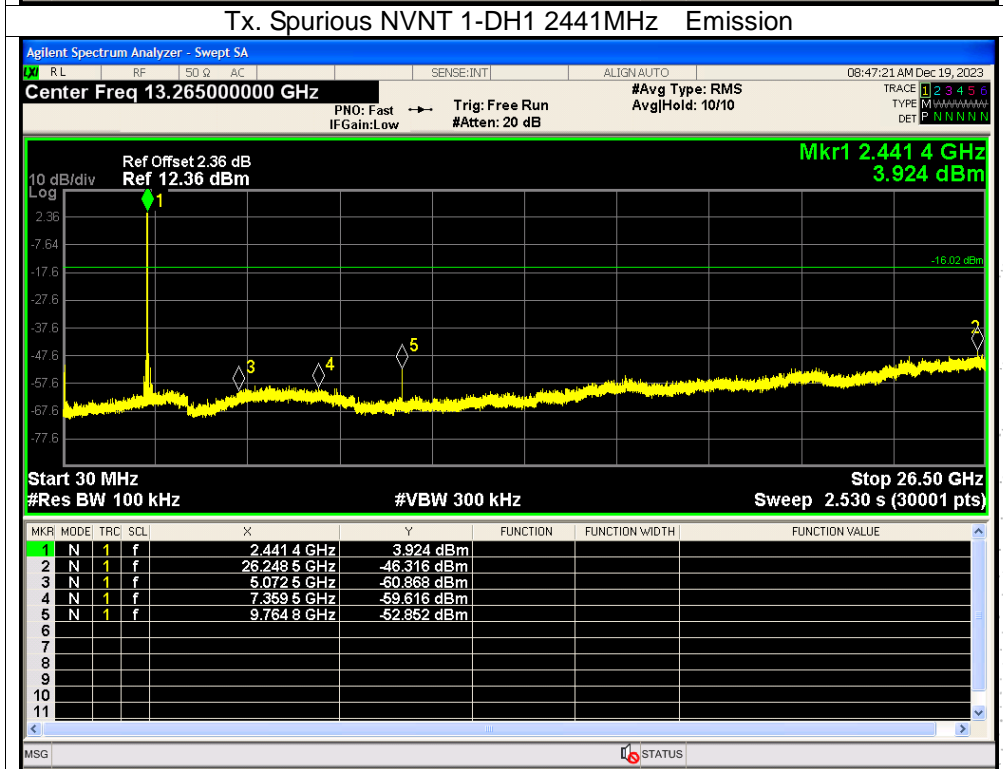
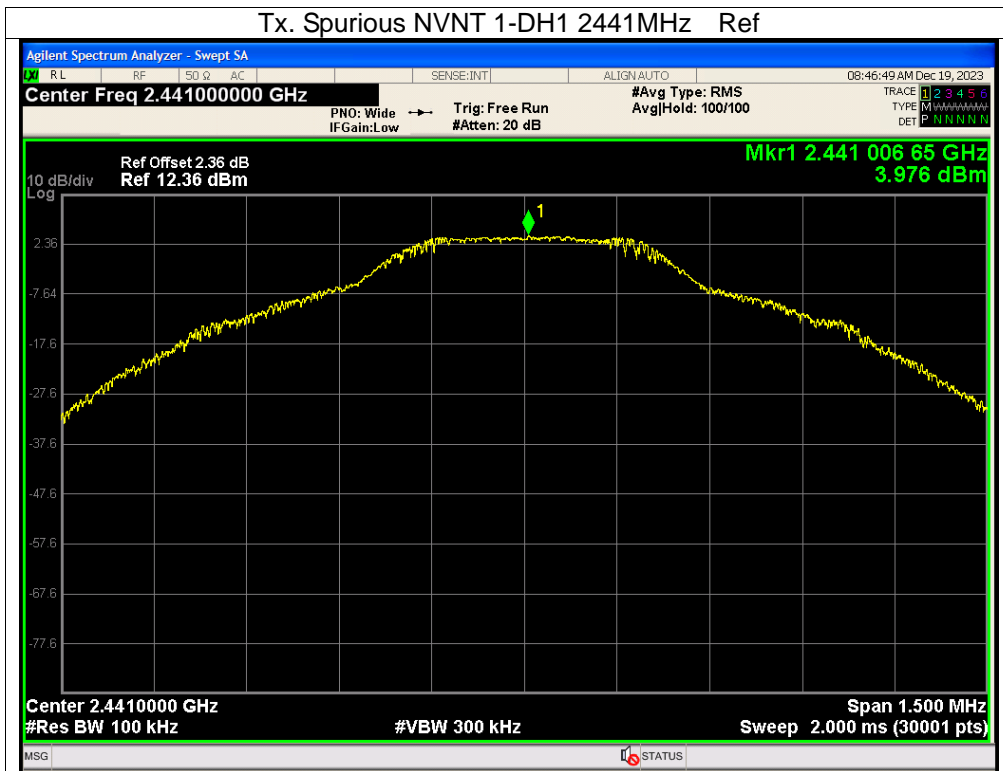

CO. LTD

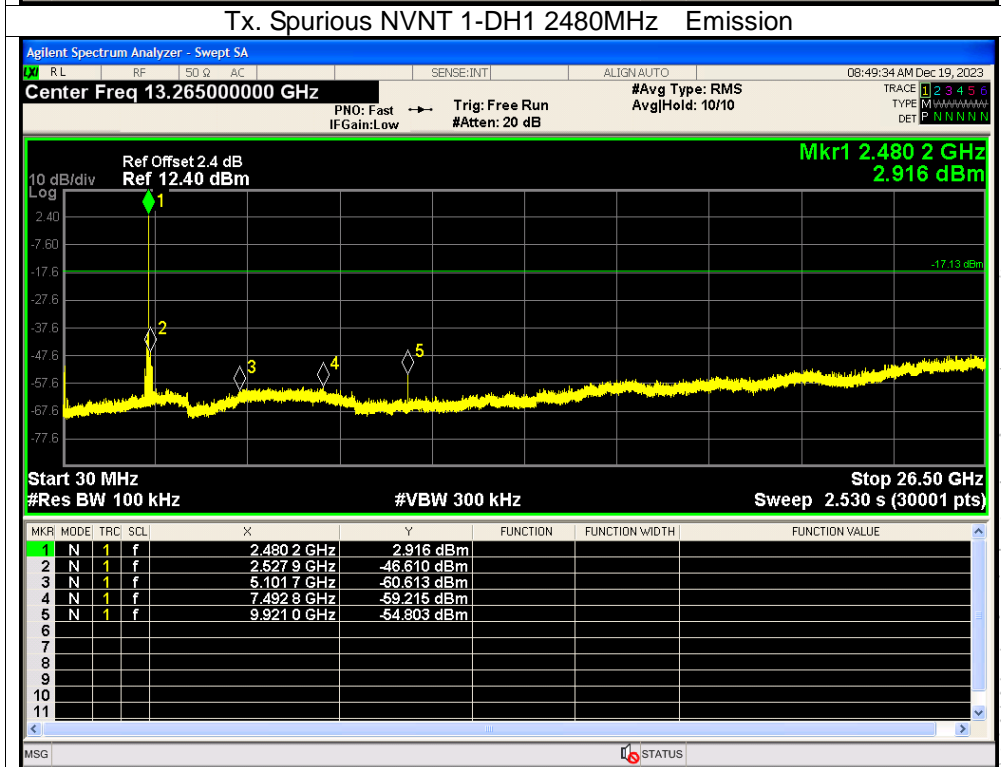
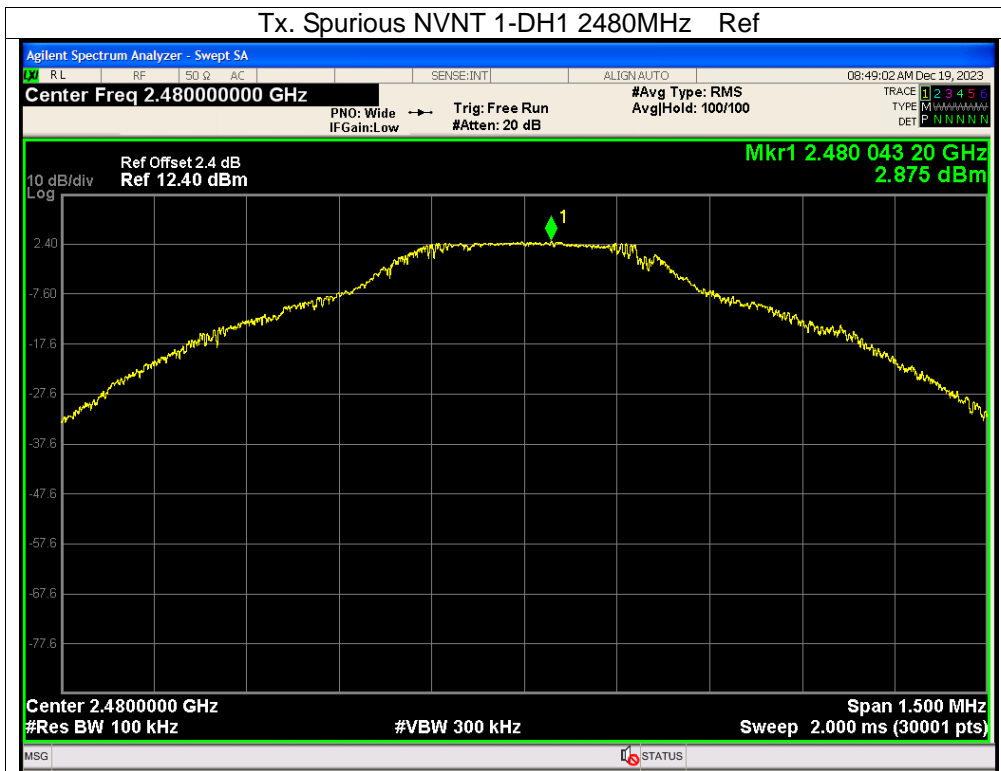

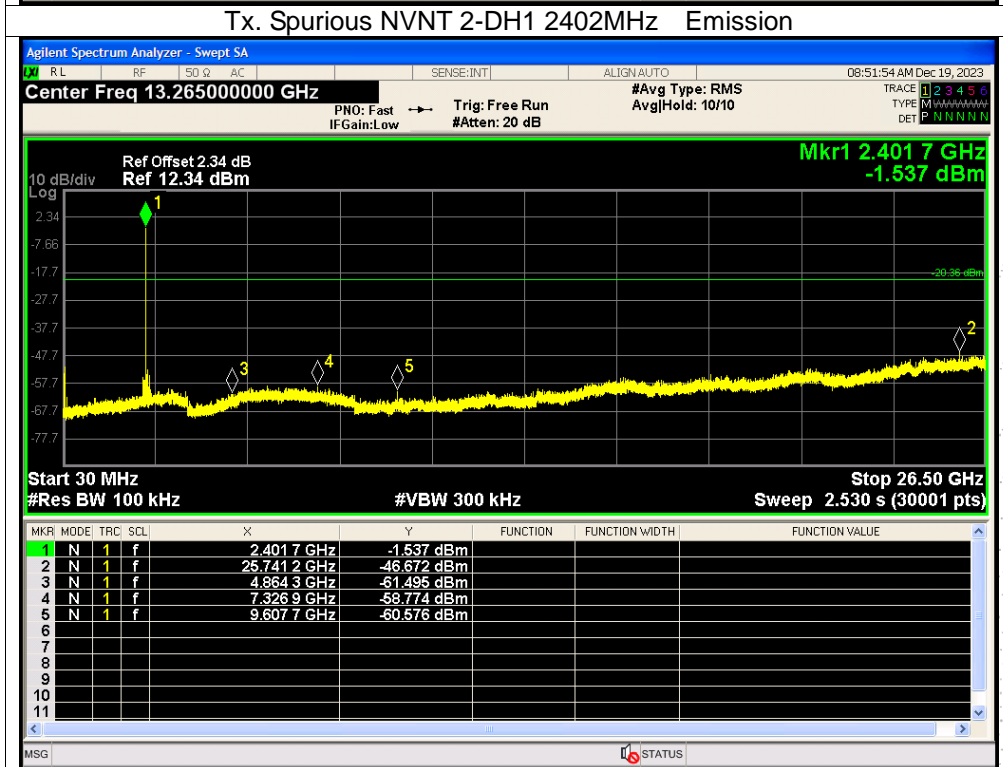
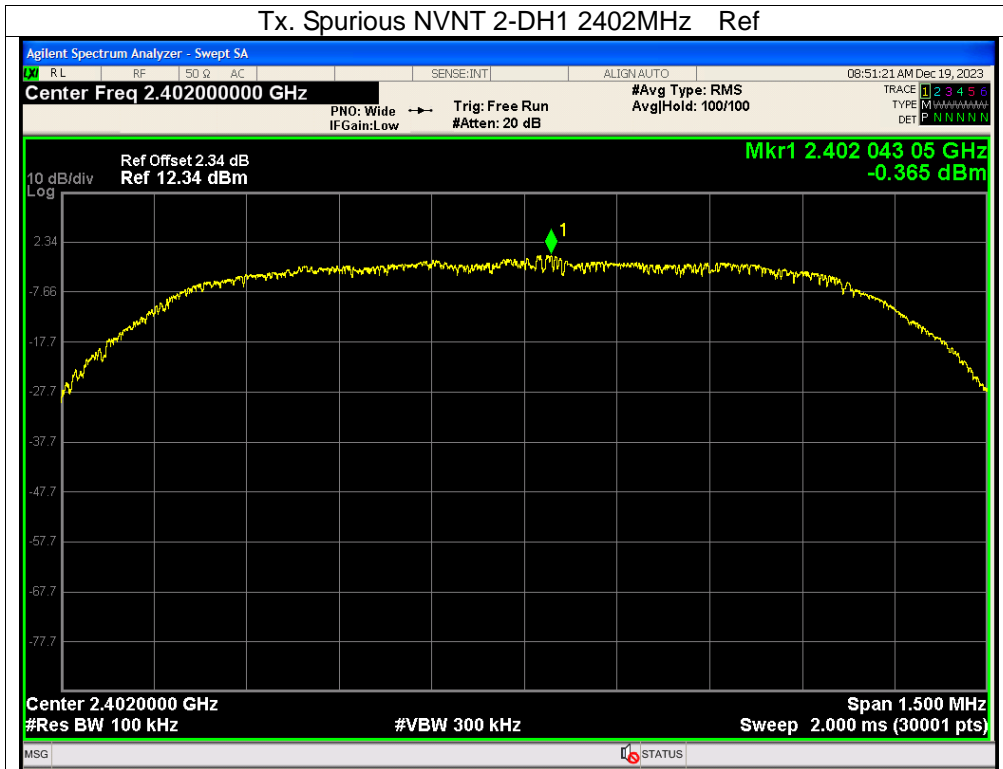

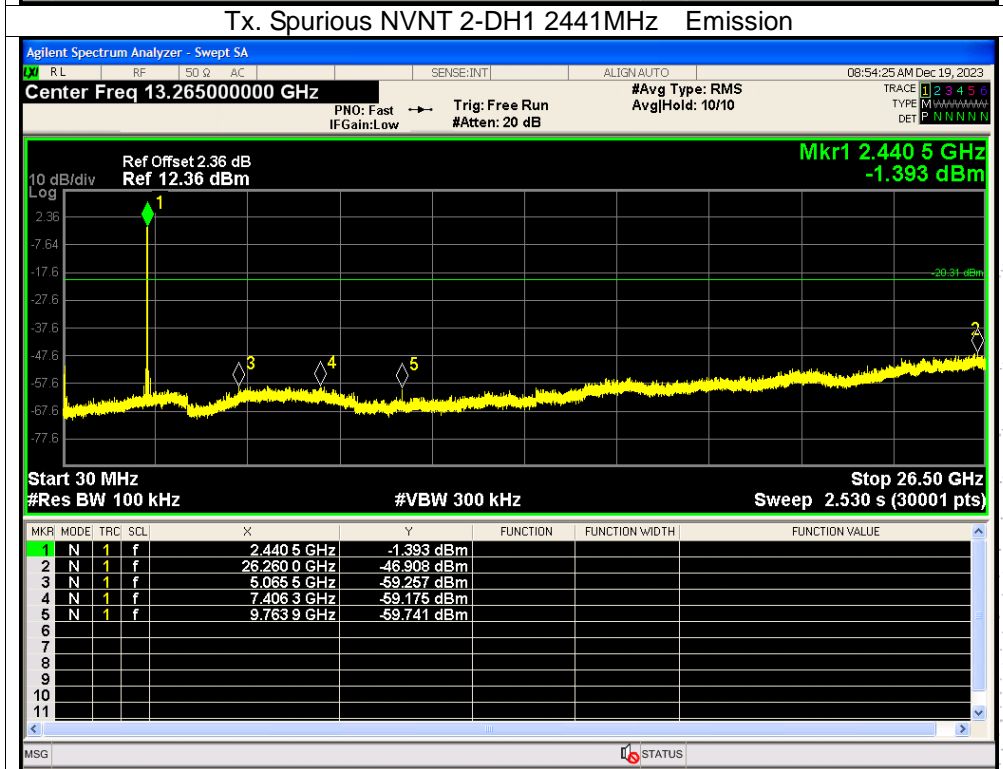
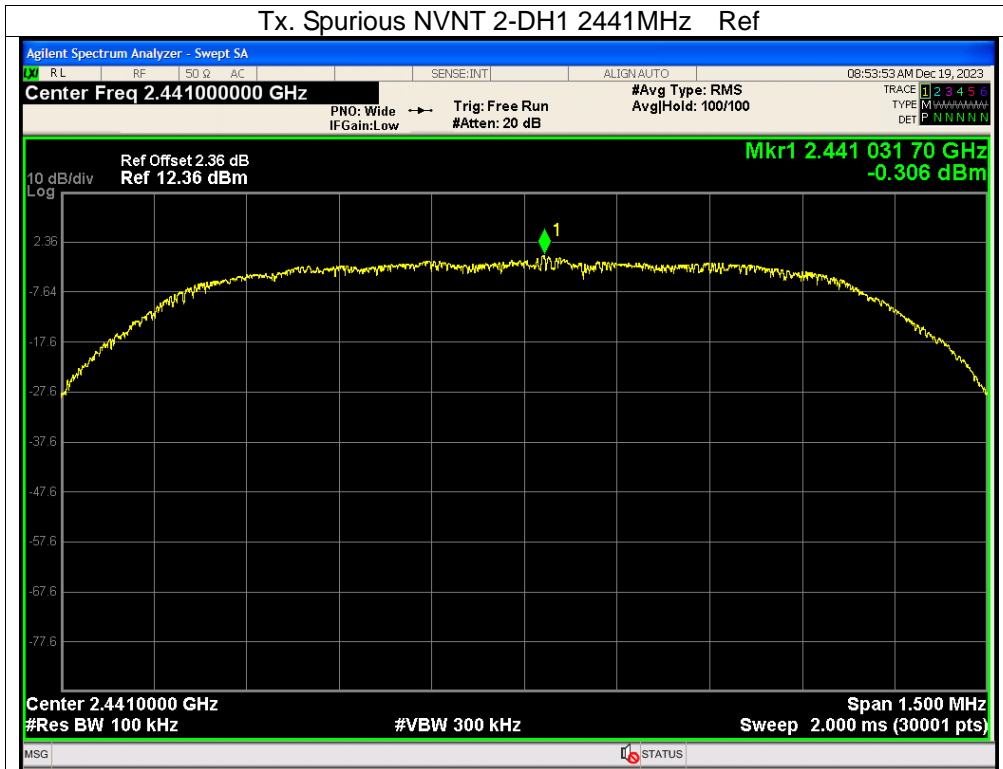

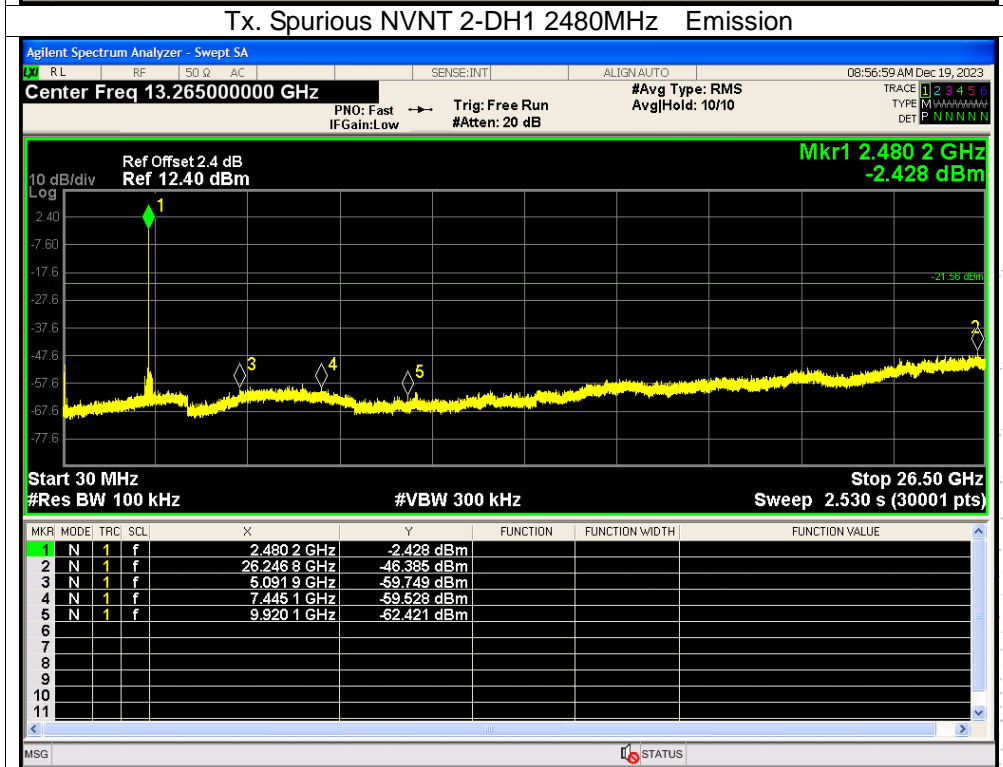
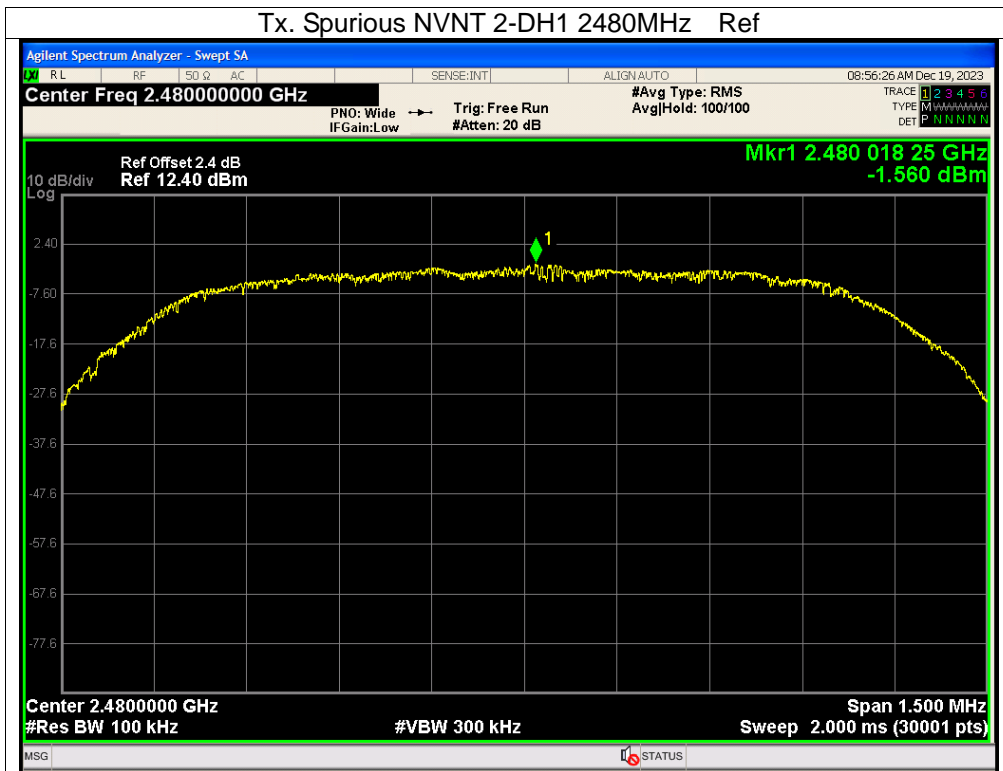

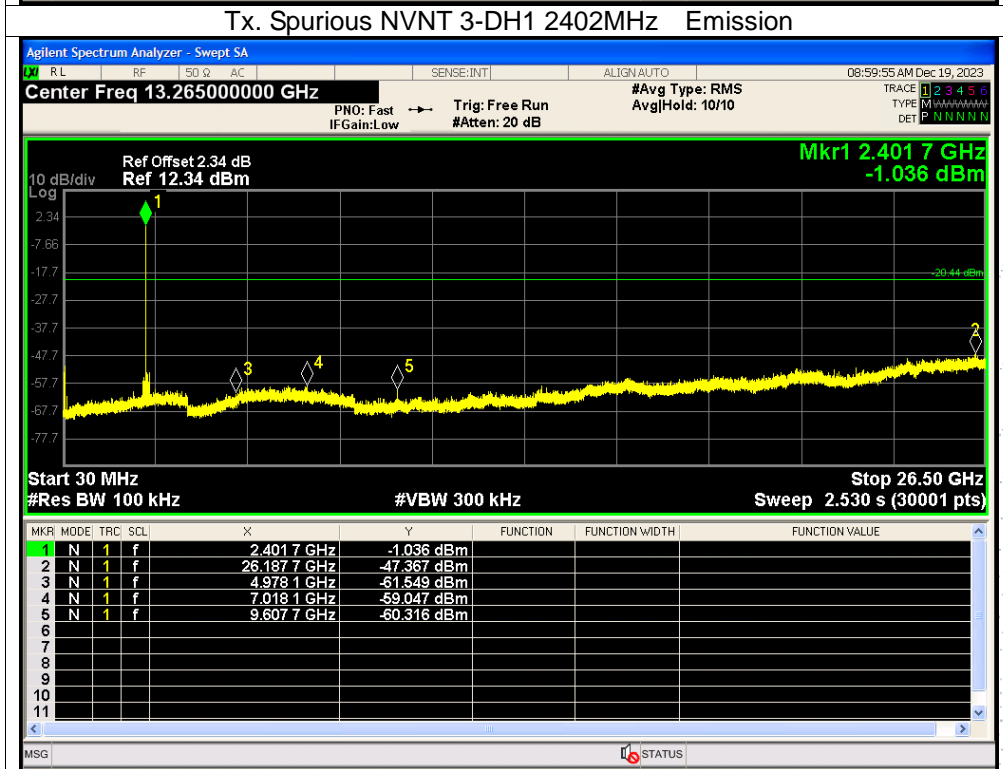
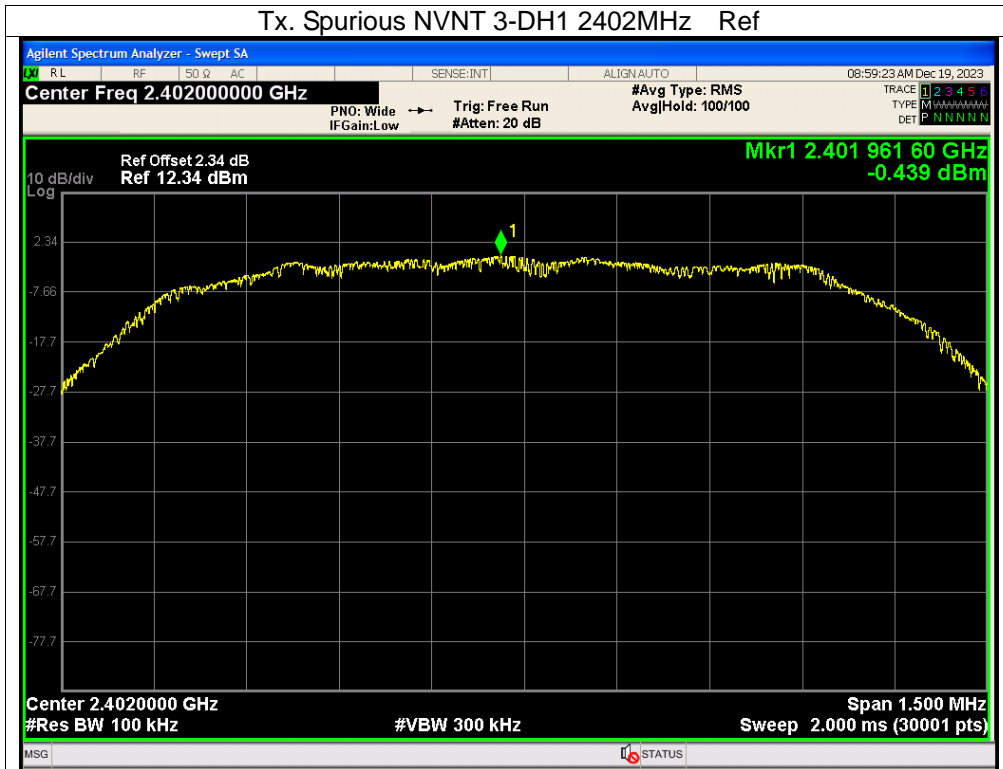

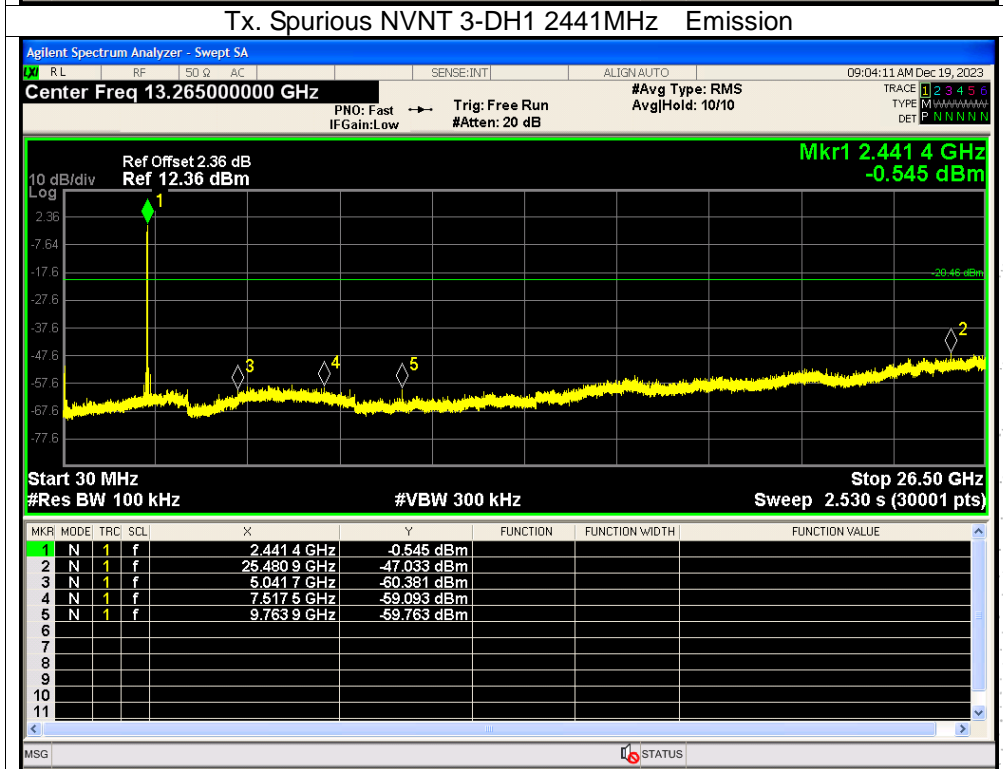
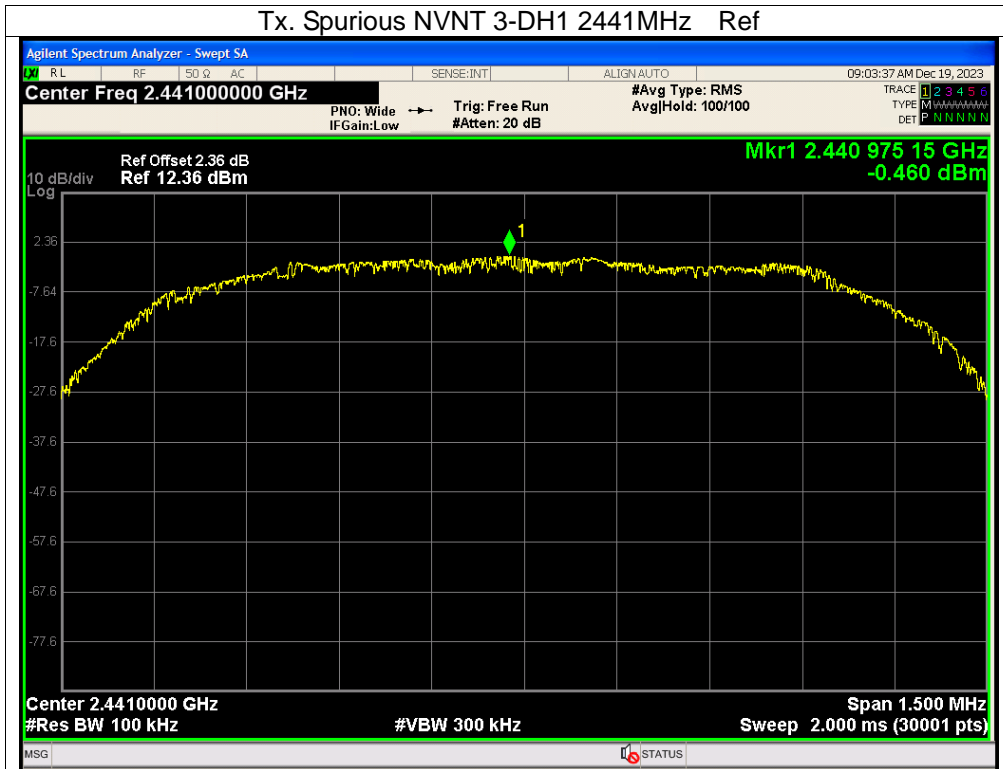

CO. LTD

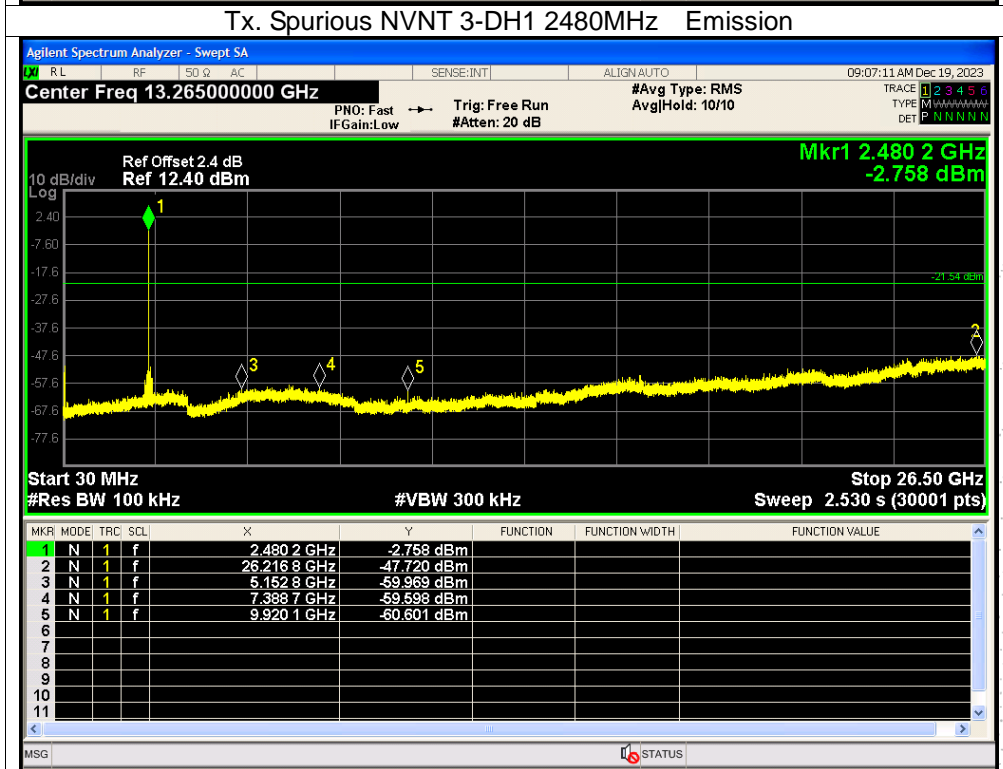
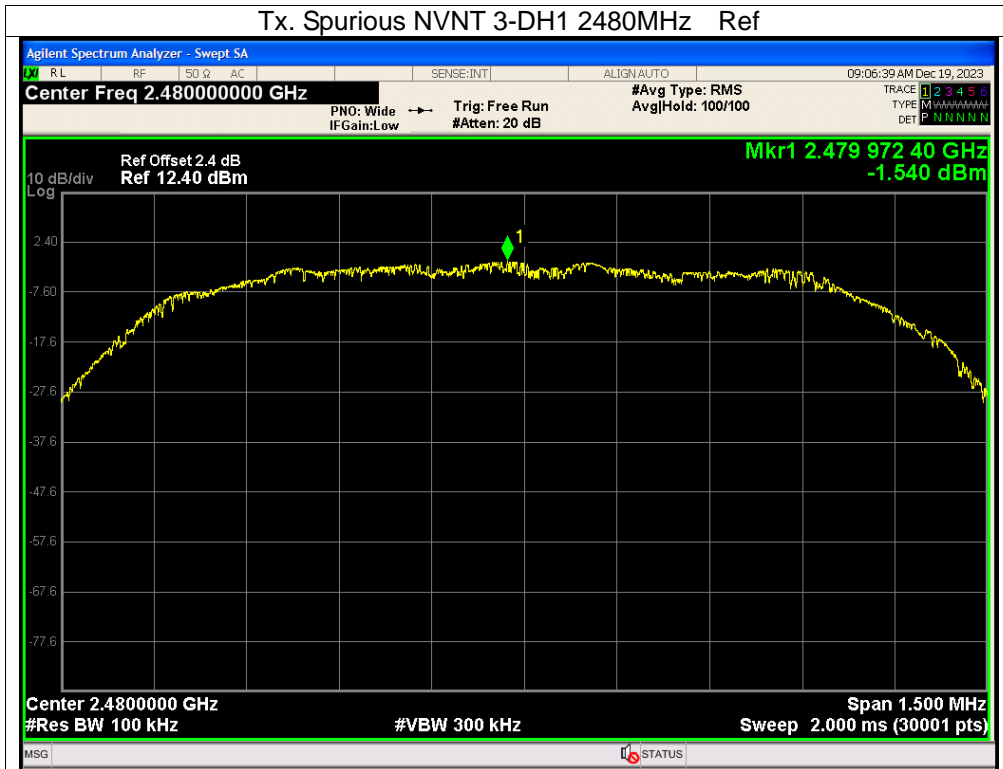

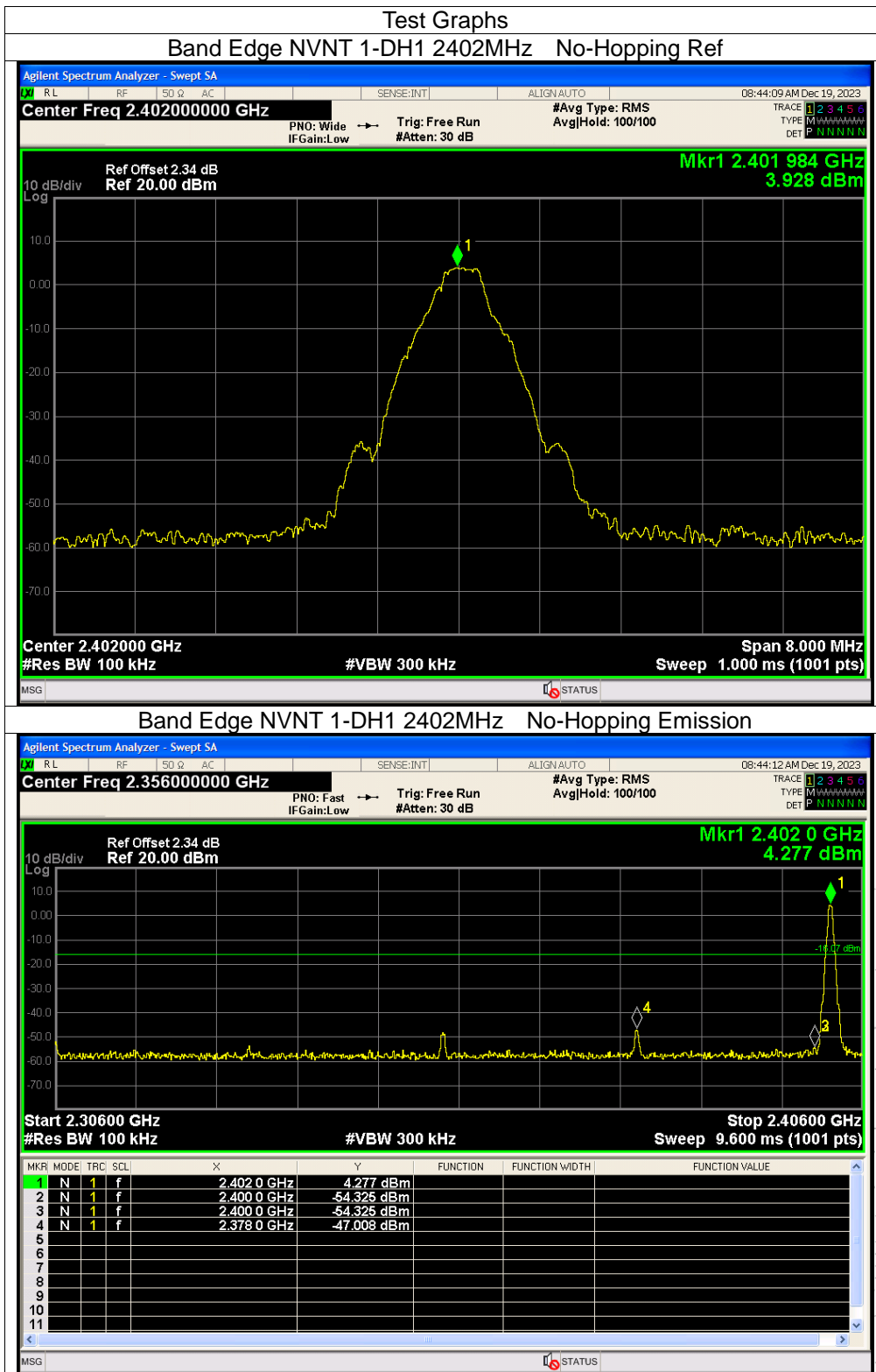

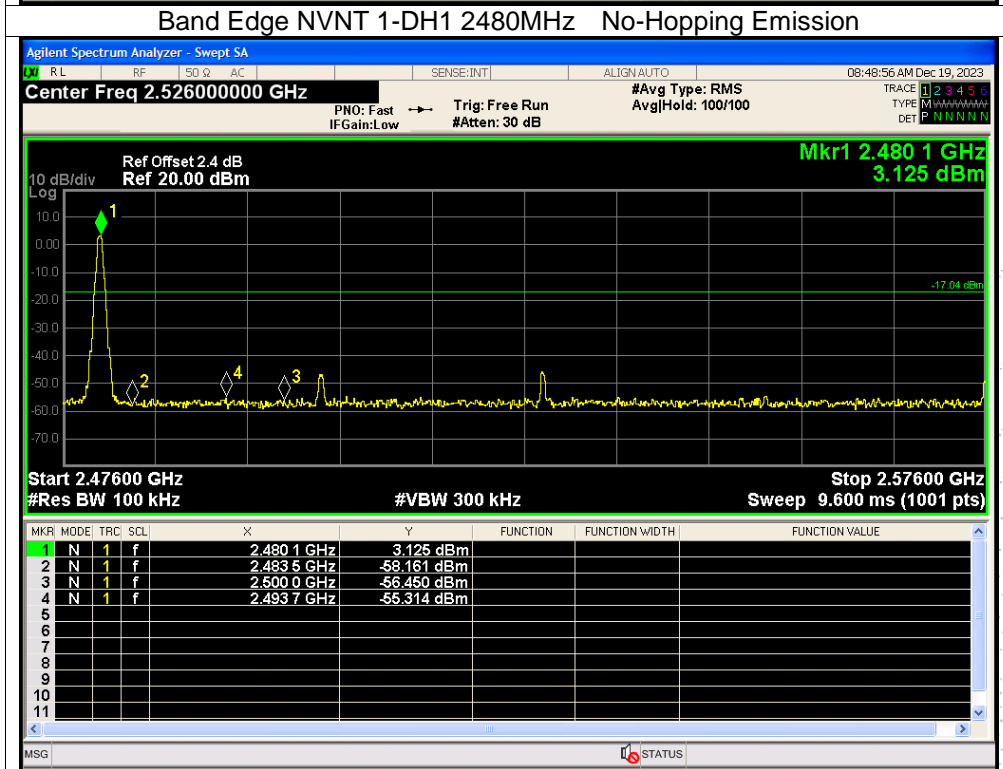
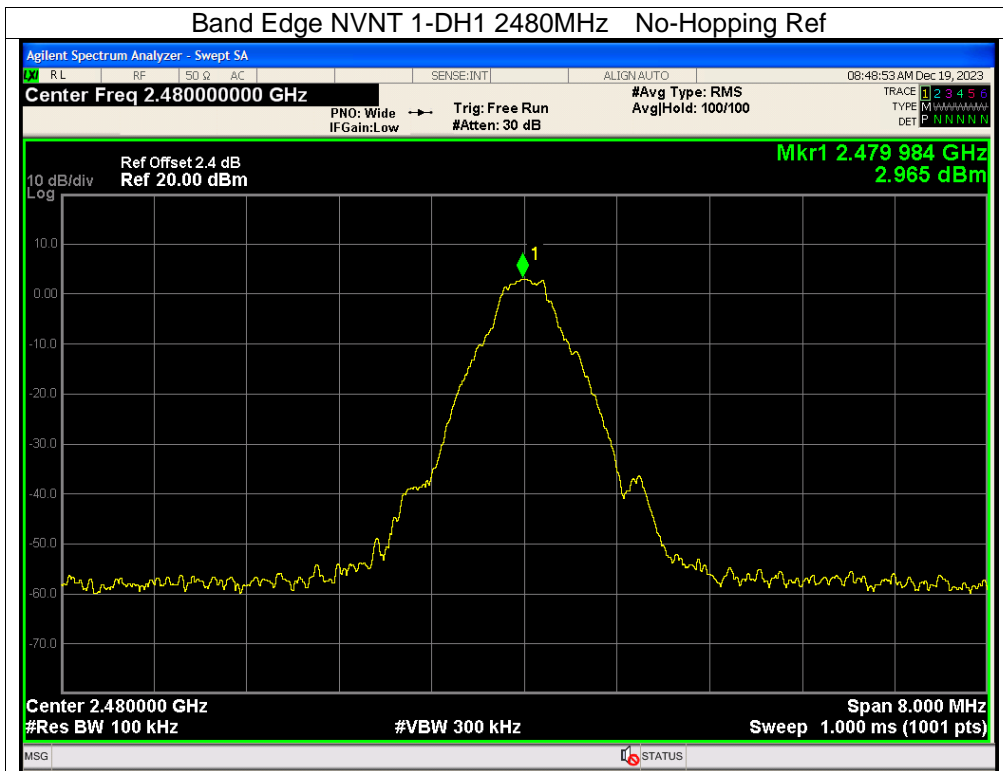

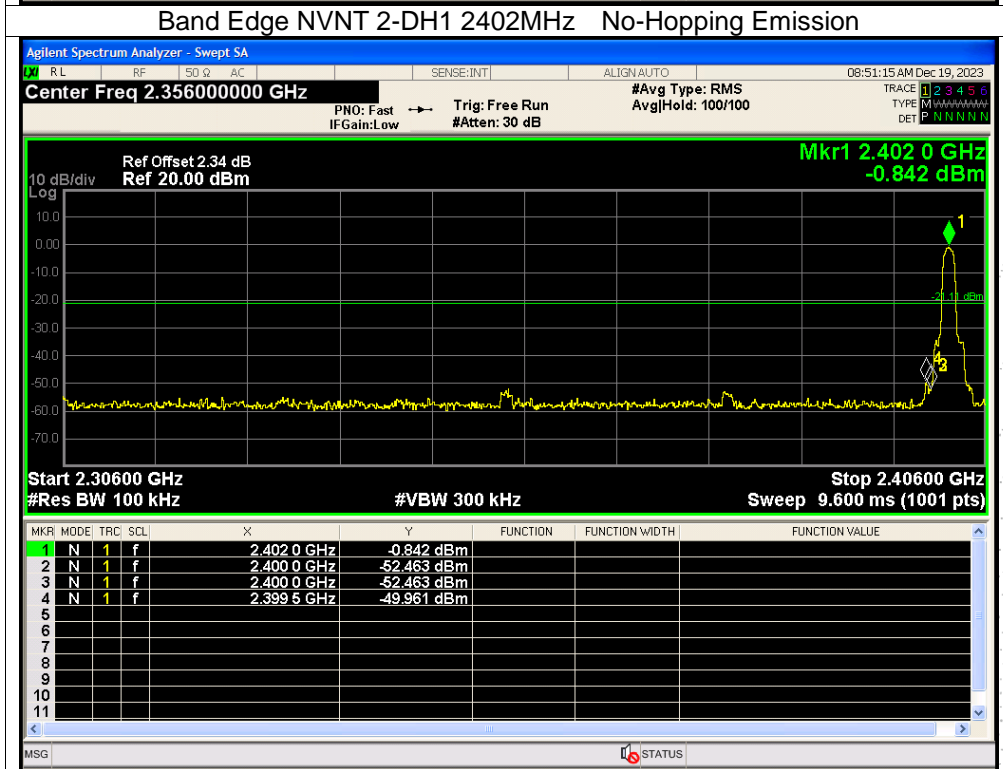
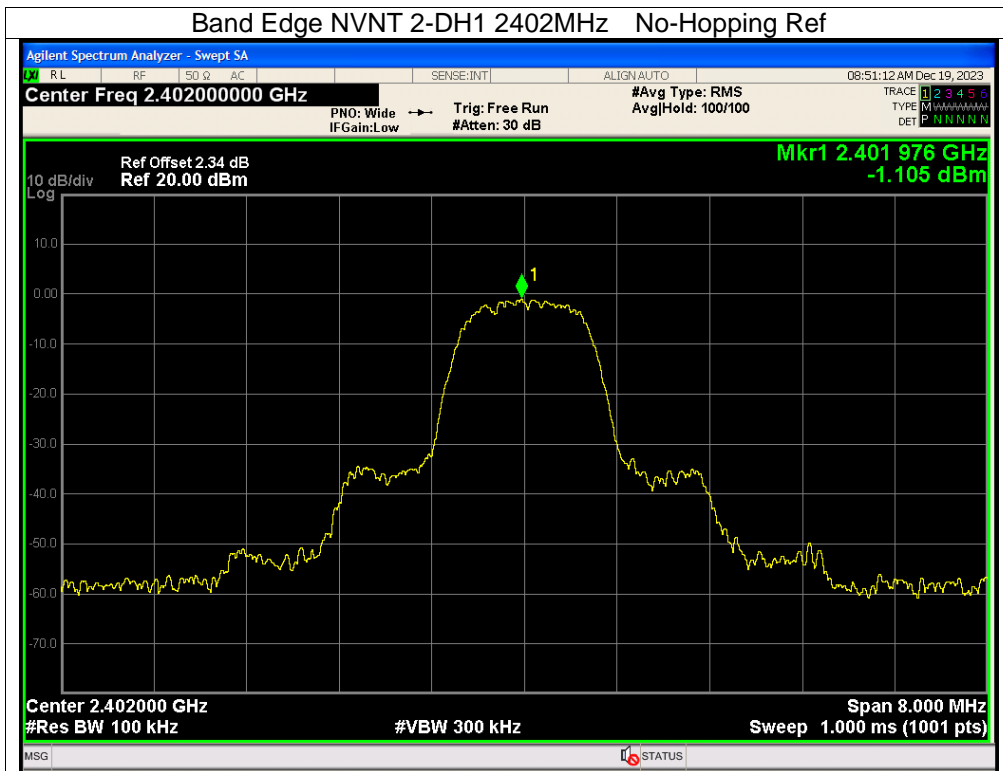

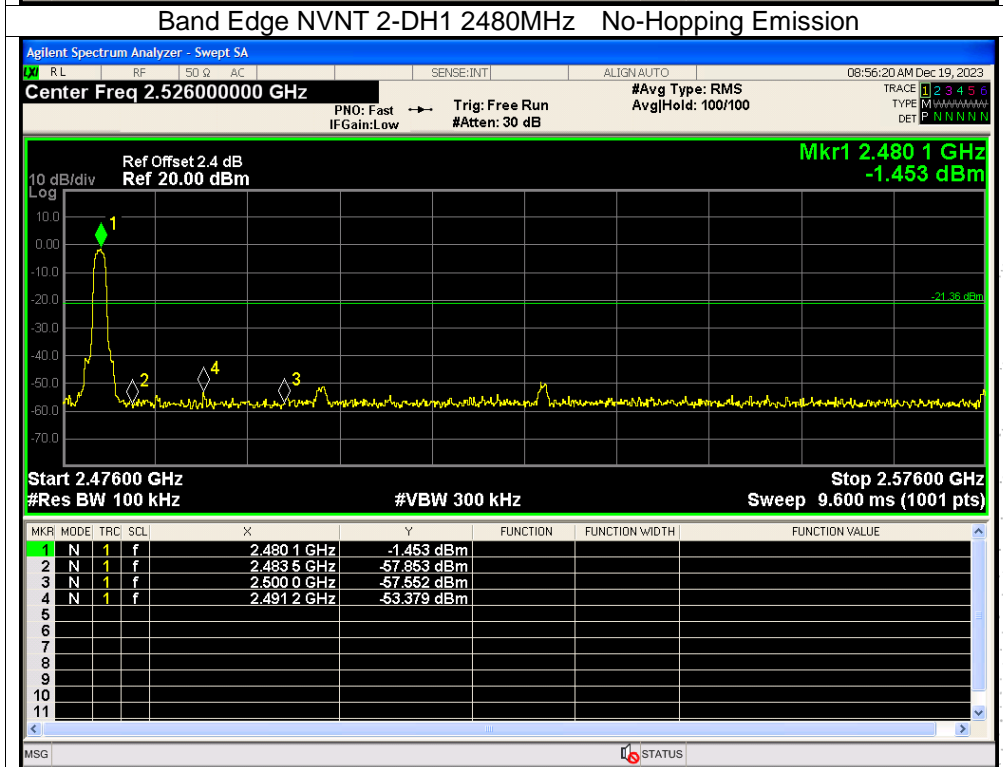
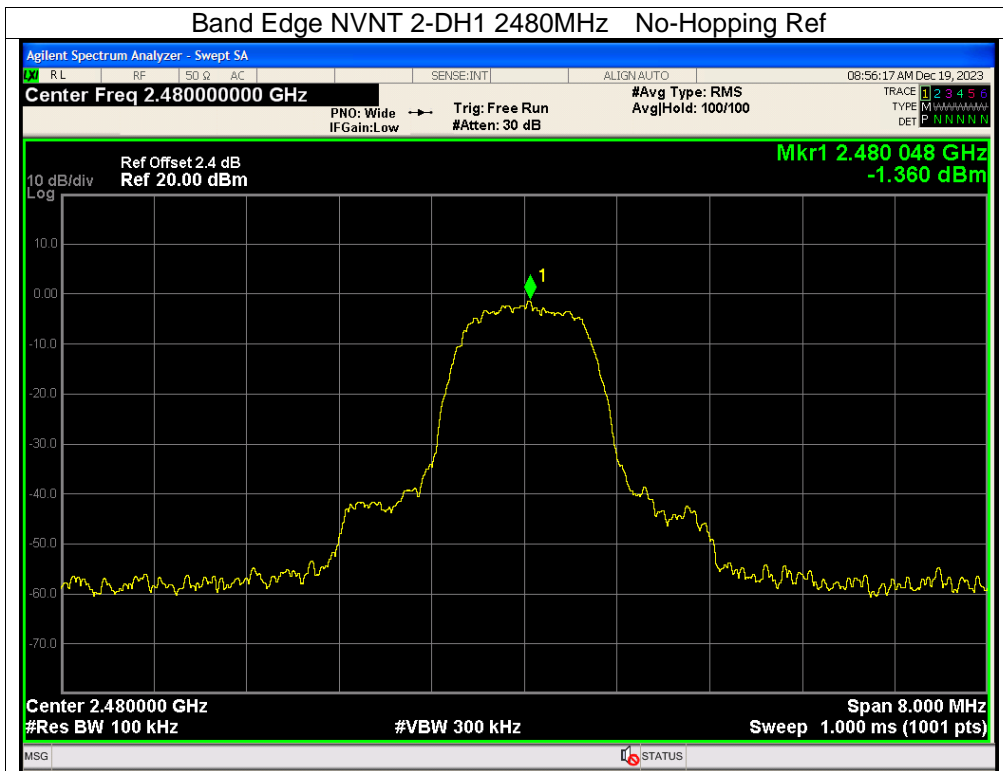

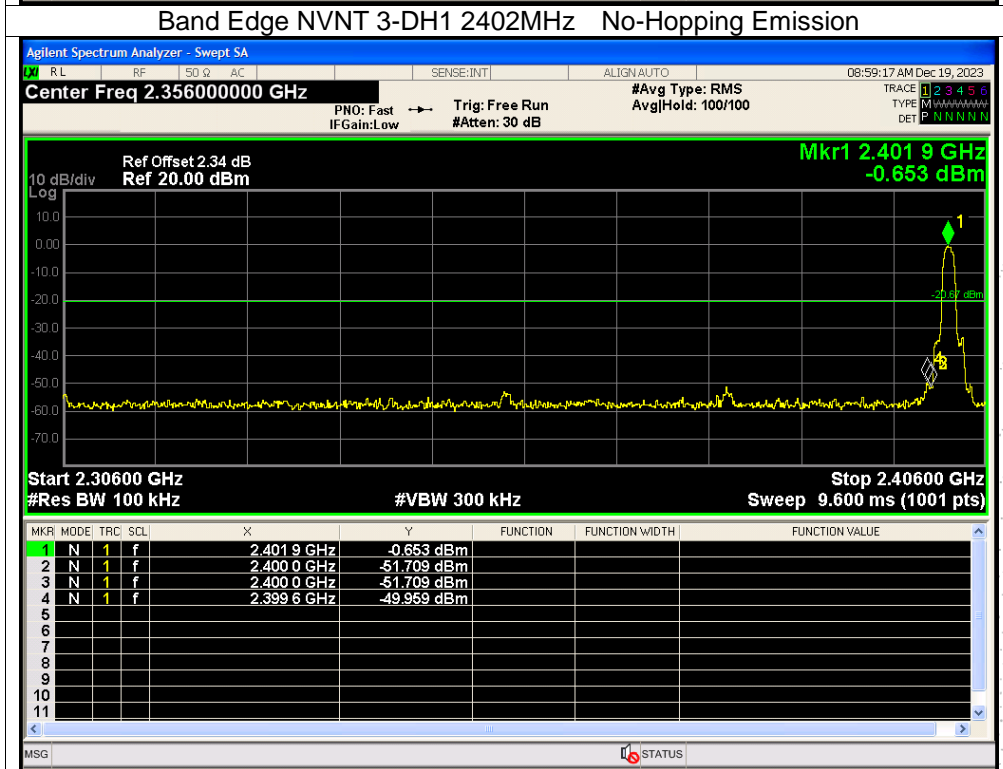
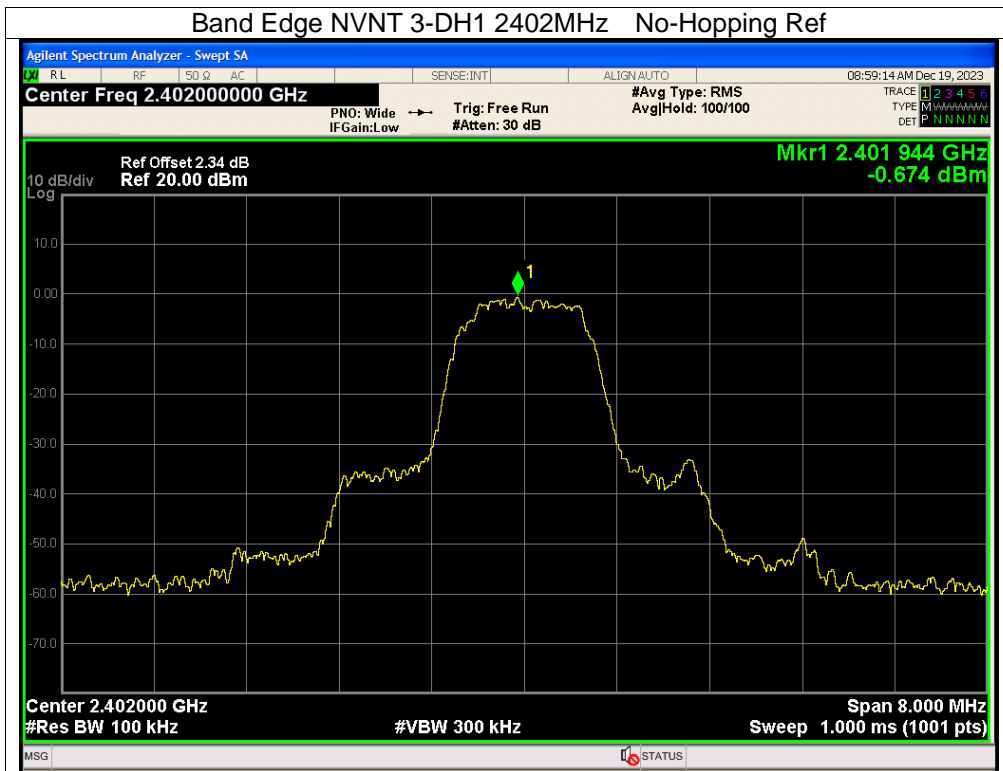

CO. LTD

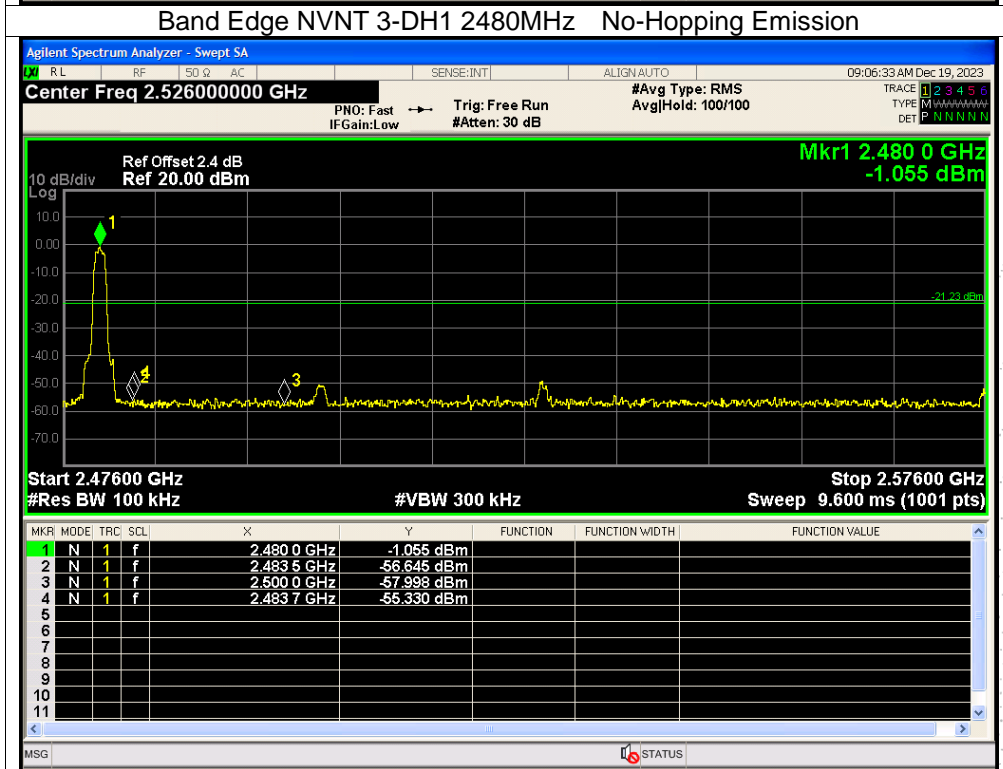
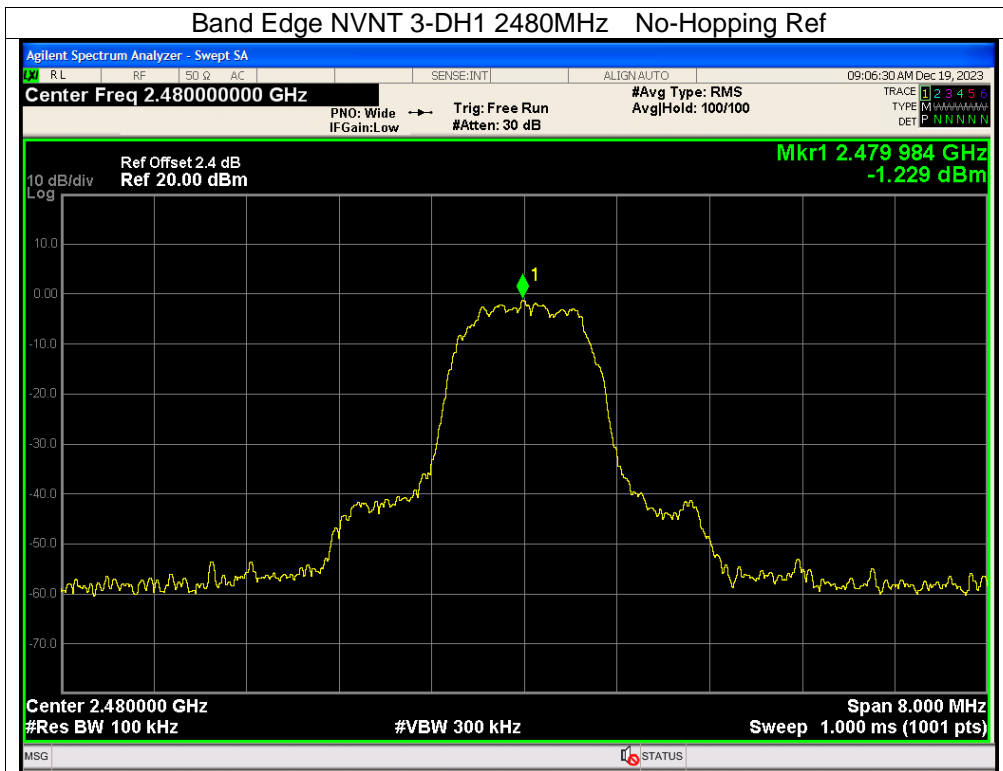

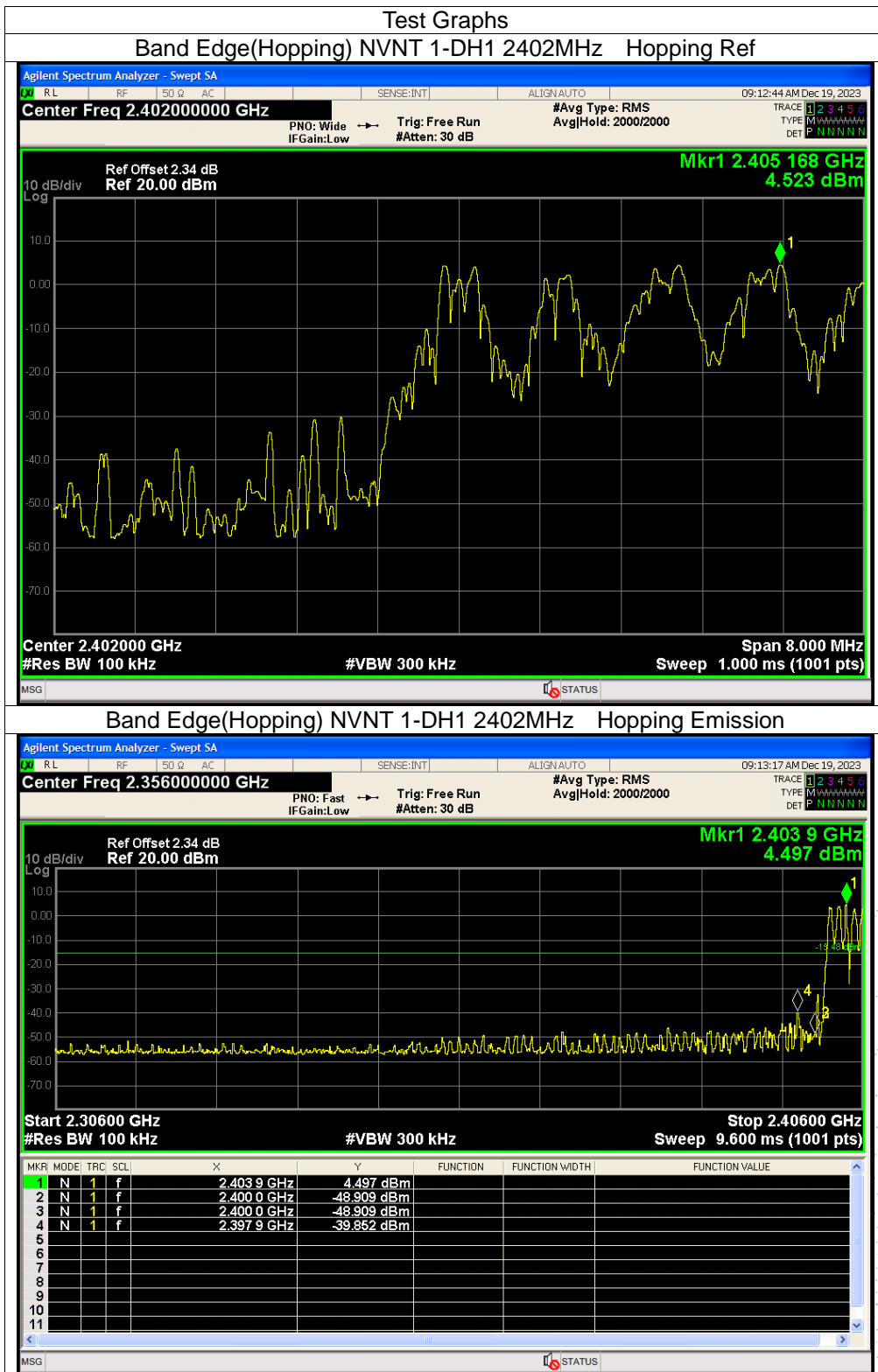

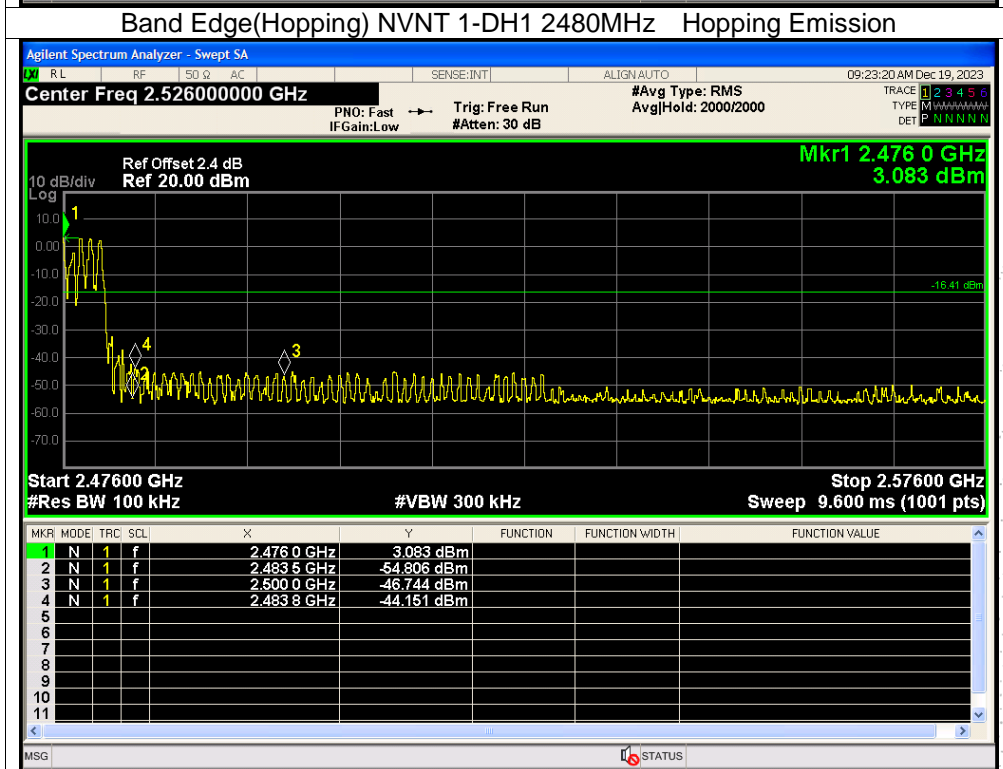
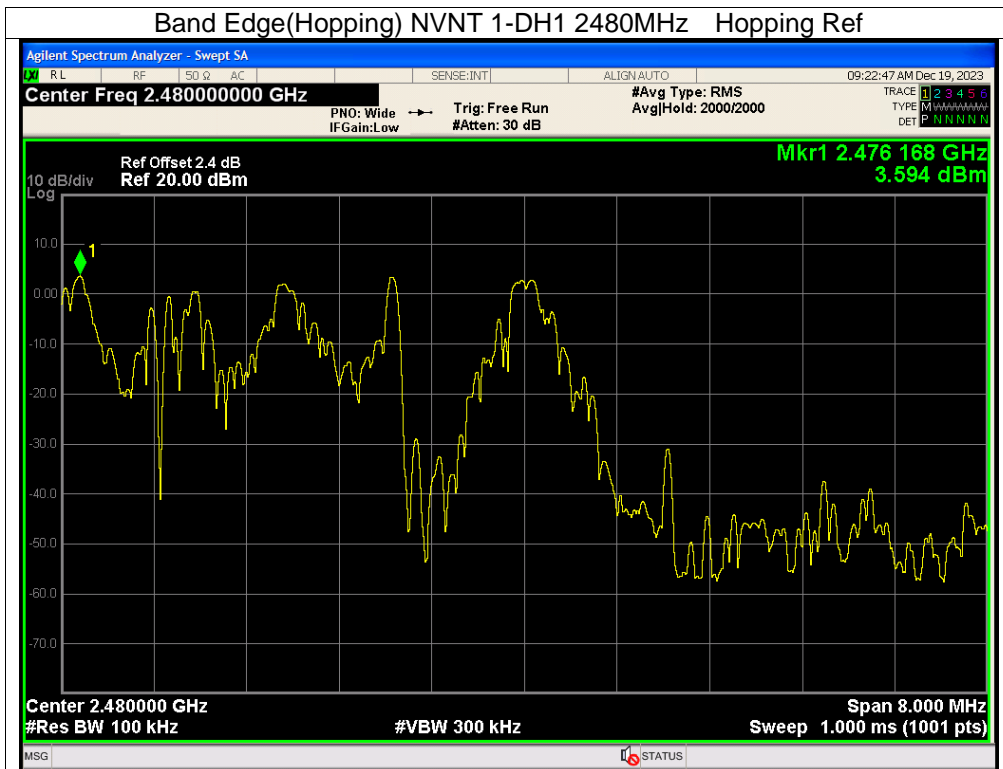

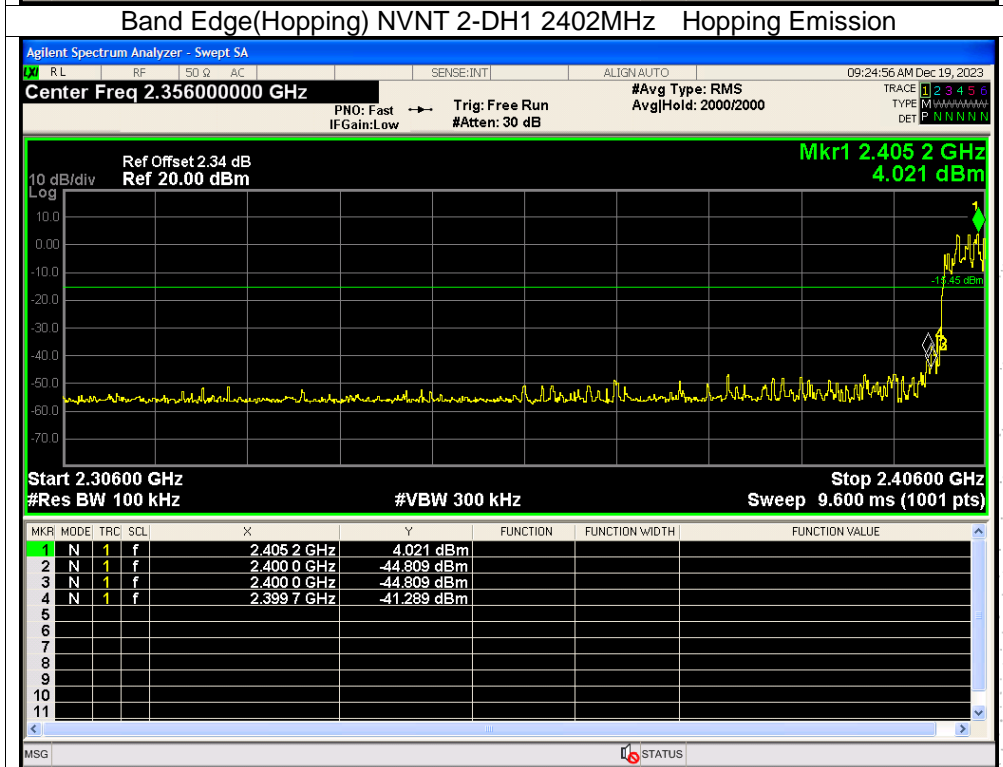
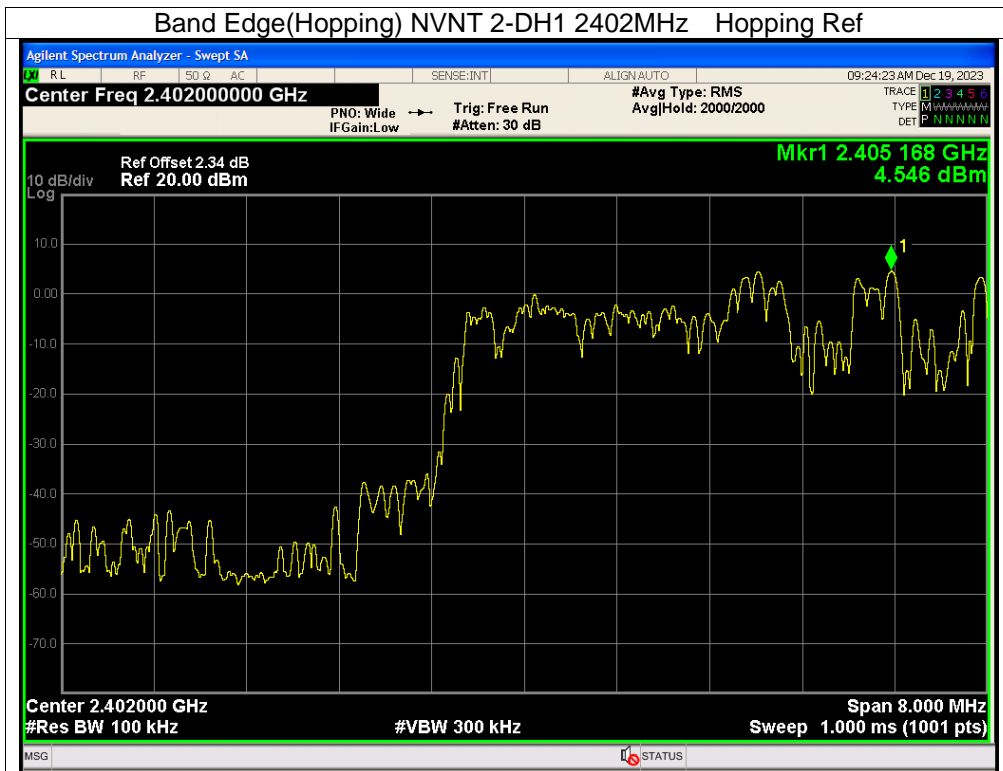

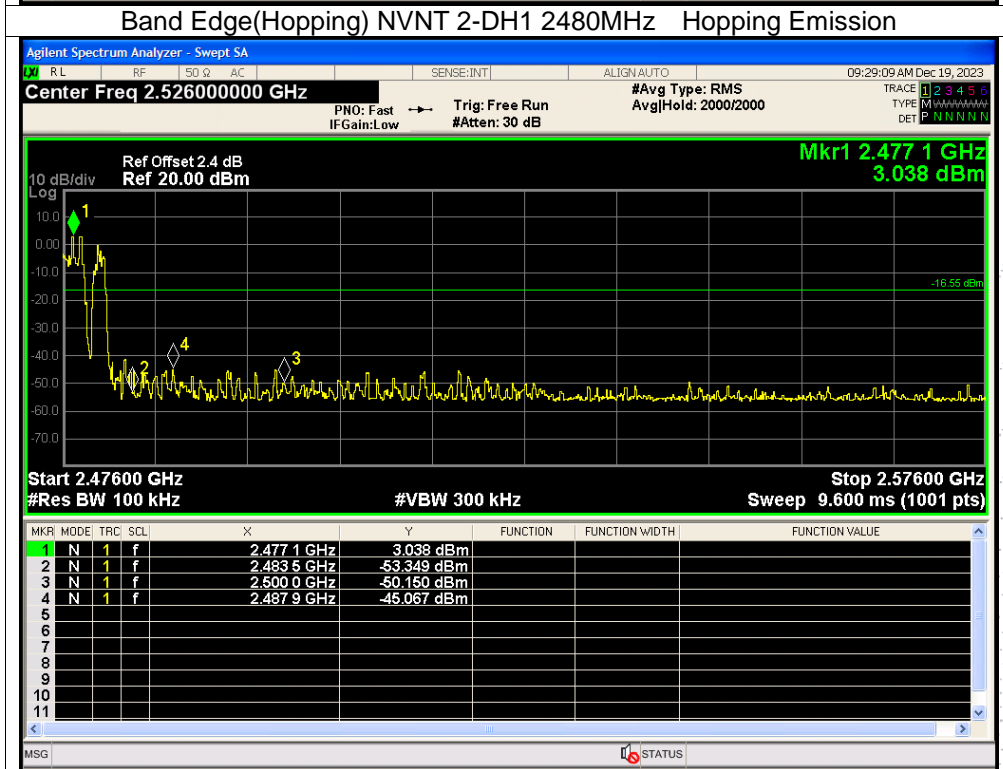
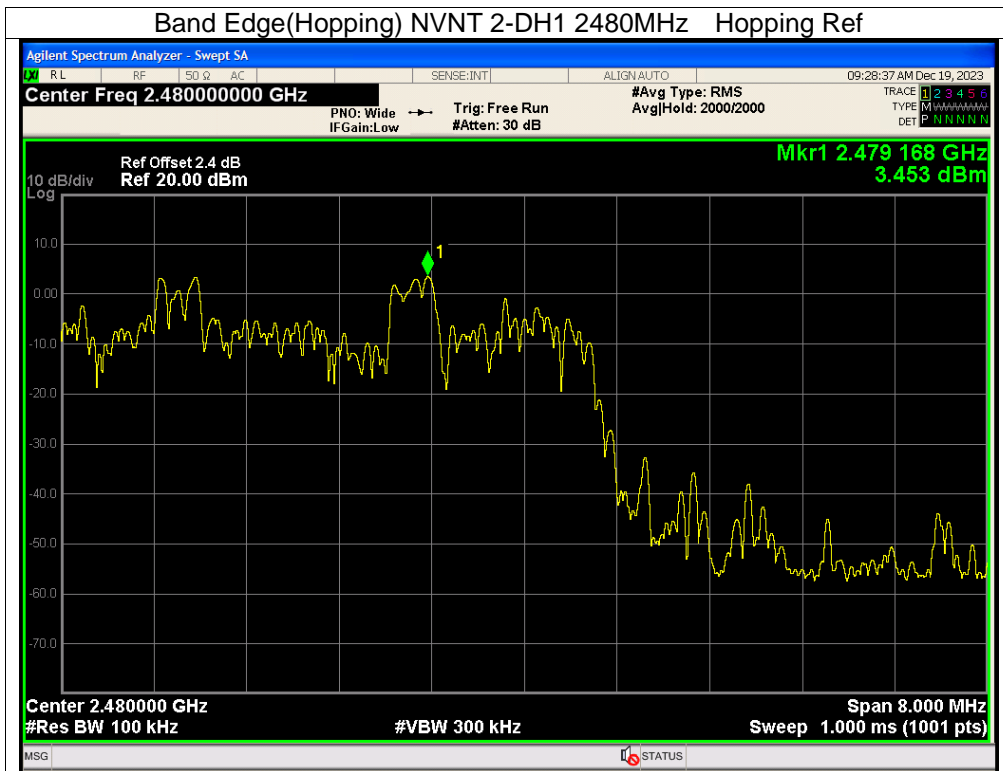

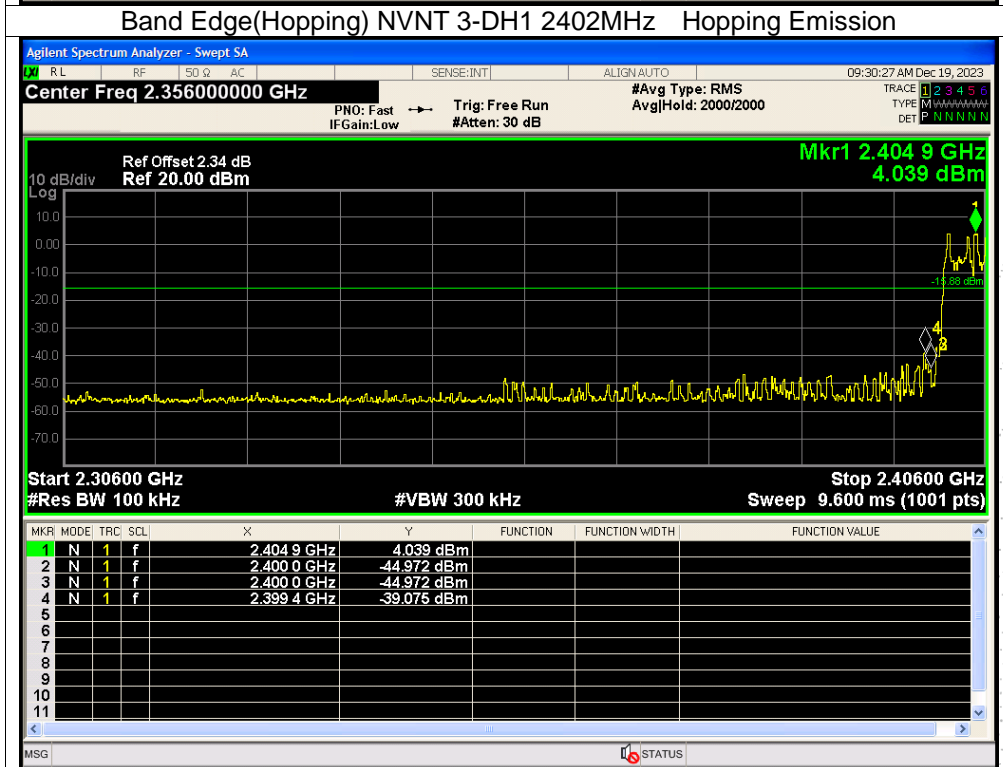
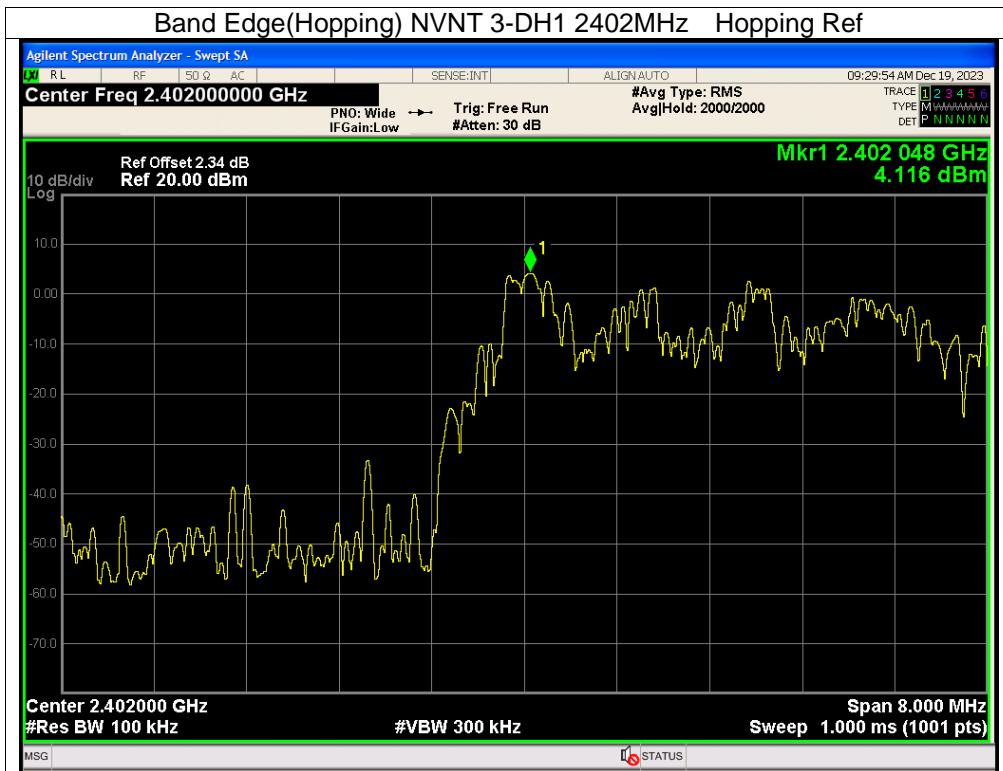

CO., LTD

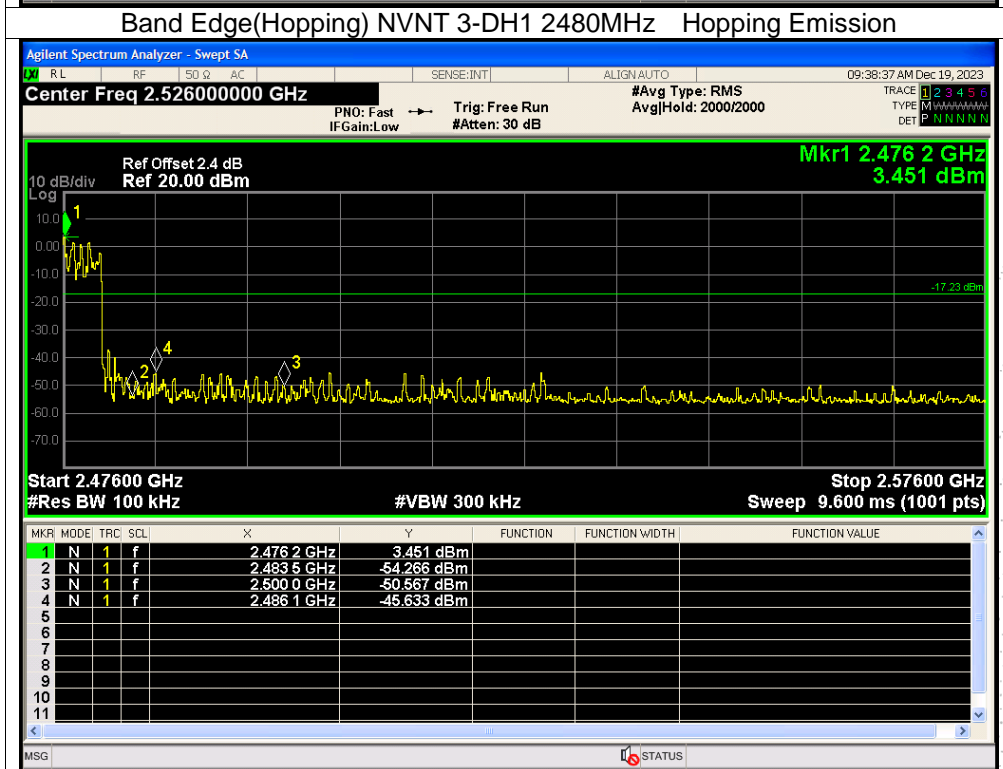
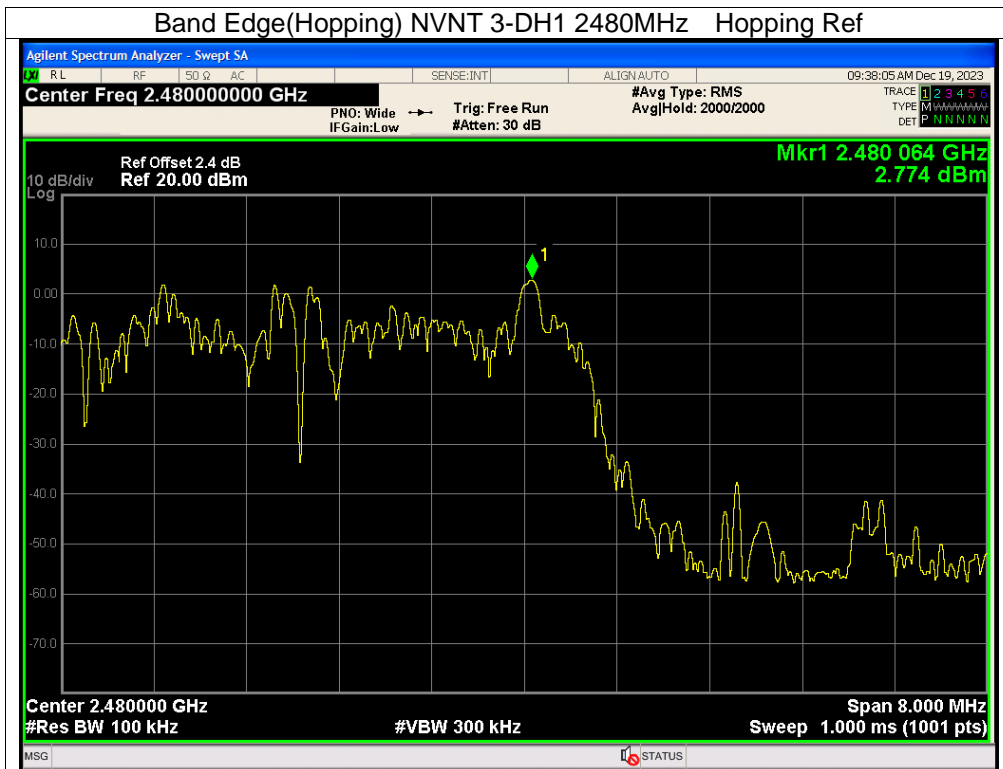

10. 20 dB Bandwidth

10.1 Block Diagram Of Test Setup



10.2 Limit

N/A

10.3 Test procedure

1. Set RBW = 30kHz.
2. Set the video bandwidth (VBW) $\geq 3 \times$ RBW.
3. Detector = Peak.
4. Trace mode = max hold.
5. Sweep = auto couple.
6. Allow the trace to stabilize.
7. Measure the maximum width of the emission that is constrained by the frequencies associated with the two outermost amplitude points (upper and lower frequencies) that are attenuated by 6 dB relative to the maximum level measured in the fundamental emission.

10.4 Test Result

| Condition | Mode | Frequency (MHz) | -20 dB Bandwidth (MHz) | Verdict |
|-----------|-------|-----------------|------------------------|---------|
| NVNT | 1-DH1 | 2402 | 0.936 | Pass |
| NVNT | 1-DH1 | 2441 | 0.954 | Pass |
| NVNT | 1-DH1 | 2480 | 0.946 | Pass |
| NVNT | 2-DH1 | 2402 | 1.356 | Pass |
| NVNT | 2-DH1 | 2441 | 1.361 | Pass |
| NVNT | 2-DH1 | 2480 | 1.364 | Pass |
| NVNT | 3-DH1 | 2402 | 1.346 | Pass |
| NVNT | 3-DH1 | 2441 | 1.344 | Pass |
| NVNT | 3-DH1 | 2480 | 1.342 | Pass |

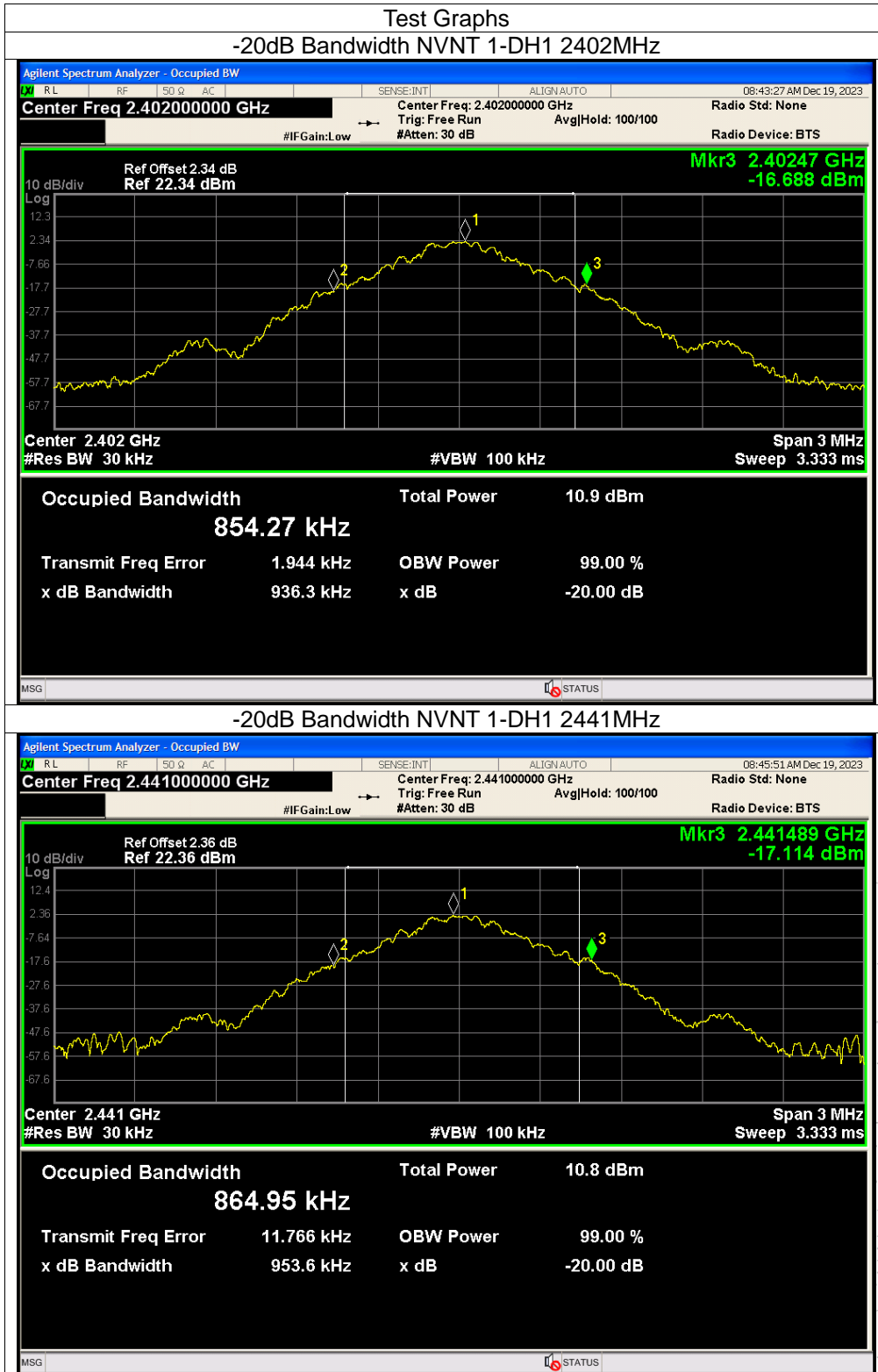

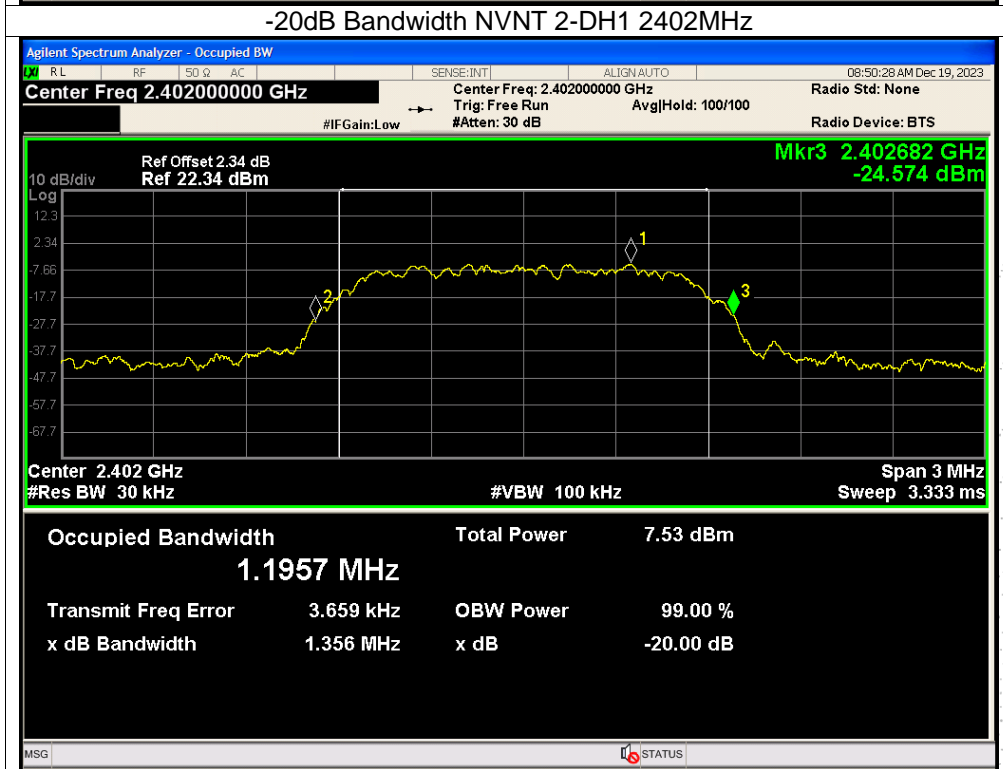
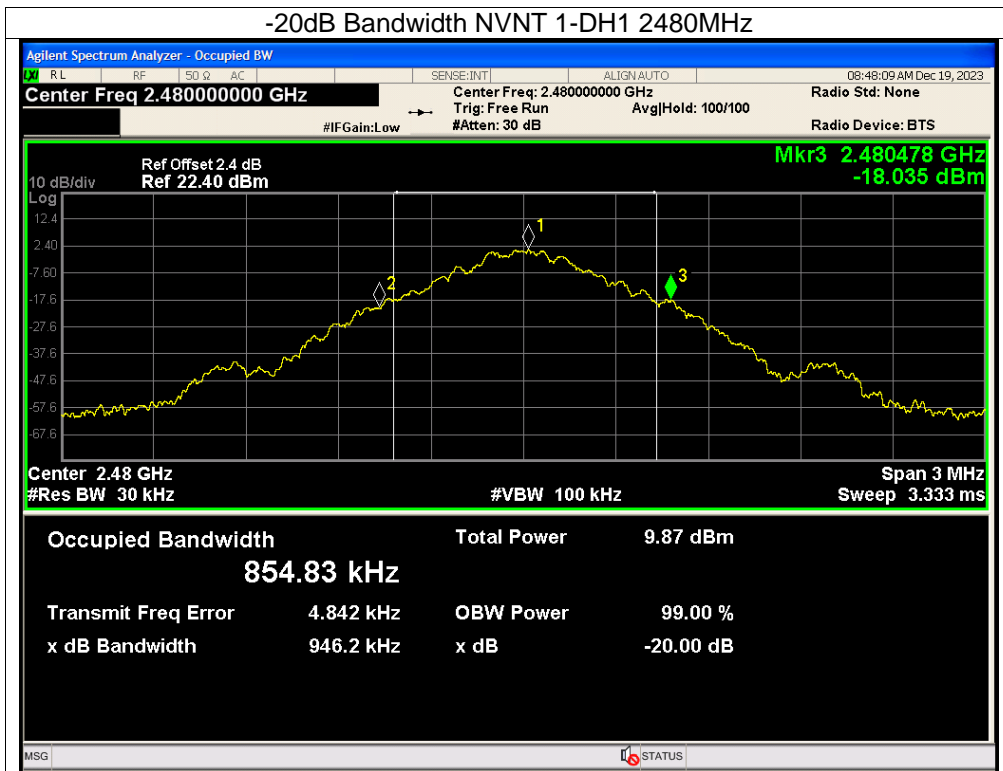

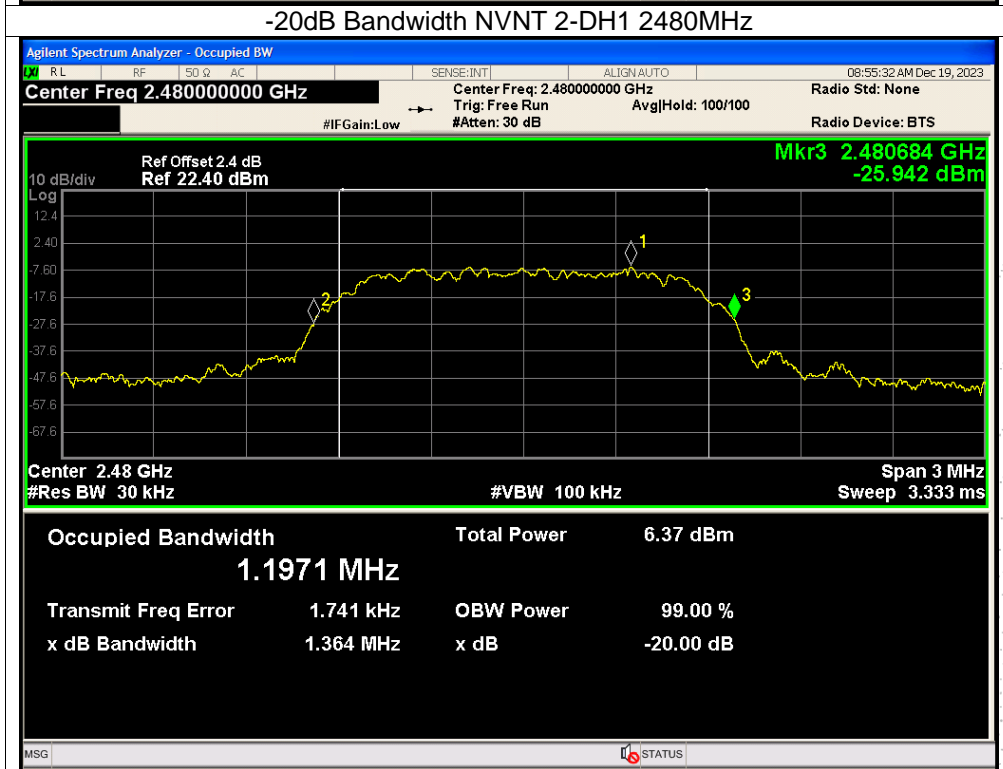
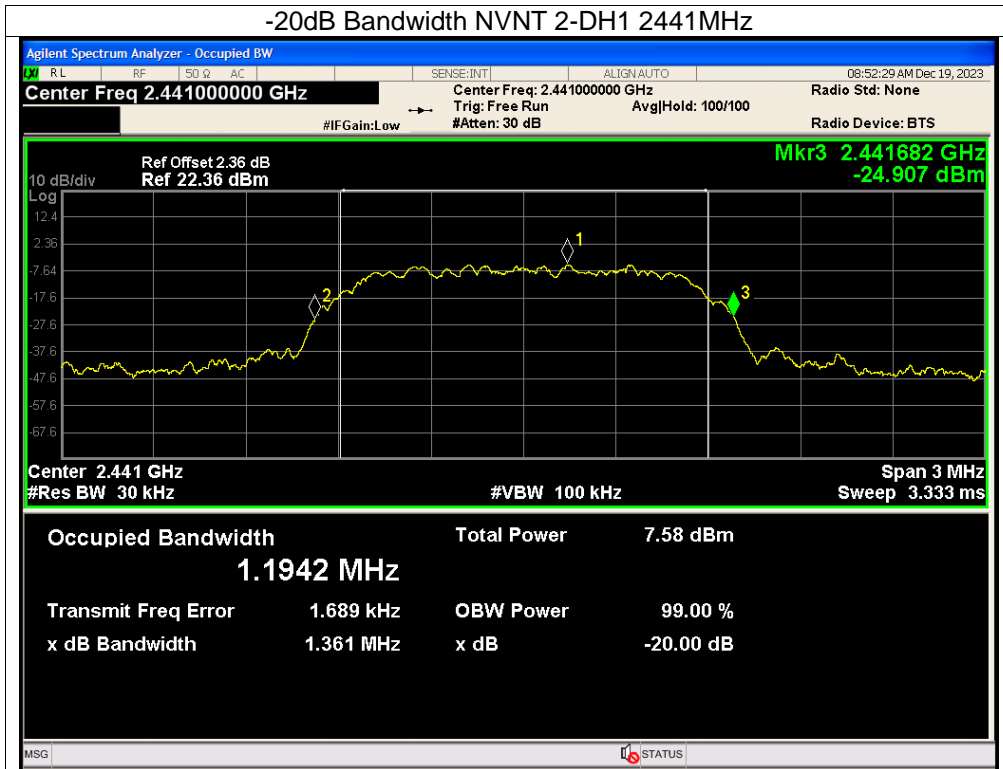

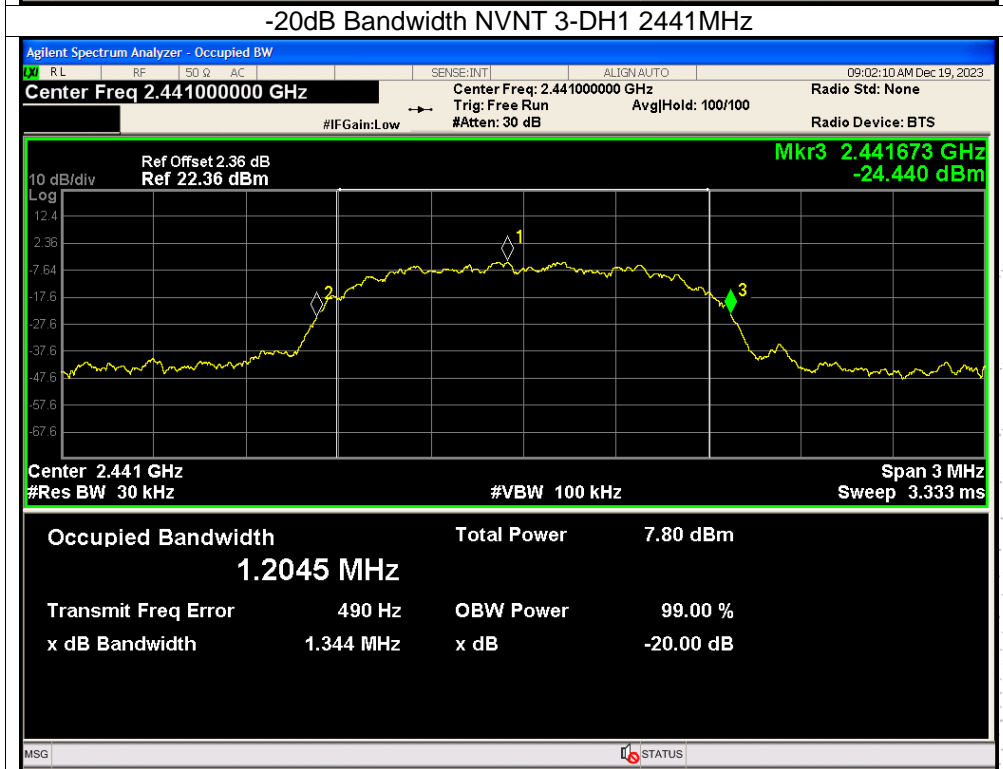
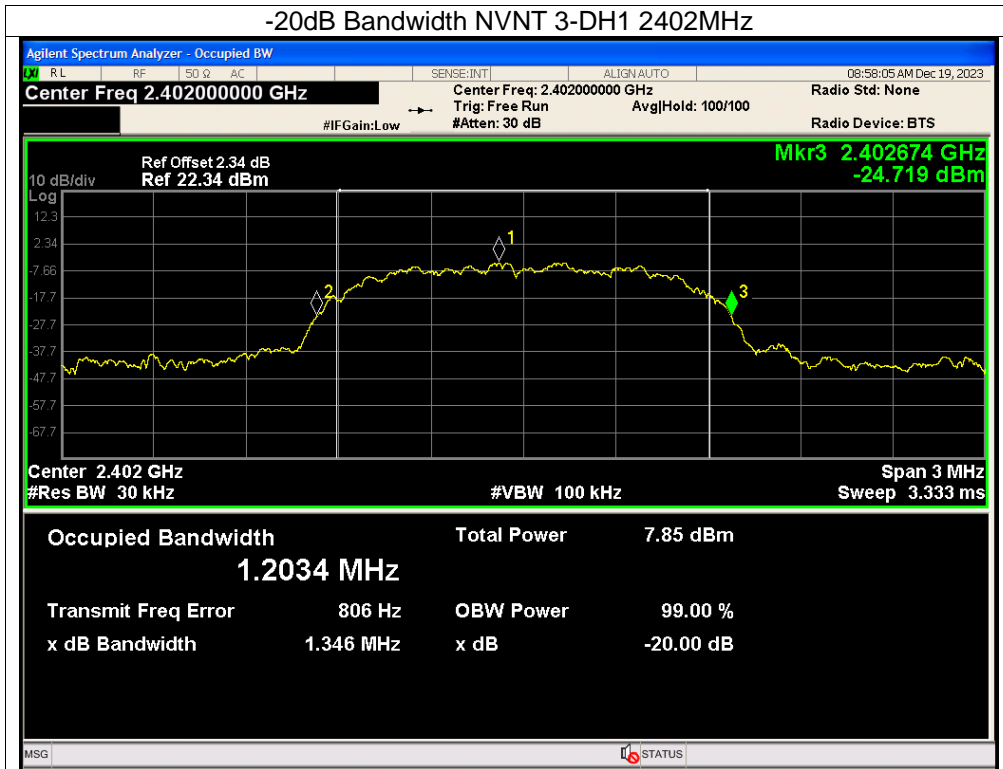

CO., LTD

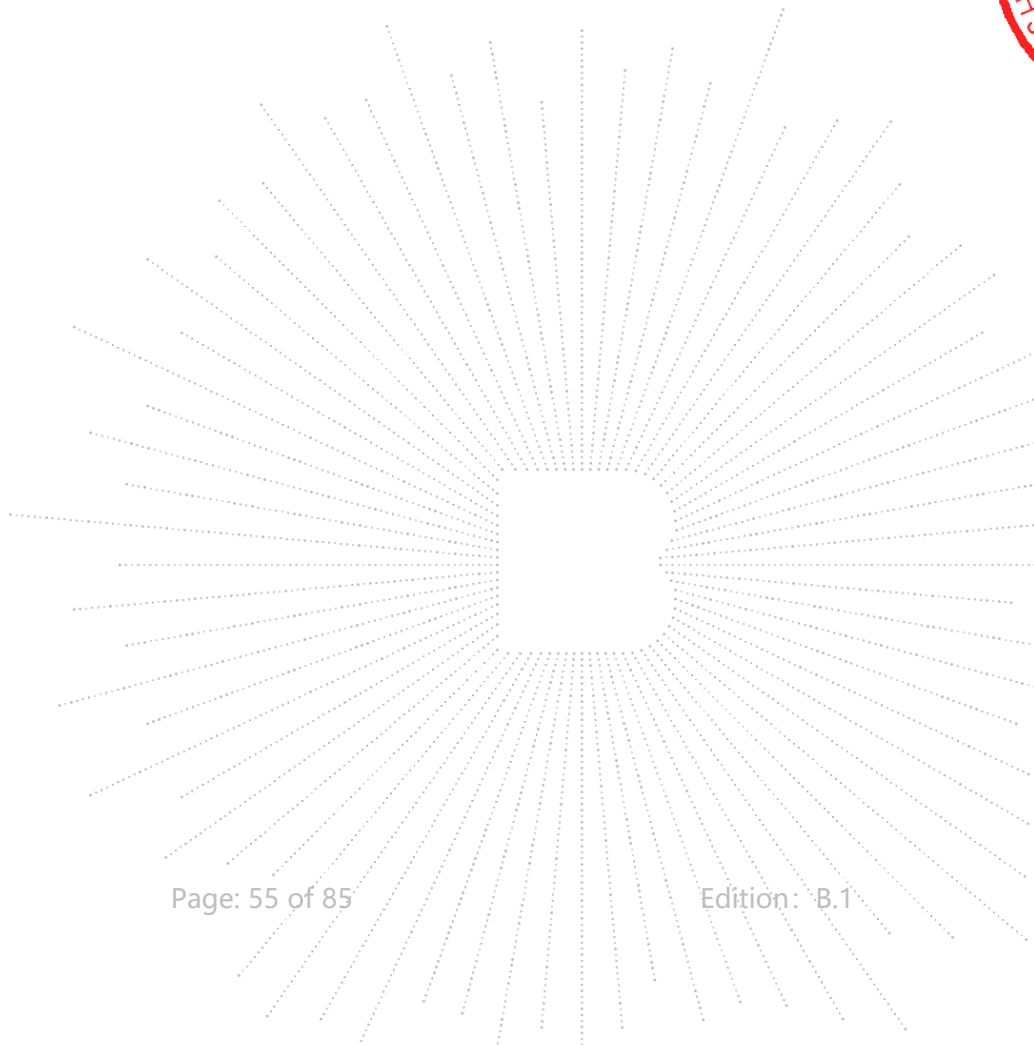
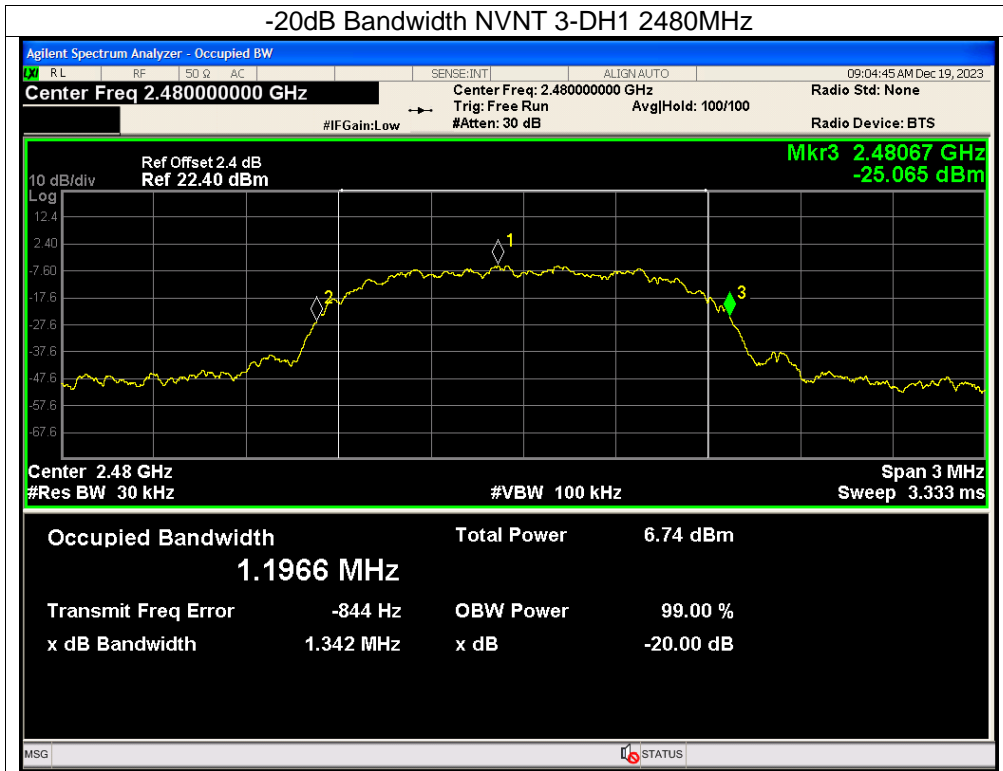

11. Maximum Peak Output Power

11.1 Block Diagram Of Test Setup



11.2 Limit

| FCC Part15 (15.247) , Subpart C | | | | |
|---------------------------------|-------------------|---------------------|-----------------------|--------|
| Section | Test Item | Limit | Frequency Range (MHz) | Result |
| 15.247(b)(1) | Peak Output Power | 0.125 watt or 21dBm | 2400-2483.5 | PASS |

11.3 Test procedure

1. Remove the antenna from the EUT and then connect a low RF cable from the antenna port to the spectrum.
2. Set the spectrum analyzer: RBW = 2MHz. VBW = 6MHz. Sweep = auto; Detector Function = Peak.
3. Keep the EUT in transmitting at lowest, medium and highest channel individually. Record the max value.

11.4 Test Result

| Condition | Mode | Frequency (MHz) | Conducted Power (dBm) | Limit (dBm) | Verdict |
|-----------|-------|-----------------|-----------------------|-------------|---------|
| NVNT | 1-DH1 | 2402 | 4.70 | 21 | Pass |
| NVNT | 1-DH1 | 2441 | 4.64 | 21 | Pass |
| NVNT | 1-DH1 | 2480 | 3.70 | 21 | Pass |
| NVNT | 2-DH1 | 2402 | 4.01 | 21 | Pass |
| NVNT | 2-DH1 | 2441 | 3.99 | 21 | Pass |
| NVNT | 2-DH1 | 2480 | 2.99 | 21 | Pass |
| NVNT | 3-DH1 | 2402 | 4.37 | 21 | Pass |
| NVNT | 3-DH1 | 2441 | 4.28 | 21 | Pass |
| NVNT | 3-DH1 | 2480 | 3.25 | 21 | Pass |



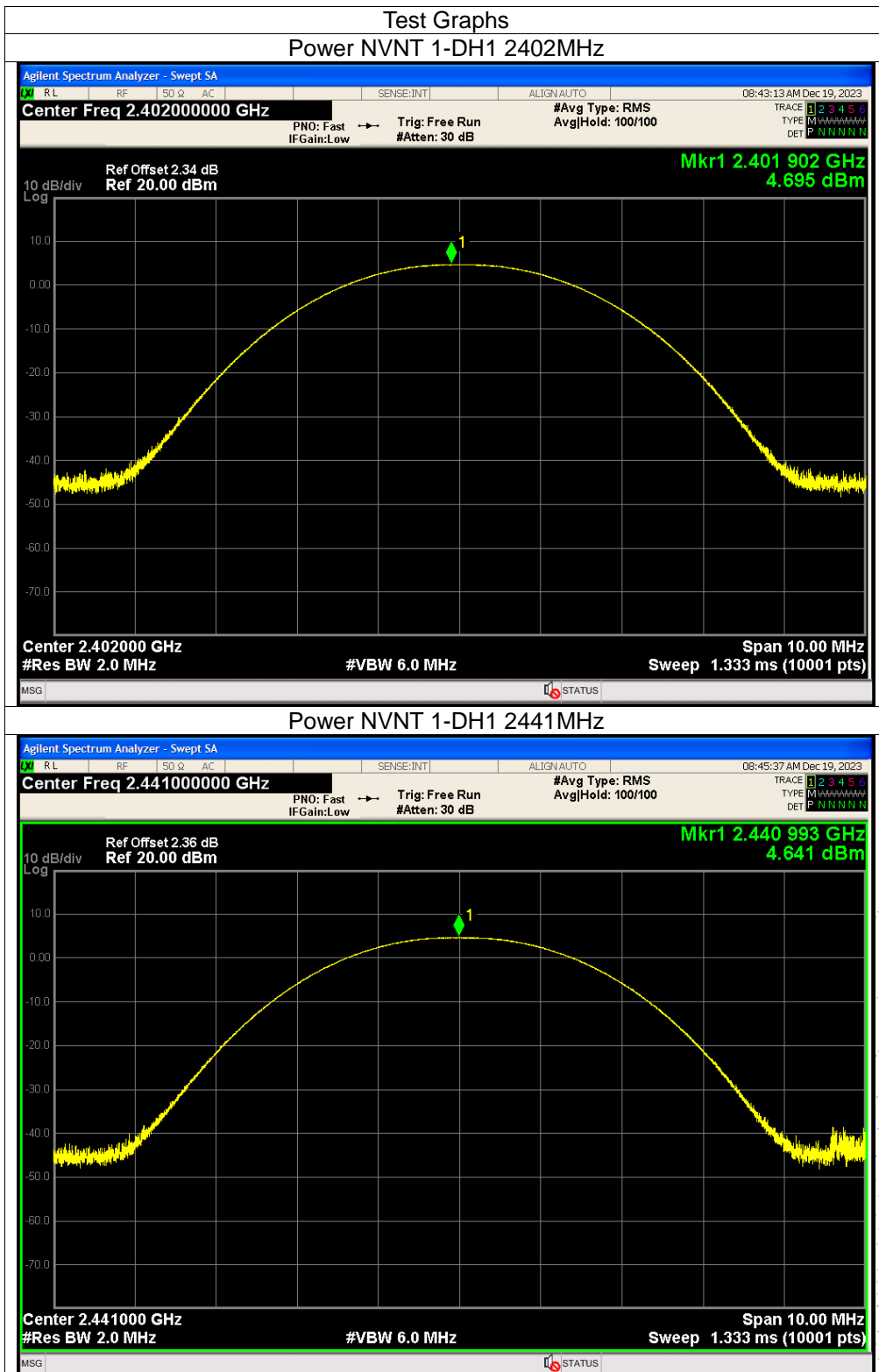

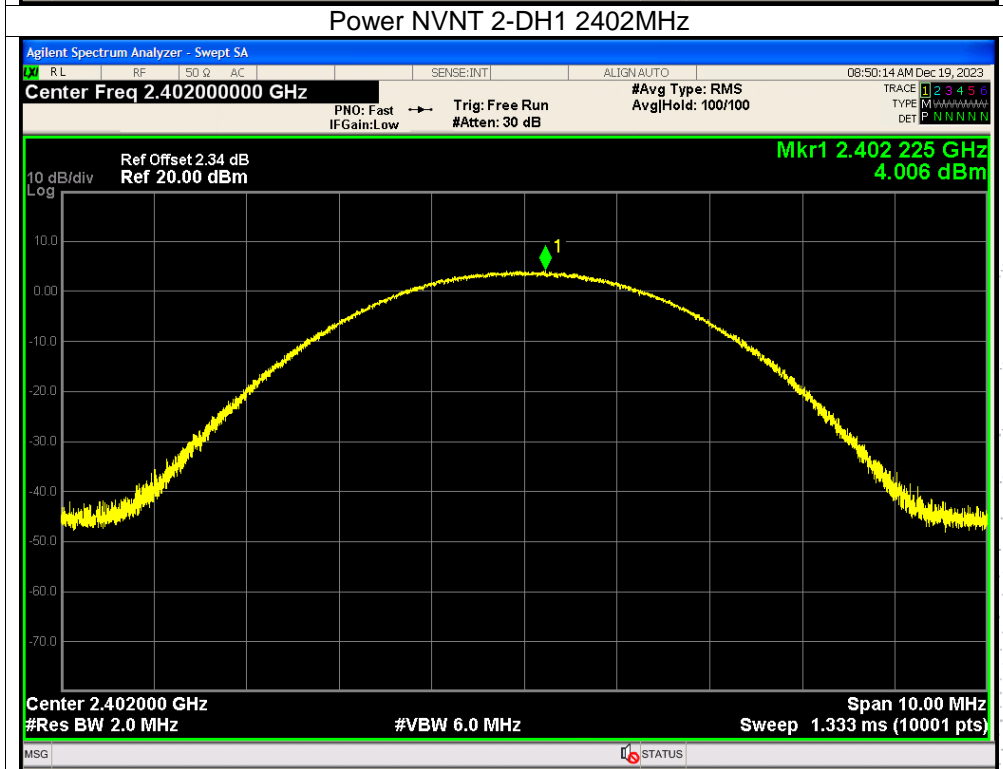
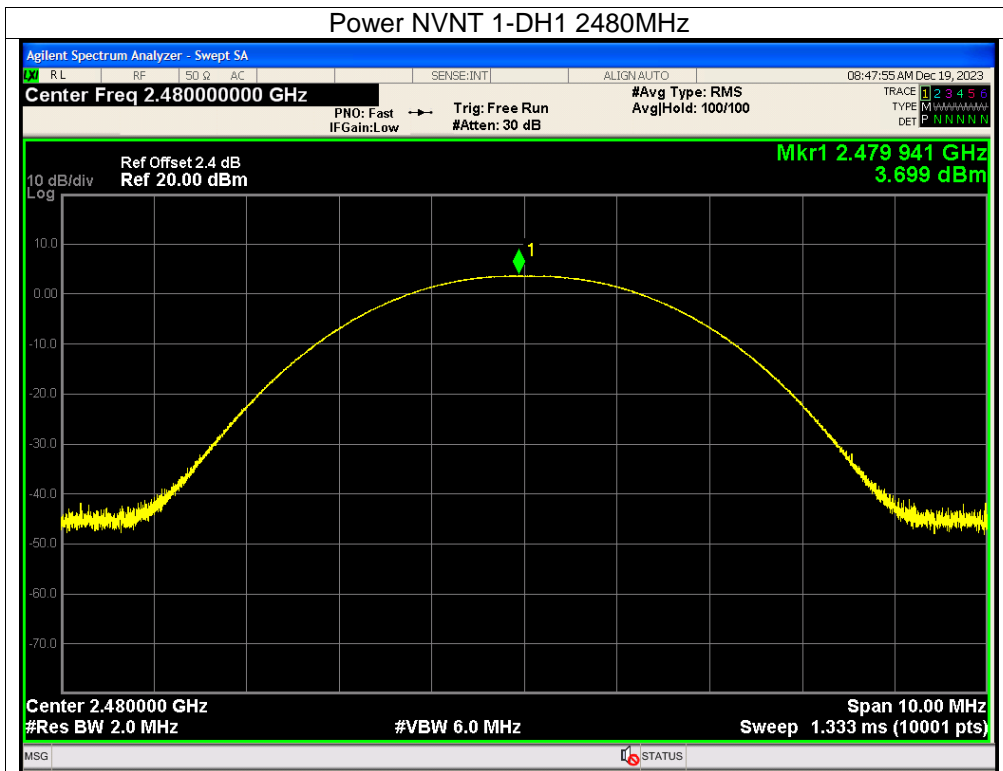

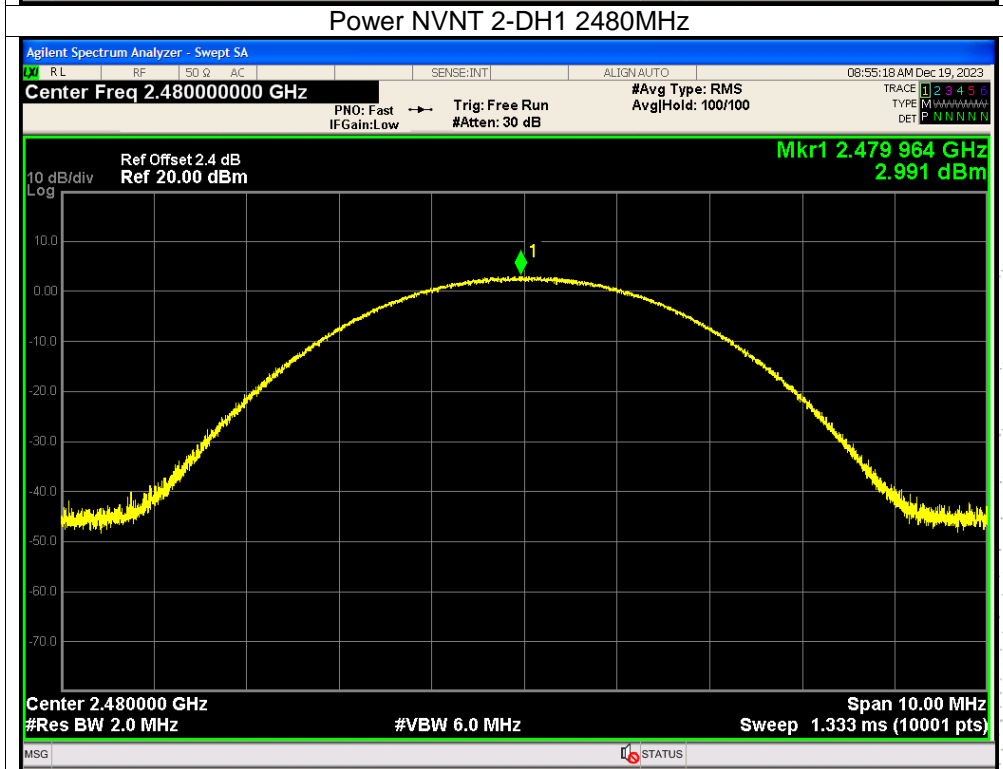
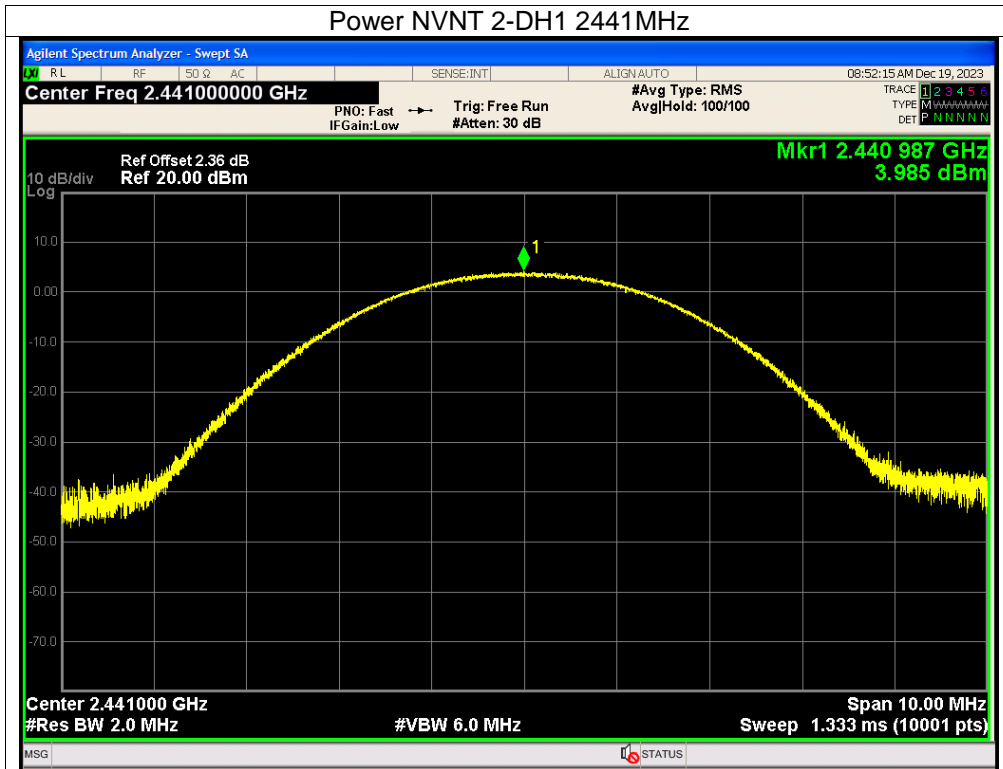

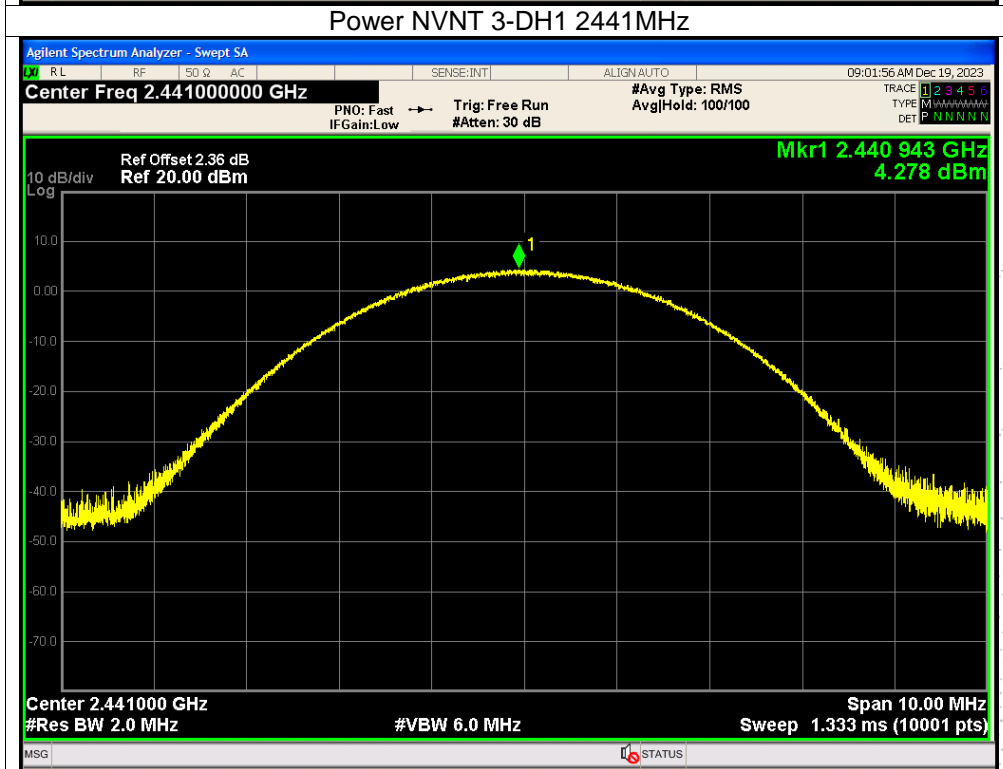
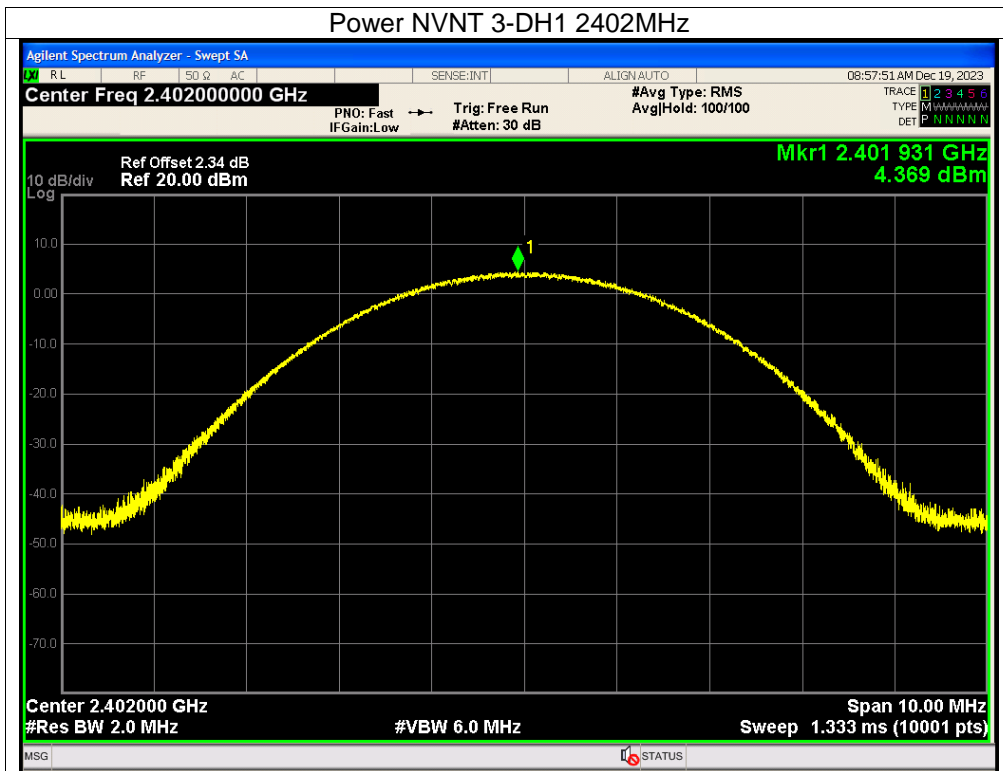

CO., LTD

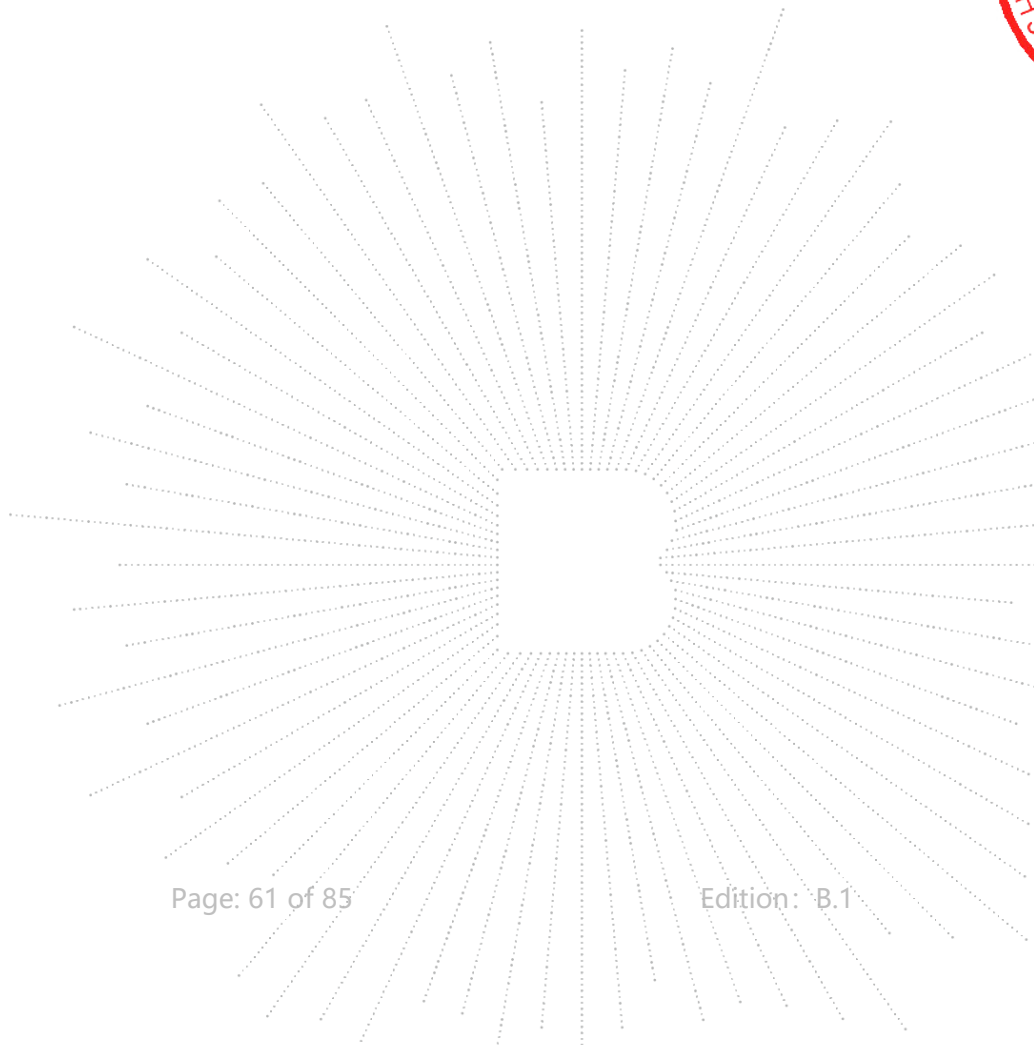
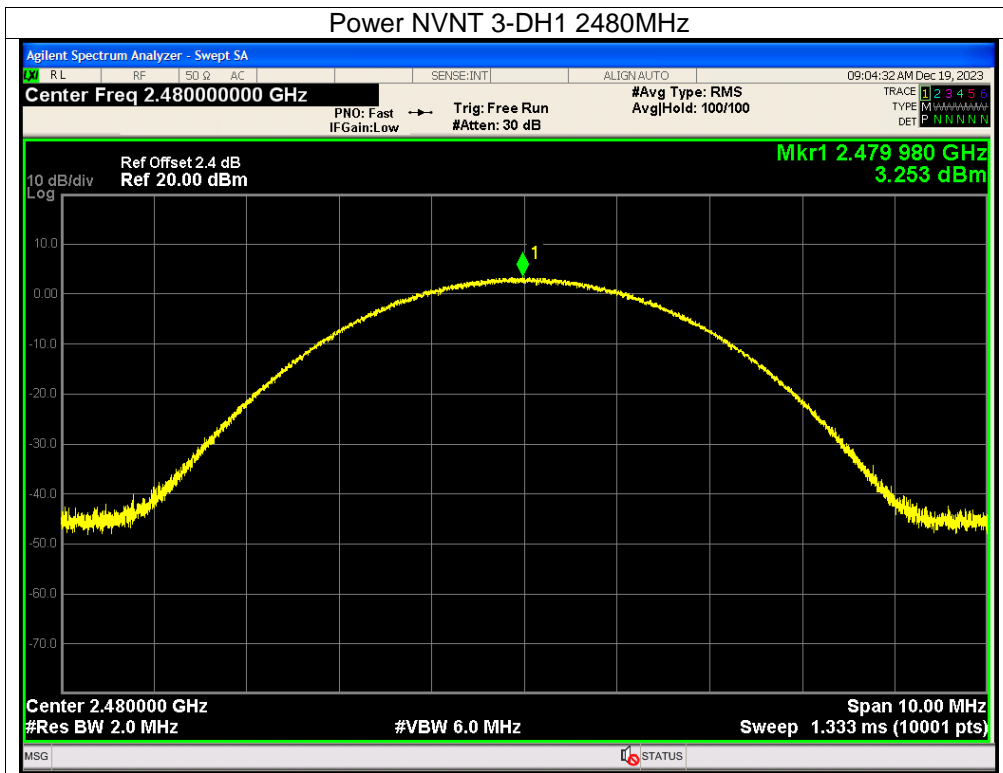

12. Hopping Channel Separation

12.1 Block Diagram Of Test Setup

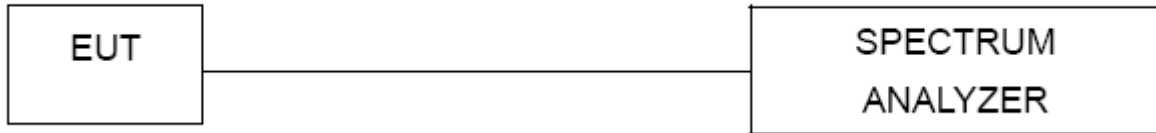

12.2 Limit

Frequency hopping systems shall have hopping channel carrier frequencies separated by a minimum of 25 kHz or the 20 dB bandwidth of the hopping channel, whichever is greater. Alternatively, frequency hopping systems operating in the 2400-2483.5 MHz band may have hopping channel carrier frequencies that are separated by 25 kHz or two-thirds of the 20 dB bandwidth of the hopping channel, whichever is greater, provided the systems operate with an output power no greater than 0.125W.

12.3 Test procedure

1. Remove the antenna from the EUT and then connect a low RF cable from the antenna port to the spectrum.
2. Set the spectrum analyzer: RBW = 30kHz. VBW = 100kHz , Span = 2.0MHz. Sweep = auto; Detector Function = Peak. Trace = Max hold.
3. Allow the trace to stabilize. Use the marker-delta function to determine the separation between the peaks of the adjacent channels. The limit is specified in one of the subparagraphs of this Section Submit this plot.

12.4 Test Result

| Modulation | Test Channel | Separation (MHz) | Limit(MHz) | Result |
|---------------|--------------|------------------|------------|--------|
| GFSK | Low | 1.002 | 0.624 | PASS |
| GFSK | Middle | 0.994 | 0.636 | PASS |
| GFSK | High | 1.002 | 0.631 | PASS |
| $\pi/4$ DQPSK | Low | 1.000 | 0.904 | PASS |
| $\pi/4$ DQPSK | Middle | 0.996 | 0.907 | PASS |
| $\pi/4$ DQPSK | High | 1.002 | 0.909 | PASS |
| 8DPSK | Low | 0.996 | 0.897 | PASS |
| 8DPSK | Middle | 1.002 | 0.896 | PASS |
| 8DPSK | High | 0.998 | 0.895 | PASS |

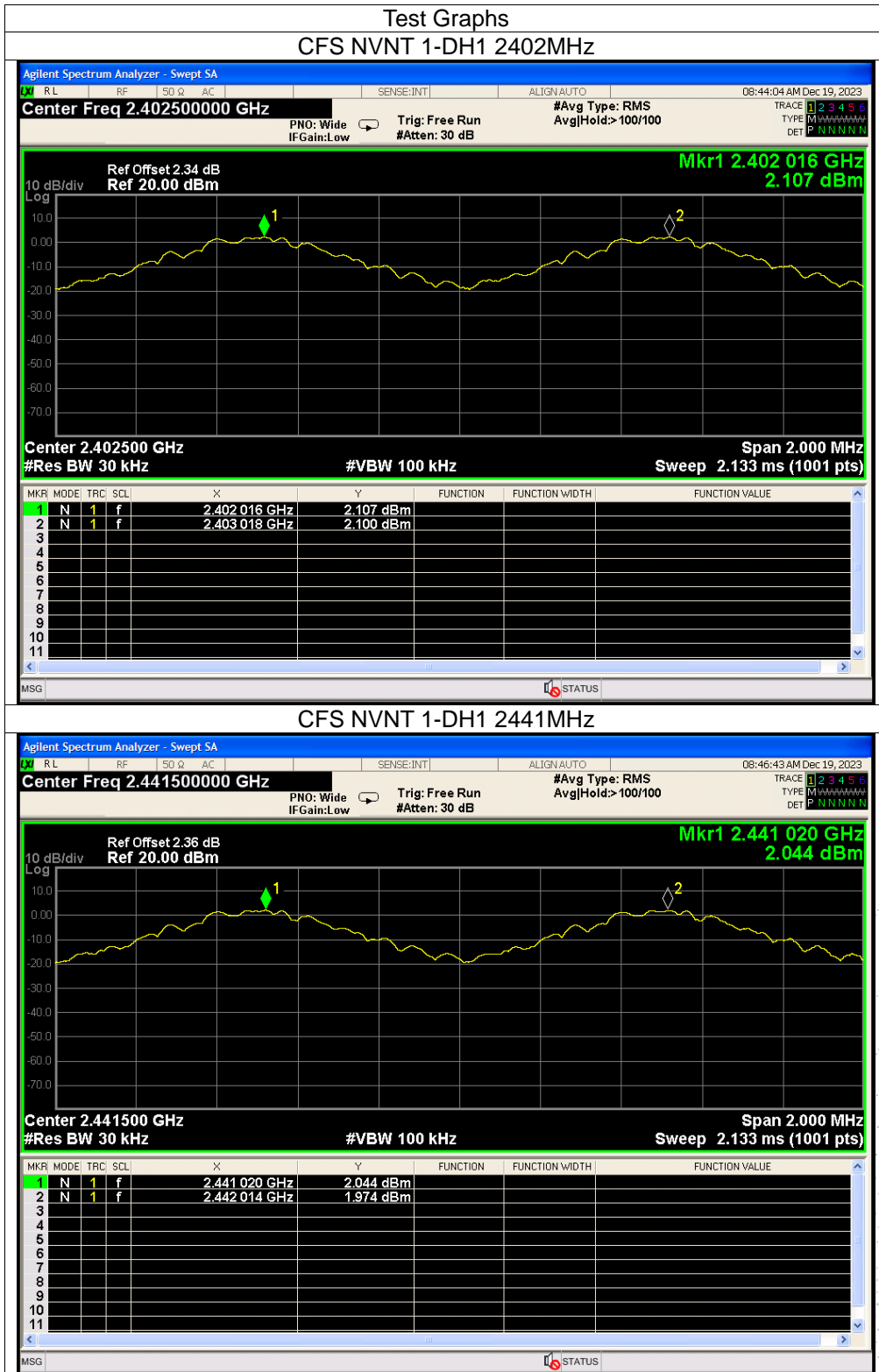

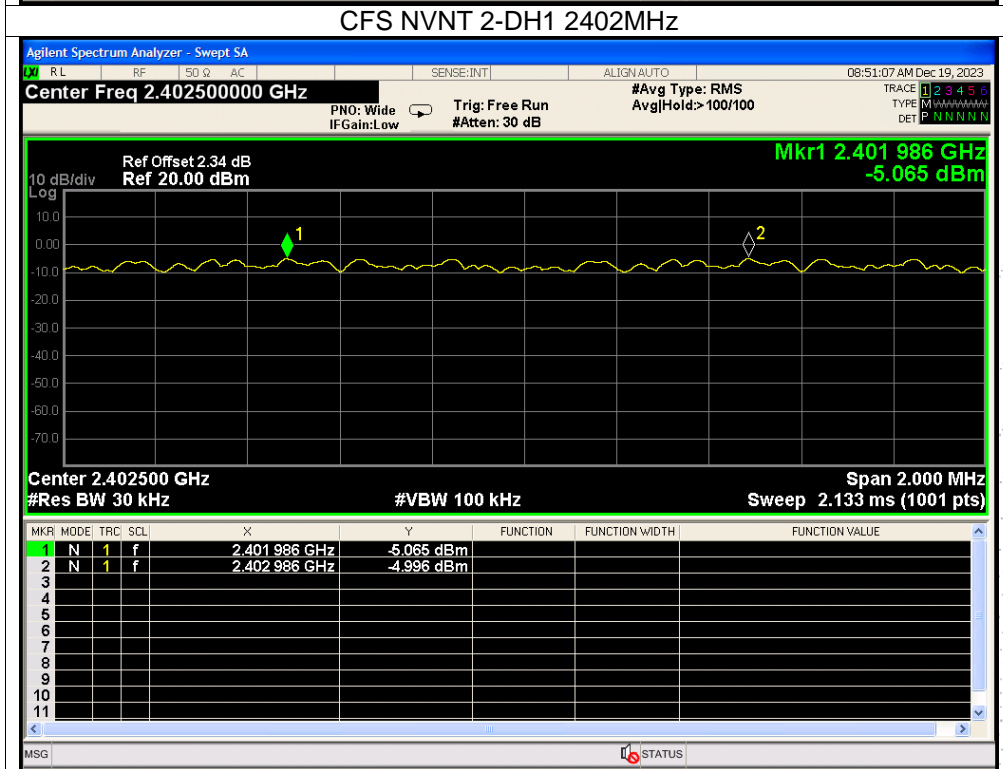
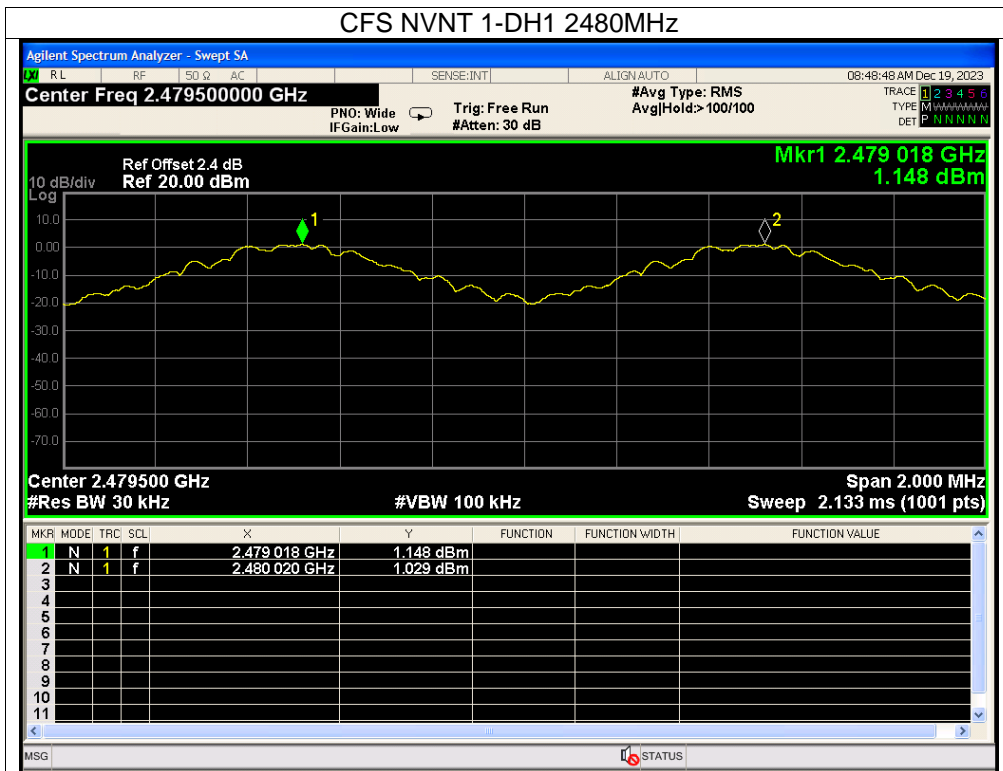

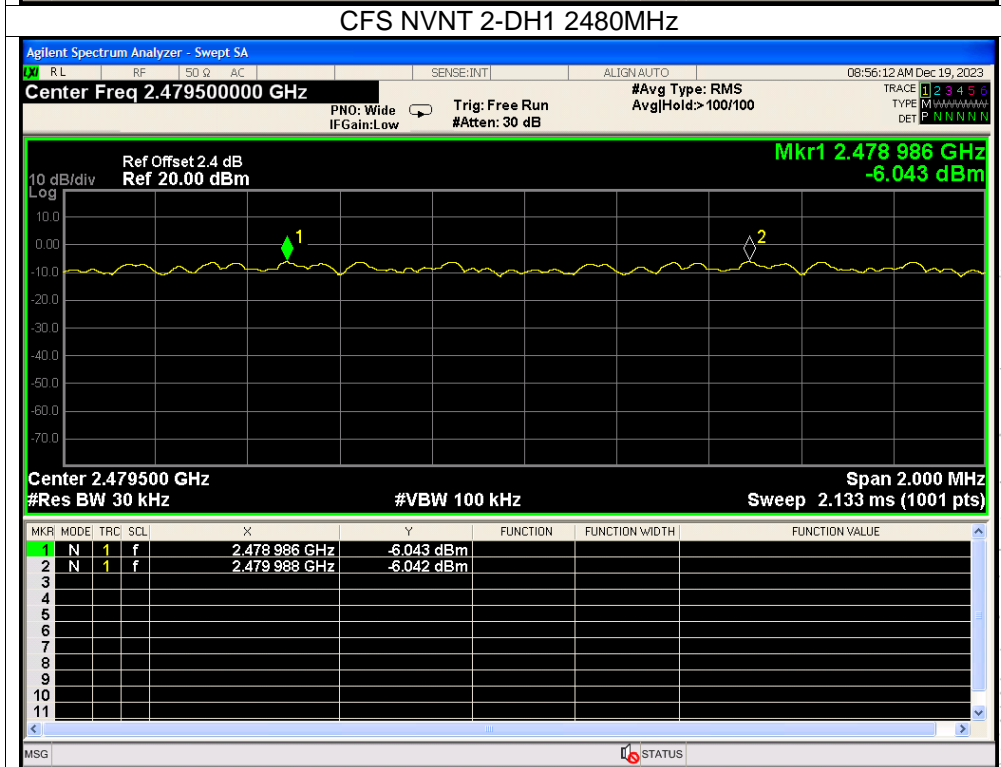
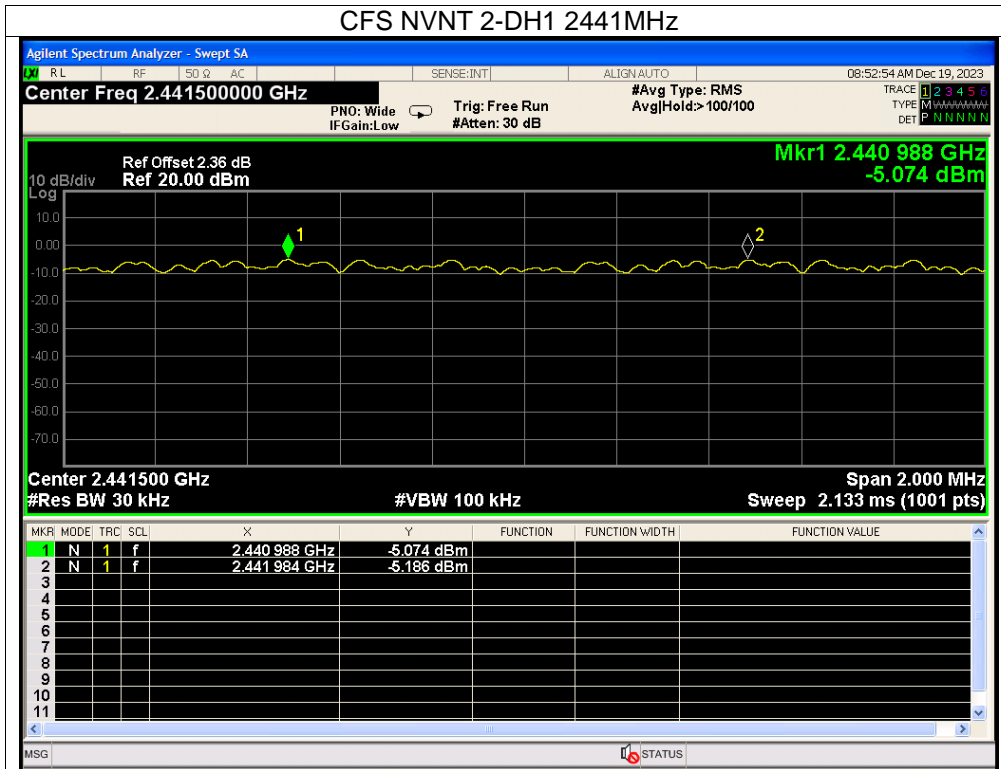

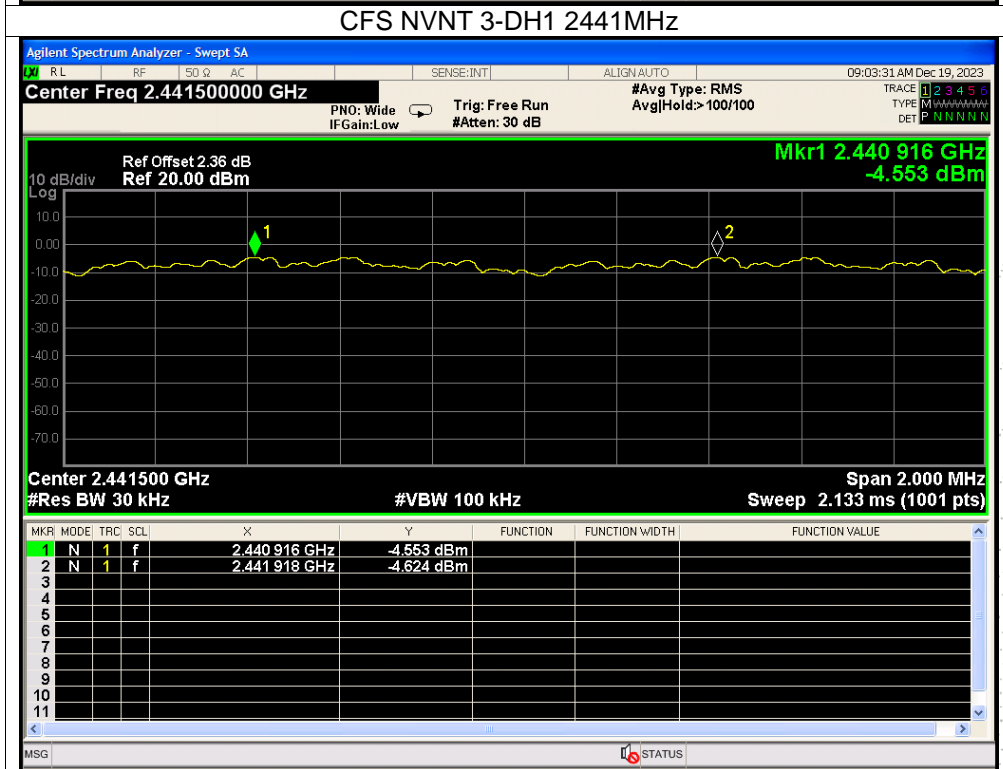
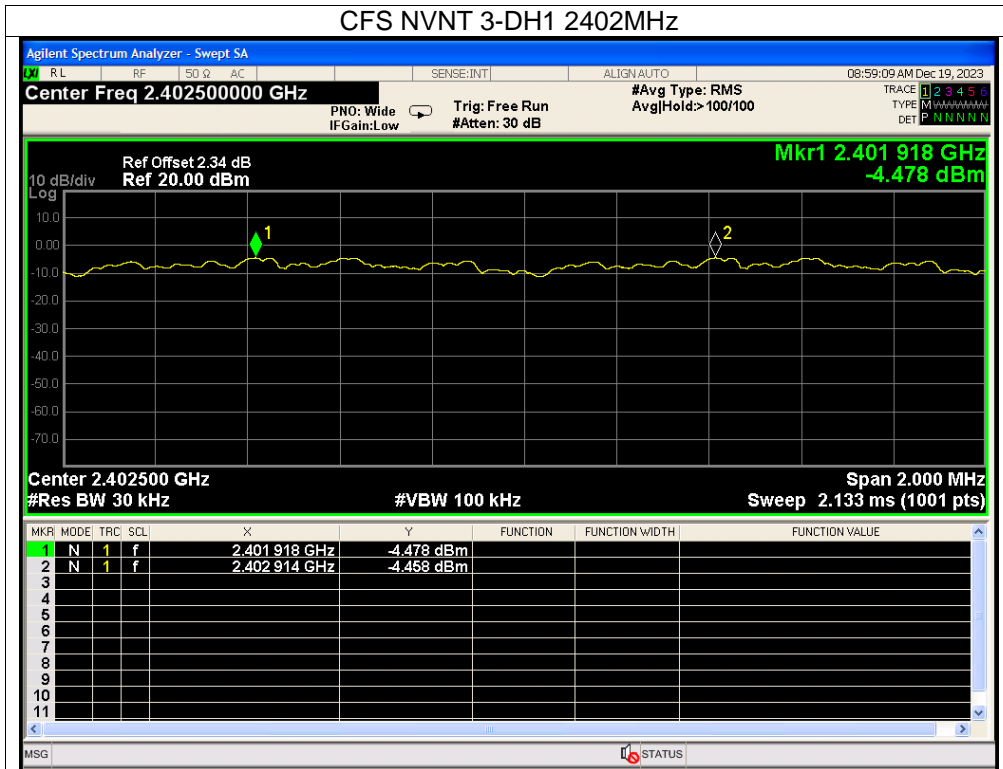

CO., LTD

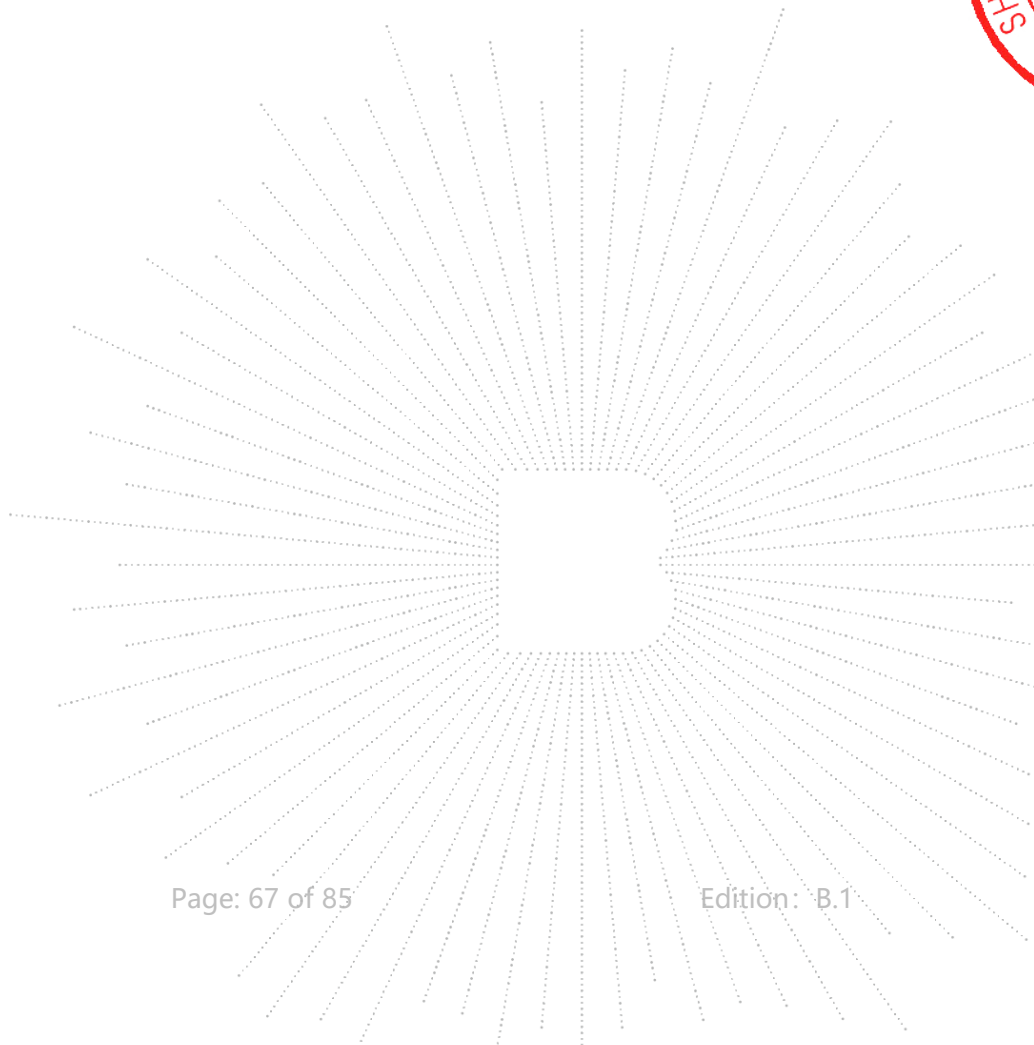
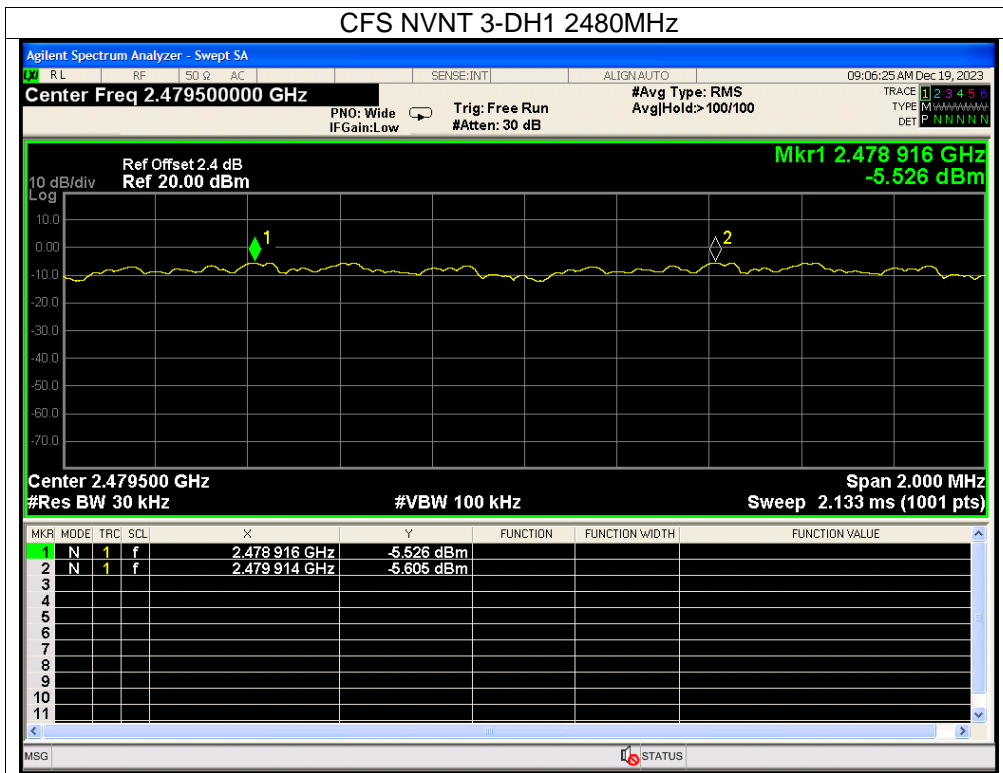

13. Number Of Hopping Frequency

13.1 Block Diagram Of Test Setup



13.2 Limit

Frequency hopping systems in the 2400-2483.5 MHz band shall use at least 15 channels.

13.3 Test procedure

1. Remove the antenna from the EUT and then connect a low RF cable from the antenna port to the spectrum.
2. Set the spectrum analyzer: RBW = 100kHz. VBW = 300kHz. Sweep = auto; Detector Function = Peak. Trace = Max hold.
3. Allow the trace to stabilize. It may prove necessary to break the span up to sections. in order to clearly show all of the hopping frequencies. The limit is specified in one of the subparagraphs of this Section.
4. Set the spectrum analyzer: Start Frequency = 2.4GHz, Stop Frequency = 2.4835GHz. Sweep=auto;

13.4 Test Result

| Condition | Mode | Hopping Number | Limit | Verdict |
|-----------|-------|----------------|-------|---------|
| NVNT | 1-DH1 | 79 | 15 | Pass |
| NVNT | 2-DH1 | 79 | 15 | Pass |
| NVNT | 3-DH1 | 79 | 15 | Pass |



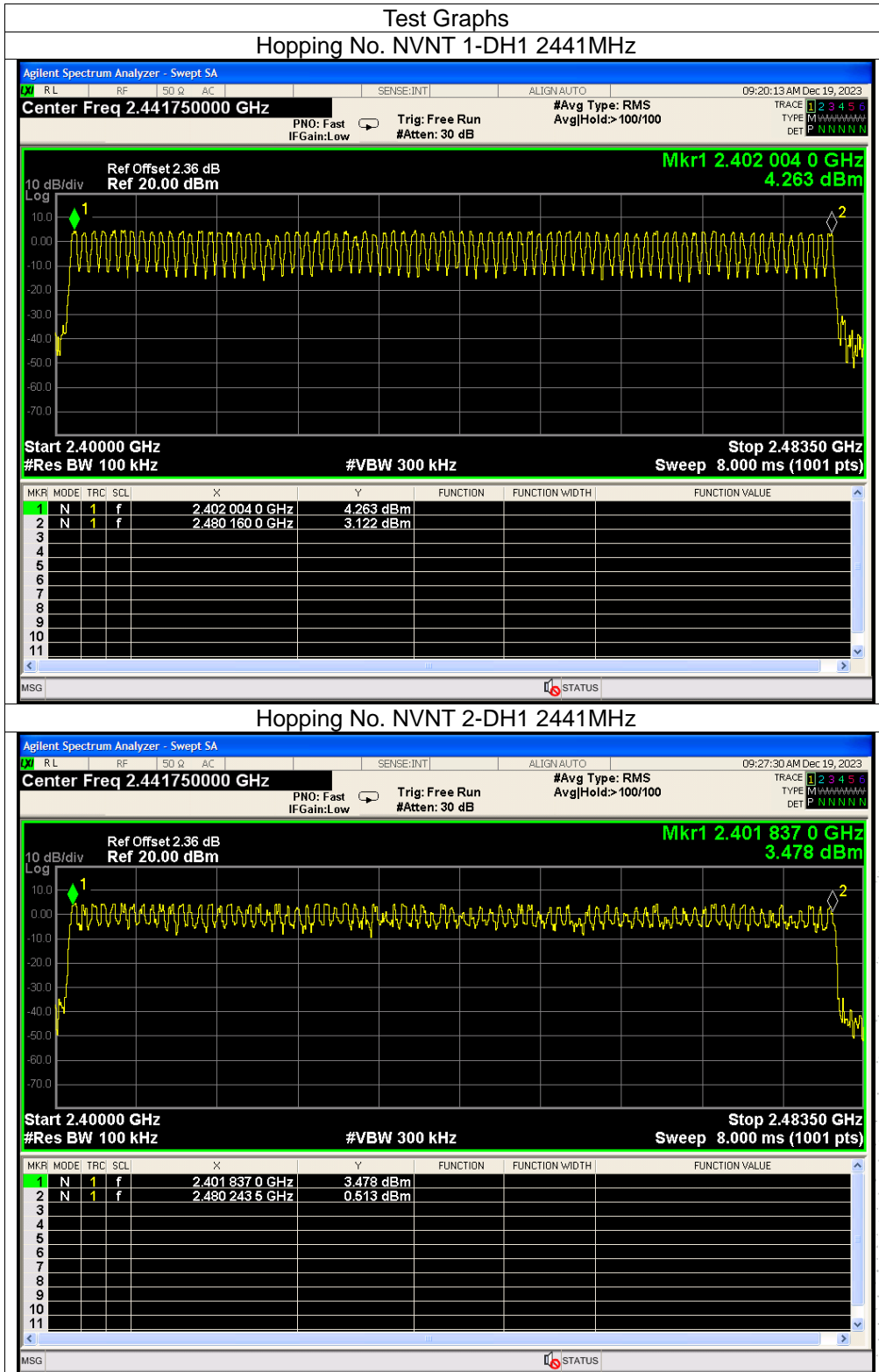

TEST
TC
OVERD
t Seal

