



CJR620WHBY

User Manual

Mini Portable Home Theater Projector

Table of Contents

Read Before Use	2
Features and Inputs	4
Remote	5
Attaching the Handle	6
Powering On/Off Your Device	7
Distance	7
Projector Placement	8
Adjusting the Focus	10
Connecting to Other Devices	11
Sub Menus	15
Projector Menus	16
Troubleshooting	18
Specifications	19
Need Help?	20
Warranty Information	20

In the Box

- Projector
- Remote
- Power Adapter
- User Manual
- Quick Start Guide
- Warranty Card

Read Before Use

- Read instructions carefully.
- Install in accordance with manufacturer's instructions.
- Do not use device near water.
- Clean only with dry cloth.
- Do not block any ventilation openings.
- Do not install near any heat sources such as radiators, stoves, or other units (including amplifiers) which produce heat.
- Protect the power cord from being walked on or pinched, especially at plugs or where they exit from the device.
- Only use attachments/accessories specified by the manufacturer.
- Unplug device during lightning storms or when unused for long periods of time.
- Refer all servicing to qualified service personnel. Servicing is required when device has been damaged in the event that: the power supply cord or plug has been damaged, liquid is spilled on device, object(s) fall on device, device has been exposed to rain or moisture, device has been dropped, or the device does not operate normally.
- Use device only with a cart, stand, tripod, bracket, or table specified by the manufacturer or sold with the device. When a cart is used, use caution when moving the combination of cart and device to avoid injury from tip-over.
- Do not look directly into the projector light or touch the projector lens.
- The power cord is used to connect the device and should remain plugged in while in operation. To disconnect the power cord from device, the unit should first be unplugged from the wall outlet.
- Caution and marking information is located at the bottom of the device.

CAUTION: Use of controls or adjustments or performance of procedures other than those specified may result in hazardous radiation exposure.

Read Before Use

WARNING:

- Shock hazard - do not open the device.
- To reduce the risk of fire or electric shock, do not expose this device to rain, moisture, dripping, or splashing.
- Objects filled with liquids, such as vases, should not be placed on the device.

NOTE: This equipment has been tested and found to comply with the limits for a Class B digital device, pursuant to Part 15 of the FCC Rules. These limits are designed to provide reasonable protection against harmful interference in a residential installation. This equipment generates, uses, and can radiate radio frequency energy and, if not installed and used in accordance with the instructions, may cause harmful interference to radio communications. However, there is no guarantee that interference will not occur in a particular installation. If this equipment does cause harmful interference to radio or television reception, which can be determined by turning the equipment off and on, the user is encouraged to try to correct the interference by one or more of the following measures:

- Reorient or relocate the receiving antenna.
- Increase the separation between the equipment and receiver.
- Connect the equipment into an outlet on a circuit different from that to which the receiver is connected.
- Consult the dealer or an experienced radio/TV technician for help.

Changes or modifications to this unit not expressly authorized by the party responsible for compliance could void the user's authority to operate the equipment.



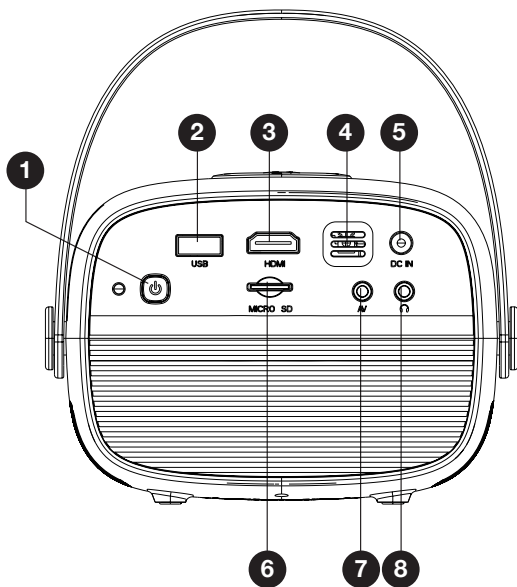
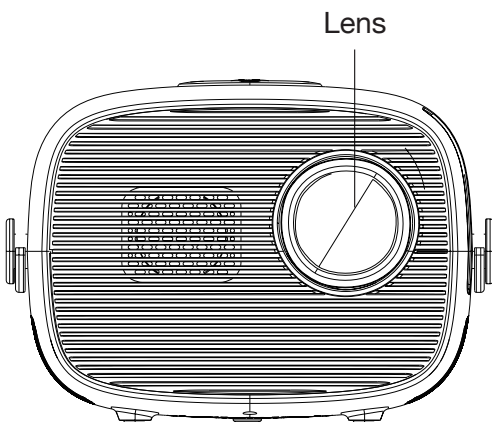
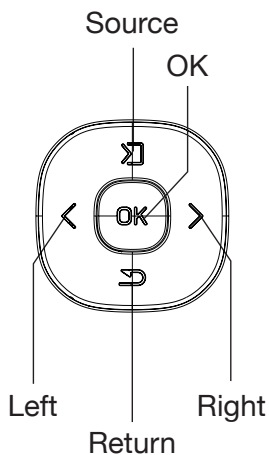
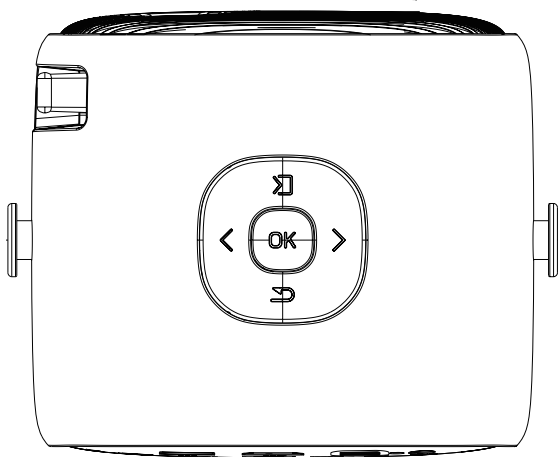





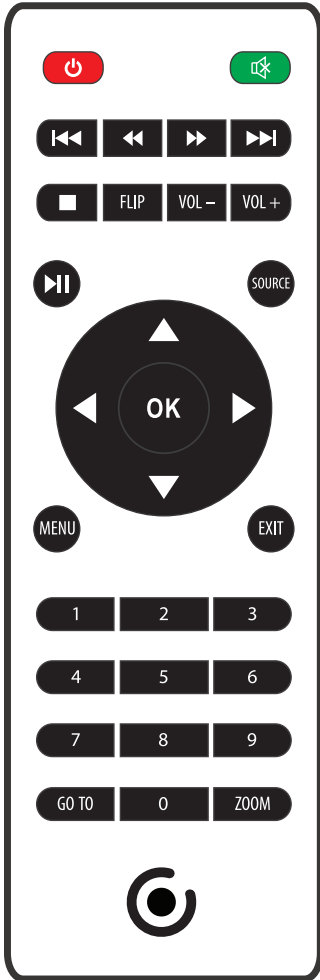



Features and Inputs



- | | |
|-----------------|-----------------------|
| 1. Power ON/OFF | 5. DC IN Port |
| 2. USB Port | 6. Micro SD Card Slot |
| 3. HDMI® Input | 7. AV Input |
| 4. IR Window | 8. Headphone Jack |

Remote



-  **Power:** Press to power ON / OFF
-  **Previous/Next:** Press to skip between chapters
-  **Play/Pause:** Press to play or pause an individual chapter or track
-  **Source:** Press to select media source (AV, PC, HDMI®, MEDIA)
-  **Menu:** Press to access projector settings
-  **Arrows/OK:** Press to navigate on-screen menu(s) and make a selection
-  **Mute:** Press to mute volume
-  **Back/Fwd:** Press to search through an individual chapter or track
-  **Vol+/Vol-:** Press to adjust audio level
-  **Flip:** Press to flip display image 180°
-  **Zoom:** Press to zoom display image in or out
-  **Exit:** Press to exit menu(s)
-  **Go To/Number Key Pad:** Press to enter specific chapter or track number; press play when ready

Remote (Continued)

Batteries

Remove the battery compartment cover on the back of the remote by sliding it off carefully. Insert 2xAAA batteries (not included), referring to the polarity markings. Replace the cover.

NOTE: Batteries should not be exposed to extreme heat. Be sure that the battery polarity is installed correctly. Do not mix old and new batteries. Only same or equivalent type batteries as recommend are to be used. Do not dispose of batteries in fire; battery may explode or leak. Do not try to recharge a battery. Do not mix alkaline, standard, or rechargeable batteries.

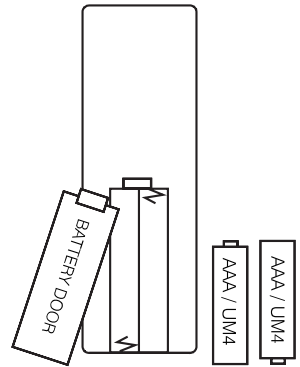

Attaching the Projector Handle

Remove the handle from the box, and attach it to the buttons on each side of the device.

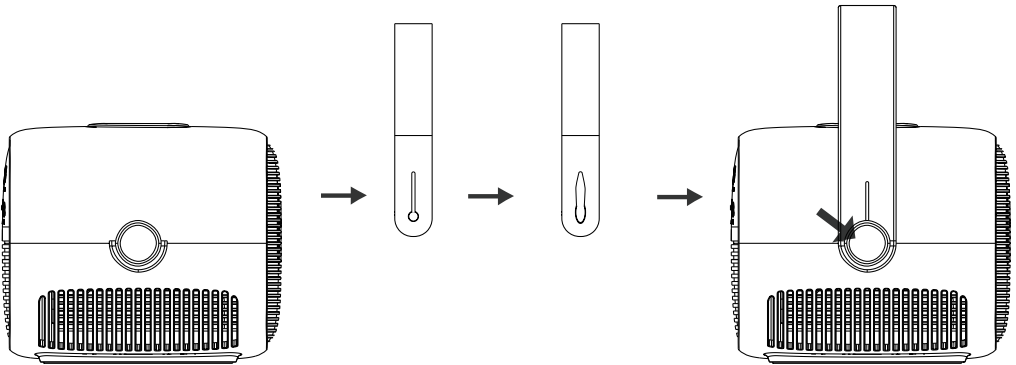

Powering On/Off Your Device

Power On

1. Connect the small end of the power adapter into the DC IN port on the projector, and then plug the adapter body into a power outlet. The projector's indicator light will turn red.
2. Press the power button on the projector. The indicator light will now turn green.
3. The projector will turn on after 5 seconds.

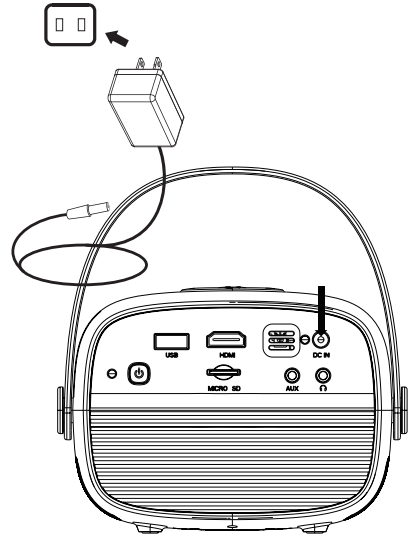

Power Off

1. Press the power button on the projector twice to power off.
2. Unplug the power adapter.

Distance

Measure the distance between the projector and screen. This is the projection distance.

Note: For best results, we recommend aligning the center of the projector lens with the center of the screen.

Projection Distance	39"	78"	118"
Projection Size	30"	68"	100"

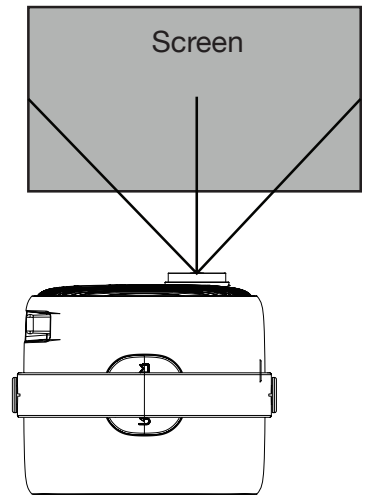

Projector Placement

Your projector can be installed in four different configurations (see below):

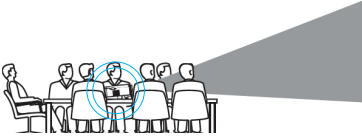

Front Table

Select this location with the projector placed near the floor in front of the screen.

This is the most common way to position the projector for quick setup and portability.



Rear Table

Select this location with the projector placed near the floor behind the screen.

NOTE: A special rear projection screen is required for this configuration.

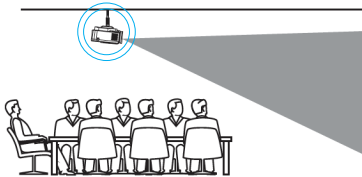

Front Ceiling

Select this location with the projector suspended upside down from the ceiling in front of the screen.

NOTE: A projector mount is required to install the projector on a ceiling.

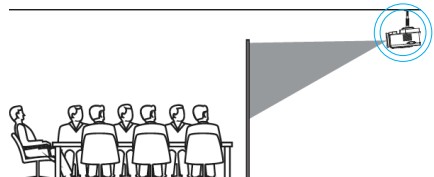

Rear Ceiling

Select this location with the projector suspended upside down from the ceiling behind the screen.

NOTE: A projector mount is required to install the projector on a ceiling. A special rear projection screen is required for this configuration.

Projector Placement (Continued)

Mounting Projector on Ceiling

When mounting the projector to the ceiling, please purchase a projector mount recommended by an installation professional and follow the instructions that come with the mount.

Before installing the projector on the ceiling, please check to make sure the ceiling structure can support the weight of the projector and the mount. If in doubt, please ask an installation professional for advice.

NOTE: Projector mount and screw(s) not included.

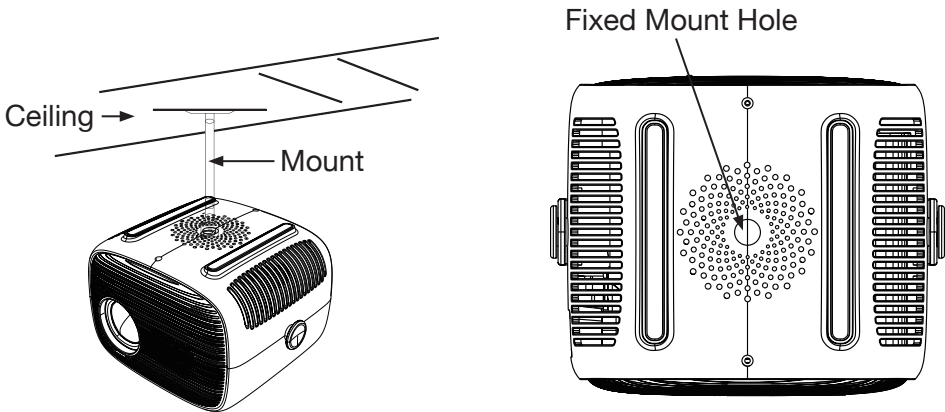

Adjusting the Focus

Refer to the diagram below to adjust the focus.

Turn the knob while observing the image pixels near the center of the screen. Optimal focus is obtained when the pixels are clearly visible. Depending on the projected screen size, the focus near the screen edges may be less sharp than the screen center.

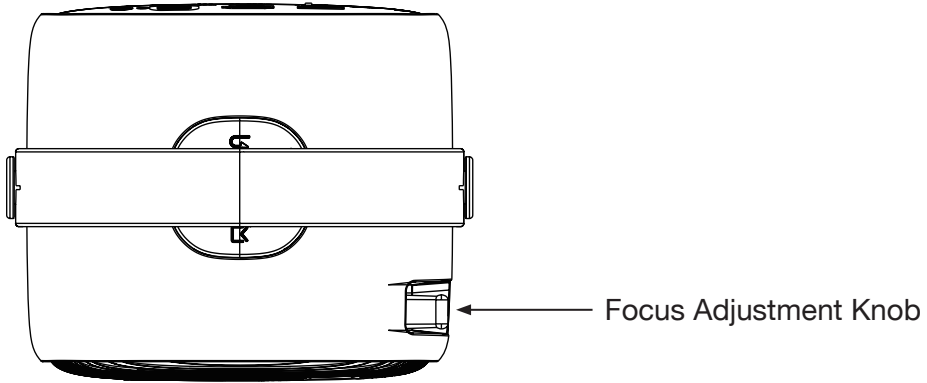

Connecting to Other Devices

Select an Input Source

Power on the projector. Press the Source button on the projector or remote to select the desired input source (AV / HDMI® / Media Player).

You may connect various input devices to the projector according to the following instructions.

Media Player

Turn off your projector before connecting external devices.

Insert a USB Drive or Micro SD card (sold separately) into the projector's corresponding slots. Turn on the device, and press the Source button to access the Media Player mode. Select Video / Music / Picture to open the content you wish to play.

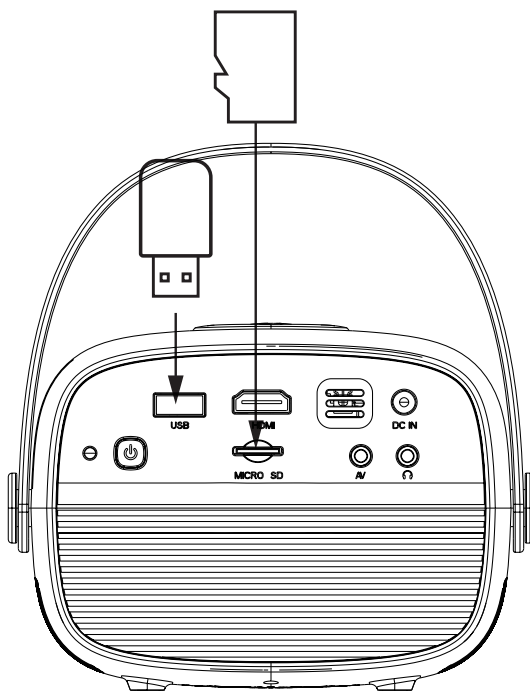

NOTE: Power off the projector before removing your USB Drive / Micro SD card.

Connecting to Other Devices (Continued)

HDMI®

Follow the diagram below to connect your HDMI® cable (not included) to your compatible device (laptop, DVD player, streaming device, smartphone, etc).

1. Turn off the projector before connecting your HDMI® cable. Plug one end into the projector's HDMI® input and the other end into your output device.

You may also connect a smartphone to the projector. Use your smartphone charging cable with an HDMI® adapter to project images onto the big screen.

2. Once connected, press the Power button to turn on the unit. The power indicator will turn green.
3. Press the Source button until you reach HDMI® mode, and the display of your HDMI® device will appear on the projector screen.

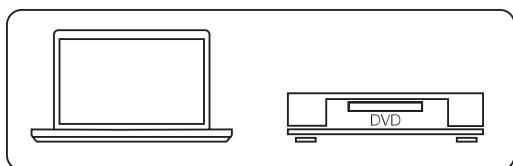
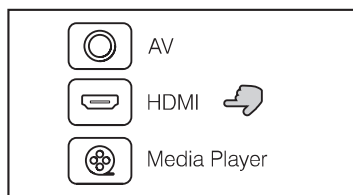
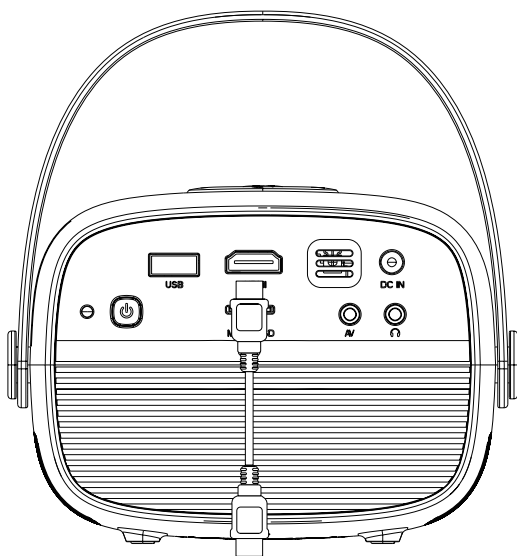

Connecting to Other Devices (Continued)

AV

Follow the diagram below to connect your AV cable (not included) to the device.

1. Turn off the projector before connecting your AV cable.
2. Plug the single end into the projector's AV input, and match the other ends into the ports on your output device. You may need to use both male and female AV cables (not included) depending on the device you wish to connect.
3. Once connected, press the Power button to turn on the unit. The power indicator will turn green.
4. Press the Source button until you reach AV mode, and the content from your AV device will transfer to the projector.

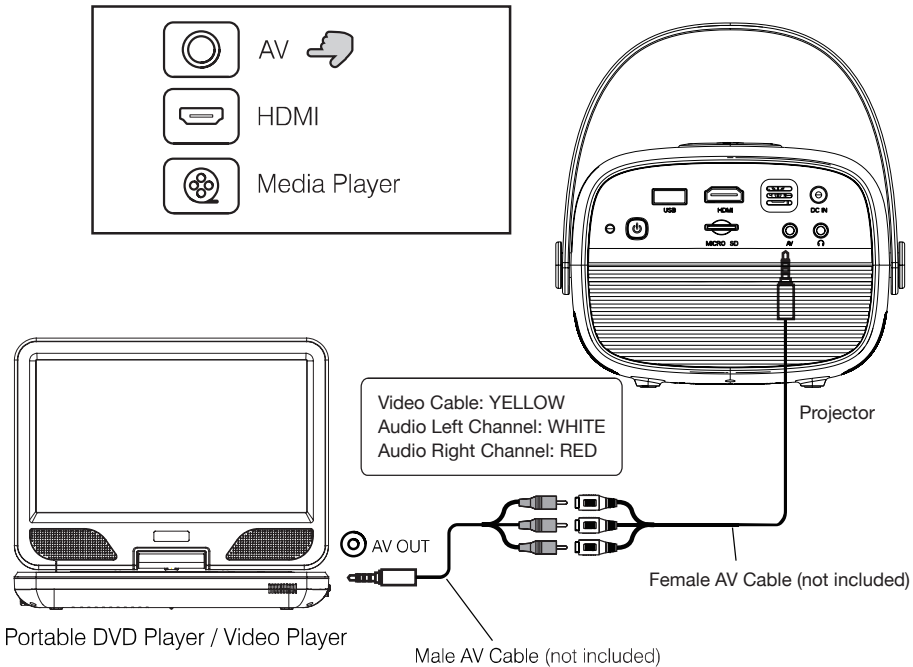

Connecting to Other Devices (Continued)

Headphone Jack

You may connect headphones or a wired audio system (not included) to the projector via the 3.5mm jack.

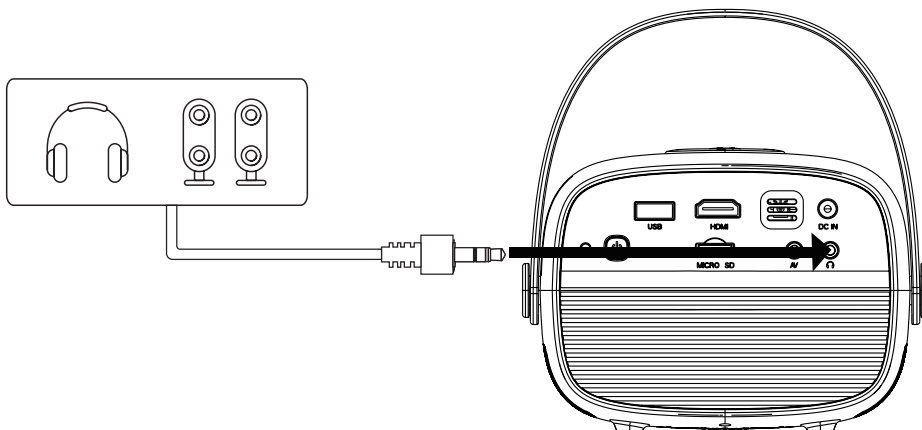

Bluetooth® -Enabled Devices

Follow the details below to connect your Bluetooth®-enabled device (such as a speaker; not included) to the projector:

1. Open the projector menu. Select Setup > Options > Bluetooth® On.
2. Select Bluetooth® On > Search. The projector will begin searching for Bluetooth®-enabled devices.
3. Turn on your Bluetooth® speaker.
4. If the projector finds the device, the name of your speaker will display.
5. Select the speaker's name, and the projector will show Bluetooth® Connected to indicate a successful connection.

Sub Menus



Sub Menu on Photo Screen

1. With Photo Playback, press the OK button to view functions as shown in the diagram at left.
2. Use the arrows on the Navigator to select an icon, and press the OK button to play the special function.



Sub Menu on Music Screen

1. With Music Playback, press the OK button to view functions as shown in the diagram at left.
2. Use the arrows on the Navigator to select an icon, and press the OK button to play the special function.

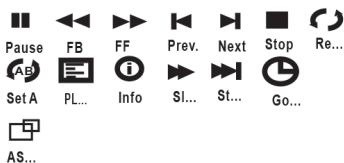

Sub Menu on Movie Screen

1. With Movie Playback, press the OK button to view functions as shown in the diagram at left.
2. Use the arrows on the Navigator to select an icon, and press the OK button to play the special function.

Projector Menus

Picture Mode	Standard
Contrast	50
Brightness	50
Color	50
Sharpness	50

Color Temperature	Medium
Aspect Ratio	Auto
Noise Reduction	Middle

Menu 01

Press the Menu button to enter the projector's menu. Press again to return to the previous screen.

Use Navigator buttons to select the adjustments shown on the left.

Picture Mode: Use the left/right arrows on the Navigator to select different picture effects (Soft / Standard / Vivid / User).

Contrast / Brightness / Color / Sharpness: Use the up/down arrows on the Navigator to select level.

Color Temperature: Use the left/right arrows on the Navigator to select different color temperatures (Cool / Medium / Warm).

Aspect Ratio: Use the left/right arrows on the Navigator to select screen ratio (4:3 or 16:9).

Noise Reduction: Use the left/right arrows on the Navigator to select Off / Low / Medium / High / Default.

Sound Mode	Standard
Treble	50
Bass	50
Balance	0
Auto Volume	Off

Menu 02

Press the Menu button to enter the projector's menu. Press again to return to the previous screen.

Use Navigator buttons to select the adjustments shown on the left.

Sound Mode: Use the left/right arrows on the Navigator to select different sound effects (Standard/Music/Movie/Sports/User)

Treble: Use the left/right arrows to select level (0-100)

Balance: Use the left/right arrows to select level (0-100)

Projector Menus (Continued)

OSD Language	English
Restore Factory Default	
Panel Rotate	0
Info	

Menu 03

Press the Menu button to enter the projector's menu. Press again to return to the previous screen.

Use Navigator buttons to select the adjustments shown on the left.

OSD Language: Use Navigator to select different languages.

Restore Factory Default: Use the left/right arrows on the Navigator to select Y or N. Clicking Y will restore the unit to its factory default settings.

Panel Flip Rotate: Use the left/right arrows on the Navigator to select Front / Rear Ceiling / Front Ceiling / Rear

Info: Display device information

Clock - - -
Off Timer Off
On Timer Off
Sleep Timer Off
Auto Sleep Never

Menu 04

Press the Menu button to enter the projector's menu. Press again to return to the previous screen.

Use Navigator buttons to select the adjustments shown on the left.

Clock: Use Navigator arrows to adjust clock: Day / Month / Year / Hours / Minutes

Off Timer: Use Navigator arrows to select timer turn off: Day / Hour / Minutes

On Timer: Use Navigator arrows to select timer turn on: Day / Hour / Minutes

Sleep Timer Off: Select the automatic sleep timer (in minutes): Off / 10 / 20 / 30 / 60 / 90 / 120 / 180 / 240

Auto Sleep: Select the automatic sleep timer (in hours): Never / 4 / 6 / 8

NOTE: Date and time settings do not save when the device is unplugged.

Troubleshooting

Before seeking maintenance service, please review the following troubleshooting tips:

Projector is not turning on.

Be sure that the power adapter is plugged in securely. Press the power button on the projector or the remote to turn it on.

The projector is turned on, but images are not displaying.

1. Make sure your external device is properly connected to the projector.
2. Make sure the lens cover has been removed.
3. Check that the input signal source corresponds to the connected external device.
4. Make sure the video quality is equal to or under 1080p.

The lamp (bulb) switches off after some time.

1. Let the projector cool down for a few moments.
2. Check if anything is blocking the projector's ventilation.

Display is dim.

This projector works best in relatively dark environments.

Spots appear on the display.

Use lens-cleaning paper or a clean, lint-free cloth to remove dust and smudges from the projector lens.

Images are blurry.

The recommended projection distance is 39-118". Use the Focus knob to adjust image sharpness. If the projection size is too large, the focus near the screen edges may be less sharp than at the screen center.

My projector is making loud noises.

Projector noise is due to the cooling system's fan. Projectors generate heat during operation, and as a result, the fan will run to cool the device down.

Specifications

Native display resolution	800 x 480
Supported video resolutions	1080p, 1080i, 720p, 576i, 480p, 480i
Light source type	LED
Power	DC 12V/3A; 110-240V, 50/60Hz
Brightness	40 lumens
Connection types	HDMI®, USB, Micro SD card, AV, audio
Inputs	HDMI® input x 1 / AV x 1 / Micro SD card x 1 / USB port x 1
Output	3.5mm headphone x 1
USB port	Supports USB devices up to 1TB
Micro SD card slot	Supports Micro SD cards up to 1TB
Supported image formats	.jpg / .png / .bmp
Supported audio formats	.mp3
Supported video formats	.avi / .mp4 / .mov
Projector weight	1.15 lb
Projector dimensions	5.6 x 4.6 x 3.9 in

Optimal performance in dark viewing environments.

Need Help?

For customer support regarding your device, please submit a request by emailing support@dpaudiovideo.zendesk.com. You will be provided a ticket number regarding your inquiry, which you can refer to when contacting us further.

You may also reach a Core Innovations customer service representative by calling **1-833-909-CORE (1-833-909-2673)**. We are available Monday - Friday, 9am - 5pm PST, except major holidays. Core Innovations strongly urges customers to email their inquiry prior to calling, as this will enable us to better assist you.

Please make sure to note the model number and a description of your inquiry.

Thank you for purchasing a Core Innovations product.

Warranty Information

Limited Warranty

Core Innovations (the “Company”) warrants this new product purchased and contained in this package (the “Product”) against defects in material or workmanship for 90 Days (Parts & Labor) and 1 Year (Limited). In order for the Company to honor this limited warranty, you must present a valid proof of purchase (i.e. a receipt) of this Product. IMPORTANT NOTE: The customer is encouraged to carefully inspect the Product upon receipt after purchase – especially prior to any assembly, disassembly, mounting, installation or utilizing a third-party product of any kind, such as a decorative or protective cover or case.

This warranty is void if the Company deems, in its discretion, that the Product may have been damaged when the packaging was opened, through modification, improper transport, improper storage, improper use, improper assembly or disassembly, exposure to adverse elements, mounting or other installation, end user negligence, water damage or tampering of the barcode of the Product. This warranty does not apply: (a) to cosmetic damage, including but not limited to screen damage, a cracked display, scratches, dents and broken ports; (b) to damage caused by accident, abuse, misuse, fire, water vapor exposure, excessive exposure

Warranty Information

to humidity, water or other liquid contact, earthquake or other external cause; (c) to defects caused by normal wear and tear or otherwise due to the normal aging of the product; (d) if any serial number has been removed or defaced from the product; or (e) to damage caused by installation or mounting, assembly or disassembly, use with a third party device, cable, protective or decorative cover/case, component or product that does not meet the Company's product specifications. This warranty is a limited warranty for repair of the Product or replacement of the Product with a new or refurbished product, subject to the conditions set forth herein.

The Company is not liable for consequential, indirect, incidental, special or punitive damages and the Company's total liability hereunder shall not exceed an amount greater than the retail purchase price of the product.

90 Days Parts & Labor

The Company warrants to you as the original retail purchaser of the Product, that should the Product have any warranted defect out of the packaging, under normal conditions, such defect(s) will be repaired or replaced with a new or refurbished part (at the Company's sole discretion) without charge, if the Product is submitted to the Company within a period of ninety (90) calendar days from the date of purchase of the Product. The customer is responsible for transportation cost and insurance charges (if applicable) to the Company and must be able to document a clear proof of delivery to the Company as well as proof of registered receipt by the Company. It is the customer's responsibility to retain original packaging or provide like packaging in order to facilitate the warranty repair or replacement process. The Company will incur no liability whatsoever to provide packaging for warranty items. Should the product be damaged en route to the Company due to insufficient or improper packaging or improper transport, the warranty may be voided. You must receive a return authorization number (RMA#) before sending the unit in for service. This warranty only applies to manufacturer defects, and the Product must be returned to the Company in its original condition.

1 Year Limited Parts

If determined to be covered under warranty, the one (1) year limited parts warranty gives the customer the option to return the Product to the Company for repair or replacement. The customer will be responsible for labor charges. This warranty does not cover any incidental or indirect costs incurred as a result of a defect in the Product, including any consequential, incidental or indirect damages.



Core Innovations intends to make this manual accurate and complete. However, Core Innovations makes no claim that the information contained herein covers all details and conditions. The information in this document is subject to change without notice at any time. Core Innovations assumes no responsibility for accuracy or completeness of the information contained in this manual.

FCC WARNING

This device complies with part 15 of the FCC Rules. Operation is subject to the following two conditions: (1) this device may not cause harmful interference, and (2) this device must accept any interference received, including interference that may cause undesired operation.

Any changes or modifications not expressly approved by the party responsible for compliance could void the user's authority to operate the equipment.

NOTE: This equipment has been tested and found to comply with the limits for a Class B digital device, pursuant to Part 15 of the FCC Rules. These limits are designed to provide reasonable protection against harmful interference in a residential installation. This equipment generates, uses and can radiate radio frequency energy and, if not installed and used in accordance with the instructions, may cause harmful interference to radio communications.

However, there is no guarantee that interference will not occur in a particular installation.

If this equipment does cause harmful interference to radio or television reception, which can be determined by turning the equipment off and on, the user is encouraged to try to correct the interference by one or more of the following measures:

- Reorient or relocate the receiving antenna.
- Increase the separation between the equipment and receiver.
- Connect the equipment into an outlet on a circuit different from that to which the receiver is connected.
- Consult the dealer or an experienced radio/TV technician for help.

To maintain compliance with FCC's RF Exposure guidelines, This equipment should be installed and operated with minimum distance between 20cm the radiator your body: Use only the supplied antenna.