



243 Jubug-Ri, Yangji-Myeon, Yongin-Si, Gyeonggi-Do, Korea 17159
Tel: +82-31-323-6008 Fax: +82-31-323-6010
<http://www.ltalab.com>

Dates of Tests: December 13, 2023 ~ January 04, 2023
Test Report S/N: LR500112303O
Test Site : LTA CO., LTD.

CERTIFICATION OF COMPLIANCE

FCC ID.	2AVQ5BT-CFEA
APPLICANT	BT Inc.

Equipment Class	:	Digital Transmission System (DTS)
Manufacturing Description	:	CPR and First Aid Training Model
Manufacturer	:	BT Inc.
Model name	:	BT-CFEA-F
Variant Model name	:	BT-CFEA-B
Test Device Serial No.:	:	Identical prototype
Rule Part(s)	:	FCC Part 15.247 Subpart C ; ANSI C63.10 - 2013
Frequency Range	:	BLE 2402 ~ 2480 MHz
Max. Output Power	:	0.00136 W
Data of issue	:	March 24, 2023

This test report is issued under the authority of:

The test was supervised by:

Ja-Beom Koo, Manager

Eun-Hwan Jung, Test Engineer

This test result only responds to the tested sample. It is not allowed to copy this report even partly without the allowance of the test laboratory. The report must not be used by the client to claim product certification, approval, or endorsement by NVLAP, NIST, or any agency of the Federal Government.



NVLAP LAB Code.: 200723-0

TABLE OF CONTENTS

1. GENERAL INFORMATION ----- 3

2. INFORMATION ABOUT TEST ITEM ----- 4

3. TEST REPORT ----- 5

 3.1 SUMMARY OF TESTS ----- 5

 3.2 TECHNICAL CHARACTERISTICS TEST ----- 6

 3.2.1 RADIATED SPURIOUS EMISSIONS----- 6

APPENDIX

 APPENDIX TEST EQUIPMENT USED FOR TESTS ----- 16

1. General information

1-1 Test Performed

Company name : LTA Co., Ltd.
 Address : 243, Jubug-ri, Yangji-Myeon, Youngin-Si, Kyunggi-Do, Korea. 17159
 Web site : <http://www.ltalab.com>
 E-mail : chahn@ltalab.com
 Telephone : +82-31-323-6008
 Facsimile : +82-31-323-6010

Quality control in the testing laboratory is implemented as per ISO/IEC 17025 which is the “General requirements for the competents of calibration and testing laboratory”.

1-2 Accredited agencies

LTA Co., Ltd. is approved to perform EMC testing by the following agencies:

Agency	Country	Accreditation No.	Validity	Reference
NVLAP	U.S.A	200723-0	2023-09-28	ECT accredited Lab.
RRA	KOREA	KR0049	-	EMC accredited Lab.
FCC	U.S.A	649054	2023-01-25	FCC CAB
VCCI	JAPAN	C-4948,	2023-09-10	VCCI registration
VCCI	JAPAN	T-2416,	2023-09-10	VCCI registration
VCCI	JAPAN	R-4483(10 m),	2023-08-15	VCCI registration
VCCI	JAPAN	G-847	2023-12-13	VCCI registration
IC	CANADA	5799A-1	2023-10-18	IC filing

2. Information about test item

2-1 Client & Manufacturer

Client Company name : BT Inc.

Address : A-313 Samsung Techno-valley, 140, Tongil-ro, Deogyang-gu , Goyang-si, Gyeonggi-do, 10594, Republic of Korea

Tel / Fax : TEL No : +82-01- 2756-2614 / FAX No : + 82-303-3130-607

Manufacturer : BT Inc.

Address : A-313 Samsung Techno-valley, 140, Tongil-ro, Deogyang-gu , Goyang-si, Gyeonggi-do, 10594, Republic of Korea

Tel / Fax : TEL No : +82-01- 2756-2614 / FAX No : + 82-303-3130-607

2-2 Equipment Under Test (EUT)

Model name : BT-CFEA-F

Serial number : Identical prototype

Date of receipt : December 13, 2022

EUT condition : Pre-production, not damaged

Antenna type : Chip Antenna (Max Gain : -1.10 dBi)

Frequency Range : BLE 2402 ~ 2480 MHz

Type of Modulation : GFSK

Power Source : DC 12 V by Adapter, DC 9 V by Battery

2-3 Tested frequency

	LOW	MID	HIGH
Frequency (MHz) BLE	2402	2442	2480

2-4 Ancillary Equipment

Equipment	Model No.	Serial No.	Manufacturer
Notebook	-	MS-1736	MSI

3. Test Report

3.1 Summary of tests

FCC Part Section(s)	Parameter	Test Condition	Status (note 1)
15.247(a)	6 dB Bandwidth	Conducted	N/A ¹⁾
15.247(b)	Transmitter Peak Output Power		N/A ¹⁾
15.247(e)	Transmitter Power Spectral Density		N/A ¹⁾
15.247(d)	Band Edge & Conducted Spurious emission		N/A ¹⁾
15.209	Transmitter emission	Radiated	C
15.207	AC Conducted Emissions	Conducted	N/A ¹⁾
15.203	Antenna requirement	-	C

N/A¹⁾ : The product replaces this test with a certificate using an authenticated module.

The above equipment was tested by LTA Co., Ltd. The test data, data evaluation, test procedures, and equipment configurations shown in this report were made in accordance with the procedures given in ANSI C63.10-2013 and the energy emitted by the sample EUT tested as described in this report is in compliance with the requirements of FCC Rules Part 2 and Part 15.247 The test results of this report relate only to the tested sample identified in this report.

The tests were performed according to the method of measurements prescribed in KDB No.558074.

→ Antenna Requirement

BT Inc.. FCC ID: 2AVQ5BT-CFEA-F unit complies with the requirement of §15.203.

The antenna type is Chip Antenna

below 1 GHz (30 MHz to 1 GHz)

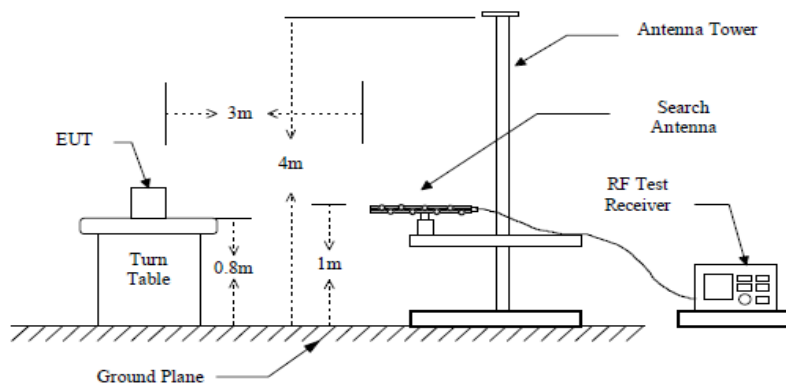

above 1 GHz

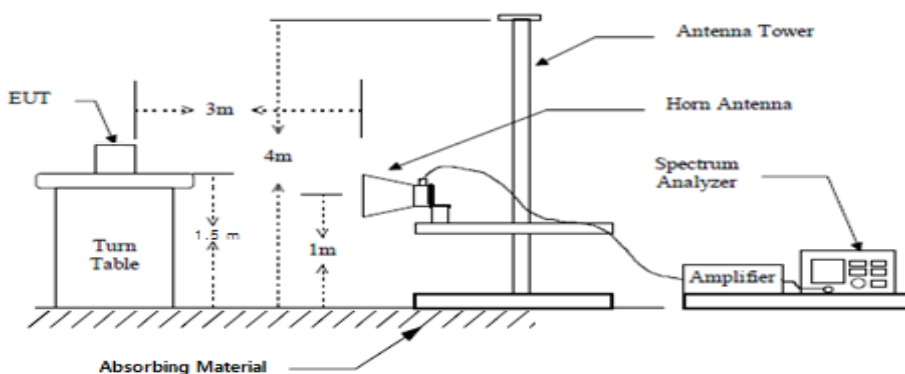

Measurement Data: **Complies**

- See next pages for actual measured data.
- No other emissions were detected at a level greater than 20 dB below limit include from 9 kHz to 30MHz.
- The test results for the worst of the various operating modes are presented in accordance with 6.3.4 of ANSI C63.10.
- Checked with a red circle is the fundamental frequency.
- At the request of the applicant, measurements of derived model products are also attached.

Minimum Standard: FCC Part 15.209(a)

Frequency (MHz)	Limit (uV/m) @ 3 m
0.009 ~ 0.490	2400/F(kHz) (@ 30 m)
0.490 ~ 1.705	24000/F(kHz) (@ 30 m)
1.705 ~ 30	30(@ 30 m)
30 ~ 88	100 **
88 ~ 216	150 **
216 ~ 960	200 **
Above 960	500

** Except as provided in 15.209(g), fundamental emissions from intentional radiators operating under this Section shall not be located in the frequency bands 54-72 MHz, 76-88 MHz, 174-216 MHz or 470-806 MHz. However, operation within these frequency bands is permitted under other sections of this Part, e.g. 15.231 and 15.241.

Radiated Emissions – BLE (BT-CFEA-F)

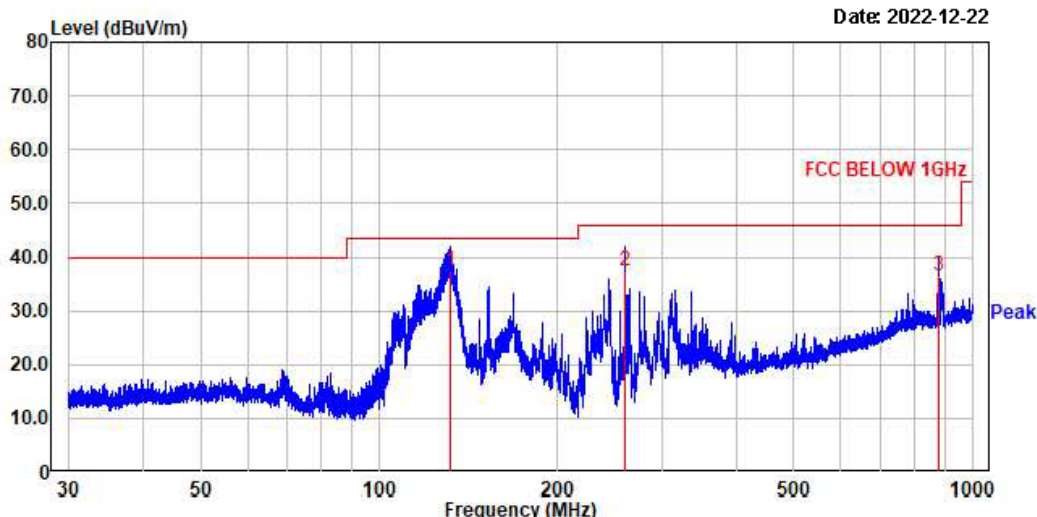

Trace:									
No.	Freq	Reading	C.F	Result	Limit	Margin	Height	Angle	Polarity
	MHz	dBμV	dB	dBμV/m	dBμV/m	dB	cm	deg	
1.	131.70	50.30	-12.84	37.46	43.50	6.04	400	360	horizontal
2.	259.92	49.19	-11.62	37.57	46.00	8.43	100	205	horizontal
3.	875.63	34.21	2.34	36.55	46.00	9.45	100	85	horizontal

Remarks: C.F (Correction Factor) = Antenna factor + Cable loss - Preamp gain

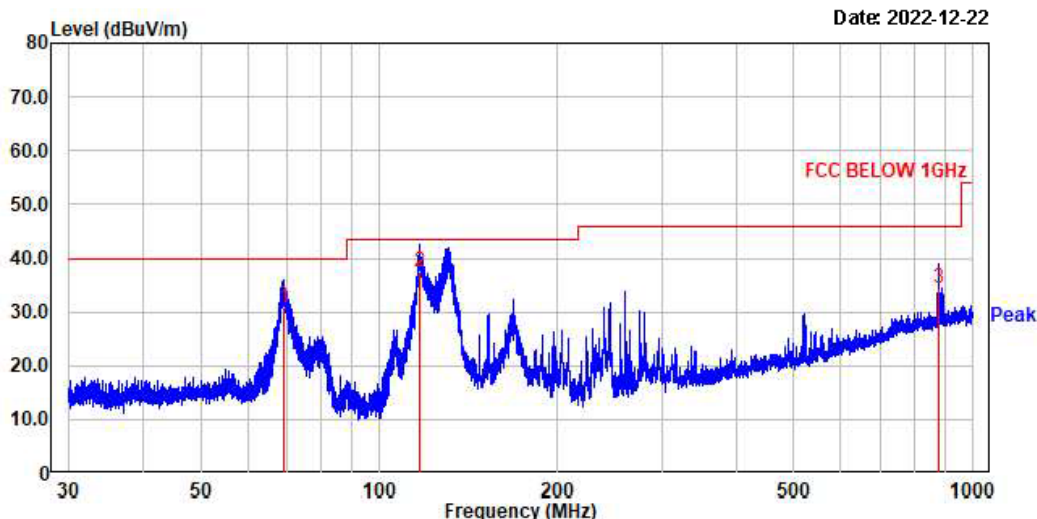

Trace:									
No.	Freq	Reading	C.F	Result	Limit	Margin	Height	Angle	Polarity
	MHz	dBμV	dB	dBμV/m	dBμV/m	dB	cm	deg	
1.	69.17	44.50	-13.86	30.64	40.00	9.36	100	324	vertical
2.	116.95	51.90	-14.41	37.49	43.50	6.01	100	0	vertical
3.	876.40	32.00	2.36	34.36	46.00	11.64	100	341	vertical

Remarks: C.F (Correction Factor) = Antenna factor + Cable loss - Preamp gain

Date: 2022-12-22

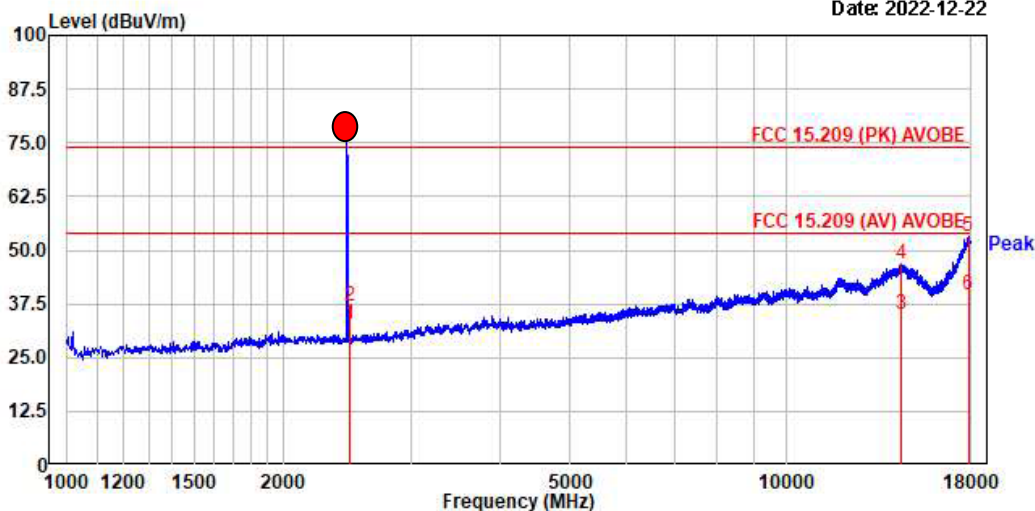

No.	Freq MHz	RD PK dBμV	RD AV dBμV	C.F dB	Result PK dBμV	Result AV dBμV	Limit PK dBμV	Limit AV dBμV	Margin PK dB	Margin AV dB	Height cm	Angle deg	Polarity
2.	2472.63	48.52	36.58	-3.66	36.86	32.84	74.88	54.88	37.14	21.16	188	49	horizontal
4.	14447.88	27.13	15.41	19.58	46.71	34.99	74.88	54.88	27.29	19.81	188	384	horizontal
5.	17878.88	27.58	-----	25.57	53.87	-----	74.88	-----	28.93	-----	188	178	horizontal
6.	17878.88	-----	14.88	25.57	-----	39.57	-----	54.88	-----	14.43	188	178	horizontal

Remarks: C.F (Correction Factor) = Antenna factor + Cable loss - Preamp gain

Date: 2022-12-22

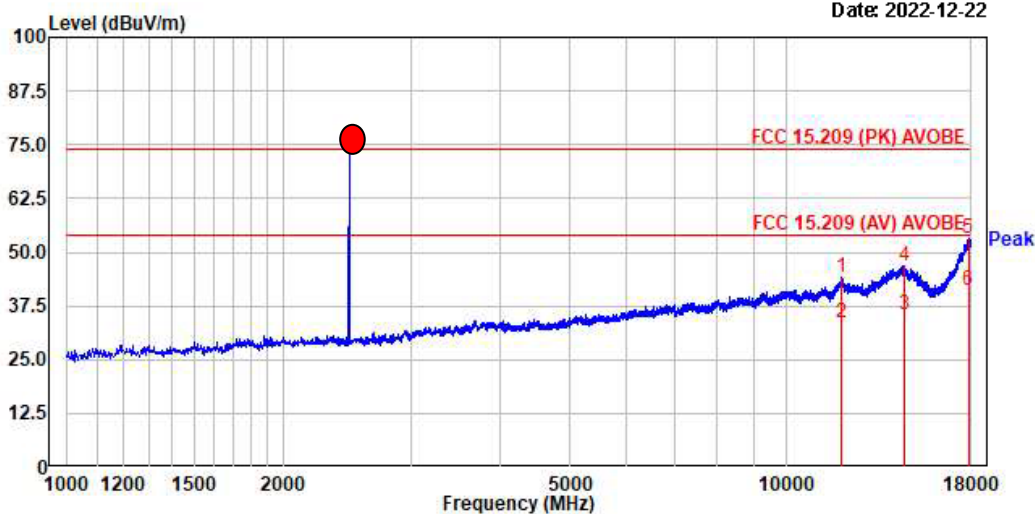

No.	Freq MHz	RD PK dBμV	RD AV dBμV	C.F dB	Result PK dBμV	Result AV dBμV	Limit PK dBμV	Limit AV dBμV	Margin PK dB	Margin AV dB	Height cm	Angle deg	Polarity
1.	11937.38	28.69	-----	15.38	43.99	-----	74.88	-----	38.81	-----	188	191	vertical
2.	11937.38	-----	18.28	15.38	-----	33.58	-----	54.88	-----	28.58	188	191	vertical
4.	14557.58	26.99	15.78	19.73	46.72	35.43	74.88	54.88	27.28	18.57	188	8	vertical
5.	17878.88	27.69	-----	25.57	53.26	-----	74.88	-----	28.74	-----	188	368	vertical
6.	17878.88	-----	15.78	25.57	-----	41.27	-----	54.88	-----	12.73	188	368	vertical

Remarks: C.F (Correction Factor) = Antenna factor + Cable loss - Preamp gain

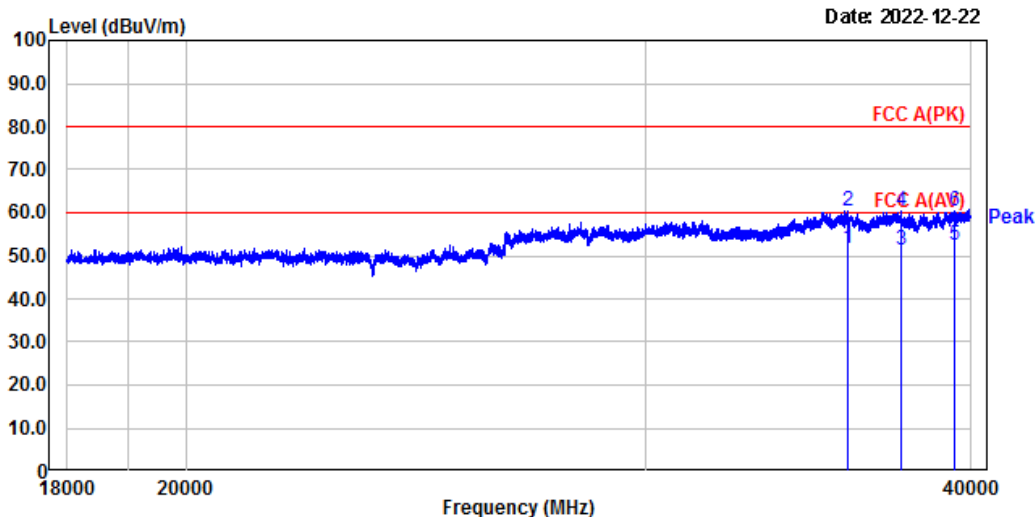

No.	Freq MHz	RD PK dBμV	RD AV dBμV	C.F dB	Result PK dBμV	Result AV dBμV	Limit PK dBμV	Limit AV dBμV	Margin PK dB	Margin AV dB	Height cm	Angle deg	Polarity
2.	35883.25	37.20	28.20	23.32	60.52	51.52	80.00	60.00	19.48	8.48	100	50	horizontal
4.	37629.50	36.53	27.53	23.66	60.19	51.19	80.00	60.00	19.81	8.81	100	7	horizontal
6.	39447.25	36.40	28.40	23.88	60.28	52.28	80.00	60.00	19.72	7.72	100	96	horizontal

Remarks: C.F (Correction Factor) = Antenna factor + Cable loss - Preamp gain

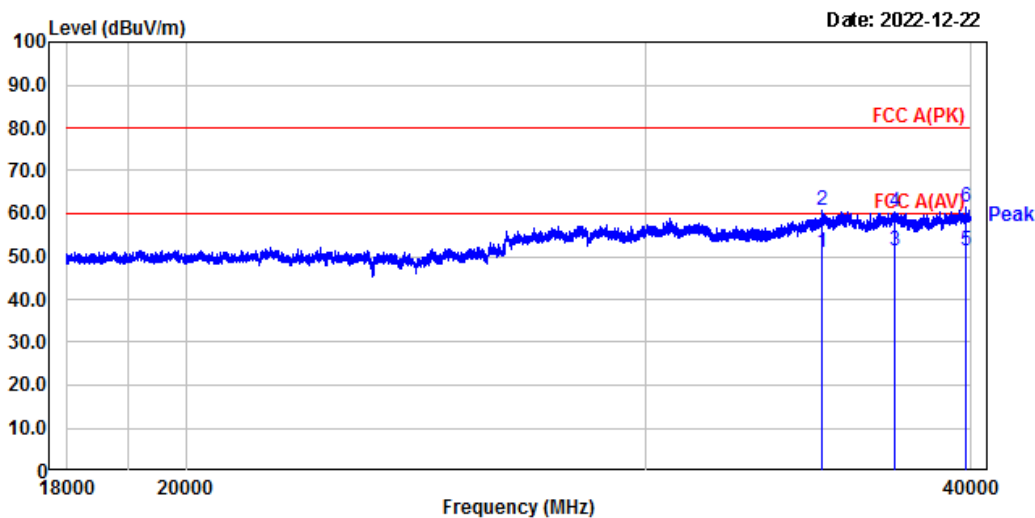

No.	Freq MHz	RD PK dBμV	RD AV dBμV	C.F dB	Result PK dBμV	Result AV dBμV	Limit PK dBμV	Limit AV dBμV	Margin PK dB	Margin AV dB	Height cm	Angle deg	Polarity
2.	35083.00	38.48	28.48	22.30	60.78	50.78	80.00	60.00	19.22	9.22	100	124	vertical
4.	37420.50	36.51	27.51	23.74	60.25	51.25	80.00	60.00	19.75	8.75	100	155	vertical
6.	39837.75	37.13	27.13	24.34	61.47	51.47	80.00	60.00	18.53	8.53	100	285	vertical

Remarks: C.F (Correction Factor) = Antenna factor + Cable loss - Preamp gain

Radiated Emissions – BLE (BT-CFEA-B)

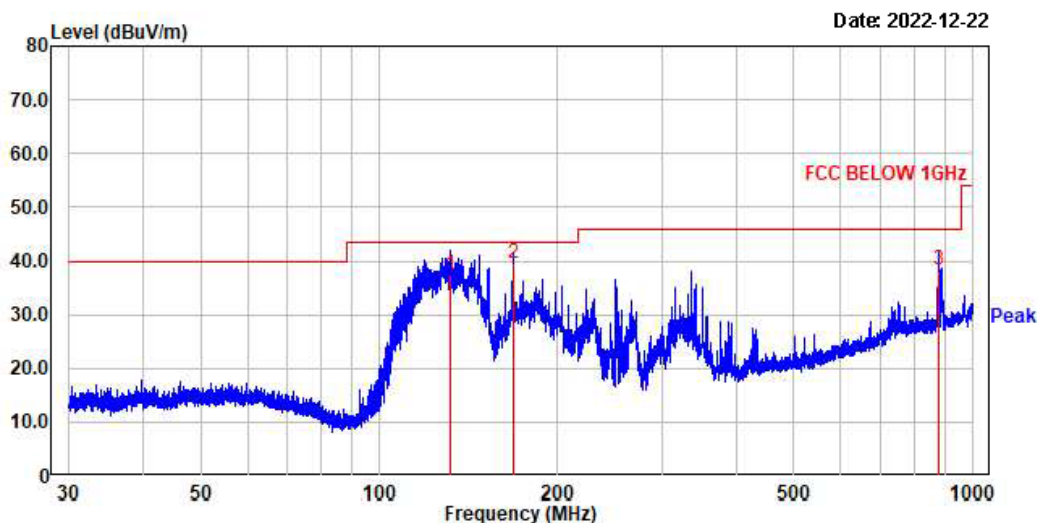

Trace:								
No.	Freq	Reading	C.F	Result	Limit	Margin	Height	Angle Polarity
	MHz	dBμV	dB	QP dBμV/m	dBμV/m	dB	cm	deg
1.	132.05	50.20	-12.81	37.39	43.50	6.11	216	0 horizontal
2.	168.12	51.40	-11.71	39.69	43.50	3.81	100	152 horizontal
3.	876.40	35.90	2.36	38.26	46.00	7.74	100	294 horizontal

Remarks: C.F (Correction Factor) = Antenna factor + Cable loss - Preamp gain

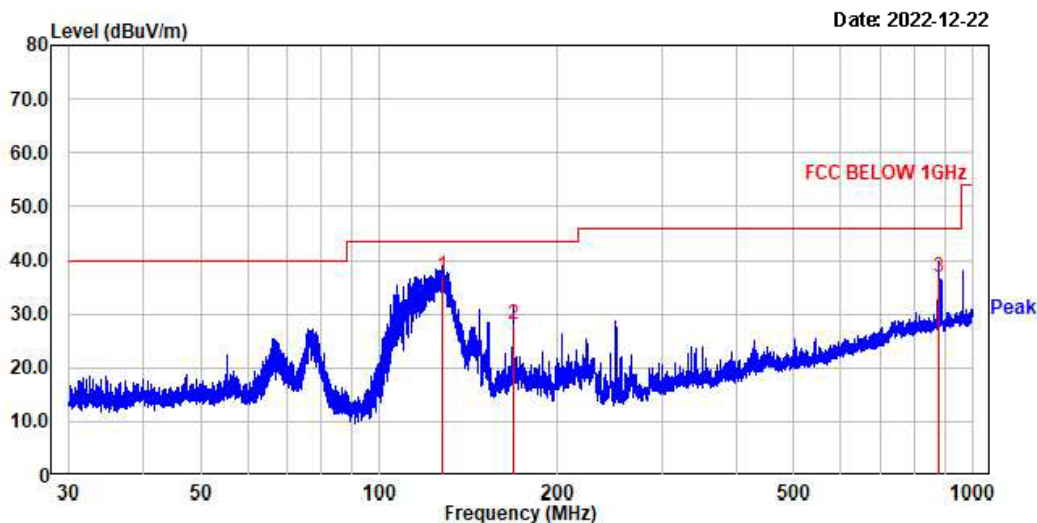

Trace:								
No.	Freq	Reading	C.F	Result	Limit	Margin	Height	Angle Polarity
	MHz	dBμV	dB	QP dBμV/m	dBμV/m	dB	cm	deg
1.	127.55	50.39	-13.30	37.09	43.50	6.41	100	99 vertical
2.	168.05	39.70	-11.71	27.99	43.50	15.51	400	50 vertical
3.	876.40	34.40	2.36	36.76	46.00	9.24	100	83 vertical

Remarks: C.F (Correction Factor) = Antenna factor + Cable loss - Preamp gain

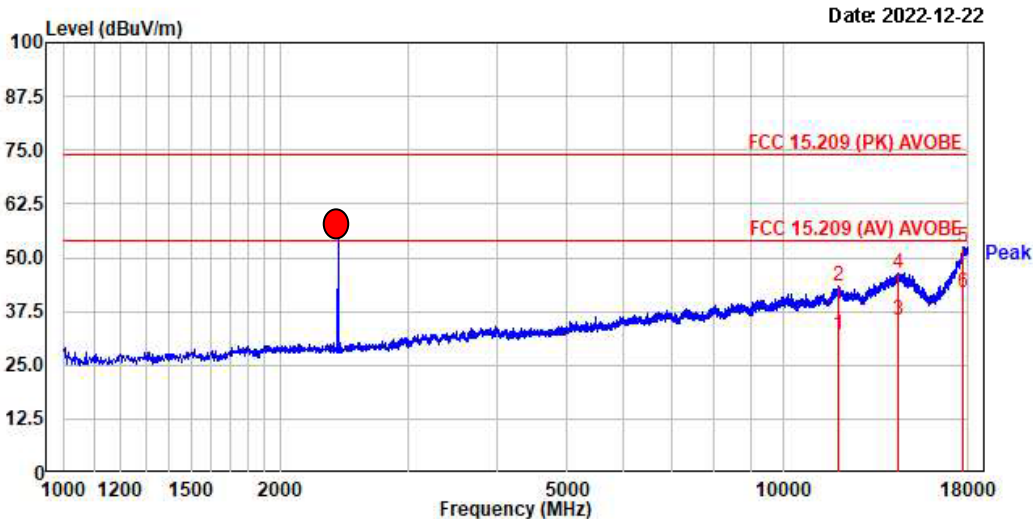

No.	Freq MHz	RD PK dBμV	RD AV dBμV	C.F dB	Result PK dBμV	Result AV dBμV	Limit PK dBμV	Limit AV dBμV	Margin PK dB	Margin AV dB	Height cm	Angle deg	Polarity
2.	11897.80	27.91	16.91	15.32	43.23	32.23	74.00	54.00	30.77	21.77	100	304	horizontal
4.	14413.80	26.94	15.79	19.52	46.46	35.31	74.00	54.00	27.54	18.69	100	360	horizontal
5.	17717.38	27.83	-----	24.70	52.53	-----	74.00	-----	21.47	-----	100	358	horizontal
6.	17717.38	-----	17.20	24.70	-----	41.90	-----	54.00	-----	12.10	100	358	horizontal

Remarks: C.F (Correction Factor) = Antenna factor + Cable loss - Preamp gain

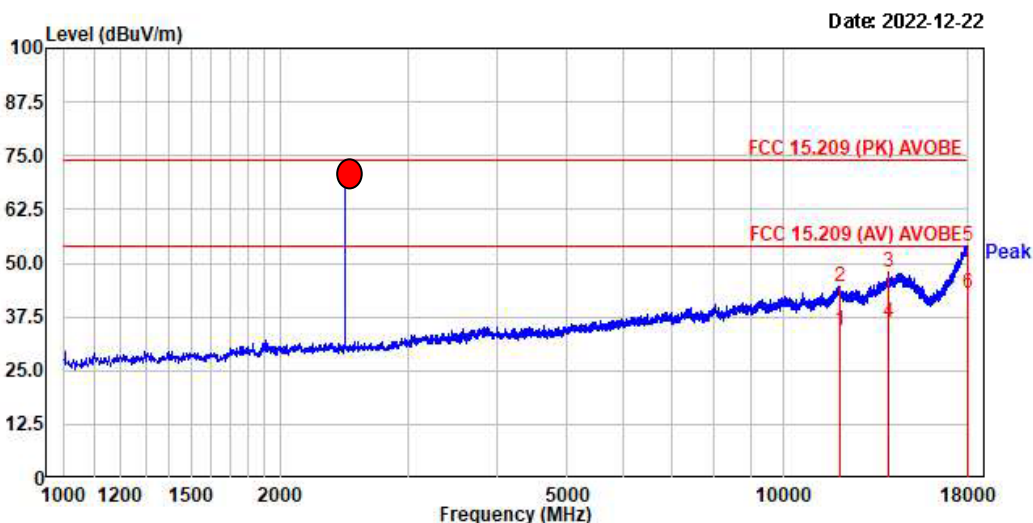

No.	Freq MHz	RD PK dBμV	RD AV dBμV	C.F dB	Result PK dBμV	Result AV dBμV	Limit PK dBμV	Limit AV dBμV	Margin PK dB	Margin AV dB	Height cm	Angle deg	Polarity
2.	11994.75	29.14	19.20	15.26	44.40	34.46	74.00	54.00	29.60	19.54	100	85	vertical
3.	13981.63	29.22	-----	18.73	47.95	-----	74.00	-----	26.05	-----	100	360	vertical
4.	13981.63	-----	17.60	18.73	-----	36.33	-----	54.00	-----	17.67	100	360	vertical
5.	17976.63	28.44	-----	25.67	54.11	-----	74.00	-----	19.89	-----	100	360	vertical
6.	17976.63	-----	17.31	25.67	-----	42.98	-----	54.00	-----	11.02	100	360	vertical

Remarks: C.F (Correction Factor) = Antenna factor + Cable loss - Preamp gain

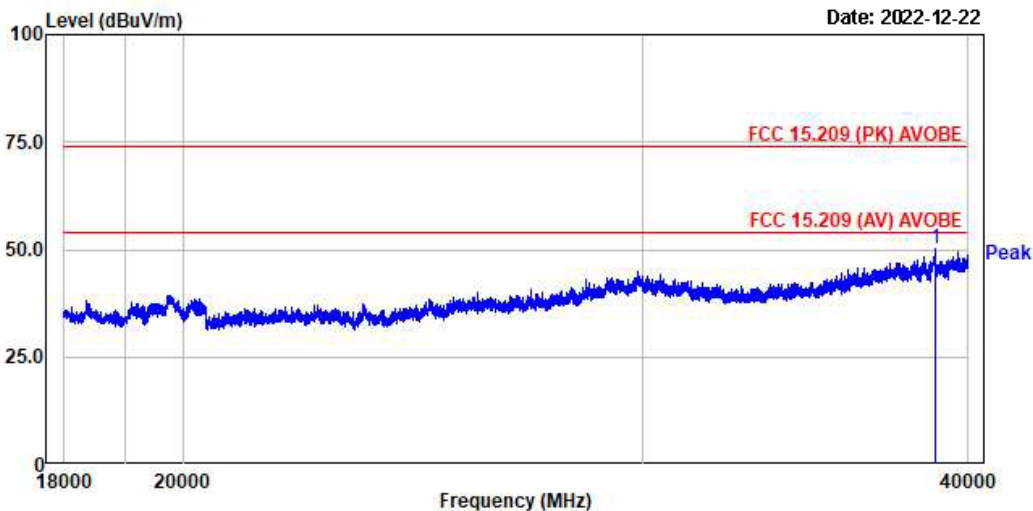

No.	Freq MHz	RD PK dBμV	RD AV dBμV	C.F dB	Result PK dBμV	Result AV dBμV	Limit PK dBμV	Limit AV dBμV	Margin PK dB	Margin AV dB	Height cm	Angle deg	Polarity
1.	38861.50	28.88	-----	21.48	50.36	-----	74.00	-----	23.64	-----	256	263	horizontal

Remarks: C.F (Correction Factor) = Antenna factor + Cable loss - Preamp gain

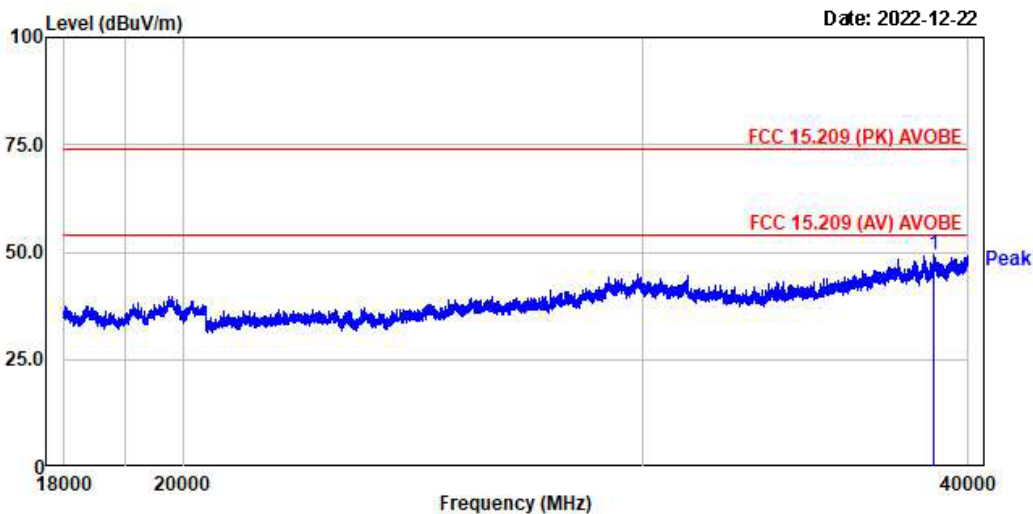

No.	Freq MHz	RD PK dBμV	RD AV dBμV	C.F dB	Result PK dBμV	Result AV dBμV	Limit PK dBμV	Limit AV dBμV	Margin PK dB	Margin AV dB	Height cm	Angle deg	Polarity
1.	38853.25	28.86	-----	21.49	49.55	-----	74.00	-----	24.45	-----	84	77	vertical

Remarks: C.F (Correction Factor) = Antenna factor + Cable loss - Preamp gain

3.2.7 AC Conducted Emissions

Procedure:

The conducted emissions are measured in the shielded room with a spectrum analyzer in peak hold. While the measurement, EUT had its hopping function disabled at the middle channels in line with Section 15.31(m). Emissions closest to the limit are measured in the quasi-peak mode (QP) with the tuned receiver using a bandwidth of 9 kHz. The emissions are maximized further by cable manipulation and Exerciser operation. The highest emissions relative to the limit are listed.

Measurement Data: N/A

Minimum Standard: FCC Part 15.207(a) / EN 55022

Class B

Frequency Range	quasi-peak	Average
0.15 ~ 0.5	66 to 56 *	56 to 46 *
0.5 ~ 5	56	46
5 ~ 30	60	50

* Decreases with the logarithm of the frequency

APPENDIX
TEST EQUIPMENT USED FOR TESTS

	Use	Description	Model No.	Serial No.	Manufacturer	Interval	Next Cal. Date
1	■	Signal Analyzer (9 kHz ~ 30 GHz)	FSV30	100757	R&S	1 year	2022-09-06
2	■	Signal Generator (~3.2 GHz)	8648C	3623A02597	HP	1 year	2023-03-16
3		SYNTHESIZED CW GENERATOR	83711B	US34490456	HP	1 year	2023-03-16
4		Attenuator (3 dB)	8491A	37822	HP	1 year	2023-08-30
5		Attenuator (10 dB)	8491A	63196	HP	1 year	2023-08-30
6	■	EMI Test Receiver (~7 GHz)	ESCI7	100722	R&S	1 year	2023-08-30
7		RF Amplifier (~1.3 GHz)	8447D OPT 010	2944A07684	HP	1 year	2023-08-30
8		RF Amplifier (1~26.5 GHz)	8449B	3008A02126	HP	1 year	2023-03-16
9	■	Horn Antenna (1~18 GHz)	3115	00114105	ETS	2 year	2024-09-06
10		DRG Horn (Small)	3116B	81109	ETS-Lindgren	2 year	2024-03-18
11		DRG Horn (Small)	3116B	133350	ETS-Lindgren	2 year	2024-03-18
12	■	TRILOG Antenna	VULB 9160	9160-3237	SCHWARZBECK	2 year	2023-03-20
13		Temp.Humidity Data Logger	SK-L200TH II A	00801	SATO	1 year	2023-03-16
14		Splitter (SMA)	ZFSC-2-2500	SF617800326	Mini-Circuits	-	-
15	■	DC Power Supply	6674A	3637A01657	Agilent	-	-
17	■	Power Meter	EPM-441A	GB32481702	HP	1 year	2023-03-16
18	■	Power Sensor	8481A	3318A94972	HP	1 year	2023-08-30
19		Audio Analyzer	8903B	3729A18901	HP	1 year	2023-08-30
20		Modulation Analyzer	8901B	3749A05878	HP	1 year	2023-08-30
21		TEMP & HUMIDITY Chamber	YJ-500	LTAS06041	JinYoung Tech	1 year	2023-08-30
22		Stop Watch	HS-3	812Q08R	CASIO	2 year	2024-03-18
23		LISN	KNW-407	8-1430-1	Kyoritsu	1 year	2023-08-30
24		Two-Lime V-Network	ESH3-Z5	893045/017	R&S	1 year	2023-03-16
25		UNIVERSAL RADIO COMMUNICATION TESTER	CMU200	106243	R&S	1 year	2023-03-16
26		Highpass Filter	WHKX1.5/15G-10SS	74	Wainwright Instruments	1 year	2023-03-16
27		Highpass Filter	WHKX3.0/18G-10SS	118	Wainwright Instruments	1 year	2023-03-16
28		OSP120 BASE UNIT	OSP120	101230	R&S	1 year	2023-03-16
29		Signal Generator(100 kHz ~ 40 GHz)	SMB100A03	177621	R&S	1 year	2023-03-16
30		Signal Analyzer (10 Hz ~ 40 GHz)	FSV40	101367	R&S	1 year	2023-03-16
31	■	Active Loop Antenna	FMZB 1519	1519-031	SCHWARZBECK	2 year	2023-02-26