

TEST REPORT

Report No.: 20091177HKG-002

Nacon (HK) Limited

Application For Certification
(Original Grant)

FCC ID: 2AVPR-7HX

IC: 25872-7HX

Transceiver

Prepared and Checked by:

Approved by:

Signed On File
Lee For Yiu, Florey
Assistant Engineer

Wong Kwok Yeung, Kenneth
Assistant Supervisor
Date: October 25, 2021

Intertek's standard Terms and Conditions can be obtained at our website <http://www.intertek.com/terms/>.

The test report only allows to be revised within the retention period unless further standard or the requirement was noticed.

This report is for the exclusive use of Intertek's Client and is provided pursuant to the agreement between Intertek and its Client. Intertek's responsibility and liability are limited to the terms and conditions of the agreement. Intertek assumes no liability to any party, other than to the Client in accordance with the agreement, for any loss, expense or damage occasioned by the use of this report. Only the Client is authorized to permit copying or distribution of this report and then only in its entirety. Any use of the Intertek name or one of its marks for the sale or advertisement of the tested material, product or service must first be approved in writing by Intertek. The observations and test results in this report are relevant only to the sample tested. This report by itself does not imply that the material, product, or service is or has ever been under an Intertek certification program.

© 2017 Intertek

TEST REPORT

GENERAL INFORMATION

Grantee:	Nacon (HK) Limited
Grantee Address:	Unit 1505, 148 Electric Road, North Point, Hong Kong.
Contact Person:	Johnny Wong
Tel:	+852 2512 3111
Fax:	/
e-mail:	johnny@nacon.com.hk
Manufacturer:	Nacon (HK) Limited
Manufacturer Address:	Unit 1505, 148 Electric Road, North Point, Hong Kong.
Brand Name:	Nacon
Model / HVIN:	700A
PMN:	RIG 700HX
Type of EUT:	Transceiver
Description of EUT:	Dongle
FCC ID / IC:	2AVPR-7HX / 25872-7HX
Date of Sample Submitted:	September 25, 2020
Date of Test:	September 25, 2020 to November 09, 2020
Report No.:	20091177HKG-002
Report Date:	October 25, 2021
Environmental Conditions:	Temperature: +10 to 40°C Humidity: 10 to 90%
Conclusion:	Test was conducted by client submitted sample. The submitted sample as received complied with the 47 CFR Part 15 / RSS-210 Issue 10 Certification.

TEST REPORT

SUMMARY OF TEST RESULT

Test Specification	Reference	Results
Transmitter Power Line Conducted Emissions	15.207 / RSS-Gen 8.8	Pass
Radiated Emission Radiated Emission on the Bandedge	15.249, 15.209 / RSS-210 B.10, RSS-210 4.4	Pass
Radiated Emission in Restricted Bands	15.205 / RSS-210 4.1	Pass
20dB Occupied Bandwidth	15.215 / RSS-210 4.1	Pass

The equipment under test is found to be complying with the following standards:

FCC Part 15, October 1, 2020 Edition

RSS-210 Issue 10 + A1 April 2020

RSS-Gen Issue 5 Amendment 1, March 2019

- Note:
1. The EUT uses a permanently attached antenna which, in accordance to section 15.203, is considered sufficient to comply with the provisions of this section.
 2. Pursuant to FCC part 15 Section 15.215(c), the 20 dB bandwidth of the emission was contained within the frequency band designated (mentioned as above) which the EUT operated. The effects, if any, from frequency sweeping, frequency hopping, other modulation techniques and frequency stability over excepted variations in temperature and supply voltage were considered.

TEST REPORT

TABLE OF CONTENTS

1.0 GENERAL DESCRIPTION 5

 1.1 Product Description5

 1.2 Related Submittal(s) Grants5

 1.3 Test Methodology.....5

 1.4 Test Facility5

2.0 SYSTEM TEST CONFIGURATION..... 6

 2.1 Justification6

 2.2 EUT Exercising Software.....6

 2.3 Special Accessories6

 2.4 Measurement Uncertainty.....7

 2.5 Support Equipment List and Description.....7

3.0 EMISSION RESULTS..... 8

 3.1 Field Strength Calculation8

 3.2 Radiated Emission Configuration Photograph.....9

 3.3 Radiated Emission Data9

 3.4 Conducted Emission Configuration Photograph9

 3.5 Conducted Emission Data9

4.0 EQUIPMENT PHOTOGRAPHS 30

5.0 PRODUCT LABELLING..... 30

6.0 TECHNICAL SPECIFICATIONS 30

7.0 INSTRUCTION MANUAL..... 30

8.0 MISCELLANEOUS INFORMATION 31

 8.1 Radiated Emission on the Bandedge.....31

 8.2 Emissions Test Procedures.....36

 8.3 Occupied Bandwidth.....40

9.0 CONFIDENTIALITY REQUEST 44

10.0 EQUIPMENT LIST 44

TEST REPORT

1.0 GENERAL DESCRIPTION

1.1 Product Description

The Equipment Under Test is a Gaming Headset Dongle of 2.4GHz Wireless Headphone with Dongle and Docking (Cradle). The EUT operates at frequency range of 2403.35MHz to 2479.35MHz. There are total 39 channels with 2MHz channel spacing. The EUT is powered by USB port (5VDC). The EUT has two antenna.

The EUT is powered by notebook for 5.00VDC. After switching on the EUT, it will be emitting sound based on the button pressed on the EUT.

Antenna Type: Internal, Integral

For electronic filing, the brief circuit description is saved with filename: descri.pdf.

1.2 Related Submittal(s) Grants

This is a single application for certification of a transceiver.

1.3 Test Methodology

Both AC mains line-conducted and radiated emission measurements were performed according to the procedures in ANSI C63.10 (2013). All radiated measurements were performed in an 3m Chamber. Preliminary scans were performed in the 3m Chamber only to determine worst case modes. All radiated tests were performed at an antenna to EUT distance of 3 meters, unless stated otherwise in the “**Justification Section**” of this Application.

1.4 Test Facility

The 3m Chamber and conducted measurement facility used to collect the radiated data is located at Shenzhen UnionTrust Quality and Technology Co., Ltd. (Address: 16/F, Block A, Building 6, Baoneng Science and Technology Park, Qingxiang Road No.1, Longhua New District, Shenzhen, China). This test facility and site measurement data have been placed on file with the FCC and IC.

IC test site Company Number: 21600

CAB identifier: CN0032

TEST REPORT

2.0 SYSTEM TEST CONFIGURATION

2.1 Justification

The system was configured for testing in a typical fashion (as a customer would normally use it), and in the confines as outlined in ANSI C63.10 (2013).

The device was powered by notebook for 5.00VDC.

For maximizing emissions, the EUT was rotated through 360°, the antenna height was varied from 1 meter to 4 meters above the ground plane, and the antenna polarization was changed. This step by step procedure for maximizing emissions led to the data reported in Exhibit 3.0.

The unit was operated standalone and placed in the center of the turntable.

The equipment under test (EUT) was configured for testing in a typical fashion (as a customer would normally use it). The EUT was mounted to a plastic stand if necessary and placed on the wooden turntable, which enabled the engineer to maximize emissions through its placement in the three orthogonal axes.

2.2 EUT Exercising Software

There was no special software to exercise the device. Once the unit is powered up, it receives the RF signal continuously.

2.3 Special Accessories

There are no special accessories necessary for compliance of this product.

TEST REPORT

2.4 Measurement Uncertainty

Decision Rule for compliance: For FCC/IC standard, the measured value must be within the limits of applicable standard without accounting for the measurement uncertainty. For EN/IEC/HKTA/HKTC standard, conformity rules will be used as per standard directly excepted EN/IEC 61000-3-2, EN/IEC 61000-3-3, HKTA1004, HKCA1008, HKTA1019, HKTA1020, HKTA1041 and HKTA1044. For these excepted or not mentioned standards, Cl 4.2.2 of ILAC-G8:09/2019 decision rules will be reference and guard band will be equal to our measurement uncertainty with 95% confidence level (k=2). In case, the measured value is within guard band region, undetermined decision will be used.

Uncertainty and Compliance - Unless the standard specifically states that measured values are to be extended by the measurement uncertainty in determining compliance, all compliance determinations are based on the actual measured value.

No.	Item	Measurement Uncertainty
1	Conducted emission 9KHz-150KHz	±3.2 dB
2	Conducted emission 150KHz-30MHz	±2.7 dB
3	Radiated emission 9KHz-30MHz	± 4.7 dB
4	Radiated emission 30MHz-1GHz	± 4.9 dB
5	Radiated emission 1GHz-18GHz	± 4.8 dB
6	Radiated emission 18GHz-26GHz	± 5.1 dB
7	Radiated emission 26GHz-40GHz	± 5.1 dB
8	Conducted spurious emissions	± 2.7 dB
9	RF Power, Conducted	± 0.9 dB
10	Occupied Bandwidth	± 1.86 %
11	Radio Frequency	2.4 GHz: ± 6.5 x 10 ⁻⁸
12	Transmission Time	± 0.19 %

2.5 Support Equipment List and Description

N/A.

TEST REPORT

3.0 EMISSION RESULTS

Data is included of the worst case configuration (the configuration which resulted in the highest emission levels). A sample calculation, configuration photographs and data tables of the emissions are included.

3.1 Field Strength Calculation

The field strength is calculated by adding the Antenna Factor and Cable Factor, and subtracting the Amplifier Gain (if any), Average Factor (optional) from the measured reading. The basic equation with a sample calculation is as follows:

$$FS = RA + AF + CF - AG - AV$$

where FS = Field Strength in dB μ V/m

RA = Receiver Amplitude (including preamplifier) in dB μ V

CF = Cable Attenuation Factor in dB

AF = Antenna Factor in dB

AG = Amplifier Gain in dB

AV = Average Factor in dB

In the following table(s), the reading shown on the data table reflects the preamplifier gain. An example for the calculations in the following table is as follows:

$$FS = RR + LF$$

where FS = Field Strength in dB μ V/m

RR = RA - AG - AV in dB μ V

LF = CF + AF in dB

Assume a receiver reading of 52.0 dB μ V is obtained. The antenna factor of 7.4 dB and cable factor of 1.6 dB are added. The amplifier gain of 29 dB and average factor of 5 dB are subtracted, giving a field strength of 27 dB μ V/m. This value in dB μ V/m was converted to its corresponding level in μ V/m.

$$RA = 52.0 \text{ dB}\mu\text{V/m}$$

$$AF = 7.4 \text{ dB}$$

$$CF = 1.6 \text{ dB}$$

$$AG = 29.0 \text{ dB}$$

$$AV = 5.0 \text{ dB}$$

$$FS = RR + LF$$

$$FS = 18 + 9 = 27 \text{ dB}\mu\text{V/m}$$

$$RR = 18.0 \text{ dB}\mu\text{V}$$

$$LF = 9.0 \text{ dB}$$

$$\text{Level in } \mu\text{V/m} = \text{Common Antilogarithm } [(27 \text{ dB}\mu\text{V/m})/20] = 22.4 \mu\text{V/m}$$

TEST REPORT

3.2 Radiated Emission Configuration Photograph

The worst case in radiated emission was found at 2479.35 MHz

For electronic filing, the worst case radiated emission configuration photographs are saved with filename: radiated photos.pdf.

3.3 Radiated Emission Data

The data on the following page lists the significant emission frequencies, the limit and the margin of compliance. Numbers with a minus sign are below the limit.

Judgment: Passed by 1.96 dB

3.4 Conducted Emission Configuration Photograph

The worst case in line-conducted emission was found at 15.717 MHz

For electronic filing, the worst case line-conducted configuration photographs are saved with filename: conducted photo.pdf.

3.5 Conducted Emission Data

For electronic filing, the graph and data table of conducted emission is saved with filename: conducted.pdf.

Judgment: Pass by 8.28 dB

TEST REPORT

CONDUCTED EMISSION

Model: RIG700HX

Date of Test: November 09, 2020

Worst-Case Operating Mode: Transmitting

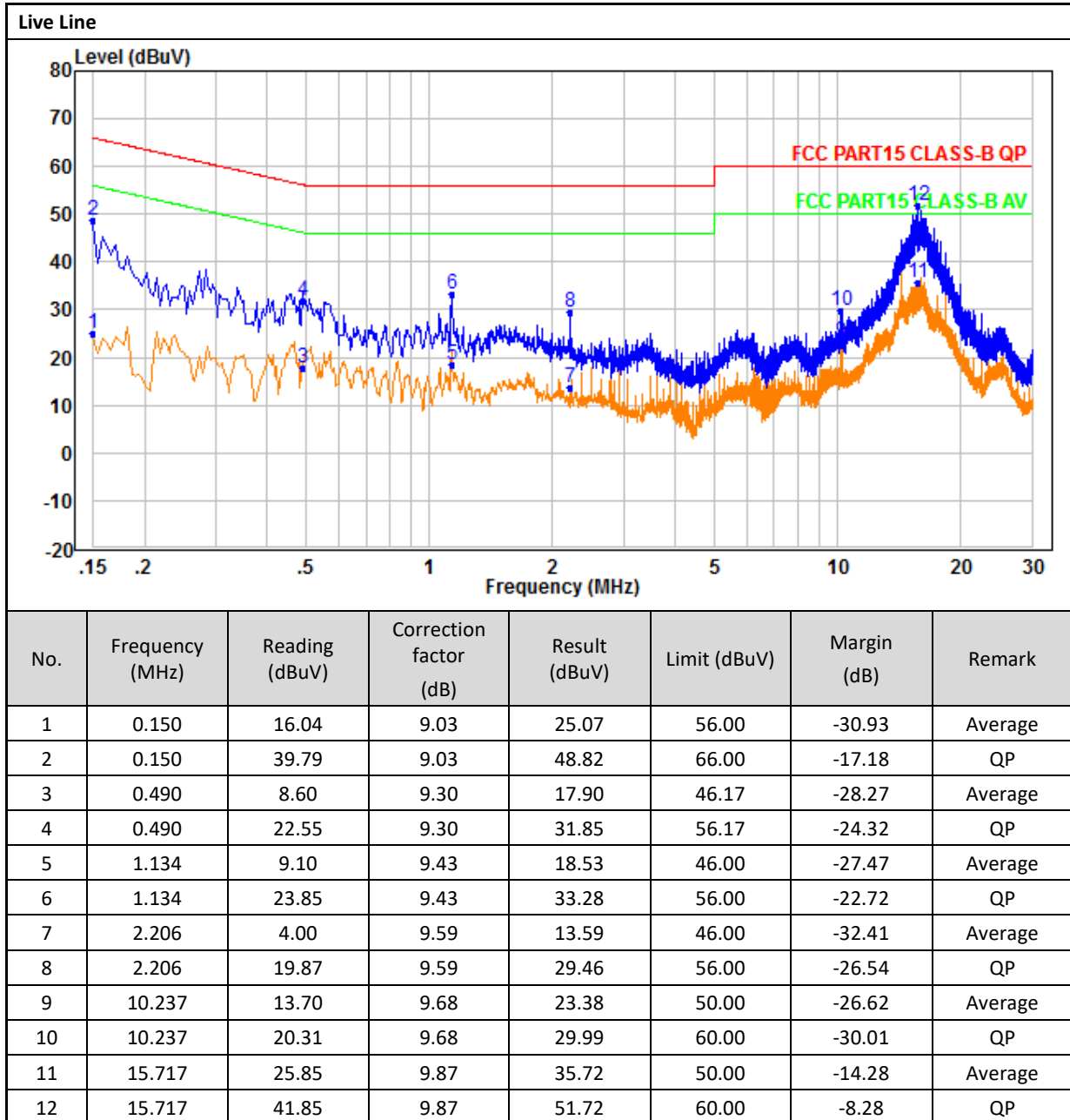

TEST REPORT

Model: RIG700HX

Date of Test: November 09, 2020

Worst-Case Operating Mode: Transmitting

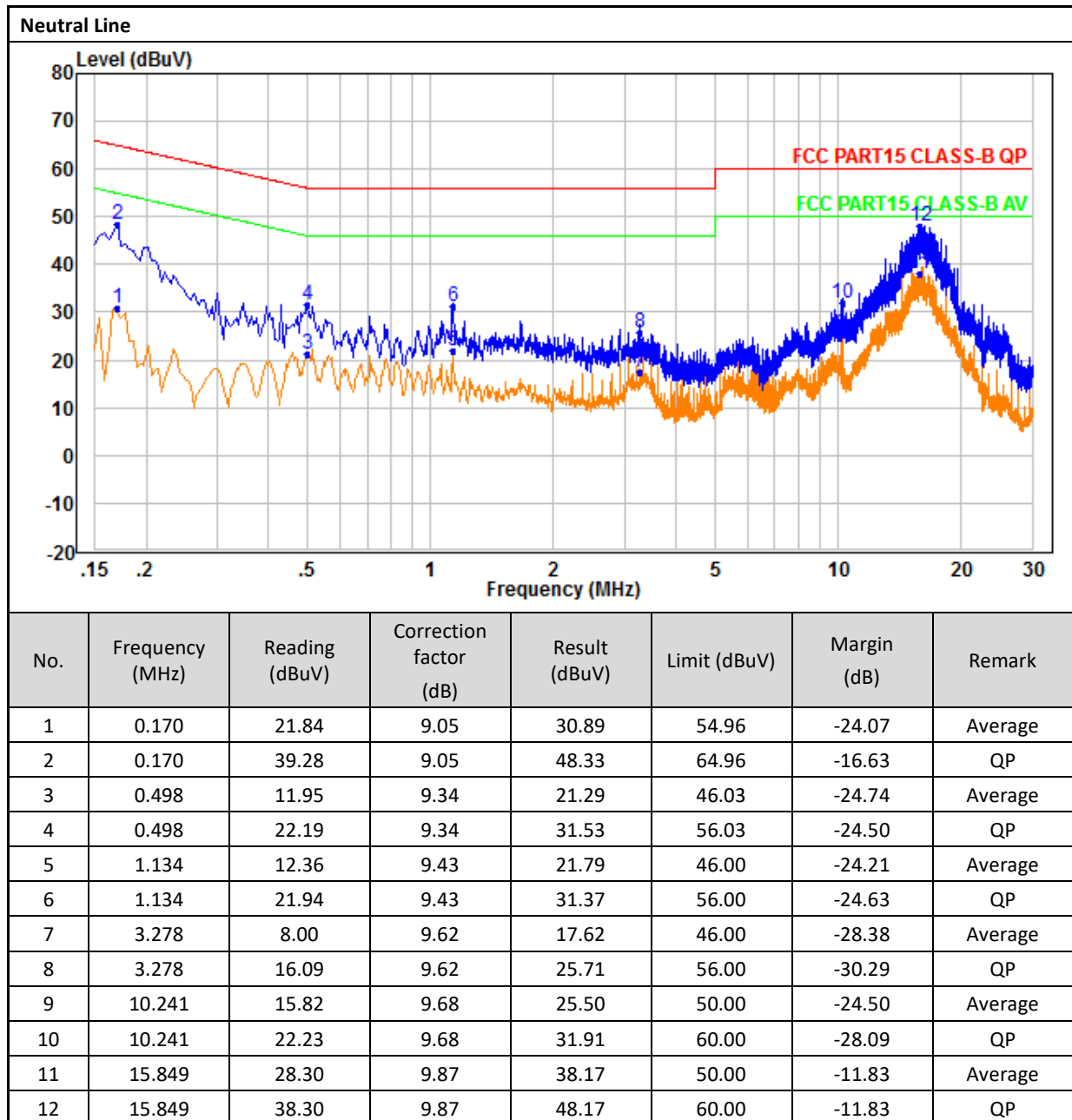

Note:

1. Correct Factor = LISN Factor + Cable Loss + Pulse Limiter Factor, the value was added to Original Receiver Reading by the software automatically.
2. Result = Reading + Correct Factor.
3. Margin = Result - Limit
4. An initial pre-scan was performed on the Phase and neutral lines with peak detector. Quasi-Peak and Average measurement were performed at the frequencies with maximized peak emission were detected.
5. Measurement Uncertainty is ± 2.7 dB at a level of confidence of 95%.

TEST REPORT

RADIATED EMISSIONS

Model: RIG700HX

Date of Test: November 09, 2020

Worst-Case Operating Mode: Transmitting

Table 1
Pursuant to FCC Part 15 Section 15.249 / RSS-210 B10.0 Requirement

ANTO:

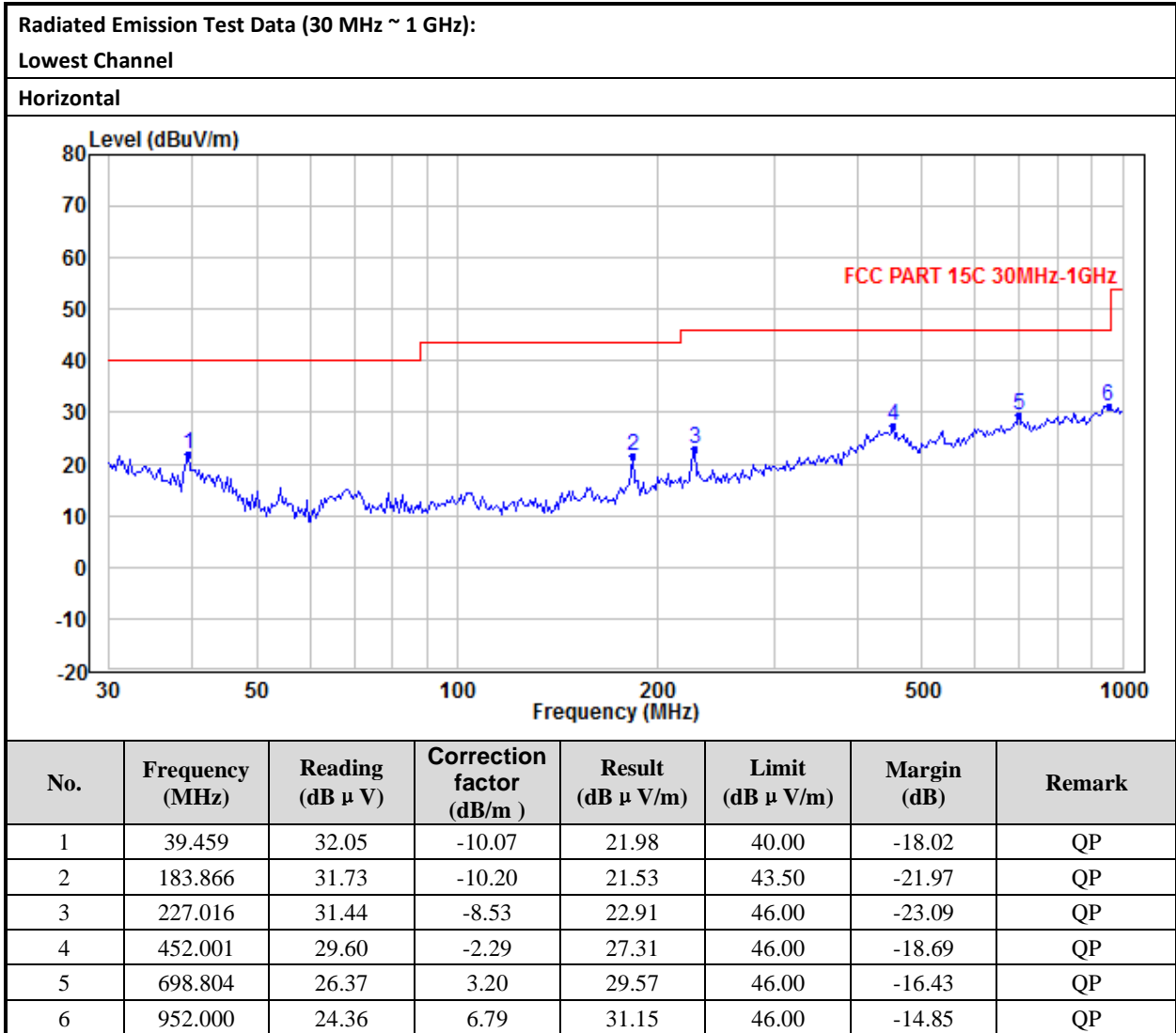

TEST REPORT

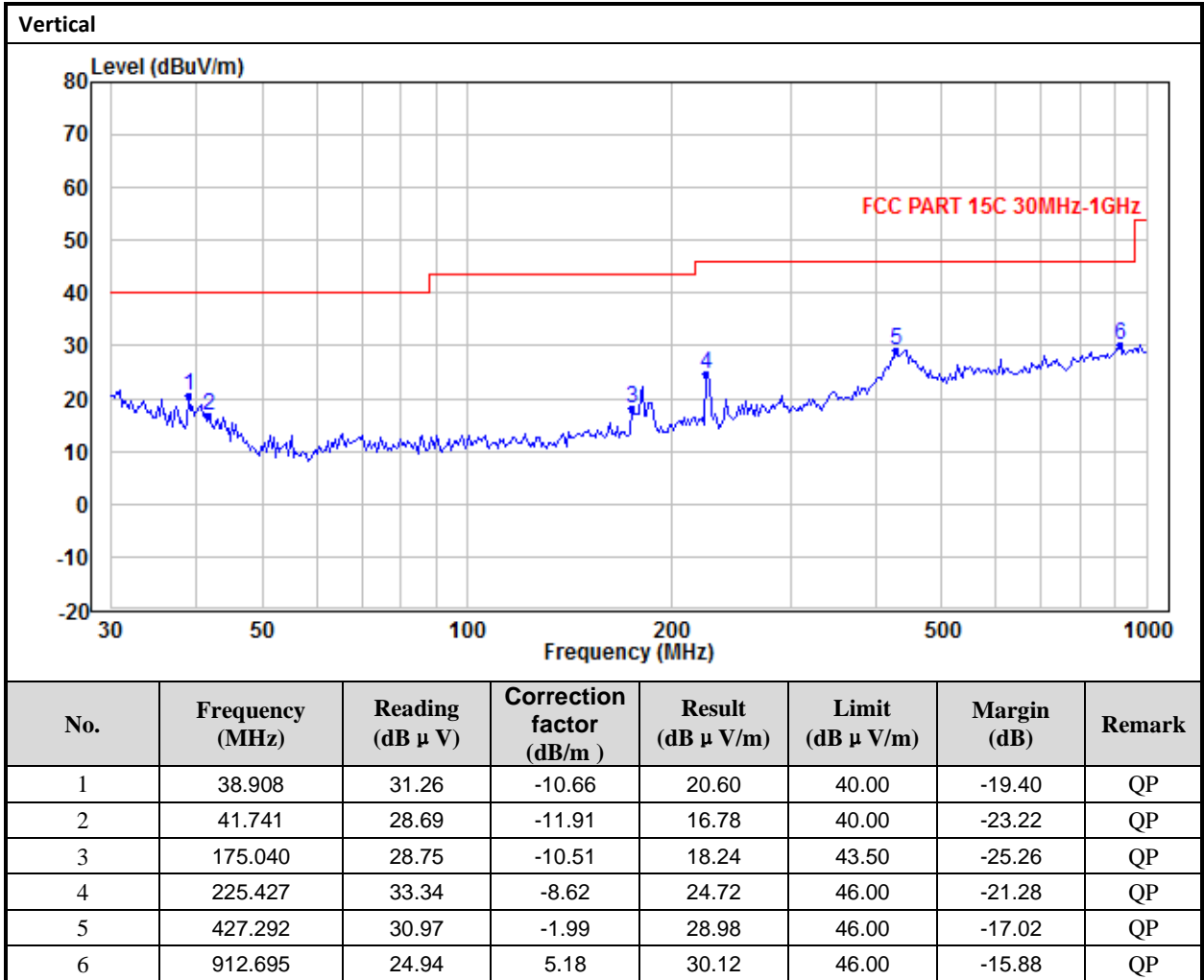

TEST REPORT

Radiated Emission Test Data (Above 1GHz):								
Lowest Channel:								
No.	Frequency (MHz)	Reading (dBµV/m)	Correction factor (dB)	Result (dBµV/m)	Limit (dBµV/m)	Margin (dB)	Detector	Antenna Polaxis
1	2403.35	94.21	-6.19	88.02	114.00	-25.98	Peak	Horizontal
2	2403.35	94.21	-6.19	88.02	94.00	-5.98	Average	Horizontal
3	2403.35	94.63	-9.59	85.04	114.00	-28.96	Peak	Vertical
4	2403.35	94.63	-9.59	85.04	94.00	-8.96	Average	Vertical
5	4806.70	45.36	-3.32	42.04	74.00	-31.96	Peak	Horizontal
6	4806.70	45.36	-3.32	42.04	54.00	-11.96	Average	Horizontal
7	7210.05	44.68	0.84	45.52	74.00	-28.48	Peak	Horizontal
8	7210.05	44.68	0.84	45.52	54.00	-8.48	Average	Horizontal
9	4806.70	45.47	-3.07	42.40	74.00	-31.60	Peak	Vertical
10	4806.70	45.47	-3.07	42.40	54.00	-11.60	Average	Vertical
11	7210.05	45.49	1.08	46.57	74.00	-27.43	Peak	Vertical
12	7210.05	45.49	1.08	46.57	54.00	-7.43	Average	Vertical

TEST REPORT

ANT1:

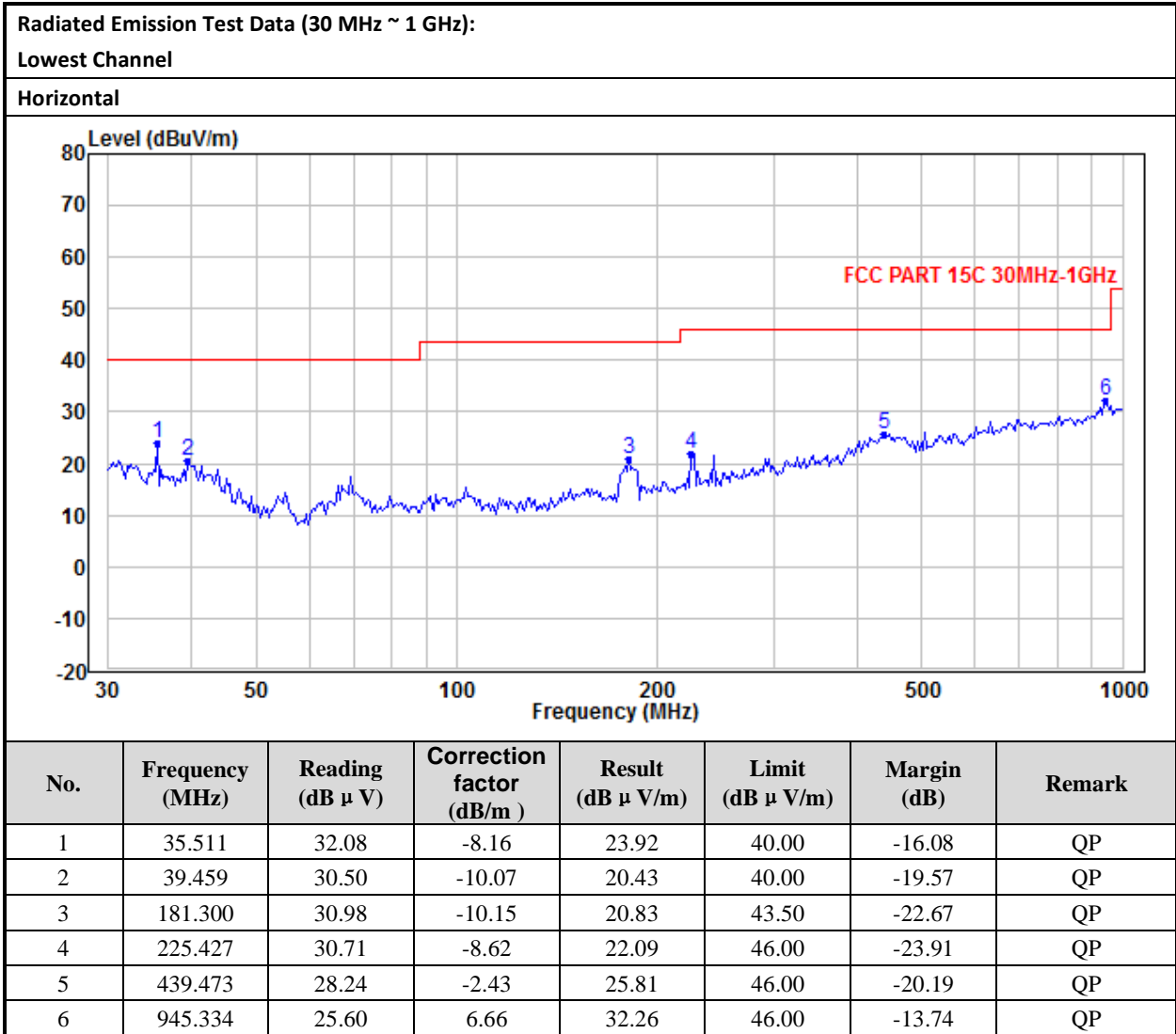

TEST REPORT

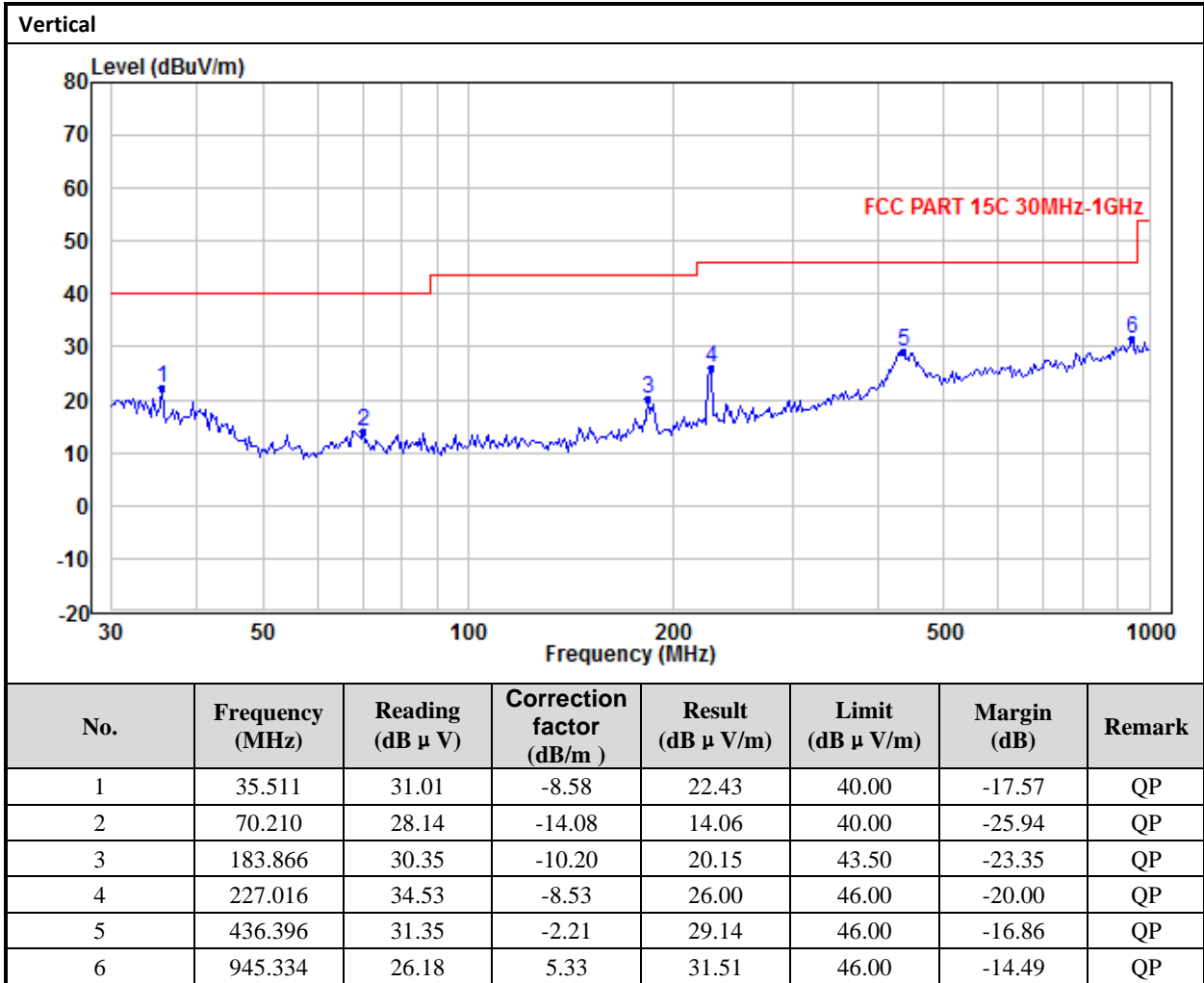

TEST REPORT

Radiated Emission Test Data (Above 1GHz):								
Lowest Channel:								
No.	Frequency (MHz)	Reading (dBµV/m)	Correction factor (dB)	Result (dBµV/m)	Limit (dBµV/m)	Margin (dB)	Detector	Antenna Polaxis
1	2403.35	97.64	-9.17	88.47	114.00	-25.53	Peak	Horizontal
2	2403.35	97.64	-9.17	88.47	94.00	-5.53	Average	Horizontal
3	2403.35	94.92	-9.60	85.32	114.00	-28.68	Peak	Vertical
4	2403.35	94.92	-9.60	85.32	94.00	-8.68	Average	Vertical
5	4806.70	44.79	-3.32	41.47	74.00	-32.53	Peak	Horizontal
6	4806.70	44.79	-3.32	41.47	54.00	-12.53	Average	Horizontal
7	7210.05	45.23	0.84	46.07	74.00	-27.93	Peak	Horizontal
8	7210.05	45.23	0.84	46.07	54.00	-7.93	Average	Horizontal
9	4806.70	45.74	-3.21	42.53	74.00	-31.47	Peak	Vertical
10	4806.70	45.74	-3.21	42.53	54.00	-11.47	Average	Vertical
11	7210.05	44.70	0.94	45.64	74.00	-28.36	Peak	Vertical
12	7210.05	44.70	0.94	45.64	54.00	-8.36	Average	Vertical

- NOTES:
1. Peak Detector Data unless otherwise stated.
 2. Average detector is applied according to ANSI C63.10.
 3. All measurements were made at 3 meters.
 4. Negative sign in the column shows value below limit.
 5. Horn antenna is used for the emission over 1000MHz.
 6. Emission (the row indicated by **bold italic**) within the restricted band meets the requirement of FCC Part 15 Section 15.205 / RSS-210 4.1.
 7. Measurement Uncertainty is ±5.1dB at a level of confidence of 95%.

TEST REPORT

Model: RIG700HX
Date of Test: November 09, 2020
Worst-Case Operating Mode: Transmitting

Table 2
Pursuant to FCC Part 15 Section 15.249 / RSS-210 B10.0 Requirement

ANT0:

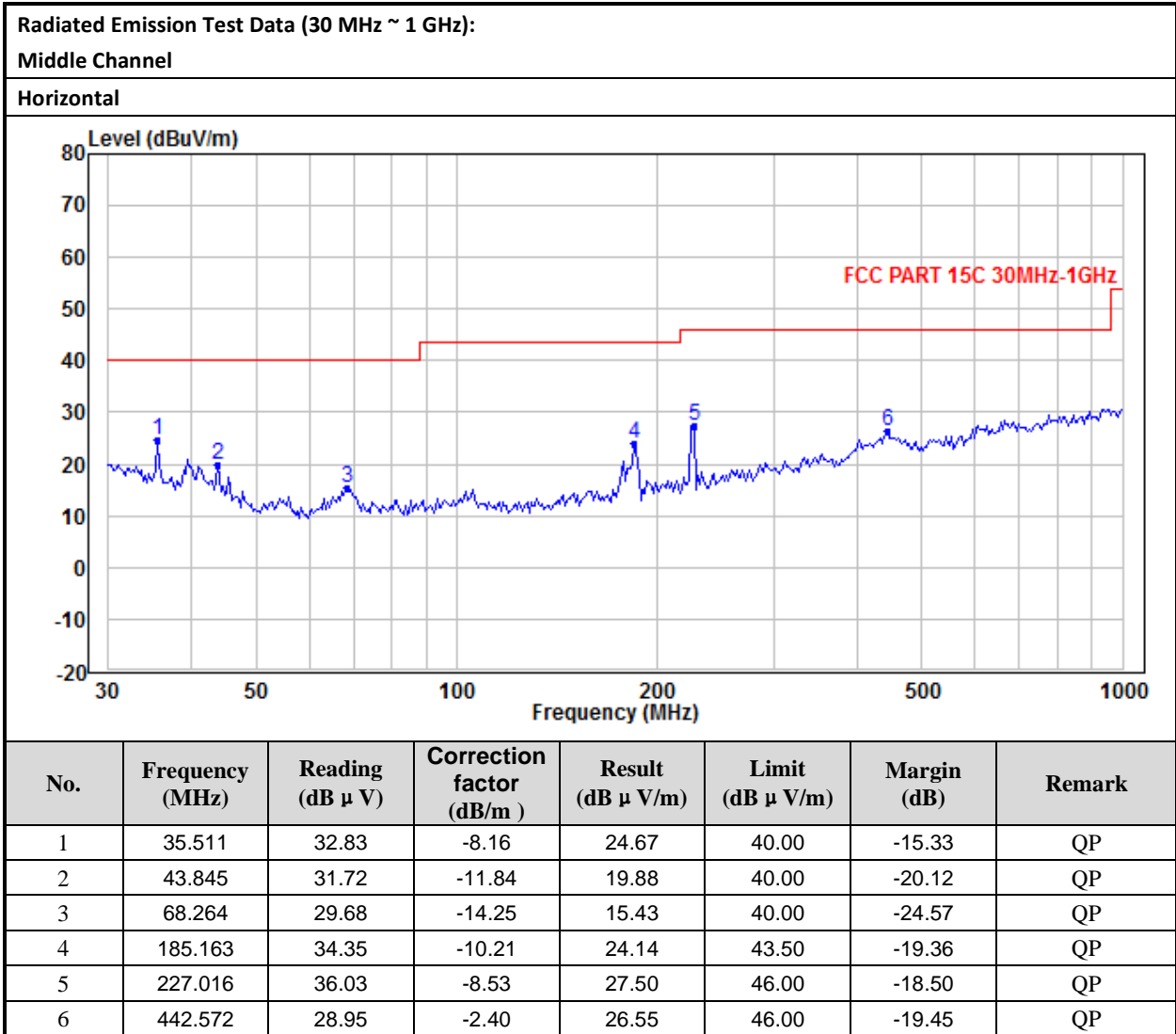

TEST REPORT

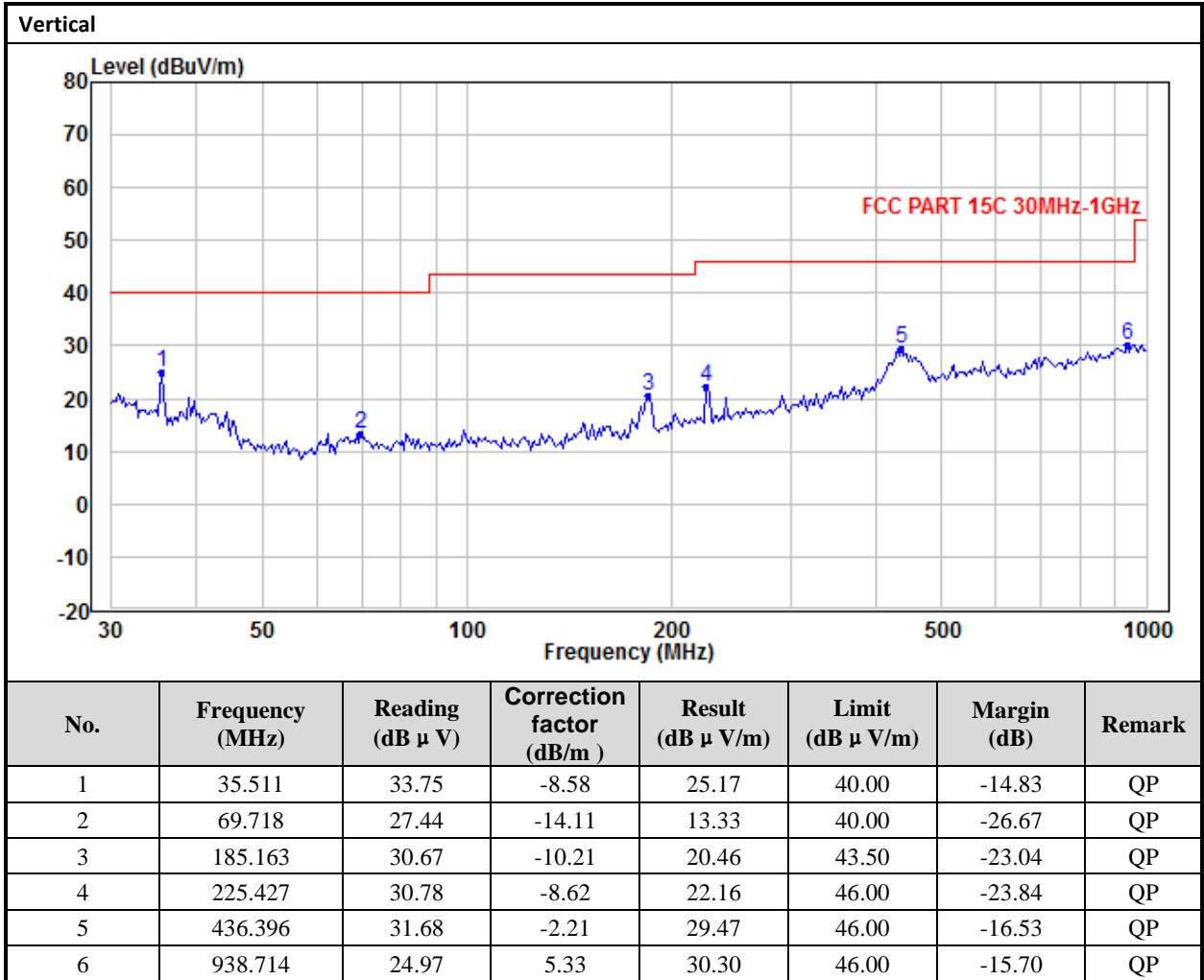

TEST REPORT

Radiated Emission Test Data (Above 1GHz):								
Middle Channel:								
No.	Frequency (MHz)	Reading (dBµV/m)	Correction factor (dB)	Result (dBµV/m)	Limit (dBµV/m)	Margin (dB)	Detector	Antenna Polaxis
1	2439.35	95.42	-9.09	86.33	114.00	-27.67	Peak	Horizontal
2	2439.35	95.42	-9.09	86.33	94.00	-7.67	Average	Horizontal
3	2439.35	93.19	-9.52	83.67	114.00	-30.33	Peak	Vertical
4	2439.35	93.19	-9.52	83.67	94.00	-10.33	Average	Vertical
5	4878.70	45.83	-3.24	42.59	74.00	-31.41	Peak	Horizontal
6	4878.70	45.83	-3.24	42.59	54.00	-11.41	Average	Horizontal
7	7318.05	44.53	0.98	45.51	74.00	-28.49	Peak	Horizontal
8	7318.05	44.53	0.98	45.51	54.00	-8.49	Average	Horizontal
9	4878.70	45.29	-3.07	42.22	74.00	-31.78	Peak	Vertical
10	4878.70	45.29	-3.07	42.22	54.00	-11.78	Average	Vertical
11	7318.05	45.23	1.08	46.31	74.00	-27.69	Peak	Vertical
12	7318.05	45.23	1.08	46.31	54.00	-7.69	Average	Vertical

TEST REPORT

ANT1:

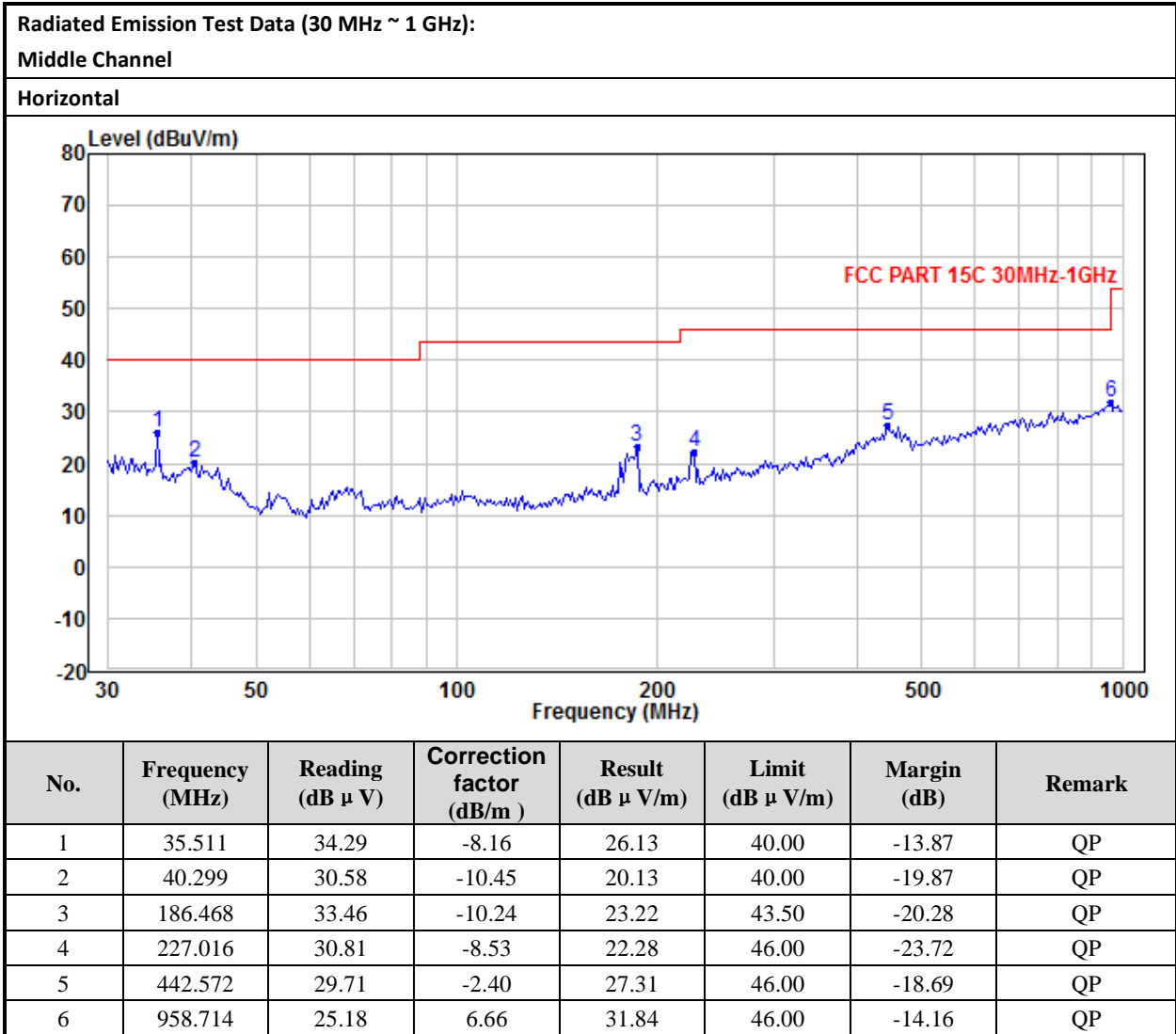

TEST REPORT

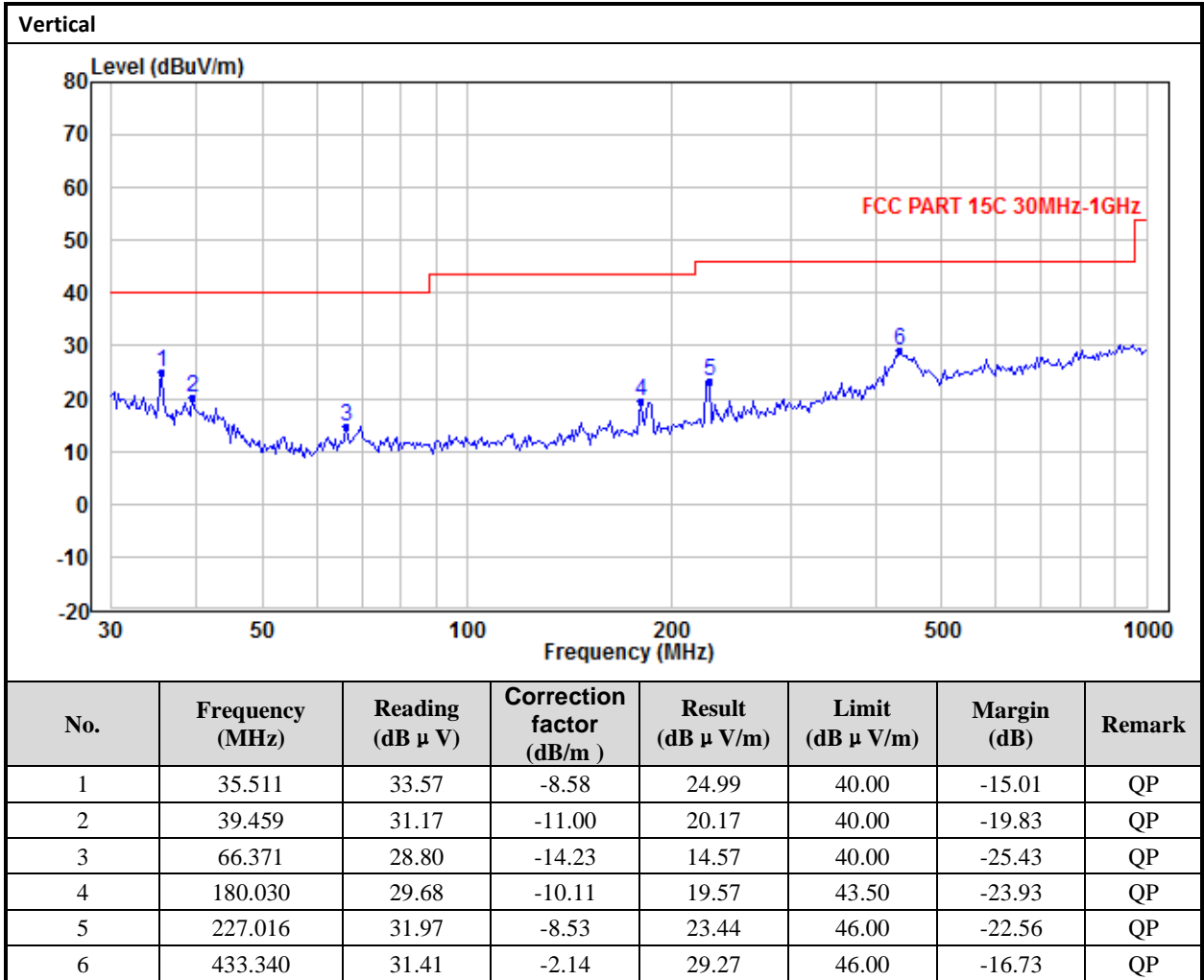

TEST REPORT

Radiated Emission Test Data (Above 1GHz):								
Middle Channel:								
No.	Frequency (MHz)	Reading (dBµV/m)	Correction factor (dB)	Result (dBµV/m)	Limit (dBµV/m)	Margin (dB)	Detector	Antenna Polaxis
1	2439.35	95.57	-9.09	86.48	114.00	-27.52	Peak	Horizontal
2	2439.35	95.57	-9.09	86.48	94.00	-7.52	Average	Horizontal
3	2439.35	93.45	-9.51	83.94	114.00	-30.06	Peak	Vertical
4	2439.35	93.45	-9.51	83.94	94.00	-10.06	Average	Vertical
5	4878.70	44.66	-3.24	41.42	74.00	-32.58	Peak	Horizontal
6	4878.70	44.66	-3.24	41.42	54.00	-12.58	Average	Horizontal
7	7318.05	45.41	0.98	46.39	74.00	-27.61	Peak	Horizontal
8	7318.05	45.41	0.98	46.39	54.00	-7.61	Average	Horizontal
9	4878.70	45.01	-3.07	41.94	74.00	-32.06	Peak	Vertical
10	4878.70	45.01	-3.07	41.94	54.00	-12.06	Average	Vertical
11	7318.05	45.10	1.08	46.18	74.00	-27.82	Peak	Vertical
12	7318.05	45.10	1.08	46.18	54.00	-7.82	Average	Vertical

- NOTES:
1. Peak Detector Data unless otherwise stated.
 2. Average detector is applied according to ANSI C63.10.
 3. All measurements were made at 3 meters.
 4. Negative sign in the column shows value below limit.
 5. Horn antenna is used for the emission over 1000MHz.
 6. Emission (the row indicated by ***bold italic***) within the restricted band meets the requirement of FCC Part 15 Section 15.205 / RSS-210 4.1.
 7. Measurement Uncertainty is ±5.1dB at a level of confidence of 95%.

TEST REPORT

Model: RIG700HX
Date of Test: November 09, 2020
Worst-Case Operating Mode: Transmitting

Table 3
Pursuant to FCC Part 15 Section 15.249 / RSS-210 B10.0 Requirement

ANT0:

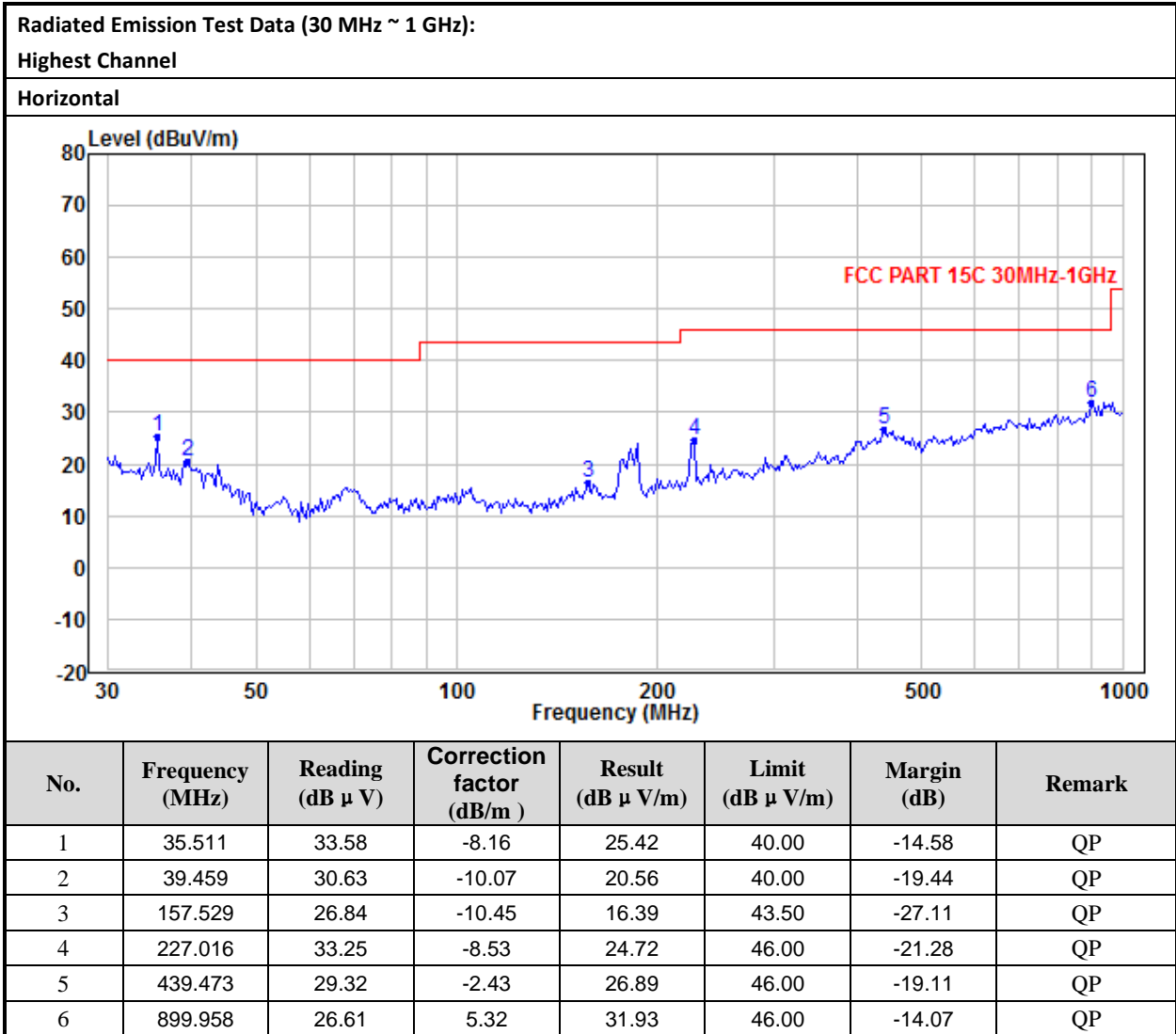

TEST REPORT

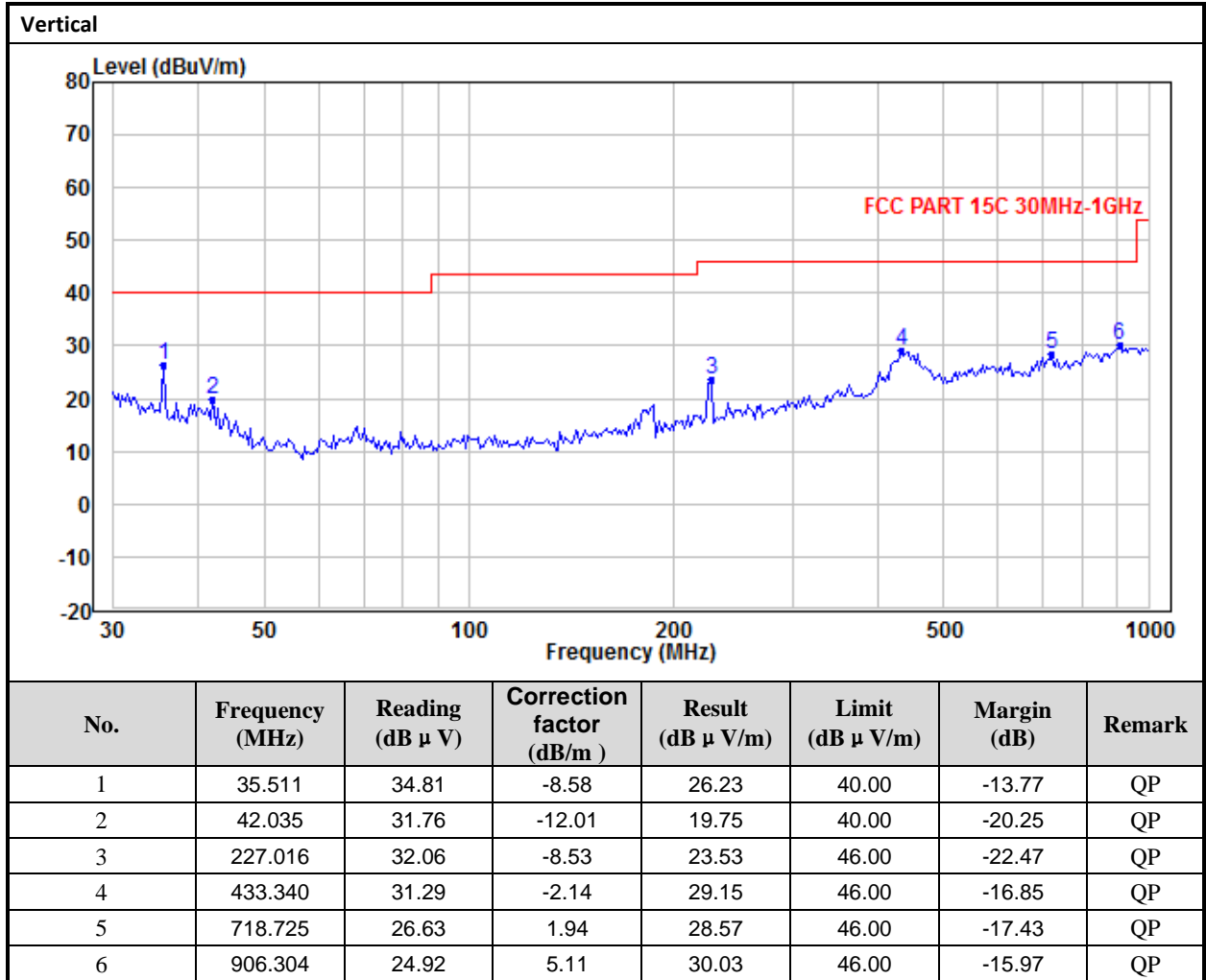

TEST REPORT

Radiated Emission Test Data (Above 1GHz):								
Highest Channel:								
No.	Frequency (MHz)	Reading (dBµV/m)	Correction factor (dB)	Result (dBµV/m)	Limit (dBµV/m)	Margin (dB)	Detector	Antenna Polaxis
1	2479.35	100.88	-9.00	91.88	114.00	-22.12	Peak	Horizontal
2	2479.35	100.88	-9.00	91.88	94.00	-2.12	Average	Horizontal
3	2479.35	100.45	-9.40	91.05	114.00	-22.95	Peak	Vertical
4	2479.35	100.45	-9.40	91.05	94.00	-2.95	Average	Vertical
5	4958.70	45.17	-3.17	42.00	74.00	-32.00	Peak	Horizontal
6	4958.70	45.17	-3.17	42.00	54.00	-12.00	Average	Horizontal
7	7438.05	44.88	1.13	46.01	74.00	-27.99	Peak	Horizontal
8	7438.05	44.88	1.13	46.01	54.00	-7.99	Average	Horizontal
9	4958.70	44.98	-2.91	42.07	74.00	-31.93	Peak	Vertical
10	4958.70	44.98	-2.91	42.07	54.00	-11.93	Average	Vertical
11	7438.05	45.04	1.23	46.27	74.00	-27.73	Peak	Vertical
12	7438.05	45.04	1.23	46.27	54.00	-7.73	Average	Vertical

TEST REPORT

ANT1:

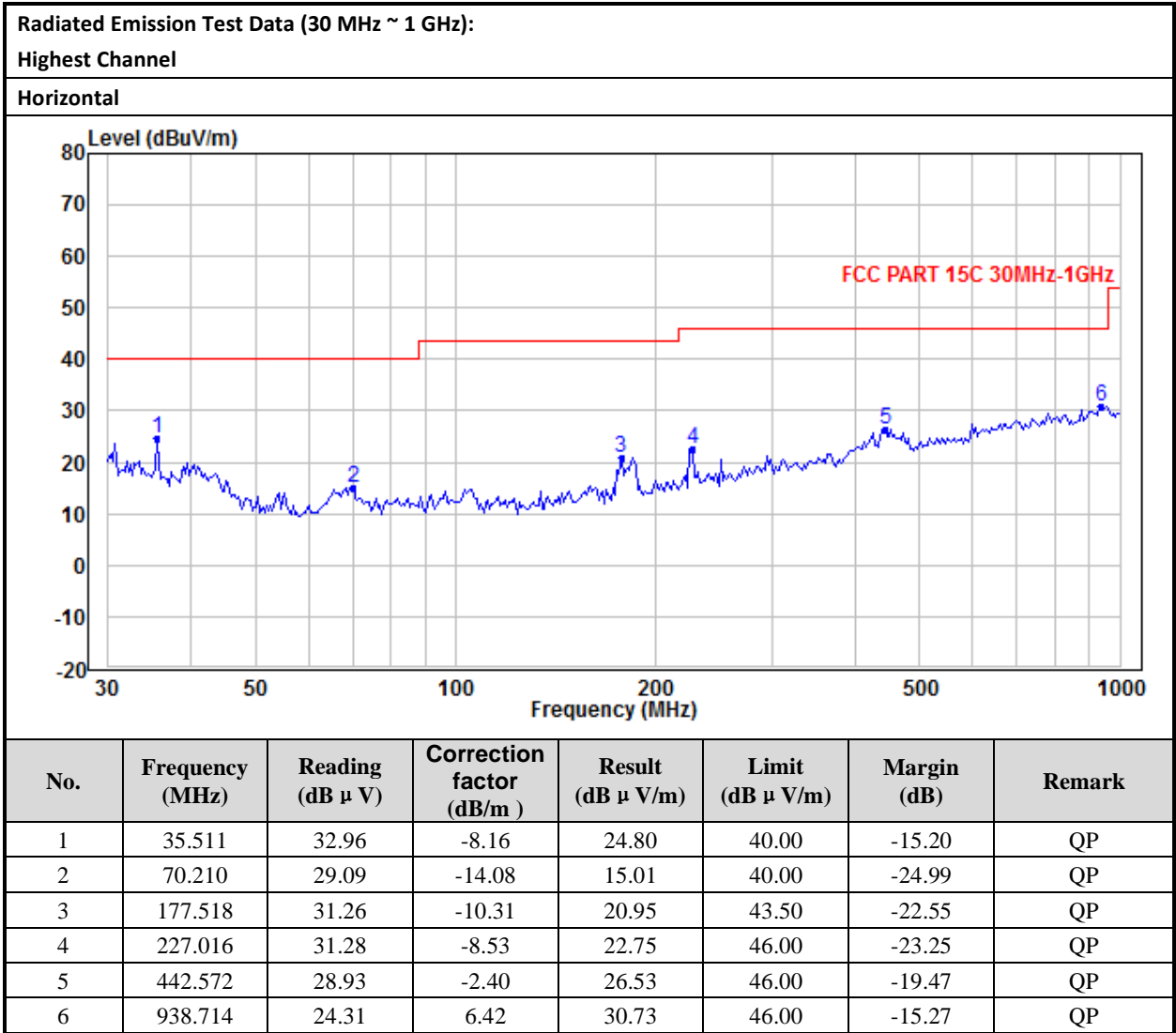

TEST REPORT

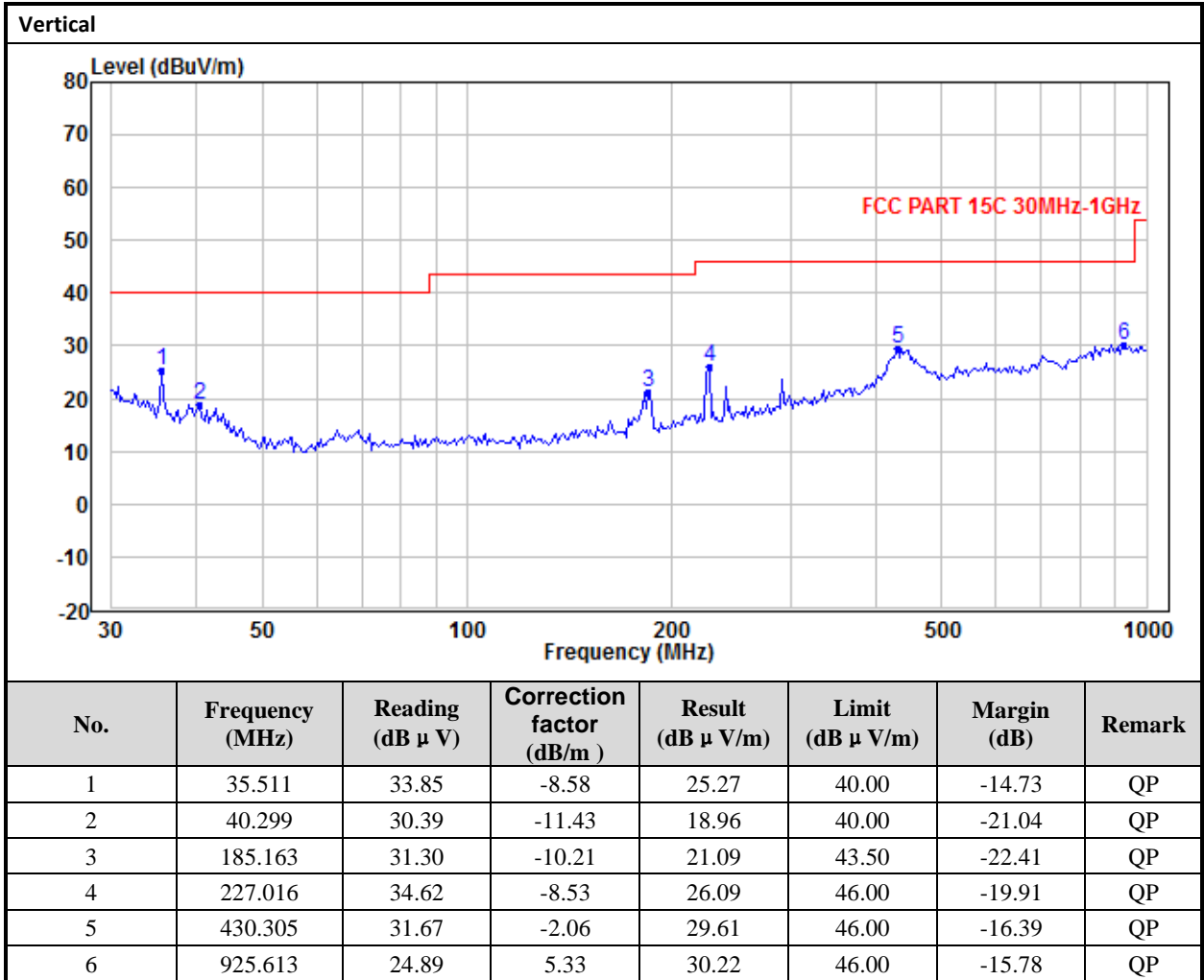

TEST REPORT

Radiated Emission Test Data (Above 1GHz):								
Highest Channel:								
No.	Frequency (MHz)	Reading (dBµV/m)	Correction factor (dB)	Result (dBµV/m)	Limit (dBµV/m)	Margin (dB)	Detector	Antenna Polaxis
1	2479.35	101.04	-9.00	92.04	114.00	-21.96	Peak	Horizontal
2	2479.35	101.04	-9.00	92.04	94.00	-1.96	Average	Horizontal
3	2479.35	99.44	-9.40	90.04	114.00	-23.96	Peak	Vertical
4	2479.35	99.44	-9.40	90.04	94.00	-3.96	Average	Vertical
5	4958.70	45.05	-3.17	41.88	74.00	-32.12	Peak	Horizontal
6	4958.70	45.05	-3.17	41.88	54.00	-12.12	Average	Horizontal
7	7438.05	44.49	1.13	45.62	74.00	-28.38	Peak	Horizontal
8	7438.05	44.49	1.13	45.62	54.00	-8.38	Average	Horizontal
9	4958.70	44.95	-2.91	42.04	74.00	-31.96	Peak	Vertical
10	4958.70	44.95	-2.91	42.04	54.00	-11.96	Average	Vertical
11	7438.05	44.91	1.23	46.14	74.00	-27.86	Peak	Vertical
12	7438.05	44.91	1.23	46.14	54.00	-7.86	Average	Vertical

- NOTES:
1. Peak Detector Data unless otherwise stated.
 2. Average detector is applied according to ANSI C63.10.
 3. All measurements were made at 3 meters.
 4. Negative sign in the column shows value below limit.
 5. Horn antenna is used for the emission over 1000MHz.
 6. Emission (the row indicated by **bold italic**) within the restricted band meets the requirement of FCC Part 15 Section 15.205 / RSS-210 4.1.
 7. Measurement Uncertainty is ±5.1dB at a level of confidence of 95%.

TEST REPORT

4.0 EQUIPMENT PHOTOGRAPHS

For electronic filing, the photographs are saved with filename: external photos.pdf and internal photos.pdf.

5.0 PRODUCT LABELLING

For electronics filing, the FCC ID label artwork and the label location are saved with filename: label.pdf.

6.0 TECHNICAL SPECIFICATIONS

For electronic filing, the block diagram and schematic of the tested EUT are saved with filename: block.pdf and circuit.pdf respectively.

7.0 INSTRUCTION MANUAL

For electronic filing, a preliminary copy of the Instruction Manual is saved with filename: manual.pdf.

This manual will be provided to the end-user with each unit sold/leased in the United States and Canada.

TEST REPORT

8.0 MISCELLANEOUS INFORMATION

The miscellaneous information includes details of the test procedure and measured bandwidth / calculation of factor such as pulse desensitization and averaging factor (calculation and timing diagram).

8.1 Radiated Emission on the Bandedge

From the following plots, they show that the fundamental emissions are confined in the specified band (2400MHz to 2483.5MHz). In case of the fundamental emissions are within two standard bandwidths from the bandedge, the delta measurement technique is used for determining bandedge compliance. Standard bandwidth is the bandwidth specified by ANSI C63.10 (2013) for frequency being measured.

Emissions radiated outside of the specified frequency bands, except harmonics, are attenuated by 50dB below the level of the fundamental or to the general radiated emissions limits in Section 15.209 / RSS-210 4.4, whichever is the lesser attenuation, which meet the requirement of part 15.249(d) / RSS-210 B.10.

TEST REPORT

PEAK MEASUREMENT

ANTO:

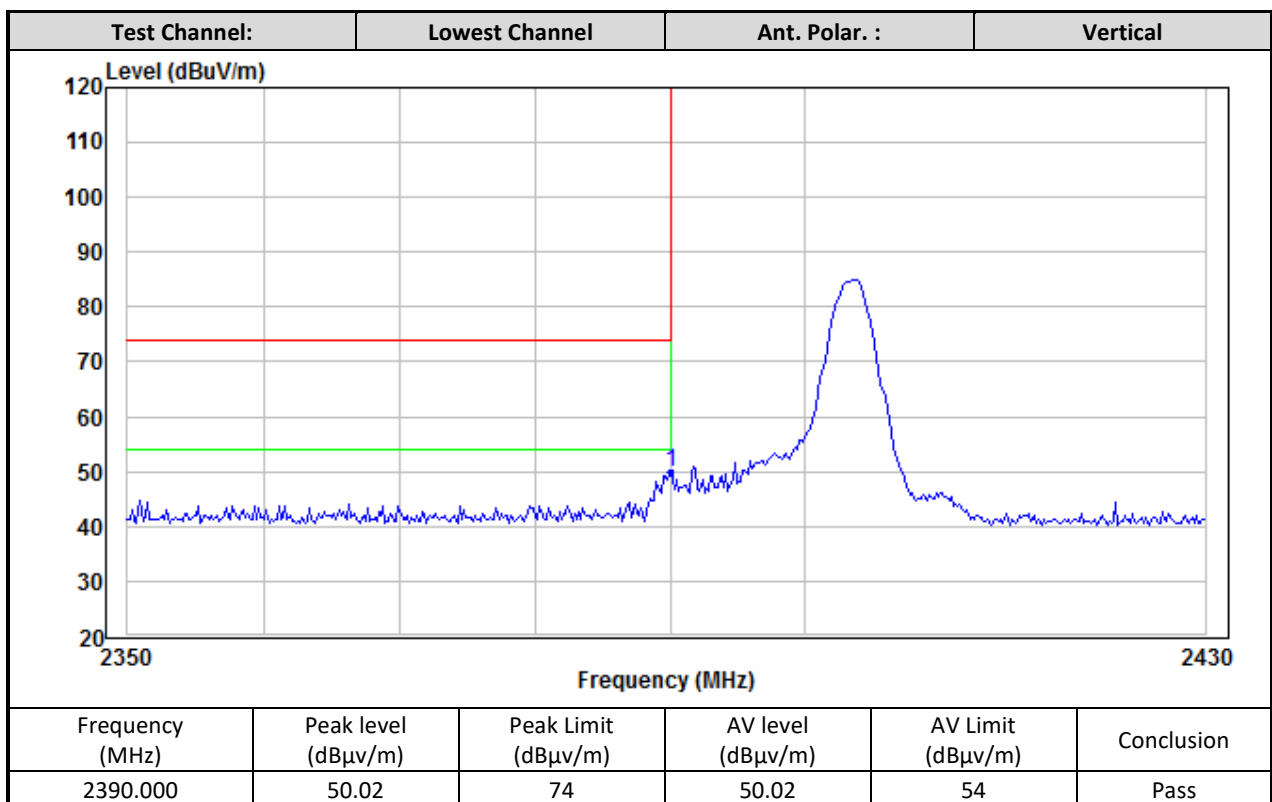
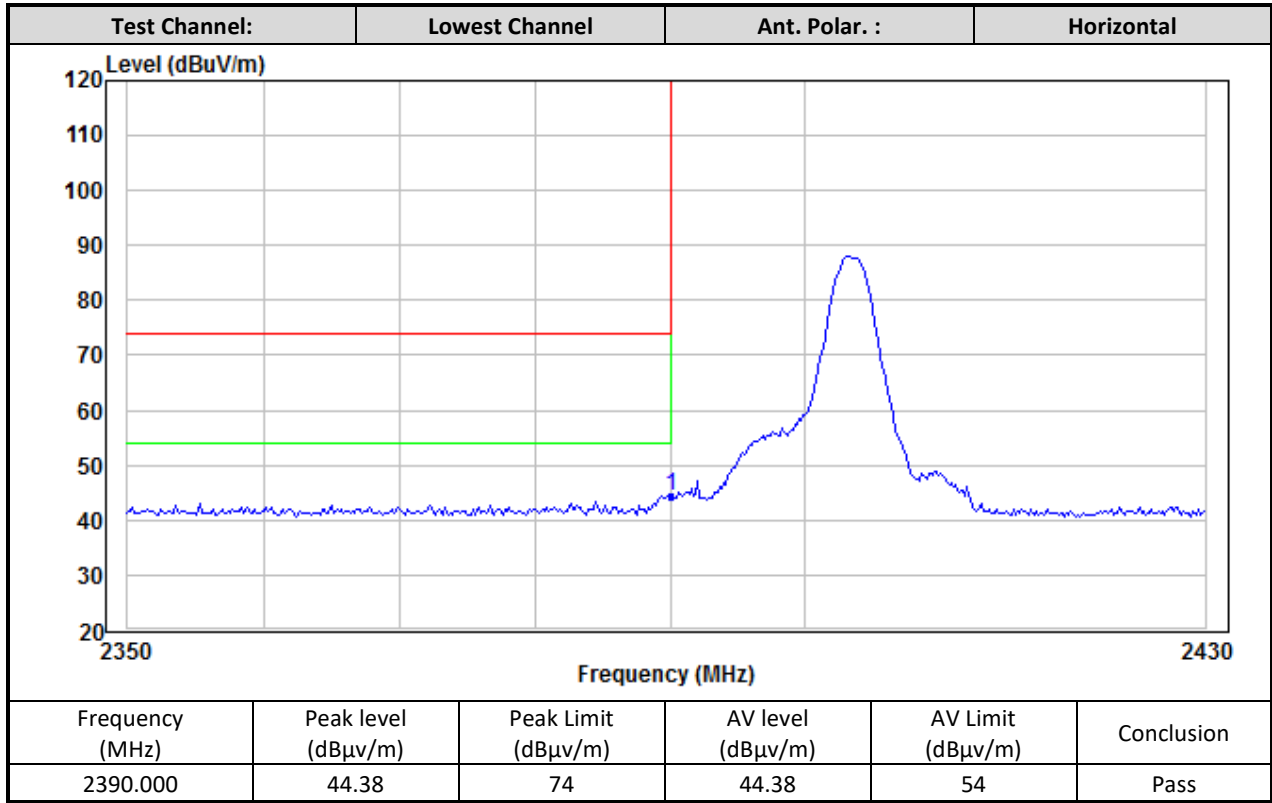

TEST REPORT

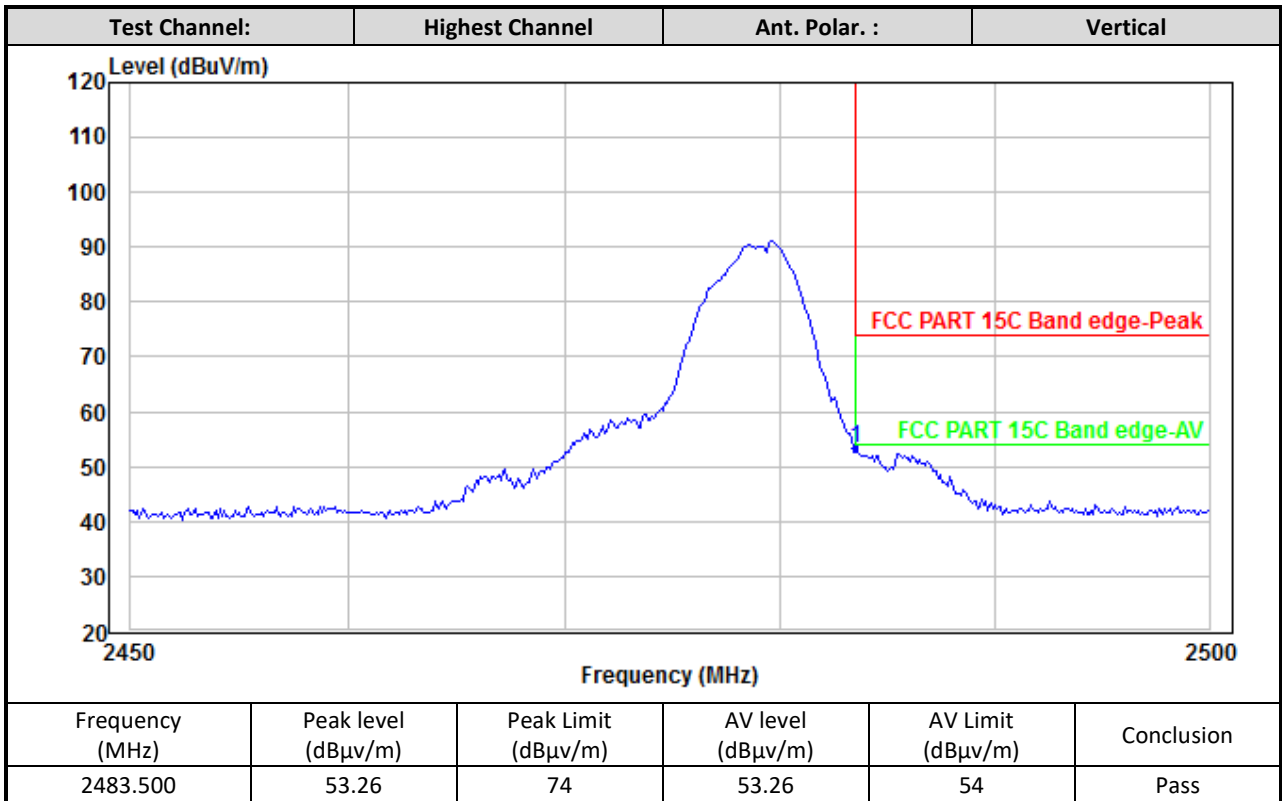
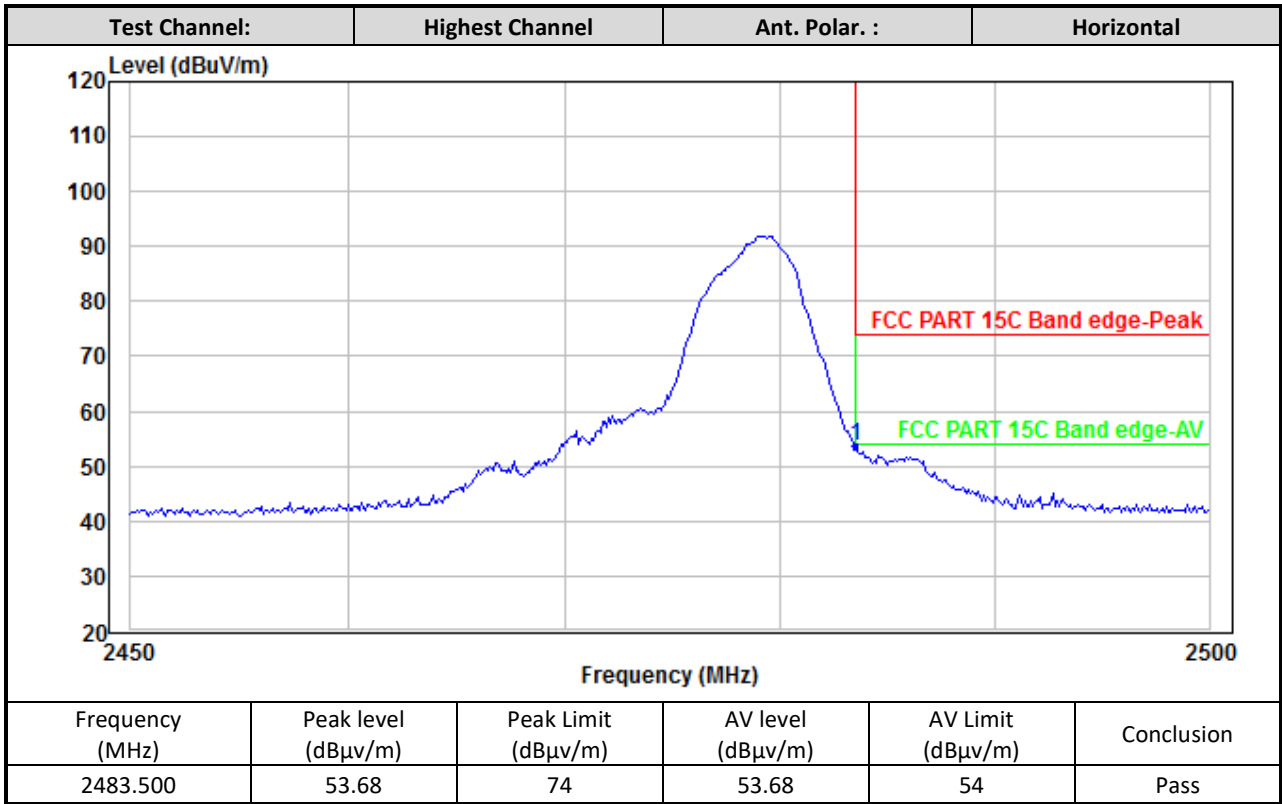

Remark: Average result = Peak result + Average Factor

TEST REPORT

ANT1:

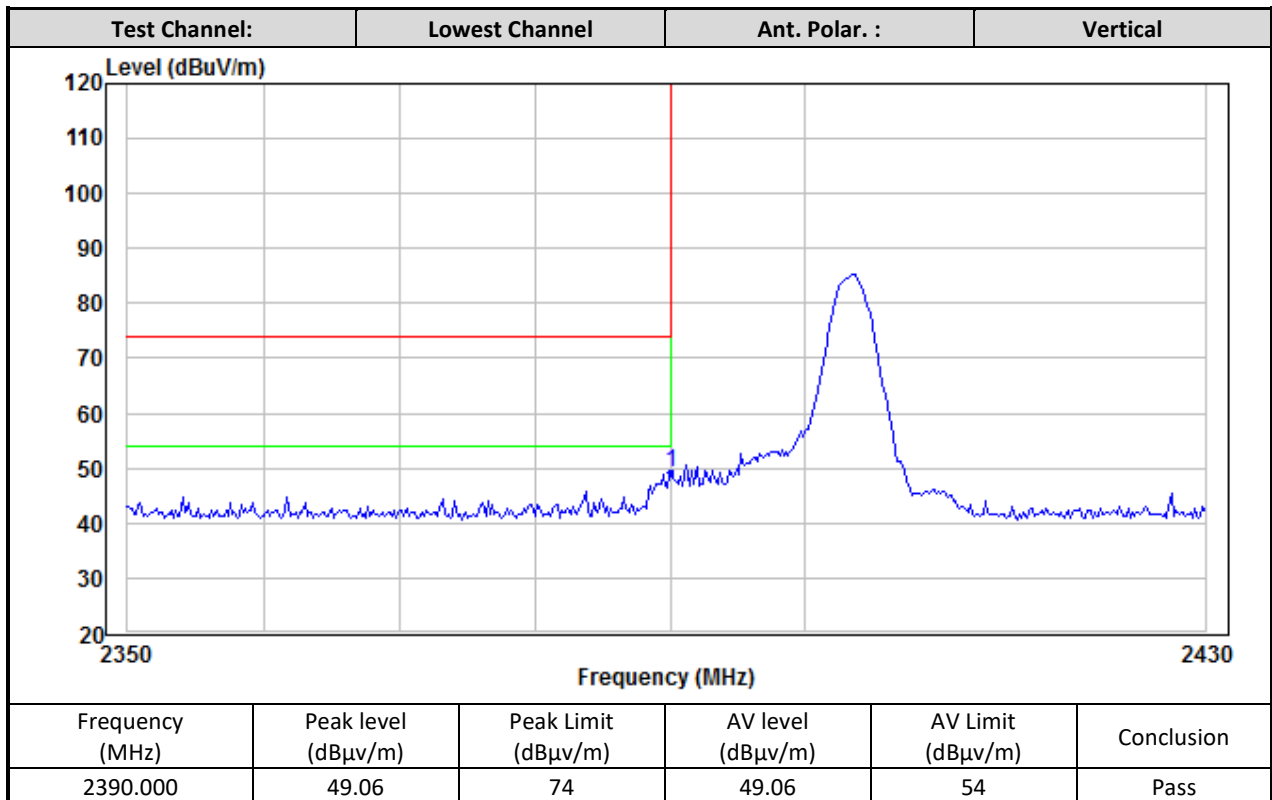
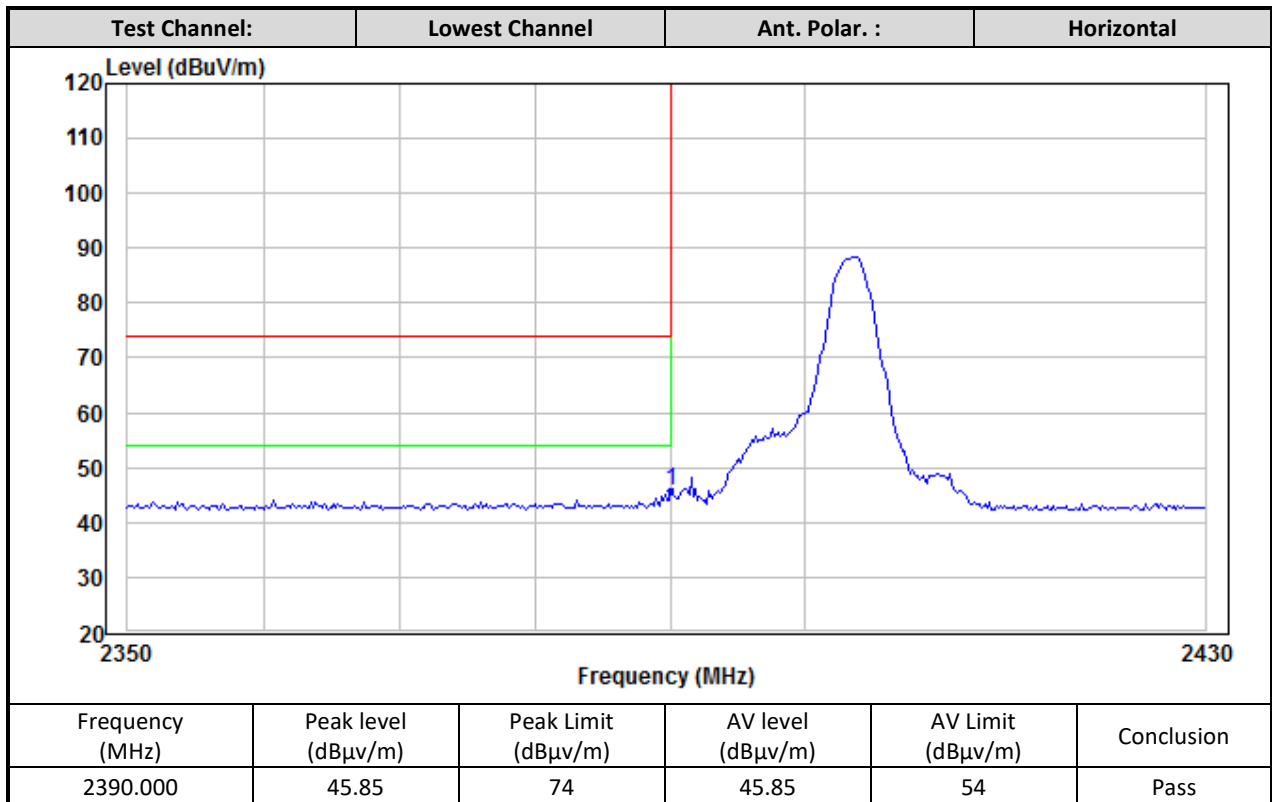

TEST REPORT

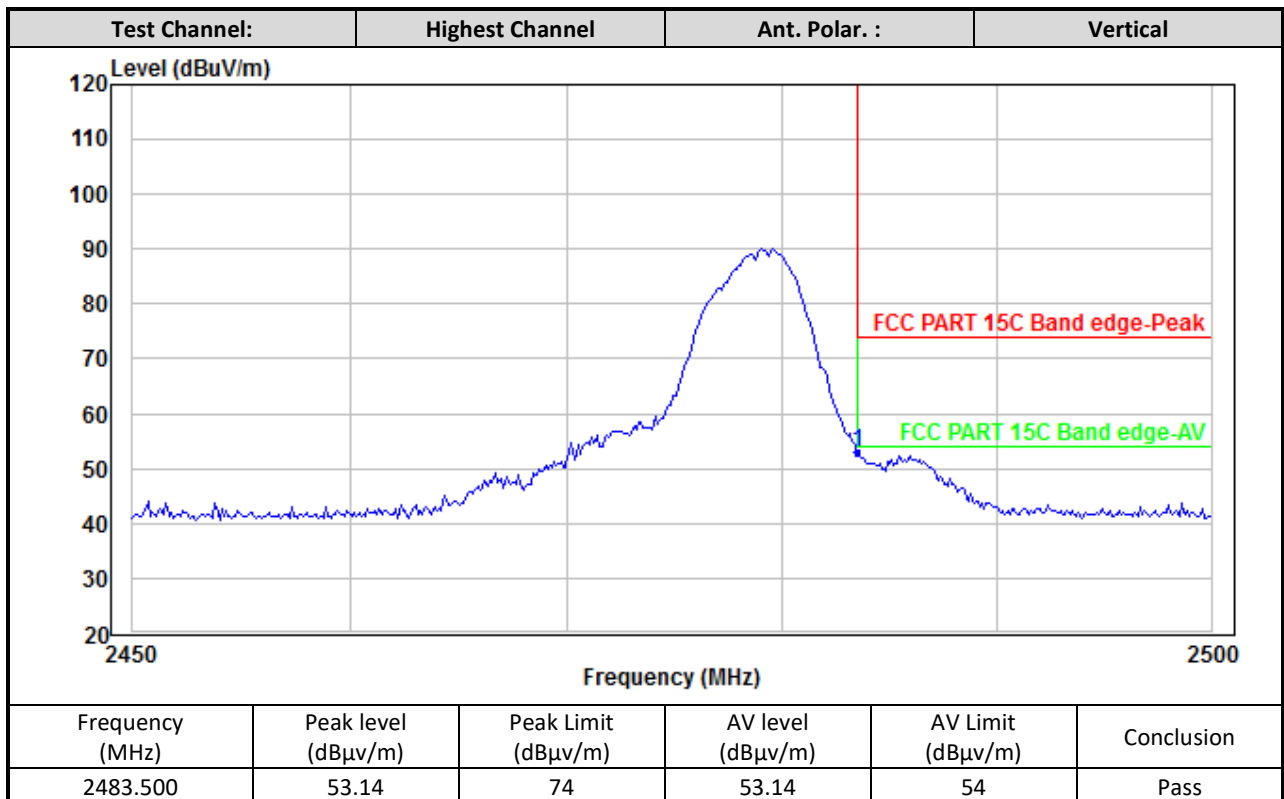
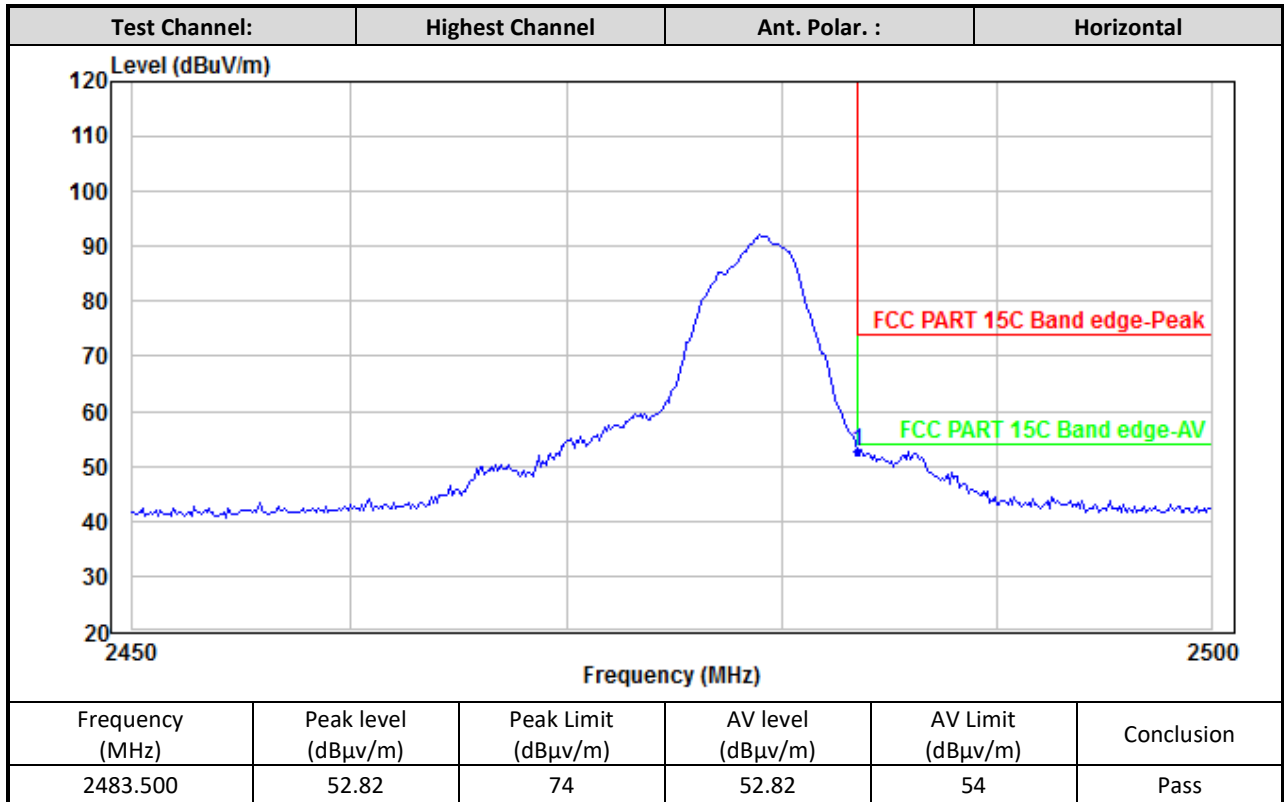

Remark: Average result = Peak result + Average Factor

TEST REPORT

8.2 Emissions Test Procedures

The following is a description of the test procedure used by Intertek Testing Services Hong Kong Ltd. in the measurements of transmitter operating under the Part 15, Subpart C rules.

The transmitting equipment under test (EUT) is placed on a wooden turntable which is four feet in diameter and approximately 0.8m in height above the ground plane for emission measurement at or below 1GHz and 1.5m in height above the ground plane for emission measurement above 1GHz. During the radiated emissions test, the turntable is rotated and any cables leaving the EUT are manipulated to find the configuration resulting in maximum emissions. The EUT is adjusted through all three orthogonal axis to obtain maximum emission levels. The antenna height and polarization are also varied during the testing to search for maximum signal levels. The height of the antenna is varied from one to four meters.

Detector function for radiated emissions is in peak mode. Average readings, when required, are taken by measuring the duty cycle of the equipment under test and subtracting the corresponding amount in dB from the measured peak readings. A detailed description for the calculation of the average factor can be found in Exhibit 8.3.

The frequency range scanned is from the lowest radio frequency signal generated in the device which is greater than 9 kHz to the tenth harmonic of the highest fundamental frequency or 40 GHz, whichever is lower. For line conducted emissions, the range scanned is 150 kHz to 30 MHz.

TEST REPORT

8.2 Emissions Test Procedures (cont'd)

The EUT is warmed up for 15 minutes prior to the test.

AC power to the unit is varied from 85% to 115% nominal and variation in the fundamental emission field strength is recorded. If battery powered, a new, fully charged battery is used.

Conducted measurements were made as described in ANSI C63.10 (2013).

The IF bandwidth used for measurement of radiated signal strength was 100 kHz or greater when frequency is below 1000 MHz. Where pulsed transmissions of short enough pulse duration warrant, a greater bandwidth is selected according to the recommendations of Hewlett Packard Application Note 150-2. A discussion of whether pulse desensitivity is applicable to this unit is included in this report (See Exhibit 8.1). Above 1000 MHz, a resolution bandwidth of 3 MHz is used.

Transmitter measurements are normally conducted at a measurement distance of three meters. However, to assure low enough noise floor in the forbidden bands and above 1 GHz, signals are acquired at a distance of one meter or less. All measurements are extrapolated to three meters using inverse scaling, unless otherwise reported. Measurements taken at a closer distance are so marked.

TEST REPORT

8.2.1 Radiated Emission Test Setup

The figure below shows the test setup, which is utilized to make these measurements.

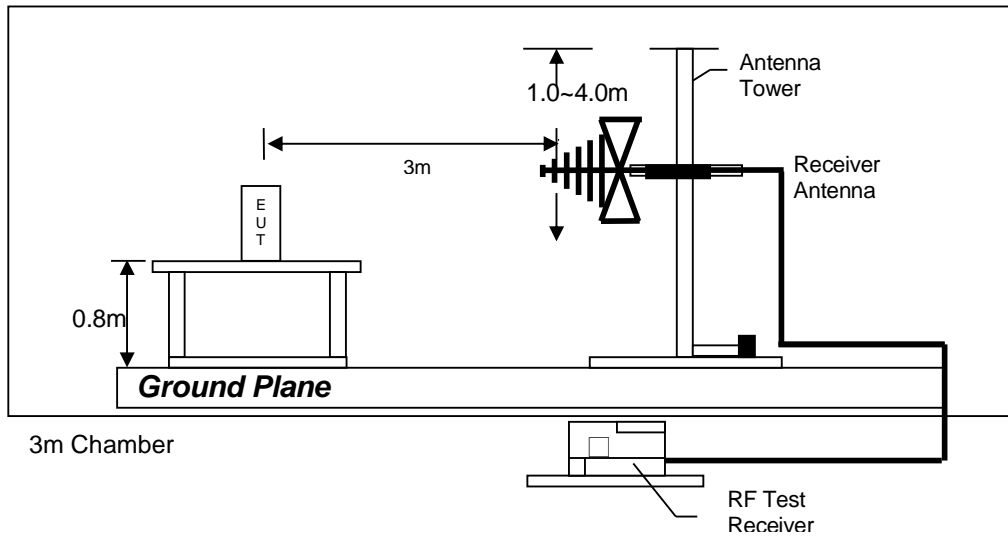

Test setup of radiated emissions up to 1GHz

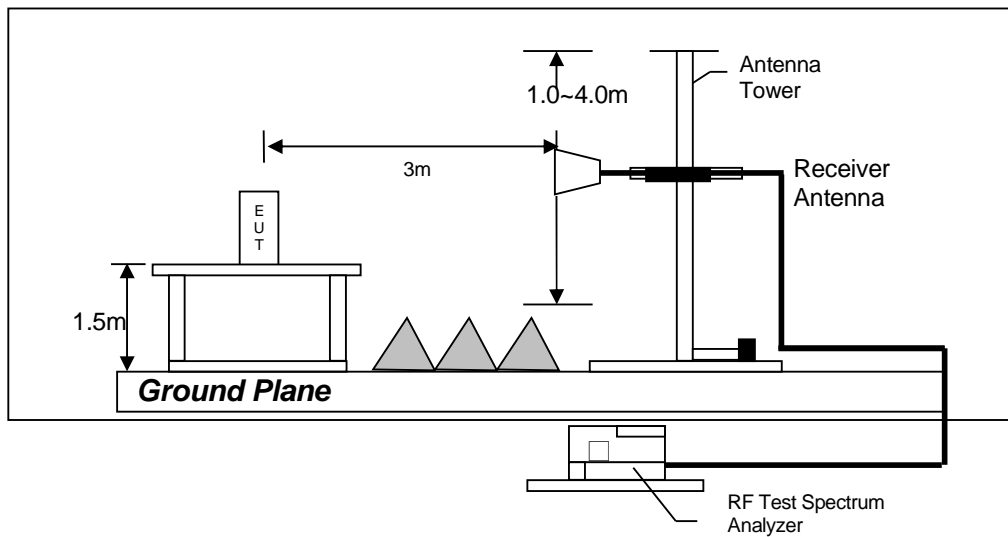

Test setup of radiated emissions above 1GHz

TEST REPORT

8.2.2 Conducted Emission Test Procedures

For tabletop equipment, the EUT along with its peripherals were placed on a 1.0m(W)×1.5m(L) and 0.8m in height wooden table. For floor-standing equipment, the EUT and all cables were insulated, if required, from the ground plane by up to 12 mm of insulating material. The EUT was adjusted to maintain a 0.4 meter space from a vertical reference plane. The EUT was connected to power mains through a line impedance stabilization network (LISN), which provided 50 ohm coupling impedance for measuring instrument and the chassis ground was bounded to the horizontal ground plane of shielded room. The excess power cable between the EUT and the LISN was bundled.

All connecting cables of EUT and peripherals were moved to find the maximum emission.

8.2.3 Conducted Emission Test Setup

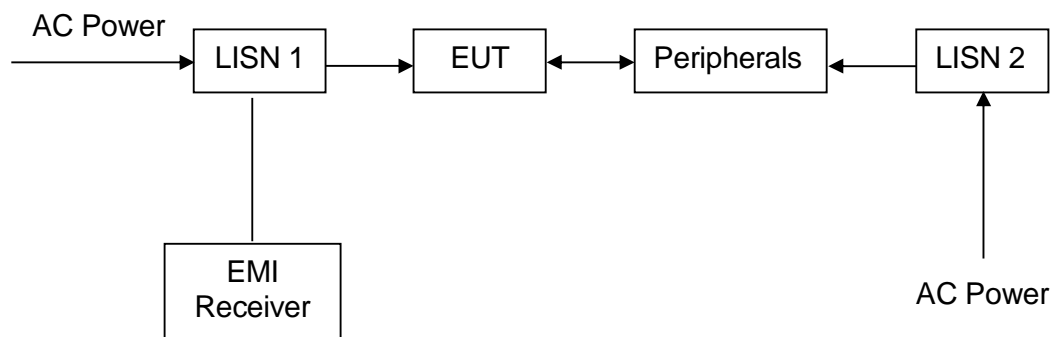

TEST REPORT

8.3 Occupied Bandwidth

Occupied Bandwidth Results:

ANTO:

Test Channel	20 dB Bandwidth (MHz)
Lowest	2.156
Middle	2.153
Highest	2.144

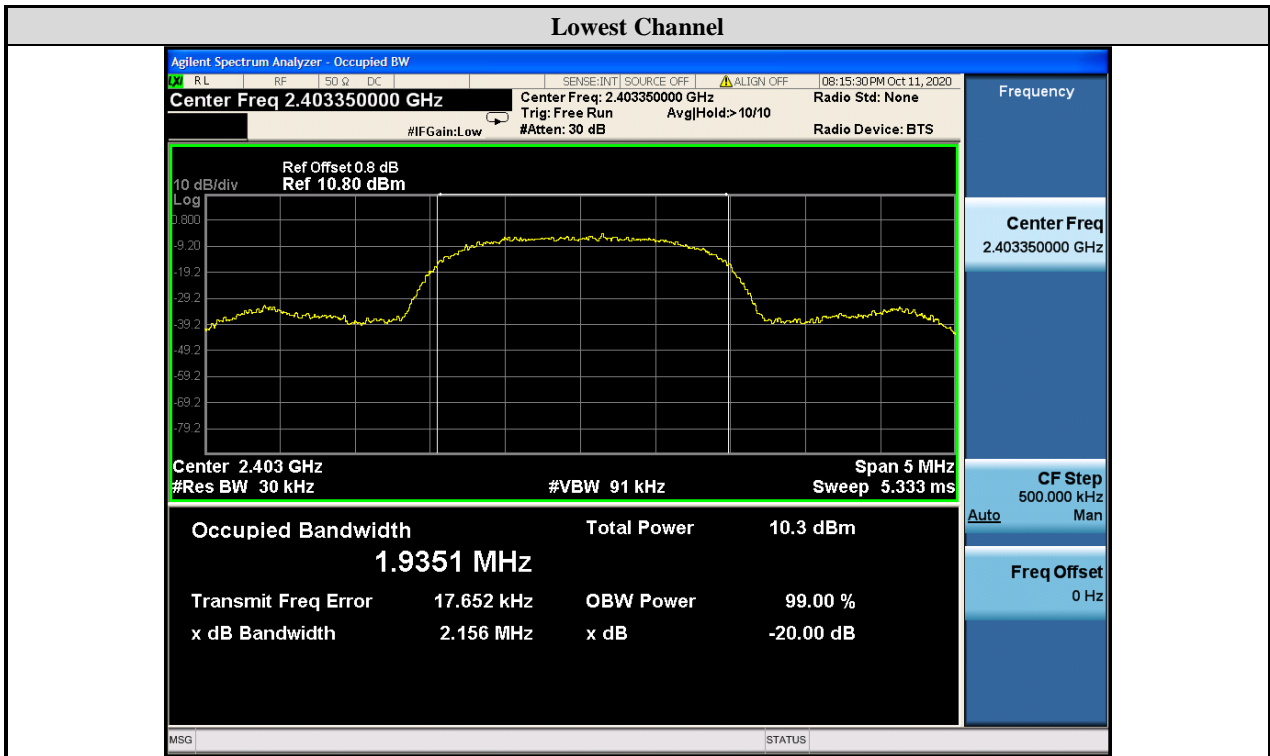

TEST REPORT

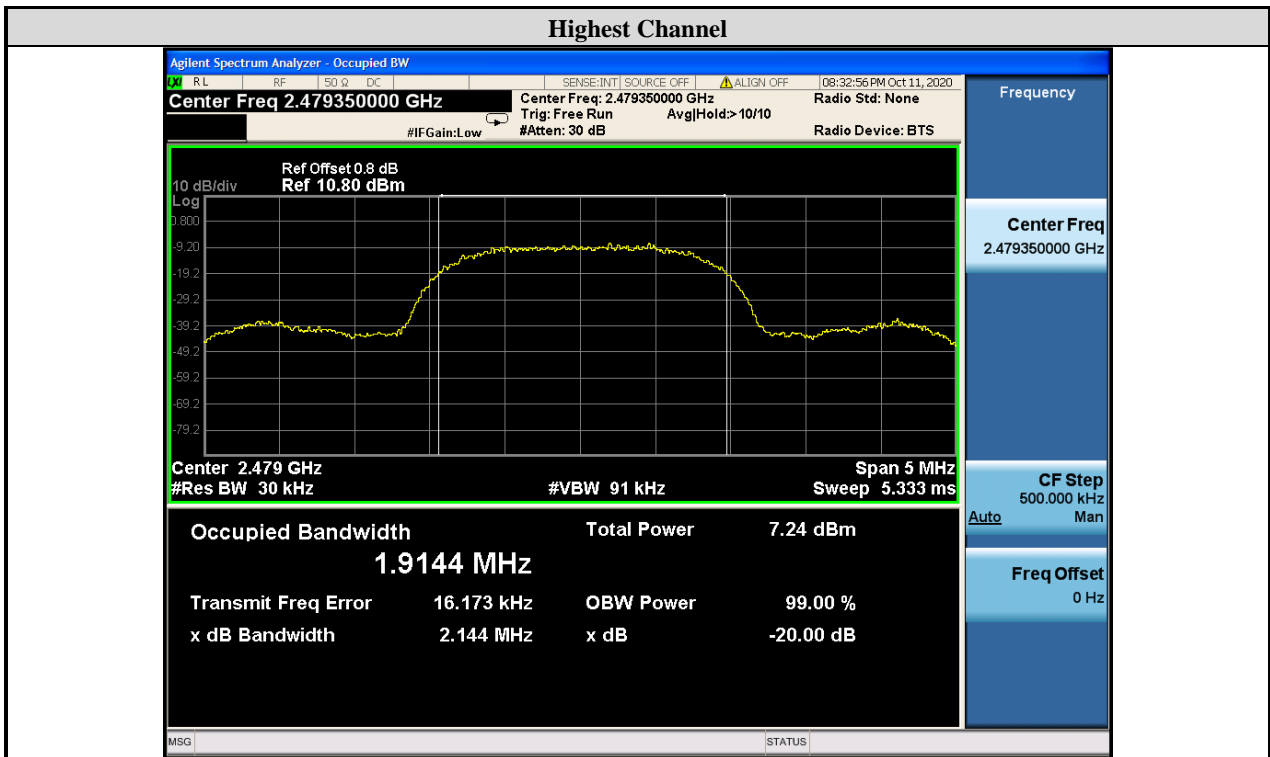
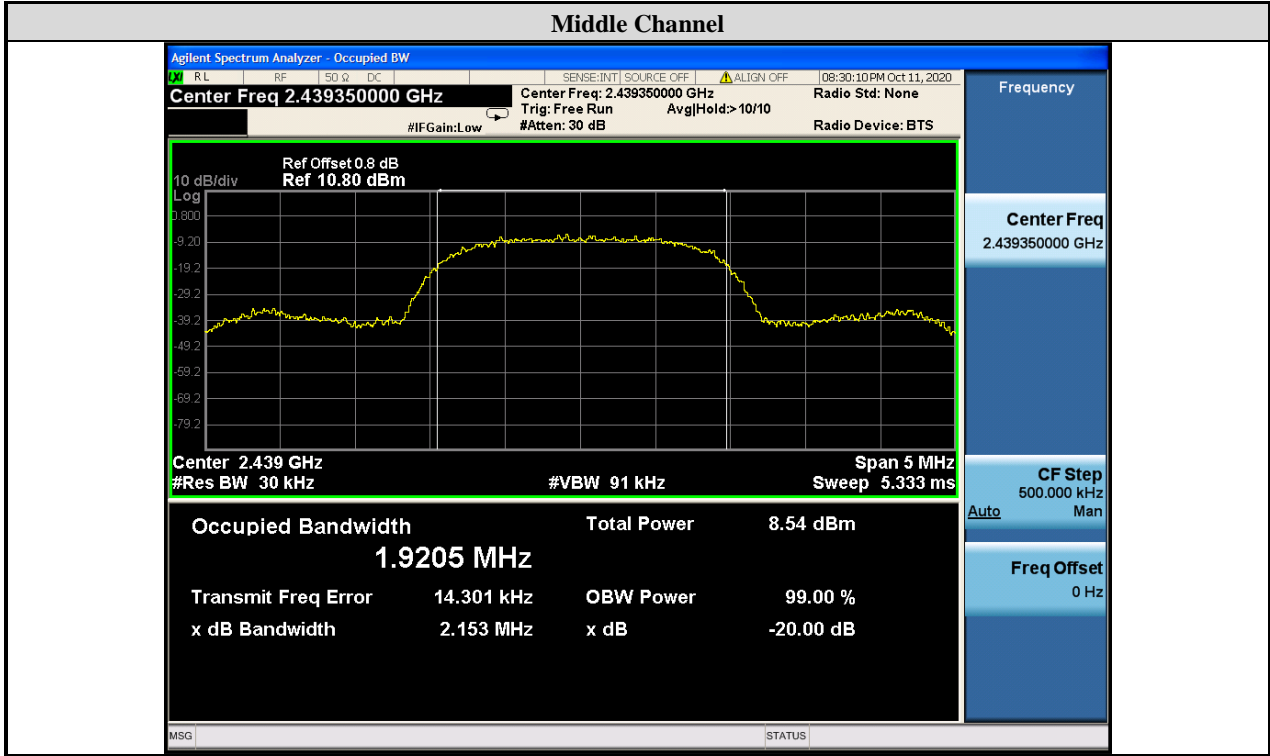

TEST REPORT

ANT1:

Test Channel	20 dB Bandwidth (MHz)
Lowest	2.149
Middle	2.148
Highest	2.140

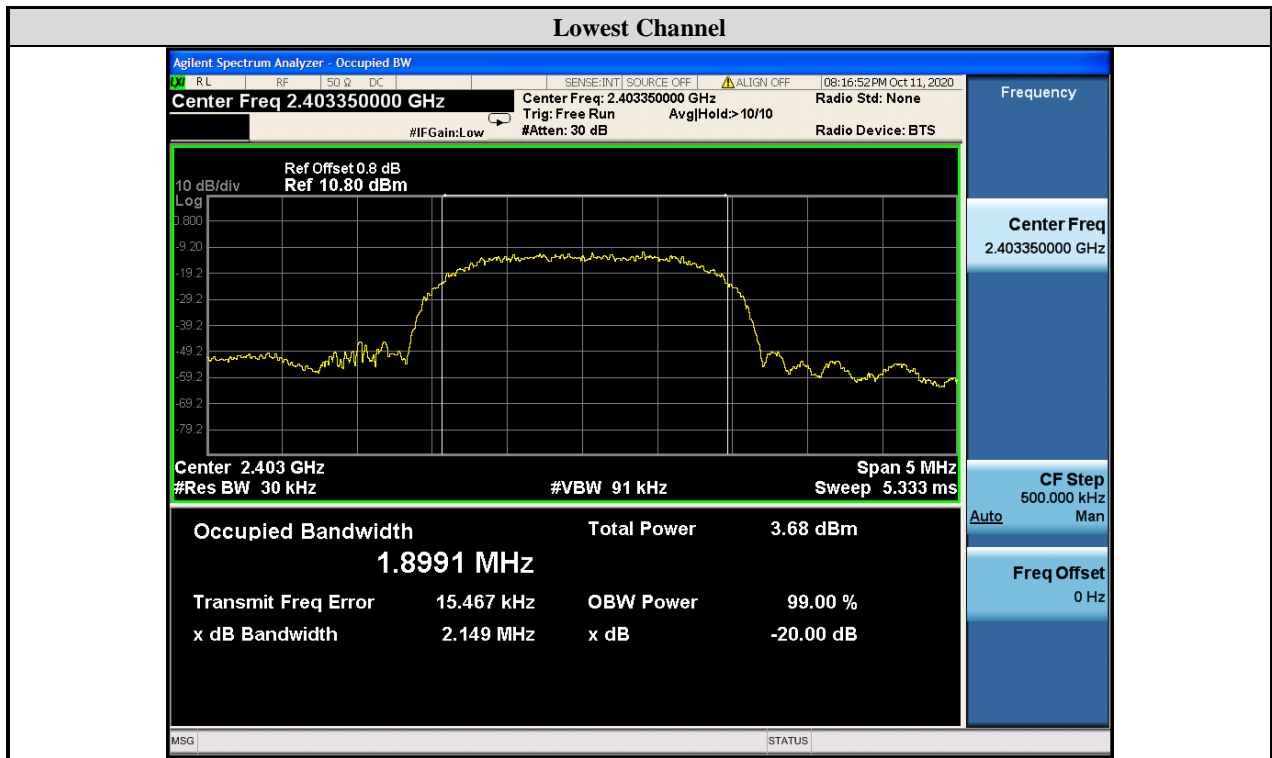

TEST REPORT

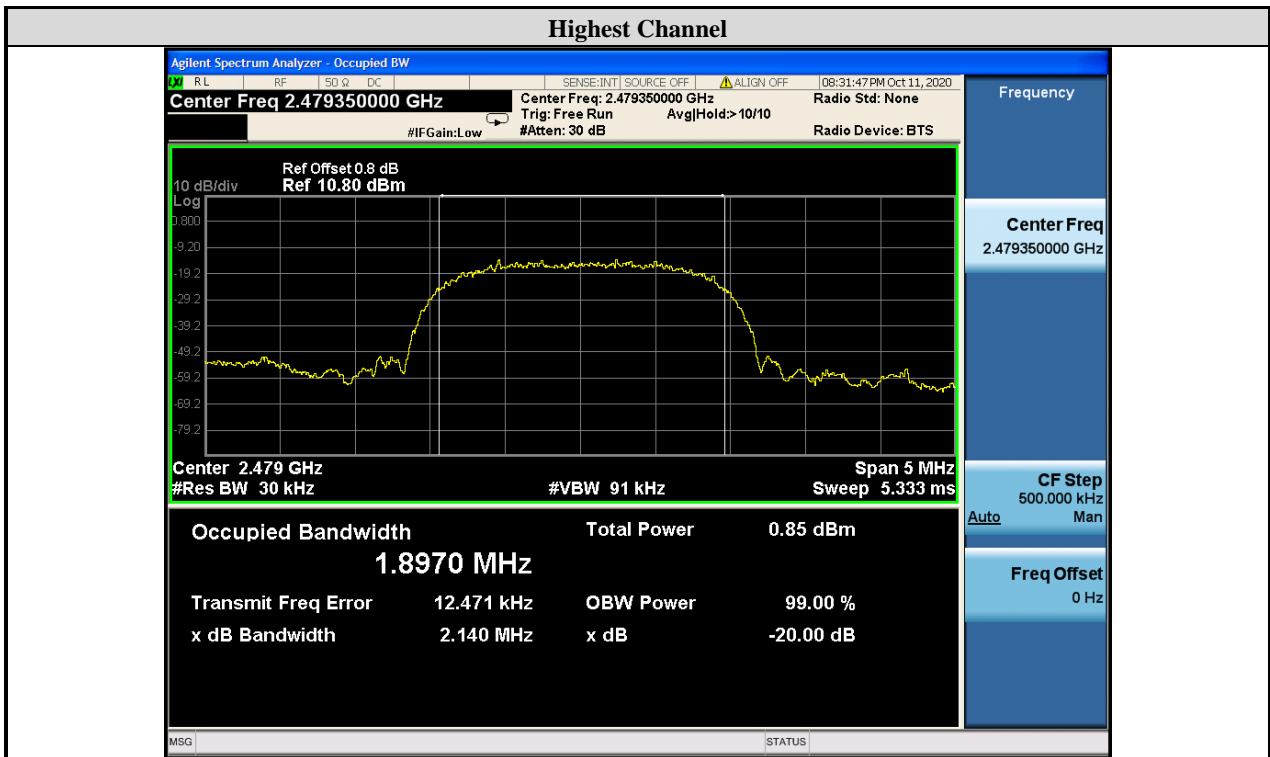
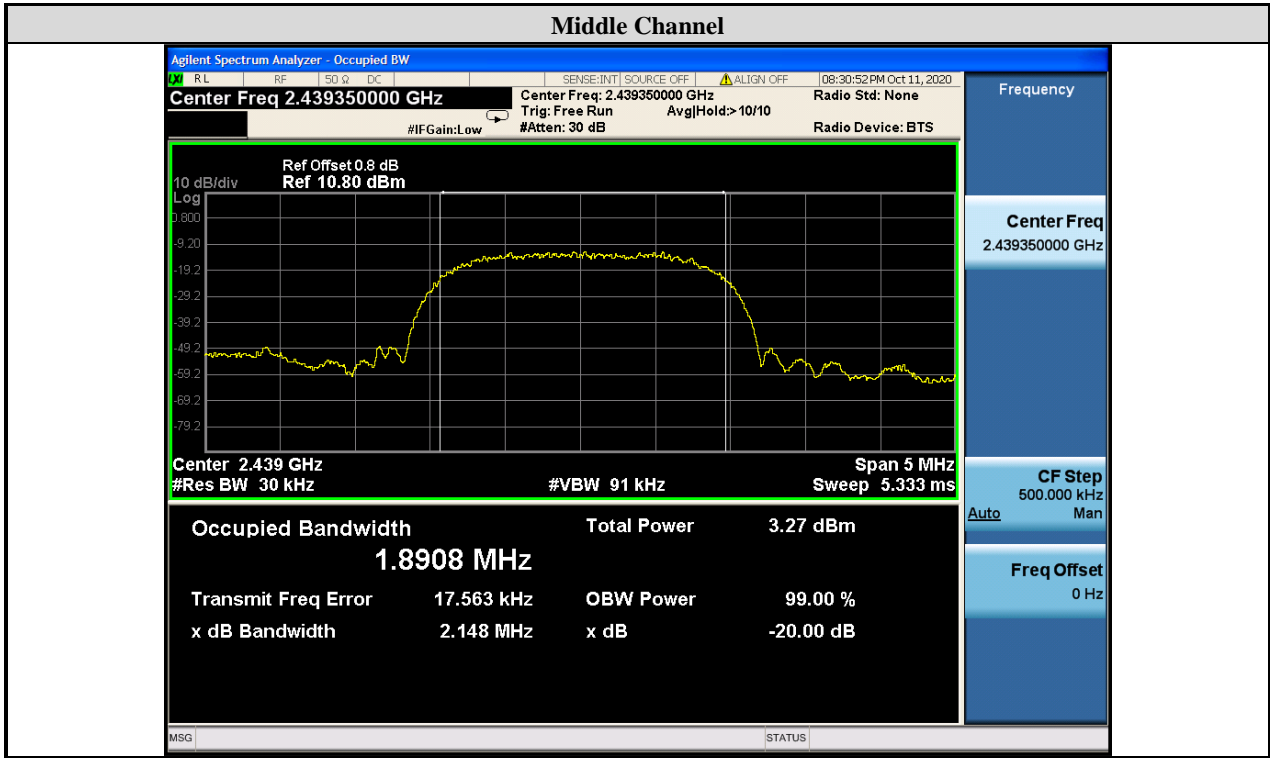

TEST REPORT

9.0 CONFIDENTIALITY REQUEST

For electronic filing, a preliminary copy of the confidentiality request is saved with filename: request.pdf.

10.0 EQUIPMENT LIST

1) Radiated Emissions Test

Equipment	3M Chamber & Accessory Equipment	Receiver	Loop Antenna
Equipment No..	UTTL-E010	UTTL-E026	UTTL-E013
Manufacturer	ETS-LINDGREN	R&S	ETS-LINDGREN
Model No.	3M	ESIB26	6502
Calibration Date	December 03, 2018	November 24, 2019	November 16, 2019
Calibration Due Date	December 03, 2021	November 23, 2020	November 15, 2020

Equipment	Broadband Antenna	6dB Attenuator	Preamplifier
Equipment No..	UTTL-E014	UTTL-E056	UTTL-E043
Manufacturer	ETS-LINDGREN	Talent	HP
Model No.	3142E	RA6A5-N-18	8447F
Calibration Date	November 16, 2019	November 16, 2019	November 24, 2019
Calibration Due Date	November 15, 2020	November 15, 2020	November 23, 2020

Equipment	Horn Antenna (Pre-amplifier)	Multi device Controller	Band Rejection Filter (2400MHz~2500MHz)
Equipment No..	UTTL-E017	UTTL-EN002	UTTL-E044
Manufacturer	ETS-LINDGREN	ETS-LINDGREN	Micro-Tronics
Model No.	3117-PA	7006-001	BRM50702
Calibration Date	May 30, 2020	N/A	November 24, 2019
Calibration Due Date	May 29, 2021	N/A	November 23, 2020

Equipment	Test Software
Equipment No..	N/A
Manufacturer	Audix
Model No.	E3
Calibration Date	Software Version: 9.160333

TEST REPORT

2) Conducted Emissions Test

Equipment	Receiver	Pulse Limiter	LISN
Equipment No..	UTTL-E005	UTTL-E007	UTTL-E003
Manufacturer	R&S	R&S	R&S
Model No.	ESR7	ESH3-Z2	ESH2-Z5
Calibration Date	November 24, 2019	November 24, 2019	November 24, 2019
Calibration Due Date	November 23, 2020	November 23, 2020	November 23, 2020

Equipment	Test Software
Equipment No..	N/A
Manufacturer	Audix
Model No.	E3
Calibration Date	Software Version: 9.160333

3) Bandedge Measurement

Equipment	EXA Spectrum Analyzer
Equipment No.	UTTL-E032
Manufacturer	KEYSIGHT
Model No.	N9010A
Calibration Date	November 24, 2019
Calibration Due Date	November 23, 2020

END OF TEST REPORT