



Report Reference ID:	411924-1TRFWL
-----------------------------	---------------

Test specification:	<p>Title 47-Telecommunication Chapter I - Federal Communications Commission Subchapter A - General Part 15 - Radio Frequency Devices Subpart C - Intentional Radiators</p> <p>RSS-Gen Issue 5 March 2019 Amendment 1 General Requirements for Compliance of Radio Apparatus</p> <p>RSS-210 Issue 10 December 2019 Licence-Exempt Radio Apparatus: Category I Equipment</p> <p>Clause 7.3 Transmitters With Wanted Emissions That are Within the General Field Strength Limits</p>
----------------------------	--

Applicant:	C.O.B.O. Spa – Tito Speri, 10 – 25024 Leno (BS) – Italy
Apparatus:	RFID Dashboard
Model:	04610311, 04610312
FCC ID:	2AVOV-04610311
IC Registration Number:	25864-04610311

Testing laboratory:	Nemko Spa Via del Carroccio, 4 – 20853 Biassono (MB) – Italy
----------------------------	--

	Name, function and signature	Date
Tested by:	D. Guarnone  (project handler)	2020-12-02
Reviewed by:	P. Barbieri  (verifier)	2020-12-02

Nemko Spa, 20853 Biassono (MB) - Italy. All rights reserved.

This publication may be reproduced in whole for non-commercial purposes as long as Nemko Spa is acknowledged as copyright owner and source of the material. Nemko Spa takes no responsibility for and will not assume liability for damages resulting from the reader's interpretation of the reproduced material due to its placement and context. Nemko Spa accepts no responsibility for damages, if any, suffered by any third party as a result of decisions made or actions based on this report. This test report may not be partially reproduced, except with the prior written permission of Nemko Spa. The test report merely corresponds to the test sample. The phase of sampling / collection of equipment under test is carried out by the customer.

This Test Report, when bearing the Nemko name and logo is only valid when issued by a Nemko laboratory, or by a laboratory having special agreement with Nemko.

Table of contents	
Section 1: Report summary	3
1.1 Test specification	3
1.2 Statement of compliance	3
1.3 Exclusions	3
1.4 Registration number	3
1.5 Test report revision history	3
1.6 Limits of responsibility	4
Section 2: Summary of test results	5
2.1 FCC Part 15, test results	5
2.2 RSS-210, test results	5
Section 3: Equipment under test (EUT) and application details	6
3.1 Applicant details	6
3.2 Modular equipment	6
3.3 Product details	6
3.4 Application purpose	7
3.5 Certification details	7
3.6 Composite/related equipment	7
3.7 Sample information	7
3.8 EUT technical specifications	7
3.9 Accessories and support equipment	8
3.10 Operation of the EUT during testing	8
3.11 EUT setup diagram	8
3.12 Software version	8
Section 4: Engineering considerations	8
4.1 Modifications incorporated in the EUT	8
4.2 Deviations from laboratory tests procedures	8
4.3 Technical judgment	8
Section 5: Test conditions	9
5.1 Deviations from laboratory tests procedures	9
5.2 Test conditions, power source and ambient temperatures	9
5.3 Measurement uncertainty	10
5.4 Test equipment	11
Section 6: Test results	12
Clause 15.31 Number of operating frequencies	12
Clause 15.203 Antenna requirement	13
Clause 15.209 Field Strength emissions	14
Appendix A: Block diagrams of test set-ups	18
Appendix B: Photos	19

Section 1: Report summary

1.1 Test specification

Specifications	<p>Part 15 - Radio Frequency Devices Subpart C - Intentional Radiators</p> <p>RSS-Gen Issue 5 March 2019 Amendment 1 General Requirements for Compliance of Radio Apparatus</p> <p>RSS-210 Issue 10 December 2019 Licence-Exempt Radio Apparatus: Category I Equipment</p> <p>Clause 7.3 Transmitters With Wanted Emissions That are Within the General Field Strength Limits</p>
-----------------------	---

1.2 Statement of compliance

Compliance	<p>In the configuration tested the EUT was found compliant Yes <input checked="" type="checkbox"/> No <input type="checkbox"/></p> <p>This report contains an assessment of apparatus against specifications based upon tests carried out on samples submitted at Nemko Spa. These tests were conducted on a sample of the equipment for the purpose of demonstrating compliance with RSS-210 Issue 10. The tests were conducted in accordance with ANSI C63.10.</p>
-------------------	--

1.3 Exclusions

Exclusions	None
-------------------	------

1.4 Registration number

Test site:	FCC ID number 682159 ISED ID number 9109A
-------------------	--

1.5 Test report revision history

Revision #	Details of changes made to test report
1	Original report issued

1.6 Limits of responsibility

Note that the results contained in this report relate only to the items tested and were obtained in the period between the date of initial receipt of samples and the date of issue of the report. This test report has been completed in accordance with the requirements of ISO/IEC 17025. Nemko Spa authorizes the applicant to reproduce this report provided it is reproduced in its entirety and for use by the company's employees only. Any use which a third party makes of this report, or any reliance on or decisions to be made based on it, are the responsibility of such third parties. Nemko Spa accepts no responsibility for damages, if any, suffered by any third party as a result of decisions made or actions based on this report.

Section 2: Summary of test results

2.1 FCC Part 15, test results

Part	Methods	Test description	Verdict
§15.31(m)	ANSI C63.10	Number of frequencies to be investigated	Pass
§15.203	ANSI C63.10	Antenna requirement	Pass
§15.209(a)	ANSI C63.10	Radiated emission limits, general requirements	Pass

Notes:

Possible test case verdicts:

test case does not apply to the test object: N/A (Not applicable)

test object does meet the requirement: P (Pass)

test object does not meet the requirement: F (Fail)

2.2 RSS-210, test results

Part	Methods	Test description	Verdict
RSS-210 §7.3	ANSI C63.10	Occupied bandwidth	Pass
RSS-210 §7.3	ANSI C63.10	Transmitters With Wanted Emissions That are Within the General Field Strength Limits	Pass

Notes:

Possible test case verdicts:

test case does not apply to the test object: N/A (Not applicable)

test object does meet the requirement: P (Pass)

test object does not meet the requirement: F (Fail)

Section 3: Equipment under test (EUT) and application details

3.1 Applicant details

Applicant	Name:	C.O.B.O Spa
	Address:	Via Tito Speri, 10
	City:	Leno
	Province/State:	Brescia
	Post code:	25024
	Country:	Italy
	IC company number:	25864
Manufacturer	Name:	C.O.B.O Spa
	Address:	Via Tito Speri, 10
	City:	Leno
	Province/State:	Brescia
	Post code:	25024
	Country:	Italy
	IC company number:	25864
Canadian representative	Name:	Ducati Canada
	Address:	777 Bayly Ave.
	City:	Ajax
	Province/State:	ON
	Post code:	L1S7G7
	Country:	Canada
	IC company number:	23452

3.2 Modular equipment

a) Single modular approval	Single modular approval Yes <input type="checkbox"/> No <input checked="" type="checkbox"/>
b) Limited single modular approval	Limited single modular approval Yes <input type="checkbox"/> No <input checked="" type="checkbox"/>

3.3 Product details

FCC ID	Grantee code:	2AVOV
	Product code:	- 04610311
IC ID	Proposed certification number:	25864-04610311
Equipment class	FCC: DCD "Part 15 Low Power Transmitter Below 1705 kHz ISED: Low Power Transmitter General Field Limits (9 kHz – 30 MHz)	
Equipment category:	Category I: Highest emission: 43.3 dBuV/m @ 10m @ 134.7 kHz Limit: $(67.6 - 20 \log(135)) + 40 \log(300/10) = 84$ dBuV/m	
Spurious emissions:	38.6 dBuV/m @ 0.1347 MHz	
Description of product as it is marketed	RFID Dashboard	
	Model name:	04610311, 04610312
	Serial number:	0000065
Product	The EUT is also classified as Terminal Equipment subject to IC CS-03 No <input checked="" type="checkbox"/> Yes <input type="checkbox"/>	

3.4 Application purpose

Type of application	<input checked="" type="checkbox"/> Original certification <input type="checkbox"/> Change in identification of presently authorized equipment <input type="checkbox"/> Original FCC ID: Grant date: <input type="checkbox"/> Class II permissive change or modification of presently authorized equipment
----------------------------	---

3.5 Certification details

Services requested	<input type="checkbox"/> New certification <input checked="" type="checkbox"/> New family <input type="checkbox"/> Re-assessment <input type="checkbox"/> Existing family <input type="checkbox"/> Multiple listing
Type of assessment	

3.6 Composite/related equipment

a) Composite equipment	The EUT is a composite device subject to an additional equipment authorization Yes <input type="checkbox"/> No <input checked="" type="checkbox"/>
b) Related equipment	The EUT is part of a system that operates with, or is marketed with, another device that requires an equipment authorization Yes <input type="checkbox"/> No <input checked="" type="checkbox"/>

3.7 Sample information

Receipt date:	2020-11-30
Nemko sample ID:	411924-1/2

3.8 EUT technical specifications

Operating frequency:	134.7 kHz
Modulation type:	FSK
Occupied bandwidth:	14.3 kHz
Channel spacing:	--
Emission designator:	14K3F1D
RF Output	43.3 dBuV/m @ 10m
Antenna type:	Loop Antenna
Power source:	14.5 V DC

3.9 Accessories and support equipment

The following information identifies accessories used to exercise the EUT during testing:

--

3.10 Operation of the EUT during testing

Details: Transmitting at max gain with max RF power output.

3.11 EUT setup diagram

The E-Lock steering lock system is a mechatronic device in which there is the steering lock function, carried out mechanically by means of the rotation of a key lock cylinder, together with the immobilizer function realized electronically by a special integrated unit.

3.12 Software version

Details: Not provided

Section 4: Engineering considerations

4.1 Modifications incorporated in the EUT

Modifications Modifications performed to the EUT during this assessment
 None Yes , performed by Client or Nemko
 Details:

4.2 Deviations from laboratory tests procedures

Deviations Deviations from laboratory test procedures
 None Yes - details are listed below:

4.3 Technical judgment

Judgment None

Section 5: Test conditions

5.1 Deviations from laboratory tests procedures

No deviations were made from laboratory test procedures.

5.2 Test conditions, power source and ambient temperatures

Normal temperature, humidity and air pressure test conditions	<p>Unless different values are declared in the test case, following ambient conditions apply for the tests:</p> <p>Temperature: 18 ÷ 33 °C Relative humidity: 30 ÷ 60 % Air pressure: 980 ÷ 1060 hPa</p> <p>When it is impracticable to carry out tests under these conditions, a note to this effect stating the ambient temperature and relative humidity during the tests shall be recorded and stated.</p>
Power supply range:	The normal test voltage for equipment to be connected to the mains shall be the nominal mains voltage. For the purpose of the present document, the nominal voltage shall be the declared voltage, or any of the declared voltages $\pm 5\%$, for which the equipment was designed.

Equipment	Manufacturer	Model	Serial N°
Thermo-hygrometer data loggers	Testo	175-H2	20012380/305
Thermo-hygrometer data loggers	Testo	175-H2	38203337/703
Barometer	Castle	GPB 3300	072015

5.3 Measurement uncertainty

The measurement uncertainty was calculated for each test and quantity listed in this test report, according to CISPR 16-4-2 and other specific test standard and is documented in Nemko Spa working manual WML1002.

The assessment of conformity for each test performed on the equipment is performed not taking into account the measurement uncertainty. The two following possible verdicts are stated in the report:

P (Pass) - The measured values of the equipment respect the specification limit at the points tested. The specific risk of false accept is up to 50% when the measured result is close to the limit.

F (Fail) - One or more measured values of the equipment do not respect the specification limit at the points tested. The specific risk of false reject is up to 50% when the measured result is close to the limit.

Hereafter Nemko's measurement uncertainties are reported:

EUT	Type	Test	Range	Measurement Uncertainty	Notes
Transmitter	Conducted	Frequency error	0.001 MHz ÷ 40 GHz	0.08 ppm	(1)
		Carrier power RF Output Power	0.009 MHz ÷ 30 MHz	1.1 dB	(1)
			30 MHz ÷ 18 GHz	1.5 dB	(1)
			18 MHz ÷ 40 GHz	3.0 dB	(1)
			40 MHz ÷ 140 GHz	5.0 dB	(1)
		Adjacent channel power	1 MHz ÷ 18 GHz	1.4 dB	(1)
		Conducted spurious emissions	0.009 MHz ÷ 18 GHz	3.0 dB	(1)
			18 GHz ÷ 40 GHz	4.2 dB	(1)
			40 GHz ÷ 220 GHz	6.0 dB	(1)
		Intermodulation attenuation	1 MHz ÷ 18 GHz	2.2 dB	(1)
		Attack time – frequency behaviour	1 MHz ÷ 18 GHz	2.0 ms	(1)
		Attack time – power behaviour	1 MHz ÷ 18 GHz	2.5 ms	(1)
		Release time – frequency behaviour	1 MHz ÷ 18 GHz	2.0 ms	(1)
		Release time – power behaviour	1 MHz ÷ 18 GHz	2.5 ms	(1)
		Transient behaviour of the transmitter– Transient frequency behaviour	1 MHz ÷ 18 GHz	0.2 kHz	(1)
		Transient behaviour of the transmitter – Power level slope	1 MHz ÷ 18 GHz	9%	(1)
		Frequency deviation - Maximum permissible frequency deviation	0.001 MHz ÷ 18 GHz	1.3%	(1)
	Frequency deviation - Response of the transmitter to modulation frequencies above 3 kHz	0.001 MHz ÷ 18 GHz	0.5 dB	(1)	
	Dwell time	-	3%	(1)	
	Hopping Frequency Separation	0.01 MHz ÷ 18 GHz	1%	(1)	
Occupied Channel Bandwidth	0.01 MHz ÷ 18 GHz	2%	(1)		
Modulation Bandwidth	0.01 MHz ÷ 18 GHz	2%	(1)		
Radiated	Radiated spurious emissions	0.009 MHz ÷ 26.5 GHz	6.0 dB	(1)	
		26.5 GHz ÷ 66 GHz	8.0 dB	(1)	
		66 GHz ÷ 220 GHz	10 dB	(1)	
	Effective radiated power transmitter	10 kHz ÷ 26.5 GHz	6.0 dB	(1)	
		26.5 GHz ÷ 66 GHz	8.0 dB	(1)	
Receiver	Radiated	Radiated spurious emissions	66 GHz ÷ 220 GHz	10 dB	(1)
			0.009 MHz ÷ 26.5 GHz	6.0 dB	(1)
			26.5 GHz ÷ 66 GHz	8.0 dB	(1)
	Conducted	Conducted spurious emissions	66 GHz ÷ 220 GHz	10 dB	(1)
			1 MHz ÷ 18 GHz	6.0 dB	(1)
			0.009 MHz ÷ 18 GHz	3.0 dB	(1)
Conducted	Conducted spurious emissions	18 GHz ÷ 40 GHz	4.2 dB	(1)	
		40 GHz ÷ 220 GHz	6.0 dB	(1)	
		0.009 MHz ÷ 18 GHz	3.0 dB	(1)	

NOTES:

(1) The reported expanded uncertainty of measurement is stated as the standard uncertainty of measurement multiplied by the coverage factor k = 2, which for a normal distribution corresponds to a coverage probability of approximately 95 %

5.4 Test equipment

Equipment	Manufacturer	Model	Serial N°	Cal Date	Due Date
Trilog Broadband Antenna	Schwarzbeck	VULB 9162	9162-025	2018-07	2021-07
EMI receiver (20 Hz ÷ 8 GHz)	Rohde & Schwarz	ESU8	100202	2020-01	2021-01
Semi-anechoic chamber	Nemko	10 m semi-anechoic chamber	530	2018-09	2021-09
Shielded room	Siemens	10 m control room	1947	NSC	--

Note: N/A = Not Applicable, NCR = No Cal Required, COU = CAL On Use

Section 6: Test results

Clause 15.31 Number of operating frequencies

(m) Measurements on intentional radiators or receivers, other than TV broadcast receivers, shall be performed and, if required, reported for each band in which the device can be operated with the device operating at the number of frequencies in each band specified in the following table:

Frequency range over which device operates	Number of frequencies	Location in the range of operation
1 MHz and less	1	Middle
1 to 10 MHz	2	1 near top and 1 near bottom
More than 10 MHz	3	1 near top, 1 near middle and 1 near bottom

Test date: 2020-12-02

Test results: Pass

Test data

Investigated frequency: 135.0 kHz

Clause 15.203 Antenna requirement

An intentional radiator shall be designed to ensure that no antenna other than that furnished by the responsible party shall be used with the device. The use of a permanently attached antenna or of an antenna that uses a unique coupling to the intentional radiator shall be considered sufficient to comply with the provisions of this section. The manufacturer may design the unit so that a broken antenna can be replaced by the user, but the use of a standard antenna jack or electrical connector is prohibited. Further, this requirement does not apply to intentional radiators that must be professionally installed, such as perimeter protection systems and some field disturbance sensors, or to other intentional radiators which, in accordance with §15.31(d), must be measured at the installation site. However, the installer shall be responsible for ensuring that the proper antenna is employed so that the limits in this part are not exceeded.

Test date: 2020-12-02

Test results: Pass

Test data

Antenna specifications

⚠ ANTENNA SPECIFICATIONS

PARAMETER	SPEC	
INDUCTANCE	440µH±10%	440µH±5%
RESISTANCE	4.2Ω±5%	3.8Ω±5%
TURN	95T	83T
MATERIAL	2UEW0.25	1UEW0.25

Clause 15.209 Field Strength emissions

Except when the requirements applicable to a given device state otherwise, emissions from licence-exempt transmitters shall comply with the field strength limits shown in the following table. Additionally, the level of any transmitter emission shall not exceed the level of the transmitter's fundamental emission.

Frequency (MHz)	Field strength		Measurement distance (m)
	($\mu\text{V}/\text{m}$)	($\text{dB}\mu\text{V}/\text{m}$)	
0.009–0.490	2400/F	67.6–20log(F)	300
0.490–1.705	24000/F	87.6–20log(F)	30
1.705–30.0	30	29.5	30
30–88	100	40.0	3
88–216	150	43.5	3
216–960	200	46.0	3
above 960	500	54.0	3

Notes:

- F = frequency in kHz
- In the emission table above, the tighter limit applies at the band edges.
- For frequencies above 1 GHz the limit on peak RF emissions is 20 dB above the maximum permitted average emission limit applicable to the equipment under test.

- The spectrum was searched from 9 kHz to the 10th harmonic.
- The EUT was measured on three orthogonal axis.
- All measurements were performed at a distance of 10 m (9 kHz to 30 MHz) and 3 m (30 MHz to 6 GHz)
- All measurements were performed:
 - below 30 MHz: using a quasi-peak detector with 9 kHz/30 kHz RBW/VBW,
 - within 30–1000 MHz range: using a quasi-peak detector with 120 kHz/300 kHz RBW/VBW,
 - above 1 GHz: using peak detector with 1 MHz/3 MHz RBW/VBW for peak results
 - and using averagedetector with 1 MHz/10 Hz RBW/VBW for average results
 - Only the worst data presented in the test report.

§ 15.205 Restricted bands of operation.

MHz	MHz	MHz	GHz
0.090–0.110	16.42–16.423	399.9–410	4.5–5.15
0.495–0.505	16.69475–16.69525	608–614	5.35–5.46
2.1735–2.1905	16.80425–16.80475	960–1240	7.25–7.75
4.125–4.128	25.5–25.67	1300–1427	8.025–8.5
4.17725–4.17775	37.5–38.25	1435–1626.5	9.0–9.2
4.20725–4.20775	73–74.6	1645.5–1646.5	9.3–9.5
6.215–6.218	74.8–75.2	1660–1710	10.6–12.7
6.26775–6.26825	108–121.94	1718.8–1722.2	13.25–13.4
6.31175–6.31225	123–138	2200–2300	14.47–14.5
8.291–8.294	149.9–150.05	2310–2390	15.35–16.2
8.362–8.366	156.52475–156.52525	2483.5–2500	17.7–21.4
8.37625–8.38675	156.7–156.9	2690–2900	22.01–23.12
8.41425–8.41475	162.0125–167.17	3260–3267	23.6–24.0
12.29–12.293	167.72–173.2	3332–3339	31.2–31.8
12.51975–12.52025	240–285	3345.8–3358	36.43–36.5
12.57675–12.57725	322–335.4	3600–4400	Above 38.6
13.36–13.41			

RSS-210 §7.3 Transmitter with wanted and unwanted emissions that are within the general field strength limits.

Transmitters whose wanted and unwanted emissions fall within the general field strength limits specified in RSS-Gen may operate licence-exempt in any of the frequency bands, other than the restricted frequency bands listed in RSS-Gen and the TV bands 54-72 MHz, 76-88 MHz, 174-216 MHz and 470-602 MHz, and shall be certified under RSS-210. Under no circumstances shall the level of any unwanted emissions exceed the level of the fundamental emissions.

Devices operating below 490 kHz for which all emissions are at least 40 dB below the general field strength limit listed in RSS-Gen (for transmitters at frequencies below 30 MHz) are Category II devices and are subject to the requirements specified in RSS-310, Licence-Exempt Radio Apparatus: Category II Equipment.

Test date: From 2020-12-02

Test results: Pass

Special notes

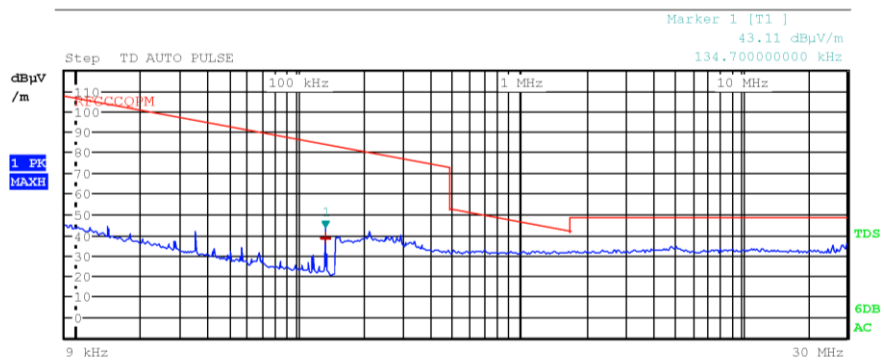
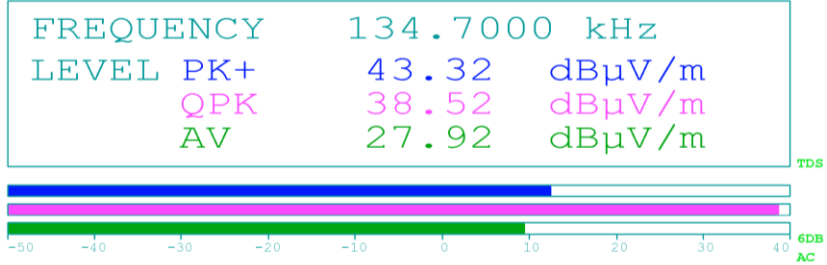

Date: 2.DEC.2020 16:12:21

CARRIER - Loop antenna @ 10 m

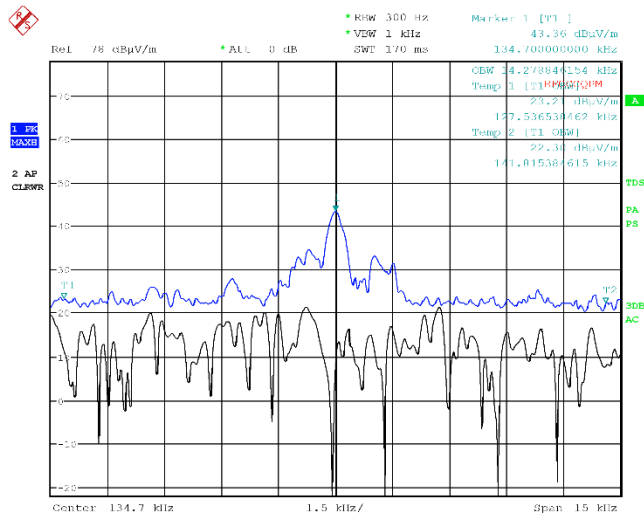

Date: 2.DEC.2020 16:13:59

Occupied Bandwidth @ 99%

Test data

Spurious radiated emissions from 9 kHz to 30 MHz

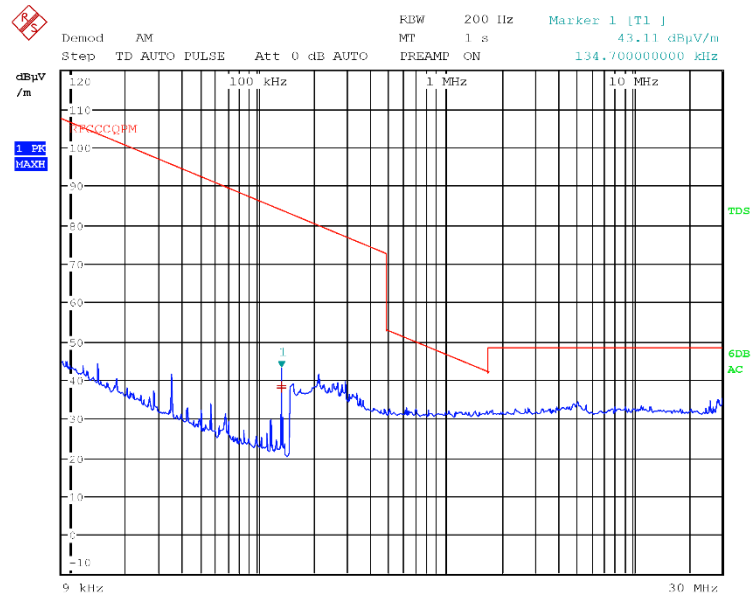

Date: 2.DEC.2020 16:11:44

Frequency (MHz)	Level (dBμV/m)	Limit (dBμV/m)	Margin (dB)	Detector
0.1347	37.9	84.1	-46.2	QP
0.1347	38.6	84.1	-45.5	QP

Frontal loop antenna (worst case)

Appendix A: Block diagrams of test set-ups

Radiated emissions set-up below 30 MHz

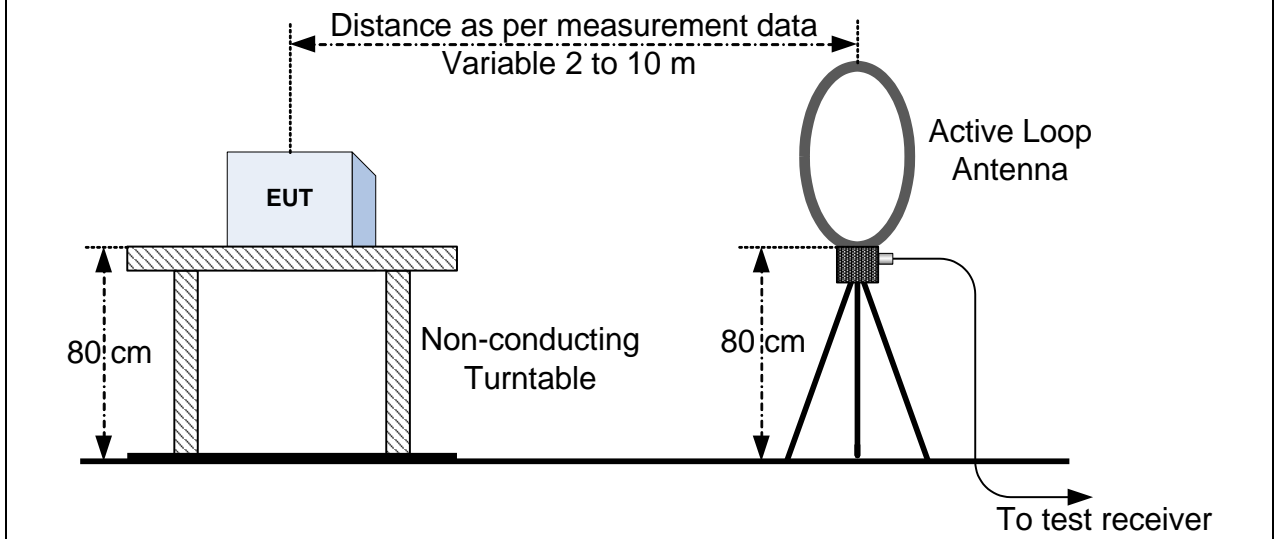

Appendix B: Photos

Set-up photos

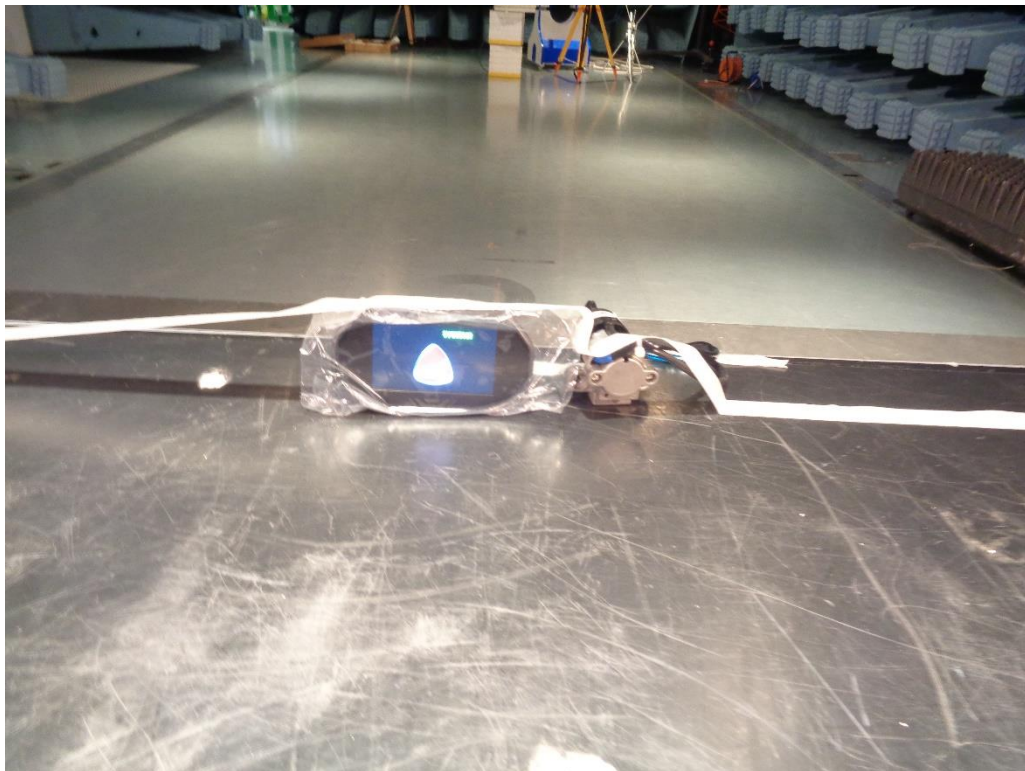
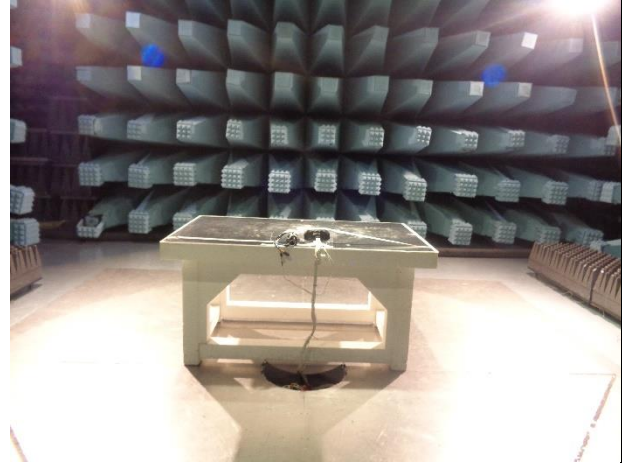

EUT photos

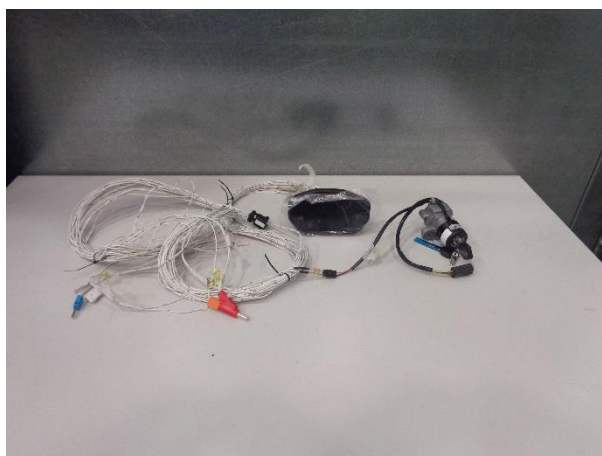



End of report