

Nalloy, LLC

REVISED TEST REPORT TO 108788-57

JZ7XYR

Tested to The Following Standards:

FCC Part 15 Subpart C Section(s)

15.207 & 15.247
(HYBRID 902-928 MHZ)

Report No.: 108788-57A

Date of issue: November 30, 2023



Test Certificate # 803.01

This test report bears the accreditation symbol indicating that the testing performed herein meets the test and reporting requirements of ISO/IEC 17025 under the applicable scope of testing for CKC Laboratories, Inc.

We strive to create long-term, trust based relationships by providing sound, adaptive, customer first testing services. We embrace each of our customers' unique EMC challenges, not as an interruption to set processes, but rather as the reason we are in business.

This report contains a total of 61 pages and may be reproduced in full only. Partial reproduction may only be done with the written consent of CKC Laboratories, Inc.

TABLE OF CONTENTS

Administrative Information	3
Test Report Information	3
Revision History	3
Report Authorization	3
Test Facility Information	4
Software Versions	4
Site Registration & Accreditation Information	4
Summary of Results	5
Modifications During Testing	5
Conditions During Testing	5
Equipment Under Test	6
General Product Information	7
FCC Part 15 Subpart C	11
15.247(a) Transmitter Characteristics	11
15.247(a)(1) Occupied Bandwidth	12
15.247(a)(1) Carrier Separation	17
15.247(a)(1)(i) Number of Channels	18
15.247(b)(2) Output Power	19
15.247(d) RF Conducted Emissions & Band Edge	22
15.247(d) Radiated Emissions & Band Edge	30
15.247 (f) Hybrid Systems Time of Occupancy	49
15.247 (f) Hybrid Systems Power Spectral Density	51
15.207 AC Conducted Emissions	54
Supplemental Information	60
Measurement Uncertainty	60
Emissions Test Details	60

ADMINISTRATIVE INFORMATION

Test Report Information

REPORT PREPARED FOR:

Nalloy, LLC
2301 5th Avenue
Seattle, WA 98108

Representative: Naga Suryadevara
Customer Reference Number: 2D-11530595

REPORT PREPARED BY:

Viviana Prado
CKC Laboratories, Inc.
5046 Sierra Pines Drive
Mariposa, CA 95338

Project Number: 108788

DATE OF EQUIPMENT RECEIPT:

October 16, 2023

DATE(S) OF TESTING:

October 16, 17, 19, 23-27, 2023
and November 2, 2023

Revision History

Original: Testing of the JZ7XYR to FCC Part 15 Subpart C Section(s) 15.207 & 15.247 (HYBRID 902-928 MHZ).

Revision A: To update data in the General Product Information table.

Report Authorization

The test data contained in this report documents the observed testing parameters pertaining to and are relevant for only the equipment provided by the client, tested in the agreed upon operational mode(s) and configuration(s) as identified herein. Compliance assessment remains the client's responsibility. This report may not be used to claim product endorsement by A2LA or any government agencies. This test report has been authorized for release under quality control from CKC Laboratories, Inc.



Steve Behm
Director of Quality Assurance & Engineering Services
CKC Laboratories, Inc.

Test Facility Information



Our laboratories are configured to effectively test a wide variety of product types. CKC utilizes first class test equipment, anechoic chambers, data acquisition and information services to create accurate, repeatable, and affordable test results.

TEST LOCATION(S):
CKC Laboratories, Inc.
22116 23rd Drive SE, Suite A
Bothell, WA 98021

Software Versions

CKC Laboratories Proprietary Software	Version
EMITest Emissions	5.03.20

Site Registration & Accreditation Information

Location	*NIST CB #	FCC	Canada	Japan
Canyon Park, Bothell, WA	US0103	US1024	3082C	A-0136
Brea, CA	US0103	US1024	3082D	A-0136
Fremont, CA	US0103	US1024	3082B	A-0136
Mariposa, CA	US0103	US1024	3082A	A-0136

*CKC's list of NIST designated countries can be found at: <https://standards.gov/cabs/designations.html>

SUMMARY OF RESULTS

Standard / Specification: FCC Part 15 Subpart C - 15.247 (Hybrid 902-928MHz)

Test Procedure	Description	Modifications	Results
15.247(a)(1)(i)	Occupied Bandwidth	NA	Pass
15.247(a)(1)	Carrier Separation	NA	Pass
15.247(a)(1)(i)	Number of Hopping Channels	NA	NA1
15.247(a)(1)(i)	Average Time of Occupancy	NA	NA1
15.247(b)(2)	Output Power	NA	Pass
15.247(d)	RF Conducted Emissions & Band Edge	NA	Pass
15.247(d)	Radiated Emissions & Band Edge	NA	Pass
15.247 (f)	Hybrid Systems Time of Occupancy	NA	Pass
15.247 (f)	Hybrid Systems Power Spectral Density	NA	Pass
15.207	AC Conducted Emissions	NA	Pass

NA = Not Applicable

NA1 = This test is not applicable under Hybrid System requirements section 15.247 (f)

ISO/IEC 17025 Decision Rule

The equipment sample utilized for testing is selected by the manufacturer. The declaration of pass or fail herein is a binary statement for simple acceptance rule (ILAC G8) based upon assessment to the specification(s) listed above, without consideration of measurement uncertainties. For performance related tests, equipment was monitored for specified criteria identified in that section of testing.

Modifications During Testing

This list is a summary of the modifications made to the equipment during testing.

Summary of Conditions

No modifications were made during testing.

Modifications listed above must be incorporated into all production units.

Conditions During Testing

This list is a summary of the conditions noted to the equipment during testing.

Summary of Conditions

None

EQUIPMENT UNDER TEST (EUT)

During testing, numerous configurations may have been utilized. The configurations listed below support compliance to the standard(s) listed in the Summary of Results section.

Configuration 1

Equipment Tested:

Device	Manufacturer	Model #	S/N
NA	Nalloy, LLC	JZ7XYR	NA

Support Equipment:

Device	Manufacturer	Model #	S/N
Laptop	Chuwi	Herobook Pro	JHeroBP2563201012960
AC Adapter	Apple	A1357	NA

Configuration 2

Equipment Tested:

Device	Manufacturer	Model #	S/N
NA	Nalloy, LLC	JZ7XYR	NA

Support Equipment:

Device	Manufacturer	Model #	S/N
Laptop	Chuwi	Herobook Pro	JHeroBP2563201012960
NA	Nalloy, LLC	24F9HC	NA
Laptop (for WISA network)	Lenovo	X230	9901661685
PoE Injector	Microsemi	PD-9601GC	NA

Configuration 5

Equipment Tested:

Device	Manufacturer	Model #	S/N
NA	Nalloy, LLC	JZ7XYR	NA

Support Equipment:

Device	Manufacturer	Model #	S/N
Laptop	HP	Elitebook	5CG213CCQ6
PoE Injector	Microsemi	PD-9601GC	NA
Wireless Access Point	Nalloy, LLC	LSMGY4	G3L201153016001D

General Product Information:

Product Information	Manufacturer-Provided Details
Equipment Type:	Radio Module
Type of Wideband System:	Hybrid
Operating Frequency Range:	902.4-927.6
Number of Hopping Channels:	64
Modulation Type(s):	GFSK-2
Maximum Duty Cycle:	Tested 100% as worst case
Number of TX Chains:	1
Antenna Type(s) and Gain:	Swivel Type Dipole, 1.57dBi declared per manufacturer
Beamforming Type:	NA
Antenna Connection Type:	External Connector
Nominal Input Voltage:	5VDC
Firmware / Software used for Test:	Realterm 2.0.0.70 Railtest_v3.01_Mongoose_EV1_200kB_GFSK2_902.4M_0-63ch_BER_mode_0dBm_Stream_PA1.8V.hex ihm-halcyon-node-halcyon-2.2.0 (1).hex
The validity of results is dependent on the stated product details, the accuracy of which the manufacturer assumes full responsibility.	

Block Diagram of Test Setup(s)

Configuration 1

Test Setup Block Diagram

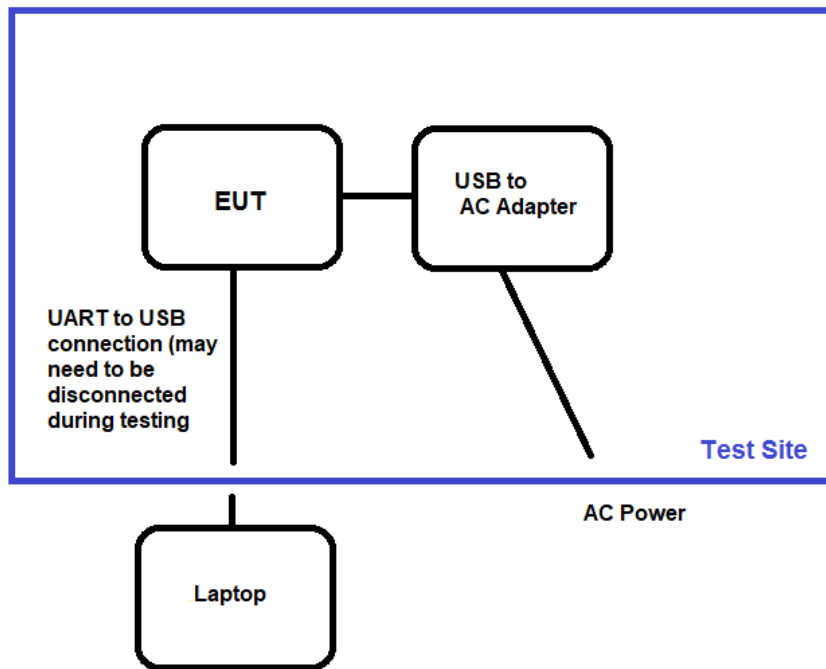

Configuration 2

Test Setup Block Diagram

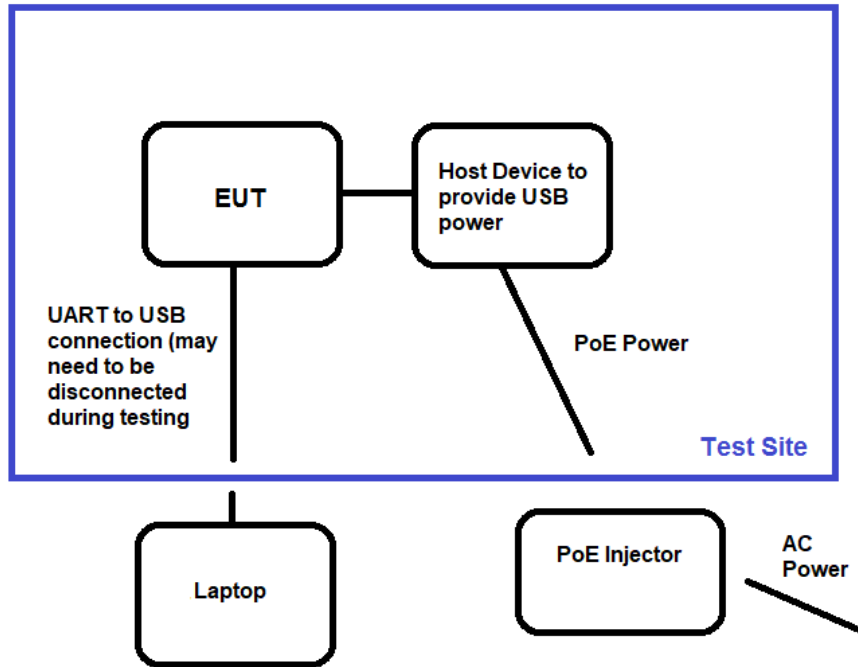

Configuration 5

Test Setup Block Diagram

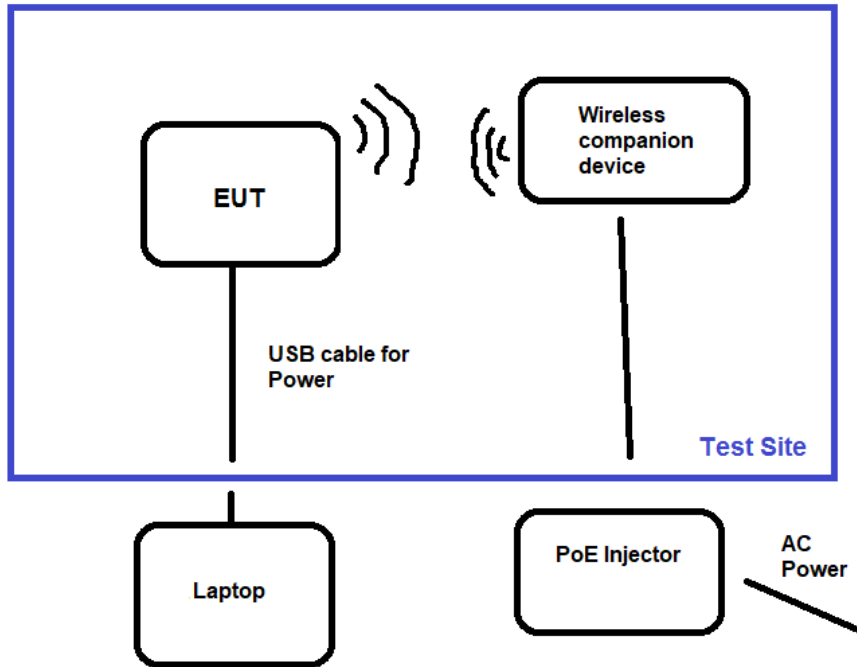

FCC Part 15 Subpart C

Note: Test setup photos are located in a separate attachment, #108788-57_TestSetupPhotos

15.247(a) Transmitter Characteristics

Test Setup/Conditions			
Test Location:	Bothell Lab Bench	Test Engineer:	M. Atkinson
Test Method:	ANSI C63.10 (2013)	Test Date(s):	10/23/23
Configuration:	1		
Test Setup:	EUT is directly connected to spectrum analyzer with appropriate attenuation and cables. The EUT is continuously transmitting being controlled through support laptop.		

Environmental Conditions			
Temperature (°C)	20-22	Relative Humidity (%):	38-55

Test Equipment					
Asset#	Description	Manufacturer	Model	Cal Date	Cal Due
03803	Spectrum Analyzer	Agilent	E4440A	2/23/2022	2/23/2024
P07226	Attenuator	Pasternack	PE7004-6	8/25/2023	8/25/2025
P07610	Cable	Andrews	Heliac	4/19/2023	4/19/2025

15.247(a)(1) Occupied Bandwidth

20dB Occupied Bandwidth

Test Data Summary					
Frequency (MHz)	Antenna Port	Modulation	Measured (kHz)	Limit (kHz)	Results
902.4	1	GFSK-2	248.118	*See Note	NA
914.8	1	GFSK-2	248.335		
927.6	1	GFSK-2	247.942		

*For this Hybrid mode there is no requirement to meet the FHSS or DTS bandwidth limits. See 15.247 (f) Hybrid Systems.

6dB DTS Occupied Bandwidth

Test Data Summary					
Frequency (MHz)	Antenna Port	Modulation	Measured (kHz)	Limit (kHz)	Results
902.4	1	GFSK-2	243.965	*See Note	NA
914.8	1	GFSK-2	244.123		
927.6	1	GFSK-2	243.597		

*For this Hybrid mode there is no requirement to meet the FHSS or DTS bandwidth limits. See 15.247 (f) Hybrid Systems.

Plot(s)

20dB Occupied Bandwidth

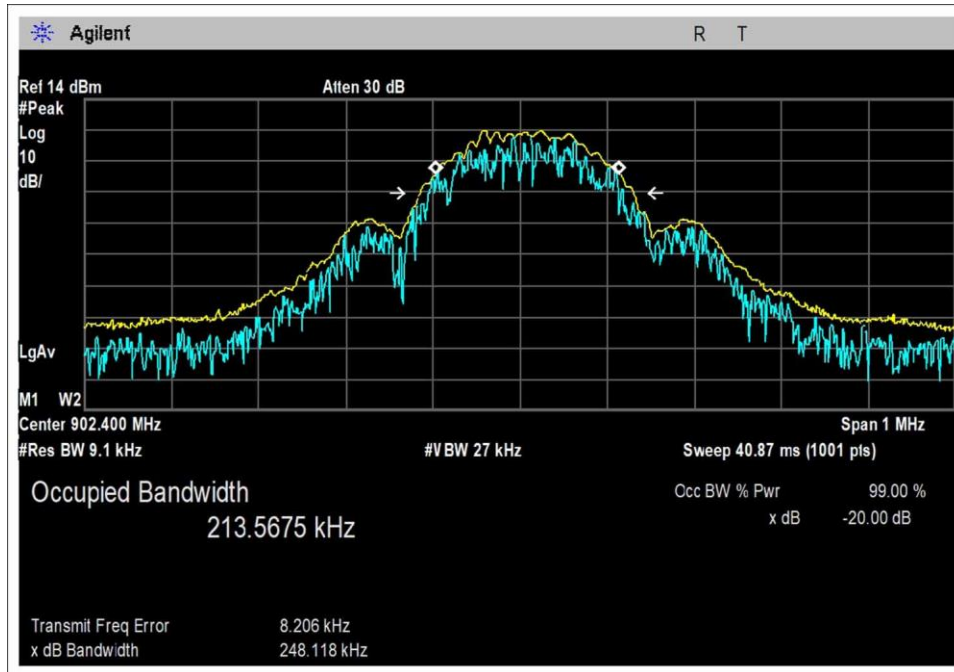

Low Channel

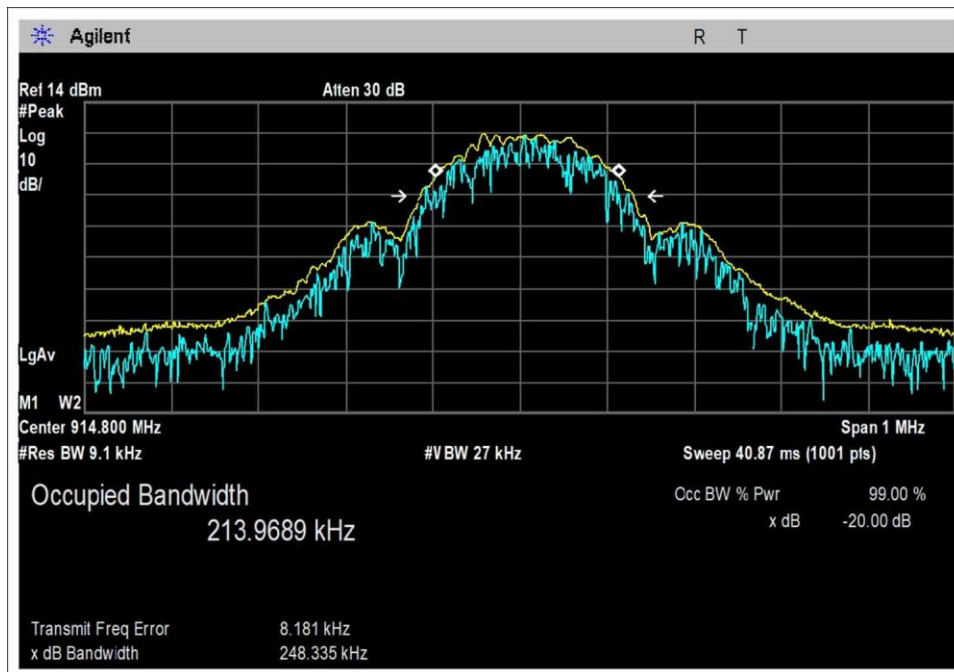

Middle Channel

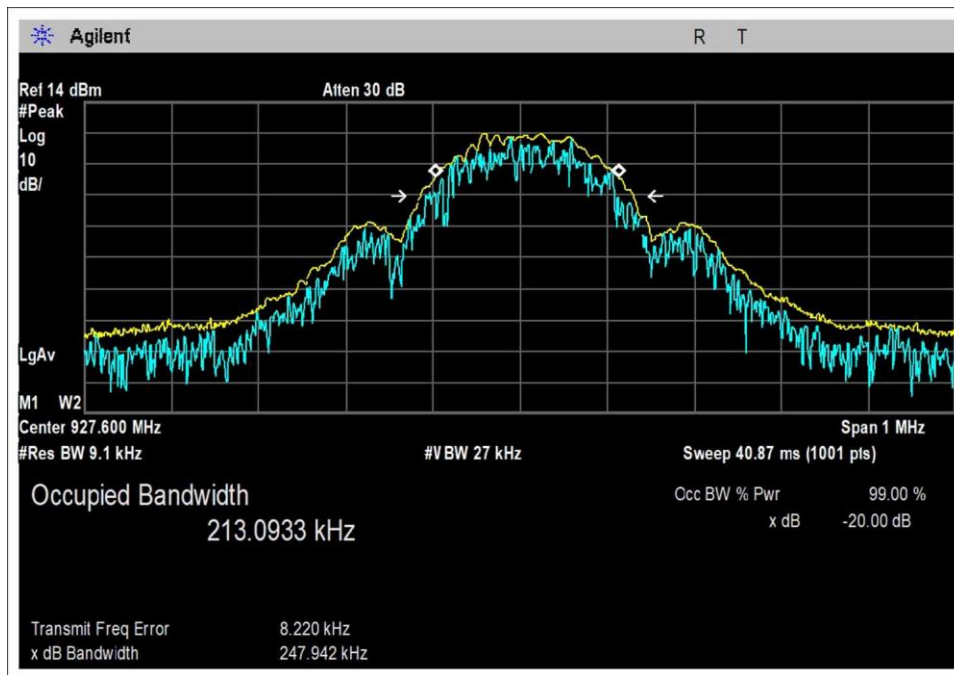

High Channel

6dB DTS Occupied Bandwidth

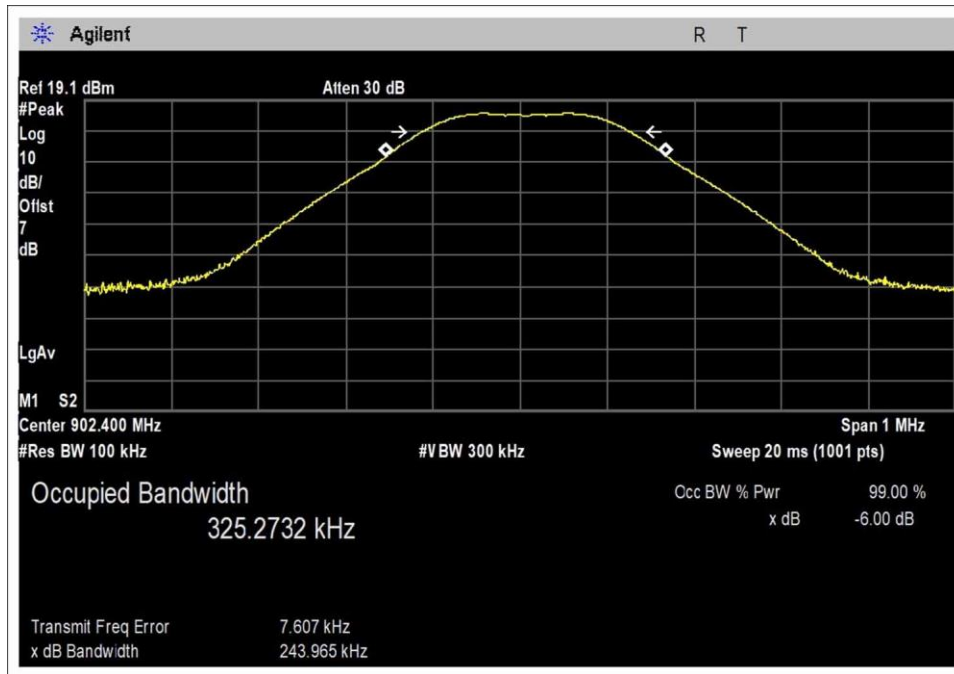

Low Channel

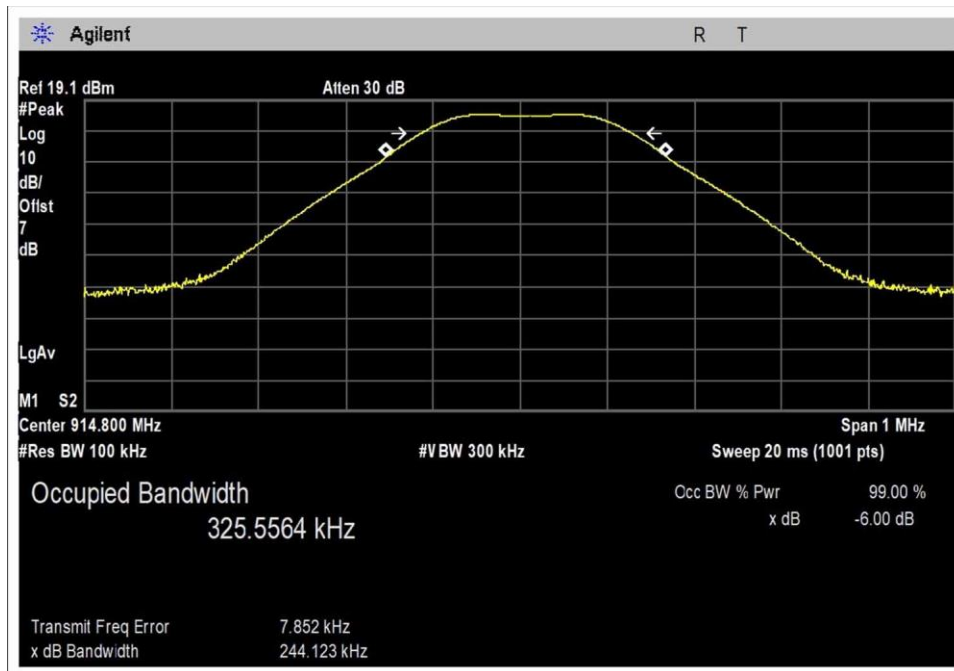

Middle Channel

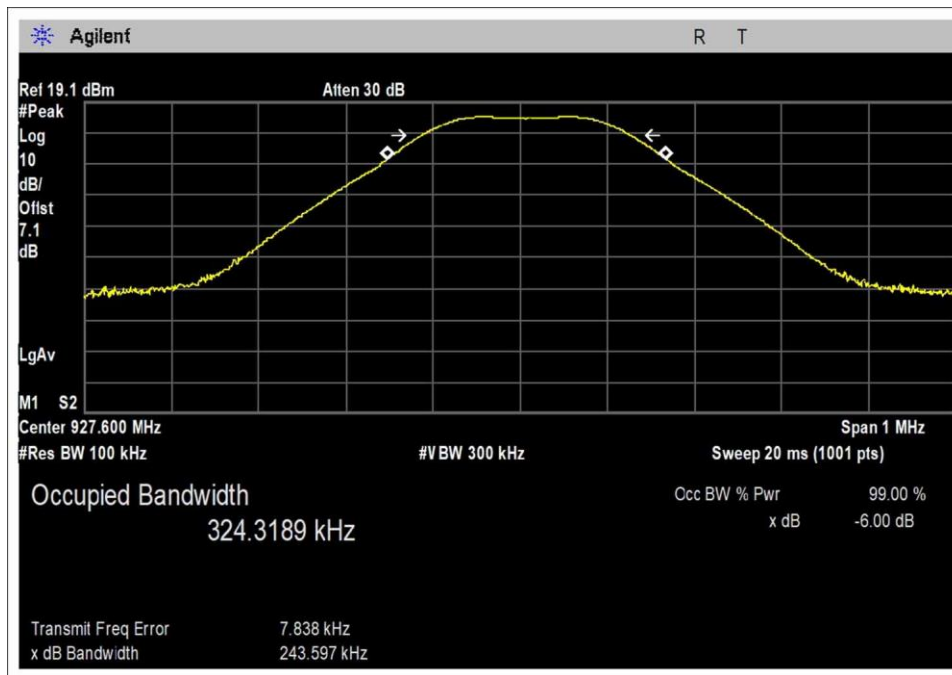

High Channel

15.247(a)(1) Carrier Separation

Test Data Summary				
Limit applied: 20dB bandwidth of the hopping channel.				
Antenna Port	Operational Mode	Measured (kHz)	Limit (kHz)	Results
1	Transmitting	396.3	≥248.335	Pass

Plot(s)

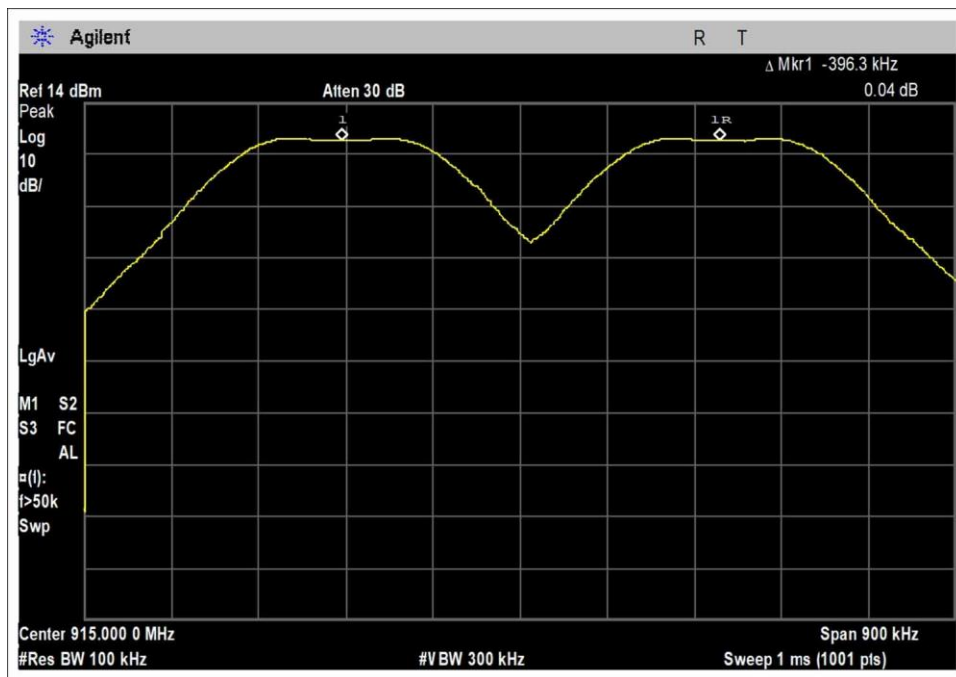

Channel Separation

15.247(a)(1)(i) Number of Channels

Test Data Summary				
Antenna Port	Operational Mode	Measured (Channels)	Limit (Channels)	Results
1	Transmitting	64	*See Note	NA

*For this Hybrid Mode there is no minimum number of hopping channels.

Plot(s)

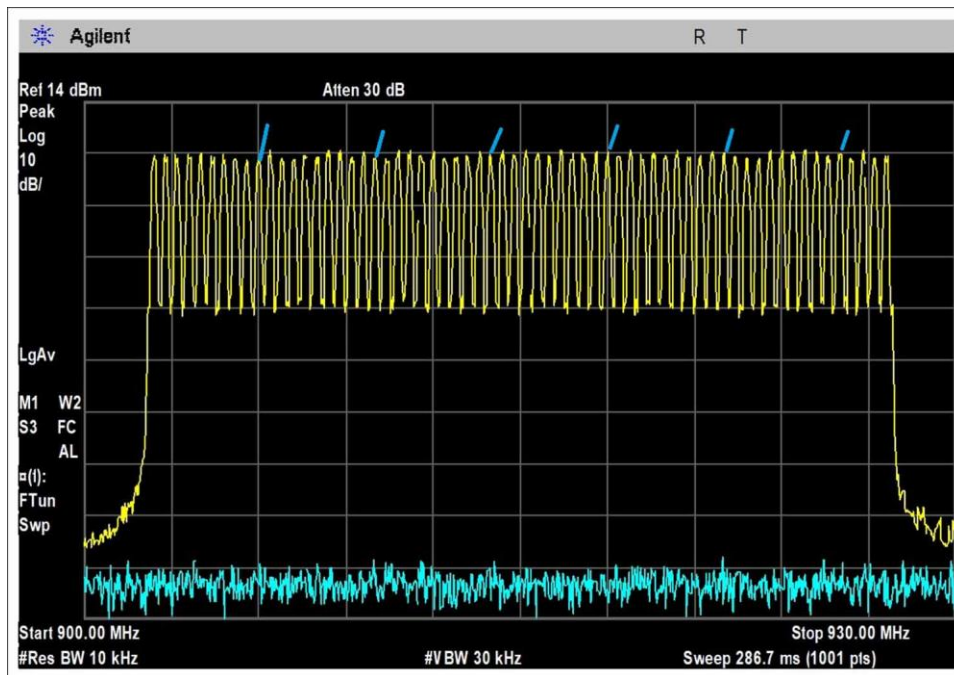

Number Channels

15.247(b)(2) Output Power

Test Setup/Conditions

Test Location:	Bothell Lab Bench	Test Engineer:	M. Atkinson
Test Method:	ANSI C63.10 (2013)	Test Date(s):	10/23/23 to 10/27/23
Configuration:	1		
Test Setup:	EUT is directly connected to spectrum analyzer with appropriate attenuation and cables. The EUT is continuously transmitting being controlled through support laptop. The correction factor for the system has been loaded into the spectrum analyzer.		

Environmental Conditions

Temperature (°C)	20-22	Relative Humidity (%):	38-55
------------------	-------	------------------------	-------

Test Equipment

Asset	Description	Manufacturer	Model	Cal Date	Cal Due
03803	Spectrum Analyzer	Agilent	E4440A	2/23/2022	2/23/2024
P07226	Attenuator	Pasternack	PE7004-6	8/25/2023	8/25/2025
P07610	Cable	Andrews	Heliac	4/19/2023	4/19/2025
1318	Multimeter	Fluke	85	7/20/2023	7/20/2025
P07788	DC 5 amp Power Supply	Rigol	DP711	1/19/2022	1/19/2024

Test Data Summary - Voltage Variations

Frequency (MHz)	Modulation	V _{Minimum} (dBm)	V _{Nominal} (dBm)	V _{Maximum} (dBm)	Max Deviation from V _{Nominal} (dB)
902.4	GFSK-2	14.5	14.5	14.5	0.0
914.8	GFSK-2	14.3	14.3	14.3	0.0
927.6	GFSK-2	14.2	14.2	14.2	0.0

Test performed using operational mode with the highest output power, representing worst case.

Parameter Definitions:

Measurements performed at input voltage V_{Nominal} ± 15%.

Parameter	Value
V _{Nominal} :	5.00VDC
V _{Minimum} :	4.25VDC
V _{Maximum} :	5.75VDC

Test Data Summary - RF Conducted Measurement

Limit = 30dBm Conducted/36dBm EIRP

Frequency (MHz)	Modulation	Ant Gain	Measured (dBm)	Limit (dBm)	Results
902.4	GFSK-2	1.57 dBi	14.5	≤30	Pass
914.8	GFSK-2	1.57 dBi	14.3	≤30	Pass
927.6	GFSK-2	1.57 dBi	14.2	≤30	Pass

For this Hybrid Mode there is no minimum number of hopping channels required for the 1 Watt (30dBm) limit.

Plot(s)

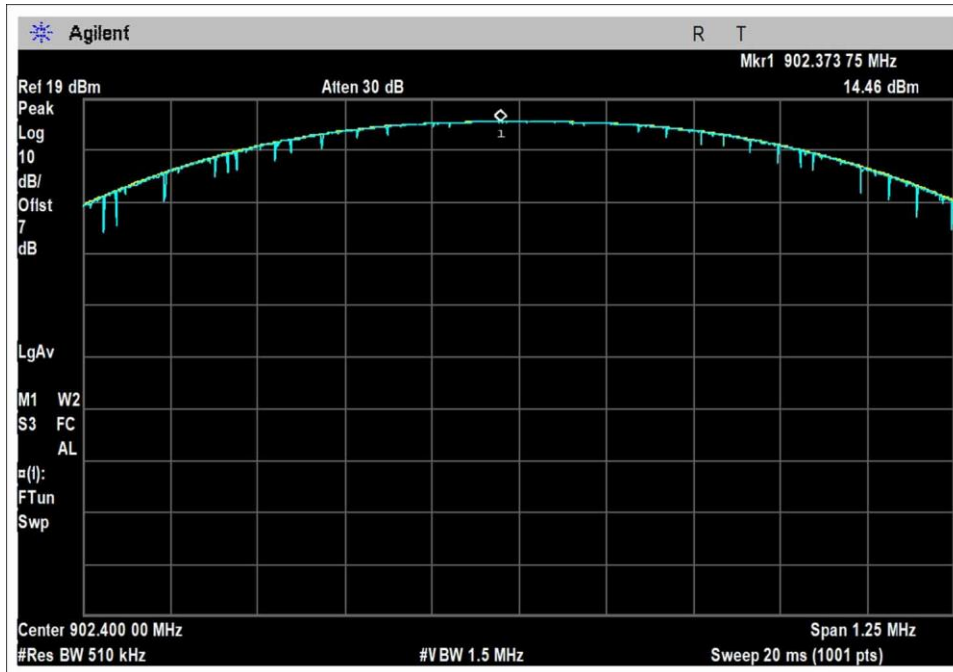

Low Channel

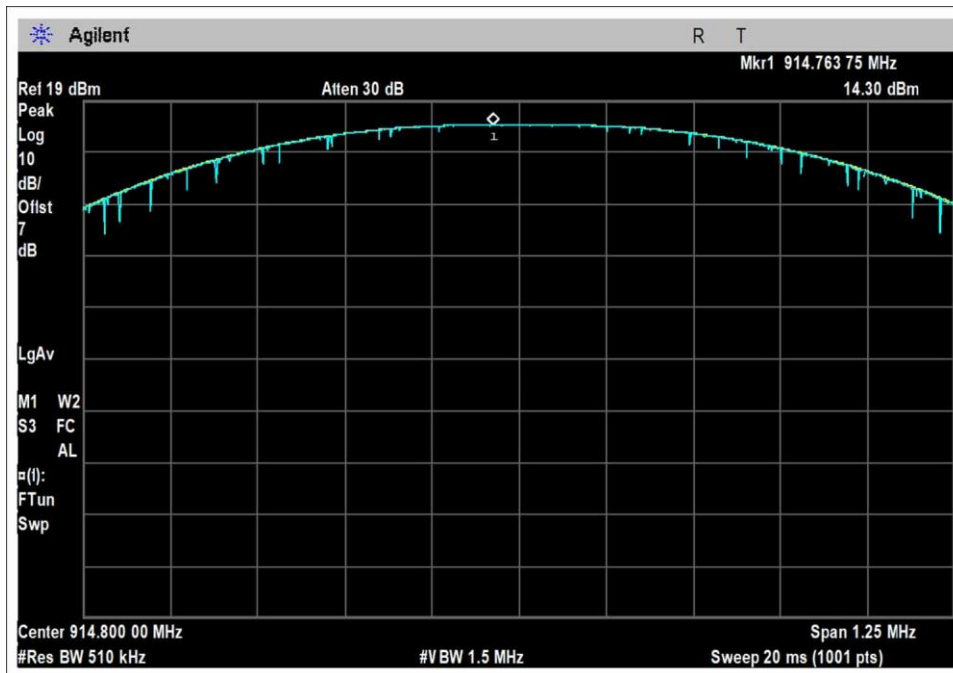

Middle Channel

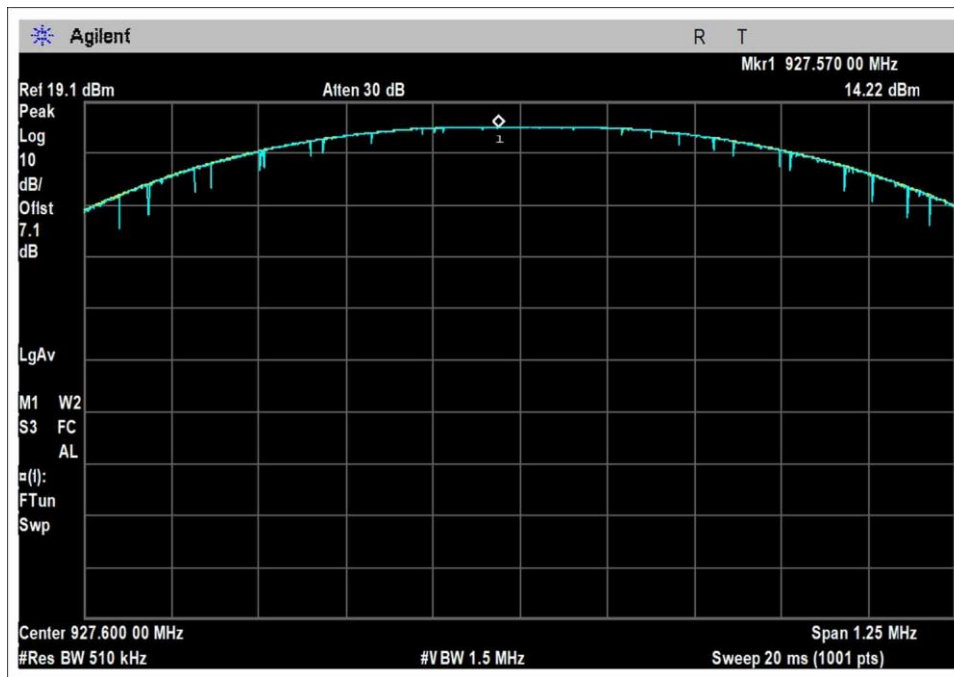

High Channel

15.247(d) RF Conducted Emissions & Band Edge

Test Setup / Conditions / Data

Test Location: CKC Laboratories, Inc. • 22116 23rd Drive SE, Suite A • Bothell, WA 98021 • 1-800-500-4EMC (4362)
 Customer: **Nalloy, LLC**
 Specification: **15.247(d) Conducted Spurious Emissions**
 Work Order #: **108788** Date: 10/23/2023
 Test Type: **Conducted Emissions** Time: 15:37:57
 Tested By: Michael Atkinson Sequence#: 22
 Software: EMITest 5.03.20 120V 60Hz

Equipment Tested:

Device	Manufacturer	Model #	S/N
Configuration 1			

Support Equipment:

Device	Manufacturer	Model #	S/N
Configuration 1			

Test Conditions / Notes:

Test Environment Conditions:
 Temperature: 22°C
 Humidity: 55%
 Pressure: 100.9.6kPa

Test Method: ANSI C63.10 (2013)

Frequency Range: 9kHz-10GHz

Test Setup:
 EUT is directly connected to spectrum analyzer with appropriate attenuation and cables. The EUT is continuously transmitting being controlled through support laptop.

Low, Middle, High channels investigated.

Nalloy, LLC WO#: 108788 Sequence#: 22 Date: 10/23/2023
 15.247(d) Conducted Spurious Emissions Test Lead: 120V 60Hz RF Port

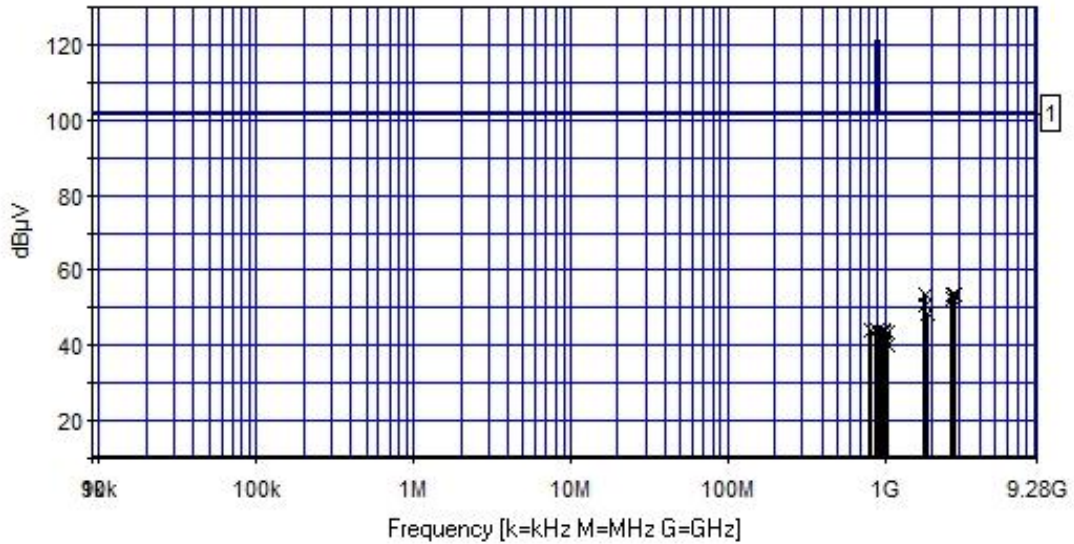

Test Equipment:

ID	Asset #	Description	Model	Calibration Date	Cal Due Date
	AN03803	Spectrum Analyzer	E4440A	2/23/2022	2/23/2024
T1	ANP07226	Attenuator	PE7004-6	8/25/2023	8/25/2025
T2	ANP05542	Cable	Heliac	2/8/2023	2/8/2025

Measurement Data:

Reading listed by margin.

Test Lead: RF Port

#	Freq MHz	Rdng dB μ V	T1 dB	T2 dB		Dist dB	Table	Corr dB μ V	Spec dB μ V	Margin dB	Polar Ant
1	2782.000M	45.4	+5.9	+2.1		+0.0		53.4	101.3 927.6	-47.9	RF Po
2	2708.000M	45.5	+5.9	+2.0		+0.0		53.4	101.3 902.4	-47.9	RF Po
3	1805.000M	45.8	+5.9	+1.7		+0.0		53.4	101.3 902.4	-47.9	RF Po
4	2744.000M	44.7	+5.9	+2.0		+0.0		52.6	101.3 914.8	-48.7	RF Po
5	1830.000M	43.3	+5.9	+1.7		+0.0		50.9	101.3 914.8	-50.4	RF Po
6	1855.000M	40.6	+5.9	+1.8		+0.0		48.3	101.3 927.6	-53.0	RF Po
7	812.500M	37.2	+5.9	+1.1		+0.0		44.2	101.3 927.6	-57.1	RF Po
8	889.000M	37.2	+5.9	+1.1		+0.0		44.2	101.3 927.6	-57.1	RF Po
9	979.000M	36.9	+5.9	+1.2		+0.0		44.0	101.3 902.4	-57.3	RF Po
10	1030.000M	36.6	+5.9	+1.2		+0.0		43.7	101.3 914.8	-57.6	RF Po
11	991.500M	36.2	+5.9	+1.2		+0.0		43.3	101.3 914.8	-58.0	RF Po
12	941.000M	36.2	+5.9	+1.2		+0.0		43.3	101.3 902.4	-58.0	RF Po
13	967.000M	35.0	+5.9	+1.2		+0.0		42.1	101.3 927.6	-59.2	RF Po
14	1042.000M	32.8	+5.9	+1.3		+0.0		40.0	101.3 927.6	-61.3	RF Po

Band Edge

Band Edge Summary

Limit applied: Max Power/100kHz - 20dB.
 Operating Mode: Single Channel (Low and High)
 100kHz measured in dB μ V = 121.3

Frequency (MHz)	Modulation	Measured (dB μ V)	Limit (dB μ V)	Results
902	GFSK-2	69.9	<101.3	Pass
928	GFSK-2	67.3	<101.3	Pass

Band Edge Summary

Limit applied: Max Power/100kHz - 20dB.
 Operating Mode: Hopping
 100kHz measured in dB μ V = 121.3

Frequency (MHz)	Modulation	Measured (dB μ V)	Limit (dB μ V)	Results
902	GFSK-2	68.9	<101.3	Pass
928	GFSK-2	67.1	<101.3	Pass

Band Edge Plots

Single Channel

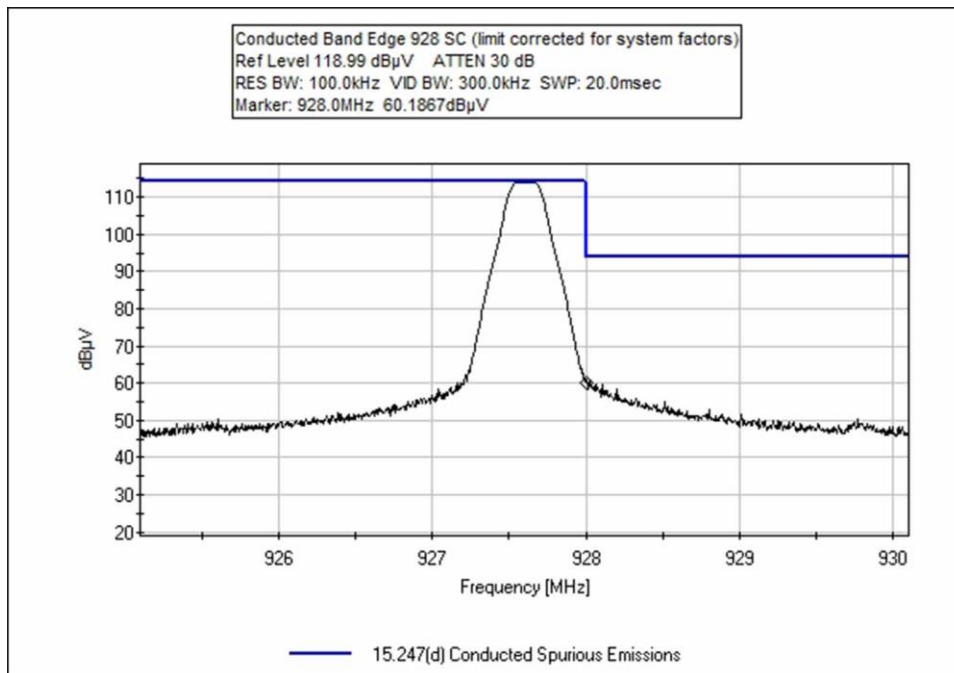
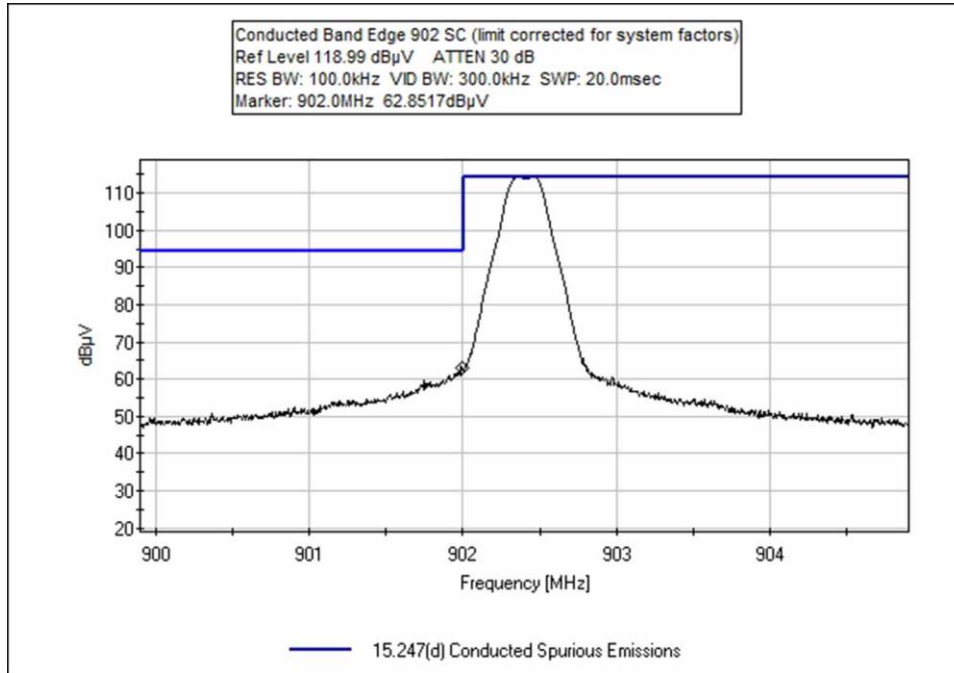

Hopping

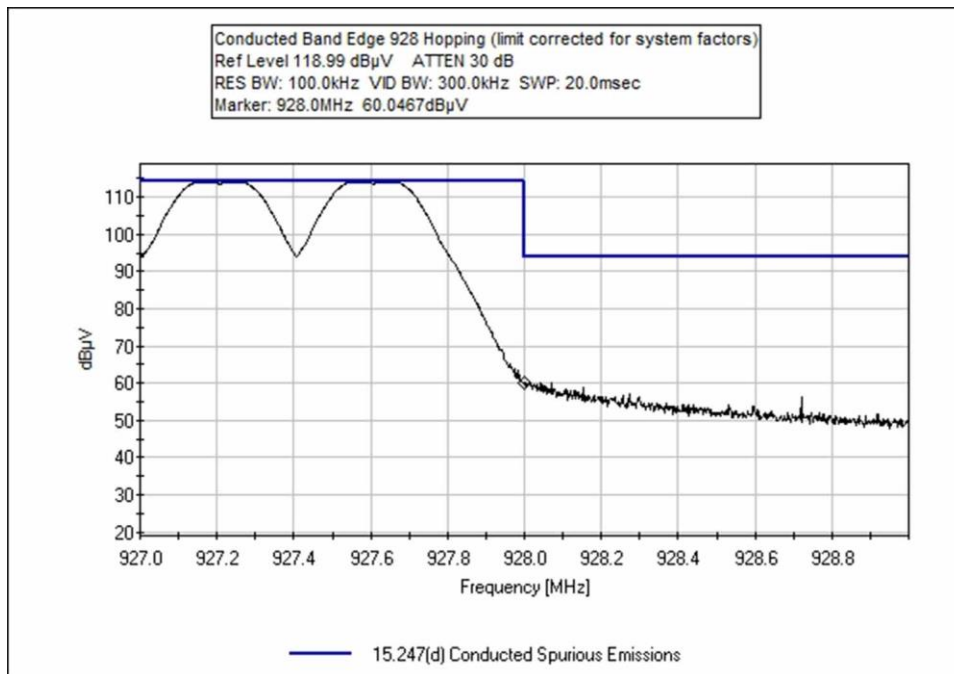
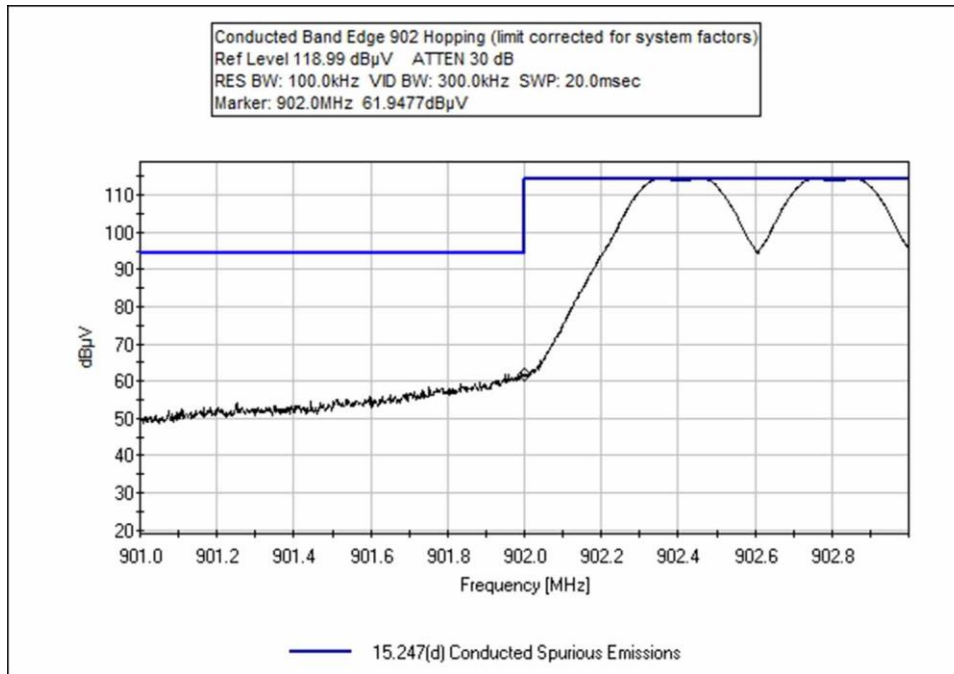

Test Setup / Conditions / Data

Test Location: CKC Laboratories, Inc. • 22116 23rd Drive SE, Suite A • Bothell, WA 98021 • 1-800-500-4EMC (4362)
 Customer: **Nalloy, LLC**
 Specification: **15.247(d) Conducted Spurious Emissions**
 Work Order #: **108788** Date: 10/23/2023
 Test Type: **Conducted Emissions** Time: 15:24:03
 Tested By: Michael Atkinson Sequence#: 21
 Software: EMITest 5.03.20 120V 60Hz

Equipment Tested:

Device	Manufacturer	Model #	S/N
Configuration 1			

Support Equipment:

Device	Manufacturer	Model #	S/N
Configuration 1			

Test Conditions / Notes:

Test Environment Conditions:
 Temperature: 22°C
 Humidity: 55%
 Pressure: 100.9.6kPa

 Test Method: ANSI C63.10 (2013)

 Frequency Range: Band Edge

 Test Setup:
 EUT is directly connected to spectrum analyzer with appropriate attenuation and cables. The EUT is continuously transmitting being controlled through support laptop.

 Single Channel and Hopping modes investigated.

Test Equipment:

ID	Asset #	Description	Model	Calibration Date	Cal Due Date
T1	AN03803	Spectrum Analyzer	E4440A	2/23/2022	2/23/2024
T2	ANP07226	Attenuator	PE7004-6	8/25/2023	8/25/2025
T3	ANP05542	Cable	Heliac	2/8/2023	2/8/2025

Measurement Data:

Reading listed by margin.

Test Lead: RF Port

#	Freq MHz	Rdng dB μ V	T1 dB	T2 dB	T3 dB	Dist dB	Dist Table	Corr dB μ V	Spec dB μ V	Margin dB	Polar Ant
1	902.000M	62.9	+0.0	+5.9	+1.1		+0.0	69.9	101.3 SC	-31.4	RF Po
2	902.000M	61.9	+0.0	+5.9	+1.1		+0.0	68.9	101.3 Hopping	-32.4	RF Po
3	928.000M	60.2	+0.0	+5.9	+1.2		+0.0	67.3	101.3 SC	-34.0	RF Po
4	928.000M	60.0	+0.0	+5.9	+1.2		+0.0	67.1	101.3 Hopping	-34.2	RF Po

15.247(d) Radiated Emissions & Band Edge

Test Setup / Conditions / Data

Test Location: CKC Laboratories, Inc. • 22116 23rd Drive SE, Suite A • Bothell, WA 98021 • 1-800-500-4EMC (4362)
 Customer: **Nalloy, LLC**
 Specification: **15.247(d) / 15.209 Radiated Spurious Emissions**
 Work Order #: **108788** Date: 10/17/2023
 Test Type: **Maximized Emissions** Time: 09:14:15
 Tested By: Michael Atkinson Sequence#: 4
 Software: EMITest 5.03.20

Equipment Tested:

Device	Manufacturer	Model #	S/N
Configuration 1			

Support Equipment:

Device	Manufacturer	Model #	S/N
Configuration 1			

Test Conditions / Notes:

Test Environment Conditions:
 Temperature: 22°C
 Humidity: 56%
 Pressure: 100.9kPa

Test Method: ANSI C63.10 (2013)

Frequency Range: 9kHz-30MHz

Test Setup:
 Low Channel (0) 902.4 MHz, Mid (31) 914.8MHz, High (63) 927.6MHz
 GFSK-2
 100% Duty Cycle

PWR Level Setting: 140

3 x orthogonal axes investigated, worst case reported.

X, Y, Z orientations and tx antenna straight and bent investigated with worst case reported.

Nalloy, LLC WO#: 108788 Sequence#: 4 Date: 10/17/2023
 15.247(d) / 15.209 Radiated Spurious Emissions Test Distance: 3 Meters Various

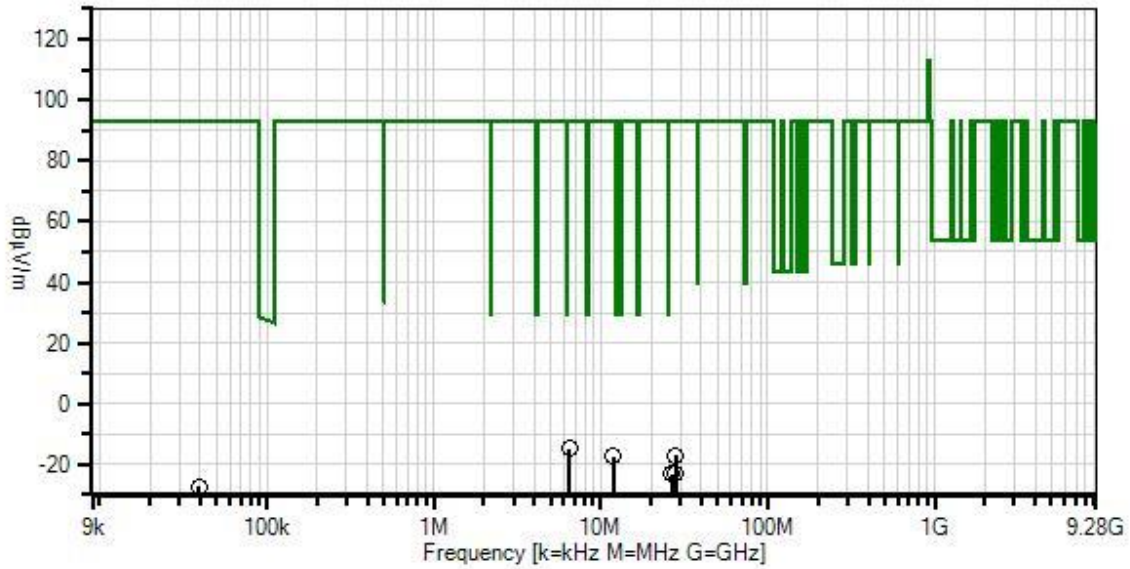

— Readings
 × QP Readings
 ▼ Ambient
 ○ Peak Readings
 * Average Readings
 Software Version: 5.03.20
 1 - 15.247(d) / 15.209 Radiated Spurious Emissions

Test Equipment:

ID	Asset #	Description	Model	Calibration Date	Cal Due Date
	AN02673	Spectrum Analyzer	E4446A	3/2/2023	3/2/2025
T1	ANP05546	Cable	Heliacx	8/1/2023	8/1/2025
T2	ANP06515	Cable	Heliacx	3/1/2023	3/1/2025
T3	AN00052	Loop Antenna	6502	5/11/2022	5/11/2024

Measurement Data: Reading listed by margin. Test Distance: 3 Meters

#	Freq MHz	Rdng dB μ V	T1 dB	T2 dB	T3 dB	Dist Table	Corr dB μ V/m	Spec dB μ V/m	Margin dB	Polar Ant
1	6.452M	16.3	+0.1	+0.1	+8.9	-40.0	-14.6	93.0	-107.6	Para
2	27.941M	18.1	+0.1	+0.3	+4.5	-40.0	-17.0	93.0	-110.0	Groun
3	11.933M	13.7	+0.1	+0.2	+8.8	-40.0	-17.2	93.0	-110.2	Para
4	27.941M	12.1	+0.1	+0.3	+4.5	-40.0	-23.0	93.0	-116.0	Para
5	26.607M	11.2	+0.1	+0.3	+5.2	-40.0	-23.2	93.0	-116.2	Perp
6	39.394k	42.4	+0.0	+0.0	+10.3	-80.0	-27.3	93.0	-120.3	Groun

Test Location: CKC Laboratories, Inc. • 22116 23rd Drive SE, Suite A • Bothell, WA 98021 • 1-800-500-4EMC (4362)
 Customer: **Nalloy, LLC**
 Specification: **15.247(d) / 15.209 Radiated Spurious Emissions**
 Work Order #: **108788** Date: 10/17/2023
 Test Type: **Maximized Emissions** Time: 08:36:55
 Tested By: Michael Atkinson Sequence#: 2
 Software: EMITest 5.03.20

Equipment Tested:

Device	Manufacturer	Model #	S/N
Configuration 1			

Support Equipment:

Device	Manufacturer	Model #	S/N
Configuration 1			

Test Conditions / Notes:

Test Environment Conditions:
 Temperature: 22°C
 Humidity: 56%
 Pressure: 100.9kPa

Test Method: ANSI C63.10 (2013)

Frequency Range: 30-1000MHz

Test Setup:
 Low Channel (0) 902.4 MHz, Mid (31) 914.8MHz, High (63) 927.6MHz
 GFSK-2
 100% Duty Cycle

PWR Level Setting: 140

Horizontal and Vertical polarities investigated, worst case reported.

X, Y, Z orientations and tx antenna straight and bent investigated with worst case reported.

Nalloy, LLC W/O#: 108788 Sequence#: 2 Date: 10/17/2023
 15.247(d) / 15.209 Radiated Spurious Emissions Test Distance: 3 Meters H+V

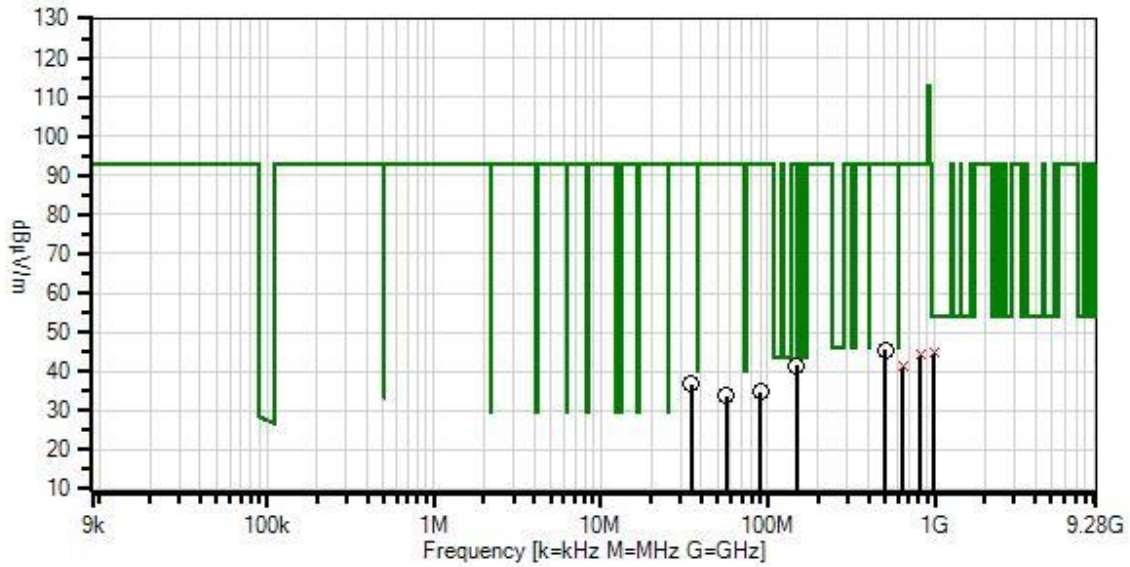

- Readings
 - × QP Readings
 - ▼ Ambient
 - 1 - 15.247(d) / 15.209 Radiated Spurious Emissions
 - Peak Readings
 - * Average Readings
- Software Version: 5.03.20

Test Equipment:

ID	Asset #	Description	Model	Calibration Date	Cal Due Date
	AN02673	Spectrum Analyzer	E4446A	3/2/2023	3/2/2025
T1	ANP05546	Cable	Heliac	8/1/2023	8/1/2025
T2	ANP05333	Cable	Heliac	8/8/2023	8/8/2025
T3	ANP05360	Cable	RG214	8/8/2023	8/8/2025
T4	AN03824	Biconilog Antenna	3142E	5/9/2023	5/9/2025

Measurement Data: Reading listed by margin. Test Distance: 3 Meters

#	Freq MHz	Rdng dB μ V	T1 dB	T2 dB	T3 dB	T4 dB	Dist Table	Corr dB μ V/m	Spec dB μ V/m	Margin dB	Polar Ant
1	986.400M	9.4	+0.7	+1.6	+2.6	+30.4	+0.0	44.7	54.0	-9.3	Vert
	QP										
^	986.400M	16.2	+0.7	+1.6	+2.6	+30.4	+0.0	51.5	54.0	-2.5	Vert
3	507.200M	17.0	+0.5	+1.1	+2.0	+24.8	+0.0	45.4	93.0	-47.6	Vert
4	815.800M	9.6	+0.6	+1.4	+2.5	+30.2	+0.0	44.3	93.0	-48.7	Horiz
	QP										
^	815.800M	16.6	+0.6	+1.4	+2.5	+30.2	+0.0	51.3	93.0	-41.7	Horiz
6	148.660M	24.8	+0.3	+0.6	+0.9	+14.9	+0.0	41.5	93.0	-51.5	Vert
7	644.800M	9.3	+0.5	+1.3	+2.4	+27.7	+0.0	41.2	93.0	-51.8	Vert
	QP										
^	644.800M	15.6	+0.5	+1.3	+2.4	+27.7	+0.0	47.5	93.0	-45.5	Vert
9	34.590M	16.6	+0.1	+0.3	+0.4	+19.3	+0.0	36.7	93.0	-56.3	Vert
10	90.100M	20.9	+0.2	+0.4	+0.6	+12.6	+0.0	34.7	93.0	-58.3	Horiz
11	56.200M	20.7	+0.1	+0.3	+0.5	+12.2	+0.0	33.8	93.0	-59.2	Vert

Test Location: CKC Laboratories, Inc. • 22116 23rd Drive SE, Suite A • Bothell, WA 98021 • 1-800-500-4EMC (4362)
 Customer: **Nalloy, LLC**
 Specification: **15.247(d) / 15.209 Radiated Spurious Emissions**
 Work Order #: **108788** Date: 10/17/2023
 Test Type: **Maximized Emissions** Time: 15:54:10
 Tested By: Steven Pittsford Sequence#: 5
 Software: EMITest 5.03.20

Equipment Tested:

Device	Manufacturer	Model #	S/N
Configuration 1			

Support Equipment:

Device	Manufacturer	Model #	S/N
Configuration 1			

Test Conditions / Notes:

Test Environment Conditions:
 Temperature: 22°C
 Humidity: 56%
 Pressure: 100.9kPa

 Test Method: ANSI C63.10 (2013)

 Frequency Range: 1-10GHz

 Test Setup:
 Low Channel (0) 902.4 MHz, Mid (31) 914.8MHz, High (63) 927.6MHz
 GFSK-2
 100% Duty Cycle

 PWR Level Setting: 140

 Vertical and Horizontal polarities, X, Y, Z axis, tx antenna straight and bent investigated with worst case reported.

Nalloy, LLC W/O#: 108788 Sequence#: 5 Date: 10/17/2023
 15.247(d) / 15.209 Radiated Spurious Emissions Test Distance: 3 Meters H+V

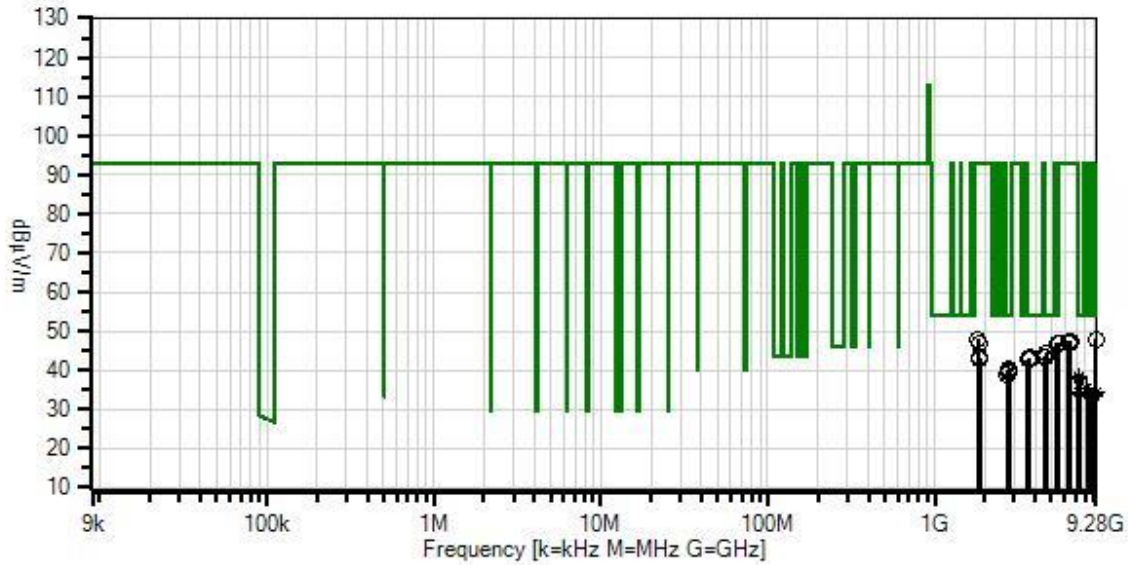

— Readings
 × QP Readings
 ▼ Ambient
 — 1 - 15.247(d) / 15.209 Radiated Spurious Emissions
 ○ Peak Readings
 * Average Readings
 Software Version: 5.03.20

Test Equipment:

ID	Asset #	Description	Model	Calibration Date	Cal Due Date
T1	AN02673	Spectrum Analyzer	E4446A	3/2/2023	3/2/2025
T2	ANP05546	Cable	Heliac	8/1/2023	8/1/2025
T3	AN03170	High Pass Filter	HM1155-11SS	9/27/2023	9/27/2025
T4	AN02374ANSI	Horn Antenna	RGA-60	5/26/2023	5/26/2025
T5	ANP06515	Cable	Heliac	3/1/2023	3/1/2025
T6	ANP07504	Cable	CLU40-KMKM-02.00F	1/24/2023	1/24/2025
T7	AN03540	Preamp	83017A	3/24/2023	3/24/2025

Measurement Data: Reading listed by margin. Test Distance: 3 Meters

#	Freq MHz	Rdng dB μ V	T1 T5 dB	T2 T6 dB	T3 T7 dB	T4 dB	Dist Table	Corr dB μ V/m	Spec dB μ V/m	Margin dB	Polar Ant
1	5414.175M	38.4	+0.0 +4.9	+1.7 +1.0	+0.4 -33.8	+34.4	+0.0	47.0	54.0 902.4	-7.0	Horiz 156
2	4638.265M	38.5	+0.0 +4.2	+1.3 +1.4	+0.5 -33.8	+32.4	+0.0	44.5	54.0 927.6	-9.5	Horiz 151
3	4571.810M	38.1	+0.0 +4.2	+1.3 +1.2	+0.4 -33.8	+32.2	+0.0	43.6	54.0 914.8	-10.4	Horiz 146
4	4608.760M	37.8	+0.0 +4.2	+1.3 +1.3	+0.5 -33.8	+32.3	+0.0	43.6	54.0 922.0	-10.4	Horiz 151
5	4510.665M	38.2	+0.0 +4.2	+1.2 +1.1	+0.4 -33.8	+32.1	+0.0	43.4	54.0 902.4	-10.6	Horiz 156
6	3710.080M	39.3	+0.0 +3.6	+1.5 +0.8	+0.3 -33.9	+31.6	+0.0	43.2	54.0 927.6	-10.8	Horiz 151
7	3688.305M	39.3	+0.0 +3.6	+1.5 +0.8	+0.3 -34.0	+31.5	+0.0	43.0	54.0 922.0	-11.0	Horiz 151
8	3658.955M	39.2	+0.0 +3.7	+1.4 +0.9	+0.3 -34.0	+31.4	+0.0	42.9	54.0 914.8	-11.1	Horiz 146
9	3608.180M	39.0	+0.0 +3.7	+1.4 +1.0	+0.4 -34.0	+31.3	+0.0	42.8	54.0 902.4	-11.2	Horiz 156
10	2782.430M	40.8	+0.0 +3.0	+1.2 +0.5	+0.3 -34.5	+29.3	+0.0	40.6	54.0 927.6	-13.4	Horiz 151
11	2766.015M	40.3	+0.0 +3.0	+1.2 +0.5	+0.3 -34.5	+29.3	+0.0	40.1	54.0 922.0	-13.9	Horiz 151
12	2744.805M	39.5	+0.0 +3.0	+1.2 +0.5	+0.3 -34.5	+29.3	+0.0	39.3	54.0 914.8	-14.7	Horiz 146
13	2707.030M	38.9	+0.0 +3.0	+1.2 +0.5	+0.3 -34.5	+29.3	+0.0	38.7	54.0 902.4	-15.3	Horiz 156
14	7318.980M Ave	27.0	+0.0 +5.3	+1.9 +1.4	+0.5 -35.1	+37.2	+0.0	38.2	54.0 914.8	-15.8	Horiz 146
^	7318.980M	38.0	+0.0 +5.3	+1.9 +1.4	+0.5 -35.1	+37.2	+0.0	49.2	54.0 914.8	-4.8	Horiz 146
16	8120.415M Ave	22.3	+0.0 +5.7	+2.6 +0.9	+0.5 -35.4	+38.9	+0.0	35.5	54.0 902.4	-18.5	Horiz 156
^	8120.415M	37.8	+0.0 +5.7	+2.6 +0.9	+0.5 -35.4	+38.9	+0.0	51.0	54.0 902.4	-3.0	Horiz 156
18	7377.835M Ave	22.8	+0.0 +5.5	+2.0 +1.3	+0.5 -35.1	+37.3	+0.0	34.3	54.0 922.0	-19.7	Horiz 151
^	7377.835M	37.2	+0.0 +5.5	+2.0 +1.3	+0.5 -35.1	+37.3	+0.0	48.7	54.0 922.0	-5.3	Horiz 151
20	8232.585M Ave	21.9	+0.0 +5.5	+2.6 +0.7	+0.5 -35.4	+38.4	+0.0	34.2	54.0 914.8	-19.8	Horiz 146
^	8232.585M	37.2	+0.0 +5.5	+2.6 +0.7	+0.5 -35.4	+38.4	+0.0	49.5	54.0 914.8	-4.5	Horiz 146
22	7420.420M Ave	22.5	+0.0 +5.5	+2.0 +1.2	+0.5 -35.1	+37.4	+0.0	34.0	54.0 927.6	-20.0	Horiz 151
^	7420.420M	37.9	+0.0 +5.5	+2.0 +1.2	+0.5 -35.1	+37.4	+0.0	49.4	54.0 927.6	-4.6	Horiz 151

24	9147.375M Ave	20.9	+0.0 +5.9	+2.4 +0.8	+0.9 -34.7	+37.7	+0.0	33.9	54.0 914.8	-20.1	Horiz 146
^	9147.375M	36.3	+0.0 +5.9	+2.4 +0.8	+0.9 -34.7	+37.7	+0.0	49.3	54.0 914.8	-4.7	Horiz 146
26	8299.740M Ave	21.6	+0.0 +5.5	+2.6 +0.6	+0.7 -35.4	+38.3	+0.0	33.9	54.0 922.0	-20.1	Horiz 151
^	8299.740M	36.5	+0.0 +5.5	+2.6 +0.6	+0.7 -35.4	+38.3	+0.0	48.8	54.0 922.0	-5.2	Horiz 151
28	8346.245M Ave	21.4	+0.0 +5.5	+2.6 +0.4	+0.8 -35.3	+38.3	+0.0	33.7	54.0 927.6	-20.3	Horiz 151
^	8346.245M	37.8	+0.0 +5.5	+2.6 +0.4	+0.8 -35.3	+38.3	+0.0	50.1	54.0 927.6	-3.9	Horiz 151
30	9024.430M Ave	19.9	+0.0 +6.0	+2.4 +1.2	+0.7 -34.8	+37.9	+0.0	33.3	54.0 902.4	-20.7	Horiz 156
^	9024.430M	35.1	+0.0 +6.0	+2.4 +1.2	+0.7 -34.8	+37.9	+0.0	48.5	54.0 902.4	-5.5	Horiz 156
32	9221.630M	35.5	+0.0 +5.8	+2.4 +0.5	+0.7 -34.7	+37.8	+0.0	48.0	93.0 922.0	-45.0	Horiz 151
33	1804.925M	51.9	+0.0 +2.2	+0.7 +0.4	+0.5 -35.1	+27.3	+0.0	47.9	93.0 902.4	-45.1	Horiz 156
34	6492.535M	37.3	+0.0 +5.8	+2.1 +1.2	+0.6 -34.3	+34.8	+0.0	47.5	93.0 927.6	-45.5	Horiz 151
35	6454.470M	37.6	+0.0 +5.7	+2.1 +1.1	+0.6 -34.3	+34.7	+0.0	47.5	93.0 922.0	-45.5	Horiz 151
36	5491.170M	37.8	+0.0 +5.1	+1.7 +1.3	+0.5 -33.8	+34.4	+0.0	47.0	93.0 914.8	-46.0	Horiz 146
37	5531.435M	37.5	+0.0 +5.2	+1.7 +1.3	+0.5 -33.8	+34.4	+0.0	46.8	93.0 922.0	-46.2	Horiz 151
38	1829.495M	50.4	+0.0 +2.3	+0.7 +0.4	+0.4 -35.1	+27.6	+0.0	46.7	93.0 914.8	-46.3	Horiz 146
39	6318.950M	37.2	+0.0 +5.4	+2.1 +0.9	+0.5 -34.2	+34.7	+0.0	46.6	93.0 902.4	-46.4	Horiz 156
40	5565.185M	37.3	+0.0 +5.2	+1.8 +1.3	+0.4 -33.8	+34.4	+0.0	46.6	93.0 927.6	-46.4	Horiz 151
41	6403.115M	37.0	+0.0 +5.6	+2.1 +1.0	+0.5 -34.3	+34.7	+0.0	46.6	93.0 914.8	-46.4	Horiz 146
42	1843.825M	46.9	+0.0 +2.3	+0.7 +0.4	+0.4 -35.0	+27.7	+0.0	43.4	93.0 922.0	-49.6	Horiz 151
43	1855.510M	46.3	+0.0 +2.3	+0.7 +0.4	+0.4 -35.0	+27.8	+0.0	42.9	93.0 927.6	-50.1	Horiz 151
44	7216.830M Ave	27.3	+0.0 +5.2	+1.8 +1.4	+0.5 -35.0	+36.8	+0.0	38.0	93.0 902.4	-55.0	Horiz 151
^	7216.830M	38.4	+0.0 +5.2	+1.8 +1.4	+0.5 -35.0	+36.8	+0.0	49.1	93.0 902.4	-43.9	Horiz 156
46	9277.720M Ave	21.7	+0.0 +5.9	+2.4 +0.4	+0.6 -34.6	+37.9	+0.0	34.3	93.0 927.6	-58.7	Horiz 151
^	9277.720M	36.7	+0.0 +5.9	+2.4 +0.4	+0.6 -34.6	+37.9	+0.0	49.3	93.0 927.6	-43.7	Horiz 151

Band Edge

Band Edge Summary

Operating Mode: Single Channel (Low and High)					
Frequency (MHz)	Modulation	Ant. Type	Field Strength (dBuV/m @3m)	Limit (dBuV/m @3m)	Results
614	GFSK-2	Swivel Type Dipole	28.9	<46	Pass
902	GFSK-2	Swivel Type Dipole	64.7	<93	Pass
928	GFSK-2	Swivel Type Dipole	62.0	< 93	Pass
960	GFSK-2	Swivel Type Dipole	35.2	<54	Pass

Band Edge Summary

Operating Mode: Hopping					
Frequency (MHz)	Modulation	Ant. Type	Field Strength (dBuV/m @3m)	Limit (dBuV/m @3m)	Results
614	GFSK-2	Swivel Type Dipole	30.2	<46	Pass
902	GFSK-2	Swivel Type Dipole	61.9	<93	Pass
928	GFSK-2	Swivel Type Dipole	64.3	< 93	Pass
960	GFSK-2	Swivel Type Dipole	36.7	<54	Pass

Band Edge Plots

Single Channel

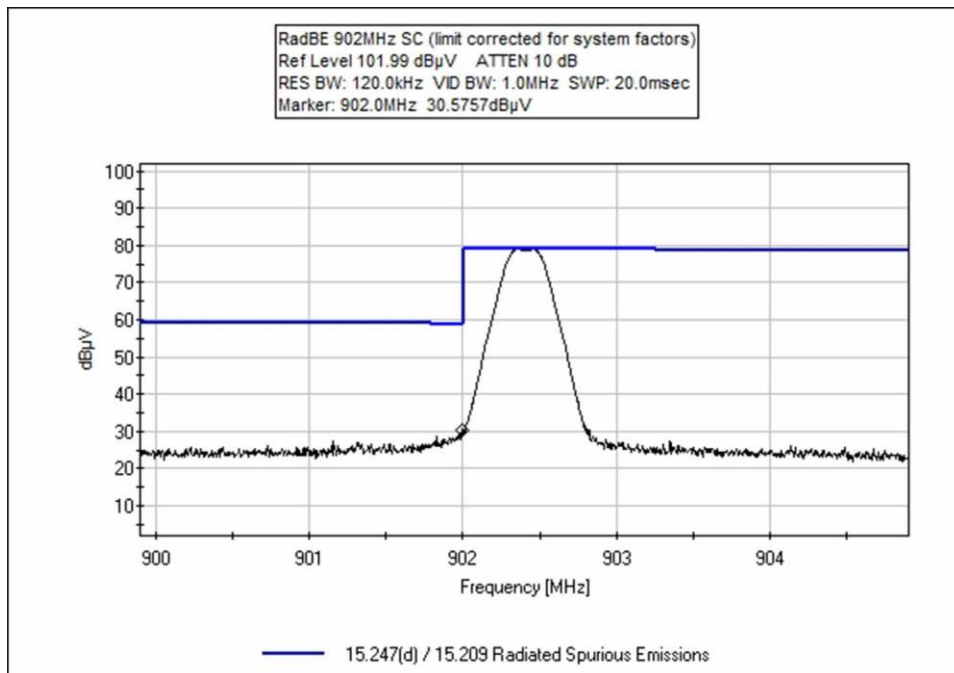
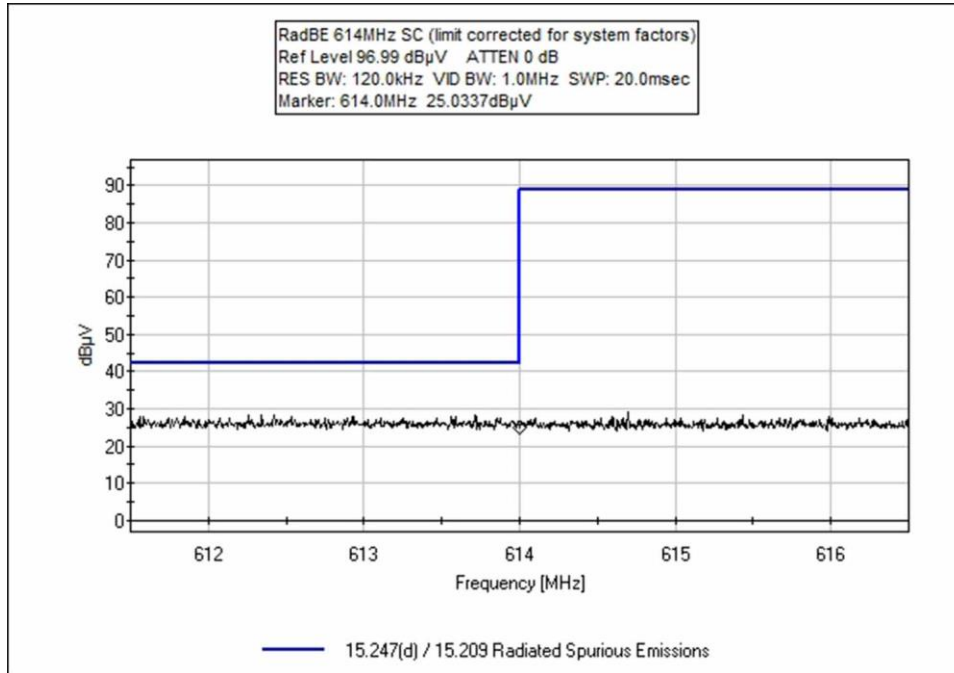

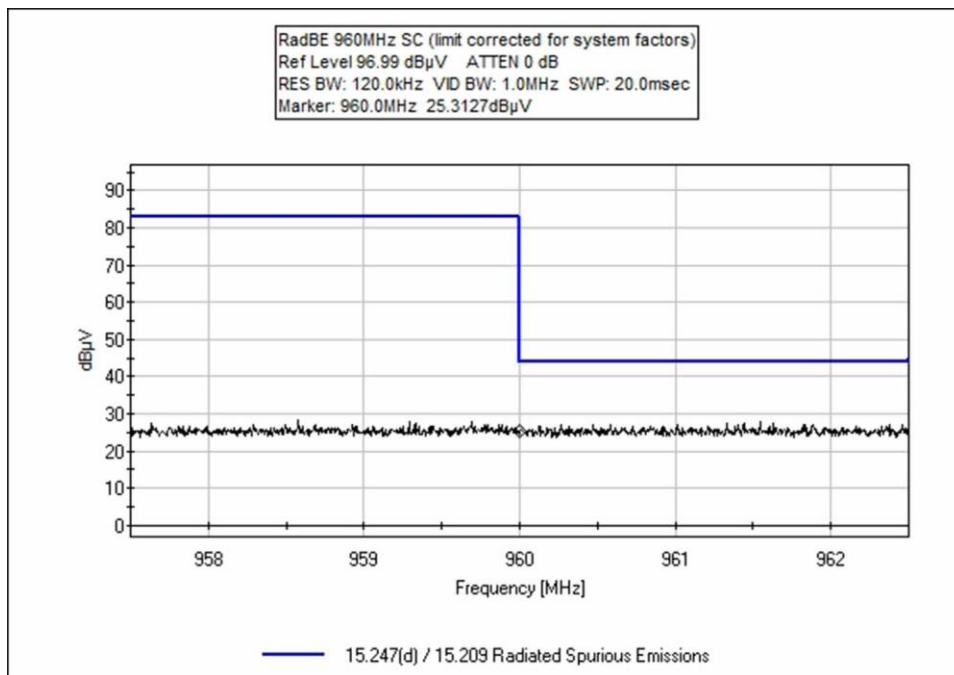
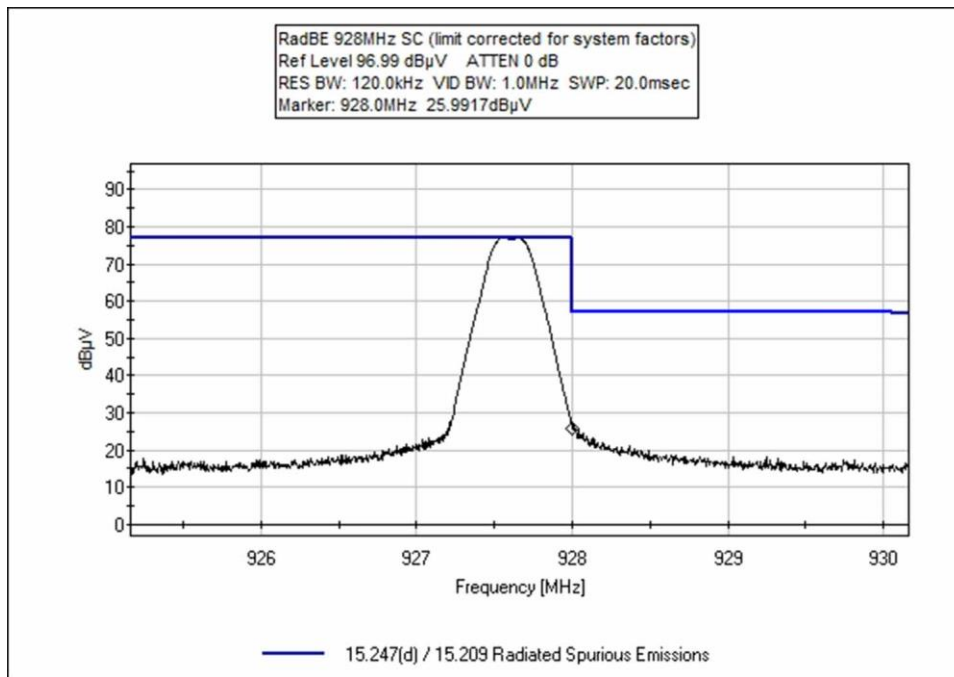

Hopping

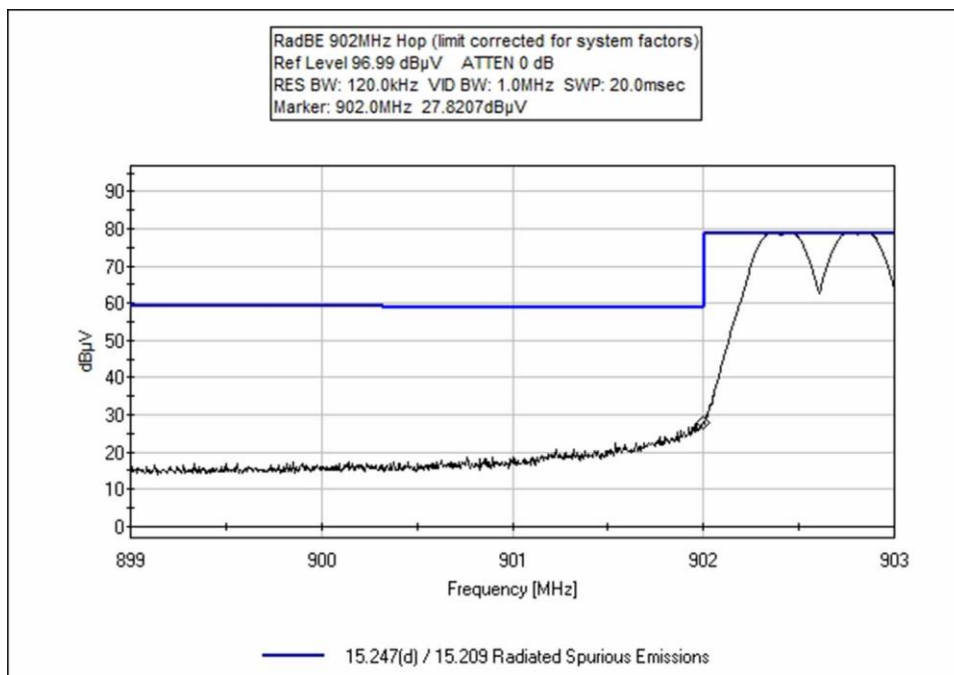
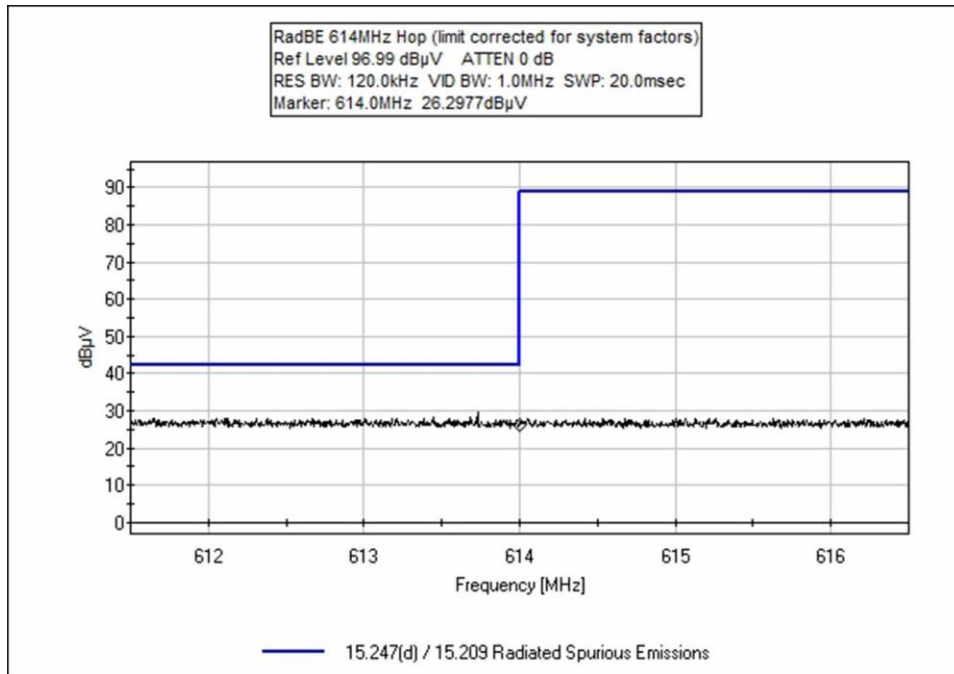

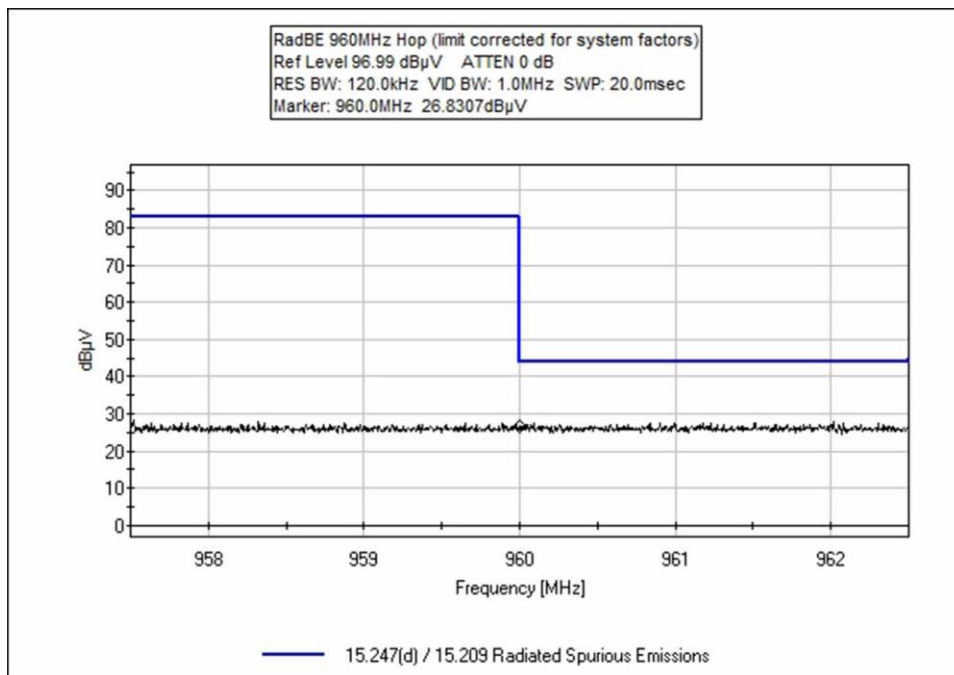
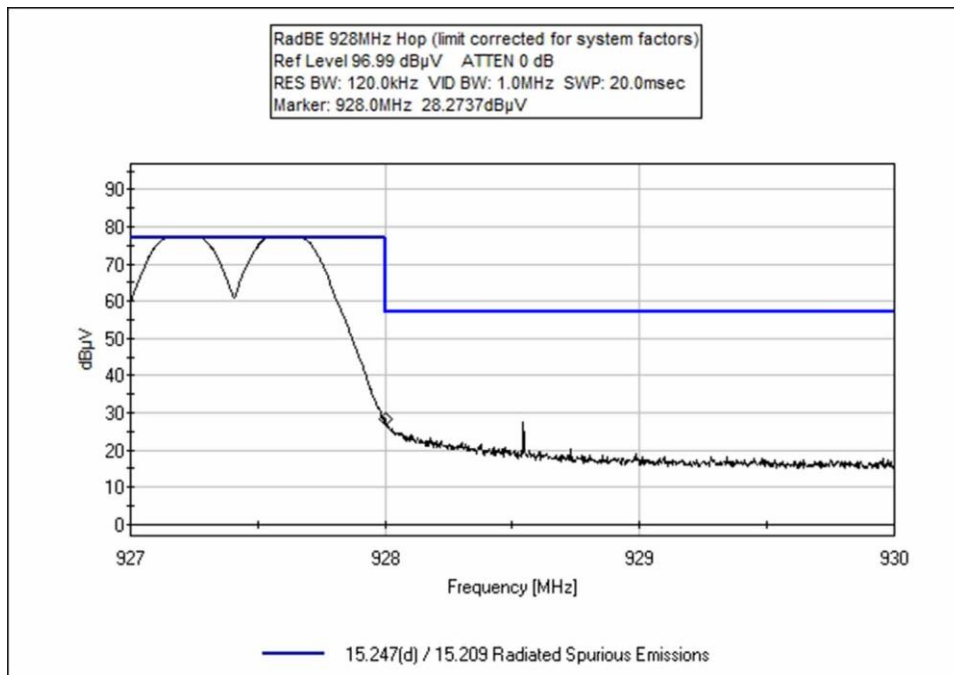

Test Setup / Conditions / Data

Test Location: CKC Laboratories, Inc. • 22116 23rd Drive SE, Suite A • Bothell, WA 98021 • 1-800-500-4EMC (4362)
 Customer: **Nalloy, LLC**
 Specification: **15.247(d) / 15.209 Radiated Spurious Emissions**
 Work Order #: **108788** Date: 10/16/2023
 Test Type: **Maximized Emissions** Time: 16:08:28
 Tested By: Michael Atkinson Sequence#: 1
 Software: EMITest 5.03.20

Equipment Tested:

Device	Manufacturer	Model #	S/N
Configuration 1			

Support Equipment:

Device	Manufacturer	Model #	S/N
Configuration 1			

Test Conditions / Notes:

Test Environment Conditions:
 Temperature: 22°C
 Humidity: 56%
 Pressure: 100.9kPa

 Test Method: ANSI C63.10 (2013)

 Frequency Range: Band Edge

 Test Setup:
 Halcyon
 Low Channel (0) 902.4 MHz, High (63) 927.6MHz
 GFSK-2
 100% Duty Cycle

 PWR Level Setting: 140
 PWR Output: 14dBm

Single channel mode

 X, Y, Z EUT orientations investigated, each with straight and bent antenna orientations investigated, worst case reported. Horizontal and Vertical antenna polarities investigated, worst case reported.

Test Equipment:

ID	Asset #	Description	Model	Calibration Date	Cal Due Date
	AN02673	Spectrum Analyzer	E4446A	3/2/2023	3/2/2025
T1	ANP05546	Cable	Heliac	8/1/2023	8/1/2025
T2	ANP05333	Cable	Heliac	8/8/2023	8/8/2025
T3	ANP05360	Cable	RG214	8/8/2023	8/8/2025
T4	AN03824	Biconilog Antenna	3142E	5/9/2023	5/9/2025
T5	AN02307	Preamp	8447D	8/9/2023	8/9/2025
T6	ANP08072	Band Reject Filter	BRC50722	10/3/2023	10/3/2025

Measurement Data:

Reading listed by margin.

Test Distance: 3 Meters

#	Freq MHz	Rdng dB μ V	T1 T5 dB	T2 T6 dB	T3 dB	T4 dB	Dist Table	Corr dB μ V/m	Spec dB μ V/m	Margin dB	Polar Ant
1	614.000M	25.0	+0.5 -27.9	+1.2 +0.4	+2.3	+27.4	+0.0	28.9	46.0	-17.1	Vert
2	960.000M	25.3	+0.7 -26.9	+1.6 +0.8	+2.6	+31.1	+0.0	35.2	54.0	-18.8	Vert
3	902.000M	30.6	+0.6 +0.0	+1.5 +0.0	+2.5	+29.5	+0.0	64.7	93.0	-28.3	Vert
4	928.000M	26.0	+0.7 +0.0	+1.5 +0.0	+2.6	+31.2	+0.0	62.0	93.0	-31.0	Vert

Test Location: CKC Laboratories, Inc. • 22116 23rd Drive SE, Suite A • Bothell, WA 98021 • 1-800-500-4EMC (4362)
 Customer: **Nalloy, LLC**
 Specification: **15.247(d) / 15.209 Radiated Spurious Emissions**
 Work Order #: **108788** Date: 10/17/2023
 Test Type: **Maximized Emissions** Time: 10:25:33
 Tested By: Michael Atkinson Sequence#: 1
 Software: EMITest 5.03.20

Equipment Tested:

Device	Manufacturer	Model #	S/N
Configuration 1			

Support Equipment:

Device	Manufacturer	Model #	S/N
Configuration 1			

Test Conditions / Notes:

Test Environment Conditions:
 Temperature: 22°C
 Humidity: 56%
 Pressure: 100.9kPa

Test Method: ANSI C63.10 (2013)

Frequency Range: Band Edge

Test Setup:
 Halcyon
 Low Channel (0) 902.4 MHz, High (63) 927.6MHz
 GFSK-2
 100% Duty Cycle

PWR Level Setting: 140
 PWR Output: 14dBm

Hopping Mode

X, Y, Z EUT orientations investigated, each with straight and bent antenna orientations investigated, worst case reported. Horizontal and Vertical antenna polarities investigated, worst case reported.

Test Equipment:

ID	Asset #	Description	Model	Calibration Date	Cal Due Date
	AN02673	Spectrum Analyzer	E4446A	3/2/2023	3/2/2025
T1	ANP05546	Cable	Heliac	8/1/2023	8/1/2025
T2	ANP05333	Cable	Heliac	8/8/2023	8/8/2025
T3	ANP05360	Cable	RG214	8/8/2023	8/8/2025
T4	AN03824	Biconilog Antenna	3142E	5/9/2023	5/9/2025
T5	AN02307	Preamp	8447D	8/9/2023	8/9/2025
T6	ANP08072	Band Reject Filter	BRC50722	10/3/2023	10/3/2025

Measurement Data:

Reading listed by margin.

Test Distance: 3 Meters

#	Freq MHz	Rdng dB μ V	T1 T5 dB	T2 T6 dB	T3 dB	T4 dB	Dist Table	Corr dB μ V/m	Spec dB μ V/m	Margin dB	Polar Ant
1	614.000M	26.3	+0.5 -27.9	+1.2 +0.4	+2.3	+27.4	+0.0	30.2	46.0	-15.8	Vert
2	960.000M	26.8	+0.7 -26.9	+1.6 +0.8	+2.6	+31.1	+0.0	36.7	54.0	-17.3	Vert
3	928.000M	28.3	+0.7 +0.0	+1.5 +0.0	+2.6	+31.2	+0.0	64.3	93.0	-28.7	Vert
4	902.000M	27.8	+0.6 +0.0	+1.5 +0.0	+2.5	+29.5	+0.0	61.9	93.0	-31.1	Vert

15.247 (f) Hybrid Systems Time of Occupancy

Test Setup/Conditions			
Test Location:	Bothell Lab Bench	Test Engineer:	M. Harrison
Test Method:	ANSI C63.10 (2013)	Test Date(s):	11/2/23
Configuration:	5		
Test Setup:	The EUT is continuously transmitting being controlled through support laptop. Normal operation firmware is used for the time of occupancy measurement with a near field probe.		

Environmental Conditions			
Temperature (°C)	20-22	Relative Humidity (%):	38-55

Test Equipment					
Asset#	Description	Manufacturer	Model	Cal Date	Cal Due
03803	Spectrum Analyzer	Agilent	E4440A	2/23/2022	2/23/2024
P07226	Attenuator	Pasternack	PE7004-6	8/25/2023	8/25/2025
P07610	Cable	Andrews	Heliac	4/19/2023	4/19/2025
02673	Spectrum Analyzer	Agilent	E4446A	3/2/2023	3/2/2025

Test Data Summary				
Observation Period, P _{obs} is derived from the following: $P_{obs} = (\text{number of hopping frequencies}) * 0.4$				
Antenna Port	Operational Mode	Measured (ms)	Limit (ms/P _{obs})	Results
1	Transmitting	4.2	≤400	Pass

Measured results are calculated as follows:

$$Dwell\ time = \left(\sum_{Bursts} RF\ Burst\ On\ Time + \sum_{Control} Control\ Signal\ On\ time \right) \Bigg|_{P_{obs}}$$

Actual Calculated Values:

Parameter	Value
Observation Period (P _{obs}):	25.6s
Number of RF Bursts / P _{obs} :	1
On time of RF Burst:	4.2ms
Number of Control or other signals / P _{obs} :	0
On time of Control or other Signals:	0
Total Measured on Time:	4.2ms

Plot(s)

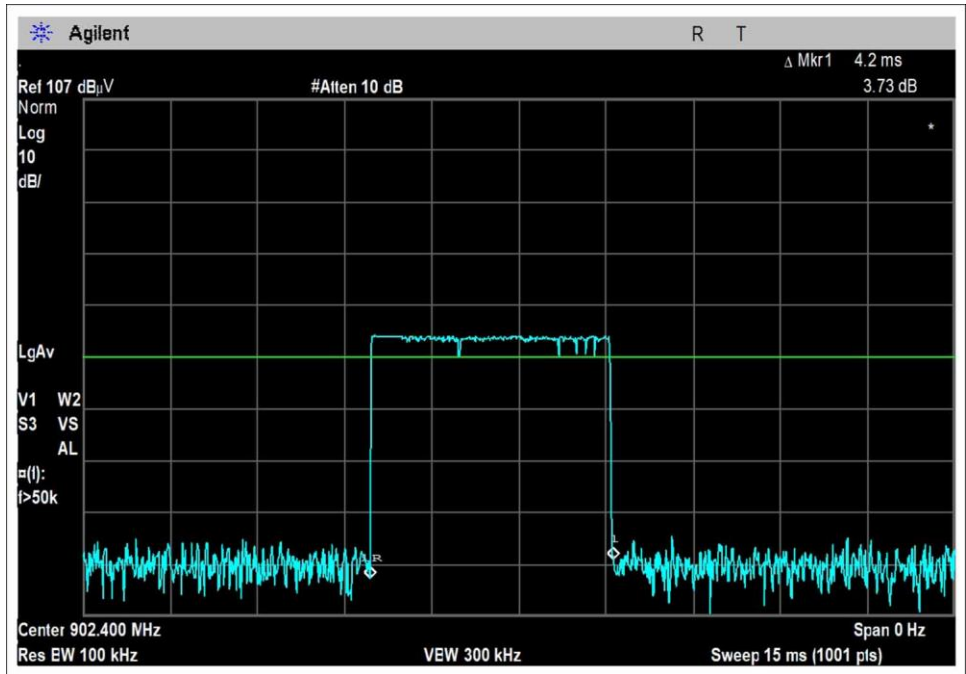

Pulse Width 4.2ms

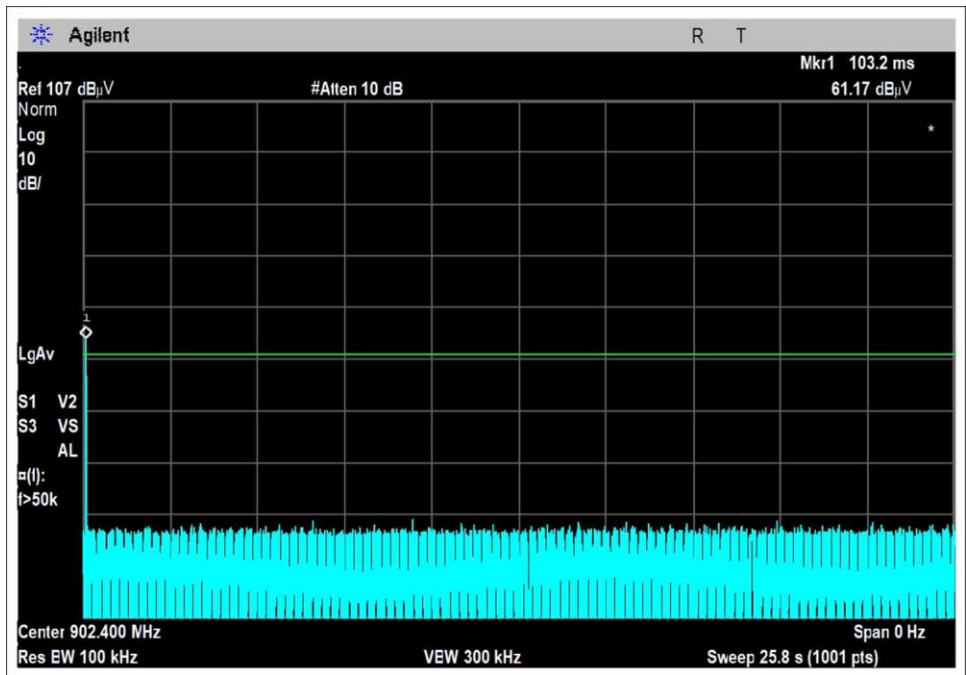

Pulses in 25.6s

15.247 (f) Hybrid Systems Power Spectral Density

Test Setup/Conditions			
Test Location:	Brea Lab Bench	Test Engineer:	M. Atkinson
Test Method:	ANSI C63.10 (2013)	Test Date(s):	10/23/23
Configuration:	1		
Test Setup:	EUT is directly connected to spectrum analyzer with appropriate attenuation and cables. The EUT is continuously transmitting being controlled through support laptop. The correction factor for the system has been loaded into the spectrum analyzer.		

Environmental Conditions			
Temperature (°C)	21	Relative Humidity (%):	55

Test Equipment					
Asset#	Description	Manufacturer	Model	Cal Date	Cal Due
03803	Spectrum Analyzer	Agilent	E4440A	2/23/2022	2/23/2024
P07226	Attenuator	Pasternack	PE7004-6	8/25/2023	8/25/2025
P07610	Cable	Andrews	Heliac	4/19/2023	4/19/2025

Power Spectral Density

Test Data Summary - RF Conducted Measurement				
Measurement Method: PKPSD				
Frequency (MHz)	Modulation	Measured (dBm/3kHz)	Limit (dBm/3kHz)	Results
902.4	GFSK-2	6.34	≤8	Pass
914.8	GFSK-2	6.18	≤8	Pass
927.6	GFSK-2	6.12	≤8	Pass

Plot(s)

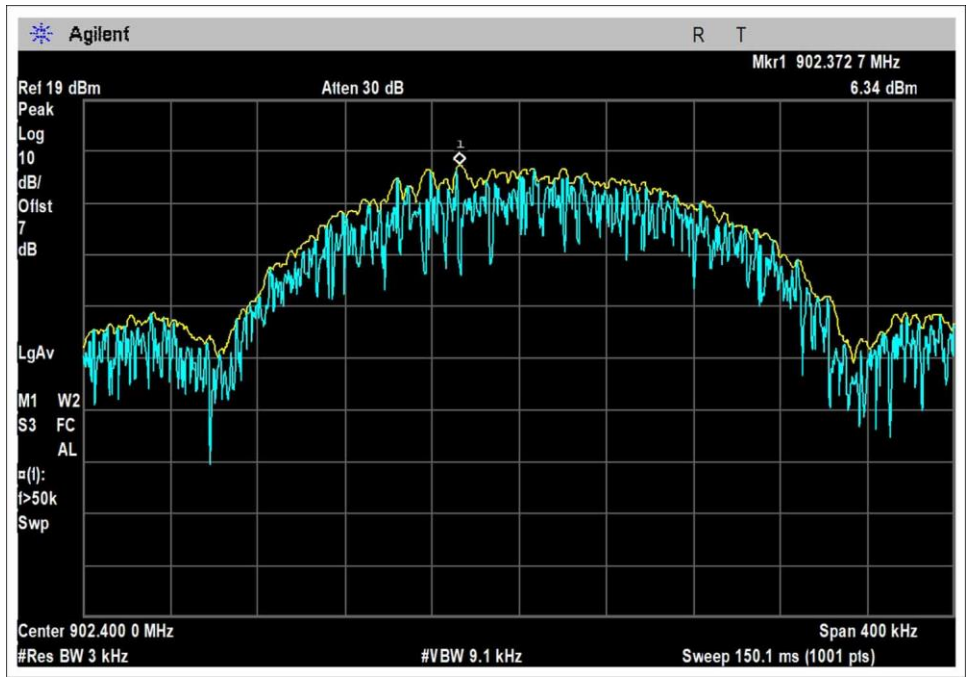

Low Channel

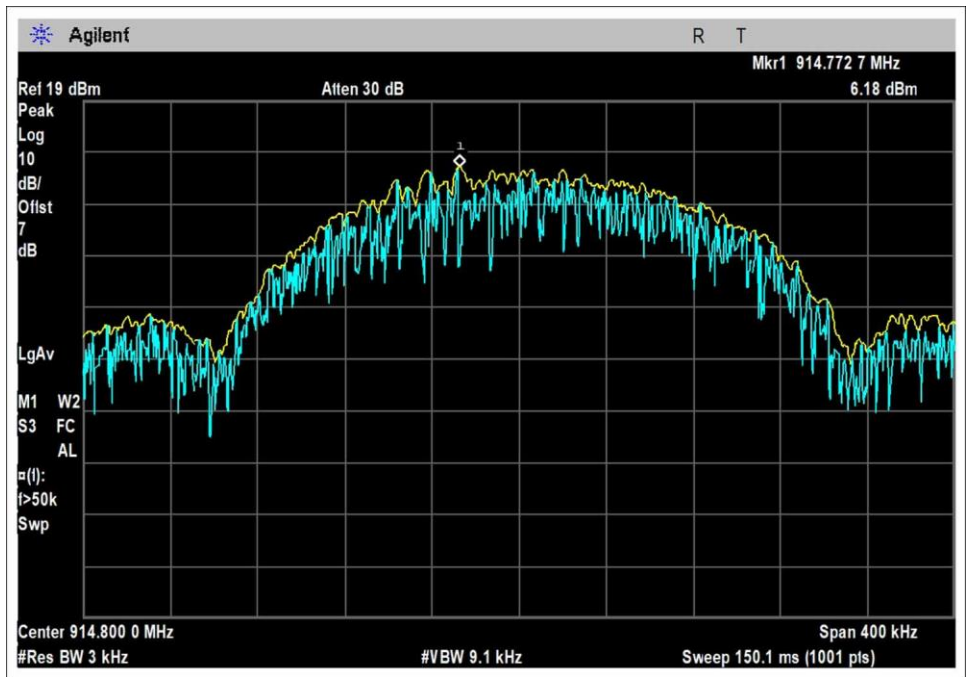

Middle Channel

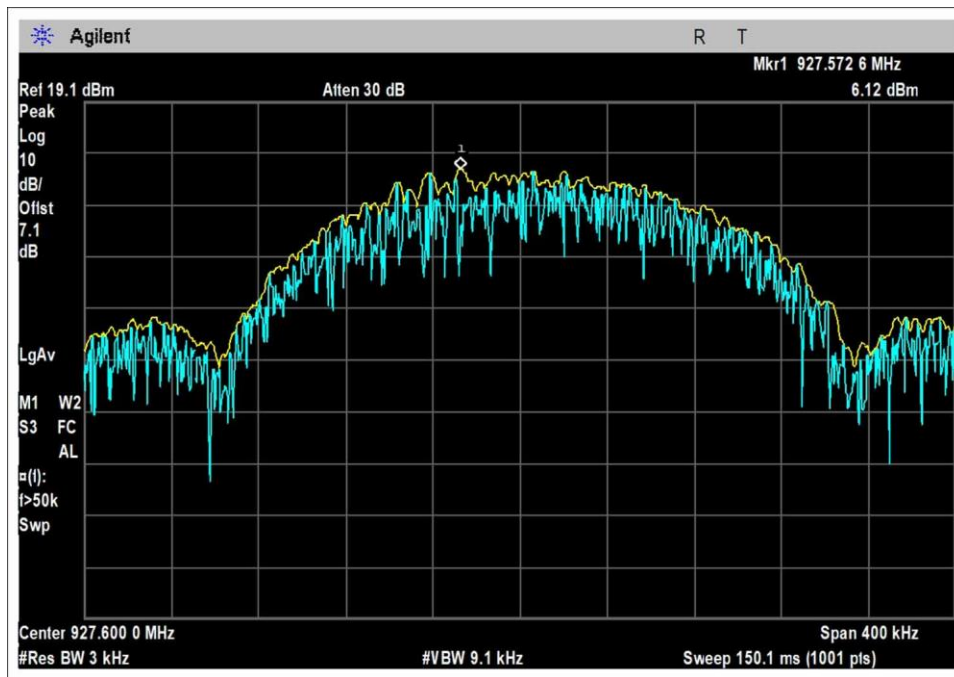

High Channel

15.207 AC Conducted Emissions

Test Setup / Conditions / Data

Test Location: CKC Laboratories, Inc. • 22116 23rd Drive SE, Suite A • Bothell, WA 98021 • 1-800-500-4EMC (4362)
 Customer: **Nalloy, LLC**
 Specification: **15.207 AC Mains - Average**
 Work Order #: **108788** Date: 10/19/2023
 Test Type: **Conducted Emissions** Time: 14:54:43
 Tested By: Michael Atkinson Sequence#: 17
 Software: EMITest 5.03.20 120V 60Hz

Equipment Tested:

Device	Manufacturer	Model #	S/N
Configuration 2			

Support Equipment:

Device	Manufacturer	Model #	S/N
Configuration 2			

Test Conditions / Notes:

Test Environment Conditions:
 Temperature: 22°C
 Humidity: 50%
 Pressure: 101.6kPa

 Test Method: ANSI C63.10 (2013)

 Frequency Range: 0.15-30MHz

 Test Setup:
 Powered by host device via USB, the host device is powered by a PoE injector connected to AC mains. Tx on low, mid, high channels investigated, worst case reported.

Measurement Data:

Reading listed by margin.

Test Lead: Line

#	Freq MHz	Rdng dB μ V	T1 T5 dB	T2 dB	T3 dB	T4 dB	Dist Table	Corr dB μ V	Spec dB μ V	Margin dB	Polar Ant
1	28.189M	30.3	+0.1 +0.0	+0.1	+0.3	+9.1	+0.0	39.9	50.0	-10.1	Line
2	286.989k Ave	31.2	+0.0 +0.1	+0.0	+0.0	+9.1	+0.0	40.4	50.6	-10.2	Line
^	289.509k	35.2	+0.0 +0.1	+0.0	+0.0	+9.1	+0.0	44.4	50.5	-6.1	Line
4	26.607M	30.1	+0.1 +0.0	+0.1	+0.3	+9.1	+0.0	39.7	50.0	-10.3	Line
5	9.533M	30.1	+0.0 +0.2	+0.1	+0.1	+9.1	+0.0	39.6	50.0	-10.4	Line
6	26.490M	29.9	+0.1 +0.0	+0.1	+0.3	+9.1	+0.0	39.5	50.0	-10.5	Line
7	27.160M	29.7	+0.1 +0.0	+0.1	+0.3	+9.1	+0.0	39.3	50.0	-10.7	Line
8	25.697M	29.6	+0.1 +0.0	+0.1	+0.3	+9.1	+0.0	39.2	50.0	-10.8	Line
9	28.535M	29.5	+0.1 +0.0	+0.1	+0.3	+9.1	+0.0	39.1	50.0	-10.9	Line
10	25.877M	29.5	+0.1 +0.0	+0.1	+0.3	+9.1	+0.0	39.1	50.0	-10.9	Line
11	28.738M	29.3	+0.1 +0.0	+0.1	+0.3	+9.1	+0.0	38.9	50.0	-11.1	Line
12	8.755M	29.4	+0.0 +0.2	+0.1	+0.1	+9.1	+0.0	38.9	50.0	-11.1	Line
13	28.944M	29.2	+0.1 +0.0	+0.1	+0.3	+9.1	+0.0	38.8	50.0	-11.2	Line
14	277.404k	30.5	+0.0 +0.1	+0.0	+0.0	+9.1	+0.0	39.7	50.9	-11.2	Line
15	24.346M	29.0	+0.1 +0.0	+0.1	+0.3	+9.1	+0.0	38.6	50.0	-11.4	Line
16	26.544M	28.9	+0.1 +0.0	+0.1	+0.3	+9.1	+0.0	38.5	50.0	-11.5	Line

Test Location: CKC Laboratories, Inc. • 22116 23rd Drive SE, Suite A • Bothell, WA 98021 • 1-800-500-4EMC (4362)
 Customer: **Nalloy, LLC**
 Specification: **15.207 AC Mains - Average**
 Work Order #: **108788** Date: 10/19/2023
 Test Type: **Conducted Emissions** Time: 14:57:30
 Tested By: Michael Atkinson Sequence#: 18
 Software: EMITest 5.03.20 120V 60Hz

Equipment Tested:

Device	Manufacturer	Model #	S/N
Configuration 2			

Support Equipment:

Device	Manufacturer	Model #	S/N
Configuration 2			

Test Conditions / Notes:

Test Environment Conditions:
 Temperature: 22°C
 Humidity: 50%
 Pressure: 101.6kPa

Test Method: ANSI C63.10 (2013)

Frequency Range: 0.15-30MHz

Test Setup:
 Powered by host device via USB, the host device is powered by a PoE injector connected to AC mains. Tx on low, mid, high channels investigated, worst case reported.

Nalloy, LLC WO#: 108788 Sequence#: 18 Date: 10/19/2023
 15.207 AC Mains - Average Test Lead: 120V 60Hz Neutral

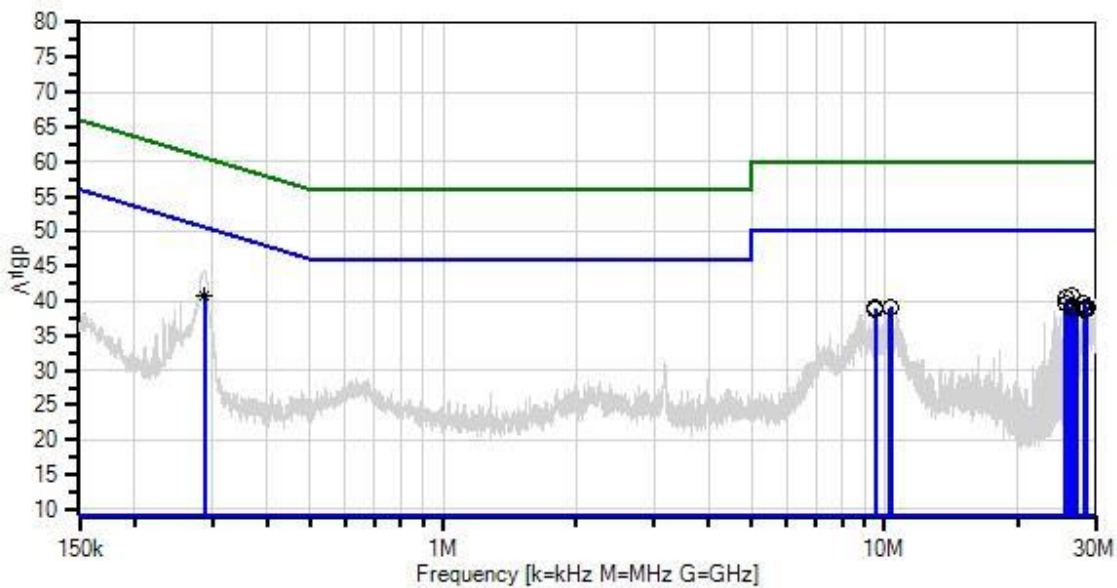

— Sweep Data
 × QP Readings
 Software Version: 5.03.20

— Readings
 * Average Readings
 — 1 - 15.207 AC Mains - Average

○ Peak Readings
 ▼ Ambient
 — 2 - 15.207 AC Mains - Quasi-peak

Test Equipment:

ID	Asset #	Description	Model	Calibration Date	Cal Due Date
	AN02673	Spectrum Analyzer	E4446A	3/2/2023	3/2/2025
T1	AN02611	High Pass Filter	HE9615-150K-50-720B	1/5/2022	1/5/2024
T2	ANP05546	Cable	Heliac	8/1/2023	8/1/2025
T3	ANP06515	Cable	Heliac	3/1/2023	3/1/2025
T4	ANP06219	Attenuator	768-10	3/23/2022	3/23/2024
	AN01311	50uH LISN-Line1 (L)	3816/2	2/23/2022	2/23/2024
T5	AN01311	50uH LISN-Line2 (N)	3816/2	2/23/2022	2/23/2024

Measurement Data: Reading listed by margin. Test Lead: Neutral

#	Freq MHz	Rdng dB μ V	T1 T5 dB	T2 dB	T3 dB	T4 dB	Dist Table	Corr dB μ V	Spec dB μ V	Margin dB	Polar Ant
1	26.607M	31.0	+0.1 +0.0	+0.1	+0.3	+9.1	+0.0	40.6	50.0	-9.4	Neutr
2	25.877M	30.8	+0.1 +0.0	+0.1	+0.3	+9.1	+0.0	40.4	50.0	-9.6	Neutr
3	288.500k Ave	31.5	+0.0 +0.1	+0.0	+0.0	+9.1	+0.0	40.7	50.6	-9.9	Neutr
^	288.619k	35.4	+0.0 +0.1	+0.0	+0.0	+9.1	+0.0	44.6	50.6	-6.0	Neutr
5	28.325M	30.1	+0.1 +0.0	+0.1	+0.3	+9.1	+0.0	39.7	50.0	-10.3	Neutr
6	25.688M	30.0	+0.1 +0.0	+0.1	+0.3	+9.1	+0.0	39.6	50.0	-10.4	Neutr
7	27.156M	29.5	+0.1 +0.0	+0.1	+0.3	+9.1	+0.0	39.1	50.0	-10.9	Neutr
8	28.628M	29.5	+0.1 +0.0	+0.1	+0.3	+9.1	+0.0	39.1	50.0	-10.9	Neutr
9	10.329M	29.7	+0.0 +0.1	+0.1	+0.1	+9.1	+0.0	39.1	50.0	-10.9	Neutr
10	26.490M	29.5	+0.1 +0.0	+0.1	+0.3	+9.1	+0.0	39.1	50.0	-10.9	Neutr
11	9.529M	29.6	+0.0 +0.1	+0.1	+0.1	+9.1	+0.0	39.0	50.0	-11.0	Neutr
12	10.273M	29.6	+0.0 +0.1	+0.1	+0.1	+9.1	+0.0	39.0	50.0	-11.0	Neutr
13	28.681M	29.3	+0.1 +0.0	+0.1	+0.3	+9.1	+0.0	38.9	50.0	-11.1	Neutr
14	28.408M	29.2	+0.1 +0.0	+0.1	+0.3	+9.1	+0.0	38.8	50.0	-11.2	Neutr
15	28.229M	29.2	+0.1 +0.0	+0.1	+0.3	+9.1	+0.0	38.8	50.0	-11.2	Neutr
16	9.550M	29.3	+0.0 +0.1	+0.1	+0.1	+9.1	+0.0	38.7	50.0	-11.3	Neutr

SUPPLEMENTAL INFORMATION

Measurement Uncertainty

Uncertainty Value	Parameter
4.73 dB	Radiated Emissions
3.34 dB	Mains Conducted Emissions
3.30 dB	Disturbance Power

Uncertainties reported are worst case for all CKC Laboratories’ sites and represent expanded uncertainties expressed at approximately the 95% confidence level using a coverage factor of k=2. Compliance is deemed to occur provided measurements are below the specified limits.

Emissions Test Details

TESTING PARAMETERS

Unless otherwise indicated, the following configuration parameters are used for equipment setup: The cables were routed consistent with the typical application by varying the configuration of the test sample. Interface cables were connected to the available ports of the test unit. The effect of varying the position of the cables was investigated to find the configuration that produced maximum emissions. Cables were of the type and length specified in the individual requirements. The length of cable that produced maximum emissions was selected.

The equipment under test (EUT) was set up in a manner that represented its normal use, as shown in the setup photographs. Any special conditions required for the EUT to operate normally are identified in the comments that accompany the emissions tables.

The emissions data was taken with a spectrum analyzer or receiver. Incorporating the applicable correction factors for distance, antenna, cable loss and amplifier gain, the data was reduced as shown in the table below. The corrected data was then compared to the applicable emission limits. Preliminary and final measurements were taken in order to ensure that all emissions from the EUT were found and maximized.

CORRECTION FACTORS

The basic spectrum analyzer reading was converted using correction factors as shown in the highest emissions readings in the tables. For radiated emissions in dBµV/m, the spectrum analyzer reading in dBµV was corrected by using the following formula. This reading was then compared to the applicable specification limit. Individual measurements were compared with the displayed limit value in the margin column. The margin was calculated based on subtracting the limit value from the corrected measurement value; a positive margin represents a measurement exceeding the limit, while a negative margin represents a measurement less than the limit.

SAMPLE CALCULATIONS		
	Meter reading	(dBµV)
+	Antenna Factor	(dB/m)
+	Cable Loss	(dB)
-	Distance Correction	(dB)
-	Pre-amplifier Gain	(dB)
=	Corrected Reading	(dBµV/m)

TEST INSTRUMENTATION AND ANALYZER SETTINGS

The test instrumentation and equipment listed were used to collect the emissions data. A spectrum analyzer or receiver was used for all measurements. Unless otherwise specified, the following table shows the measuring equipment bandwidth settings that were used in designated frequency bands. For testing emissions, an appropriate reference level and a vertical scale size of 10 dB per division were used.

MEASURING EQUIPMENT BANDWIDTH SETTINGS PER FREQUENCY RANGE			
TEST	BEGINNING FREQUENCY	ENDING FREQUENCY	BANDWIDTH SETTING
CONDUCTED EMISSIONS	150 kHz	30 MHz	9 kHz
RADIATED EMISSIONS	9 kHz	150 kHz	200 Hz
RADIATED EMISSIONS	150 kHz	30 MHz	9 kHz
RADIATED EMISSIONS	30 MHz	1000 MHz	120 kHz
RADIATED EMISSIONS	1000 MHz	>1 GHz	1 MHz

SPECTRUM ANALYZER/RECEIVER DETECTOR FUNCTIONS

The notes that accompany the measurements contained in the emissions tables indicate the type of detector function used to obtain the given readings. Unless otherwise noted, all readings were made in the "positive peak" detector mode. Whenever a "quasi-peak" or "average" reading was recorded, the measurement was annotated with a "QP" or an "Ave" on the appropriate rows of the data sheets. In cases where quasi-peak or average limits were employed and data exists for multiple measurement types for the same frequency then the peak measurement was retained in the report for reference, however the numbering for the affected row was removed and an arrow or caret ("^") was placed in the far left-hand column indicating that the row above takes precedence for comparison to the limit. The following paragraphs describe in more detail the detector functions and when they were used to obtain the emissions data.

Peak

In this mode, the spectrum analyzer or receiver recorded all emissions at their peak value as the frequency band selected was scanned. By combining this function with another feature called "peak hold," the measurement device had the ability to measure intermittent or low duty cycle transient emission peak levels. In this mode the measuring device made a slow scan across the frequency band selected and measured the peak emission value found at each frequency across the band.

Quasi-Peak

Quasi-peak measurements were taken using the quasi-peak detector when the true peak values exceeded or were within 2 dB of a quasi-peak specification limit. Additional QP measurements may have been taken at the discretion of the operator.

Average

Average measurements were taken using the average detector when the true peak values exceeded or were within 2 dB of an average specification limit. Additional average measurements may have been taken at the discretion of the operator. If the specification or test procedure requires trace averaging, then the averaging was performed using 100 samples or as required by the specification. All other average measurements are performed using video bandwidth averaging. To make these measurements, the test engineer reduces the video bandwidth on the measuring device until the modulation of the signal is filtered out. At this point the measuring device is set into the linear mode and the scan time is reduced.