



Test Report No.: W7L-P23100014RF09



VARIANT FCC TEST REPORT (PART 90)

Applicant:	Nokia of America Corp
Address:	3201, Olympus Blvd, Dallas, TX 75019, USA

Manufacturer or Supplier	Nokia of America Corp
Address	3201, Olympus Blvd, Dallas, TX 75019, USA
Product	Nokia Industrial 5G handheld HHRA501x
Brand Name	Nokia
Model Name	HHRA501a
Marketing Name:	Nokia Industrial 5G handheld HHRA501a
FCC ID	2AVO2-HHRA501A
Date of tests	Nov. 24, 2022 ~ Feb. 10, 2023

The tests have been carried out according to the requirements of the following standard:

- FCC Part 90, Subpart R, S ANSI/TIA/EIA-603- D
- FCC Part 2 ANSI/TIA/EIA-603-E ANSI C63.26-2015

CONCLUSION: The submitted sample was found to COMPLY with the test requirement

Prepared by Simon Wang Engineer / Mobile Department	Approved by Luke Lu Manager / Mobile Department
Date: Oct. 23, 2023	Date: Oct. 23, 2023

This report is governed by, and incorporates by reference, the Conditions of Testing as posted at the date of issuance of this report at <http://www.bureauveritas.com/home/about-us/our-business/cps/about-us/terms-conditions/> and is intended for your exclusive use. Any copying or replication of this report to or for any other person or entity, or use of our name or trademark, is permitted only with our prior written permission. This report sets forth our findings solely with respect to the test samples identified herein. The results set forth in this report are not indicative or representative of the quality or characteristics of the lot from which a test sample was taken or any similar or identical product unless specifically and expressly noted. Our report includes all of the tests requested by you and the results thereof based upon the information that you provided to us. Measurement uncertainty is only provided upon request for accredited tests. Statements of conformity are based on simple acceptance criteria without taking measurement uncertainty into account, unless otherwise requested in writing. You have 60 days from date of issuance of this report to notify us of any material error or omission caused by our negligence or if you require measurement uncertainty; provided, however, that such notice shall be in writing and shall specifically address the issue you wish to raise. A failure to raise such issue within the prescribed time shall constitute your unqualified acceptance of the completeness of this report, the tests conducted and the correctness of the report contents.



TABLE OF CONTENTS

RELEASE CONTROL RECORD	4
1 SUMMARY OF TEST RESULTS	5
1.1 MEASUREMENT UNCERTAINTY	5
1.2 TEST SITE AND INSTRUMENTS	6
2 GENERAL INFORMATION.....	7
2.1 GENERAL DESCRIPTION OF EUT.....	7
2.2 CONFIGURATION OF SYSTEM UNDER TEST	10
2.3 DESCRIPTION OF SUPPORT UNITS	11
2.4 DESCRIPTION OF TEST MODES.....	11
2.5 GENERAL DESCRIPTION OF APPLIED STANDARDS.....	14
3 TEST TYPES AND RESULTS	15
3.1 OUTPUT POWER MEASUREMENT	15
3.1.1 LIMITS OF OUTPUT POWER MEASUREMENT	15
3.1.2 TEST PROCEDURES	15
3.1.3 TEST SETUP.....	16
3.1.4 TEST RESULTS	16
3.2 FREQUENCY STABILITY MEASUREMENT	28
3.2.1 LIMITS OF FREQUENCY STABILITY MEASUREMENT	28
3.2.2 TEST PROCEDURE	28
3.2.3 TEST SETUP.....	28
3.2.4 TEST RESULTS	29
3.3 OCCUPIED BANDWIDTH MEASUREMENT	30
3.3.1 LIMITS OF OCCUPIED BANDWIDTH MEASUREMENT	30
3.3.2 TEST SETUP.....	30
3.3.3 TEST PROCEDURES	30
3.3.4 TEST RESULTS	31
3.4 EMISSION MASK MEASUREMENT.....	32
3.4.1 LIMITS OF EMISSION MASK MEASUREMENT	32
3.4.2 TEST SETUP.....	32
3.4.3 TEST PROCEDURES	33
3.4.4 TEST RESULTS	34
3.5 CONDUCTED SPURIOUS EMISSIONS.....	35
3.5.1 LIMITS OF CONDUCTED SPURIOUS EMISSIONS MEASUREMENT	35
3.5.2 TEST PROCEDURE.....	35
3.5.3 TEST SETUP.....	35
3.5.4 TEST RESULTS	36
3.6 RADIATED EMISSION MEASUREMENT.....	37
3.6.1 LIMITS OF RADIATED EMISSION MEASUREMENT	37
3.6.2 TEST PROCEDURES	37
3.6.3 DEVIATION FROM TEST STANDARD	37
3.6.4 TEST SETUP.....	38
3.6.5 TEST RESULTS	40
3.7 PEAK TO AVERAGE RATIO	62
3.7.1 LIMITS OF PEAK TO AVERAGE RATIO MEASUREMENT.....	62
3.7.2 TEST SETUP.....	62
3.7.3 TEST PROCEDURES	62
3.7.4 TEST RESULTS	63



**BUREAU
VERITAS**

Test Report No.: W7L-P23100014RF09

4	INFORMATION ON THE TESTING LABORATORIES	64
5	MODIFICATIONS RECORDERS FOR ENGINEERING CHANGES TO THE EUT BY THE LAB	65
6	APPENDIX	66
	LTE BAND14	66
	LTE BAND26	118



Test Report No.: W7L-P23100014RF09

RELEASE CONTROL RECORD

ISSUE NO.	REASON FOR CHANGE	DATE ISSUED
W7L-P22110036RF09	Original release	Feb. 03, 2023
W7L-P23100014RF09	Based on the original product changing the model name and FCC ID, brand name, marketing name, product name, battery model, applicant and manufacturer information.	Oct. 23, 2023



1 SUMMARY OF TEST RESULTS

The EUT has been tested according to the following specifications:

APPLIED STANDARD: FCC Part 90 & Part 2		
STANDARD SECTION	TEST TYPE AND LIMIT	RESULT
§2.1046 §90.635(b)	Conducted Output Power	PASS
§2.1055 §90.213	Frequency Stability	PASS
§2.1049 §90.209	Occupied Bandwidth	PASS
§2.1051 §90.691	Emission Masks	PASS
§2.1051 §90.691	Conducted Spurious Emissions	PASS
§2.1053 §90.691	Radiated Spurious Emissions	PASS

1.1 MEASUREMENT UNCERTAINTY

Where relevant, the following measurement uncertainty levels have been estimated for tests performed on the EUT as specified in CISPR 16-4-2:

MEASUREMENT	FREQUENCY	UNCERTAINTY
Conducted emissions	9kHz~30MHz	2.66dB
Radiated emissions	9KHz ~ 30MHz	2.68dB
	30MHz ~ 1GHz	3.26dB
	1GHz ~ 18GHz	4.48dB
	18GHz ~ 40GHz	4.12dB

This uncertainty represents an expanded uncertainty expressed at approximately the 95% confidence level using a coverage factor of k=2.



1.2 TEST SITE AND INSTRUMENTS

Equipment	Manufacturer	Model No.	Serial No.	Last Cal.	Next Cal.
MXE EMI Receiver	KEYSIGHT	N9038A-544	MY54450026	Feb. 21,22	Feb. 20,23
EXA Signal Analyzer	KEYSIGHT	N9010A-544	MY54510355	May.15,22	May.14,23
Loop Antenna	Schwarzbeck	FMZB 1519B	00173	Sep.04,22	Sep.03,23
Bilog Antenna	ETS-LINDGRE N	3143B	00161965	Mar. 06,22	Mar. 05,23
Horn Antenna	ETS-LINDGRE N	3117	00168692	Mar. 06,22	Mar. 05,23
Horn Antenna (18GHz-40GHz)	N/A	QWH-SL-18-40-K- SG/QMS-00361	15433	Aug. 24, 22	Aug. 23, 23
Radio Communication Analyzer	ANRITSU	MT8820C	6201465426	Feb. 15,22	Feb. 14,23
Signal Pre-Amplifier	EMSI	EMC 9135	980249	May.12,22	May.11,23
Signal Pre-Amplifier	EMSI	EMC 012645B	980257	May.12,22	May.11,23
Signal Pre-Amplifier	EMSI	EMC 184045B	980259	Feb. 21,22	Feb.20,23
3m Semi-anechoic Chamber	ETS-LINDGRE N	9m*6m*6m	Euroshieldpn- CT0001143-121 6	May. 19,20	May. 18,23
Test Software	E3	V 9.160323	N/A	N/A	N/A
Test Software	JS1120	3.1.36	N/A	N/A	N/A
10dB Attenuator	JFW/USA	50HF-010-SMA	1505	May. 07,22	May. 06,23
Power Meter	Anritsu	ML2495A	1506002	Feb. 22,22	Feb. 21,23
Power Sensor	Anritsu	MA2411B	1339352	May. 07,22	May. 06,23
Temperature Chamber	ESPEC	SH-242	93000855	May. 12,22	May. 11,23
MXG Analog Microvave Signal Generator	KEYSIGHT	N5183A	MY50143024	Feb. 18,22	Feb. 17,23
Base station R&S CMW500	Rohde&Schwa rz	CMW500	153085	May.12,22	May.11,23
DC Source	Kikusui/JP	PMX18-5A	0000001	Aug. 24,22	Aug. 23,23

- NOTE:**
1. The calibration interval of the above test instruments is 12 months or 36 months and the calibrations are traceable to CEPREI/CHINA, GRGT/CHINA and NIM/CHINA.
 2. The test was performed in 3m Semi-anechoic Chamber and RF Oven Room.
 3. The horn antenna is used only for the measurement of emission frequency above 1GHz if tested.
 4. The FCC Site Registration No. is 525120; The Designation No. is CN1171.



2 GENERAL INFORMATION

2.1 GENERAL DESCRIPTION OF EUT

PRODUCT	Nokia Industrial 5G handheld HHRA501x	
BRAND NAME	Nokia	
MODEL NAME	HHRA501a	
MARKETING NAME	Nokia Industrial 5G handheld HHRA501a	
NOMINAL VOLTAGE	5.0Vdc(adapter or host equipment) 3.7Vdc (Li-ion, battery)	
MODULATION TECHNOLOGY	LTE	QPSK, 16QAM, 64QAM
FREQUENCY RANGE	LTE Band 14 Channel Bandwidth: 5MHz	790.5MHz ~ 795.5MHz
	LTE Band 14 Channel Bandwidth: 10MHz	793MHz
	LTE Band 26 (Channel Bandwidth: 1.4MHz)	814.7MHz ~ 823.3MHz
	LTE Band 26 (Channel Bandwidth: 3MHz)	815.5MHz ~ 822.5MHz
	LTE Band 26 (Channel Bandwidth: 5MHz)	816.5MHz ~ 821.5MHz
	LTE Band 26 (Channel Bandwidth: 10MHz)	819MHz
EMISSION DESIGNATOR	LTE Band 14 Channel Bandwidth: 5MHz	QPSK: 4M50G7D
		16QAM: 4M51W7D
		64QAM: 4M50W7D
	LTE Band 14 Channel Bandwidth: 10MHz	QPSK: 8M99G7D
		16QAM: 8M98W7D
		64QAM: 8M97W7D
	LTE Band 26 (Channel Bandwidth: 1.4MHz)	QPSK: 1M09G7D
		16QAM: 1M09W7D
		64QAM: 1M09W7D
	LTE Band 26 (Channel Bandwidth: 3MHz)	QPSK: 2M70G7D
		16QAM: 2M69W7D
		64QAM: 2M70W7D
LTE Band 26 (Channel Bandwidth: 5MHz)	QPSK: 4M50G7D	
	16QAM: 4M50W7D	
	64QAM: 4M50W7D	
LTE Band 26 (Channel Bandwidth: 10MHz)	QPSK: 8M97G7D	
	16QAM: 8M96W7D	
	64QAM: 8M97W7D	



MAX. EIRP POWER	LTE Band 14 Channel Bandwidth: 5MHz	56.89mW
	LTE Band 14 Channel Bandwidth: 10MHz	57.15mW
	LTE Band 26 (Channel Bandwidth: 1.4MHz)	52.48mW
	LTE Band 26 (Channel Bandwidth: 3MHz)	51.76mW
	LTE Band 26 (Channel Bandwidth: 5MHz)	52.48mW
	LTE Band 26 (Channel Bandwidth: 10MHz)	52.6mW
ANTENNA TYPE	PIFA Antenna	
ANTENNA GAIN	-3 dBi for LTE Band 14/ LTE Band 26	
HW VERSION	V02	
SW VERSION	IS540_ROW_00.00_1_20221017	
I/O PORTS	Refer to user's manual	
DATA CABLE	USB cable1: non-shielded cable, with w/o ferrite core, 1.0 meter USB cable2: non-shielded cable, with w/o ferrite core, 1.0 meter	
EXTREME TEMPERATURE	-10-50 °C	
EXTREME VOLTAGE	3.6V - 4.2V	

NOTE:

- For a more detailed features description, please refer to the manufacturer's specifications or the user's manual.
- The EUT incorporates a SISO function. Physically, the EUT provides one completed transmitter and one receiver.

MODULATION MODE	TX FUNCTION
LTE	1TX/1RX

- For the test results, the EUT had been tested with all conditions. But only the worst case was shown in test report.



Test Report No.: W7L-P23100014RF09

List of Accessory:

ACCESSORIES	BRAND	MANUFACTURER	MODEL	SPECIFICATION
Battery	N/A	FPR Connectivity Technology Inc.	BL440ACP	Capacity : 3.7Vdc, 4400mAh
AC Adapter	N/A	SHENZHEN SHI YINGYUAN POWER SUPPLY TECHNOLOGY CO., LTD.	ICP12-050-2000B	I/P: 100-240Vac, 0.3A, O/P: 5.0Vdc, 2A
USB Cable 1	N/A	Winpower Technology Co., LTD	PROTECTOR 2.0	Signal Line,1.0meter
USB Cable 2	N/A	Winpower Technology Co., LTD	USB2.0	Signal Line,1.0meter

2.2 CONFIGURATION OF SYSTEM UNDER TEST

FOR RADIATION EMISSION TEST

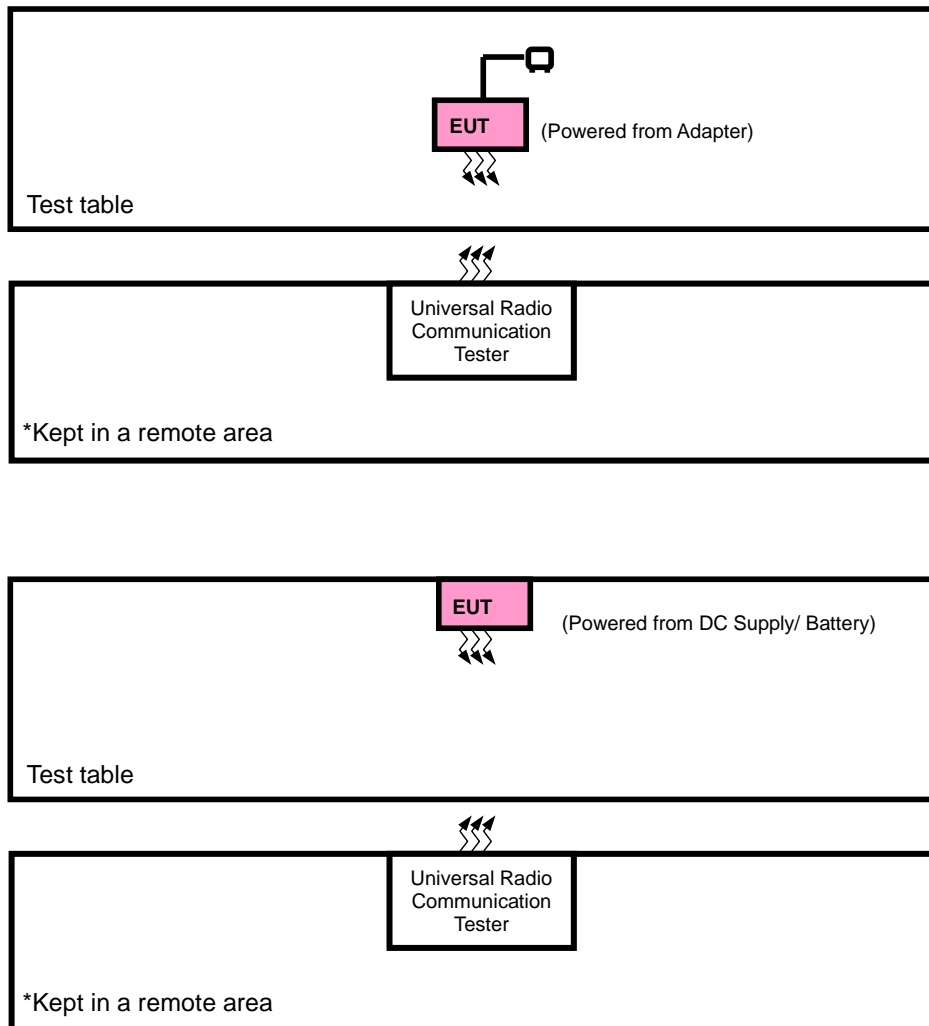



2.3 DESCRIPTION OF SUPPORT UNITS

The EUT has been tested as an independent unit together with other necessary accessories or support units. The following support units or accessories were used to form a representative test configuration during the tests.

NO.	PRODUCT	BRAND	MODEL NO.	SERIAL NO.	FCC ID
1	DC source	LONG WEI	PS-6403D	010934269	N/A

NO.	SIGNAL CABLE DESCRIPTION OF THE ABOVE SUPPORT UNITS
1	DC Line: Unshielded, Detachable 1.8m

2.4 DESCRIPTION OF TEST MODES

Pre-Scan has been conducted to determine the worst-case mode from all possible combinations between available modulations, data rates, XYZ axis and antenna ports. The worst case in ERP/EIRP and radiated emission was found when positioned on X-plane for LTE. Following channel(s) was (were) selected for the final test as listed below:

EUT CONFIGURE MODE	DESCRIPTION
A	EUT + Adapter + USB Cable with LTE link
B	EUT + DC Supply with LTE link



Test Report No.: W7L-P23100014RF09

LTE BAND 14 MODE

EUT CONFIGURE MODE	TEST ITEM	AVAILABLE CHANNEL	TESTED CHANNEL	CHANNEL BANDWIDTH	MODULATION	MODE
A	ERP	23305 to 23355	23305, 23330, 23355	5MHz	QPSK,16QAM,64QAM	1 RB / 0 RB Offset
		23330	23330	10MHz	QPSK,16QAM,64QAM	1 RB / 0 RB Offset
B	FREQUENCY STABILITY	23305 to 23355	23305, 23330, 23355	5MHz	QPSK,16QAM,64QAM	25 RB / 0 RB Offset
		23330	23330	10MHz	QPSK,16QAM,64QAM	50 RB / 0 RB Offset
A	OCCUPIED BANDWIDTH	23305 to 23355	23305, 23330, 23355	5MHz	QPSK,16QAM,64QAM	25 RB / 0 RB Offset
		23330	23330	10MHz	QPSK,16QAM,64QAM	50 RB / 0 RB Offset
A	BAND EDGE	23305 to 23355	23305	5MHz	QPSK,16QAM, 64QAM	1 RB / 0 RB Offset 25 RB / 0 RB Offset
			23355	5MHz	QPSK,16QAM, 64QAM	1 RB / 24 RB Offset 25 RB / 0 RB Offset
		23300	23330	10MHz	QPSK,16QAM, 64QAM	1 RB / 0 RB Offset
						50 RB / 0 RB Offset
						1 RB / 49 RB Offset
		/				
A	CONDUCTED EMISSION	23305 to 23355	23305, 23330, 23355	5MHz	QPSK,16QAM,64QAM	1 RB / 0 RB Offset
		23330	23330	10MHz	QPSK,16QAM,64QAM	1 RB / 0 RB Offset
A	RADIATED EMISSION	23305 to 23355	23305, 23330, 23355	5MHz	QPSK	1 RB / 0 RB Offset
		23330	23330	10MHz	QPSK	1 RB / 0 RB Offset

Note: This device was tested under all bandwidths, RB configurations and modulations. The worst case was found in QPSK modulation.



Test Report No.: W7L-P23100014RF09

LTE BAND 26 MODE

EUT CONFIGURE MODE	TEST ITEM	AVAILABLE CHANNEL	TESTED CHANNEL	CHANNEL BANDWIDTH	MODULATION	MODE		
A	ERP	26697 to 26783	26697, 26740, 26783	1.4MHz	QPSK, 16QAM, 64QAM	1 RB / 0 RB Offset		
		26705 to 26775	26705, 26740, 26775	3MHz	QPSK, 16QAM, 64QAM	1 RB / 0 RB Offset		
		26715 to 26765	26715, 26740, 26765	5MHz	QPSK, 16QAM, 64QAM	1 RB / 0 RB Offset		
		26740	26740	10MHz	QPSK, 16QAM, 64QAM	1 RB / 0 RB Offset		
B	FREQUENCY STABILITY	26697 to 26783	26697, 26740, 26783	1.4MHz	QPSK,16QAM,64QAM	6 RB / 0 RB Offset		
		26705 to 26775	26705, 26740, 26775	3MHz	QPSK,16QAM,64QAM	15 RB / 0 RB Offset		
		26715 to 26765	26715, 26740, 26765	5MHz	QPSK,16QAM,64QAM	25 RB / 0 RB Offset		
		26740	26740	10MHz	QPSK,16QAM,64QAM	50 RB / 0 RB Offset		
A	OCCUPIED BANDWIDTH	26697 to 26783	26697, 26740, 26783	1.4MHz	QPSK, 16QAM, 64QAM	6 RB / 0 RB Offset		
		26705 to 26775	26705, 26740, 26775	3MHz	QPSK, 16QAM, 64QAM	15 RB / 0 RB Offset		
		26715 to 26765	26715, 26740, 26765	5MHz	QPSK, 16QAM, 64QAM	25 RB / 0 RB Offset		
		26740	26740	10MHz	QPSK, 16QAM, 64QAM	50 RB / 0 RB Offset		
A	BAND EDGE	26697 to 26783	26697	1.4MHz	QPSK,16QAM,64QAM	1 RB / 0 RB Offset 6 RB / 0 RB Offset		
			26783	1.4MHz	QPSK,16QAM,64QAM	1 RB / 5 RB Offset 6 RB / 0 RB Offset		
		26705 to 26775	26705	3MHz	QPSK,16QAM,64QAM	1 RB / 0 RB Offset 15 RB / 0 RB Offset		
			26775	3MHz	QPSK,16QAM,64QAM	1 RB / 14 RB Offset 15 RB / 0 RB Offset		
		26715 to 26765	26715	5MHz	QPSK,16QAM,64QAM	1 RB / 0 RB Offset 25 RB / 0 RB Offset		
			26765	5MHz	QPSK,16QAM,64QAM	1 RB / 24 RB Offset 25 RB / 0 RB Offset		
		26740	26740	10MHz	QPSK,16QAM,64QAM	1 RB / 0 RB Offset 50 RB / 0 RB Offset		
			26740	10MHz	QPSK,16QAM,64QAM	1 RB / 49 RB Offset 50 RB / 0 RB Offset		
		A	CONDUCTED EMISSION	26697 to 26783	26697, 26740, 26783	1.4MHz	QPSK,16QAM,64QAM	1 RB / 0 RB Offset
				26705 to 26775	26705, 26740, 26775	3MHz	QPSK,16QAM,64QAM	1 RB / 0 RB Offset
				26715 to 26765	26715, 26740, 26765	5MHz	QPSK,16QAM,64QAM	1 RB / 0 RB Offset
				26740	26740	10MHz	QPSK,16QAM,64QAM	1 RB / 0 RB Offset
A	RADIATED EMISSION	26697 to 26783	26740	1.4MHz	QPSK	1 RB / 0 RB Offset		
		26705 to 26775	26705, 26740, 26775	3MHz	QPSK	1 RB / 0 RB Offset		
		26715 to 26765	26740	5MHz	QPSK	1 RB / 0 RB Offset		
		26740	26740	10MHz	QPSK	1 RB / 0 RB Offset		

Note: This device was tested under all bandwidths, RB configurations and modulations. The worst case was found in QPSK modulation.



TEST CONDITION:

TEST ITEM	ENVIRONMENTAL CONDITIONS	INPUT POWER	TESTED BY
EIRP(ERP)	24deg. C, 60%RH	DC 5V By Adapter	Jace Hu
FREQUENCY STABILITY	24deg. C, 61%RH	DC 3.6V/3.7V/4.2V By DC Supply	James Fu
OCCUPIED BANDWIDTH	24deg. C, 61%RH	DC5V By Adapter	James Fu
BAND EDGE	24deg. C, 61%RH	DC 5V By Adapter	James Fu
CONDUCTED EMISSION	24deg. C, 61%RH	DC5V By Adapter	James Fu
RADIATED EMISSION	23deg. C, 70%RH	DC5V By Adapter	Jace Hu

2.5 GENERAL DESCRIPTION OF APPLIED STANDARDS

The EUT is a RF product. According to the specifications of the manufacturer, it must comply with the requirements of the following standards:

FCC 47 CFR Part 2

FCC 47 CFR Part 90

ANSI/TIA/EIA-603-D

ANSI/TIA/EIA-603-E

ANSI C63.26-2015

NOTE: All test items have been performed and recorded as per the above standards.



3 TEST TYPES AND RESULTS

3.1 OUTPUT POWER MEASUREMENT

3.1.1 LIMITS OF OUTPUT POWER MEASUREMENT

Per FCC Part 90.635(a)(b)

The maximum output power of the transmitter for mobile stations is 100 watts (20 dBw).

3.1.2 TEST PROCEDURES

EIRP / ERP MEASUREMENT:

Per KDB 971168 D01 Power Meas License Digital Systems v03r01 or subclause 5.2.5.5 of ANSI C63.26-2015, the relevant equation for determining the ERP or EIRP from the conducted RF output power measured using the guidance provided above is:

$$\text{ERP or EIRP} = P_{\text{Meas}} + G_{\text{T}} - L_{\text{C}}$$

Where:

ERP or EIRP = effective radiated power or equivalent isotropically radiated power, respectively
(expressed in the same units as P_{Meas} , typically dBW or dBm);

P_{Meas} = measured transmitter output power or PSD, in dBm or dBW;

G_{T} = gain of the transmitting antenna, in dBd (ERP) or dBi (EIRP);

L_{C} = signal attenuation in the connecting cable between the transmitter and antenna, in dB

CONDUCTED POWER MEASUREMENT:

- a. The EUT was set up for the maximum power with LTE link data modulation and link up with simulator.
- b. Set the EUT to transmit under low, middle and high channel and record the power level shown on simulator.



3.1.3 TEST SETUP

CONDUCTED POWER MEASUREMENT:

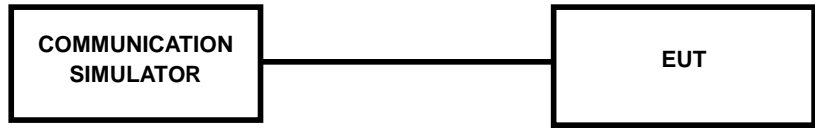

For the actual test configuration, please refer to the attached file (Test Setup Photo).

3.1.4 TEST RESULTS

AVERAGE CONDUCTED OUTPUT POWER (dBm)

LTE Band 14

Band/BW	Modulation	RB Size	RB Offset	Low CH 23305	Mid CH 23330	High CH 23355
				Frequency 790.5 MHz	Frequency 793 MHz	Frequency 795.5 MHz
14/ 5	QPSK	1	0	22.54	22.61	22.57
		1	12	22.68	22.67	22.70
		1	24	22.42	22.46	22.43
		12	0	21.66	21.68	21.71
		12	6	21.76	21.82	21.79
		12	13	21.69	21.63	21.69
		25	0	21.69	21.71	21.69
	16QAM	1	0	22.23	22.27	22.23
		1	12	22.16	22.18	22.21
		1	24	22.08	22.07	22.09
		12	0	20.74	20.76	20.79
		12	6	20.82	20.88	20.84
		12	13	20.66	20.73	20.72
		25	0	20.82	20.81	20.78
	64QAM	1	0	20.45	20.52	20.51
		1	12	20.70	20.69	20.66
		1	24	20.60	20.64	20.63
		12	0	19.76	19.78	19.81
		12	6	19.86	19.92	19.89
		12	13	19.85	19.79	19.85
		25	0	19.72	19.74	19.72



Test Report No.: W7L-P23100014RF09

Band/BW	Modulation	RB Size	RB Offset	/	Mid CH 23330	/
				/	Frequency 793 MHz	/
14/ 10	QPSK	1	0	/	22.62	/
		1	24	/	22.72	/
		1	49	/	22.48	/
		25	0	/	21.73	/
		25	12	/	21.84	/
		25	25	/	21.71	/
		50	0	/	21.77	/
	16QAM	1	0	/	22.29	/
		1	24	/	22.23	/
		1	49	/	22.14	/
		25	0	/	20.81	/
		25	12	/	20.90	/
		25	25	/	20.74	/
		50	0	/	20.86	/
	64QAM	1	0	/	20.53	/
		1	24	/	20.74	/
		1	49	/	20.66	/
		25	0	/	19.83	/
		25	12	/	19.94	/
		25	25	/	19.87	/
		50	0	/	19.80	/



Test Report No.: W7L-P23100014RF09

LTE Band 26

Band/BW	Modulation	RB Size	RB Offset	Low CHG 26697	Mid CH 26740	High CH 26783
				Frequency 814.7 MHz	Frequency 819 MHz	Frequency 823.3 MHz
26/ 1.4	QPSK	1	0	22.23	22.25	22.22
		1	2	22.35	22.34	22.28
		1	5	22.12	22.03	22.07
		3	0	22.18	21.35	21.32
		3	1	22.05	21.21	21.16
		3	3	22.16	21.29	21.27
		6	0	21.32	21.34	21.33
	16QAM	1	0	21.47	21.38	21.37
		1	2	21.74	21.77	21.74
		1	5	21.66	21.60	21.55
		3	0	21.30	20.28	20.26
		3	1	21.20	20.17	20.11
		3	3	21.27	20.24	20.28
		6	0	20.30	20.28	20.22
	64QAM	1	0	20.35	20.29	20.33
		1	2	20.18	20.20	20.17
		1	5	19.96	19.94	19.89
		3	0	20.43	19.40	19.38
		3	1	20.39	19.43	19.42
		3	3	20.38	19.35	19.32
		6	0	19.37	19.39	19.34



Test Report No.: W7L-P23100014RF09

Band/BW	Modulation	RB Size	RB Offset	Low CHG 26705	Mid CH 26740	High CH 26775
				Frequency 815.5 MHz	Frequency 819 MHz	Frequency 822.5 MHz
26/ 3	QPSK	1	0	22.25	22.24	22.21
		1	7	22.29	22.28	22.28
		1	14	22.11	22.07	22.03
		8	0	21.32	21.32	21.33
		8	3	21.22	21.16	21.22
		8	7	21.30	21.27	21.30
		15	0	21.33	21.33	21.33
	16QAM	1	0	21.43	21.37	21.40
		1	7	21.77	21.74	21.78
		1	14	21.68	21.55	21.54
		8	0	20.28	20.26	20.28
		8	3	20.24	20.11	20.17
		8	7	20.33	20.28	20.27
		15	0	20.26	20.22	20.23
	64QAM	1	0	20.42	20.33	20.32
		1	7	20.19	20.17	20.21
		1	14	20.00	19.89	19.95
		8	0	19.42	19.38	19.41
		8	3	19.43	19.42	19.43
		8	7	19.34	19.32	19.35
		15	0	19.39	19.34	19.38



Test Report No.: W7L-P23100014RF09

Band/BW	Modulation	RB Size	RB Offset	Low CHG 26715	Mid CH 26740	High CH 26765
				Frequency 816.5 MHz	Frequency 819 MHz	Frequency 821.5 MHz
26/ 5	QPSK	1	0	22.26	22.23	22.23
		1	12	22.32	22.34	22.35
		1	24	22.09	22.10	22.06
		12	0	21.35	21.33	21.36
		12	6	21.24	21.18	21.18
		12	13	21.31	21.34	21.33
		25	0	21.29	21.30	21.27
	16QAM	1	0	21.49	21.43	21.39
		1	12	21.74	21.75	21.78
		1	24	21.64	21.60	21.57
		12	0	20.29	20.26	20.27
		12	6	20.21	20.13	20.14
		12	13	20.28	20.30	20.30
		25	0	20.24	20.25	20.29
	64QAM	1	0	20.35	20.35	20.32
		1	12	20.20	20.17	20.22
		1	24	19.93	19.94	19.91
		12	0	19.43	19.38	19.44
		12	6	19.39	19.42	19.36
		12	13	19.35	19.32	19.35
		25	0	19.33	19.37	19.38



Test Report No.: W7L-P23100014RF09

Band/BW	Modulation	RB Size	RB Offset	/	Mid CH 26740	/
				/	Frequency 819 MHz	/
26/ 10	QPSK	1	0	/	22.28	/
		1	24	/	22.36	/
		1	49	/	22.11	/
		25	0	/	21.38	/
		25	12	/	21.23	/
		25	25	/	21.35	/
		50	0	/	21.35	/
	16QAM	1	0	/	21.45	/
		1	24	/	21.80	/
		1	49	/	21.62	/
		25	0	/	20.34	/
		25	12	/	20.19	/
		25	25	/	20.32	/
		50	0	/	20.30	/
	64QAM	1	0	/	20.37	/
		1	24	/	20.23	/
		1	49	/	19.96	/
		25	0	/	19.46	/
		25	12	/	19.44	/
		25	25	/	19.40	/
		50	0	/	19.40	/



Test Report No.: W7L-P23100014RF09

ERP

LTE BAND 14

CHANNEL BANDWIDTH: 5MHz QPSK

Channel	Frequency (MHz)	Conducted Power (dBm)	G _{T-Lc} (dB)	ERP (dBm)	ERP (mW)	Limit (W)
23305	790.5	22.68	-3	17.53	56.62	100
23330	793	22.67	-3	17.52	56.49	100
23355	795.5	22.7	-3	17.55	56.89	100

CHANNEL BANDWIDTH: 5MHz 16QAM

Channel	Frequency (MHz)	Conducted Power (dBm)	G _{T-Lc} (dB)	ERP (dBm)	ERP (mW)	Limit (W)
23305	790.5	22.23	-3	17.08	51.05	100
23330	793	22.27	-3	17.12	51.52	100
23355	795.5	22.23	-3	17.08	51.05	100

CHANNEL BANDWIDTH: 5MHz 64QAM

Channel	Frequency (MHz)	Conducted Power (dBm)	G _{T-Lc} (dB)	ERP (dBm)	ERP (mW)	Limit (W)
23305	790.5	20.7	-3	15.55	35.89	100
23330	793	20.69	-3	15.54	35.81	100
23355	795.5	20.66	-3	15.51	35.56	100



Test Report No.: W7L-P23100014RF09

CHANNEL BANDWIDTH: 10MHz QPSK

Channel	Frequency (MHz)	Conducted Power (dBm)	G _T -L _c (dB)	ERP (dBm)	ERP (mW)	Limit (W)
-	-	-	-	-	-	-
23330	793	22.72	-3	17.57	57.15	100
-	-	-	-	-	-	-

CHANNEL BANDWIDTH: 10MHz 16QAM

Channel	Frequency (MHz)	Conducted Power (dBm)	G _T -L _c (dB)	ERP (dBm)	ERP (mW)	Limit (W)
-	-	-	-	-	-	-
23330	793	22.29	-3	17.14	51.76	100
-	-	-	-	-	-	-

CHANNEL BANDWIDTH: 10MHz 64QAM

Channel	Frequency (MHz)	Conducted Power (dBm)	G _T -L _c (dB)	ERP (dBm)	ERP (mW)	Limit (W)
-	-	-	-	-	-	-
23330	793	20.74	-3	15.59	36.22	100
-	-	-	-	-	-	-

REMARKS: ERP Output Power (dBm) = ERP (dBm) -2.15(dB).



LTE BAND 26

CHANNEL BANDWIDTH: 1.4MHz QPSK

Channel	Frequency (MHz)	Conducted Power (dBm)	G _T -L _C (dB)	ERP (dBm)	ERP (mW)	Limit (W)
26697	814.7	22.35	-3	17.2	52.48	100
26740	819	22.34	-3	17.19	52.36	100
26783	823.3	22.28	-3	17.13	51.64	100

REMARKS: ERP Output Power (dBm) = EIRP (dBm) -2.15(dB).

CHANNEL BANDWIDTH: 1.4MHz 16QAM

Channel	Frequency (MHz)	Conducted Power (dBm)	G _T -L _C (dB)	ERP (dBm)	ERP (mW)	Limit (W)
26697	814.7	21.74	-3	16.59	45.6	100
26740	819	21.77	-3	16.62	45.92	100
26783	823.3	21.74	-3	16.59	45.6	100

REMARKS: ERP Output Power (dBm) = EIRP (dBm) -2.15(dB).

CHANNEL BANDWIDTH: 1.4MHz 64QAM

Channel	Frequency (MHz)	Conducted Power (dBm)	G _T -L _C (dB)	ERP (dBm)	ERP (mW)	Limit (W)
26697	814.7	20.43	-3	15.28	33.73	100
26740	819	20.29	-3	15.14	32.66	100
26783	823.3	20.33	-3	15.18	32.96	100

REMARKS: ERP Output Power (dBm) = EIRP (dBm) -2.15(dB).



Test Report No.: W7L-P23100014RF09

LTE BAND 26

CHANNEL BANDWIDTH: 3MHz QPSK

Channel	Frequency (MHz)	Conducted Power (dBm)	G _T -L _C (dB)	ERP (dBm)	ERP (mW)	Limit (W)
26705	815.5	22.29	-3	17.14	51.76	100
26740	819	22.28	-3	17.13	51.64	100
26775	822.5	22.28	-3	17.13	51.64	100

REMARKS: ERP Output Power (dBm) = EIRP (dBm) -2.15(dB).

CHANNEL BANDWIDTH: 3MHz 16QAM

Channel	Frequency (MHz)	Conducted Power (dBm)	G _T -L _C (dB)	ERP (dBm)	ERP (mW)	Limit (W)
26705	815.5	21.77	-3	16.62	45.92	100
26740	819	21.74	-3	16.59	45.6	100
26775	822.5	21.78	-3	16.63	46.03	100

REMARKS: ERP Output Power (dBm) = EIRP (dBm) -2.15(dB).

CHANNEL BANDWIDTH: 3MHz 64QAM

Channel	Frequency (MHz)	Conducted Power (dBm)	G _T -L _C (dB)	ERP (dBm)	ERP (mW)	Limit (W)
26705	815.5	20.42	-3	15.27	33.65	100
26740	819	20.33	-3	15.18	32.96	100
26775	822.5	20.32	-3	15.17	32.89	100

REMARKS: ERP Output Power (dBm) = EIRP (dBm) -2.15(dB).



Test Report No.: W7L-P23100014RF09

LTE BAND 26

CHANNEL BANDWIDTH: 5MHz QPSK

Channel	Frequency (MHz)	Conducted Power (dBm)	G _T -L _C (dB)	ERP (dBm)	ERP (mW)	Limit (W)
26715	816.5	22.32	-3	17.17	52.12	100
26740	819	22.34	-3	17.19	52.36	100
26765	821.5	22.35	-3	17.2	52.48	100

REMARKS: ERP Output Power (dBm) = EIRP (dBm) -2.15(dB).

CHANNEL BANDWIDTH: 5MHz 16QAM

Channel	Frequency (MHz)	Conducted Power (dBm)	G _T -L _C (dB)	ERP (dBm)	ERP (mW)	Limit (W)
26715	816.5	21.74	-3	16.59	45.6	100
26740	819	21.75	-3	16.6	45.71	100
26765	821.5	21.78	-3	16.63	46.03	100

REMARKS: ERP Output Power (dBm) = EIRP (dBm) -2.15(dB).

CHANNEL BANDWIDTH: 5MHz 64QAM

Channel	Frequency (MHz)	Conducted Power (dBm)	G _T -L _C (dB)	ERP (dBm)	ERP (mW)	Limit (W)
26715	816.5	20.35	-3	15.2	33.11	100
26740	819	20.35	-3	15.2	33.11	100
26765	821.5	20.32	-3	15.17	32.89	100

REMARKS: ERP Output Power (dBm) = EIRP (dBm) -2.15(dB).



Test Report No.: W7L-P23100014RF09

LTE BAND 26

CHANNEL BANDWIDTH: 10MHz QPSK

Channel	Frequency (MHz)	Conducted Power (dBm)	G _T -L _C (dB)	ERP (dBm)	ERP (mW)	Limit (W)
-	-	-	-	-	-	-
26740	819	22.36	-3	17.21	52.6	100
-	-	-	-	-	-	-

REMARKS: ERP Output Power (dBm) = EIRP (dBm) -2.15(dB).

CHANNEL BANDWIDTH: 10MHz 16QAM

Channel	Frequency (MHz)	Conducted Power (dBm)	G _T -L _C (dB)	ERP (dBm)	ERP (mW)	Limit (W)
-	-	-	-	-	-	-
26740	819	21.8	-3	16.65	46.24	100
-	-	-	-	-	-	-

REMARKS: ERP Output Power (dBm) = EIRP (dBm) -2.15(dB).

CHANNEL BANDWIDTH: 10MHz 64QAM

Channel	Frequency (MHz)	Conducted Power (dBm)	G _T -L _C (dB)	ERP (dBm)	ERP (mW)	Limit (W)
-	-	-	-	-	-	-
26740	819	20.37	-3	15.22	33.27	100
-	-	-	-	-	-	-

REMARKS: ERP Output Power (dBm) = EIRP (dBm) -2.15(dB).

3.2 FREQUENCY STABILITY MEASUREMENT

3.2.1 LIMITS OF FREQUENCY STABILITY MEASUREMENT

The frequency stability of mobile, portable and control transmitters operating in the wideband segment must be 1.25 parts per million or better when AFC is locked to a base station, and 5 parts per million or better when AFC is not locked

3.2.2 TEST PROCEDURE

- a. Device is placed at the oven room. The oven room could control the temperatures and humidity. Power warm up is at least 15 min and power applied should perform before recording frequency error.
- b. EUT is connected the external power supply to control the DC input power. The test voltage range is from minimum to maximum working voltage. Each step shall be record the frequency error rate.
- c. The temperature range step is 10 degrees in this test items. All temperature levels shall be hold the $\pm 0.5^{\circ}\text{C}$ during the measurement testing. The each temperature step shall be at least 0.5 hours, consider the EUT could be test under the stability condition.

NOTE: The frequency error was recorded frequency error from the communication simulator.

3.2.3 TEST SETUP

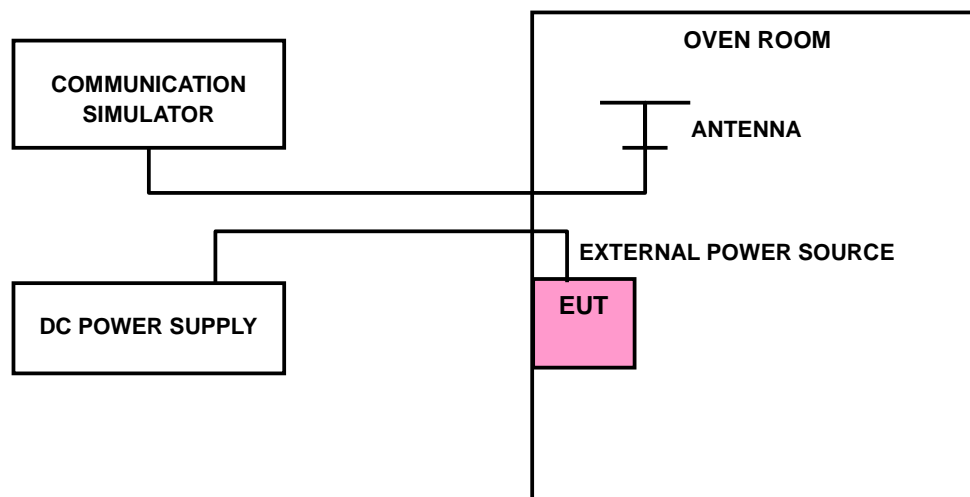



Test Report No.: W7L-P23100014RF09

3.2.4 TEST RESULTS

Please Refer to Appendix Of this test report.

Note: VL = Low voltage(3.6V); VN/NV = Normal voltage(3.7V); VH = High voltage(4.2V);
NT = Normal temperature (25°C)

3.3 OCCUPIED BANDWIDTH MEASUREMENT

3.3.1 LIMITS OF OCCUPIED BANDWIDTH MEASUREMENT

The width of a frequency band such that, below the lower and above the upper frequency limits, the mean powers emitted are each equal to a specified percentage 0.5 %of the total mean power of a given emission.

3.3.2 TEST SETUP

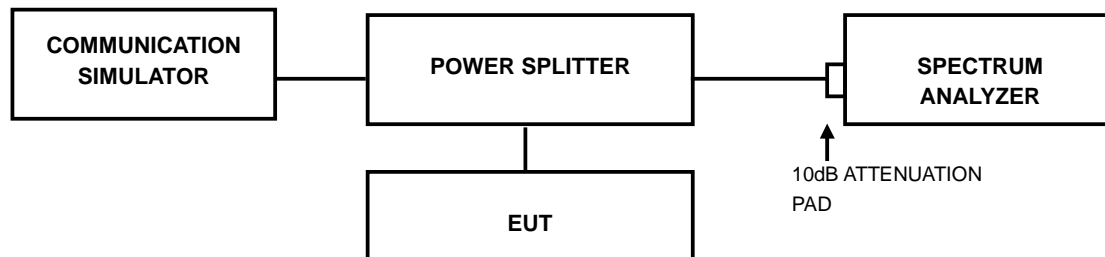

3.3.3 TEST PROCEDURES

- The conducted occupied bandwidth used the power splitter via EUT RF power connector between simulation base station and spectrum analyzer.
- Use OBW measurement function of Spectrum analyzer to measure 99 % occupied bandwidth.



Test Report No.: W7L-P23100014RF09

3.3.4 TEST RESULTS

Please Refer to Appendix Of this test report.

3.4 EMISSION MASK MEASUREMENT

3.4.1 LIMITS OF EMISSION MASK MEASUREMENT

According to FCC part 90.691 shall be tested the emission mask. For any frequency removed from the EA licensee's frequency block by up to and including 37.5 kHz, the power of any emission shall be attenuated below the transmitter power (P) in watts by at least $116 \log_{10}(f/6.1)$ decibels or $50 + 10 \log_{10}(P)$ decibels or 80 decibels, whichever is the lesser attenuation, where f is the frequency removed from the center of the outer channel in the block in kilohertz and where f is greater than 12.5 kHz.

For any frequency removed from the EA licensee's frequency block greater than 37.5 kHz, the power of any emission shall be attenuated below the transmitter power (P) in watts by at least $43 + 10 \log_{10}(P)$ decibels or 80 decibels, whichever is the lesser attenuation, where f is the frequency removed from the center of the outer channel in the block in kilohertz and where f is greater than 37.5 kHz.

3.4.2 TEST SETUP

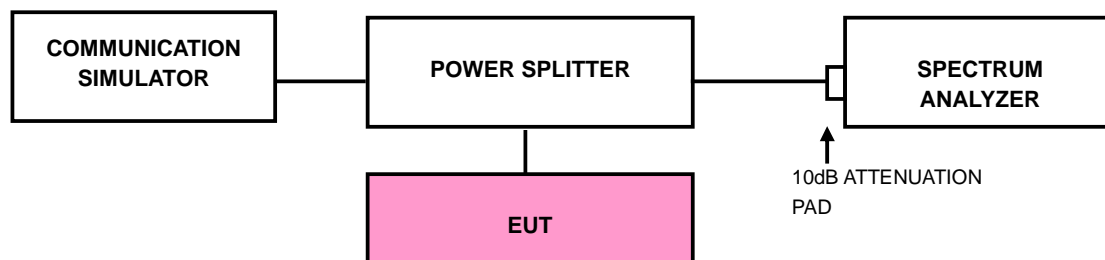



3.4.3 TEST PROCEDURES

- a) Connect the transmitter to the spectrum analyzer via coaxial cable while ensuring proper impedance matching.
- b) Tune the analyzer to the nominal center frequency of the emission bandwidth (EBW).
- c) Set the resolution bandwidth (RBW) $\geq 1\%$ EBW in the 1MHz band immediately outside and adjacent to the band edge.
- d) Beyond the 1MHz band from the band edge, RBW=1MHz was used.
- e) Set the video bandwidth (VBW) to $\geq 3 \times$ RBW.
- f) Select the average power (RMS) display detector.
- g) Set the number of measurement points to ≥ 1001 .
- h) Use auto-coupled sweep time.
- i) Perform the measurement over an interval of time when the transmission is continuous and at its maximum power level.
- j) The RF fundamental frequency should be excluded against the limit line in the operating frequency band and use RBW is 10KHz or 100KHz.
- k) Record the max trace plot into the test report.



Test Report No.: W7L-P23100014RF09

3.4.4 TEST RESULTS

Please Refer to Appendix Of this test report.

3.5 CONDUCTED SPURIOUS EMISSIONS

3.5.1 LIMITS OF CONDUCTED SPURIOUS EMISSIONS MEASUREMENT

The power of any emission outside a licensee's frequency block shall be attenuated below the transmitter power (P) by at least $43 + 10 \log_{10}(P)$ dB. The limit of emission equal to -13dBm

3.5.2 TEST PROCEDURE

- a. The EUT makes a phone call to the communication simulator. All measurements were done at middle operational frequency range.
- b. Measuring frequency range is from 9kHz up to a frequency including its 10th harmonic. 10dB attenuation pad is connected with spectrum. RBW=1MHz and VBW=3MHz is used for conducted emission measurement.

3.5.3 TEST SETUP

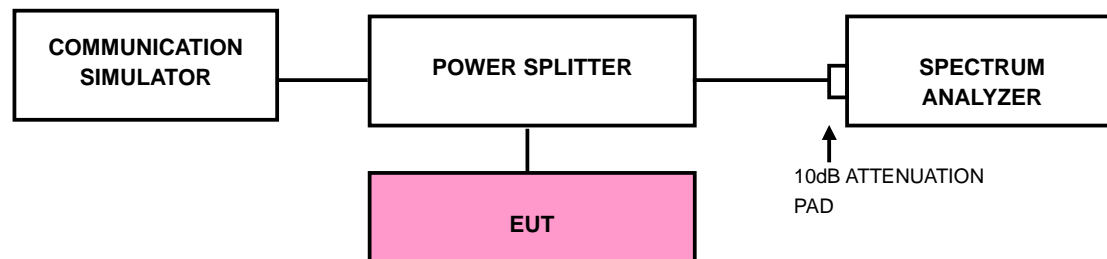



Test Report No.: W7L-P23100014RF09

3.5.4 TEST RESULTS

NOTE : The 9K~30MHz amplitude of spurious emissions attenuated more than 20 dB below the permissible value is not required in the report.

Please Refer to Appendix Of this test report.



3.6 RADIATED EMISSION MEASUREMENT

3.6.1 LIMITS OF RADIATED EMISSION MEASUREMENT

(1) The power of any emission outside a licensee's frequency block shall be attenuated below the transmitter power (P) by at least $43 + 10 \log_{10}(P)$ dB. The limit of emission equal to -13dBm

(2) For operations in the 763–775 MHz and 793–805 MHz bands, all emissions including harmonics in the band 1559–1610 MHz shall be limited to -70 dBW/MHz equivalent isotropically radiated power (EIRP) for wideband signals, and -80 dBW EIRP for discrete emissions of less than 700 Hz bandwidth. For the purpose of equipment authorization, a transmitter shall be tested with an antenna that is representative of the type that will be used with the equipment in normal operation.

3.6.2 TEST PROCEDURES

- a. Substitution method is used for E.I.R.P measurement. In the semi-anechoic chamber, EUT placed on the 0.8m height of Turn Table, rotated the table around 360 degrees to search the maximum radiation power and receiver antenna shall be rotated vertical and horizontal polarization and moved height from 1m to 4m to find the maximum polar radiated power. The “Read Value” is the spectrum reading the maximum power value.
- b. The substitution horn antenna is substituted for EUT at the same position and signals generator export the CW signal to the substitution antenna via a TX cable. Rotated the Turn Table and moved receiving antenna to find the maximum radiation power. Adjust output power level of S.G to get a Value of spectrum reading equal to “Read Value” of step a. Record the power level of S.G
- c. $\text{EIRP} = \text{Output power level of S.G} - \text{TX cable loss} + \text{Antenna gain of substitution horn.}$
- d. E.R.P power can be calculated form E.I.R.P power by subtracting the gain of dipole, $\text{E.R.P power} = \text{E.I.P.R power} - 2.15\text{dBi.}$

NOTE: The resolution bandwidth of spectrum analyzer is 1 MHz and the video bandwidth is 3 MHz.

3.6.3 DEVIATION FROM TEST STANDARD

No deviation

3.6.4 TEST SETUP

<Below 30MHz>

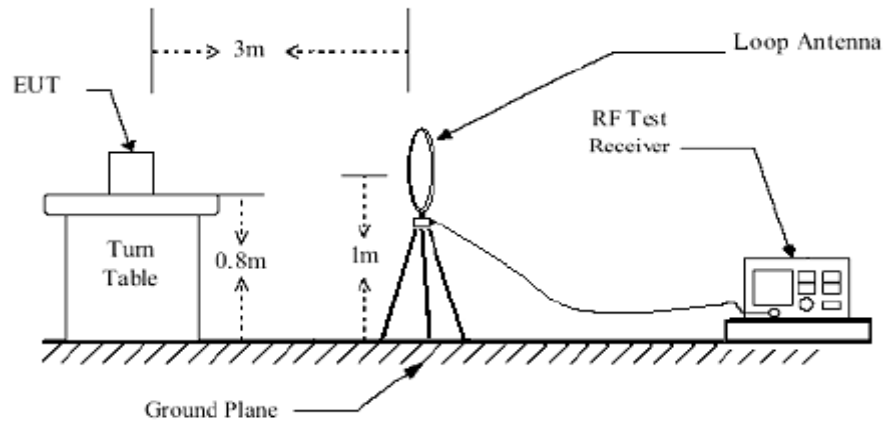

< Frequency Range 30MHz~1GHz >

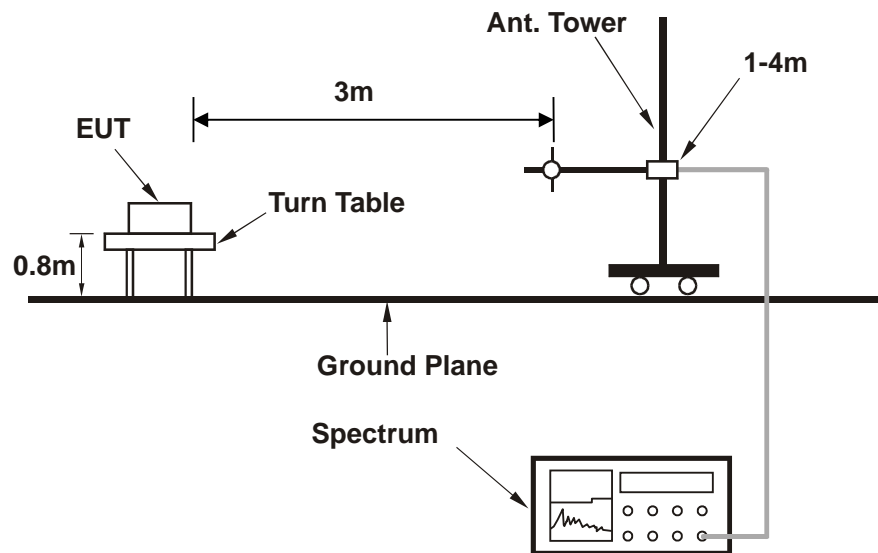

< Frequency Range above 1GHz >

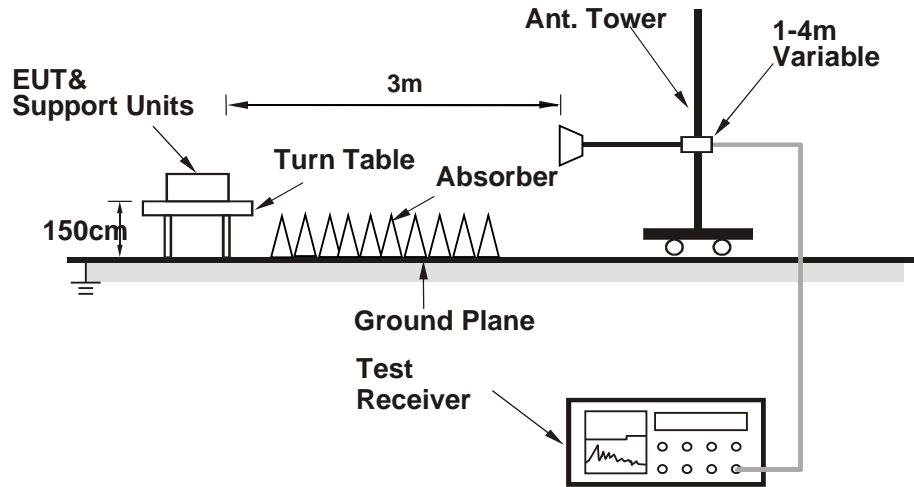

For the actual test configuration, please refer to the attached file (Test Setup Photo).



Test Report No.: W7L-P23100014RF09

3.6.5 TEST RESULTS

NOTE : The 9K~30MHz amplitude of spurious emissions attenuated more than 20 dB below the permissible value is not required in the report.

BELOW 1GHz WORST-CASE DATA

30 MHz – 1GHz data:

LTE Band 14:

CHANNEL BANDWIDTH: 5MHz / QPSK

MODE	TX channel 23305	FREQUENCY RANGE	Below 1000MHz
ENVIRONMENTAL CONDITIONS	23deg. C, 70%RH	INPUT POWER	AC 120V/60HZ
TESTED BY	Jace HU		
ANTENNA POLARITY & TEST DISTANCE: HORIZONTAL AT 3 M			

	Freq	Level	Read Level	Limit Line	Over Limit	Factor	Remark	Pol/Phase
	MHz	dBm/m	dBm	dBm/m	dB	dB/m		
1	57.160	-68.90	-50.64	-13.00	-55.90	-18.26	Peak	Horizontal
2 PP	75.590	-64.94	-43.56	-13.00	-51.94	-21.38	Peak	Horizontal
3	159.980	-68.88	-53.03	-13.00	-55.88	-15.85	Peak	Horizontal
4	202.660	-68.90	-51.79	-13.00	-55.90	-17.11	Peak	Horizontal
5	245.340	-66.16	-54.15	-13.00	-53.16	-12.01	Peak	Horizontal
6	422.850	-70.21	-60.59	-13.00	-57.21	-9.62	Peak	Horizontal

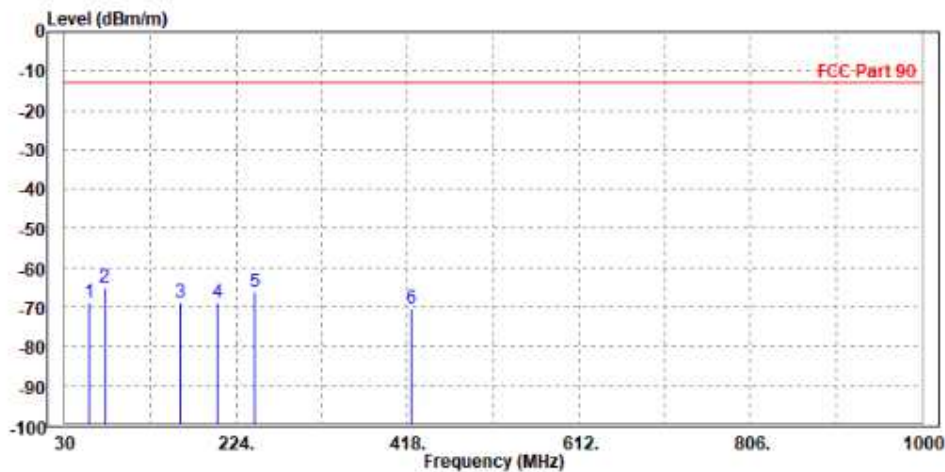



Test Report No.: W7L-P23100014RF09

MODE	TX channel 23305	FREQUENCY RANGE	Below 1000MHz
ENVIRONMENTAL CONDITIONS	23deg. C, 70%RH	INPUT POWER	AC 120V/60HZ
TESTED BY	Jace HU		
ANTENNA POLARITY & TEST DISTANCE: VERTICAL AT 3 M			

	Freq	Level	Read Level	Limit Line	Over Limit	Factor	Remark	Pol/Phase	
	MHz	dBm/m	dBm	dBm/m	dB	dB/m			
1	PP	74.620	-61.80	-40.75	-13.00	-48.80	-21.05	Peak	Vertical
2		98.870	-62.63	-55.21	-13.00	-49.63	-7.42	Peak	Vertical
3		197.810	-78.11	-59.93	-13.00	-65.11	-18.18	Peak	Vertical
4		242.430	-74.28	-60.01	-13.00	-61.28	-14.27	Peak	Vertical
5		423.820	-71.93	-63.15	-13.00	-58.93	-8.78	Peak	Vertical
6		499.480	-71.22	-63.14	-13.00	-58.22	-8.08	Peak	Vertical

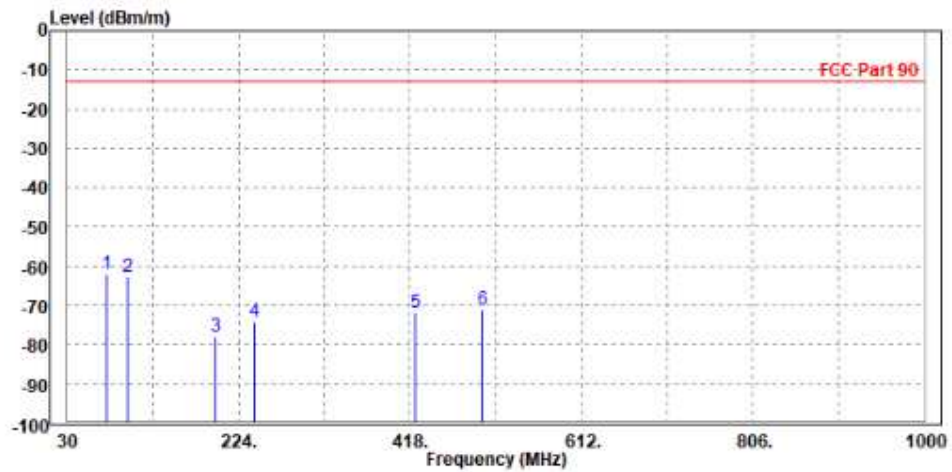



Test Report No.: W7L-P23100014RF09

ABOVE 1GHz

Note: For higher frequency, the emission is too low to be detected.

LTE B14

CHANNEL BANDWIDTH: 5MHz / QPSK

CH23305

MODE	Tx channel 23305	FREQUENCY RANGE	Above 1000MHz
ENVIRONMENTAL CONDITIONS	23deg. C, 70%RH	INPUT POWER	AC 120V/60HZ
TESTED BY	Jace Hu		
ANTENNA POLARITY & TEST DISTANCE: HORIZONTAL AT 3 M			

	Freq	Level	Read Level	Limit Line	Over Limit	Factor	Remark	Pol/Phase
	MHz	dBm/m	dBm	dBm/m	dB	dB/m		
1	PP 1581.000	-51.90	-52.13	-40.00	-11.90	0.23	Peak	Horizontal
2	2377.000	-52.80	-57.79	-13.00	-39.80	4.99	Peak	Horizontal

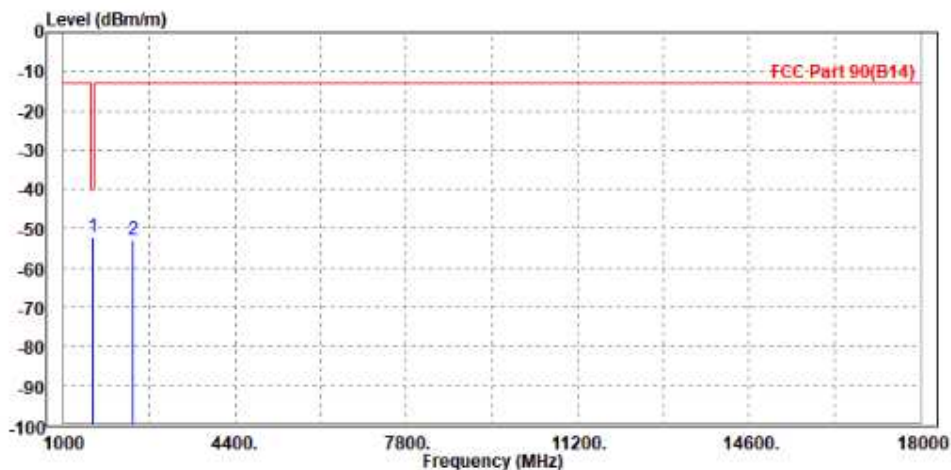



Test Report No.: W7L-P23100014RF09

MODE	TX channel 23305	FREQUENCY RANGE	Above 1000MHz
ENVIRONMENTAL CONDITIONS	23deg. C, 70%RH	INPUT POWER	AC 120V/60HZ
TESTED BY	Jace Hu		
ANTENNA POLARITY & TEST DISTANCE: VERTICAL AT 3 M			

	Freq	Level	Read Level	Limit Line	Over Limit	Factor	Remark	Pol/Phase
	MHz	dBm/m	dBm	dBm/m	dB	dB/m		
1	PP 1578.000	-49.82	-50.35	-40.00	-9.82	0.53	Peak	Vertical
2	2371.500	-53.76	-58.35	-13.00	-40.76	4.59	Peak	Vertical

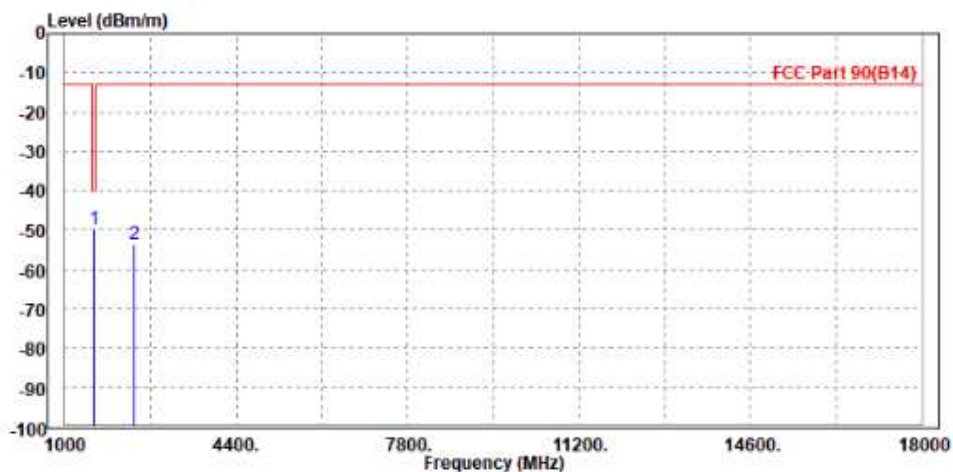



Test Report No.: W7L-P23100014RF09

CH23330

MODE	TX channel 23330	FREQUENCY RANGE	Above 1000MHz
ENVIRONMENTAL CONDITIONS	23deg. C, 70%RH	INPUT POWER	AC 120V/60HZ
TESTED BY	Jace Hu		
ANTENNA POLARITY & TEST DISTANCE: HORIZONTAL AT 3 M			

	Read	Limit	Over				
Freq	Level	Level	Line	Limit	Factor	Remark	Pol/Phase
MHz	dBm/m	dBm	dBm/m	dB	dB/m		
1 PP 1578.000	-51.42	-51.63	-40.00	-11.42	0.21	Peak	Horizontal
2 2379.000	-53.42	-58.42	-13.00	-40.42	5.00	Peak	Horizontal

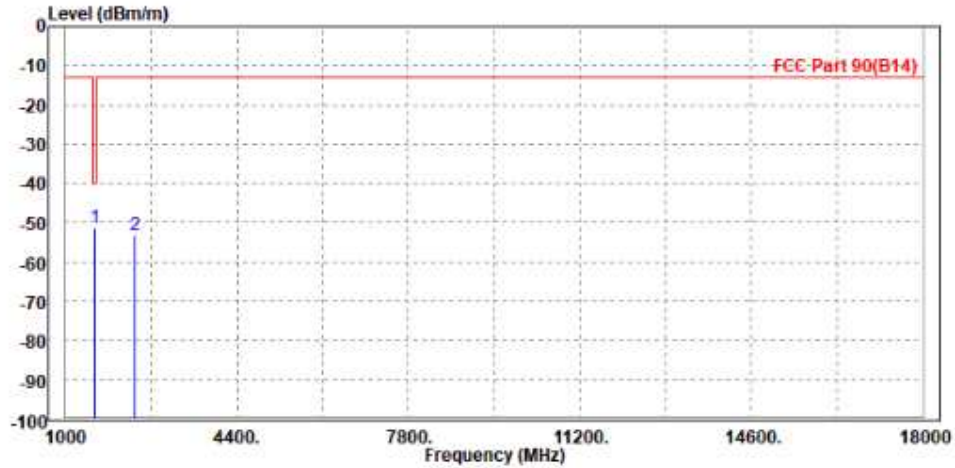



Test Report No.: W7L-P23100014RF09

MODE	TX channel 23330	FREQUENCY RANGE	Above 1000MHz
ENVIRONMENTAL CONDITIONS	23deg. C, 70%RH	INPUT POWER	AC 120V/60HZ
TESTED BY	Jace Hu		
ANTENNA POLARITY & TEST DISTANCE: VERTICAL AT 3 M			

	Freq	Level	Read Level	Limit Line	Over Limit	Factor	Remark	Pol/Phase
	MHz	dBm/m	dBm	dBm/m	dB	dB/m		
1	PP 1586.000	-51.54	-52.13	-40.00	-11.54	0.59	Peak	Vertical
2	2377.000	-53.98	-58.59	-13.00	-40.98	4.61	Peak	Vertical

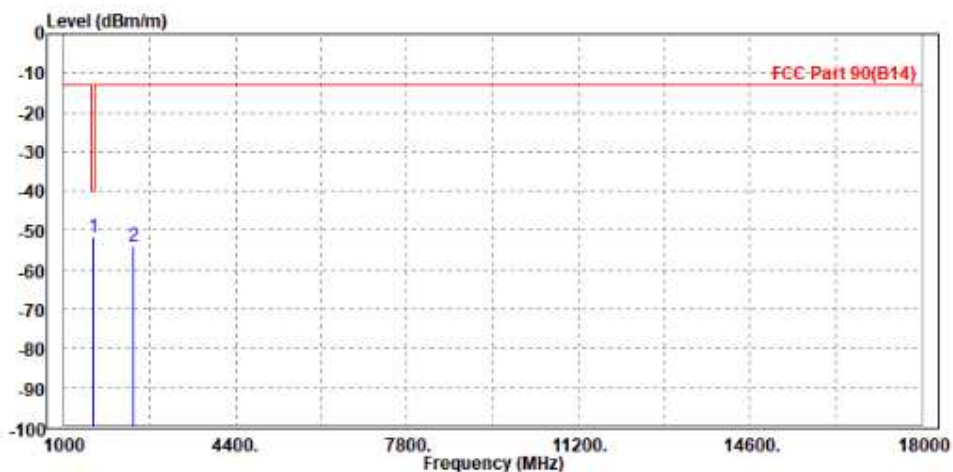



Test Report No.: W7L-P23100014RF09

CH23355

MODE	TX channel 23355	FREQUENCY RANGE	Above 1000MHz
ENVIRONMENTAL CONDITIONS	23deg. C, 70%RH	INPUT POWER	AC 120V/60HZ
TESTED BY	Jace Hu		
ANTENNA POLARITY & TEST DISTANCE: HORIZONTAL AT 3 M			

	Freq	Level	Read Level	Limit Line	Over Limit	Factor	Remark	Pol/Phase
	MHz	dBm/m	dBm	dBm/m	dB	dB/m		
1	PP 1595.000	-52.55	-52.90	-40.00	-12.55	0.35	Peak	Horizontal
2	2386.500	-53.57	-58.60	-13.00	-40.57	5.03	Peak	Horizontal

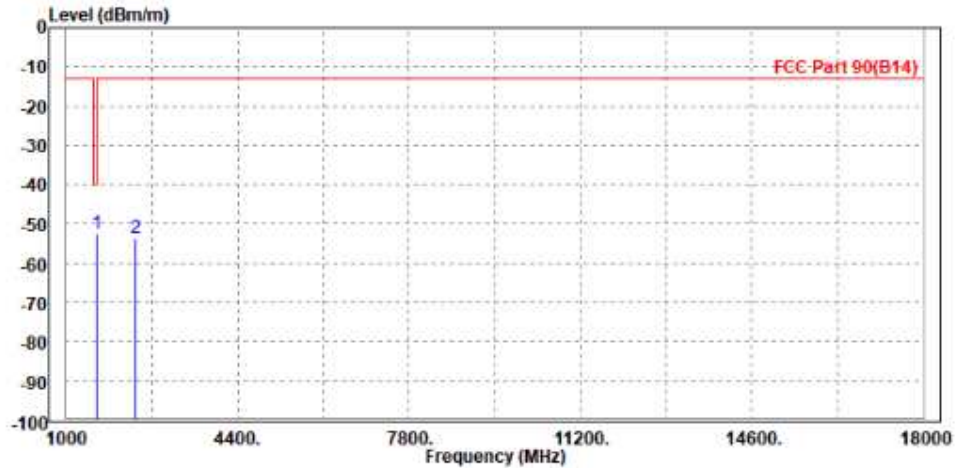



Test Report No.: W7L-P23100014RF09

MODE	TX channel 23355	FREQUENCY RANGE	Above 1000MHz
ENVIRONMENTAL CONDITIONS	23deg. C, 70%RH	INPUT POWER	AC 120V/60HZ
TESTED BY	Jace Hu		
ANTENNA POLARITY & TEST DISTANCE: VERTICAL AT 3 M			

	Freq	Level	Read Level	Limit Line	Over Limit	Factor	Remark	Pol/Phase
	MHz	dBm/m	dBm	dBm/m	dB	dB/m		
1	PP 1591.000	-51.98	-52.60	-40.00	-11.98	0.62	Peak	Vertical
2	2394.000	-53.23	-57.88	-13.00	-40.23	4.65	Peak	Vertical

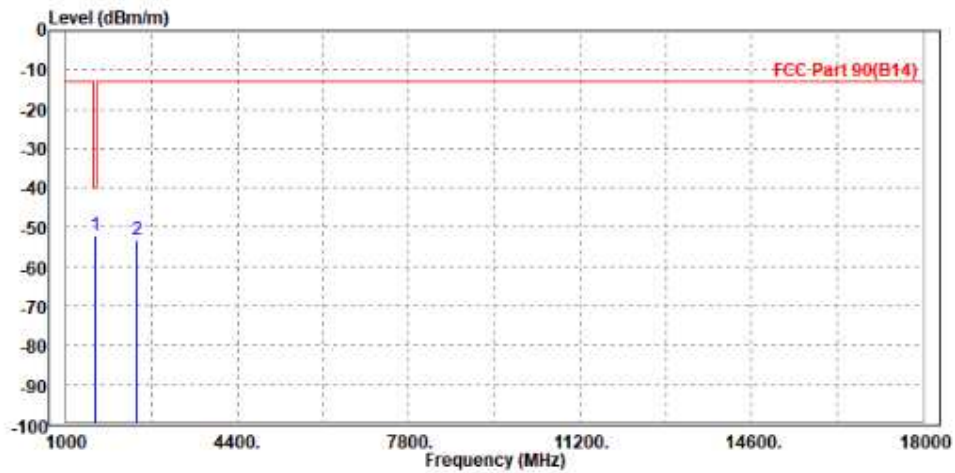



Test Report No.: W7L-P23100014RF09

CHANNEL BANDWIDTH: 10MHz / QPSK

CH23330

MODE	TX channel 23330	FREQUENCY RANGE	Above 1000MHz
ENVIRONMENTAL CONDITIONS	23deg. C, 70%RH	INPUT POWER	AC 120V/60HZ
TESTED BY	Jace Hu		
ANTENNA POLARITY & TEST DISTANCE: HORIZONTAL AT 3 M			

	Freq	Level	Read Level	Limit Line	Over Limit	Factor	Remark	Pol/Phase
	MHz	dBm/m	dBm	dBm/m	dB	dB/m		
1	PP 1586.000	-53.77	-54.04	-40.00	-13.77	0.27	Peak	Horizontal
2	2377.000	-53.64	-58.63	-13.00	-40.64	4.99	Peak	Horizontal

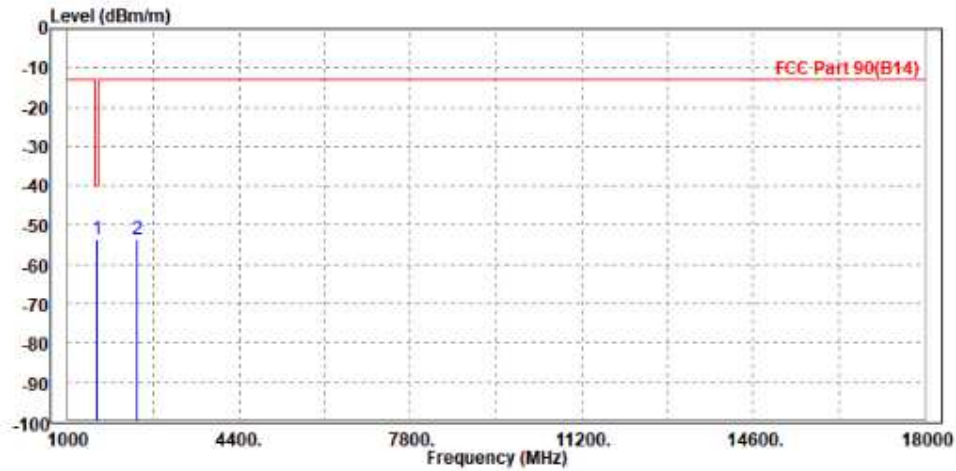



Test Report No.: W7L-P23100014RF09

MODE	TX channel 23330	FREQUENCY RANGE	Above 1000MHz
ENVIRONMENTAL CONDITIONS	23deg. C, 70%RH	INPUT POWER	AC 120V/60HZ
TESTED BY	Jace Hu		
ANTENNA POLARITY & TEST DISTANCE: VERTICAL AT 3 M			

	Freq	Level	Read Level	Limit Line	Over Limit	Factor	Remark	Pol/Phase
	MHz	dBm/m	dBm	dBm/m	dB	dB/m		
1	PP 1578.000	-54.17	-54.70	-40.00	-14.17	0.53	Peak	Vertical
2	2379.000	-51.95	-56.56	-13.00	-38.95	4.61	Peak	Vertical

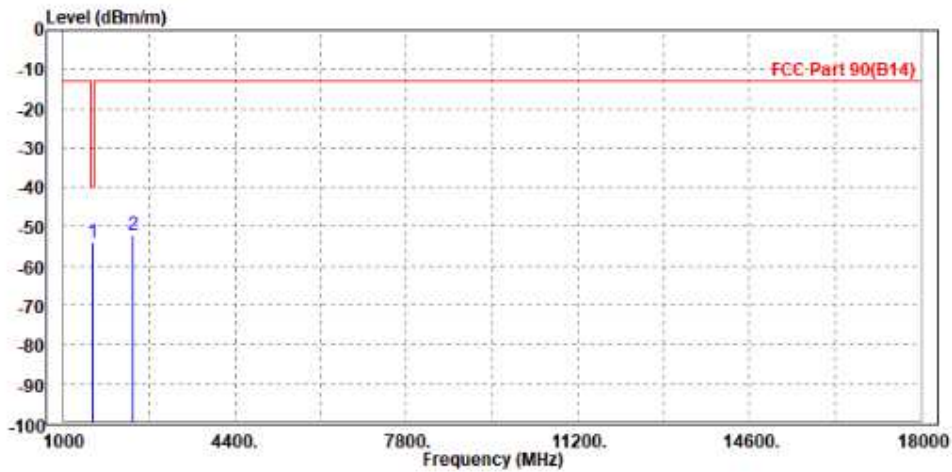



Test Report No.: W7L-P23100014RF09

LTE BAND 26

CHANNEL BANDWIDTH: 1.4MHz / QPSK

MODE	TX channel 26697	FREQUENCY RANGE	Above 1000MHz
ENVIRONMENTAL CONDITIONS	23deg. C, 70%RH	INPUT POWER	AC 120V/60HZ
TESTED BY	Jace Hu		
ANTENNA POLARITY & TEST DISTANCE: HORIZONTAL AT 3 M			

	Freq	Level	Read Level	Limit Line	Over Limit	Factor	Remark	Pol/Phase
	MHz	dBm/m	dBm	dBm/m	dB	dB/m		
1	PP 1638.000	-52.54	-53.23	-13.00	-39.54	0.69	Peak	Horizontal
2	2462.000	-53.27	-58.57	-13.00	-40.27	5.30	Peak	Horizontal

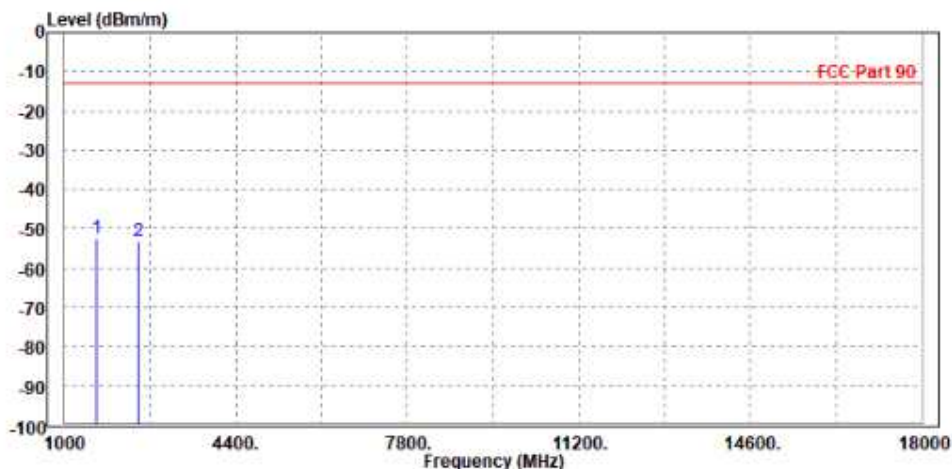



Test Report No.: W7L-P23100014RF09

MODE	TX channel 26697	FREQUENCY RANGE	Above 1000MHz
ENVIRONMENTAL CONDITIONS	23deg. C, 70%RH	INPUT POWER	AC 120V/60HZ
TESTED BY	Jace Hu		
ANTENNA POLARITY & TEST DISTANCE: VERTICAL AT 3 M			

	Freq	Level	Read Level	Limit Line	Over Limit	Factor	Remark	Pol/Phase
	MHz	dBm/m	dBm	dBm/m	dB	dB/m		
1	PP 1646.000	-50.77	-51.79	-13.00	-37.77	1.02	Peak	Vertical
2	2457.000	-53.79	-58.61	-13.00	-40.79	4.82	Peak	Vertical

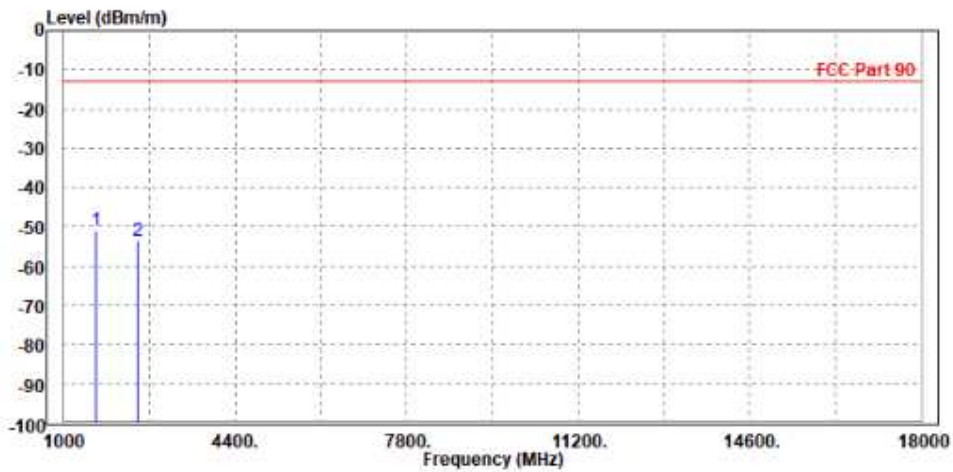



Test Report No.: W7L-P23100014RF09

CHANNEL BANDWIDTH: 3MHz / QPSK

CH26705

MODE	TX channel 26705	FREQUENCY RANGE	Above 1000MHz
ENVIRONMENTAL CONDITIONS	23deg. C, 70%RH	INPUT POWER	AC 120V/60HZ
TESTED BY	Jace Hu		
ANTENNA POLARITY & TEST DISTANCE: HORIZONTAL AT 3 M			

	Freq	Level	Read Level	Limit Line	Over Limit	Factor	Remark	Pol/Phase
	MHz	dBm/m	dBm	dBm/m	dB	dB/m		
1	1635.000	-53.94	-54.61	-13.00	-40.94	0.67	Peak	Horizontal
2 PP	2445.000	-52.73	-57.97	-13.00	-39.73	5.24	Peak	Horizontal

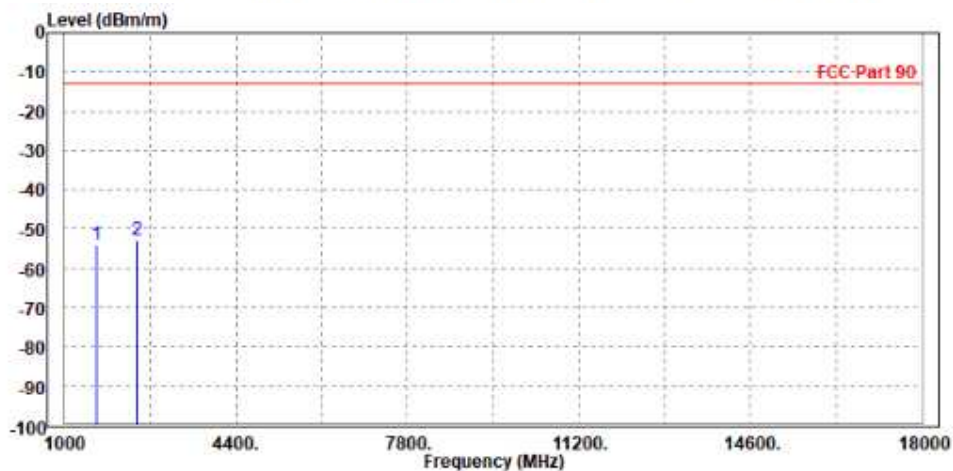



Test Report No.: W7L-P23100014RF09

MODE	TX channel 26705	FREQUENCY RANGE	Above 1000MHz
ENVIRONMENTAL CONDITIONS	23deg. C, 70%RH	INPUT POWER	AC 120V/60HZ
TESTED BY	Jace Hu		
ANTENNA POLARITY & TEST DISTANCE: VERTICAL AT 3 M			

	Freq	Level	Read Level	Limit Line	Over Limit	Factor	Remark	Pol/Phase
	MHz	dBm/m	dBm	dBm/m	dB	dB/m		
1	PP 1629.000	-51.66	-52.56	-13.00	-38.66	0.90	Peak	Vertical
2	2452.500	-53.17	-57.98	-13.00	-40.17	4.81	Peak	Vertical

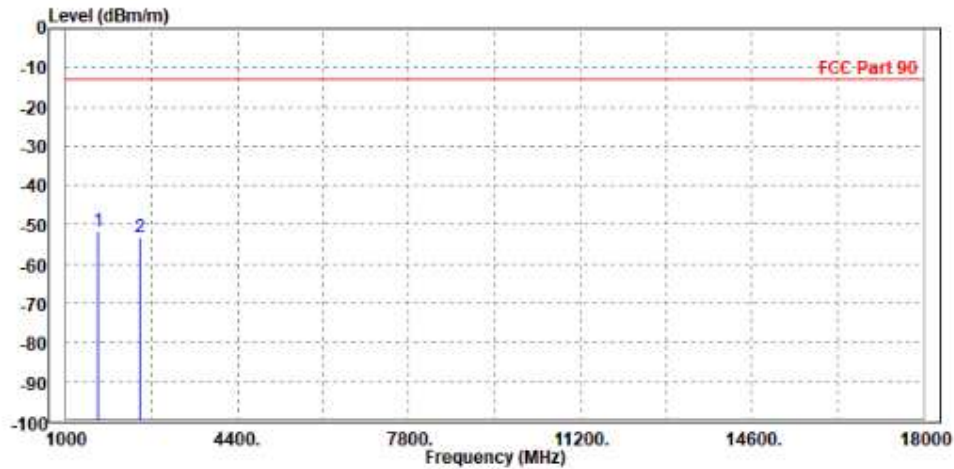



Test Report No.: W7L-P23100014RF09

CH26740

MODE	TX channel 26740	FREQUENCY RANGE	Above 1000MHz
ENVIRONMENTAL CONDITIONS	23deg. C, 70%RH	INPUT POWER	AC 120V/60HZ
TESTED BY	Jace Hu		
ANTENNA POLARITY & TEST DISTANCE: HORIZONTAL AT 3 M			

	Freq	Level	Read Level	Limit Line	Over Limit	Factor	Remark	Pol/Phase
	MHz	dBm/m	dBm	dBm/m	dB	dB/m		
1	PP 1646.000	-51.88	-52.64	-13.00	-38.88	0.76	Peak	Horizontal
2	2457.000	-52.69	-57.97	-13.00	-39.69	5.28	Peak	Horizontal

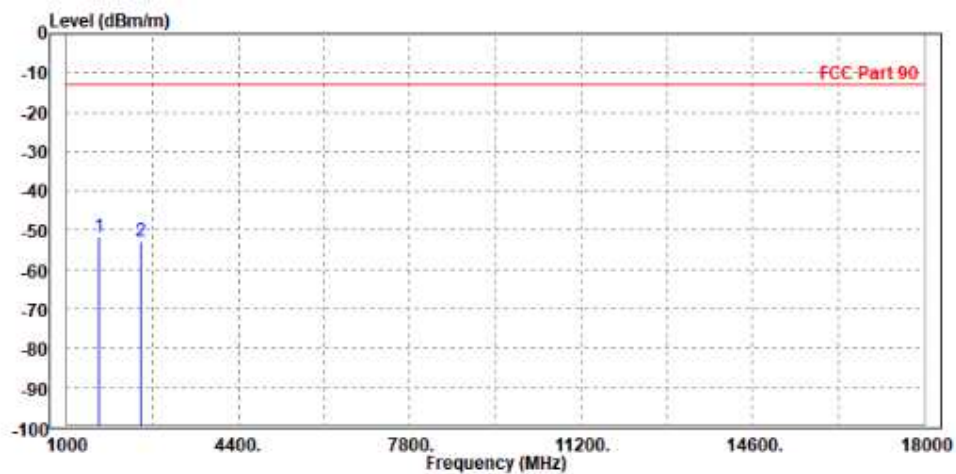



Test Report No.: W7L-P23100014RF09

MODE	TX channel 26740	FREQUENCY RANGE	Above 1000MHz
ENVIRONMENTAL CONDITIONS	23deg. C, 70%RH	INPUT POWER	AC 120V/60HZ
TESTED BY	Jace Hu		
ANTENNA POLARITY & TEST DISTANCE: VERTICAL AT 3 M			

	Freq	Level	Read Level	Limit Line	Over Limit	Factor	Remark	Pol/Phase
	MHz	dBm/m	dBm	dBm/m	dB	dB/m		
1	PP 1638.000	-50.32	-51.28	-13.00	-37.32	0.96	Peak	Vertical
2	2462.000	-52.34	-57.18	-13.00	-39.34	4.84	Peak	Vertical

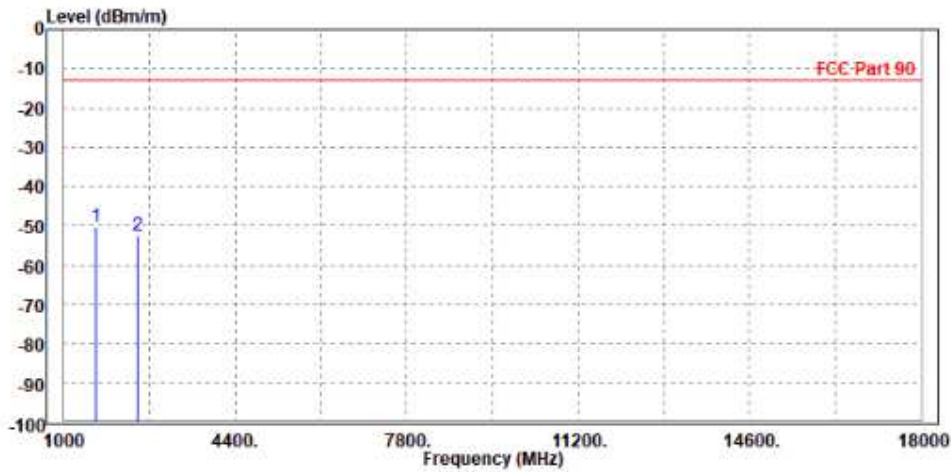



Test Report No.: W7L-P23100014RF09

CH26775

MODE	TX channel 26775	FREQUENCY RANGE	Above 1000MHz
ENVIRONMENTAL CONDITIONS	23deg. C, 70%RH	INPUT POWER	AC 120V/60HZ
TESTED BY	Jace Hu		
ANTENNA POLARITY & TEST DISTANCE: HORIZONTAL AT 3 M			

	Freq	Level	Read Level	Limit Line	Over Limit	Factor	Remark	Pol/Phase
	MHz	dBm/m	dBm	dBm/m	dB	dB/m		
1	1646.000	-53.43	-54.19	-13.00	-40.43	0.76	Peak	Horizontal
2	PP 2461.500	-52.79	-58.09	-13.00	-39.79	5.30	Peak	Horizontal

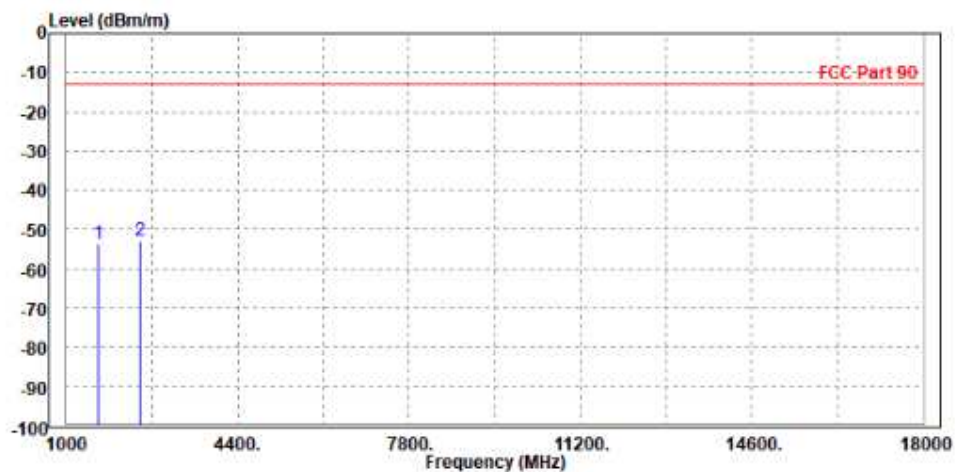



Test Report No.: W7L-P23100014RF09

MODE	TX channel 26775	FREQUENCY RANGE	Above 1000MHz
ENVIRONMENTAL CONDITIONS	23deg. C, 70%RH	INPUT POWER	AC 120V/60HZ
TESTED BY	Jace Hu		
ANTENNA POLARITY & TEST DISTANCE: VERTICAL AT 3 M			

	Freq	Level	Read Level	Limit Line	Over Limit	Factor	Remark	Pol/Phase
	MHz	dBm/m	dBm	dBm/m	dB	dB/m		
1	PP 1641.000	-51.27	-52.26	-13.00	-38.27	0.99	Peak	Vertical
2	2462.000	-53.71	-58.55	-13.00	-40.71	4.84	Peak	Vertical

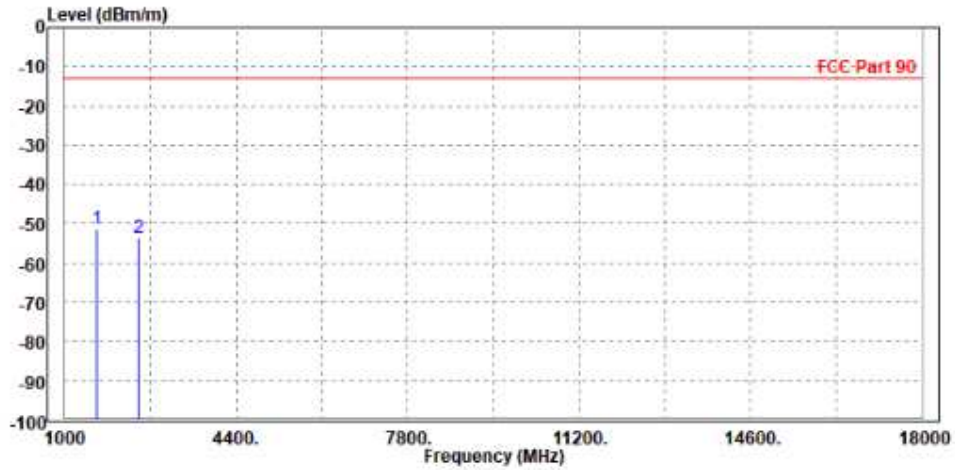



Test Report No.: W7L-P23100014RF09

CHANNEL BANDWIDTH: 5MHz / QPSK

MODE	TX channel 26740	FREQUENCY RANGE	Above 1000MHz
ENVIRONMENTAL CONDITIONS	23deg. C, 70%RH	INPUT POWER	AC 120V/60HZ
TESTED BY	Jace Hu		
ANTENNA POLARITY & TEST DISTANCE: HORIZONTAL AT 3 M			

	Freq	Level	Read Level	Limit Line	Over Limit	Factor	Remark	Pol/Phase
	MHz	dBm/m	dBm	dBm/m	dB	dB/m		
1	1638.000	-53.72	-54.41	-13.00	-40.72	0.69	Peak	Horizontal
2	PP 2462.000	-53.04	-58.34	-13.00	-40.04	5.30	Peak	Horizontal

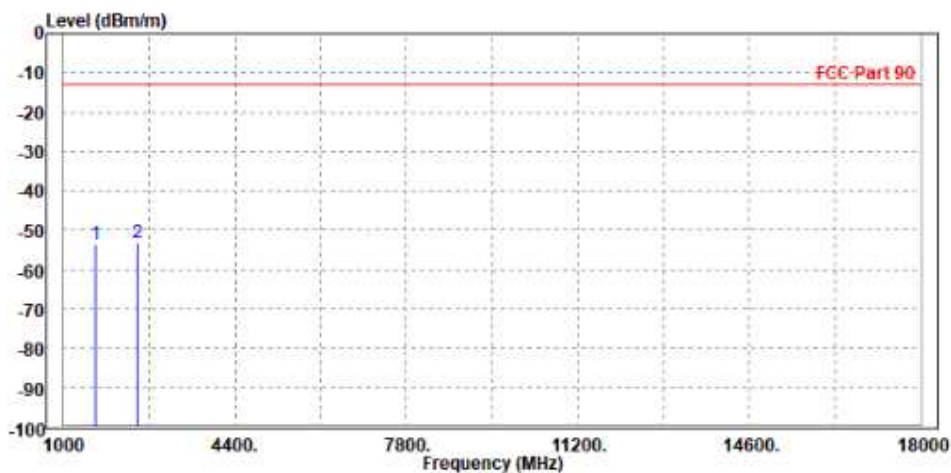



Test Report No.: W7L-P23100014RF09

MODE	TX channel 26740	FREQUENCY RANGE	Above 1000MHz
ENVIRONMENTAL CONDITIONS	23deg. C, 70%RH	INPUT POWER	AC 120V/60HZ
TESTED BY	Jace Hu		
ANTENNA POLARITY & TEST DISTANCE: VERTICAL AT 3 M			

	Freq	Level	Read Level	Limit Line	Over Limit	Factor	Remark	Pol/Phase
	MHz	dBm/m	dBm	dBm/m	dB	dB/m		
1	PP 1646.000	-51.97	-52.99	-13.00	-38.97	1.02	Peak	Vertical
2	2457.000	-53.59	-58.41	-13.00	-40.59	4.82	Peak	Vertical

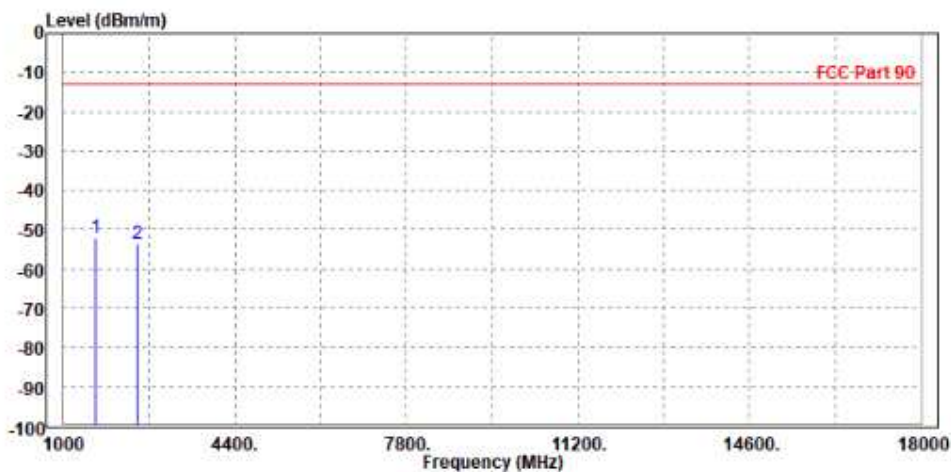



Test Report No.: W7L-P23100014RF09

CHANNEL BANDWIDTH: 10MHz / QPSK

MODE	TX channel 26740	FREQUENCY RANGE	Above 1000MHz
ENVIRONMENTAL CONDITIONS	23deg. C, 70%RH	INPUT POWER	AC 120V/60HZ
TESTED BY	Jace Hu		
ANTENNA POLARITY & TEST DISTANCE: HORIZONTAL AT 3 M			

	Freq	Level	Read Level	Limit Line	Over Limit	Factor	Remark	Pol/Phase
	MHz	dBm/m	dBm	dBm/m	dB	dB/m		
1	1646.000	-56.35	-57.11	-13.00	-43.35	0.76	Peak	Horizontal
2 PP	2457.000	-52.81	-58.09	-13.00	-39.81	5.28	Peak	Horizontal

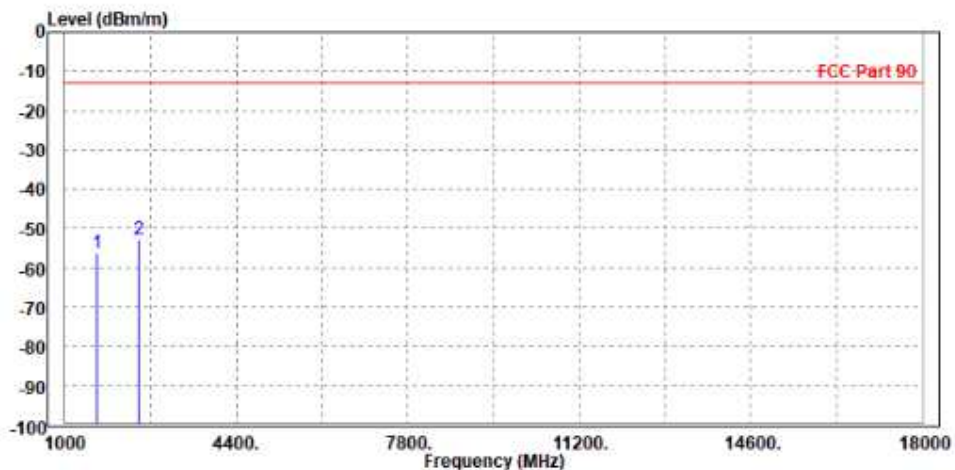



Test Report No.: W7L-P23100014RF09

MODE	TX channel 26740	FREQUENCY RANGE	Above 1000MHz
ENVIRONMENTAL CONDITIONS	23deg. C, 70%RH	INPUT POWER	AC 120V/60HZ
TESTED BY	Jace Hu		
ANTENNA POLARITY & TEST DISTANCE: VERTICAL AT 3 M			

	Freq	Level	Read Level	Limit Line	Over Limit	Factor	Remark	Pol/Phase
	MHz	dBm/m	dBm	dBm/m	dB	dB/m		
1	PP 1646.000	-52.24	-53.26	-13.00	-39.24	1.02	Peak	Vertical
2	2457.000	-53.64	-58.46	-13.00	-40.64	4.82	Peak	Vertical

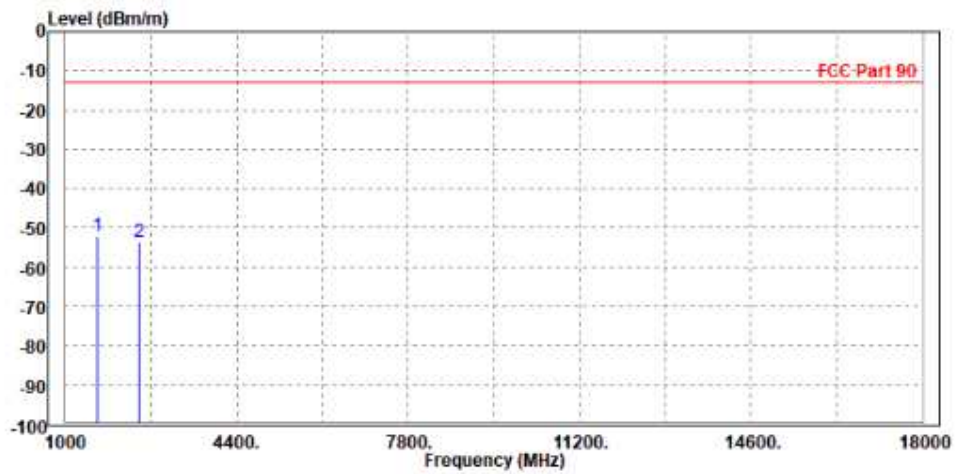

3.7 PEAK TO AVERAGE RATIO

3.7.1 LIMITS OF PEAK TO AVERAGE RATIO MEASUREMENT

In measuring transmissions in this band using an average power technique, the peak to-average ratio (PAR) of the transmission may not exceed 13 dB

3.7.2 TEST SETUP

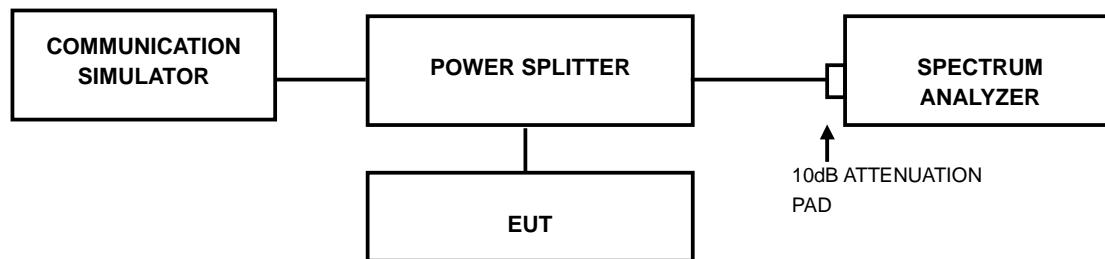

3.7.3 TEST PROCEDURES

1. Set resolution/measurement bandwidth \geq signal's occupied bandwidth;
2. Set the number of counts to a value that stabilizes the measured CCDF curve;
3. Record the maximum PAPR level associated with a probability of 0.1%.



Test Report No.: W7L-P23100014RF09

3.7.4 TEST RESULTS

Please Refer to Appendix Of this test report.



Test Report No.: W7L-P23100014RF09

4 INFORMATION ON THE TESTING LABORATORIES

We, BV 7LAYERS COMMUNICATIONS TECHNOLOGY (SHENZHEN) CO. LTD., were founded in 2015 to provide our best service in EMC, Radio, Telecom and Safety consultation. Our laboratories are accredited and approved according to ISO/IEC 17025.

If you have any comments, please feel free to contact us at the following:

Shenzhen EMC/RF Lab:

Tel: +86-755-88696566

Fax: +86-755-88696577

Email: customerservice.sw@bureauveritas.com

Web Site: www.adt.com.tw

The address and road map of all our labs can be found in our web site also.



Test Report No.: W7L-P23100014RF09

5 MODIFICATIONS RECORDERS FOR ENGINEERING CHANGES TO THE EUT BY THE LAB

No modifications were made to the EUT by the lab during the test.



6 APPENDIX

LTE BAND14

PEAK-TO-AVERAGE RATIO(CCDF)

Test Result

Band	Bandwidth	Modulation	Channel	RB Configuration	Result(dB)	Limit(dB)	Verdict
Band14	5MHz	QPSK	23305	1RB#0	3.43	13	PASS
Band14	5MHz	QPSK	23305	25RB#0	5.02	13	PASS
Band14	5MHz	QPSK	23330	1RB#0	3.48	13	PASS
Band14	5MHz	QPSK	23330	25RB#0	5.34	13	PASS
Band14	5MHz	QPSK	23355	1RB#0	3.73	13	PASS
Band14	5MHz	QPSK	23355	25RB#0	5.32	13	PASS
Band14	5MHz	16QAM	23305	1RB#0	4.85	13	PASS
Band14	5MHz	16QAM	23305	25RB#0	5.78	13	PASS
Band14	5MHz	16QAM	23330	1RB#0	4.94	13	PASS
Band14	5MHz	16QAM	23330	25RB#0	6.06	13	PASS
Band14	5MHz	16QAM	23355	1RB#0	5.45	13	PASS
Band14	5MHz	16QAM	23355	25RB#0	6.10	13	PASS
Band14	5MHz	64QAM	23305	1RB#0	6.15	13	PASS
Band14	5MHz	64QAM	23305	25RB#0	6.47	13	PASS
Band14	5MHz	64QAM	23330	1RB#0	6.09	13	PASS
Band14	5MHz	64QAM	23330	25RB#0	6.79	13	PASS
Band14	5MHz	64QAM	23355	1RB#0	6.48	13	PASS
Band14	5MHz	64QAM	23355	25RB#0	6.71	13	PASS
Band14	10MHz	QPSK	23330	1RB#0	3.41	13	PASS
Band14	10MHz	QPSK	23330	50RB#0	5.23	13	PASS
Band14	10MHz	16QAM	23330	1RB#0	4.94	13	PASS
Band14	10MHz	16QAM	23330	50RB#0	6.01	13	PASS
Band14	10MHz	64QAM	23330	1RB#0	5.83	13	PASS
Band14	10MHz	64QAM	23330	50RB#0	6.62	13	PASS



Test Graphs

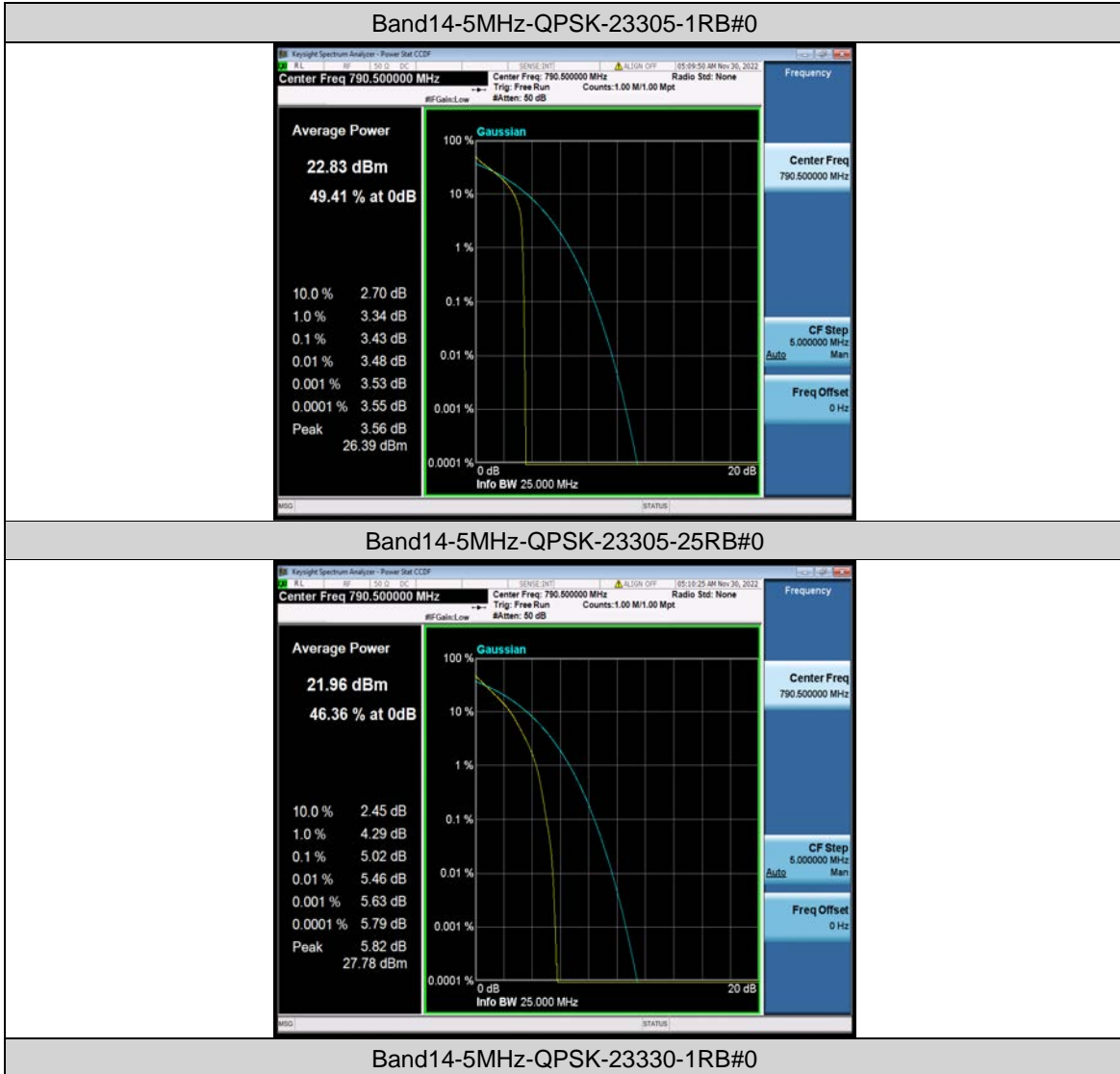



Test Report No.: W7L-P23100014RF09

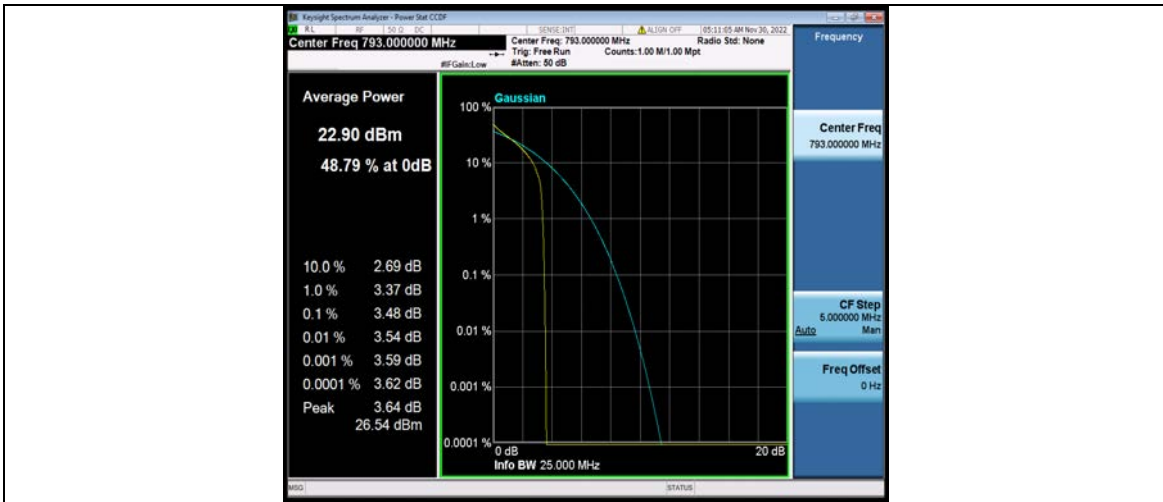

Band14-5MHz-QPSK-23330-25RB#0

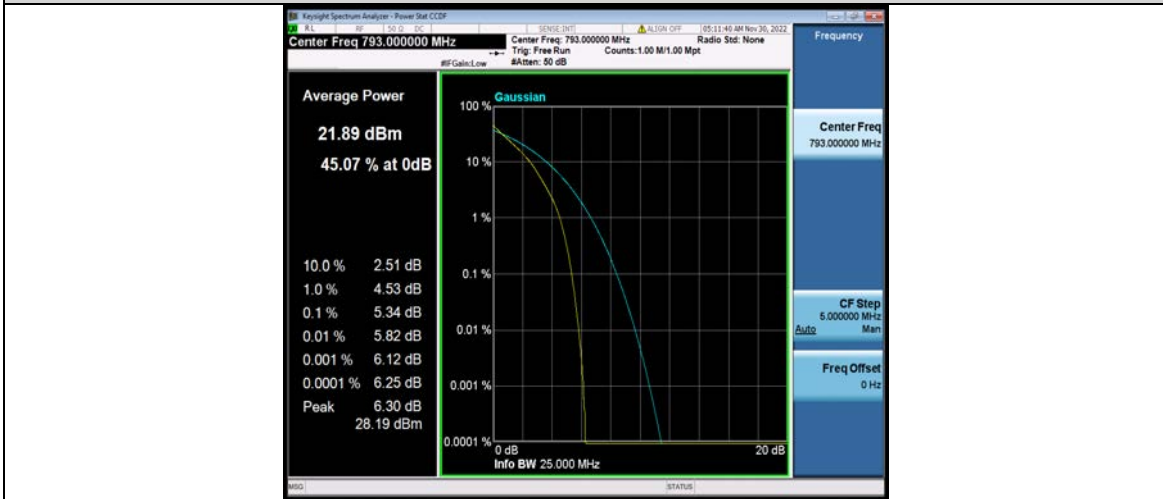

Band14-5MHz-QPSK-23355-1RB#0

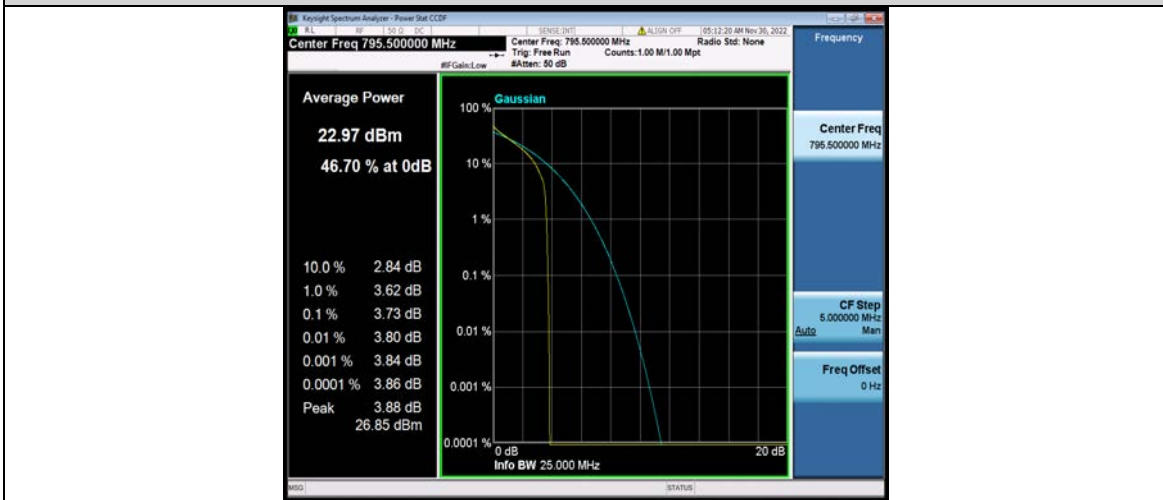

Band14-5MHz-QPSK-23355-25RB#0



Test Report No.: W7L-P23100014RF09

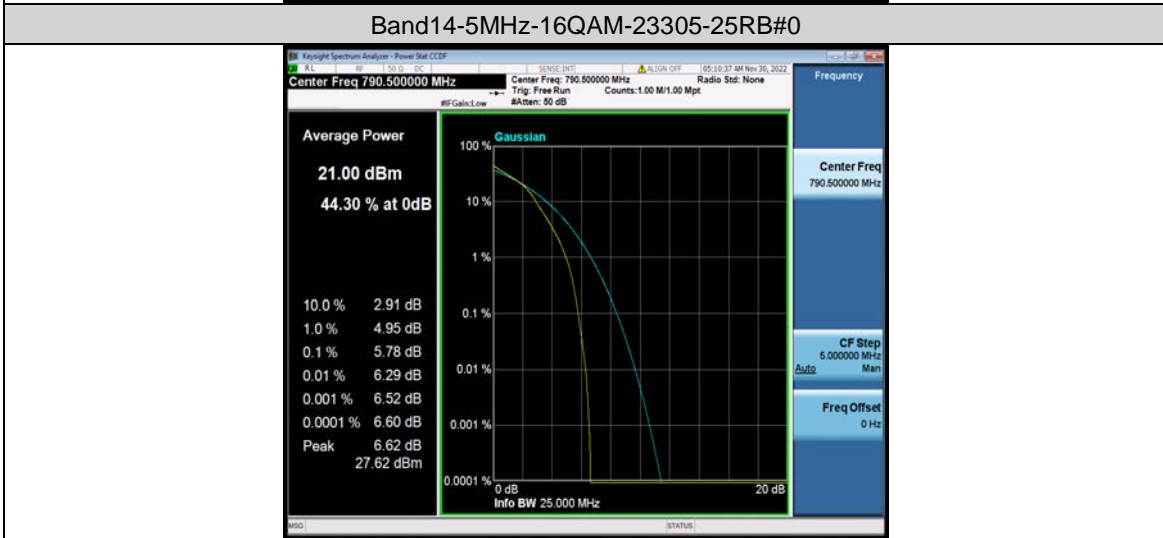
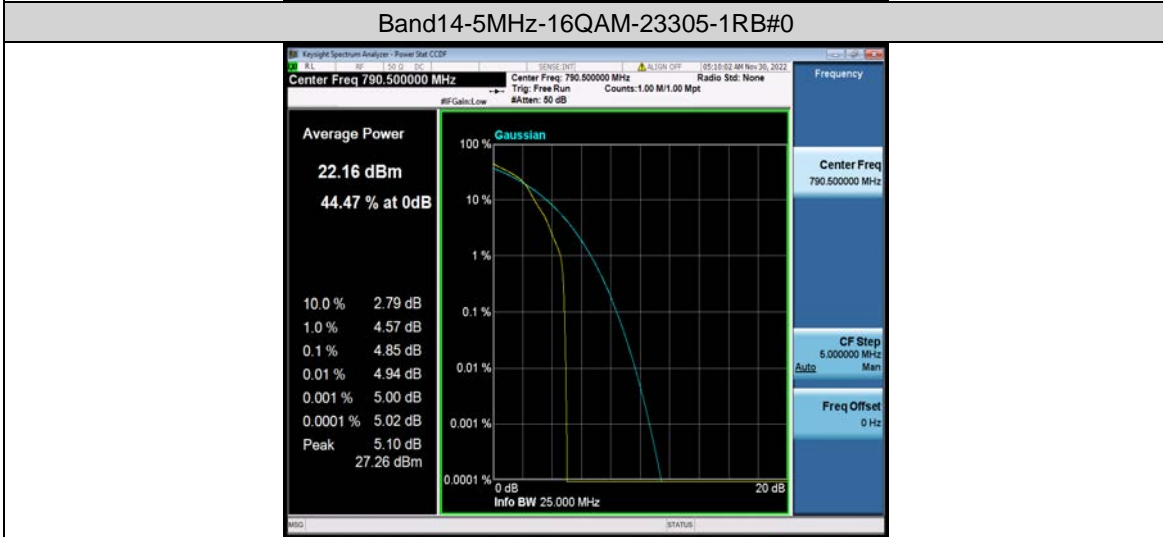
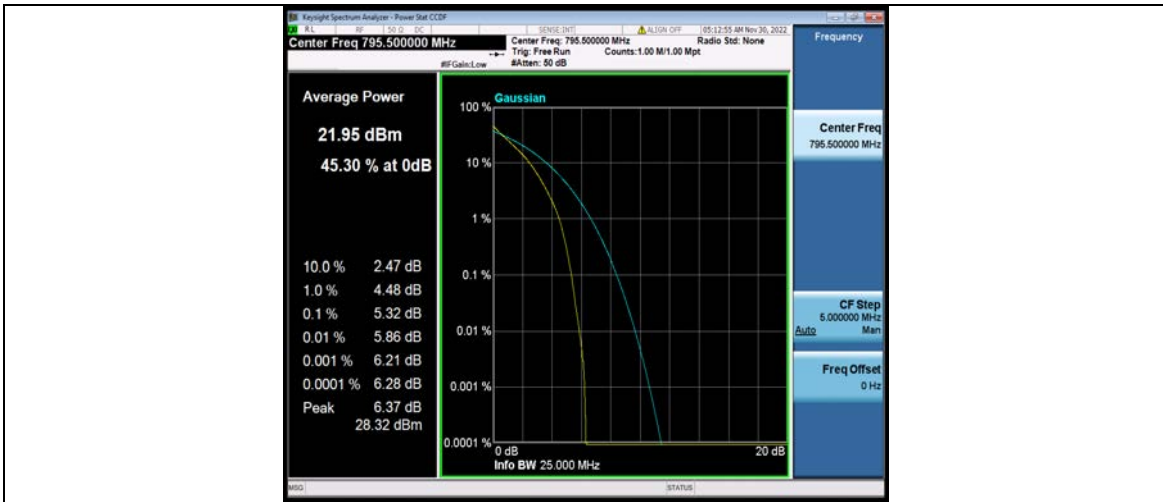



Test Report No.: W7L-P23100014RF09



Band14-5MHz-16QAM-23330-25RB#0

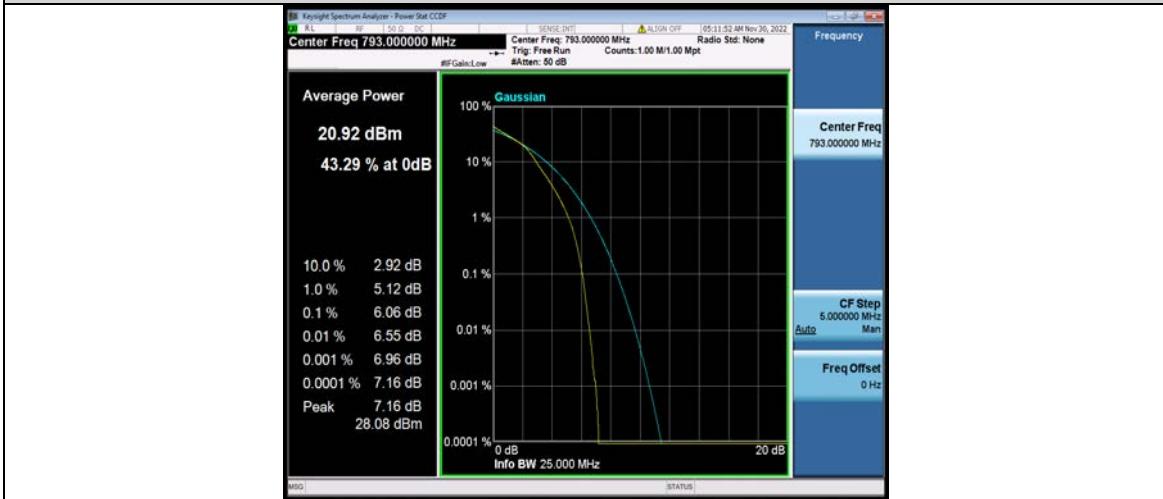

Band14-5MHz-16QAM-23355-1RB#0



Band14-5MHz-16QAM-23355-25RB#0



Test Report No.: W7L-P23100014RF09



Band14-5MHz-64QAM-23305-1RB#0

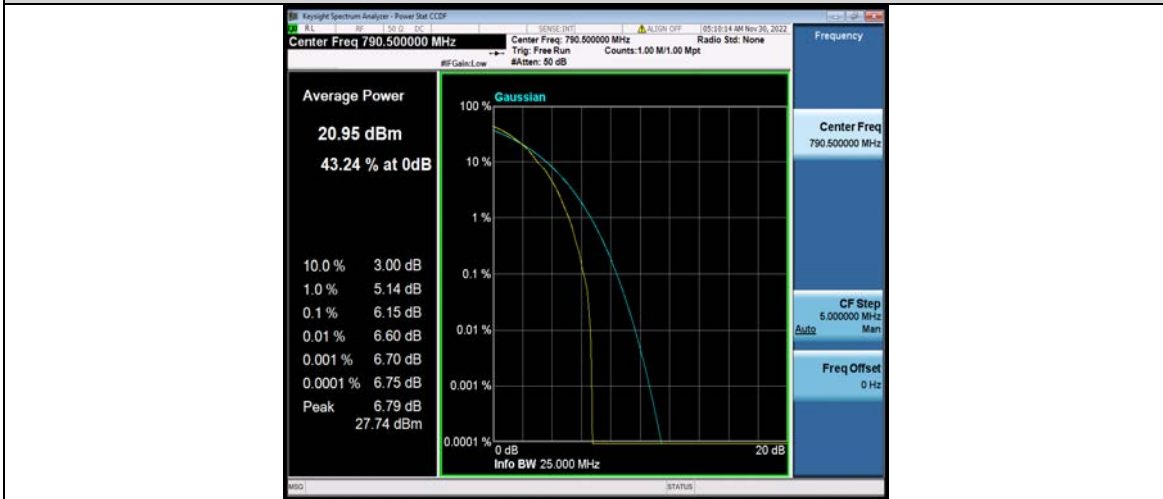

Band14-5MHz-64QAM-23305-25RB#0



Band14-5MHz-64QAM-23330-1RB#0



Test Report No.: W7L-P23100014RF09

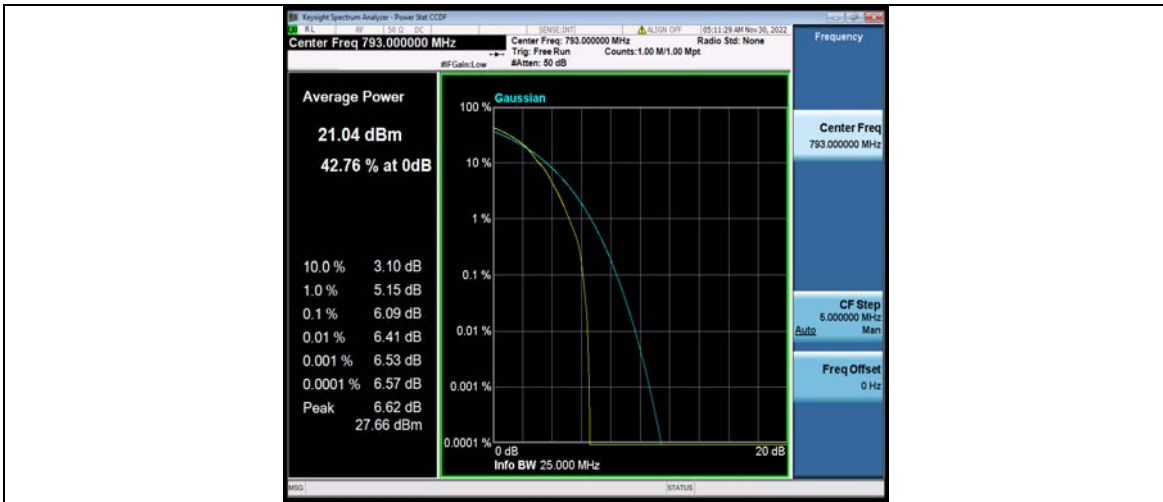

Band14-5MHz-64QAM-23330-25RB#0

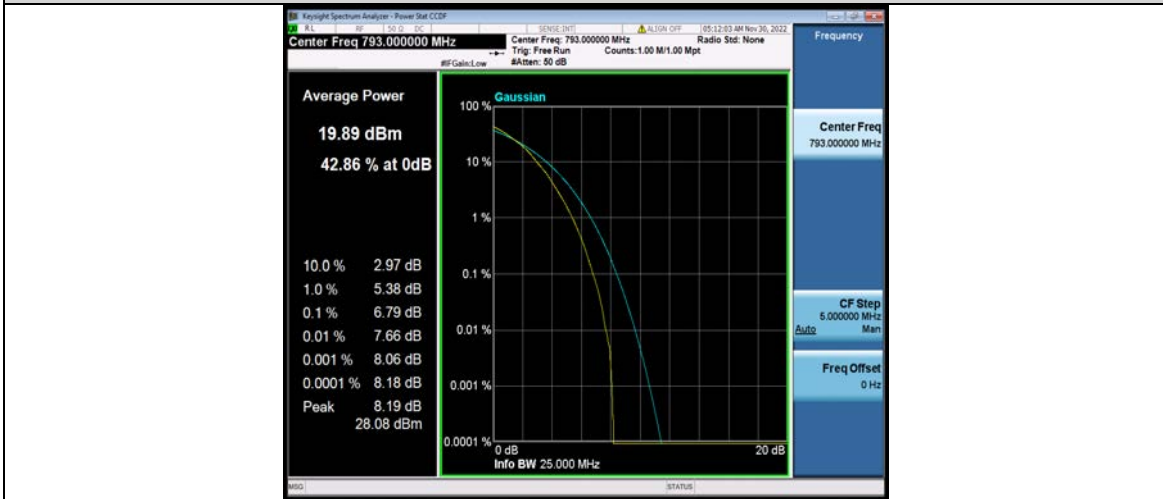

Band14-5MHz-64QAM-23355-1RB#0

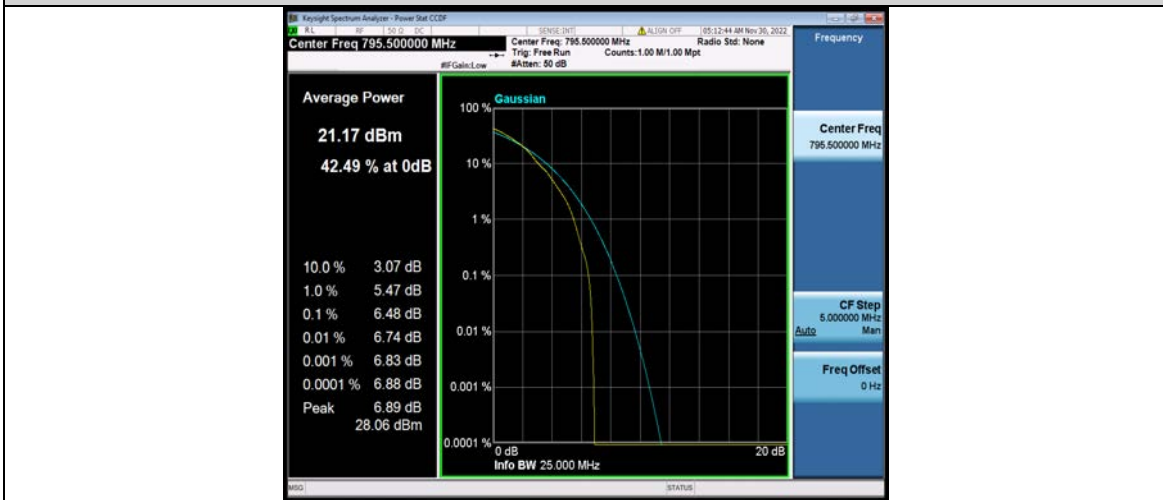

Band14-5MHz-64QAM-23355-25RB#0



Test Report No.: W7L-P23100014RF09



Band14-10MHz-QPSK-23330-1RB#0

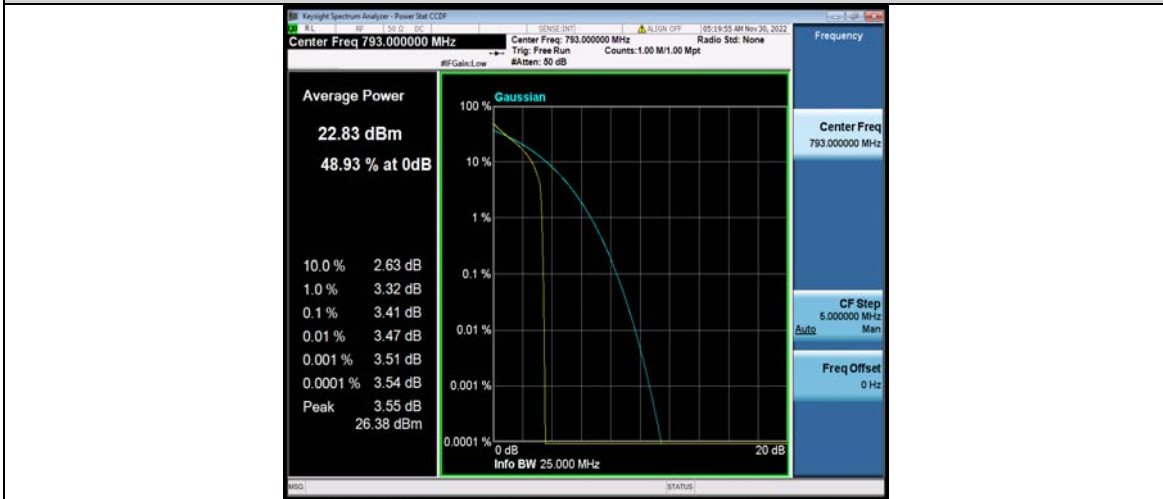

Band14-10MHz-QPSK-23330-50RB#0

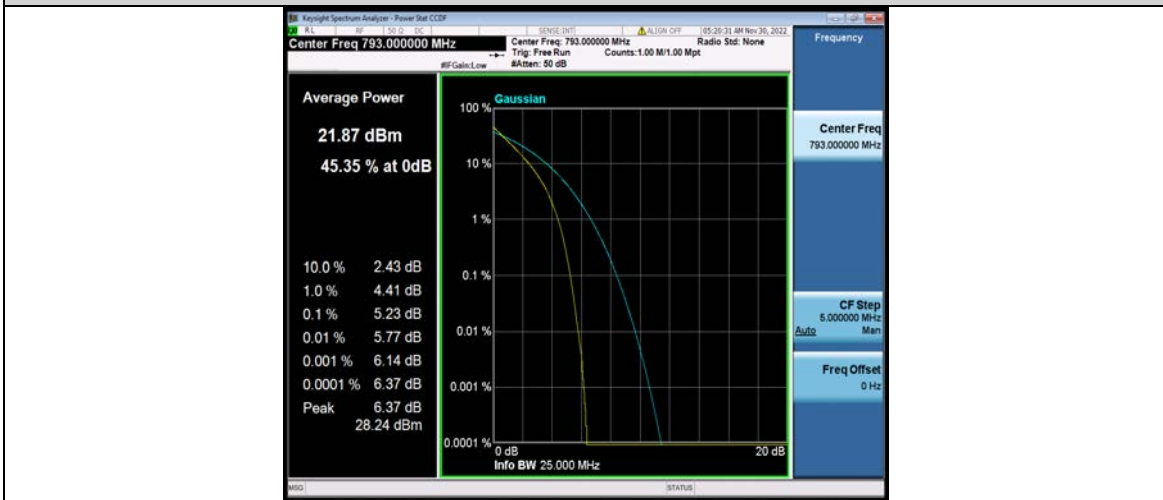

Band14-10MHz-16QAM-23330-1RB#0



Test Report No.: W7L-P23100014RF09

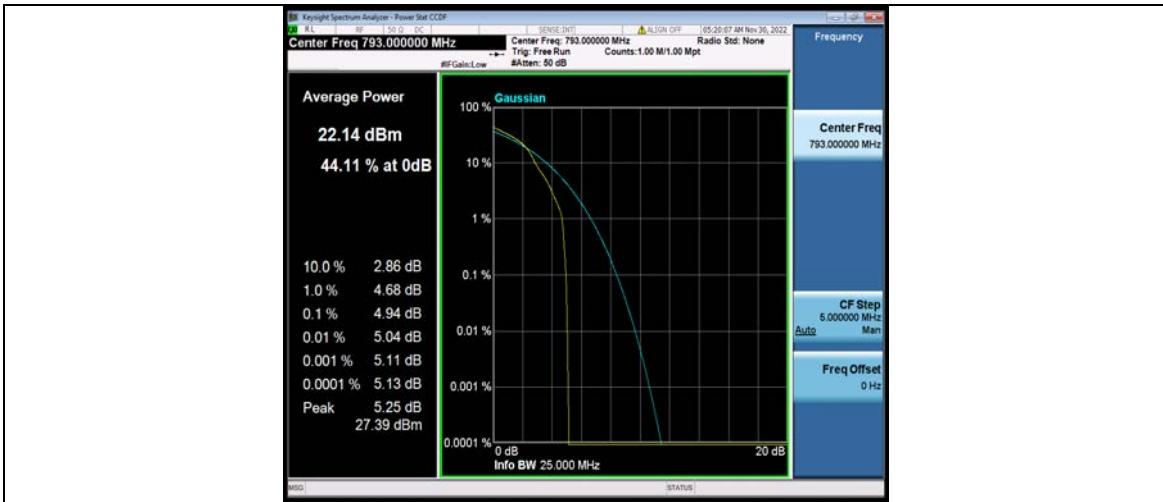

Band14-10MHz-16QAM-23330-50RB#0

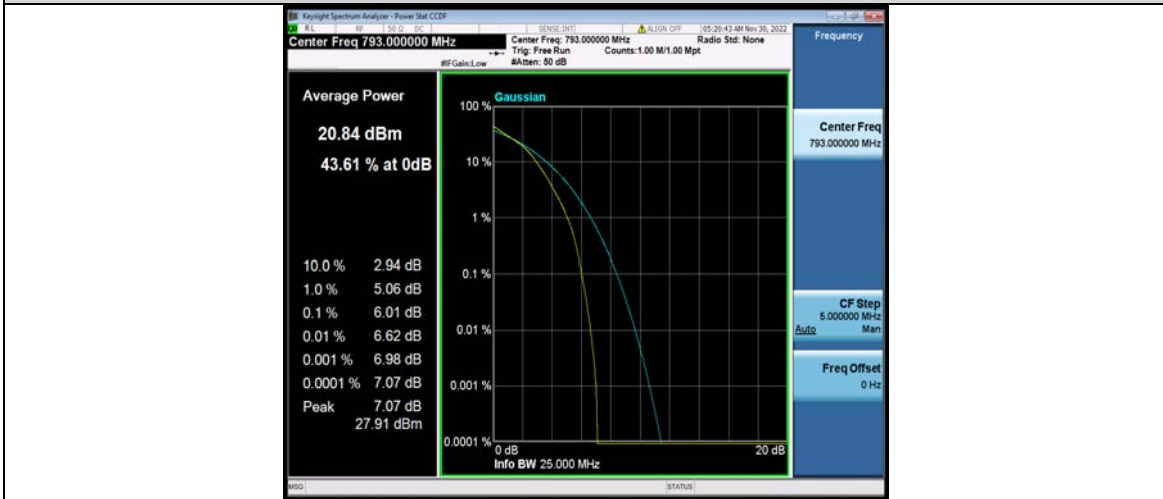

Band14-10MHz-64QAM-23330-1RB#0

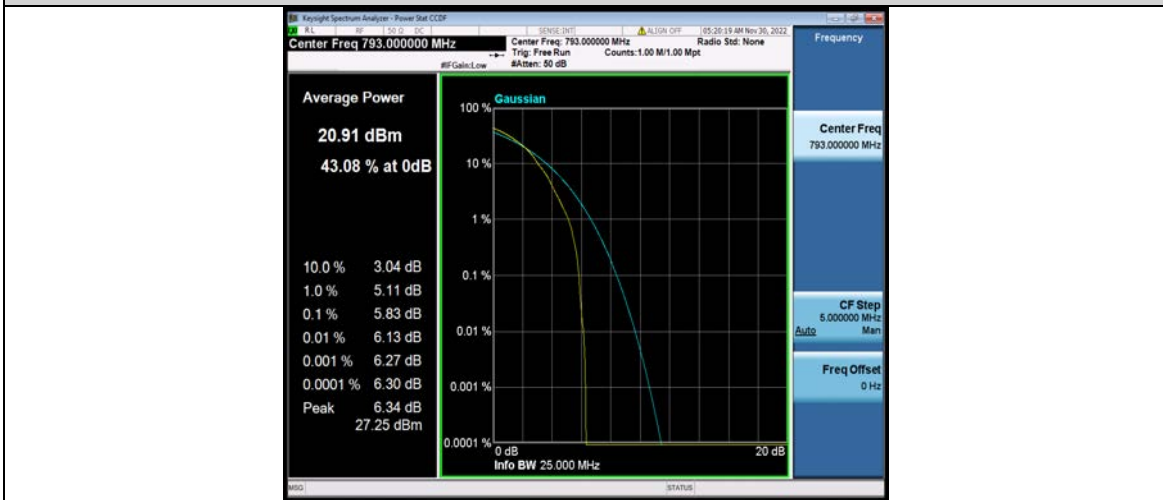

Band14-10MHz-64QAM-23330-50RB#0



Test Report No.: W7L-P23100014RF09

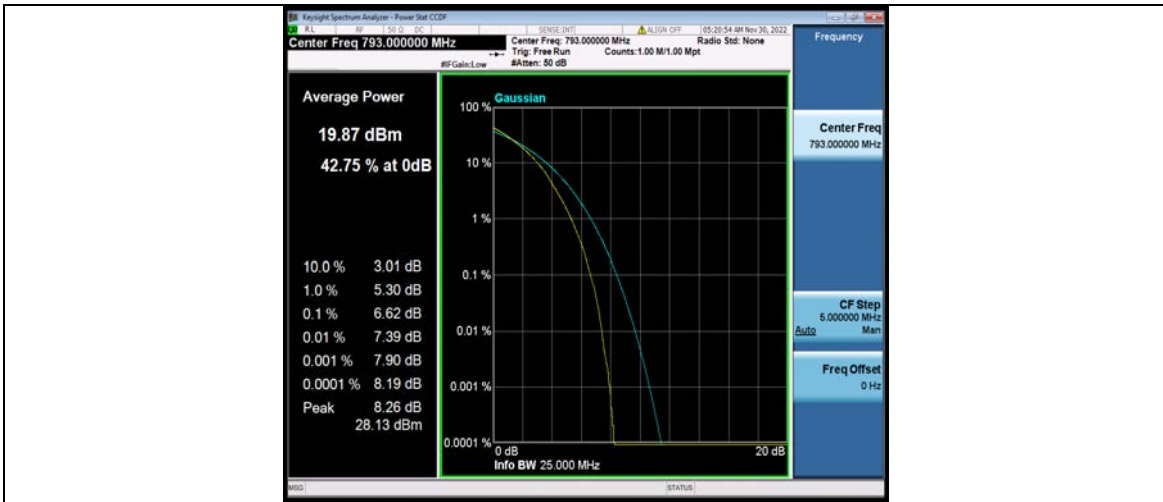



Test Report No.: W7L-P23100014RF09

26DB BANDWIDTH AND OCCUPIED BANDWIDTH

Test Result

Band	Bandwidth	Modulation	Channel	RB Configuration	Occupied Bandwidth (MHz)	26dB Bandwidth (MHz)	Verdict
Band14	5MHz	QPSK	23305	25RB#0	4.4925	4.847	PASS
Band14	5MHz	QPSK	23330	25RB#0	4.5046	4.889	PASS
Band14	5MHz	QPSK	23355	25RB#0	4.4962	4.866	PASS
Band14	5MHz	16QAM	23305	25RB#0	4.4991	4.844	PASS
Band14	5MHz	16QAM	23330	25RB#0	4.5098	4.819	PASS
Band14	5MHz	16QAM	23355	25RB#0	4.5016	4.873	PASS
Band14	5MHz	64QAM	23305	25RB#0	4.4901	4.847	PASS
Band14	5MHz	64QAM	23330	25RB#0	4.4971	4.848	PASS
Band14	5MHz	64QAM	23355	25RB#0	4.5011	4.863	PASS
Band14	10MHz	QPSK	23330	50RB#0	8.9912	9.549	PASS
Band14	10MHz	16QAM	23330	50RB#0	8.9765	9.493	PASS
Band14	10MHz	64QAM	23330	50RB#0	8.9725	9.504	PASS



Test Graphs

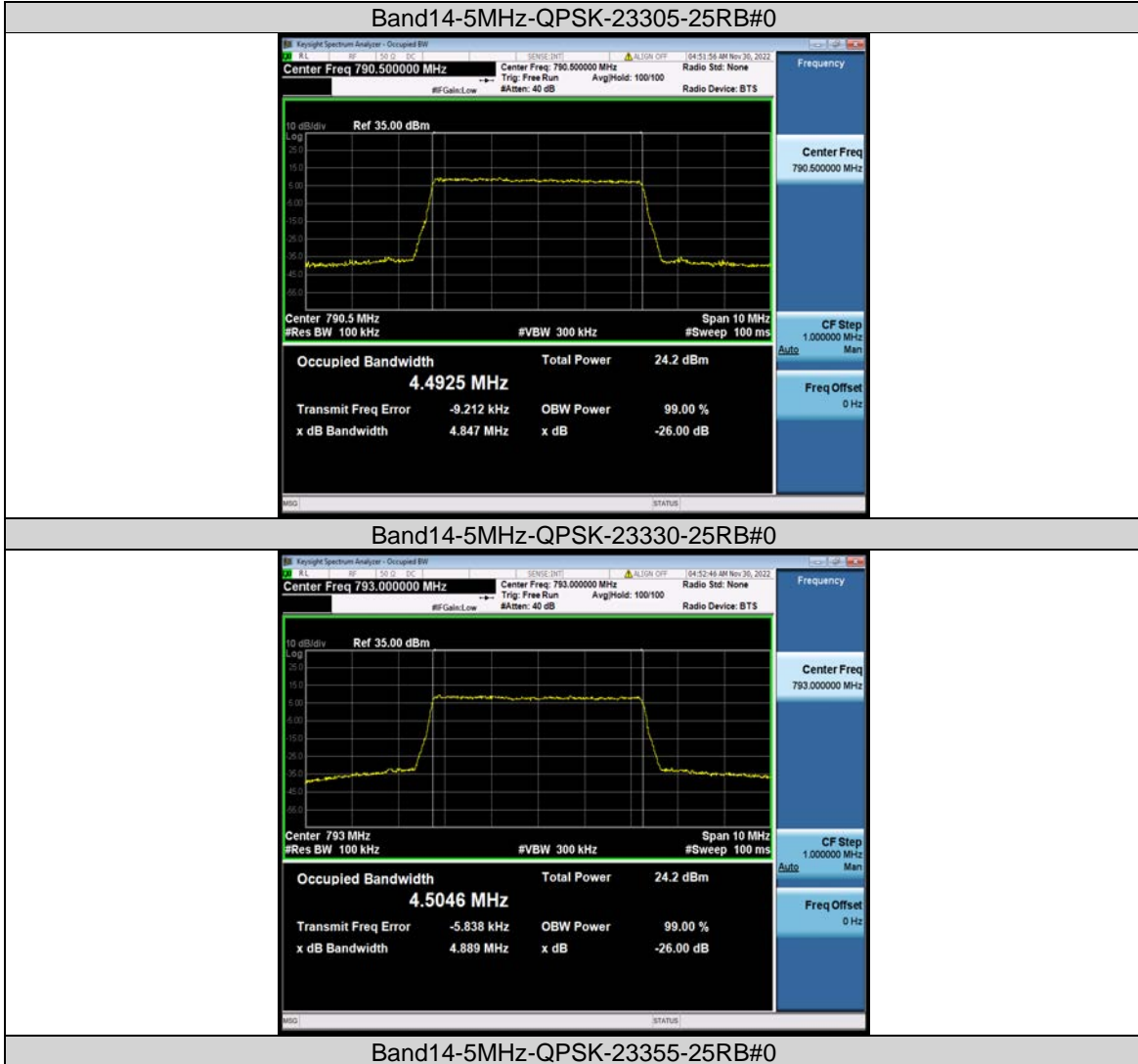



Test Report No.: W7L-P23100014RF09



Band14-5MHz-16QAM-23305-25RB#0



Band14-5MHz-16QAM-23330-25RB#0



Band14-5MHz-16QAM-23355-25RB#0



Test Report No.: W7L-P23100014RF09



Band14-5MHz-64QAM-23305-25RB#0



Band14-5MHz-64QAM-23330-25RB#0

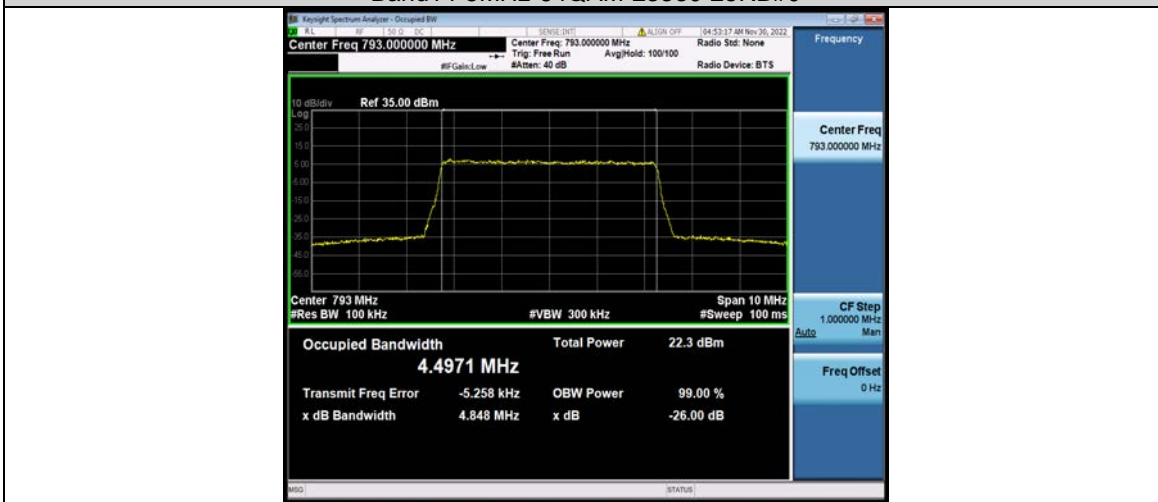

Band14-5MHz-64QAM-23355-25RB#0



Test Report No.: W7L-P23100014RF09



Band14-10MHz-QPSK-23330-50RB#0

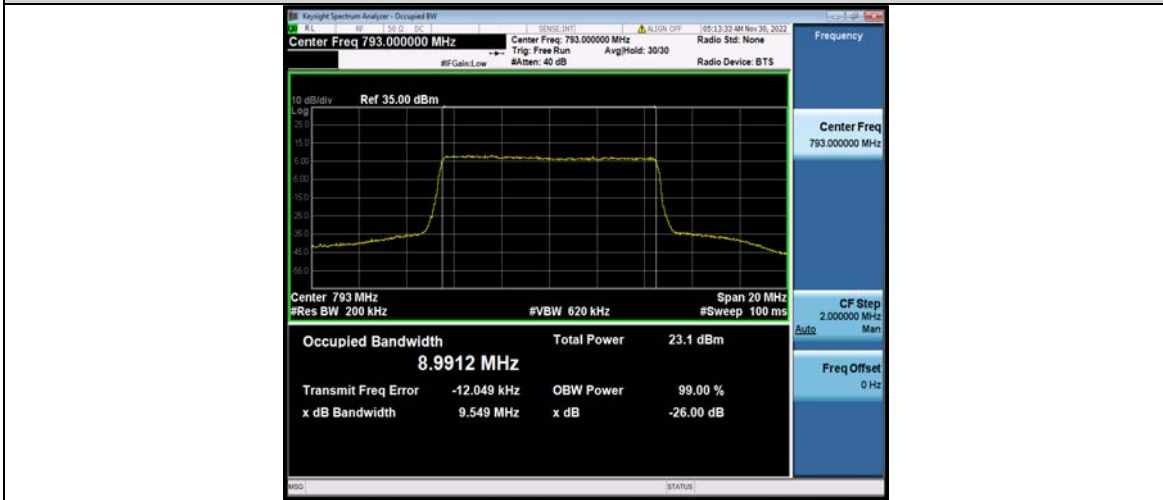

Band14-10MHz-16QAM-23330-50RB#0

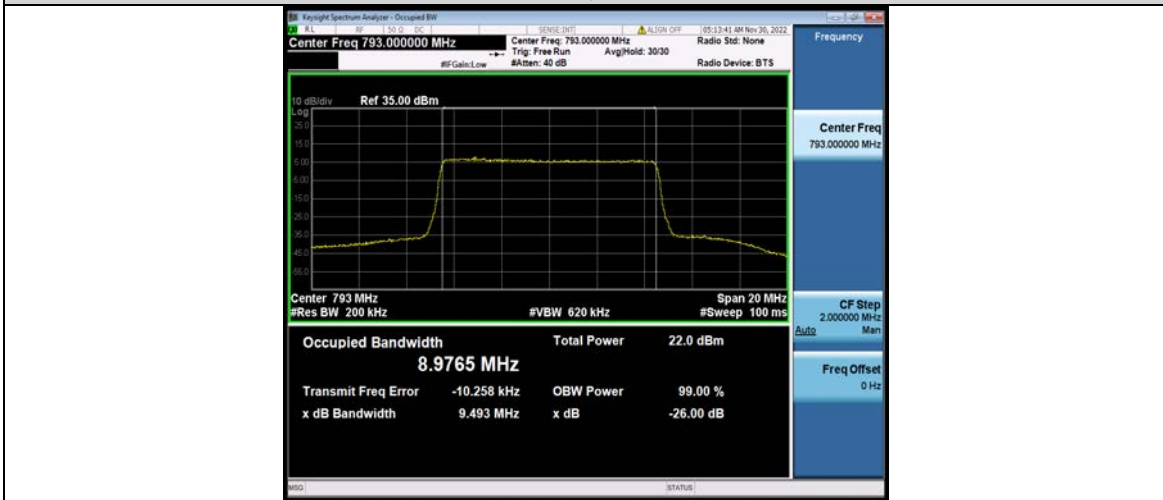

Band14-10MHz-64QAM-23330-50RB#0



Test Report No.: W7L-P23100014RF09





Test Report No.: W7L-P23100014RF09

BAND EDGE

Test Result

Band	Bandwidth	Modulation	Channel	RB Configuration	Result(dBm)	Verdict
Band14	5MHz	QPSK	23305	1RB#0	-18.44	PASS
Band14	5MHz	QPSK	23305	25RB#0	-27.39	PASS
Band14	5MHz	QPSK	23355	1RB#24	-18.95	PASS
Band14	5MHz	QPSK	23355	25RB#0	-27.69	PASS
Band14	5MHz	16QAM	23305	1RB#0	-19.92	PASS
Band14	5MHz	16QAM	23305	25RB#0	-28.31	PASS
Band14	5MHz	16QAM	23355	1RB#24	-19.66	PASS
Band14	5MHz	16QAM	23355	25RB#0	-29.13	PASS
Band14	5MHz	64QAM	23305	1RB#0	-21.22	PASS
Band14	5MHz	64QAM	23305	25RB#0	-30.43	PASS
Band14	5MHz	64QAM	23355	1RB#24	-21.84	PASS
Band14	5MHz	64QAM	23355	25RB#0	-30.44	PASS
Band14	10MHz	QPSK	23330	1RB#0	-26.43,-47.31	PASS
Band14	10MHz	QPSK	23330	1RB#49	-45.58,-29.23	PASS
Band14	10MHz	QPSK	23330	50RB#0	-29.99,-31.99	PASS
Band14	10MHz	16QAM	23330	1RB#0	-28.00,-47.72	PASS
Band14	10MHz	16QAM	23330	1RB#49	-47.24,-29.82	PASS
Band14	10MHz	16QAM	23330	50RB#0	-31.63,-33.85	PASS
Band14	10MHz	64QAM	23330	1RB#0	-28.42,-47.71	PASS
Band14	10MHz	64QAM	23330	1RB#49	-47.82,-32.00	PASS
Band14	10MHz	64QAM	23330	50RB#0	-33.89,-35.92	PASS



Test Graphs

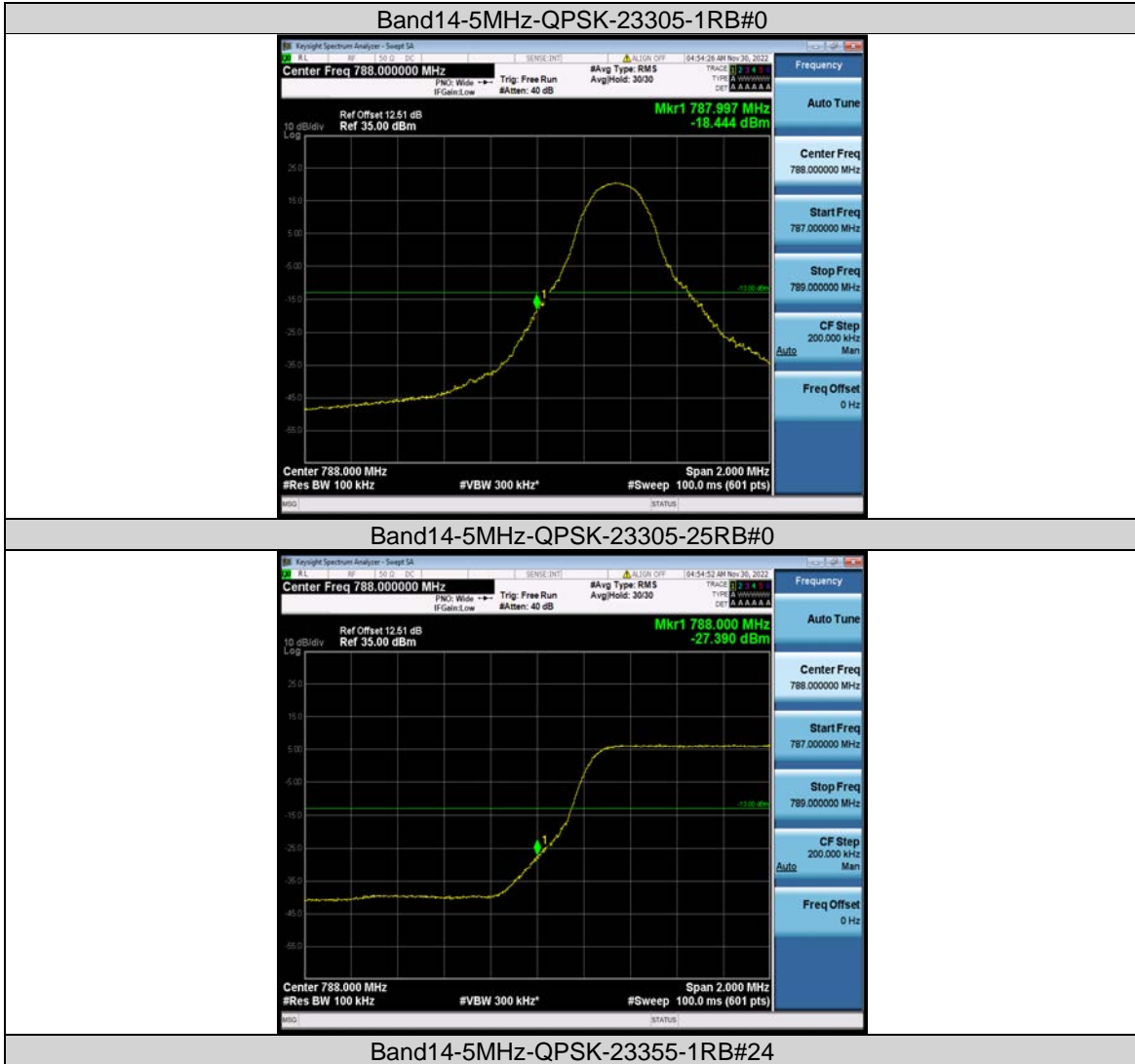



Test Report No.: W7L-P23100014RF09



Band14-5MHz-QPSK-23355-25RB#0



Band14-5MHz-16QAM-23305-1RB#0



Band14-5MHz-16QAM-23305-25RB#0



Test Report No.: W7L-P23100014RF09



Band14-5MHz-16QAM-23355-1RB#24

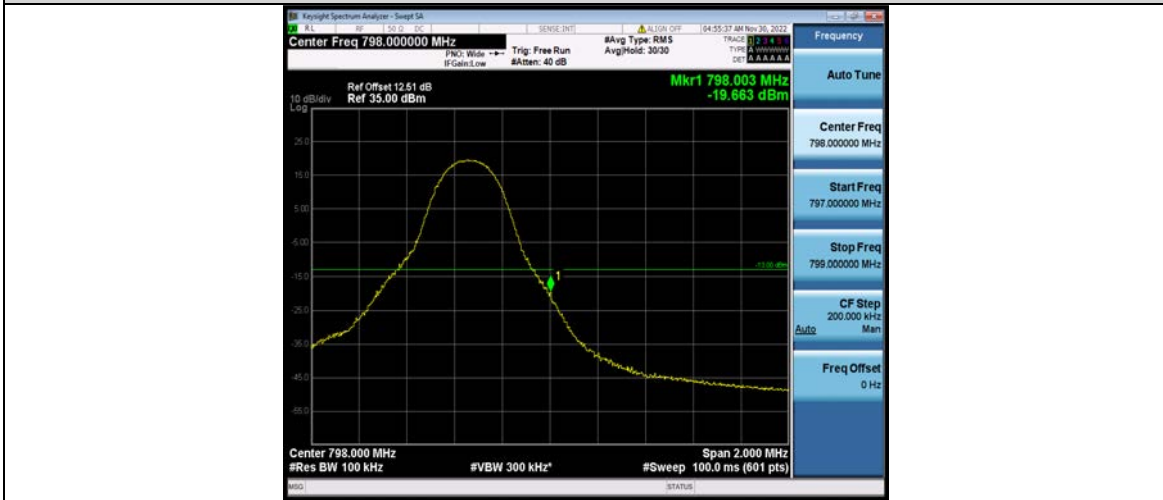

Band14-5MHz-16QAM-23355-25RB#0



Band14-5MHz-64QAM-23305-1RB#0



Test Report No.: W7L-P23100014RF09

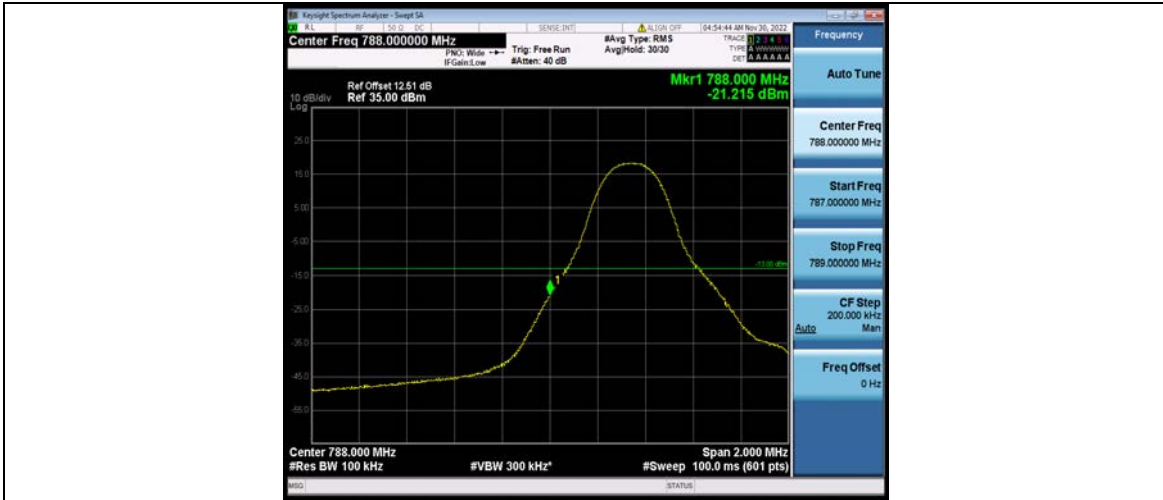

Band14-5MHz-64QAM-23305-25RB#0



Band14-5MHz-64QAM-23355-1RB#24



Band14-5MHz-64QAM-23355-25RB#0



Test Report No.: W7L-P23100014RF09



Band14-10MHz-QPSK-23330-1RB#0

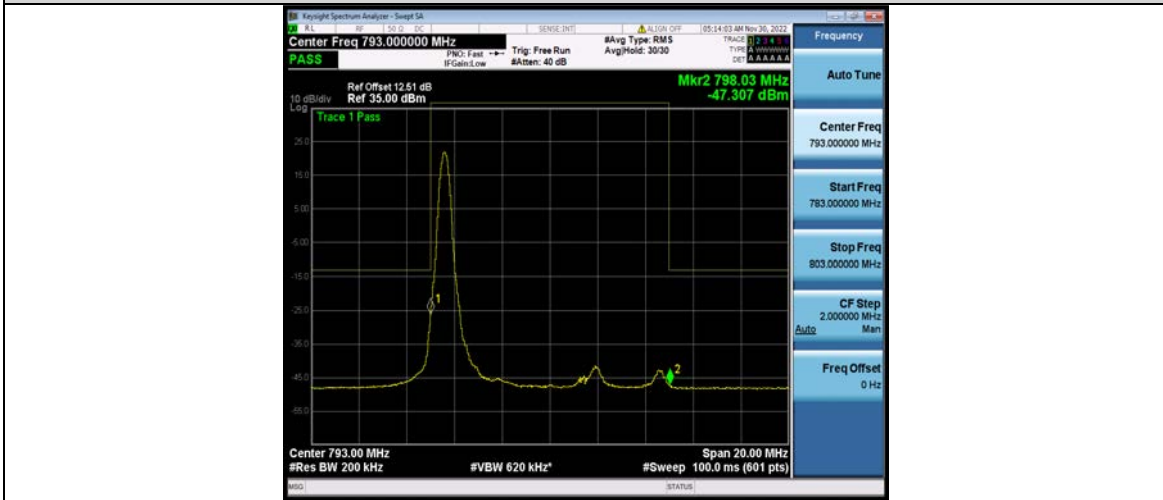

Band14-10MHz-QPSK-23330-1RB#49

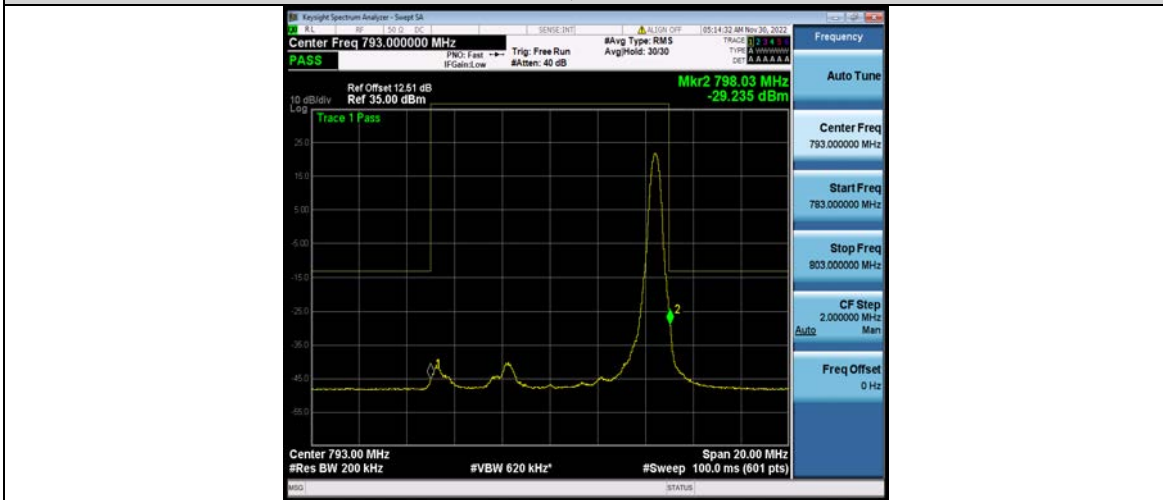

Band14-10MHz-QPSK-23330-50RB#0



Test Report No.: W7L-P23100014RF09



Band14-10MHz-16QAM-23330-1RB#0

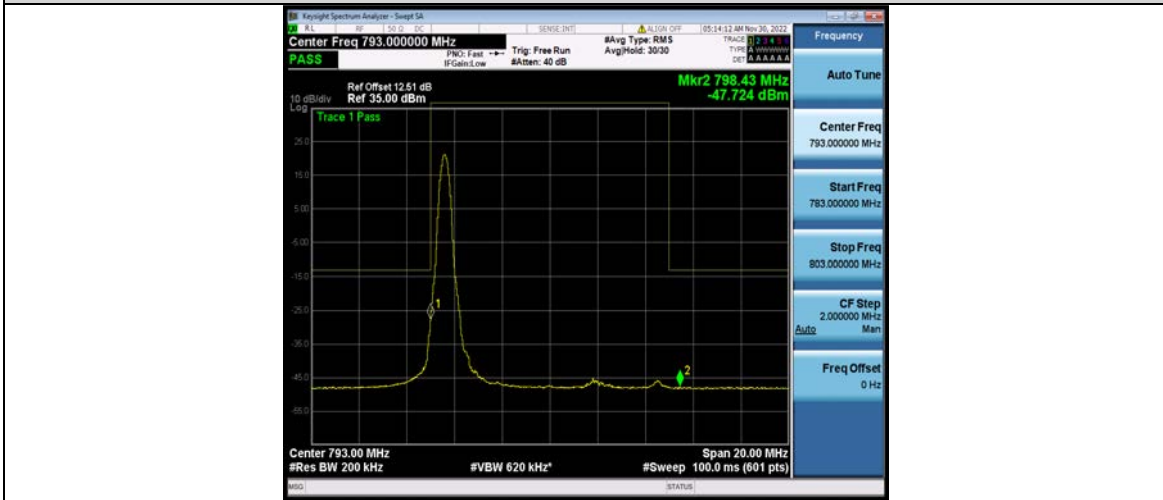

Band14-10MHz-16QAM-23330-1RB#49

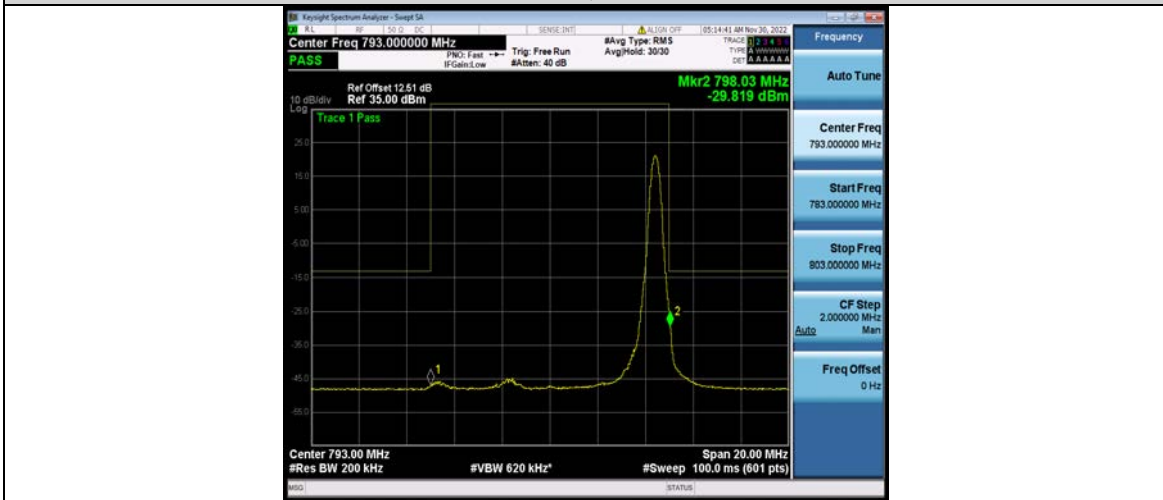

Band14-10MHz-16QAM-23330-50RB#0



Test Report No.: W7L-P23100014RF09



Band14-10MHz-64QAM-23330-1RB#0

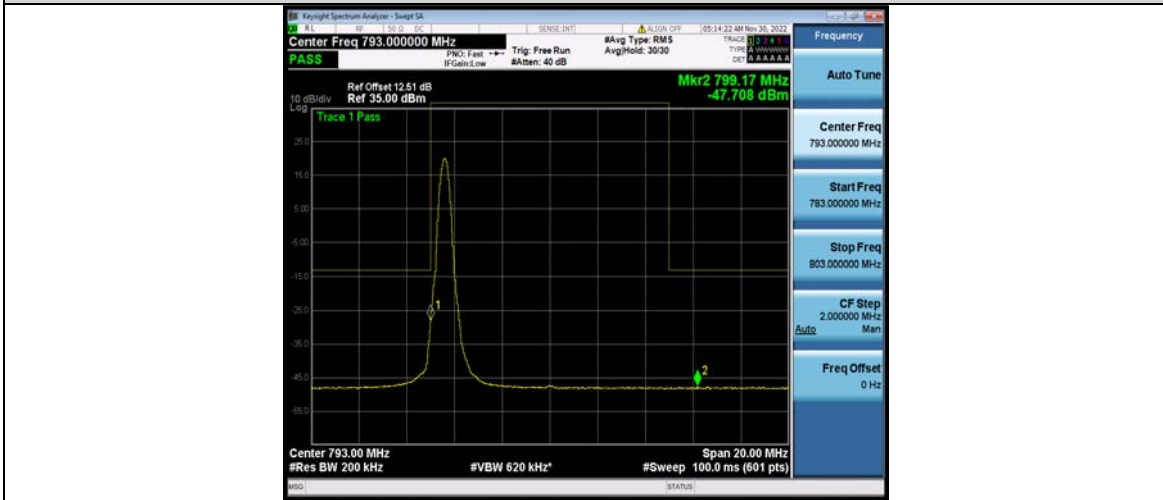

Band14-10MHz-64QAM-23330-1RB#49

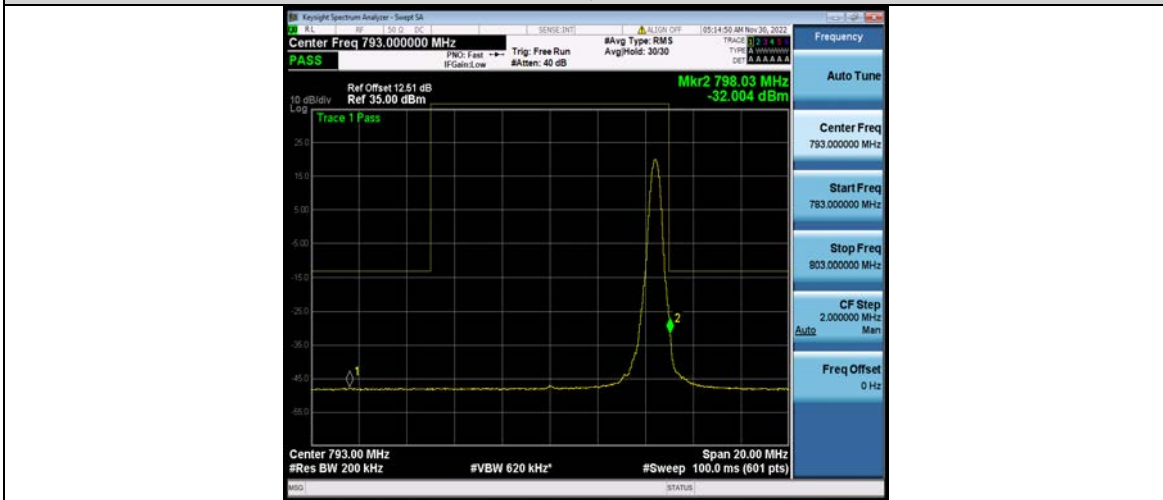

Band14-10MHz-64QAM-23330-50RB#0



Test Report No.: W7L-P23100014RF09





CONDUCTED SPURIOUS EMISSION

Test Result

Band	Bandwidth	Modulation	Channel	RB Configuration	Frequency Range	Result (dBm)	Verdict
Band14	5MHz	QPSK	23305	1RB#0	Range1:30~1000MHz	-39.74	PASS
Band14	5MHz	QPSK	23305	1RB#0	Range4:769~775MHz	-52.51	PASS
Band14	5MHz	QPSK	23305	1RB#0	Range5:799~805MHz	-51.88	PASS
Band14	5MHz	QPSK	23305	1RB#0	Range2:1000~10000MHz	-34.03	PASS
Band14	5MHz	QPSK	23305	1RB#0	Range3:1559~1610MHz	-48.79	PASS
Band14	5MHz	QPSK	23330	1RB#0	Range1:30~1000MHz	-39.98	PASS
Band14	5MHz	QPSK	23330	1RB#0	Range4:769~775MHz	-52.46	PASS
Band14	5MHz	QPSK	23330	1RB#0	Range5:799~805MHz	-52.09	PASS
Band14	5MHz	QPSK	23330	1RB#0	Range2:1000~10000MHz	-34.42	PASS
Band14	5MHz	QPSK	23330	1RB#0	Range3:1559~1610MHz	-48.62	PASS
Band14	5MHz	QPSK	23355	1RB#0	Range1:30~1000MHz	-39.41	PASS
Band14	5MHz	QPSK	23355	1RB#0	Range4:769~775MHz	-51.63	PASS
Band14	5MHz	QPSK	23355	1RB#0	Range5:799~805MHz	-52.69	PASS
Band14	5MHz	QPSK	23355	1RB#0	Range2:1000~10000MHz	-34.51	PASS
Band14	5MHz	QPSK	23355	1RB#0	Range3:1559~1610MHz	-48.36	PASS
Band14	5MHz	16QAM	23305	1RB#0	Range1:30~1000MHz	-40.39	PASS
Band14	5MHz	16QAM	23305	1RB#0	Range4:769~775MHz	-52.29	PASS
Band14	5MHz	16QAM	23305	1RB#0	Range5:799~805MHz	-51.63	PASS
Band14	5MHz	16QAM	23305	1RB#0	Range2:1000~10000MHz	-34.11	PASS
Band14	5MHz	16QAM	23305	1RB#0	Range3:1559~1610MHz	-49.51	PASS
Band14	5MHz	16QAM	23330	1RB#0	Range1:30~1000MHz	-40.84	PASS
Band14	5MHz	16QAM	23330	1RB#0	Range4:769~775MHz	-52.11	PASS
Band14	5MHz	16QAM	23330	1RB#0	Range5:799~805MHz	-52.09	PASS
Band14	5MHz	16QAM	23330	1RB#0	Range2:1000~10000MHz	-33.77	PASS
Band14	5MHz	16QAM	23330	1RB#0	Range3:1559~1610MHz	-49.41	PASS
Band14	5MHz	16QAM	23355	1RB#0	Range1:30~1000MHz	-40.19	PASS
Band14	5MHz	16QAM	23355	1RB#0	Range4:769~775MHz	-52.32	PASS
Band14	5MHz	16QAM	23355	1RB#0	Range5:799~805MHz	-51.07	PASS
Band14	5MHz	16QAM	23355	1RB#0	Range2:1000~10000MHz	-34.35	PASS
Band14	5MHz	16QAM	23355	1RB#0	Range3:1559~1610MHz	-49.28	PASS
Band14	5MHz	64QAM	23305	1RB#0	Range1:30~1000MHz	-39.62	PASS
Band14	5MHz	64QAM	23305	1RB#0	Range4:769~775MHz	-53.19	PASS
Band14	5MHz	64QAM	23305	1RB#0	Range5:799~805MHz	-51.76	PASS
Band14	5MHz	64QAM	23305	1RB#0	Range2:1000~10000MHz	-34.07	PASS
Band14	5MHz	64QAM	23305	1RB#0	Range3:1559~1610MHz	-51.38	PASS
Band14	5MHz	64QAM	23330	1RB#0	Range1:30~1000MHz	-39.77	PASS
Band14	5MHz	64QAM	23330	1RB#0	Range4:769~775MHz	-52.31	PASS
Band14	5MHz	64QAM	23330	1RB#0	Range5:799~805MHz	-51.87	PASS
Band14	5MHz	64QAM	23330	1RB#0	Range2:1000~10000MHz	-34	PASS
Band14	5MHz	64QAM	23330	1RB#0	Range3:1559~1610MHz	-51.33	PASS
Band14	5MHz	64QAM	23355	1RB#0	Range1:30~1000MHz	-40.09	PASS
Band14	5MHz	64QAM	23355	1RB#0	Range4:769~775MHz	-52.58	PASS
Band14	5MHz	64QAM	23355	1RB#0	Range5:799~805MHz	-51.44	PASS
Band14	5MHz	64QAM	23355	1RB#0	Range2:1000~10000MHz	-34.33	PASS



Test Report No.: W7L-P23100014RF09

Band14	5MHz	64QAM	23355	1RB#0	Range3:1559~1610MHz	-50.54	PASS
Band14	10MHz	QPSK	23330	1RB#0	Range1:30~1000MHz	-40.28	PASS
Band14	10MHz	QPSK	23330	1RB#0	Range4:769~775MHz	-52.32	PASS
Band14	10MHz	QPSK	23330	1RB#0	Range5:799~805MHz	-51.61	PASS
Band14	10MHz	QPSK	23330	1RB#0	Range2:1000~1000MHz	-33.98	PASS
Band14	10MHz	QPSK	23330	1RB#0	Range3:1559~1610MHz	-48.95	PASS
Band14	10MHz	16QAM	23330	1RB#0	Range1:30~1000MHz	-38.7	PASS
Band14	10MHz	16QAM	23330	1RB#0	Range4:769~775MHz	-51.86	PASS
Band14	10MHz	16QAM	23330	1RB#0	Range5:799~805MHz	-51.99	PASS
Band14	10MHz	16QAM	23330	1RB#0	Range2:1000~1000MHz	-33.77	PASS
Band14	10MHz	16QAM	23330	1RB#0	Range3:1559~1610MHz	-49.33	PASS
Band14	10MHz	64QAM	23330	1RB#0	Range1:30~1000MHz	-40.31	PASS
Band14	10MHz	64QAM	23330	1RB#0	Range4:769~775MHz	-51.62	PASS
Band14	10MHz	64QAM	23330	1RB#0	Range5:799~805MHz	-52.4	PASS
Band14	10MHz	64QAM	23330	1RB#0	Range2:1000~1000MHz	-35.26	PASS
Band14	10MHz	64QAM	23330	1RB#0	Range3:1559~1610MHz	-51.34	PASS

Test Graphs

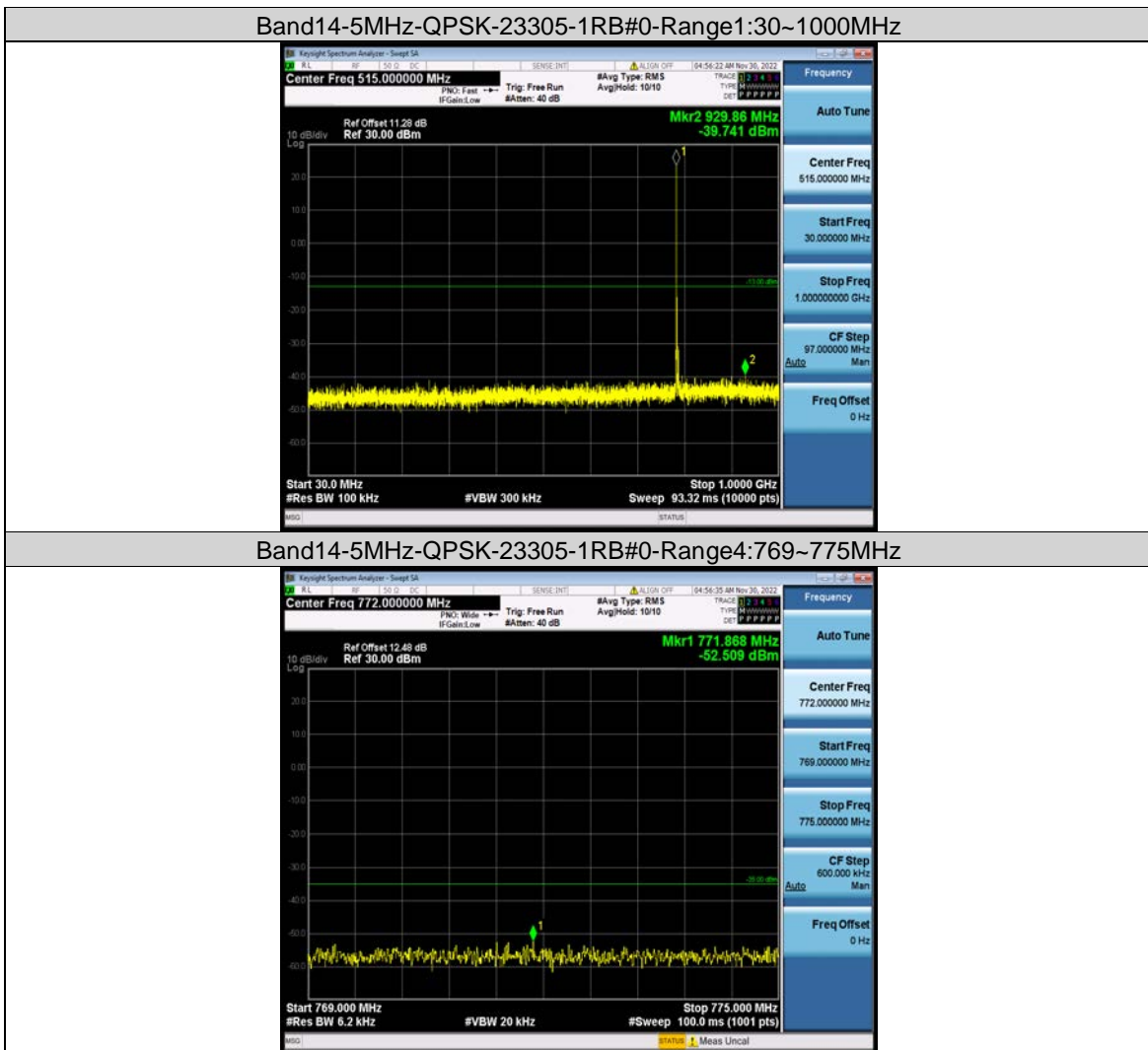



Test Report No.: W7L-P23100014RF09

Band14-5MHz-QPSK-23305-1RB#0-Range5:799~805MHz

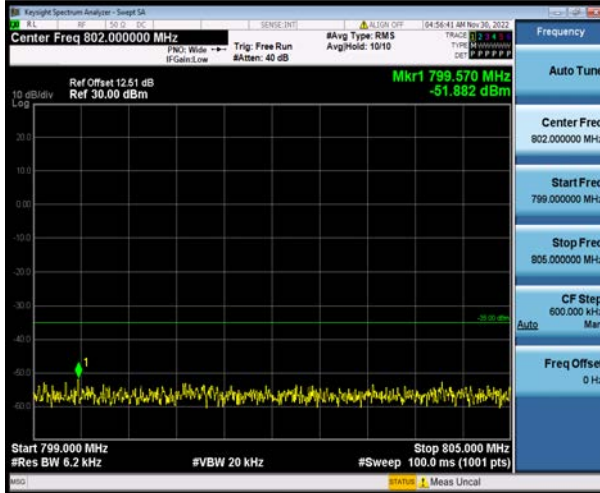

Band14-5MHz-QPSK-23305-1RB#0-Range2:1000~10000MHz

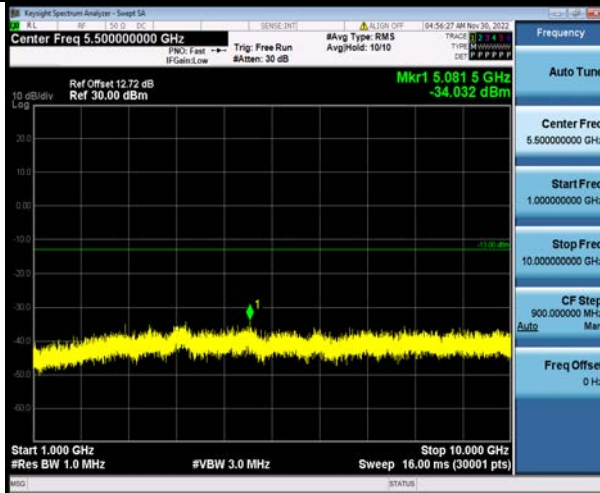

Band14-5MHz-QPSK-23305-1RB#0-Range3:1559~1610MHz

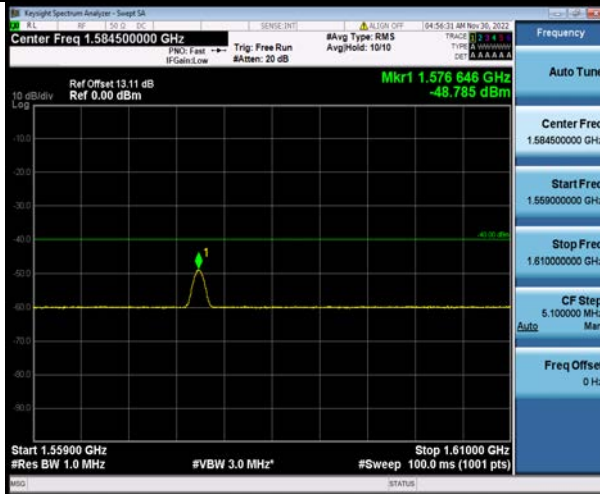

Band14-5MHz-QPSK-23330-1RB#0-Range1:30~1000MHz



Test Report No.: W7L-P23100014RF09

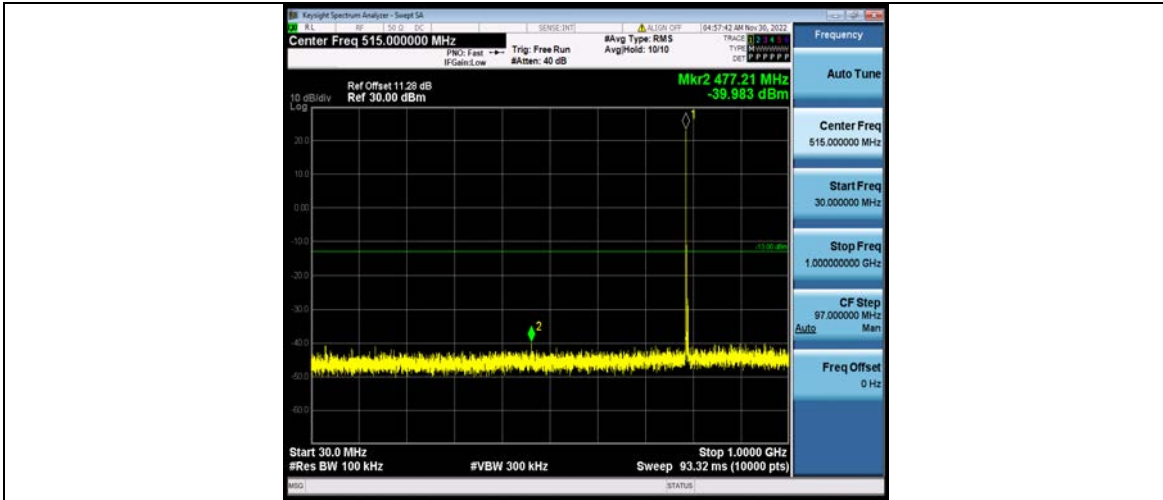

Band14-5MHz-QPSK-23330-1RB#0-Range4:769~775MHz

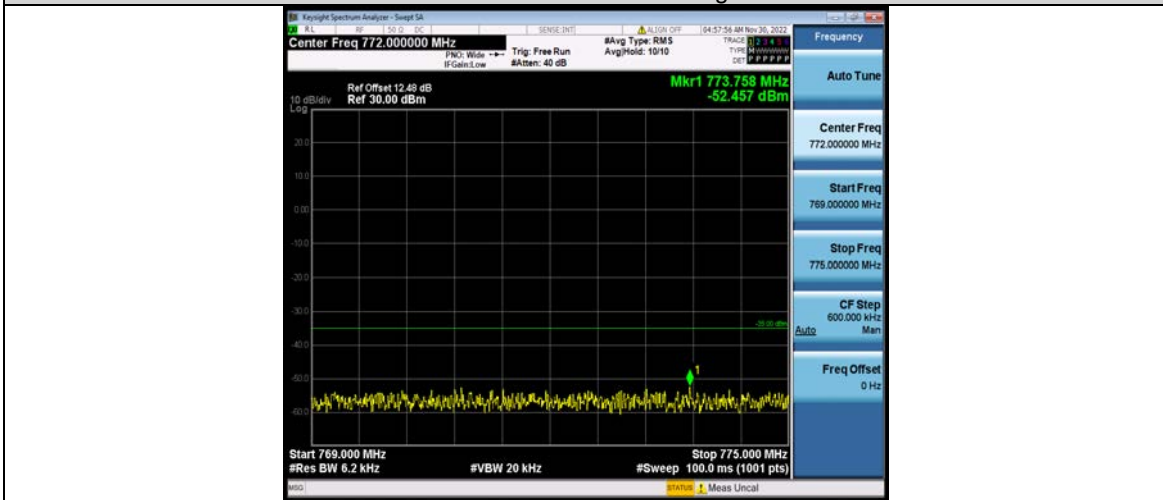

Band14-5MHz-QPSK-23330-1RB#0-Range5:799~805MHz

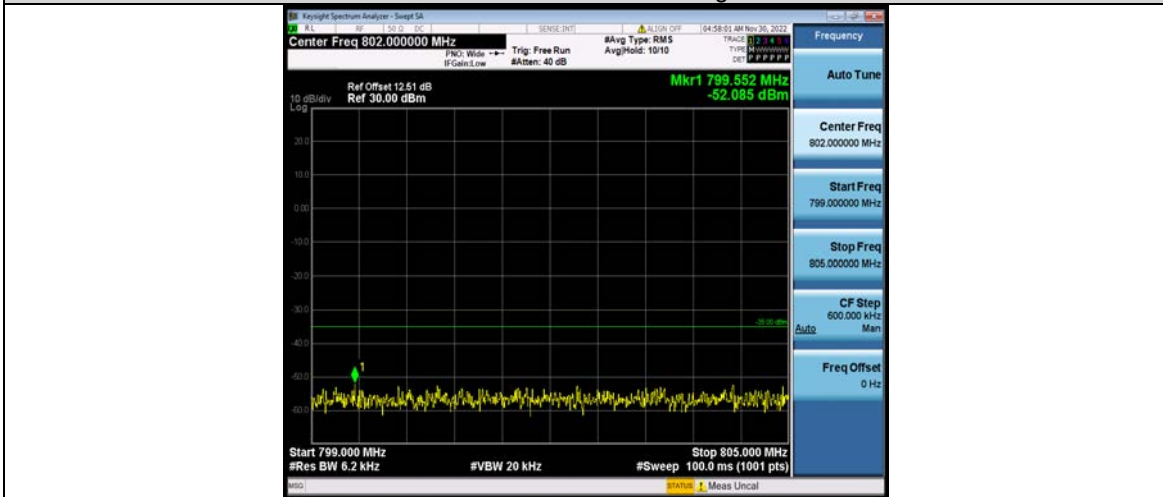

Band14-5MHz-QPSK-23330-1RB#0-Range2:1000~10000MHz



Test Report No.: W7L-P23100014RF09

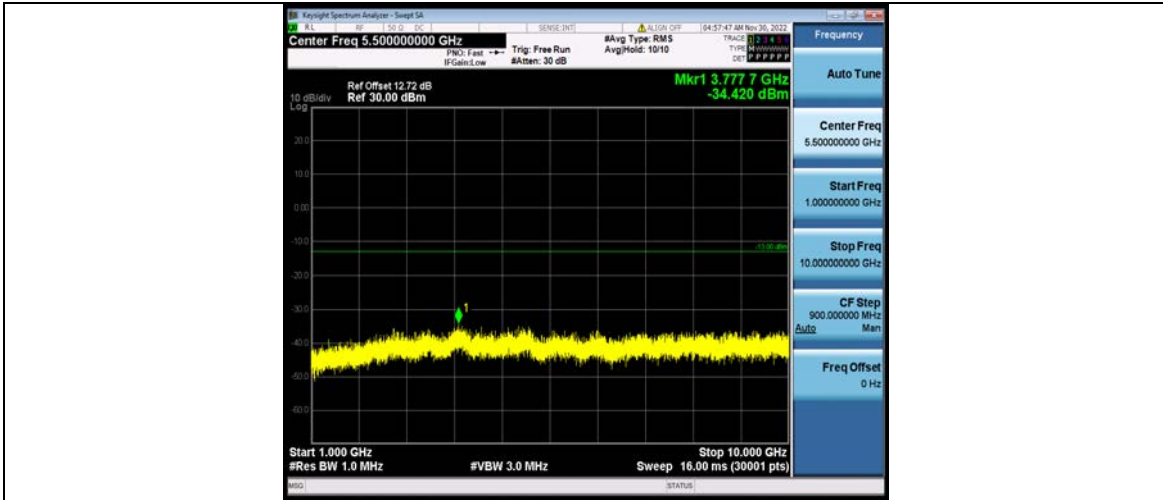

Band14-5MHz-QPSK-23330-1RB#0-Range3:1559~1610MHz

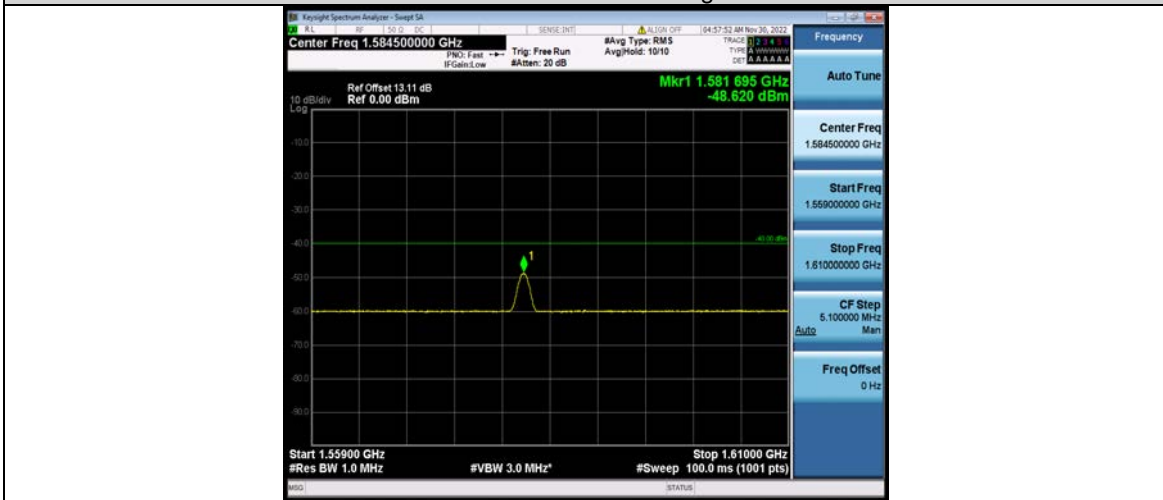

Band14-5MHz-QPSK-23355-1RB#0-Range1:30~1000MHz

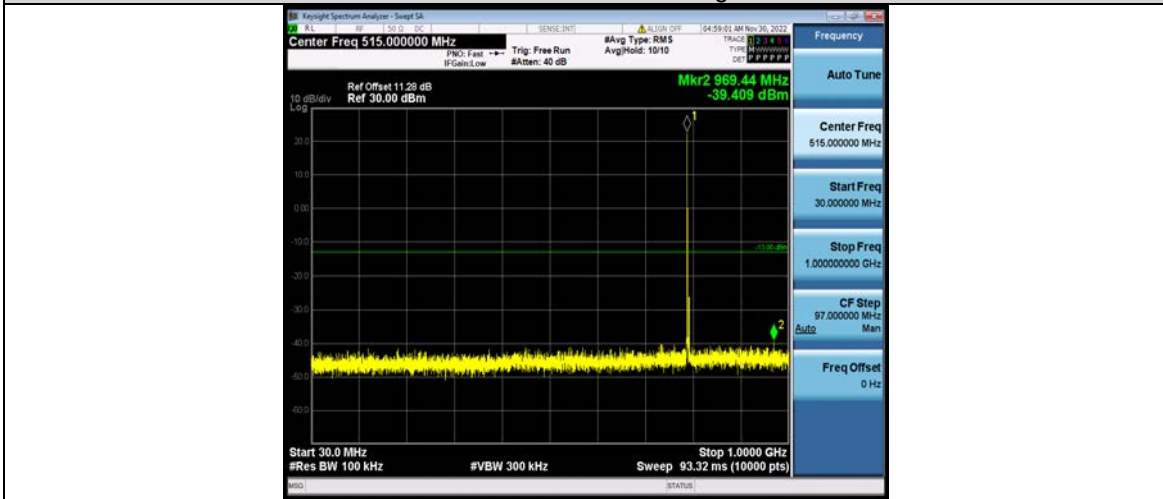

Band14-5MHz-QPSK-23355-1RB#0-Range4:769~775MHz



Test Report No.: W7L-P23100014RF09

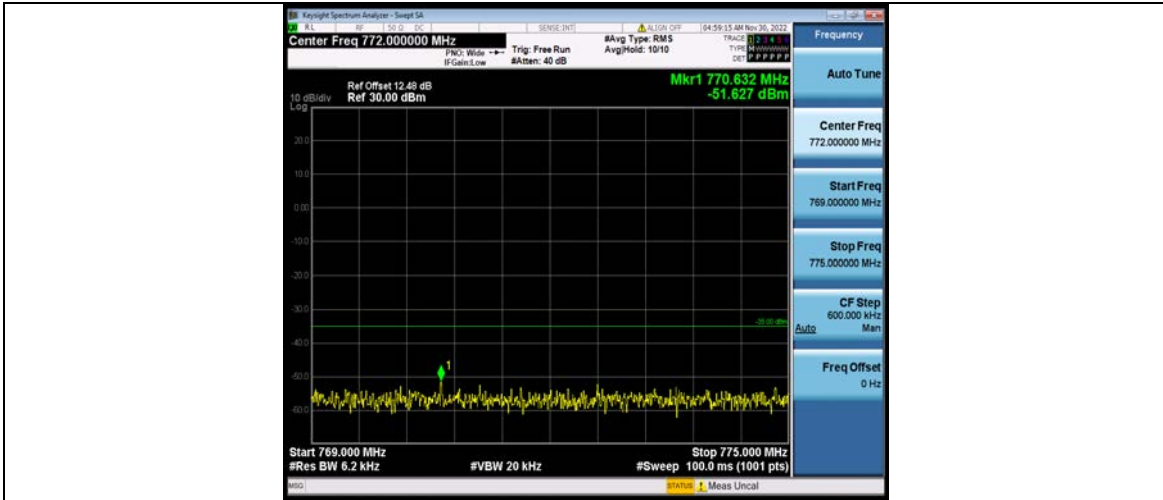

Band14-5MHz-QPSK-23355-1RB#0-Range5:799~805MHz

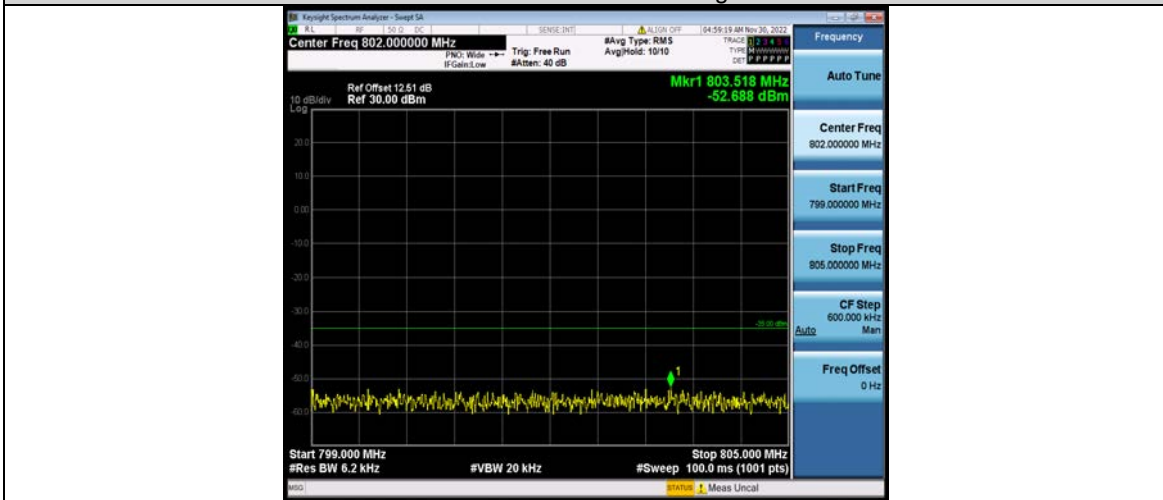

Band14-5MHz-QPSK-23355-1RB#0-Range2:1000~10000MHz

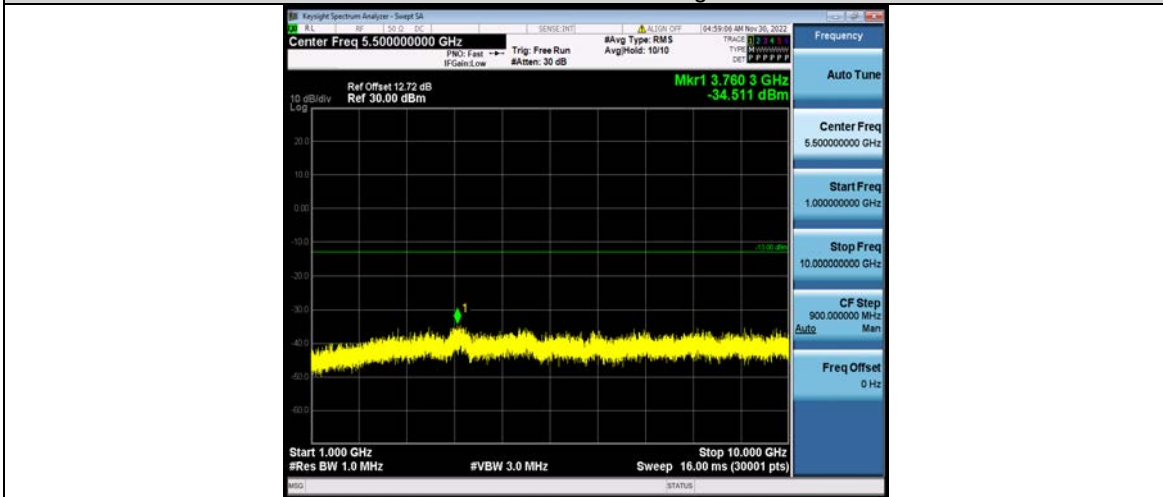

Band14-5MHz-QPSK-23355-1RB#0-Range3:1559~1610MHz



Test Report No.: W7L-P23100014RF09

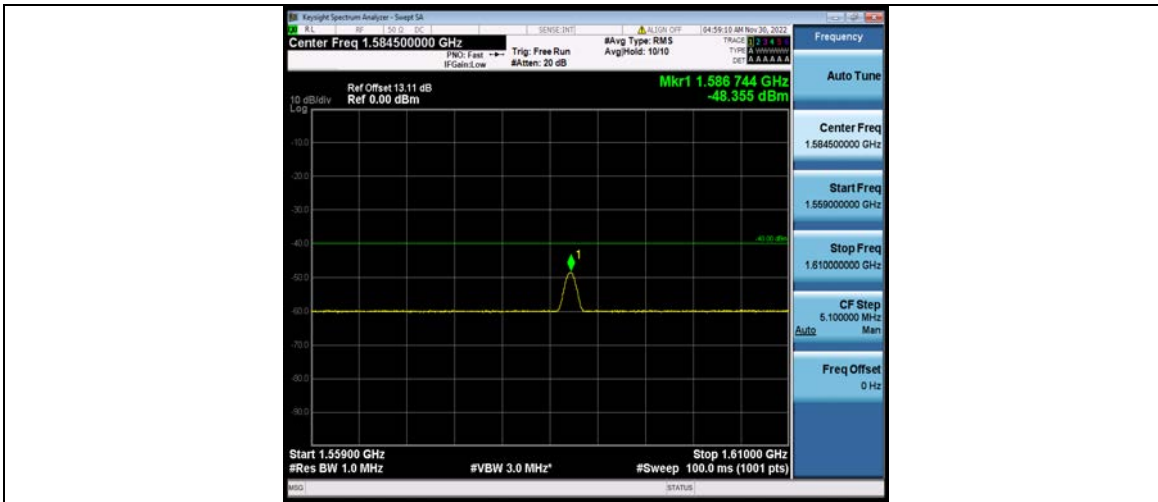

Band14-5MHz-16QAM-23305-1RB#0-Range1:30~1000MHz

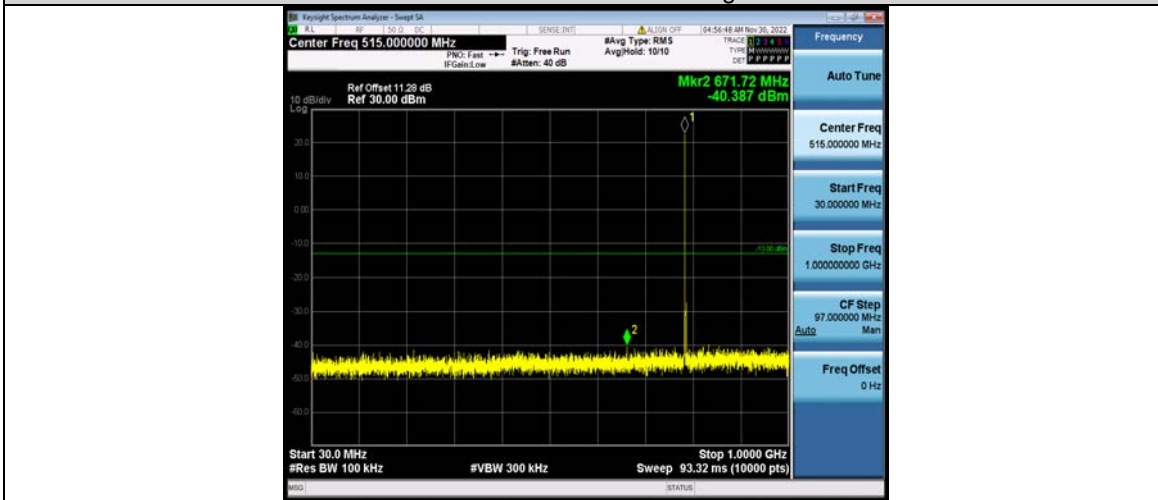

Band14-5MHz-16QAM-23305-1RB#0-Range4:769~775MHz

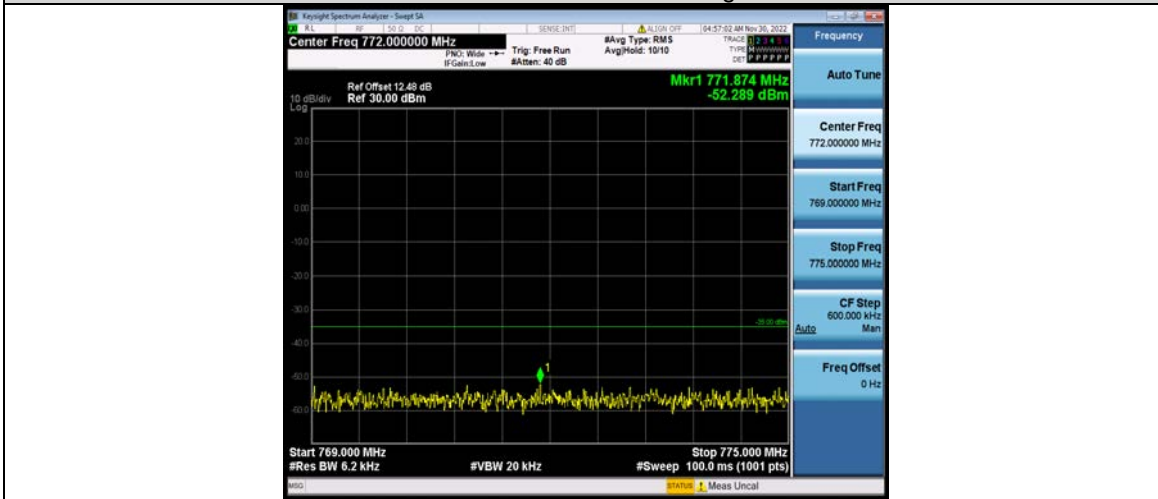

Band14-5MHz-16QAM-23305-1RB#0-Range5:799~805MHz



Test Report No.: W7L-P23100014RF09

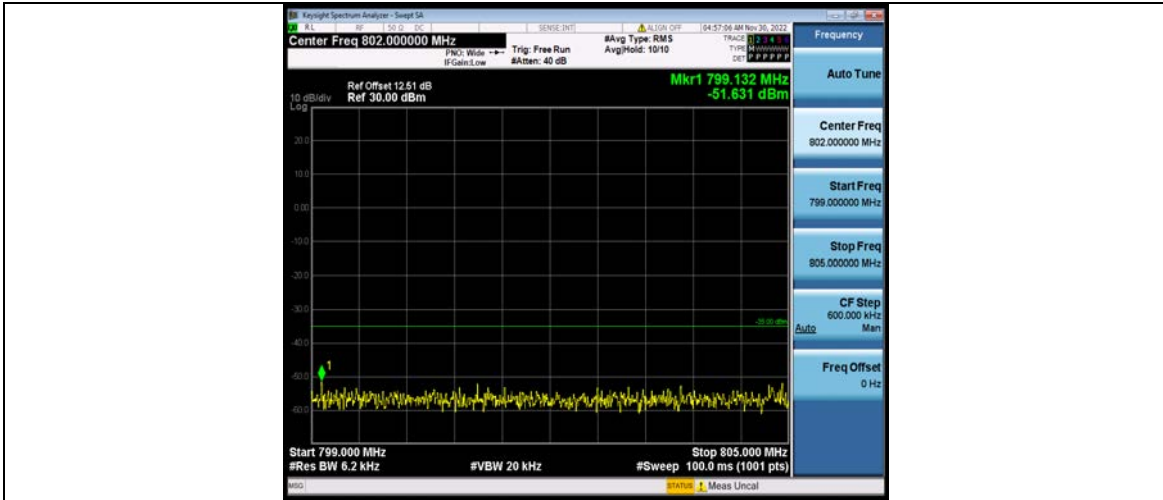

Band14-5MHz-16QAM-23305-1RB#0-Range2:1000~1000MHz

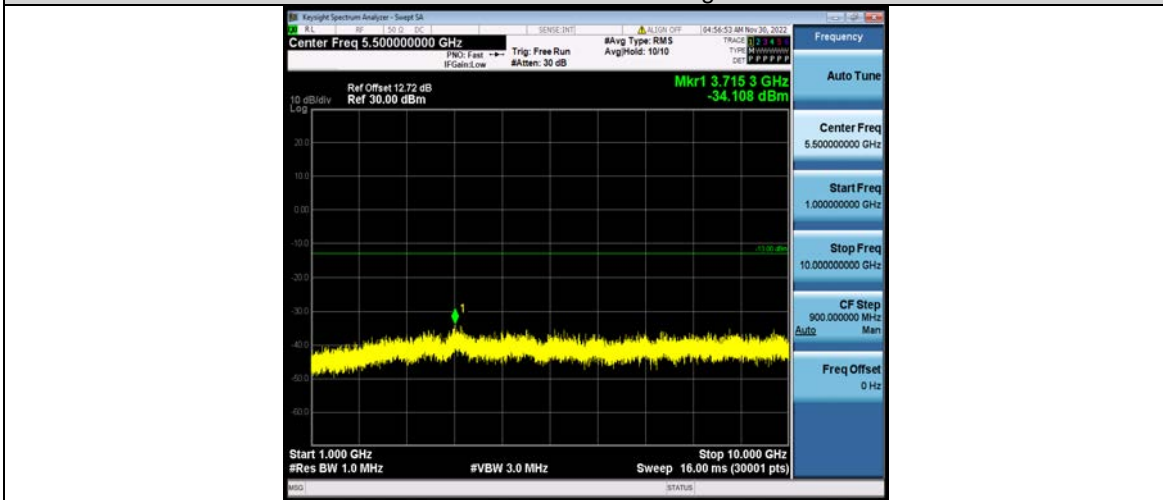

Band14-5MHz-16QAM-23305-1RB#0-Range3:1559~1610MHz

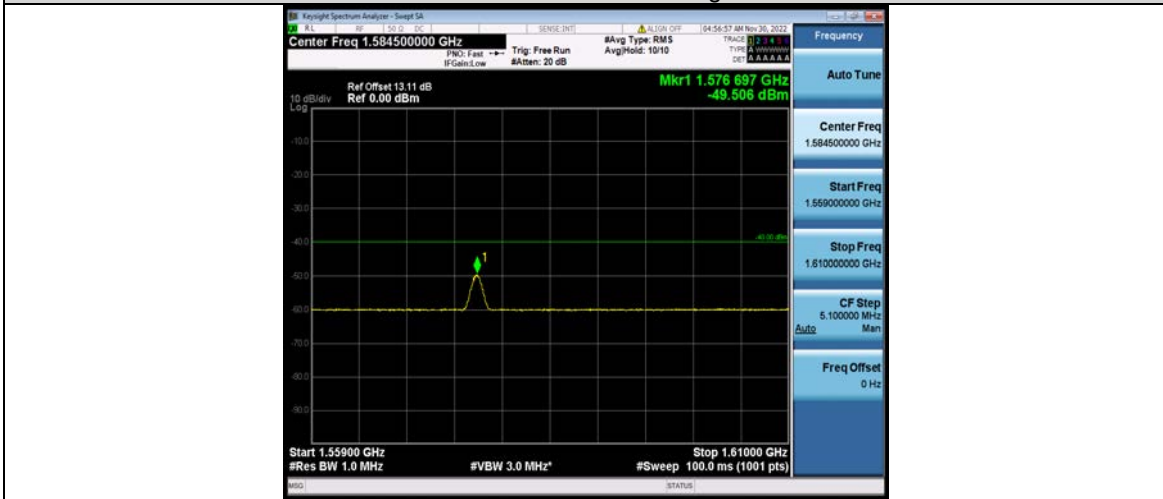

Band14-5MHz-16QAM-23330-1RB#0-Range1:30~1000MHz



Test Report No.: W7L-P23100014RF09

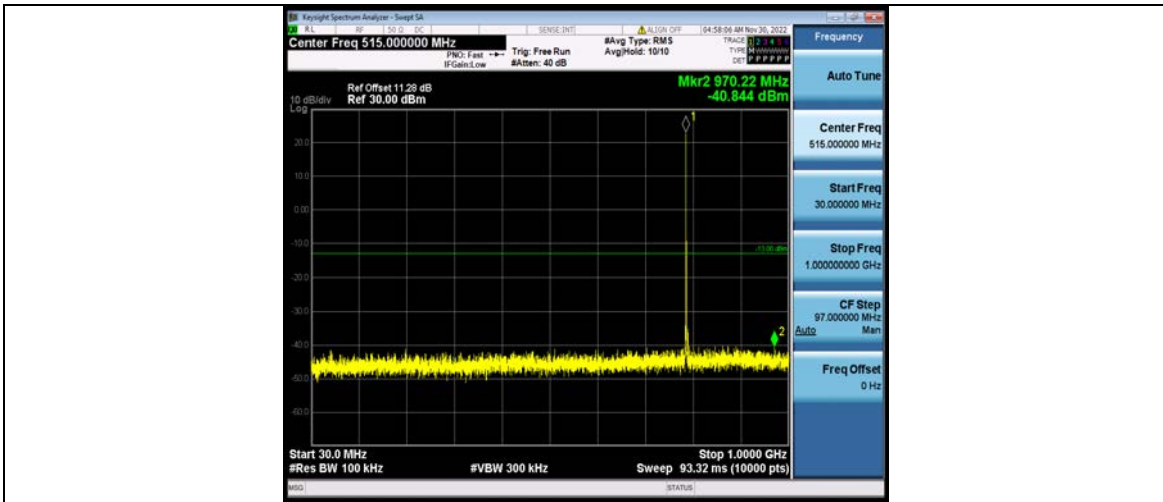

Band14-5MHz-16QAM-23330-1RB#0-Range4:769~775MHz

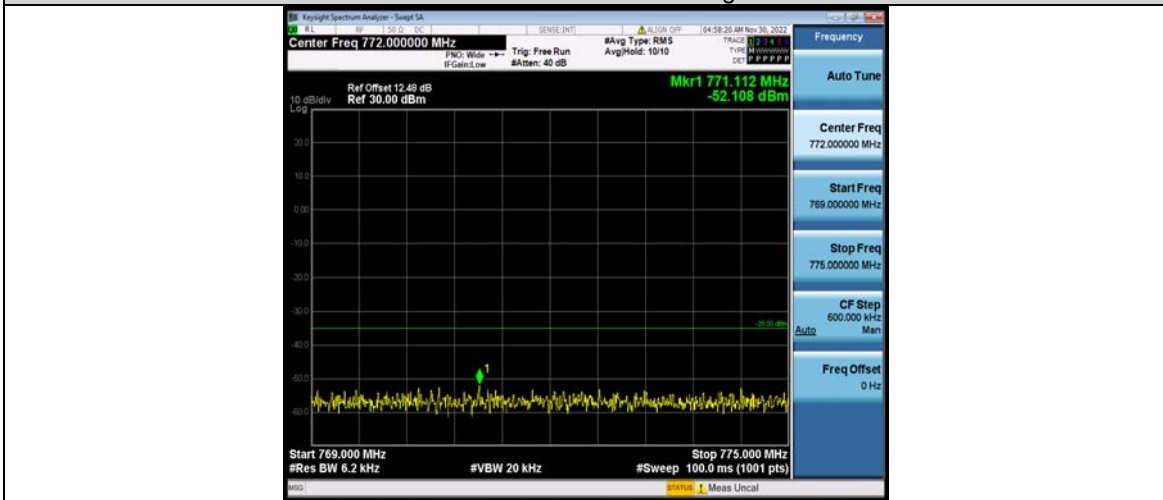

Band14-5MHz-16QAM-23330-1RB#0-Range5:799~805MHz

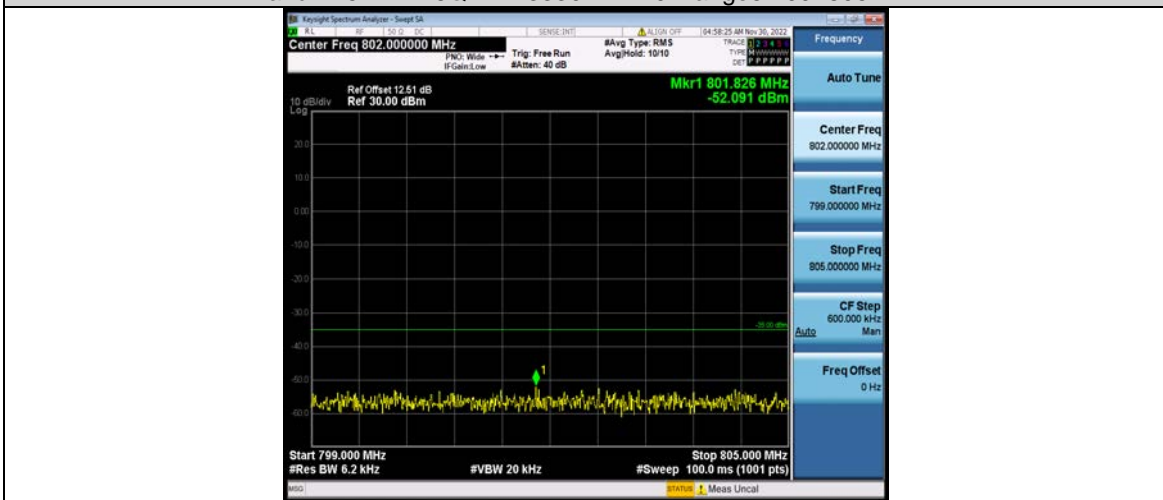

Band14-5MHz-16QAM-23330-1RB#0-Range2:1000~10000MHz



Test Report No.: W7L-P23100014RF09

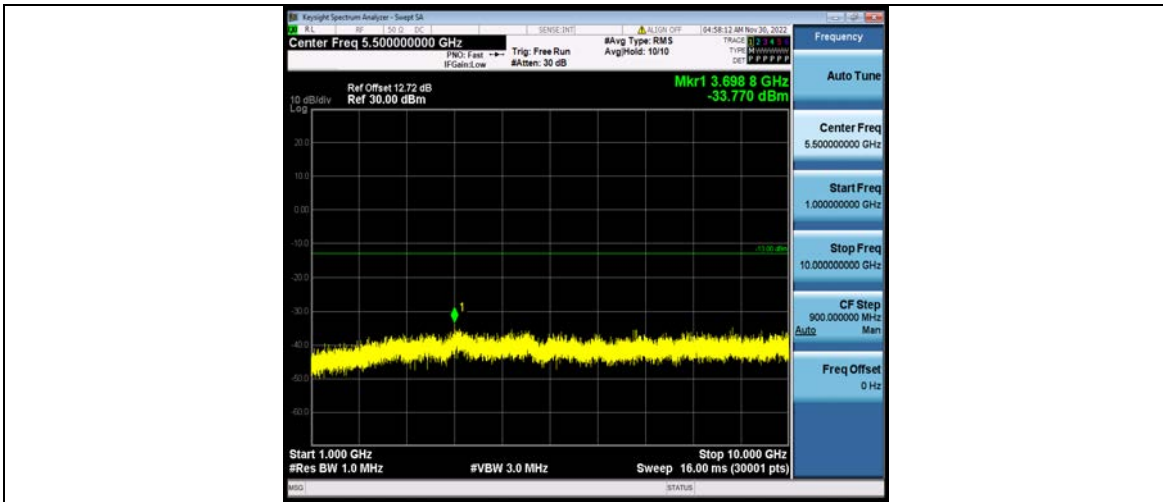

Band14-5MHz-16QAM-23330-1RB#0-Range3:1559~1610MHz

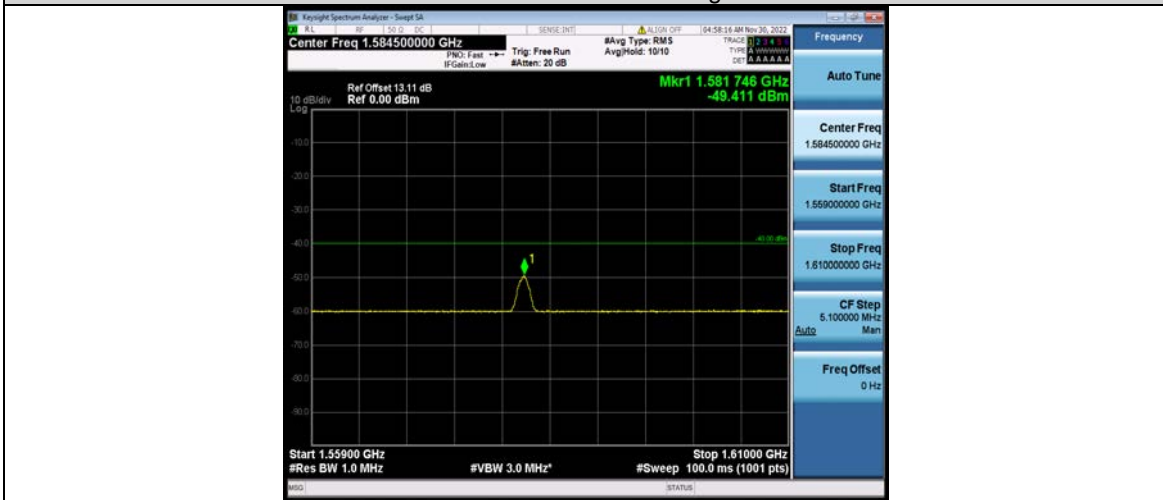

Band14-5MHz-16QAM-23355-1RB#0-Range1:30~1000MHz

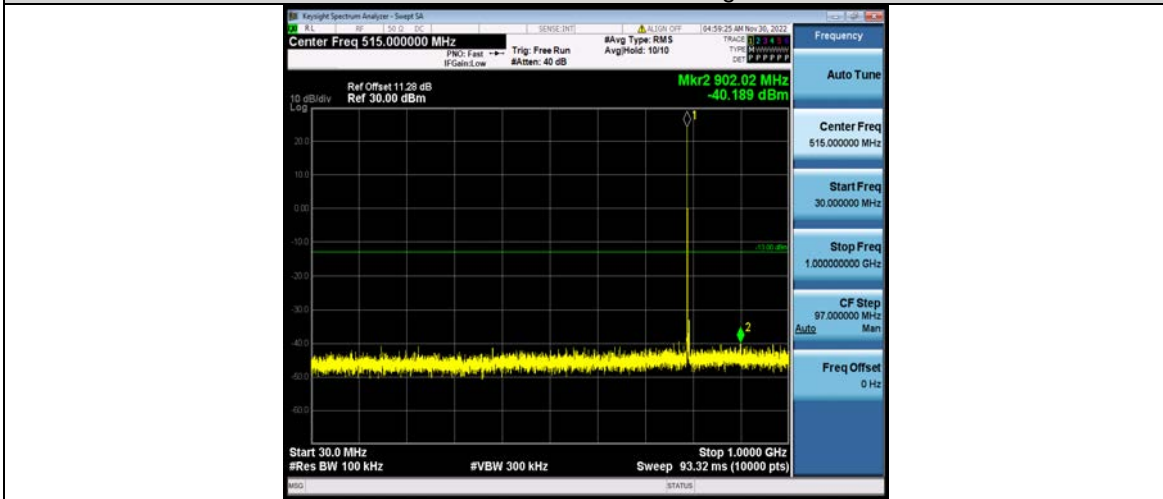

Band14-5MHz-16QAM-23355-1RB#0-Range4:769~775MHz



Test Report No.: W7L-P23100014RF09

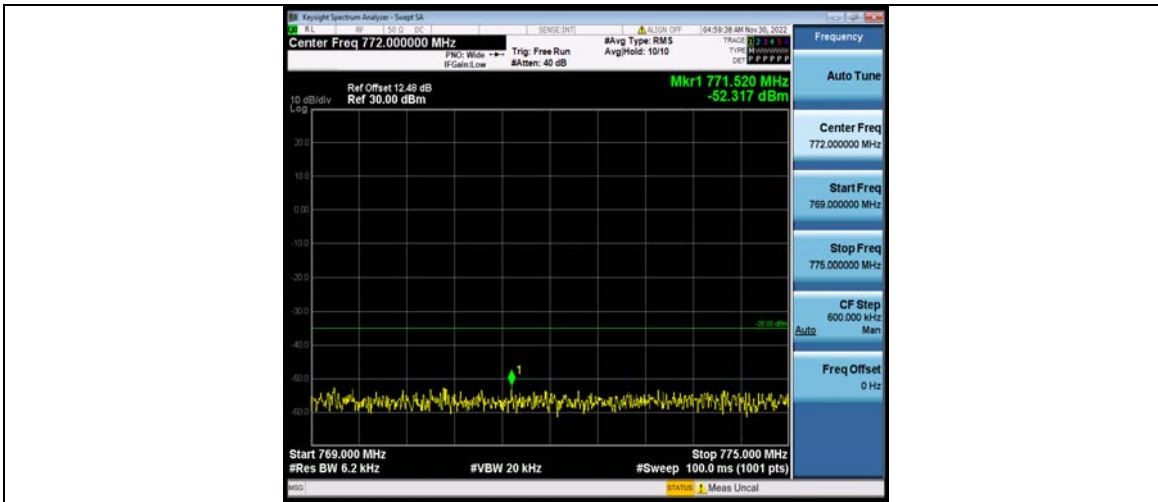

Band14-5MHz-16QAM-23355-1RB#0-Range5:799~805MHz

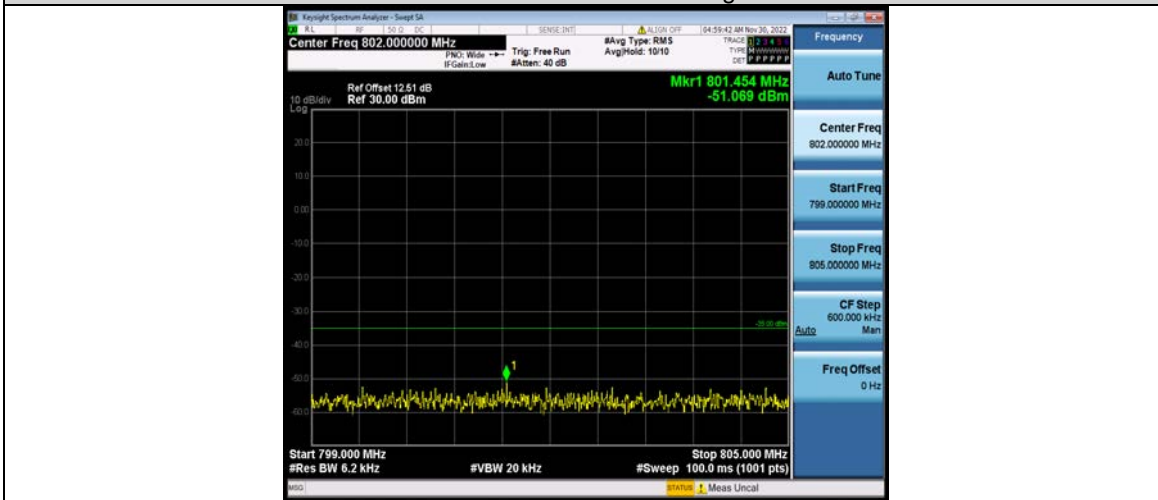

Band14-5MHz-16QAM-23355-1RB#0-Range2:1000~1000MHz

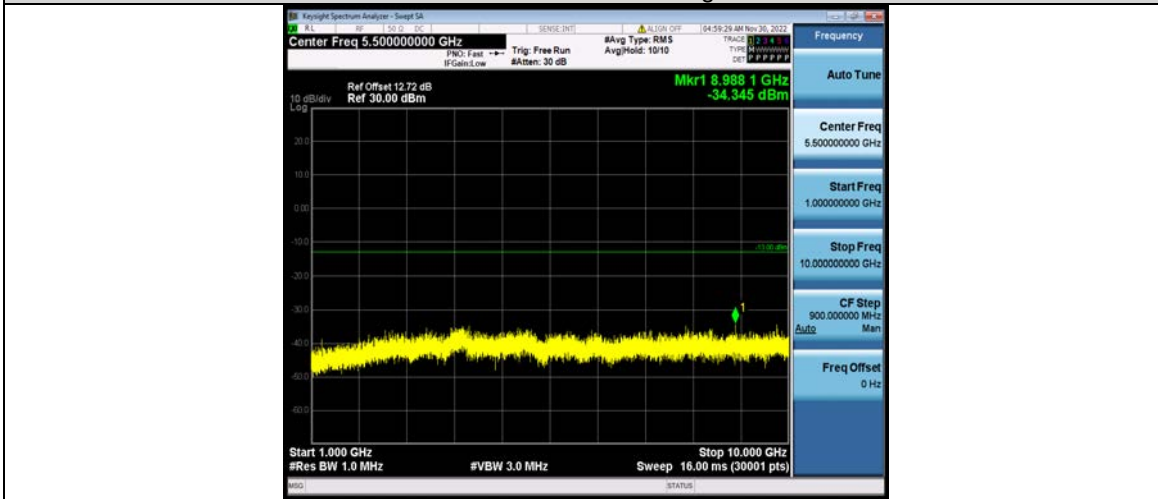

Band14-5MHz-16QAM-23355-1RB#0-Range3:1559~1610MHz



Test Report No.: W7L-P23100014RF09

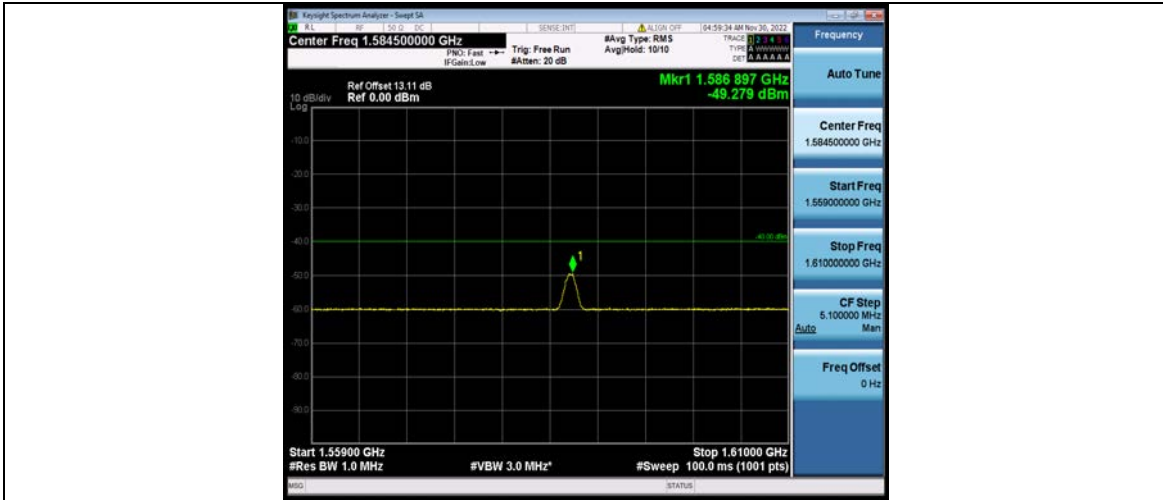

Band14-5MHz-64QAM-23305-1RB#0-Range1:30~1000MHz

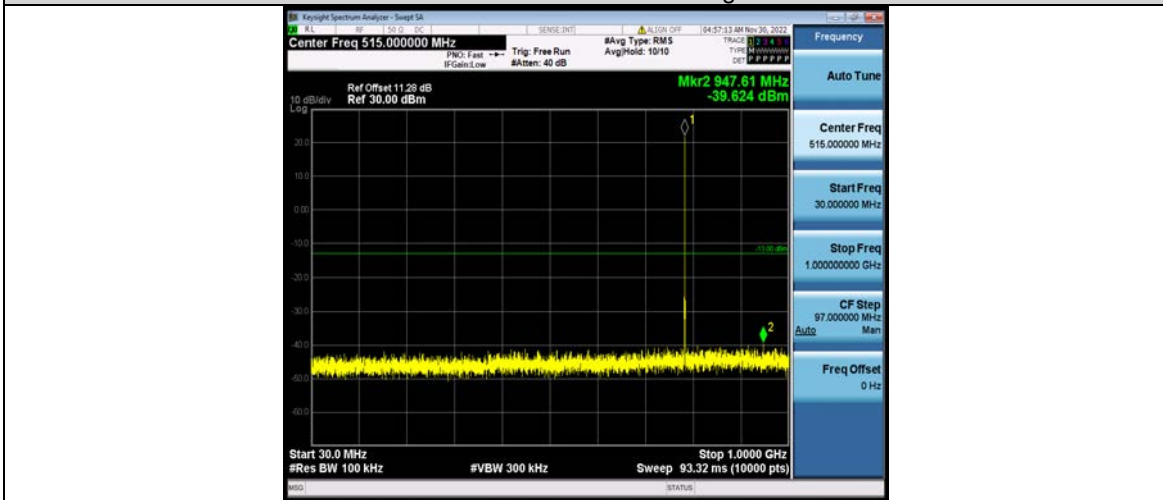

Band14-5MHz-64QAM-23305-1RB#0-Range4:769~775MHz

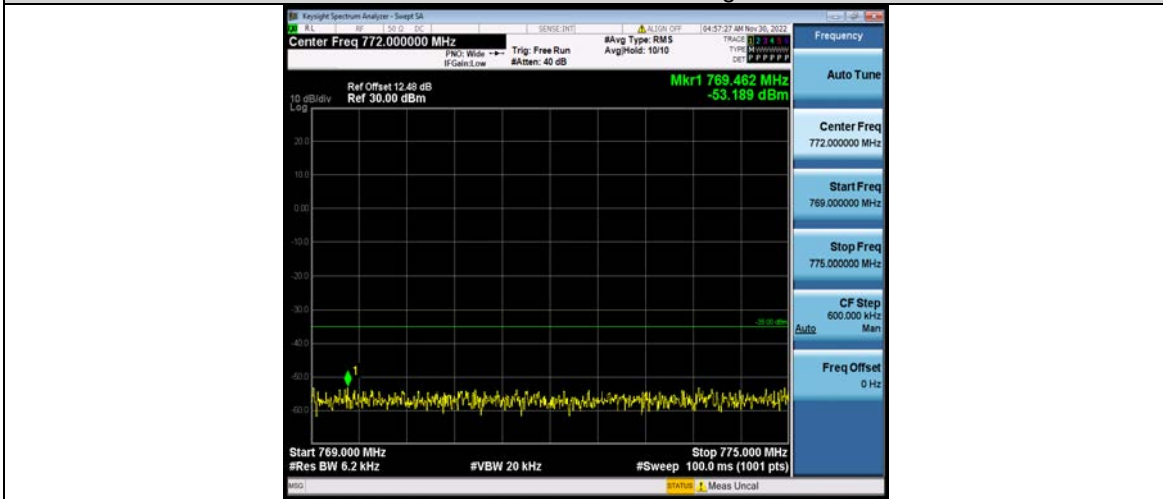

Band14-5MHz-64QAM-23305-1RB#0-Range5:799~805MHz



Test Report No.: W7L-P23100014RF09

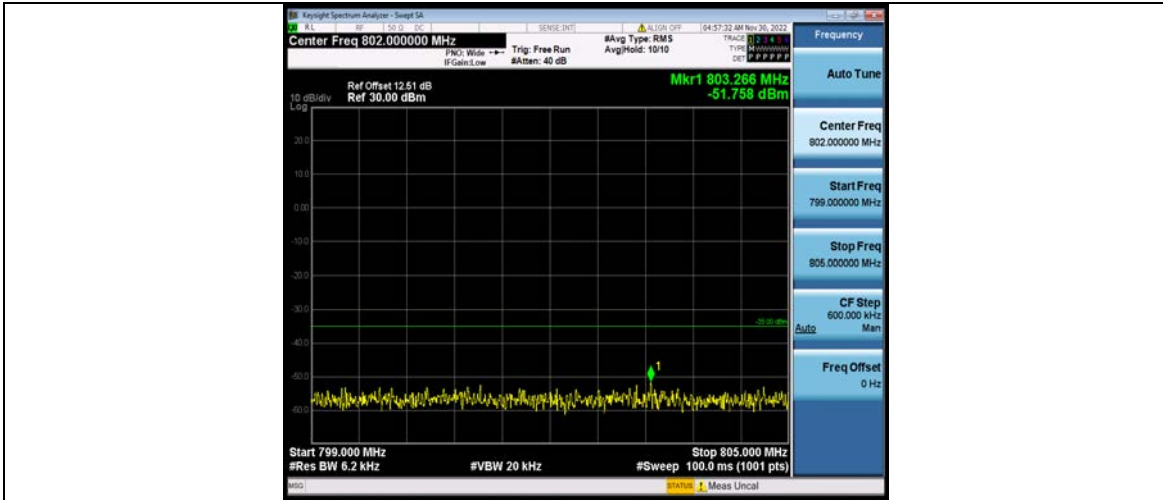

Band14-5MHz-64QAM-23305-1RB#0-Range2:1000~1000MHz

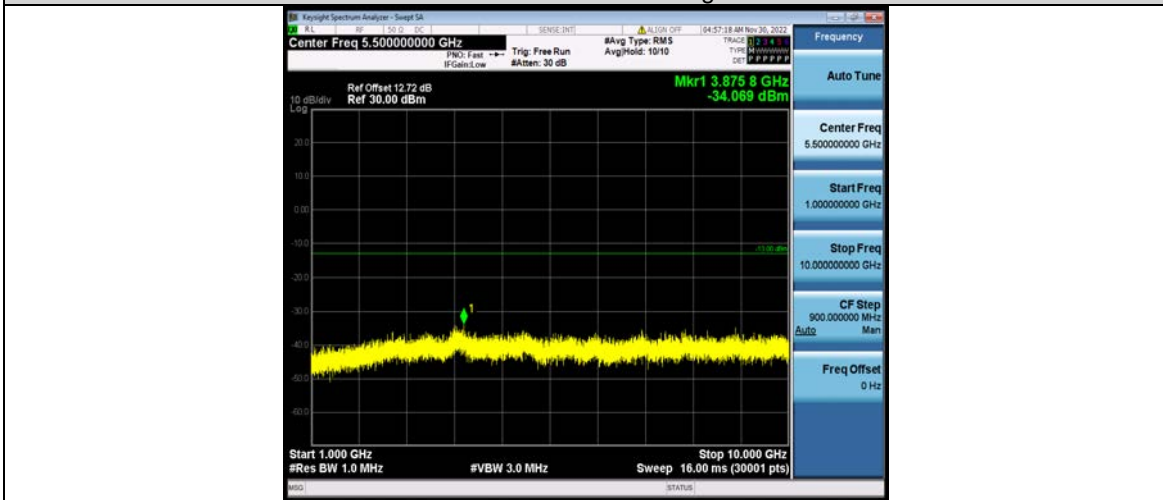

Band14-5MHz-64QAM-23305-1RB#0-Range3:1559~1610MHz

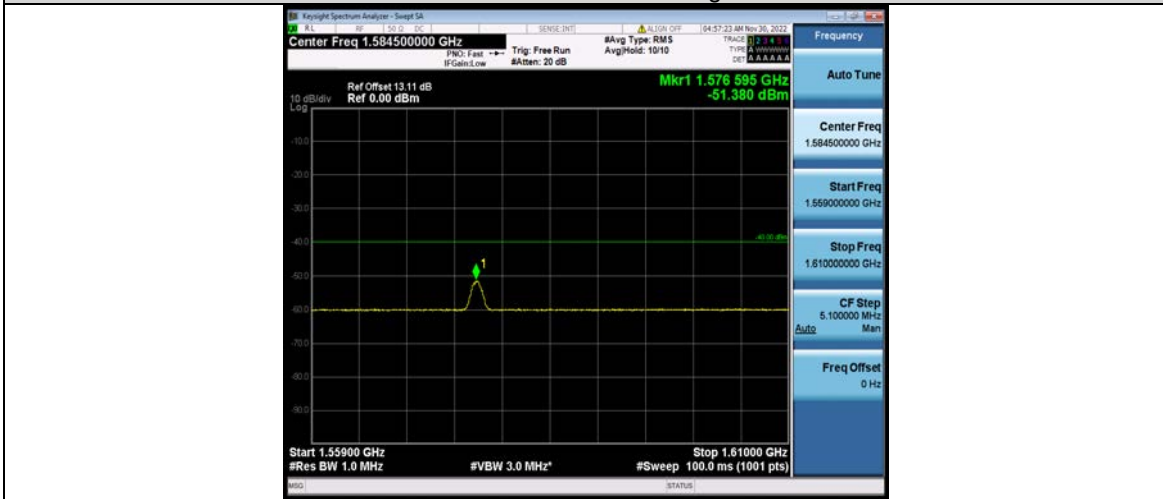

Band14-5MHz-64QAM-23330-1RB#0-Range1:30~1000MHz



Test Report No.: W7L-P23100014RF09

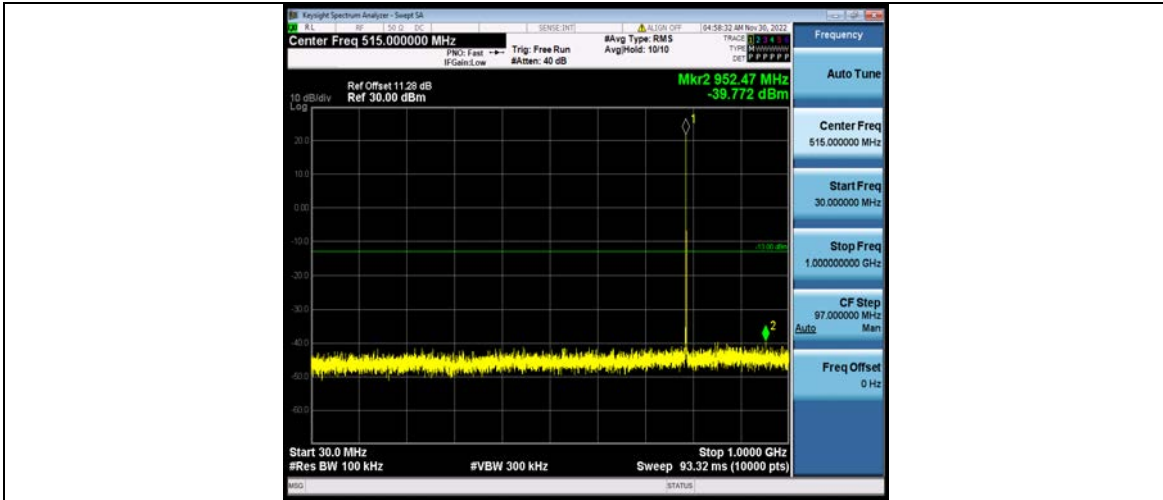

Band14-5MHz-64QAM-23330-1RB#0-Range4:769~775MHz

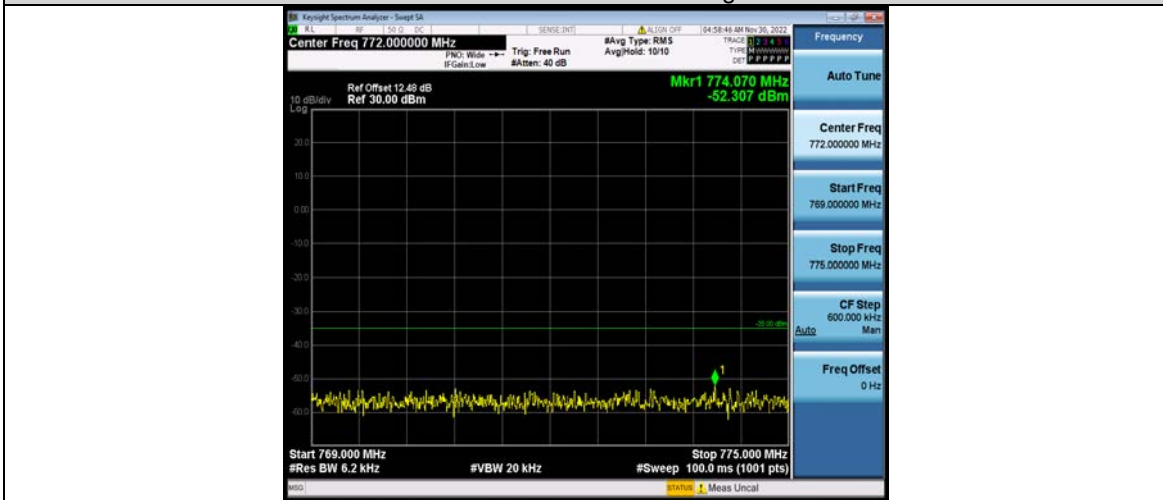

Band14-5MHz-64QAM-23330-1RB#0-Range5:799~805MHz

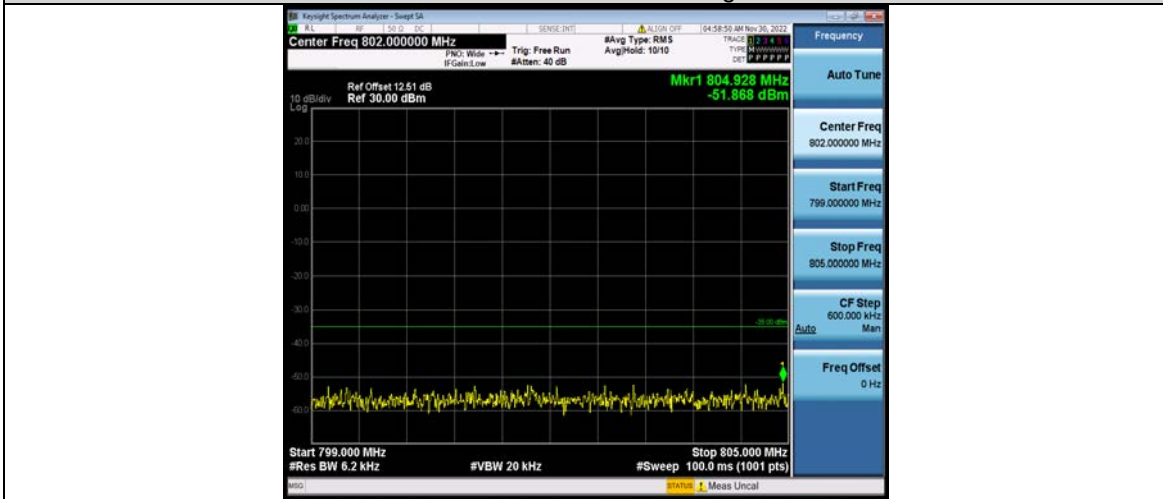

Band14-5MHz-64QAM-23330-1RB#0-Range2:1000~10000MHz



Test Report No.: W7L-P23100014RF09

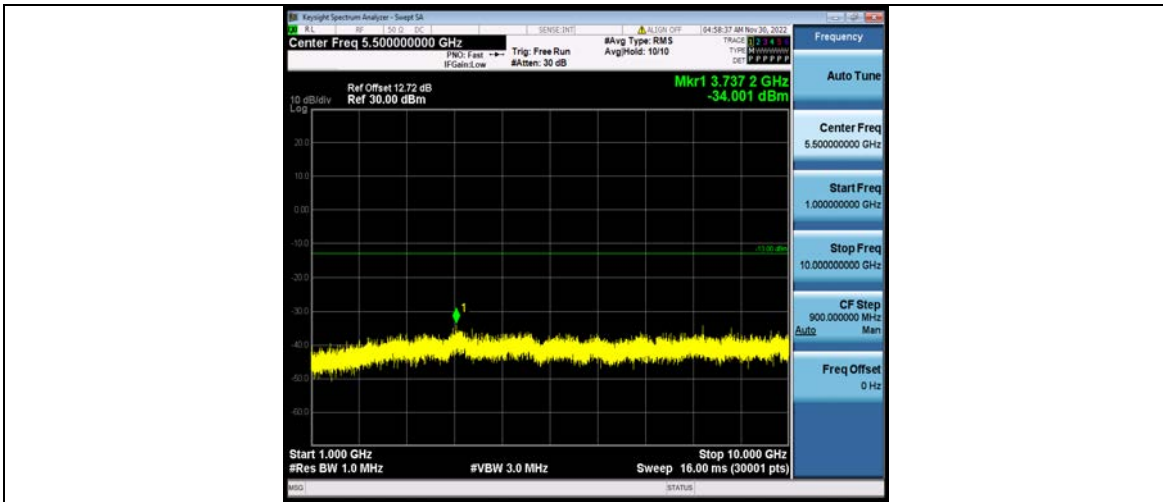

Band14-5MHz-64QAM-23330-1RB#0-Range3:1559~1610MHz

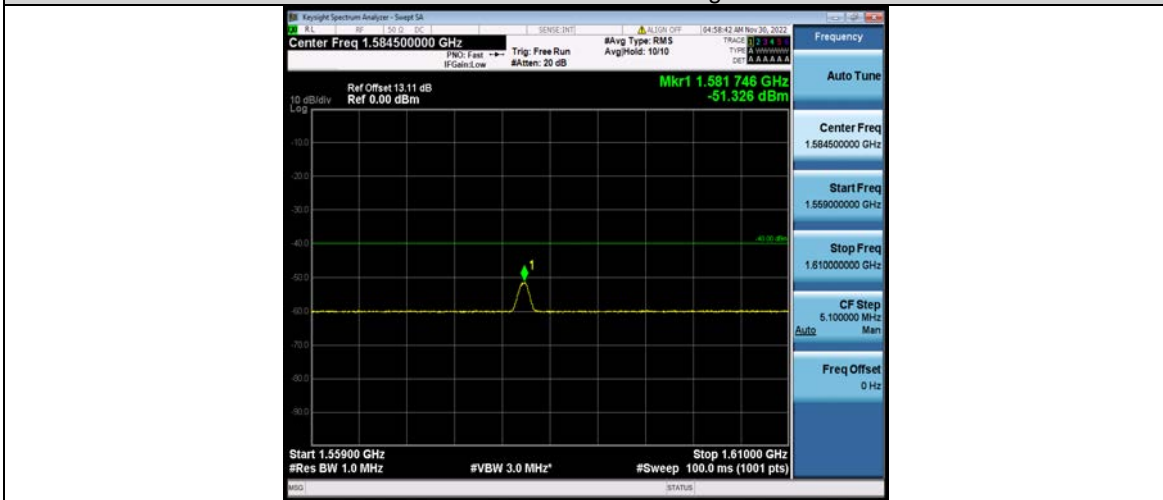

Band14-5MHz-64QAM-23355-1RB#0-Range1:30~1000MHz

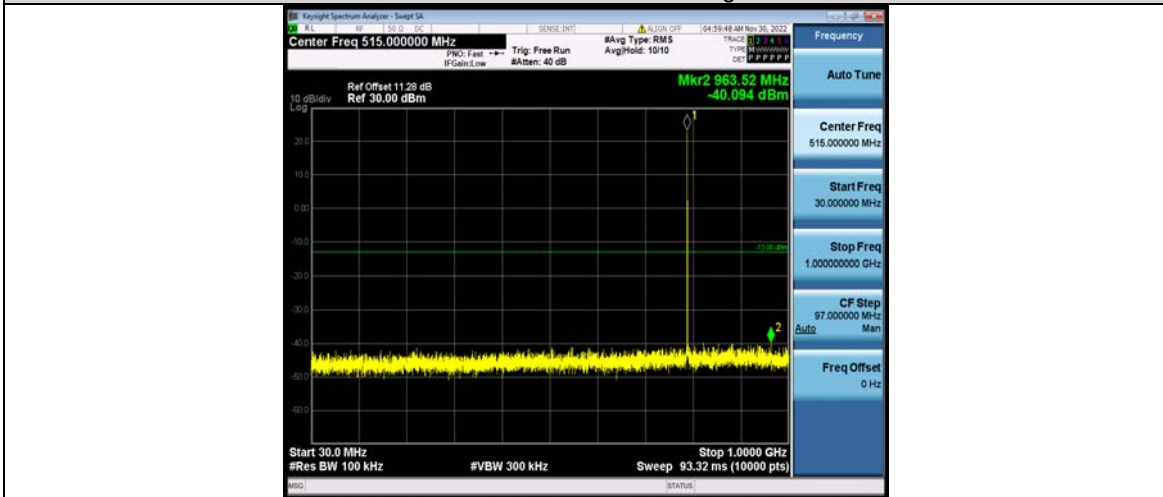

Band14-5MHz-64QAM-23355-1RB#0-Range4:769~775MHz



Test Report No.: W7L-P23100014RF09

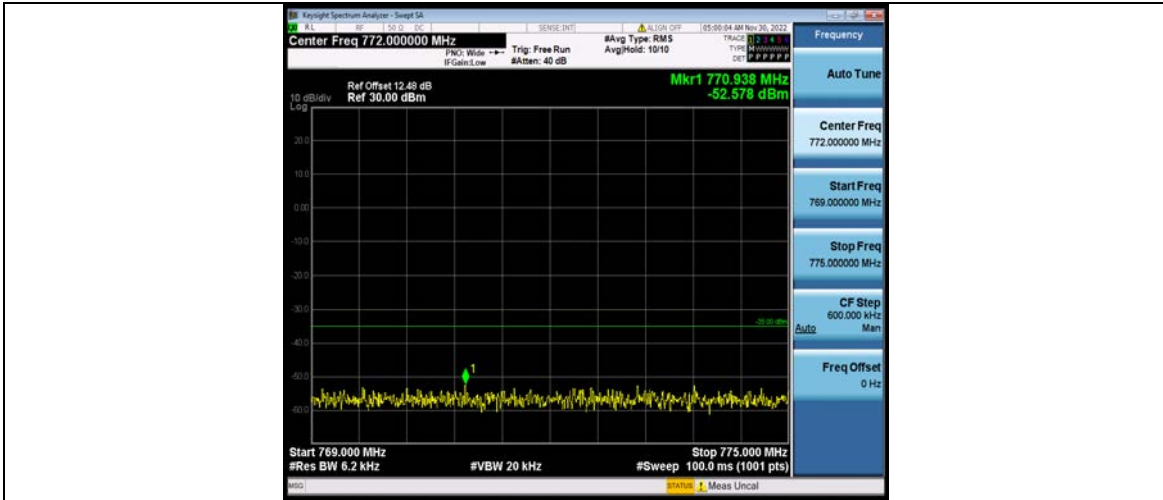

Band14-5MHz-64QAM-23355-1RB#0-Range5:799~805MHz

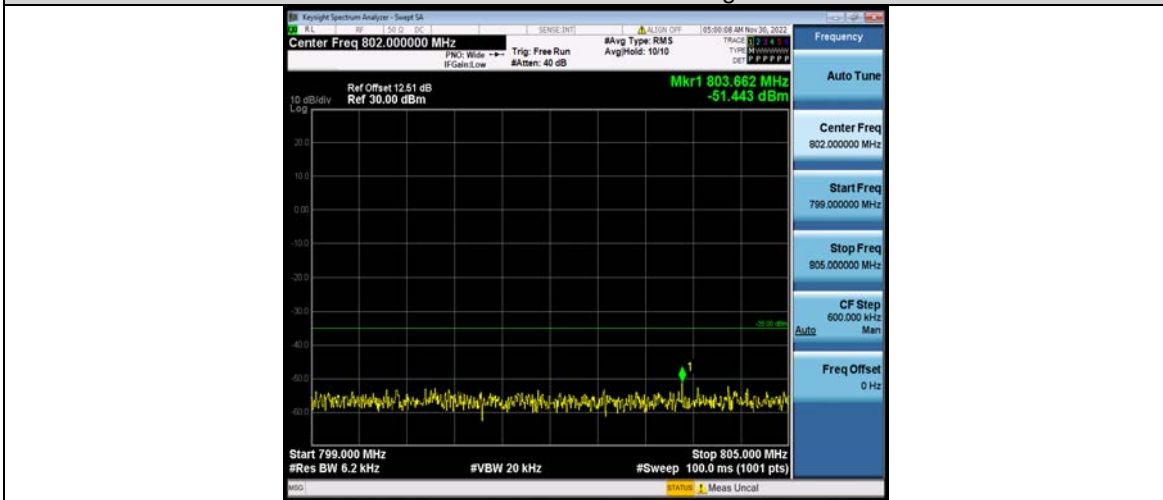

Band14-5MHz-64QAM-23355-1RB#0-Range2:1000~10000MHz

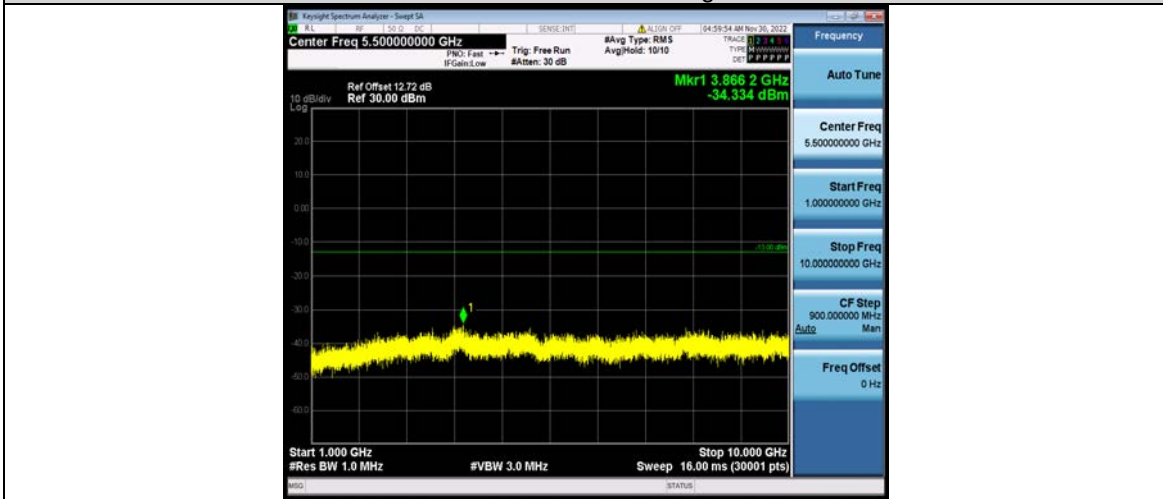

Band14-5MHz-64QAM-23355-1RB#0-Range3:1559~1610MHz



Test Report No.: W7L-P23100014RF09

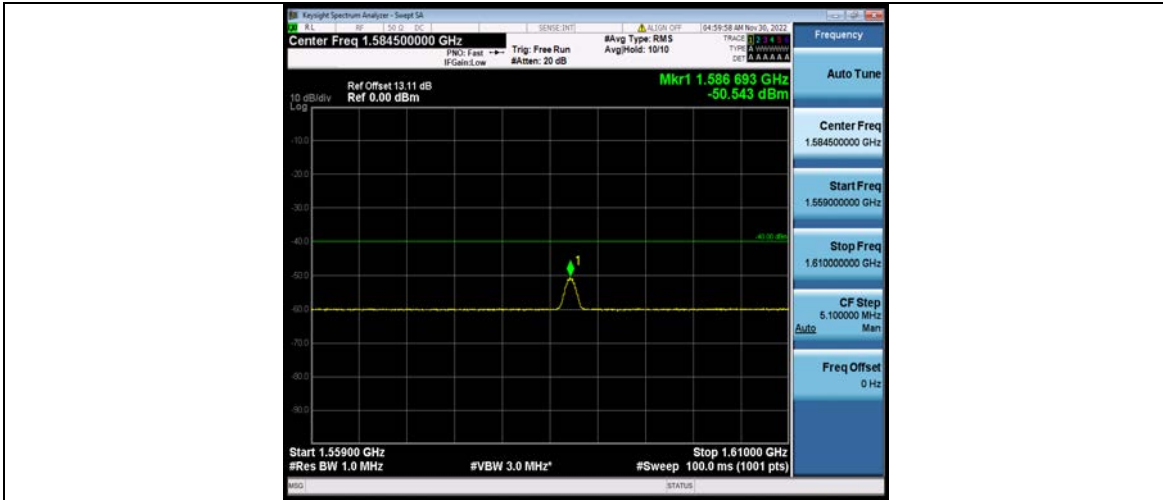

Band14-10MHz-QPSK-23330-1RB#0-Range1:30~1000MHz

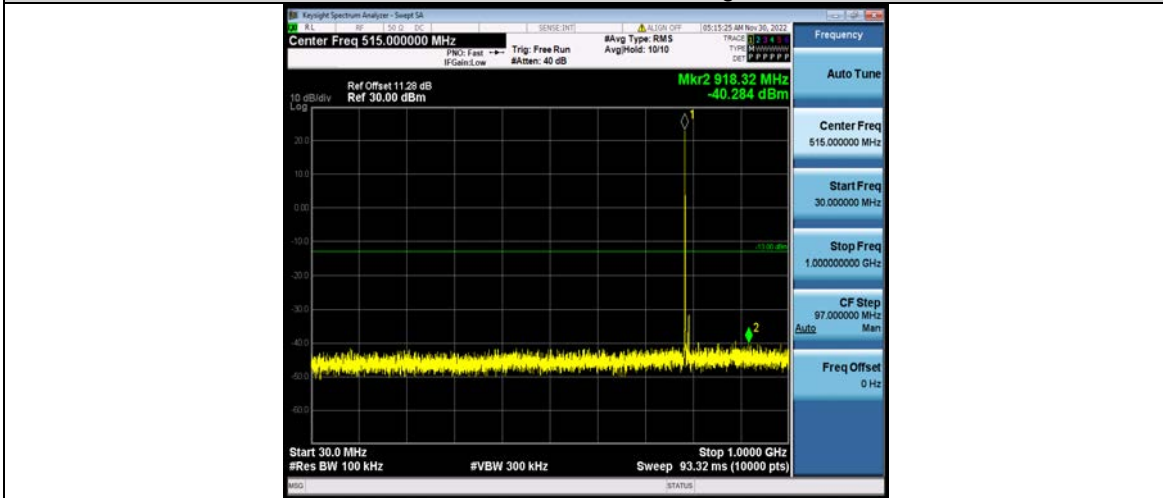

Band14-10MHz-QPSK-23330-1RB#0-Range4:769~775MHz

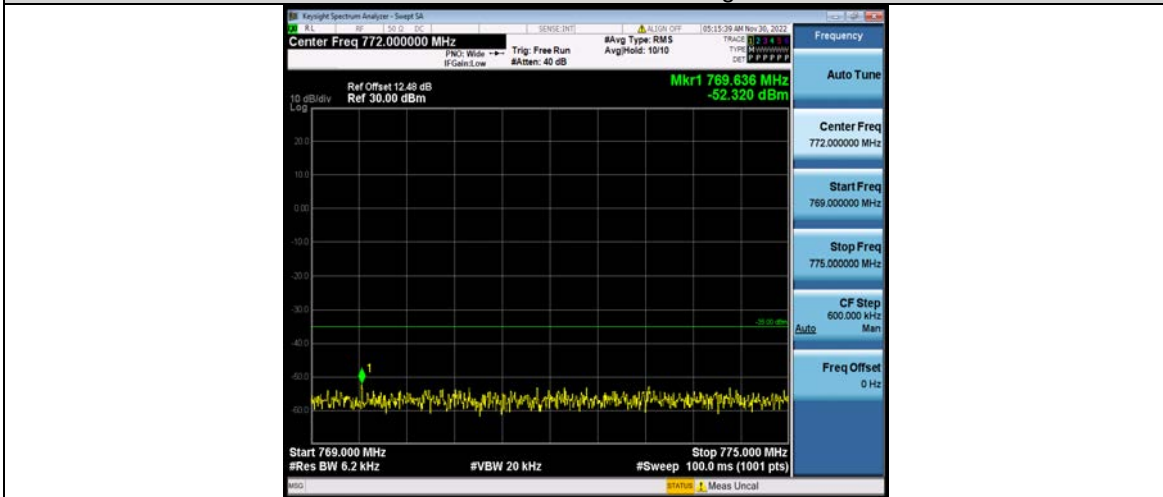

Band14-10MHz-QPSK-23330-1RB#0-Range5:799~805MHz



Test Report No.: W7L-P23100014RF09

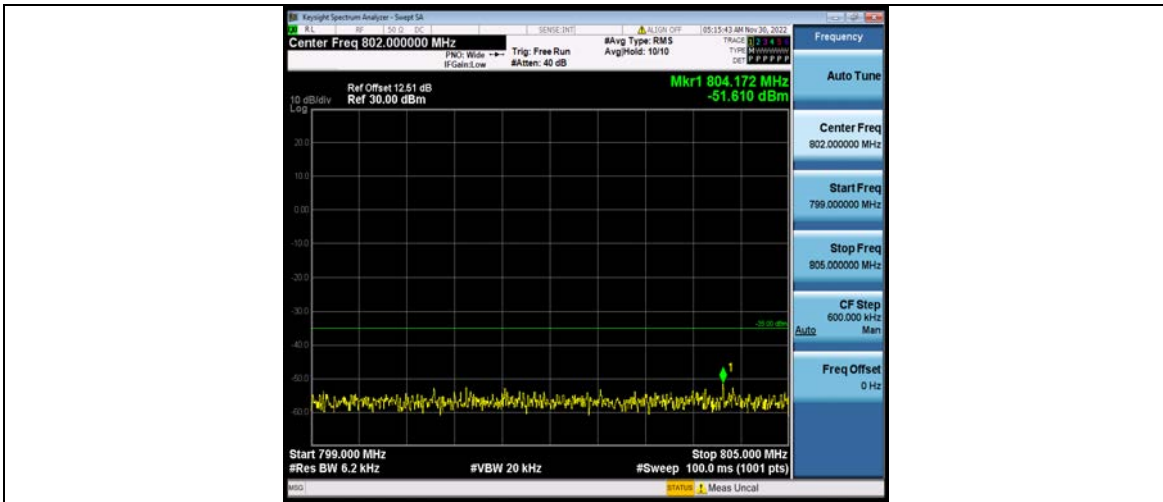

Band14-10MHz-QPSK-23330-1RB#0-Range2:1000~10000MHz

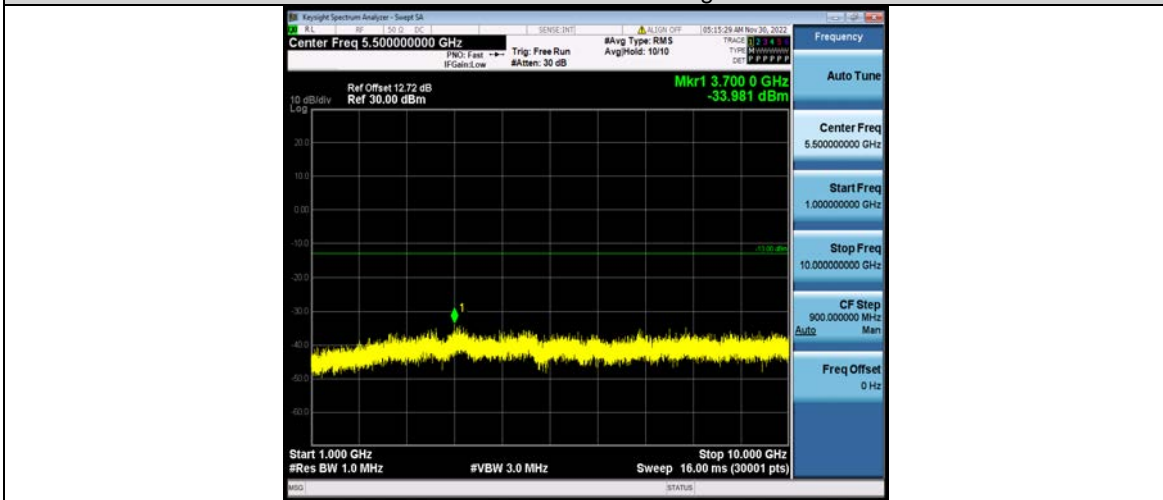

Band14-10MHz-QPSK-23330-1RB#0-Range3:1559~1610MHz

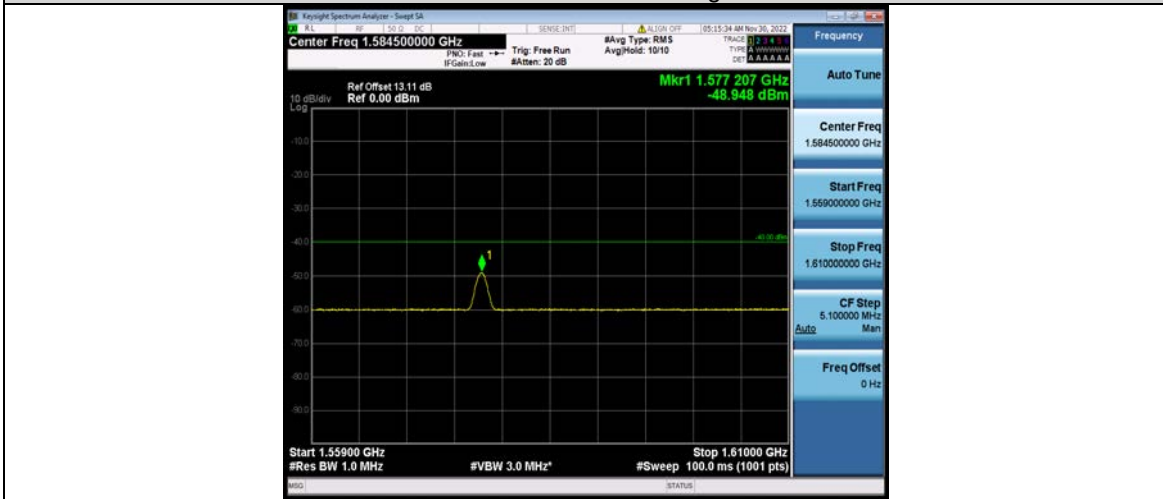

Band14-10MHz-16QAM-23330-1RB#0-Range1:30~1000MHz



Test Report No.: W7L-P23100014RF09

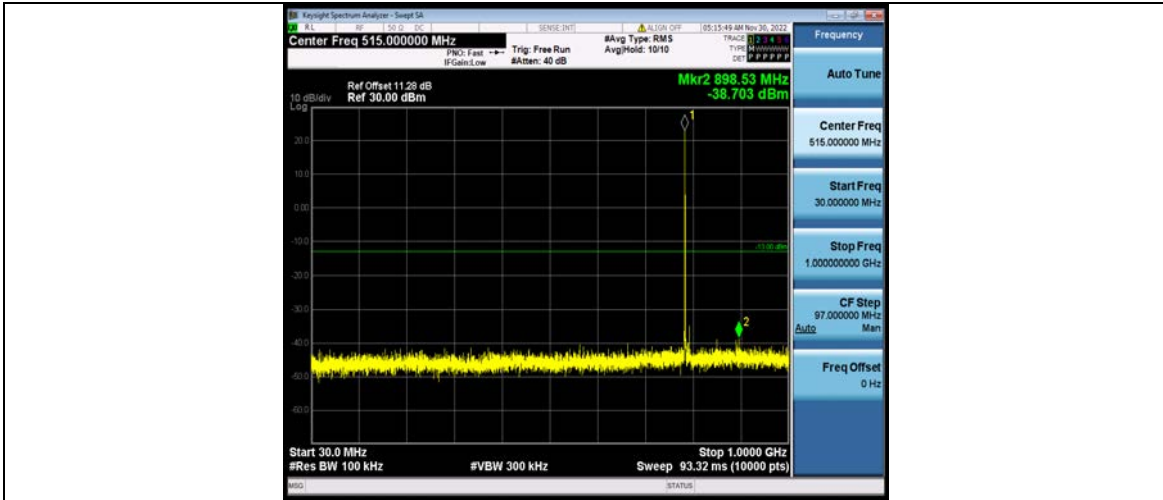

Band14-10MHz-16QAM-23330-1RB#0-Range4:769~775MHz

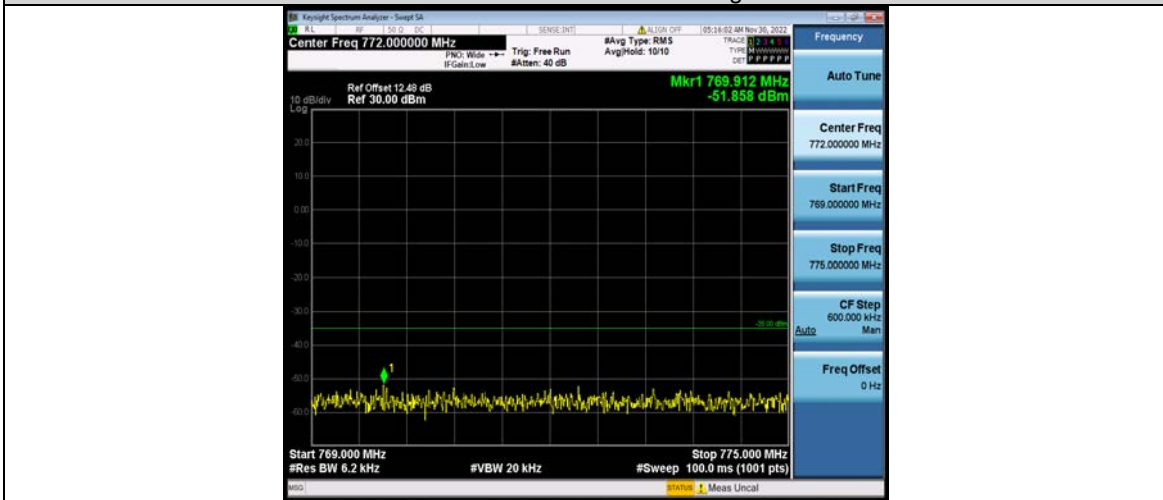

Band14-10MHz-16QAM-23330-1RB#0-Range5:799~805MHz

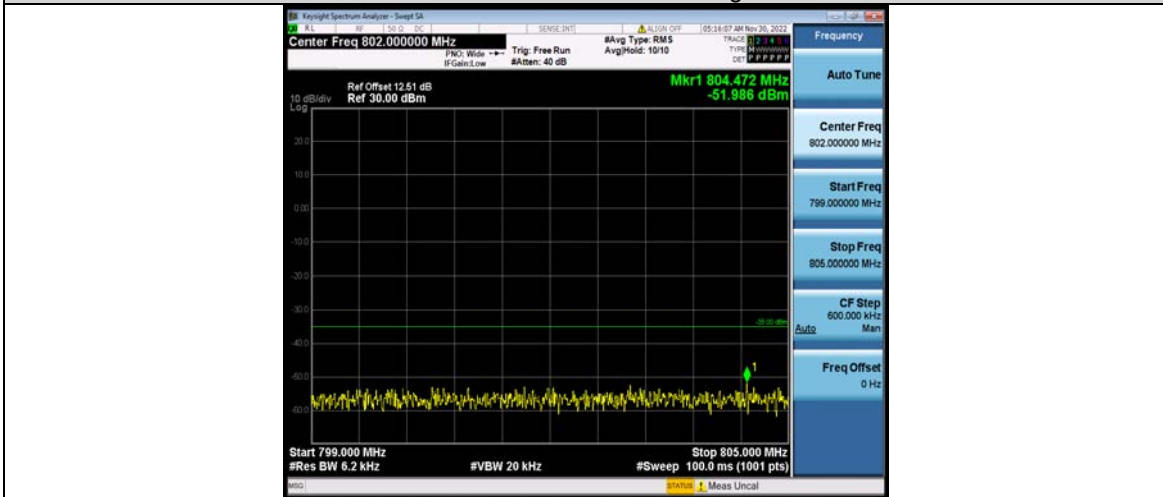

Band14-10MHz-16QAM-23330-1RB#0-Range2:1000~10000MHz



Test Report No.: W7L-P23100014RF09

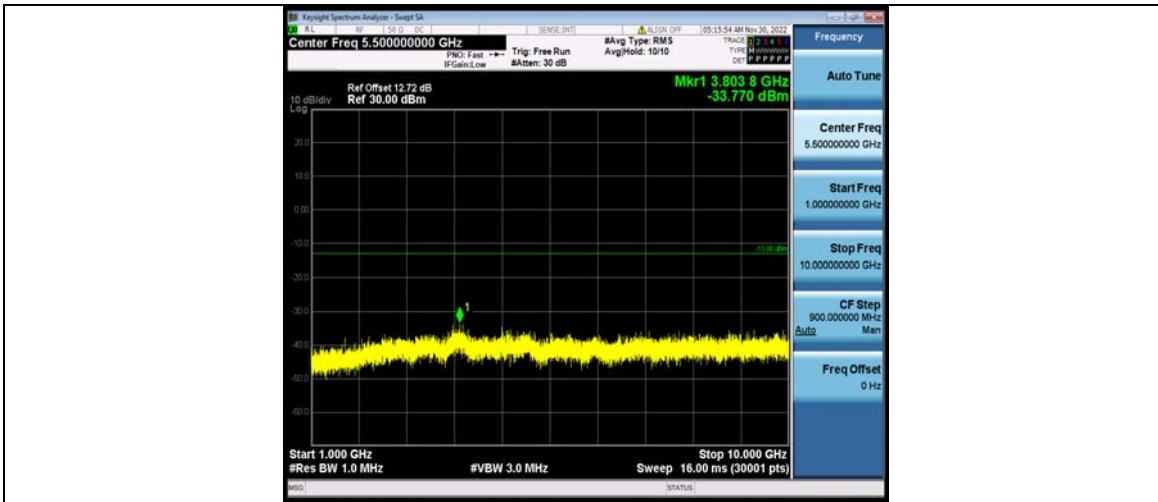

Band14-10MHz-16QAM-23330-1RB#0-Range3:1559~1610MHz

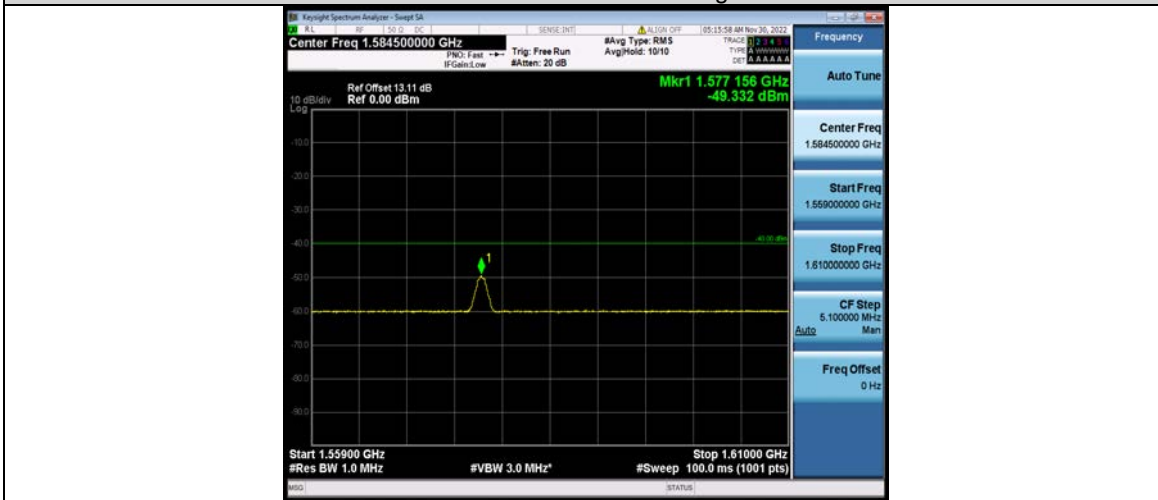

Band14-10MHz-64QAM-23330-1RB#0-Range1:30~1000MHz

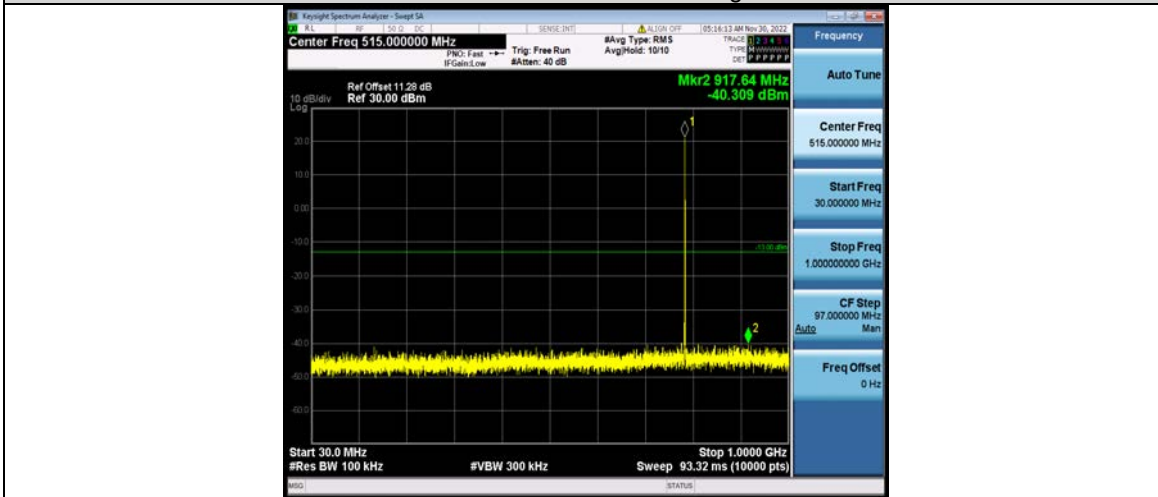

Band14-10MHz-64QAM-23330-1RB#0-Range4:769~775MHz



Test Report No.: W7L-P23100014RF09

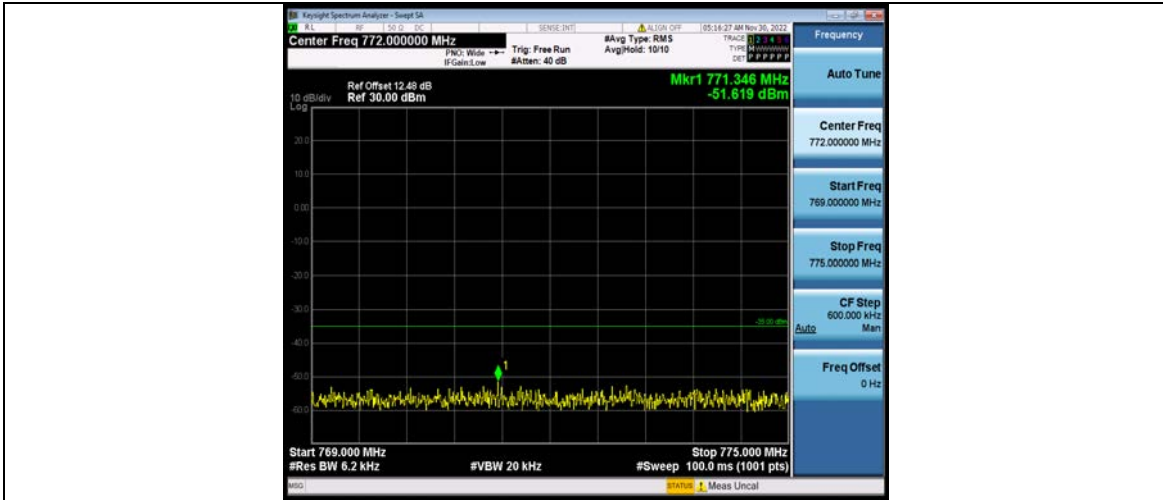

Band14-10MHz-64QAM-23330-1RB#0-Range5:799~805MHz

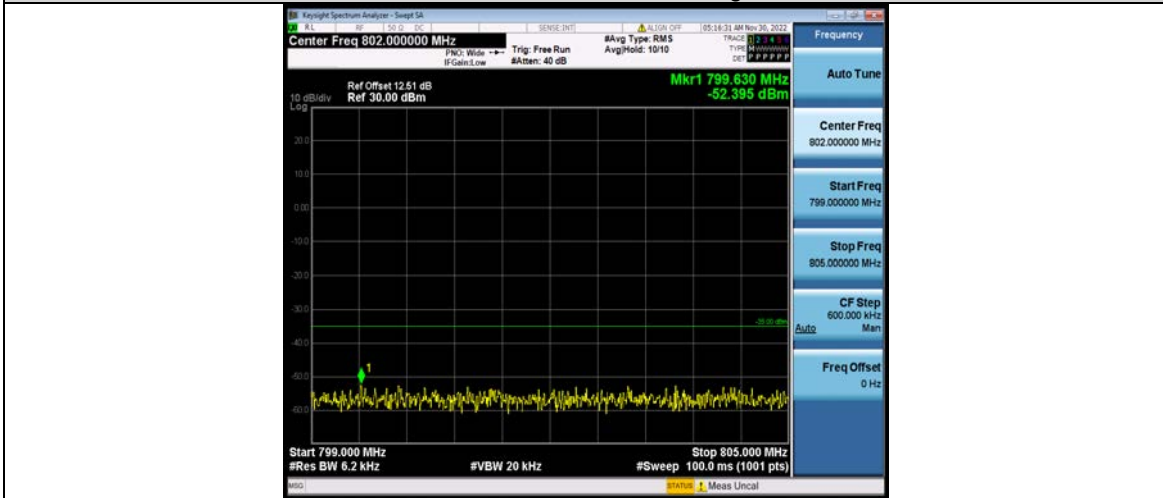

Band14-10MHz-64QAM-23330-1RB#0-Range2:1000~1000MHz

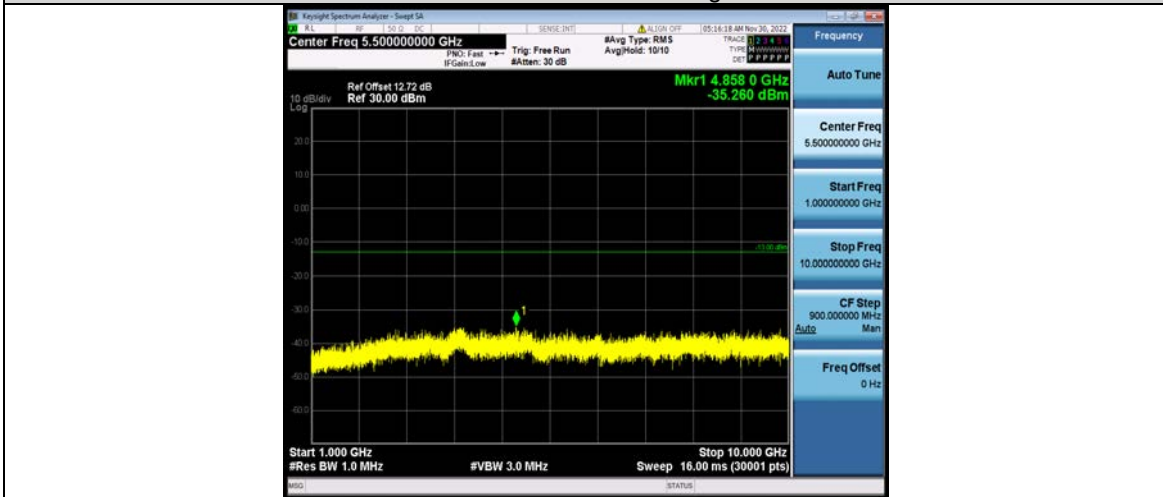

Band14-10MHz-64QAM-23330-1RB#0-Range3:1559~1610MHz



FREQUENCY STABILITY

Test Result

Band	Bandwidth	Modulation	Channel	RB Configure	Voltage		Deviation (Hz)	Deviation (ppm)	Limit (ppm)	Verdict
					Voltage [Vdc]	Temperature (°C)				
Band1_4	5MHz	QPSK	23305	25RB#0	VL	NT	2.46	0.003112	±2.5	PASS
Band1_4	5MHz	QPSK	23305	25RB#0	VN	NT	-1.96	-0.002479	±2.5	PASS
Band1_4	5MHz	QPSK	23305	25RB#0	VH	NT	-2.37	-0.002998	±2.5	PASS
Band1_4	5MHz	QPSK	23330	25RB#0	VL	NT	1.93	0.002434	±2.5	PASS
Band1_4	5MHz	QPSK	23330	25RB#0	VN	NT	-1.56	-0.001967	±2.5	PASS
Band1_4	5MHz	QPSK	23330	25RB#0	VH	NT	14.99	0.018903	±2.5	PASS
Band1_4	5MHz	QPSK	23355	25RB#0	VL	NT	-5.58	-0.007014	±2.5	PASS
Band1_4	5MHz	QPSK	23355	25RB#0	VN	NT	-6.68	-0.008397	±2.5	PASS
Band1_4	5MHz	QPSK	23355	25RB#0	VH	NT	-7.67	-0.009642	±2.5	PASS
Band1_4	5MHz	16QAM	23305	25RB#0	VL	NT	19.78	0.025022	±2.5	PASS
Band1_4	5MHz	16QAM	23305	25RB#0	VN	NT	4.08	0.005161	±2.5	PASS
Band1_4	5MHz	16QAM	23305	25RB#0	VH	NT	3.12	0.003947	±2.5	PASS
Band1_4	5MHz	16QAM	23330	25RB#0	VL	NT	-2.12	-0.002673	±2.5	PASS
Band1_4	5MHz	16QAM	23330	25RB#0	VN	NT	-1.36	-0.001715	±2.5	PASS
Band1_4	5MHz	16QAM	23330	25RB#0	VH	NT	1.14	0.001438	±2.5	PASS
Band1_4	5MHz	16QAM	23355	25RB#0	VL	NT	-6.91	-0.008686	±2.5	PASS
Band1_4	5MHz	16QAM	23355	25RB#0	VN	NT	2.29	0.002879	±2.5	PASS
Band1_4	5MHz	16QAM	23355	25RB#0	VH	NT	1.42	0.001785	±2.5	PASS
Band1_4	5MHz	64QAM	23305	25RB#0	VL	NT	-8.85	-0.011195	±2.5	PASS
Band1_4	5MHz	64QAM	23305	25RB#0	VN	NT	18.08	0.022872	±2.5	PASS
Band1_4	5MHz	64QAM	23305	25RB#0	VH	NT	2.85	0.003605	±2.5	PASS



Test Report No.: W7L-P23100014RF09

Band1 4	5MHz	64QAM	23330	25RB#0	VL	NT	4.26	0.005372	±2.5	PASS
Band1 4	5MHz	64QAM	23330	25RB#0	VN	NT	-7.15	-0.009016	±2.5	PASS
Band1 4	5MHz	64QAM	23330	25RB#0	VH	NT	-7.28	-0.009180	±2.5	PASS
Band1 4	5MHz	64QAM	23355	25RB#0	VL	NT	-2.27	-0.002854	±2.5	PASS
Band1 4	5MHz	64QAM	23355	25RB#0	VN	NT	-3.05	-0.003834	±2.5	PASS
Band1 4	5MHz	64QAM	23355	25RB#0	VH	NT	-2.53	-0.003180	±2.5	PASS
Band1 4	10MHz	QPSK	23330	50RB#0	VL	NT	-8.64	-0.010895	±2.5	PASS
Band1 4	10MHz	QPSK	23330	50RB#0	VN	NT	-10.66	-0.013443	±2.5	PASS
Band1 4	10MHz	QPSK	23330	50RB#0	VH	NT	-7.75	-0.009773	±2.5	PASS
Band1 4	10MHz	16QAM	23330	50RB#0	VL	NT	14.15	0.017844	±2.5	PASS
Band1 4	10MHz	16QAM	23330	50RB#0	VN	NT	2.09	0.002636	±2.5	PASS
Band1 4	10MHz	16QAM	23330	50RB#0	VH	NT	-1.37	-0.001728	±2.5	PASS
Band1 4	10MHz	64QAM	23330	50RB#0	VL	NT	13.59	0.017137	±2.5	PASS
Band1 4	10MHz	64QAM	23330	50RB#0	VN	NT	12.67	0.015977	±2.5	PASS
Band1 4	10MHz	64QAM	23330	50RB#0	VH	NT	1.27	0.001602	±2.5	PASS

Temperature										
Band	Bandwidth	Modulation	Channel	RB Configuration	Voltage [Vdc]	Temperature (°C)	Deviation (Hz)	Deviation (ppm)	Limit (ppm)	Verdict
Band14	5MHz	QPSK	23305	25RB#0	NV	-30	17.11	0.021645	±2.5	PASS
Band14	5MHz	QPSK	23305	25RB#0	NV	-20	2.06	0.002606	±2.5	PASS
Band14	5MHz	QPSK	23305	25RB#0	NV	0	3	0.003795	±2.5	PASS
Band14	5MHz	QPSK	23305	25RB#0	NV	10	17.9	0.022644	±2.5	PASS
Band14	5MHz	QPSK	23305	25RB#0	NV	20	2.22	0.002808	±2.5	PASS
Band14	5MHz	QPSK	23305	25RB#0	NV	30	-2.79	-0.003507	±2.5	PASS
Band14	5MHz	QPSK	23305	25RB#0	NV	40	-3.71	-0.004664	±2.5	PASS
Band14	5MHz	QPSK	23305	25RB#0	NV	50	3.43	0.004339	±2.5	PASS



Test Report No.: W7L-P23100014RF09

Band14	5MHz	QPSK	23330	25RB#0	NV	-30	-2.49	-0.00314	±2.5	PASS
Band14	5MHz	QPSK	23330	25RB#0	NV	-20	3.71	0.004678	±2.5	PASS
Band14	5MHz	QPSK	23330	25RB#0	NV	0	15.52	0.019571	±2.5	PASS
Band14	5MHz	QPSK	23330	25RB#0	NV	10	-2.37	-0.002989	±2.5	PASS
Band14	5MHz	QPSK	23330	25RB#0	NV	20	2.29	0.002888	±2.5	PASS
Band14	5MHz	QPSK	23330	25RB#0	NV	30	2.27	0.002854	±2.5	PASS
Band14	5MHz	QPSK	23330	25RB#0	NV	40	2.75	0.003468	±2.5	PASS
Band14	5MHz	QPSK	23330	25RB#0	NV	50	2.27	0.002877	±2.5	PASS
Band14	5MHz	QPSK	23355	25RB#0	NV	-30	-8.23	-0.010346	±2.5	PASS
Band14	5MHz	QPSK	23355	25RB#0	NV	-20	-3.71	-0.004664	±2.5	PASS
Band14	5MHz	QPSK	23355	25RB#0	NV	0	-7.31	-0.009189	±2.5	PASS
Band14	5MHz	QPSK	23355	25RB#0	NV	10	-2.79	-0.003507	±2.5	PASS
Band14	5MHz	QPSK	23355	25RB#0	NV	20	-9.54	-0.011992	±2.5	PASS
Band14	5MHz	QPSK	23355	25RB#0	NV	30	-1.29	-0.001627	±2.5	PASS
Band14	5MHz	QPSK	23355	25RB#0	NV	40	-1.47	-0.001848	±2.5	PASS
Band14	5MHz	QPSK	23355	25RB#0	NV	50	-1.44	-0.00181	±2.5	PASS
Band14	5MHz	16QAM	23305	25RB#0	NV	-30	4.99	0.006312	±2.5	PASS
Band14	5MHz	16QAM	23305	25RB#0	NV	-20	4.52	0.005718	±2.5	PASS
Band14	5MHz	16QAM	23305	25RB#0	NV	0	20	0.0253	±2.5	PASS
Band14	5MHz	16QAM	23305	25RB#0	NV	10	18.02	0.022796	±2.5	PASS
Band14	5MHz	16QAM	23305	25RB#0	NV	20	3.43	0.004339	±2.5	PASS
Band14	5MHz	16QAM	23305	25RB#0	NV	30	-2.76	-0.00348	±2.5	PASS
Band14	5MHz	16QAM	23305	25RB#0	NV	40	1.65	0.002074	±2.5	PASS
Band14	5MHz	16QAM	23305	25RB#0	NV	50	2.07	0.00261	±2.5	PASS



Test Report No.: W7L-P23100014RF09

Band14	5MHz	16QAM	23330	25RB#0	NV	-30	14.93	0.018827	±2.5	PASS
Band14	5MHz	16QAM	23330	25RB#0	NV	-20	14.95	0.018852	±2.5	PASS
Band14	5MHz	16QAM	23330	25RB#0	NV	0	2.75	0.003468	±2.5	PASS
Band14	5MHz	16QAM	23330	25RB#0	NV	10	-2.32	-0.002926	±2.5	PASS
Band14	5MHz	16QAM	23330	25RB#0	NV	20	18.1	0.022825	±2.5	PASS
Band14	5MHz	16QAM	23330	25RB#0	NV	30	2.73	0.003461	±2.5	PASS
Band14	5MHz	16QAM	23330	25RB#0	NV	40	-2.22	-0.002808	±2.5	PASS
Band14	5MHz	16QAM	23330	25RB#0	NV	50	2.22	0.002808	±2.5	PASS
Band14	5MHz	16QAM	23355	25RB#0	NV	-30	-7.47	-0.00939	±2.5	PASS
Band14	5MHz	16QAM	23355	25RB#0	NV	-20	-7.75	-0.009742	±2.5	PASS
Band14	5MHz	16QAM	23355	25RB#0	NV	0	1.65	0.002074	±2.5	PASS
Band14	5MHz	16QAM	23355	25RB#0	NV	10	2.27	0.002854	±2.5	PASS
Band14	5MHz	16QAM	23355	25RB#0	NV	20	-1.77	-0.002225	±2.5	PASS
Band14	5MHz	16QAM	23355	25RB#0	NV	30	-2.37	-0.002989	±2.5	PASS
Band14	5MHz	16QAM	23355	25RB#0	NV	40	2.29	0.002888	±2.5	PASS
Band14	5MHz	16QAM	23355	25RB#0	NV	50	2.27	0.002854	±2.5	PASS
Band14	5MHz	64QAM	23305	25RB#0	NV	-30	2.85	0.003605	±2.5	PASS
Band14	5MHz	64QAM	23305	25RB#0	NV	-20	-7.67	-0.009703	±2.5	PASS
Band14	5MHz	64QAM	23305	25RB#0	NV	0	-9.64	-0.012195	±2.5	PASS
Band14	5MHz	64QAM	23305	25RB#0	NV	10	18	0.02277	±2.5	PASS
Band14	5MHz	64QAM	23305	25RB#0	NV	20	2.52	0.003188	±2.5	PASS
Band14	5MHz	64QAM	23330	25RB#0	NV	-30	-8.4	-0.010593	±2.5	PASS
Band14	5MHz	64QAM	23330	25RB#0	NV	-20	-9.83	-0.012396	±2.5	PASS
Band14	5MHz	64QAM	23330	25RB#0	NV	0	-2.33	-0.002938	±2.5	PASS



Test Report No.: W7L-P23100014RF09

Band14	5MHz	64QAM	23330	25RB#0	NV	10	2.09	0.002636	±2.5	PASS
Band14	5MHz	64QAM	23330	25RB#0	NV	20	-7.74	-0.00976	±2.5	PASS
Band14	5MHz	64QAM	23330	25RB#0	NV	30	-2.33	-0.002938	±2.5	PASS
Band14	5MHz	64QAM	23330	25RB#0	NV	40	2.09	0.002636	±2.5	PASS
Band14	5MHz	64QAM	23330	25RB#0	NV	50	-7.74	-0.00976	±2.5	PASS
Band14	5MHz	64QAM	23355	25RB#0	NV	-30	1.95	0.002451	±2.5	PASS
Band14	5MHz	64QAM	23355	25RB#0	NV	-20	-1.47	-0.001848	±2.5	PASS
Band14	5MHz	64QAM	23355	25RB#0	NV	0	-1.44	-0.00181	±2.5	PASS
Band14	5MHz	64QAM	23355	25RB#0	NV	10	3.09	0.003884	±2.5	PASS
Band14	5MHz	64QAM	23355	25RB#0	NV	20	-6.9	-0.008674	±2.5	PASS
Band14	5MHz	64QAM	23355	25RB#0	NV	30	-1.29	-0.001627	±2.5	PASS
Band14	5MHz	64QAM	23355	25RB#0	NV	40	-2.76	-0.00348	±2.5	PASS
Band14	5MHz	64QAM	23355	25RB#0	NV	50	1.65	0.002074	±2.5	PASS
Band14	10MHz	QPSK	23330	50RB#0	NV	-30	15.79	0.019912	±2.5	PASS
Band14	10MHz	QPSK	23330	50RB#0	NV	-20	2.07	0.00261	±2.5	PASS
Band14	10MHz	QPSK	23330	50RB#0	NV	0	2.76	0.00348	±2.5	PASS
Band14	10MHz	QPSK	23330	50RB#0	NV	10	-1.29	-0.001627	±2.5	PASS
Band14	10MHz	QPSK	23330	50RB#0	NV	20	3.28	0.004136	±2.5	PASS
Band14	10MHz	QPSK	23330	50RB#0	NV	30	2.22	0.002808	±2.5	PASS
Band14	10MHz	QPSK	23330	50RB#0	NV	40	-2.49	-0.00314	±2.5	PASS
Band14	10MHz	QPSK	23330	50RB#0	NV	50	3.71	0.004678	±2.5	PASS
Band14	10MHz	16QAM	23330	50RB#0	NV	-30	1.39	0.001753	±2.5	PASS
Band14	10MHz	16QAM	23330	50RB#0	NV	-20	13.59	0.017137	±2.5	PASS
Band14	10MHz	16QAM	23330	50RB#0	NV	0	-2.76	-0.00348	±2.5	PASS



Test Report No.: W7L-P23100014RF09

Band14	10MHz	16QAM	23330	50RB#0	NV	10	13.58	0.017125	±2.5	PASS
Band14	10MHz	16QAM	23330	50RB#0	NV	20	-2.15	-0.002711	±2.5	PASS
Band14	10MHz	16QAM	23330	50RB#0	NV	30	-2.33	-0.002938	±2.5	PASS
Band14	10MHz	16QAM	23330	50RB#0	NV	40	2.09	0.002636	±2.5	PASS
Band14	10MHz	16QAM	23330	50RB#0	NV	50	-2.15	-0.002711	±2.5	PASS
Band14	10MHz	64QAM	23330	50RB#0	NV	-30	1.67	0.002106	±2.5	PASS
Band14	10MHz	64QAM	23330	50RB#0	NV	-20	-1.34	-0.00169	±2.5	PASS
Band14	10MHz	64QAM	23330	50RB#0	NV	0	-1.44	-0.001816	±2.5	PASS
Band14	10MHz	64QAM	23330	50RB#0	NV	10	14.32	0.018058	±2.5	PASS
Band14	10MHz	64QAM	23330	50RB#0	NV	20	2.15	0.002711	±2.5	PASS
Band14	10MHz	64QAM	23330	50RB#0	NV	30	-2.76	-0.00348	±2.5	PASS
Band14	10MHz	64QAM	23330	50RB#0	NV	40	2.07	0.00261	±2.5	PASS
Band14	10MHz	64QAM	23330	50RB#0	NV	50	2.76	0.00348	±2.5	PASS

LTE BAND26

PEAK-TO-AVERAGE RATIO(CCDF)

Test Result

Band	Bandwidth	Modulation	Channel	RB Configuration	Result(dB)	Limit(dB)	Verdict
Band26	1.4MHz	QPSK	26697	1RB#0	3.79	13	PASS
Band26	1.4MHz	QPSK	26697	6RB#0	5.13	13	PASS
Band26	1.4MHz	QPSK	26740	1RB#0	3.77	13	PASS
Band26	1.4MHz	QPSK	26740	6RB#0	5.15	13	PASS
Band26	1.4MHz	QPSK	26783	1RB#0	3.92	13	PASS
Band26	1.4MHz	QPSK	26783	6RB#0	5.30	13	PASS
Band26	1.4MHz	16QAM	26697	1RB#0	5.35	13	PASS
Band26	1.4MHz	16QAM	26697	6RB#0	5.91	13	PASS
Band26	1.4MHz	16QAM	26740	1RB#0	5.35	13	PASS
Band26	1.4MHz	16QAM	26740	6RB#0	6.05	13	PASS
Band26	1.4MHz	16QAM	26783	1RB#0	5.57	13	PASS
Band26	1.4MHz	16QAM	26783	6RB#0	6.14	13	PASS



Test Report No.: W7L-P23100014RF09

Band26	1.4MHz	64QAM	26697	1RB#0	6.37	13	PASS
Band26	1.4MHz	64QAM	26697	6RB#0	6.59	13	PASS
Band26	1.4MHz	64QAM	26740	1RB#0	6.29	13	PASS
Band26	1.4MHz	64QAM	26740	6RB#0	6.66	13	PASS
Band26	1.4MHz	64QAM	26783	1RB#0	6.47	13	PASS
Band26	1.4MHz	64QAM	26783	6RB#0	6.71	13	PASS
Band26	3MHz	QPSK	26705	1RB#0	3.61	13	PASS
Band26	3MHz	QPSK	26705	15RB#0	5.06	13	PASS
Band26	3MHz	QPSK	26740	1RB#0	3.62	13	PASS
Band26	3MHz	QPSK	26740	15RB#0	5.06	13	PASS
Band26	3MHz	QPSK	26775	1RB#0	3.69	13	PASS
Band26	3MHz	QPSK	26775	15RB#0	5.20	13	PASS
Band26	3MHz	16QAM	26705	1RB#0	5.22	13	PASS
Band26	3MHz	16QAM	26705	15RB#0	5.93	13	PASS
Band26	3MHz	16QAM	26740	1RB#0	5.13	13	PASS
Band26	3MHz	16QAM	26740	15RB#0	5.94	13	PASS
Band26	3MHz	16QAM	26775	1RB#0	5.29	13	PASS
Band26	3MHz	16QAM	26775	15RB#0	6.06	13	PASS
Band26	3MHz	64QAM	26705	1RB#0	6.32	13	PASS
Band26	3MHz	64QAM	26705	15RB#0	6.57	13	PASS
Band26	3MHz	64QAM	26740	1RB#0	6.23	13	PASS
Band26	3MHz	64QAM	26740	15RB#0	6.58	13	PASS
Band26	3MHz	64QAM	26775	1RB#0	6.35	13	PASS
Band26	3MHz	64QAM	26775	15RB#0	6.70	13	PASS
Band26	5MHz	QPSK	26715	1RB#0	3.62	13	PASS
Band26	5MHz	QPSK	26715	25RB#0	5.16	13	PASS
Band26	5MHz	QPSK	26740	1RB#0	3.64	13	PASS
Band26	5MHz	QPSK	26740	25RB#0	5.19	13	PASS
Band26	5MHz	QPSK	26765	1RB#0	3.65	13	PASS
Band26	5MHz	QPSK	26765	25RB#0	5.15	13	PASS
Band26	5MHz	16QAM	26715	1RB#0	5.26	13	PASS
Band26	5MHz	16QAM	26715	25RB#0	5.96	13	PASS
Band26	5MHz	16QAM	26740	1RB#0	5.15	13	PASS
Band26	5MHz	16QAM	26740	25RB#0	5.96	13	PASS
Band26	5MHz	16QAM	26765	1RB#0	5.26	13	PASS
Band26	5MHz	16QAM	26765	25RB#0	5.97	13	PASS
Band26	5MHz	64QAM	26715	1RB#0	6.23	13	PASS
Band26	5MHz	64QAM	26715	25RB#0	6.57	13	PASS
Band26	5MHz	64QAM	26740	1RB#0	6.32	13	PASS
Band26	5MHz	64QAM	26740	25RB#0	6.65	13	PASS
Band26	5MHz	64QAM	26765	1RB#0	6.10	13	PASS
Band26	5MHz	64QAM	26765	25RB#0	6.60	13	PASS
Band26	10MHz	QPSK	26740	1RB#0	3.58	13	PASS
Band26	10MHz	QPSK	26740	50RB#0	5.17	13	PASS
Band26	10MHz	16QAM	26740	1RB#0	5.01	13	PASS
Band26	10MHz	16QAM	26740	50RB#0	6.01	13	PASS
Band26	10MHz	64QAM	26740	1RB#0	6.40	13	PASS
Band26	10MHz	64QAM	26740	50RB#0	6.54	13	PASS

Test Graphs

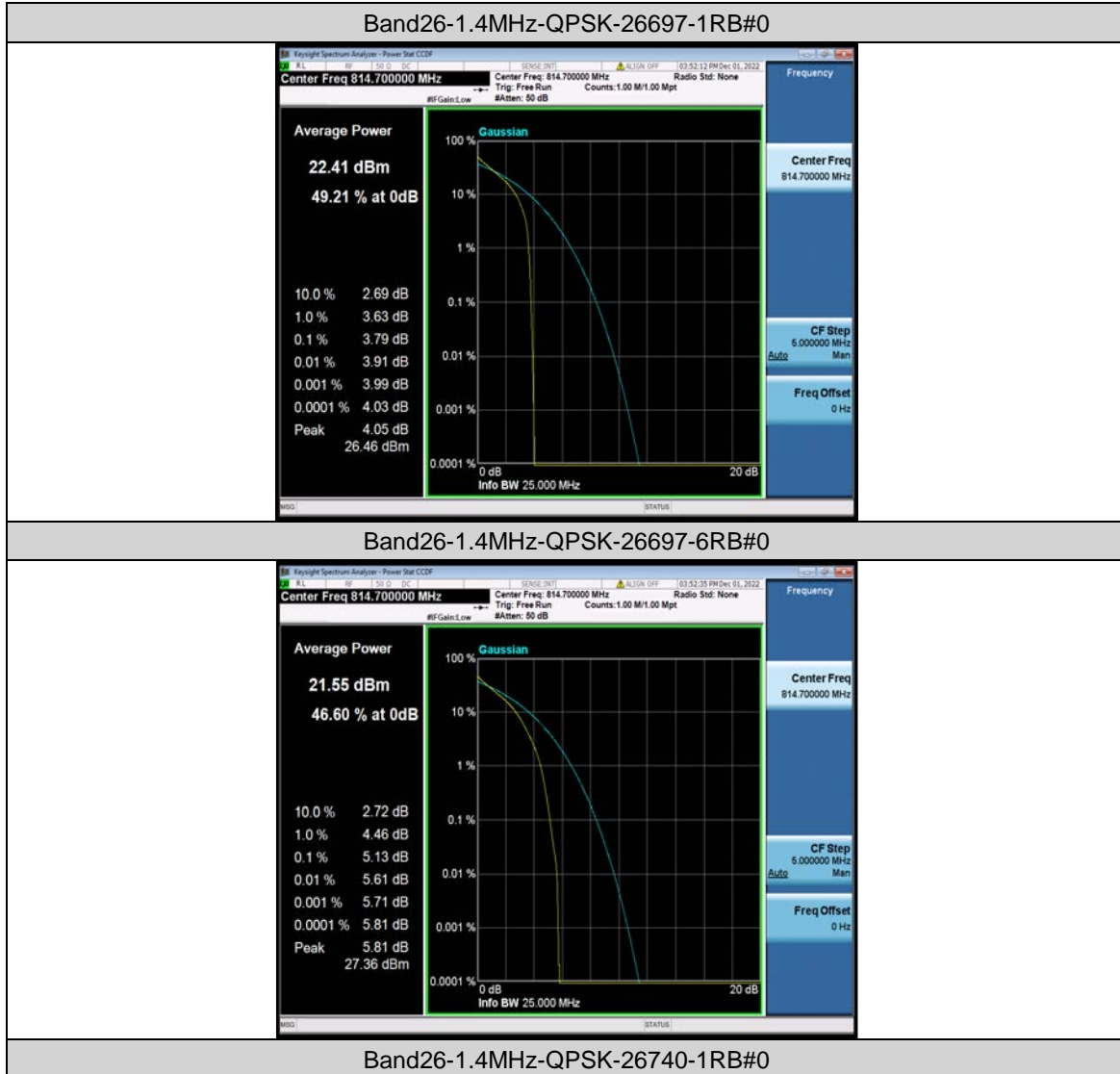



Test Report No.: W7L-P23100014RF09

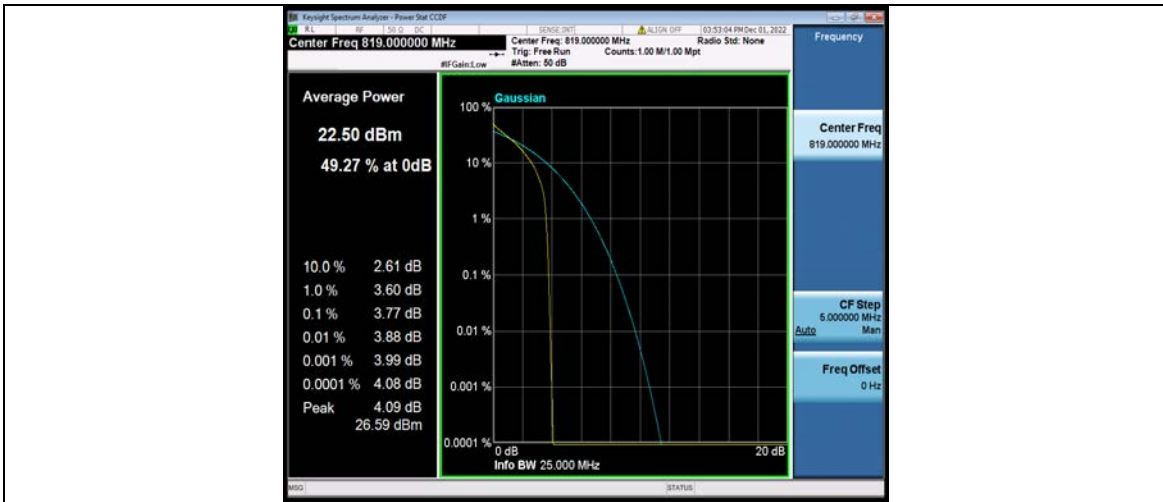

Band26-1.4MHz-QPSK-26740-6RB#0

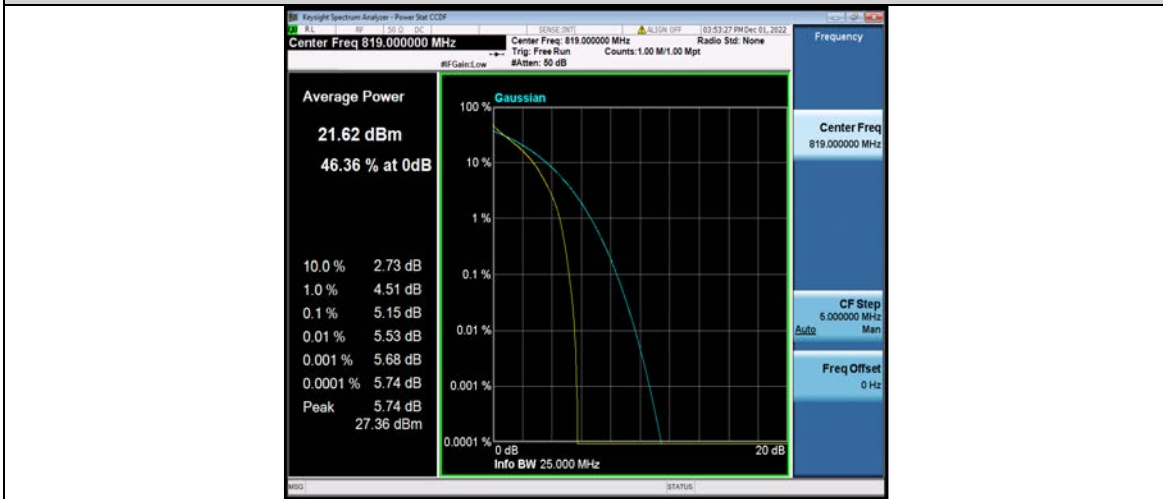

Band26-1.4MHz-QPSK-26783-1RB#0

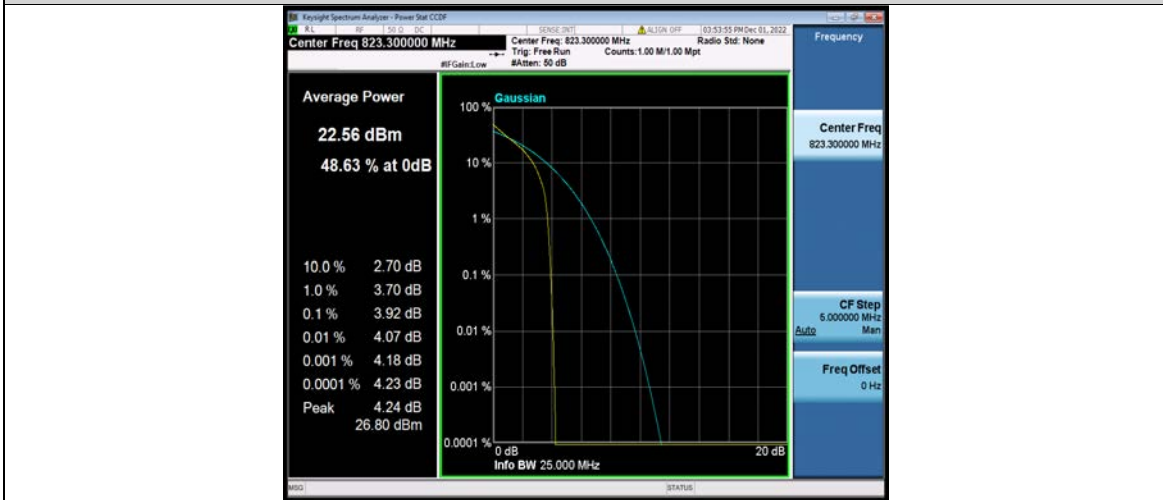

Band26-1.4MHz-QPSK-26783-6RB#0



Test Report No.: W7L-P23100014RF09

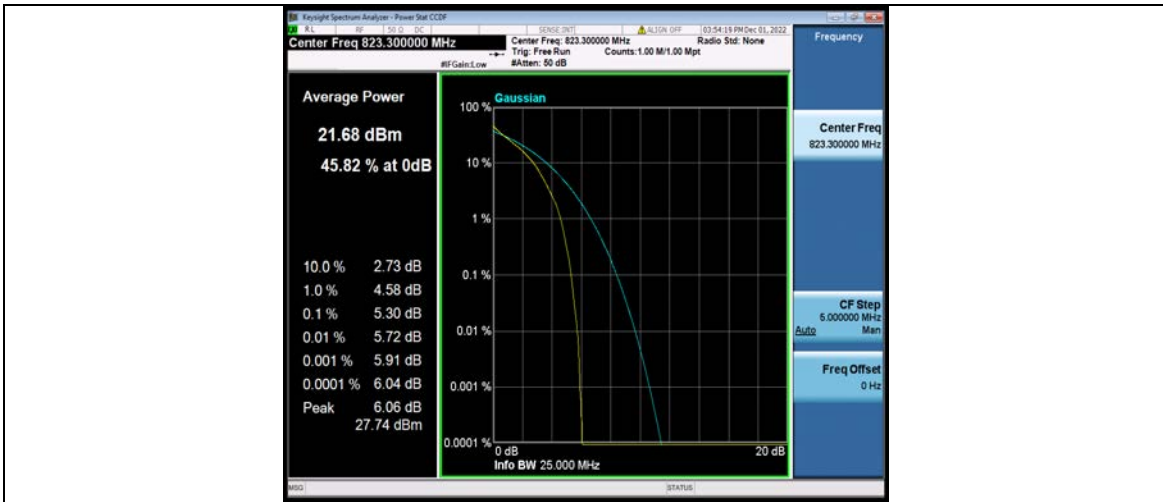

Band26-1.4MHz-16QAM-26697-1RB#0

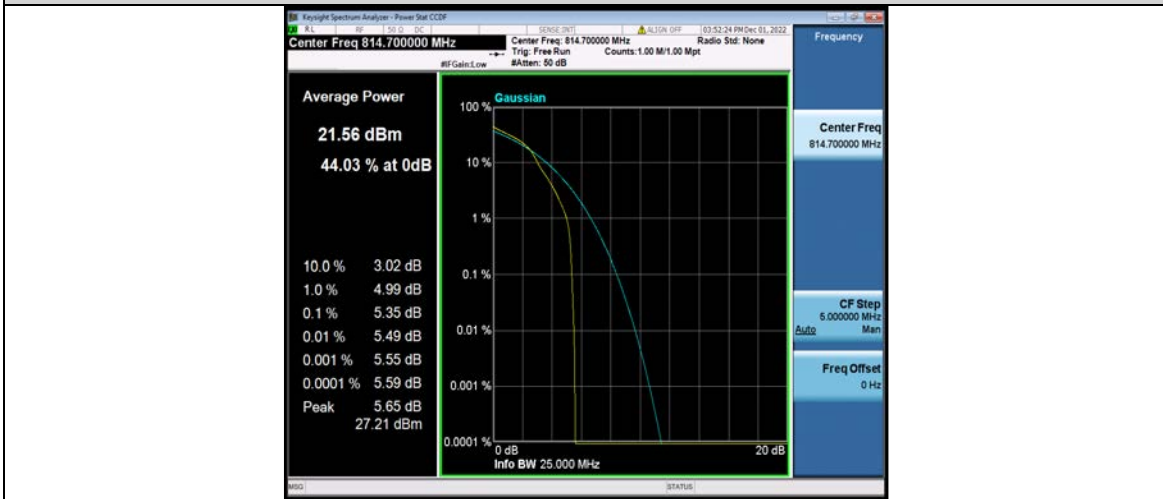

Band26-1.4MHz-16QAM-26697-6RB#0

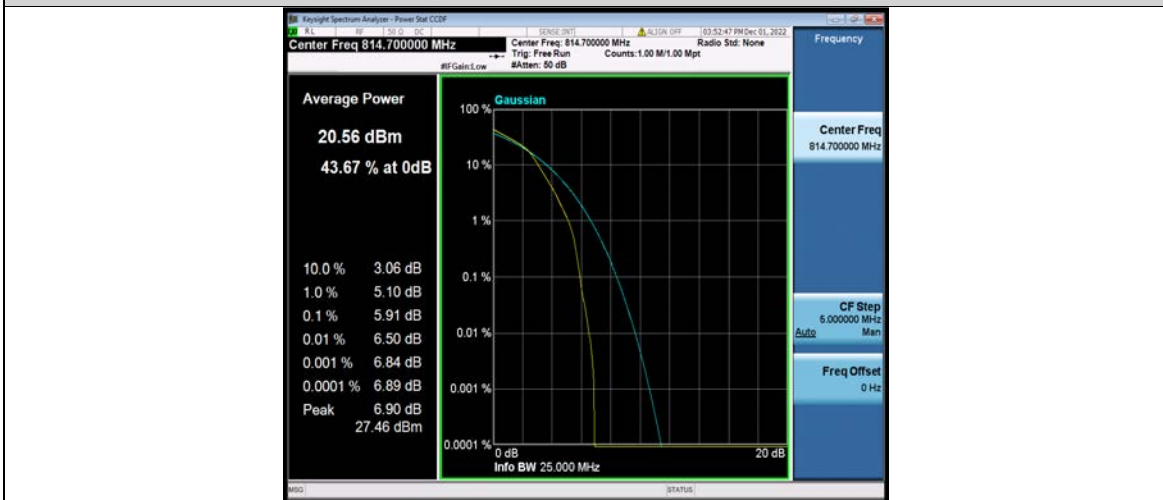

Band26-1.4MHz-16QAM-26740-1RB#0



Test Report No.: W7L-P23100014RF09

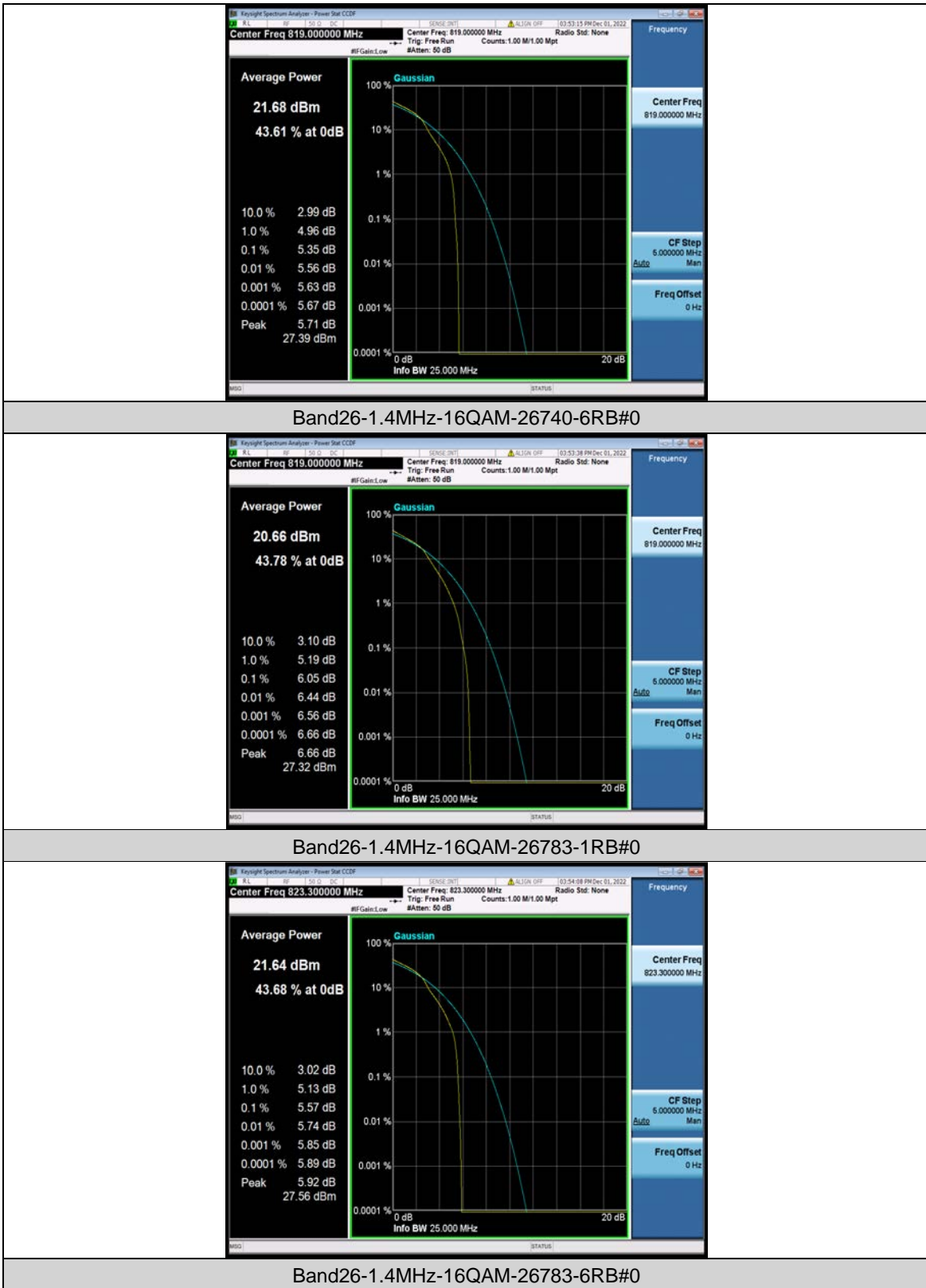



Test Report No.: W7L-P23100014RF09



Band26-1.4MHz-64QAM-26697-1RB#0

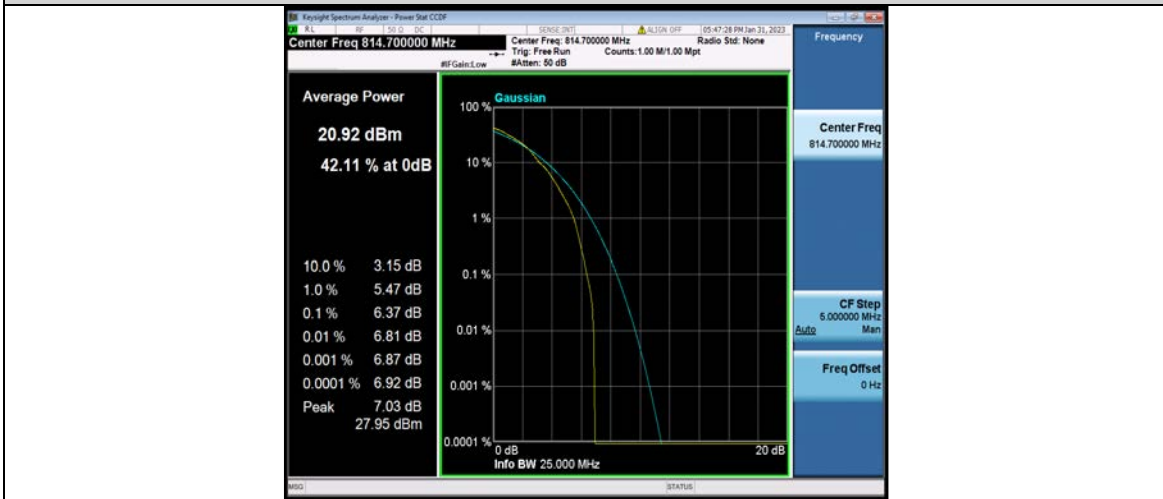

Band26-1.4MHz-64QAM-26697-6RB#0



Band26-1.4MHz-64QAM-26740-1RB#0