



Test Report No.: W7L-P23100014RF07



VARIANT FCC TEST REPORT (PART 27)

Applicant:	Nokia of America Corp
Address:	3201, Olympus Blvd, Dallas, TX 75019, USA

Manufacturer or Supplier:	Nokia of America Corp
Address:	3201, Olympus Blvd, Dallas, TX 75019, USA
Product:	Nokia Industrial 5G handheld HHRA501x
Brand Name:	Nokia
Model Name:	HHRA501a
Marketing Name:	Nokia Industrial 5G handheld HHRA501a
FCC ID:	2AVO2-HHRA501A
Date of tests:	Nov. 24, 2022 ~ Feb. 03, 2023

The tests have been carried out according to the requirements of the following standard:

- FCC Part 27 ANSI/TIA/EIA-603-D
- FCC Part 2 ANSI/TIA/EIA-603-E ANSI C63.26-2015

CONCLUSION: The submitted sample was found to COMPLY with the test requirement

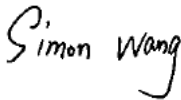
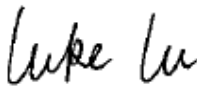
Prepared by Simon Wang Engineer / Mobile Department	Approved by Luke Lu Manager / Mobile Department
	
Date: Oct. 23, 2023	Date: Oct. 23, 2023

This report is governed by, and incorporates by reference, the Conditions of Testing as posted at the date of issuance of this report at <http://www.bureauveritas.com/home/about-us/our-business/cps/about-us/terms-conditions/> and is intended for your exclusive use. Any copying or replication of this report to or for any other person or entity, or use of our name or trademark, is permitted only with our prior written permission. This report sets forth our findings solely with respect to the test samples identified herein. The results set forth in this report are not indicative or representative of the quality or characteristics of the lot from which a test sample was taken or any similar or identical product unless specifically and expressly noted. Our report includes all of the tests requested by you and the results thereof based upon the information that you provided to us. Measurement uncertainty is only provided upon request for accredited tests. Statements of conformity are based on simple acceptance criteria without taking measurement uncertainty into account, unless otherwise requested in writing. You have 60 days from date of issuance of this report to notify us of any material error or omission caused by our negligence or if you require measurement uncertainty; provided, however, that such notice shall be in writing and shall specifically address the issue you wish to raise. A failure to raise such issue within the prescribed time shall constitute your unqualified acceptance of the completeness of this report, the tests conducted and the correctness of the report contents.



TABLE OF CONTENTS

RELEASE CONTROL RECORD 4

1 SUMMARY OF TEST RESULTS 5

1.1 MEASUREMENT UNCERTAINTY 7

1.2 TEST SITE AND INSTRUMENTS 8

2 GENERAL INFORMATION 10

2.1 GENERAL DESCRIPTION OF EUT 10

2.2 CONFIGURATION OF SYSTEM UNDER TEST 15

2.3 DESCRIPTION OF SUPPORT UNITS 16

2.4 TEST ITEM AND TEST CONFIGURATION 16

2.5 GENERAL DESCRIPTION OF APPLIED STANDARDS 24

3 TEST TYPES AND RESULTS 25

3.1 OUTPUT POWER MEASUREMENT 25

3.1.1 LIMITS OF OUTPUT POWER MEASUREMENT 25

3.1.2 TEST PROCEDURES 25

3.1.3 TEST SETUP 26

3.1.4 TEST RESULTS 27

3.2 FREQUENCY STABILITY MEASUREMENT 72

3.2.1 LIMITS OF FREQUENCY STABILITY MEASUREMENT 72

3.2.2 TEST PROCEDURE 72

3.2.3 TEST SETUP 72

3.2.4 TEST RESULTS 73

3.3 OCCUPIED BANDWIDTH MEASUREMENT 74

3.3.1 LIMITS OF OCCUPIED BANDWIDTH MEASUREMENT 74

3.3.2 TEST SETUP 74

3.3.3 TEST PROCEDURES 74

3.3.4 TEST RESULTS 75

3.4 BAND EDGE MEASUREMENT 76

3.4.1 LIMITS OF BAND EDGE MEASUREMENT 76

3.4.2 TEST SETUP 77

3.4.3 TEST PROCEDURES 78

3.4.4 TEST RESULTS 79

3.5 CONDUCTED SPURIOUS EMISSIONS 80

3.5.1 LIMITS OF CONDUCTED SPURIOUS EMISSIONS MEASUREMENT 80

3.5.2 TEST PROCEDURE 80

3.5.3 TEST SETUP 80

3.5.4 TEST RESULTS 81

3.6 RADIATED EMISSION MEASUREMENT 82

3.6.1 LIMITS OF RADIATED EMISSION MEASUREMENT 82

3.6.2 TEST PROCEDURES 82

3.6.3 DEVIATION FROM TEST STANDARD 82

3.6.4 TEST SETUP 83

3.6.5 TEST RESULTS 85

3.7 PEAK TO AVERAGE RATIO 127

3.7.1 LIMITS OF PEAK TO AVERAGE RATIO MEASUREMENT 127

3.7.2 TEST SETUP 127

3.7.3 TEST PROCEDURES 127

3.7.4 TEST RESULTS 128

4 INFORMATION ON THE TESTING LABORATORIES 129



**BUREAU
VERITAS**

Test Report No.: W7L-P23100014RF07

5 MODIFICATIONS RECORDERS FOR ENGINEERING CHANGES TO THE EUT BY THE LAB.	130
6 APPENDIX	131
LTE BAND41 (INCLUDING LTE BAND38)	131
LTE BAND42	229
LTE BAND66 (INCLUDING LTE BAND4)	314



Test Report No.: W7L-P23100014RF07

RELEASE CONTROL RECORD

ISSUE NO.	REASON FOR CHANGE	DATE ISSUED
W7L-P22110036RF07	Original release	Feb. 03, 2023
W7L-P23100014RF07	Based on the original product changing the model name and FCC ID, brand name, marketing name, product name, battery model, applicant and manufacturer information.	Oct. 23, 2023



1 SUMMARY OF TEST RESULTS

The EUT has been tested according to the following specifications:

APPLIED STANDARD: FCC PART 27 & PART 2			
STANDARD SECTION	TEST TYPE AND LIMIT	RESULT	TEST LAB*
§2.1046	Conducted Output Power	Compliance	A
§27.50(d)(4) §27.50(h)(2) §27.50(k)(3)	Equivalent Isotropically Radiated Power (Band 4) (Band 38) (Band 41) (Band 42) (Band 66)	Compliance	A
§2.1055 §27.54	Frequency Stability	Compliance	A
§2.1049	Occupied Bandwidth	Compliance	A
§2.1051 §27.53(h) §27.53(m)(4)(6) §27.53(n)(2)	Conducted Band Edge Measurements (Band 4) (Band 38) (Band 41) (Band 42) (Band 66)	Compliance	A
§2.1051 §27.53(h) §27.53(m)(4)(6) §27.53(n)(2)	Conducted Spurious Emissions (Band 4) (Band 38) (Band 41) (Band 42) (Band 66)	Compliance	A
§2.1053 §27.53(h) §27.53(m)(4)(6) §27.53(n)(2)	Radiated Spurious Emissions (Band 4) (Band 38) (Band 41) (Band 42) (Band 66)	Compliance	A/B
§27.50(k)(4)	Peak to average ratio	Compliance	A



Test Report No.: W7L-P23100014RF07

***Test Lab Information Reference**

Lab A:

BV 7Layers Communications Technology (Shenzhen) Co., Ltd

Lab Address:

No.B102, Dazu Chuangxin Mansion, North of Beihuan Avenue, North Area, Hi-Tech Industrial Park, Nanshan District, Shenzhen, Guangdong, China

Accredited Test Lab Cert 3939.01

The FCC Site Registration No. : 525120; Designation No. : CN1171;

Lab B:

Huarui 7Layers High Technology (Suzhou) Co., Ltd.

Lab Address:

Tower N, Innovation Center, 88 Zhuyi Road, High-tech District, Suzhou City, Anhui Province

Accredited Test Lab Cert 6613.01

The FCC Site Registration No. is 434559; The Designation No. is CN1325.

1.1 MEASUREMENT UNCERTAINTY

Where relevant, the following measurement uncertainty levels have been estimated for tests performed on the EUT as specified in CISPR 16-4-2:

MEASUREMENT	UNCERTAINTY
Frequency Stability	±76.97Hz
Radiated emissions (9KHz~30MHz)	±2.68dB
Radiated emissions & Radiated Power (30MHz~1GHz)	±4.98dB
Radiated emissions & Radiated Power (1GHz ~6GHz)	±4.70dB
Radiated emissions (6GHz ~18GHz)	±4.60dB
Radiated emissions (18GHz ~40GHz)	±4.12dB
Conducted emissions	±4.01dB
Occupied Channel Bandwidth	±43.58KHz
Conducted Output power	±2.06dB
Band Edge Measurements	±4.70dB

This uncertainty represents an expanded uncertainty expressed at approximately the 95% confidence level using a coverage factor of k=2.



1.2 TEST SITE AND INSTRUMENTS

Equipment	Manufacturer	Model No.	Serial No.	Last Cal.	Next Cal.
MXE EMI Receiver	KEYSIGHT	N9038A-544	MY54450026	Feb. 21,22	Feb. 20,23
EXA Signal Analyzer	KEYSIGHT	N9010A-544	MY54510355	May.15,22	May.14,23
Loop Antenna	Schwarzbeck	FMZB 1519B	00173	Sep.04,22	Sep.03,23
Bilog Antenna	ETS-LINDGRE N	3143B	00161965	Mar. 06,22	Mar. 05,23
Horn Antenna	ETS-LINDGRE N	3117	00168692	Mar. 06,22	Mar. 05,23
Horn Antenna (18GHz-40GHz)	N/A	QWH-SL-18-40-K- SG/QMS-00361	15433	Aug. 24, 22	Aug. 23, 23
Radio Communication Analyzer	ANRITSU	MT8820C	6201465426	Feb. 15,22	Feb. 14,23
Signal Pre-Amplifier	EMSI	EMC 9135	980249	May.12,22	May.11,23
Signal Pre-Amplifier	EMSI	EMC 012645B	980257	May.12,22	May.11,23
Signal Pre-Amplifier	EMSI	EMC 184045B	980259	Feb. 21,22	Feb.20,23
3m Semi-anechoic Chamber	ETS-LINDGRE N	9m*6m*6m	Euroshieldpn- CT0001143-121 6	May. 19,20	May. 18,23
Test Software	E3	V 9.160323	N/A	N/A	N/A
Test Software	JS1120	3.1.36	N/A	N/A	N/A
10dB Attenuator	JFW/USA	50HF-010-SMA	1505	May. 07,22	May. 06,23
Power Meter	Anritsu	ML2495A	1506002	Feb. 22,22	Feb. 21,23
Power Sensor	Anritsu	MA2411B	1339352	May. 07,22	May. 06,23
Temperature Chamber	ESPEC	SH-242	93000855	May. 12,22	May. 11,23
MXG Analog Microvave Signal Generator	KEYSIGHT	N5183A	MY50143024	Feb. 18,22	Feb. 17,23
Base station R&S CMW500	Rohde&Schwa rz	CMW500	153085	May.12,22	May.11,23
DC Source	Kikusui/JP	PMX18-5A	0000001	Aug. 24,22	Aug. 23,23

- NOTE:**
1. The calibration interval of the above test instruments is 12 months or 36 months and the calibrations are traceable to CEPREI/CHINA, GRGT/CHINA and NIM/CHINA.
 2. The test was performed in 3m Semi-anechoic Chamber and RF Oven Room.
 3. The horn antenna is used only for the measurement of emission frequency above 1GHz if tested.
 4. The FCC Site Registration No. is 525120; The Designation No. is CN1171.



**BUREAU
VERITAS**

Test Report No.: W7L-P23100014RF07

Equipment	Manufacturer	Model No.	Serial No.	Last Cal.	Next Cal.
Pre-Amplifier	R&S	SCU18F1	100815	Aug.30,22	Aug.29,24
Pre-Amplifier	R&S	SCU08F1	101028	Sep.16,22	Sep.15,24
Vector Signal Generator	R&S	SMBV100B	102176	Feb.16,22	Feb.15,24
Signal Generator	R&S	SMB100A	182185	Feb.16,22	Feb.15,24
3m Fully-anechoic Chamber	TDK	9m*6m*6m	HRSW-SZ-EMC-01Chamber	Nov.25,22	Nov.24,25
3m Semi-anechoic Chamber	TDK	9m*6m*6m	HRSW-SZ-EMC-02Chamber	Nov.25,22	Nov.24,25
EMI TEST Receiver	R&S	ESR26	101734	Feb.25,22	Feb.24,24
EMI TEST Receiver	R&S	ESW44	101973	Feb.25,22	Feb.24,24
Bilog Antenna	SCHWARZBECK	VULB 9163	1264	Feb.28,22	Feb.27,24
Horn Antenna	ETS-LINDGREN	3117	227836	Aug.22,22	Aug.21,24
Horn Antenna (18GHz-40GHz)	Steatite Q-par Antennas	QMS 00880	23486	Feb.23,22	Feb.22,24
Horn Antenna	Steatite Q-par Antennas	QMS 00208	23485	Aug.22,22	Aug.21,24
Loop Antenna	SCHWARZ	HFH2-Z2/Z2E	100976	Feb.23,22	Feb.22,24
WIDEBANDRADIO COMMUNICATION TESTER	R&S	CMW500	169399	Jun.27,22	Jun.26,24
Test Software	EMC32	EMC32	N/A	N/A	N/A
Test Software	ELEKTRA	ELEKTRA4.32	N/A	N/A	N/A
Open Switch and Control Unit	R&S	OSP220	101964	Oct.01,22	Sep.30,24
DC Source	HYELEC	HY3010B	551016	Aug.31,22	Aug.30,24
Hygrothermograph	DELI	20210528	SZ014	Sep.06,22	Sep.05,24
PC	LENOVO	E14	HRSW0024	N/A	N/A
TMC-AMI18843A(CABLE)	R&S	HF290-NMNM-7.00M	N/A	N/A	N/A
TMC-AMI18843A(CABLE)	R&S	HF290-NMNM-4.00M	N/A	N/A	N/A
CABLE	R&S	W13.02	N/A	Oct.31,22	Apr.29,23
CABLE	R&S	W12.14	N/A	Oct.31,22	Apr.29,23
CABLE	R&S	J12J103539-00-1	SEP-03-20-069	Oct.31,22	Apr.29,23
CABLE	R&S	J12J103539-00-1	SEP-03-20-070	Oct.31,22	Apr.29,23
Temperature Chamber	votsch	VT4002	58566078100050	May.31,22	May.30,24

- NOTE:**
1. The calibration interval of the above test instruments is 12 months or 36 months and the calibrations are traceable to CEPREI/CHINA, GRGT/CHINA and NIM/CHINA.
 2. The test was performed in 3m Semi-anechoic Chamber and RF Oven Room.
 3. The horn antenna is used only for the measurement of emission frequency above 1GHz if tested.
 4. The FCC Site Registration No. is 434559; The Designation No. is CN1325.

2 GENERAL INFORMATION

2.1 GENERAL DESCRIPTION OF EUT

PRODUCT	Nokia Industrial 5G handheld HHRA501x	
BRAND NAME	Nokia	
MODEL NAME	HHRA501a	
MARKETING NAME	Nokia Industrial 5G handheld HHRA501a	
NOMINAL VOLTAGE	5.0Vdc(adapter or host equipment) 3.7Vdc (Li-ion, battery)	
MODULATION TECHNOLOGY	LTE	QPSK, 16QAM, 64QAM
FREQUENCY RANGE	LTE Band 4 Channel Bandwidth: 1.4MHz	1710.7MHz ~ 1754.3MHz
	LTE Band 4 Channel Bandwidth: 3MHz	1711.5MHz ~ 1753.5MHz
	LTE Band 4 Channel Bandwidth: 5MHz	1712.5MHz ~ 1752.5MHz
	LTE Band 4 Channel Bandwidth: 10MHz	1715MHz ~ 1750MHz
	LTE Band 4 Channel Bandwidth: 15MHz	1717.5MHz ~ 1747.5 MHz
	LTE Band 4 Channel Bandwidth: 20MHz	1720MHz ~ 1745MHz
	LTE Band 38 Channel Bandwidth: 5MHz	2572.5MHz ~ 2617.5MHz
	LTE Band 38 Channel Bandwidth: 10MHz	2575MHz ~ 2615MHz
	LTE Band 38 Channel Bandwidth: 15MHz	2577.5MHz ~ 2612.5MHz
	LTE Band 38 Channel Bandwidth: 20MHz	2580MHz ~ 2610MHz
	LTE Band 41 Channel Bandwidth: 5MHz	2498.5MHz ~ 2687.5MHz
	LTE Band 41 Channel Bandwidth: 10MHz	2501MHz ~ 2685MHz
	LTE Band 41 Channel Bandwidth: 15MHz	2503.5MHz ~ 2682.5MHz
	LTE Band 41 Channel Bandwidth: 20MHz	2506MHz ~ 2680MHz
	LTE Band 42 Channel Bandwidth: 5MHz	3452.5 MHz ~ 3547.5MHz
	LTE Band 42 Channel Bandwidth: 10MHz	3455MHz ~ 3545MHz



BUREAU
VERITAS

Test Report No.: W7L-P23100014RF07

FREQUENCY RANGE	LTE Band 42 Channel Bandwidth: 15MHz	3457.5MHz ~ 3542.5MHz
	LTE Band 42 Channel Bandwidth: 20MHz	3460MHz ~ 3540MHz
	LTE Band 66 Channel Bandwidth: 1.4MHz	1710.7MHz ~ 1779.3MHz
	LTE Band 66 Channel Bandwidth: 3MHz	1711.5MHz ~ 1778.5MHz
	LTE Band 66 Channel Bandwidth: 5MHz	1712.5MHz ~ 1777.5MHz
	LTE Band 66 Channel Bandwidth: 10MHz	1715MHz ~ 1775MHz
	LTE Band 66 Channel Bandwidth: 15MHz	1717.5MHz ~ 1772.5MHz
	LTE Band 66 Channel Bandwidth: 20MHz	1720MHz ~ 1770MHz
MAX. EIRP POWER	LTE Band 4 Channel Bandwidth: 1.4MHz	220.8mW
	LTE Band 4 Channel Bandwidth: 3MHz	218.78mW
	LTE Band 4 Channel Bandwidth: 5MHz	220.8mW
	LTE Band 4 Channel Bandwidth: 10MHz	218.78mW
	LTE Band 4 Channel Bandwidth: 15MHz	218.27mW
	LTE Band 4 Channel Bandwidth: 20MHz	221.31mW
	LTE Band 38 Channel Bandwidth: 5MHz	132.13mW
	LTE Band 38 Channel Bandwidth: 10MHz	132.43mW
	LTE Band 38 Channel Bandwidth: 15MHz	132.74mW
	LTE Band 38 Channel Bandwidth: 20MHz	132.66mW
	LTE Band 41 Channel Bandwidth: 5MHz	135.21mW
	LTE Band 41 Channel Bandwidth: 10MHz	134.28mW
	LTE Band 41 Channel Bandwidth: 15MHz	136.46mW
	LTE Band 41 Channel Bandwidth: 20MHz	136.77mW



Test Report No.: W7L-P23100014RF07

MAX. EIRP POWER	LTE Band 42 Channel Bandwidth: 5MHz	138.04mW
	LTE Band 42 Channel Bandwidth: 10MHz	137.4mW
	LTE Band 42 Channel Bandwidth: 15MHz	137.09mW
	LTE Band 42 Channel Bandwidth: 20MHz	138.68mW
	LTE Band 66 Channel Bandwidth: 1.4MHz	252.93mW
	LTE Band 66 Channel Bandwidth: 3MHz	254.68mW
	LTE Band 66 Channel Bandwidth: 5MHz	255.27mW
	LTE Band 66 Channel Bandwidth: 10MHz	252.93mW
	LTE Band 66 Channel Bandwidth: 15MHz	252.93mW
	LTE Band 66 Channel Bandwidth: 20MHz	255.86mW
	EMISSION DESIGNATOR	LTE Band 41 Channel Bandwidth: 5MHz
16QAM: 4M50W7D		
64QAM: 4M50W7D		
LTE Band 41 Channel Bandwidth: 10MHz		QPSK: 8M98G7D
		16QAM: 8M98W7D
		64QAM: 8M98W7D
LTE Band 41 Channel Bandwidth: 15MHz		QPSK: 13M5G7D
		16QAM: 13M5W7D
		64QAM: 13M5W7D
LTE Band 41 Channel Bandwidth: 20MHz		QPSK: 18M0G7D
		16QAM: 18M0W7D
		64QAM: 18M0W7D
LTE Band 42 Channel Bandwidth: 5MHz		QPSK: 4M50G7D
		16QAM: 4M50W7D
		64QAM: 4M50W7D
LTE Band 42 Channel Bandwidth: 10MHz		QPSK: 8M99G7D
		16QAM: 8M99W7D
		64QAM: 8M98W7D



Test Report No.: W7L-P23100014RF07

EMISSION DESIGNATOR	LTE Band 42 Channel Bandwidth: 15MHz	QPSK: 13M5G7D
		16QAM: 13M5W7D
		64QAM: 13M5W7D
	LTE Band 42 Channel Bandwidth: 20MHz	QPSK: 17M9G7D
		16QAM: 17M9W7D
		64QAM: 18M0W7D
	LTE Band 66 Channel Bandwidth: 1.4MHz	QPSK: 1M09G7D
		16QAM: 1M09W7D
		64QAM: 1M09W7D
	LTE Band 66 Channel Bandwidth: 3MHz	QPSK: 2M70G7D
		16QAM: 2M69W7D
		64QAM: 2M70W7D
LTE Band 66 Channel Bandwidth: 5MHz	QPSK: 4M50G7D	
	16QAM: 4M50W7D	
	64QAM: 4M50W7D	
LTE Band 66 Channel Bandwidth: 10MHz	QPSK: 9M00G7D	
	16QAM: 8M99W7D	
	64QAM: 8M98W7D	
LTE Band 66 Channel Bandwidth: 15MHz	QPSK: 13M5G7D	
	16QAM: 13M5W7D	
	64QAM: 13M5W7D	
LTE Band 66 Channel Bandwidth: 20MHz	QPSK: 18M0G7D	
	16QAM: 18M0W7D	
	64QAM: 18M0W7D	
ANTENNA TYPE	PIFA Antenna with 0.4dBi gain for LTE4 PIFA Antenna with -1.5dBi gain for LTE38 PIFA Antenna with -1.5dBi gain for LTE41 PIFA Antenna with -1.3dBi gain for LTE42 PIFA Antenna with 0.4dBi gain for LTE66	
HW VERSION	V02	
SW VERSION	IS540_ROW_00.00_1_20221017	
I/O PORTS	Refer to user's manual	



BUREAU
VERITAS

Test Report No.: W7L-P23100014RF07

CABLE SUPPLIED	USB cable1: non-shielded cable, with w/o ferrite core, 1.0 meter USB cable2: non-shielded cable, with w/o ferrite core, 1.0 meter
EXTREME TEMPERATURE	-10-50 °C
EXTREME VOLTAGE	3.6V - 4.2V

NOTE:

1. For a more detailed features description, please refer to the manufacturer's specifications or the user's manual.
2. The EUT incorporates a SISO function. Physically, the EUT provides one completed transmitter and one receiver.

MODULATION MODE	TX FUNCTION
LTE	1TX/1RX

3. For the test results, the EUT had been tested with all conditions. But only the worst case was shown in test report.

List of Accessory:

ACCESSORIES	BRAND	MANUFACTURER	MODEL	SPECIFICATION
Battery	N/A	FPR Connectivity Technology Inc.	BL440ACP	Capacity: 3.7Vdc, 4400mAh
AC Adapter	N/A	SHENZHEN SHI YINGYUAN POWER SUPPLY TECHNOLOGY CO., LTD.	ICP12-050-2000B	I/P: 100-240Vac, 0.3A, O/P: 5.0Vdc, 2A
USB Cable 1	N/A	Winpower Technology Co., LTD	PROTECTOR 2.0	Signal Line,1.0meter
USB Cable 2	N/A	Winpower Technology Co., LTD	USB2.0	Signal Line,1.0meter

2.2 CONFIGURATION OF SYSTEM UNDER TEST

FOR RADIATION EMISSION TEST

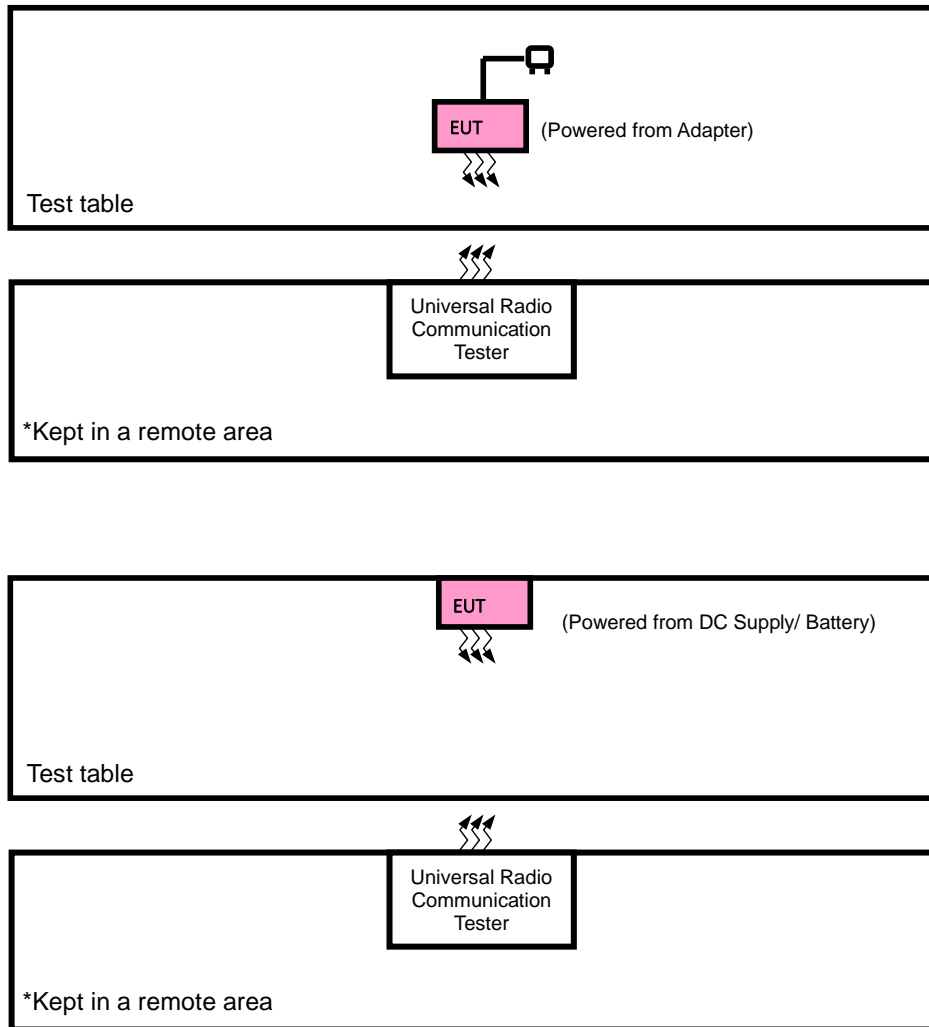



2.3 DESCRIPTION OF SUPPORT UNITS

The EUT has been tested as an independent unit together with other necessary accessories or support units. The following support units or accessories were used to form a representative test configuration during the tests.

NO.	PRODUCT	BRAND	MODEL NO.	SERIAL NO.	FCC ID
1	DC source	LONG WEI	PS-6403D	010934269	N/A

NO.	SIGNAL CABLE DESCRIPTION OF THE ABOVE SUPPORT UNITS
1	DC Line: Unshielded, Detachable 1.8m

2.4 TEST ITEM AND TEST CONFIGURATION

Pre-Scan has been conducted to determine the worst-case mode from all possible combinations between available modulations, data rates, XYZ axis and antenna ports. The worst case was found when positioned on Y-plane for EIRP and X-axis for radiated emission. Following channel(s) was (were) selected for the final test as listed below:

EUT CONFIGURE MODE	DESCRIPTION
A	EUT + Adapter + USB Cable with LTE link
B	EUT + DC Supply with LTE link

LTE BAND 4 MODE

EUT CONFIGURE MODE	TEST ITEM	AVAILABLE CHANNEL	TESTED CHANNEL	CHANNEL BANDWIDTH	MODULATION	MODE
A	EIRP	19957 to 20393	19957, 20175, 20393	1.4MHz	QPSK, 16QAM, 64QAM	1 RB / 0 RB Offset
		19965 to 20385	19965, 20175, 20385	3MHz	QPSK, 16QAM, 64QAM	1 RB / 0 RB Offset
		19975 to 20375	19975, 20175, 20375	5MHz	QPSK, 16QAM, 64QAM	1 RB / 0 RB Offset
		20000 to 20350	20000, 20175, 20350	10MHz	QPSK, 16QAM, 64QAM	1 RB / 0 RB Offset
		20025 to 20325	20025, 20175, 20325	15MHz	QPSK, 16QAM, 64QAM	1 RB / 0 RB Offset
		20050 to 20300	20050, 20175, 20300	20MHz	QPSK, 16QAM, 64QAM	1 RB / 0 RB Offset

Note: 1. This device was tested under all bandwidths, RB configurations and modulations. The worst case was found in QPSK modulation.

2. LTE Band 4 are covered by LTE Band 66, Because it is a subset of LTE Band 66 with the same output power and supported bandwidths, So the conducted test data and RSE test data please refer to LTE Band 66



LTE BAND 38 MODE

EUT CONFIGURE MODE	TEST ITEM	AVAILABLE CHANNEL	TESTED CHANNEL	CHANNEL BANDWIDTH	MODULATION	MODE
A	EIRP	37775 to 38225	37775, 38000, 38225	5MHz	QPSK, 16QAM, 64QAM	1 RB / 0 RB Offset
		37800 to 38200	37800, 38000, 38200	10MHz	QPSK, 16QAM, 64QAM	1 RB / 0RB Offset
		37825 to 38175	37825, 38000, 38175	15MHz	QPSK, 16QAM, 64QAM	1 RB / 0 RB Offset
		37850 to 38150	37850, 38000, 38150	20MHz	QPSK, 16QAM, 64QAM	1 RB / 0 RB Offset

Note: 1.This device was tested under all bandwidths, RB configurations and modulations. The worst case was found in QPSK modulation.

2. LTE Band 38 are covered by LTE Band 41, Because it is a subset of LTE Band 41 with the same output power and supported bandwidths, So the conducted test data and RSE test data please refer to LTE Band 41

LTE BAND 41 MODE

EUT CONFIGURE MODE	TEST ITEM	AVAILABLE CHANNEL	TESTED CHANNEL	CHANNEL BANDWIDTH	MODULATION	MODE
A	EIRP	39675 to 41565	39675, 40620, 41565	5MHz	QPSK, 16QAM, 64QAM	1 RB / 0 RB Offset
		39700 to 41540	39700, 40620,41540	10MHz	QPSK, 16QAM, 64QAM	1 RB / 0RB Offset
		39725 to 41515	39725, 40620, 41515	15MHz	QPSK, 16QAM, 64QAM	1 RB / 0 RB Offset
		39750 to 41490	39750, 40620, 41490	20MHz	QPSK, 16QAM, 64QAM	1 RB / 0 RB Offset
B	FREQUENCY STABILITY	39675 to 41565	39675, 41565	5MHz	QPSK, 16QAM, 64QAM	1 RB / 0 RB Offset
		39700 to 41540	39700, 41540	10MHz	QPSK, 16QAM, 64QAM	1 RB / 0RB Offset
		39725 to 41515	39725, 41515	15MHz	QPSK, 16QAM, 64QAM	1 RB / 0 RB Offset
		39750 to 41490	39750, 41490	20MHz	QPSK, 16QAM, 64QAM	1 RB / 0 RB Offset
A	OCCUPIED BANDWIDTH	39675 to 41565	39675, 40620, 41565	5MHz	QPSK, 16QAM, 64QAM	25 RB / 0 RB Offset
		39700 to 41540	39700, 40620,41540	10MHz	QPSK, 16QAM, 64QAM	50 RB / 0 RB Offset
		39725 to 41515	39725, 40620, 41515	15MHz	QPSK, 16QAM, 64QAM	75 RB / 0 RB Offset
		39750 to 41490	39750, 40620, 41490	20MHz	QPSK, 16QAM, 64QAM	100 RB / 0 RB Offset
A	PEAK TO AVERAGE RATIO	39675 to 41565	39675, 40620, 41565	5MHz	QPSK, 16QAM, 64QAM	1 RB / 0 RB Offset 25 RB / 0 RB Offset
		39700 to 41540	39700, 40620,41540	10MHz	QPSK, 16QAM, 64QAM	1 RB / 0 RB Offset 50 RB / 0 RB Offset
		39725 to 41515	39725, 40620, 41515	15MHz	QPSK, 16QAM, 64QAM	1 RB / 0 RB Offset 75 RB / 0 RB Offset
		39750 to 41490	39750, 40620, 41490	20MHz	QPSK, 16QAM, 64QAM	1 RB / 0 RB Offset 100 RB / 0 RB Offset

A	BAND EDGE	39675 to 41565	39675	5MHz	QPSK, 16QAM, 64QAM	1 RB / 0 RB Offset		
			41565	5MHz	QPSK, 16QAM, 64QAM	25 RB / 0 RB Offset		
		39700 to 41540	39700	10MHz	QPSK, 16QAM, 64QAM	1 RB / 24 RB Offset		
			41540	10MHz	QPSK, 16QAM, 64QAM	25 RB / 0 RB Offset		
		39725 to 41515	39725	15MHz	QPSK, 16QAM, 64QAM	1 RB / 0 RB Offset		
			41515	15MHz	QPSK, 16QAM, 64QAM	50 RB / 0 RB Offset		
		39750 to 41490	39750	20MHz	QPSK, 16QAM, 64QAM	1 RB / 49 RB Offset		
			41490	20MHz	QPSK, 16QAM, 64QAM	50 RB / 0 RB Offset		
		A	CONDCUDET ED EMISSION	39675 to 41565	39675, 40620, 41565	5MHz	QPSK, 16QAM, 64QAM	1 RB / 0 RB Offset
				39700 to 41540	39700, 40620, 41540	10MHz	QPSK, 16QAM, 64QAM	75 RB / 0 RB Offset
				39725 to 41515	39725, 40620, 41515	15MHz	QPSK, 16QAM, 64QAM	1 RB / 74 RB Offset
				39750 to 41490	39750, 40620, 41490	20MHz	QPSK, 16QAM, 64QAM	75 RB / 0 RB Offset
A	RADIATED EMISSION	39675 to 41565	40620	5MHz	QPSK	1 RB / 0 RB Offset		
		39700 to 41540	39700, 40620, 41540	10MHz	QPSK	100 RB / 0 RB Offset		
		39725 to 41515	40620	15MHz	QPSK	1 RB / 99 RB Offset		
		39750 to 41490	40620	20MHz	QPSK	100 RB / 0 RB Offset		

Note: This device was tested under all bandwidths, RB configurations and modulations. The worst case was found in QPSK modulation.



Test Report No.: W7L-P23100014RF07

LTE band 42

EUT CONFIGURE MODE	TEST ITEM	AVAILABLE CHANNEL	TESTED CHANNEL	CHANNEL BANDWIDTH	MODULATION	MODE
A	EIRP	42115 to 43565	42115 (3452.5MHz), 42840 (3525.0MHz), 43565 (3597.5MHz)	5MHz	QPSK, 16QAM, 64QAM	1 RB / 0 RB Offset
		42140 to 43540	42140 (3455.0MHz), 42840 (3525.0MHz), 43540 (3595.0MHz)	10MHz	QPSK, 16QAM, 64QAM	1 RB / 0 RB Offset
		42165 to 43515	42165 (3457.50MHz), 42840 (3525.0MHz), 43515 (3592.5MHz)	15MHz	QPSK, 16QAM, 64QAM	1 RB / 0 RB Offset
		42190 to 43490	42190 (3460.0MHz), 42840 (3525.0MHz), 43490 (3590.0MHz)	20MHz	QPSK, 16QAM, 64QAM	1 RB / 0 RB Offset
B	FREQUENCY STABILITY	42115 to 43565	42115 (3452.5MHz), 42840 (3525.0MHz), 43565 (3597.5MHz)	5MHz	QPSK, 16QAM, 64QAM	1 RB / 0 RB Offset
		42140 to 43540	42140 (3455.0MHz), 42840 (3525.0MHz), 43540 (3595.0MHz)	10MHz	QPSK, 16QAM, 64QAM	1 RB / 0 RB Offset
		42165 to 43515	42165 (3457.50MHz), 42840 (3525.0MHz), 43515 (3592.5MHz)	15MHz	QPSK, 16QAM, 64QAM	1 RB / 0 RB Offset
		42190 to 43490	42190 (3460.0MHz), 42840 (3525.0MHz), 43490 (3590.0MHz)	20MHz	QPSK, 16QAM, 64QAM	1 RB / 0 RB Offset
A	OCCUPIED BANDWIDTH	42115 to 43565	42115 (3452.5MHz), 42840 (3525.0MHz), 43565 (3597.5MHz)	5MHz	QPSK, 16QAM, 64QAM	25 RB / 0 RB Offset
		42140 to 43540	42140 (3455.0MHz), 42840 (3525.0MHz), 43540 (3595.0MHz)	10MHz	QPSK, 16QAM, 64QAM	50 RB / 0 RB Offset
		42165 to 43515	42165 (3457.50MHz), 42840 (3525.0MHz), 43515 (3592.5MHz)	15MHz	QPSK, 16QAM, 64QAM	75 RB / 0 RB Offset
		42190 to 43490	42190 (3460.0MHz), 42840 (3525.0MHz), 43490 (3590.0MHz)	20MHz	QPSK, 16QAM, 64QAM	100 RB / 0 RB Offset
A	PEAK TO AVERAGE RATIO	42115 to 43565	42115 (3452.5MHz), 42840 (3525.0MHz), 43565 (3597.5MHz)	5MHz	QPSK, 16QAM, 64QAM	1 RB / 0 RB Offset 25 RB / 0 RB Offset
		42140 to 43540	42140 (3455.0MHz), 42840 (3525.0MHz), 43540 (3595.0MHz)	10MHz	QPSK, 16QAM, 64QAM	1 RB / 0 RB Offset 50 RB / 0 RB Offset
		42165 to 43515	42165 (3457.50MHz), 42840 (3525.0MHz), 43515 (3592.5MHz)	15MHz	QPSK, 16QAM, 64QAM	1 RB / 0 RB Offset 75 RB / 0 RB Offset
		42190 to 43490	42190 (3460.0MHz), 42840 (3525.0MHz), 43490 (3590.0MHz)	20MHz	QPSK, 16QAM, 64QAM	1 RB / 0 RB Offset 100 RB / 0 RB Offset
A	BAND EDGE	42115 to 43565	42115	5MHz	QPSK, 16QAM, 64QAM	1 RB / 0 RB Offset 25 RB / 0 RB Offset
			43565	5MHz	QPSK, 16QAM, 64QAM	1 RB / 24 RB Offset 25 RB / 0 RB Offset



Test Report No.: W7L-P23100014RF07

		42140 to 43540	42140	10MHz	QPSK, 16QAM, 64QAM	1 RB / 0 RB Offset		
			43540	10MHz	QPSK, 16QAM, 64QAM	50 RB / 0 RB Offset		
		42165 to 43515	42165	15MHz	QPSK, 16QAM, 64QAM	1 RB / 49 RB Offset		
			43515	15MHz	QPSK, 16QAM, 64QAM	50 RB / 0 RB Offset		
		42190 to 43490	42165	15MHz	QPSK, 16QAM, 64QAM	1 RB / 0 RB Offset		
			43515	15MHz	QPSK, 16QAM, 64QAM	75 RB / 0 RB Offset		
		42190 to 43490	42190	20MHz	QPSK, 16QAM, 64QAM	1 RB / 74 RB Offset		
			43490	20MHz	QPSK, 16QAM, 64QAM	75 RB / 0 RB Offset		
		42190 to 43490	42190	20MHz	QPSK, 16QAM, 64QAM	1 RB / 0 RB Offset		
			43490	20MHz	QPSK, 16QAM, 64QAM	100 RB / 0 RB Offset		
		A	CONDCUDET ED EMISSION	42115 to 43565	42115 (3452.5MHz), 42840 (3525.0MHz), 43565 (3597.5MHz)	5MHz	QPSK, 16QAM, 64QAM	1 RB / 0 RB Offset
				42140 to 43540	42140 (3455.0MHz), 42840 (3525.0MHz), 43540 (3595.0MHz)	10MHz	QPSK, 16QAM, 64QAM	1 RB / 0RB Offset
42165 to 43515	42165 (3457.50MHz), 42840 (3525.0MHz), 43515 (3592.5MHz)			15MHz	QPSK, 16QAM, 64QAM	1 RB / 0 RB Offset		
42190 to 43490	42190 (3460.0MHz), 42840 (3525.0MHz), 43490 (3590.0MHz)			20MHz	QPSK, 16QAM, 64QAM	1 RB / 0 RB Offset		
A	RADIATED EMISSION	42115 to 43565	42840 (3525.0MHz),	5MHz	QPSK, 16QAM, 64QAM	1 RB / 0 RB Offset		
		42140 to 43540	42840 (3525.0MHz),	10MHz	QPSK, 16QAM, 64QAM	1 RB / 0RB Offset		
		42165 to 43515	42840 (3525.0MHz),	15MHz	QPSK, 16QAM, 64QAM	1 RB / 0 RB Offset		
		42190 to 43490	42190 (3460.0MHz), 42840 (3525.0MHz), 43490 (3590.0MHz)	20MHz	QPSK, 16QAM, 64QAM	1 RB / 0 RB Offset		

Note: This device was tested under all bandwidths, RB configurations and modulations. The worst case was found in QPSK modulation.



Test Report No.: W7L-P23100014RF07

LTE BAND 66 MODE

EUT CONFIGURE MODE	TEST ITEM	AVAILABLE CHANNEL	TESTED CHANNEL	CHANNEL BANDWIDTH	MODULATION	MODE
A	EIRP	131979 to 132665	131979,132322,132665	1.4MHz	QPSK,16QAM,64QAM	1 RB / 0 RB Offset
		131987 to 132657	131987,132322,132657	3MHz	QPSK,16QAM,64QAM	1 RB / 0 RB Offset
		131997 to 132647	131997,132322,132647	5MHz	QPSK,16QAM,64QAM	1 RB / 0 RB Offset
		132022 to 132622	132022,132322,132622	10MHz	QPSK,16QAM,64QAM	1 RB / 0 RB Offset
		132047 to 132597	132047,132322,132597	15MHz	QPSK,16QAM,64QAM	1 RB / 0 RB Offset
		132072 to 132572	132072,132322,132572	20MHz	QPSK,16QAM,64QAM	1 RB / 0 RB Offset
B	FREQUENCY STABILITY	131979 to 132665	131979,132322,132665	1.4MHz	QPSK,16QAM,64QAM	6 RB / 0 RB Offset
		131987 to 132657	131987,132322,132657	3MHz	QPSK,16QAM,64QAM	15 RB / 0 RB Offset
		131997 to 132647	131997,132322,132647	5MHz	QPSK,16QAM,64QAM	25 RB / 0 RB Offset
		132022 to 132622	132022,132322,132622	10MHz	QPSK,16QAM,64QAM	50 RB / 0 RB Offset
		132047 to 132597	132047,132322,132597	15MHz	QPSK,16QAM,64QAM	75 RB / 0 RB Offset
		132072 to 132572	132072,132322,132572	20MHz	QPSK,16QAM,64QAM	100 RB / 0 RB Offset
A	OCCUPIED BANDWIDTH	131979 to 132665	131979,132322,132665	1.4MHz	QPSK,16QAM,64QAM	6 RB / 0 RB Offset
		131987 to 132657	131987,132322,132657	3MHz	QPSK,16QAM,64QAM	15 RB / 0 RB Offset
		131997 to 132647	131997,132322,132647	5MHz	QPSK,16QAM,64QAM	25 RB / 0 RB Offset
		132022 to 132622	132022,132322,132622	10MHz	QPSK,16QAM,64QAM	50 RB / 0 RB Offset
		132047 to 132597	132047,132322,132597	15MHz	QPSK,16QAM,64QAM	75 RB / 0 RB Offset
		132072 to 132572	132072,132322,132572	20MHz	QPSK,16QAM,64QAM	100 RB / 0 RB Offset
A	BAND EDGE	131979 to 132322	131979	1.4MHz	QPSK,16QAM, 64QAM	1 RB / 0 RB Offset 6 RB / 0 RB Offset
			132322	1.4MHz	QPSK,16QAM, 64QAM	1 RB / 5 RB Offset 6 RB / 0 RB Offset
		131987 to 132657	131987	3MHz	QPSK,16QAM, 64QAM	1 RB / 0 RB Offset 15 RB / 0 RB Offset
			132657	3MHz	QPSK,16QAM, 64QAM	1 RB / 14 RB Offset 15 RB / 0 RB Offset
		131987 to 132657	131987	5MHz	QPSK,16QAM, 64QAM	1 RB / 0 RB Offset 25 RB / 0 RB Offset
			132657	5MHz	QPSK,16QAM, 64QAM	1 RB / 24 RB Offset 25 RB / 0 RB Offset
		131997 to 132647	131997	10MHz	QPSK,16QAM, 64QAM	1 RB / 0 RB Offset 50 RB / 0 RB Offset
			132647	10MHz	QPSK,16QAM, 64QAM	1 RB / 49 RB Offset 50 RB / 0 RB Offset
		132047 to 132597	132047	15MHz	QPSK,16QAM, 64QAM	1 RB / 0 RB Offset 75 RB / 0 RB Offset
			132597	15MHz	QPSK,16QAM, 64QAM	1 RB / 74 RB Offset 75 RB / 0 RB Offset
		132072 to 132572	132072	20MHz	QPSK,16QAM, 64QAM	1 RB / 0 RB Offset 100 RB / 0 RB Offset
			132572	20MHz	QPSK,16QAM, 64QAM	1 RB / 99 RB Offset



Test Report No.: W7L-P23100014RF07

						100 RB / 0 RB Offset
A	CONDCUDED EMISSION	131979 to 132665	131979,132322,132665	1.4MHz	QPSK,16QAM, 64QAM	1 RB / 0 RB Offset
		131987 to 132657	131987,132322,132657	3MHz	QPSK,16QAM, 64QAM	1 RB / 0 RB Offset
		131997 to 132647	131997,132322,132647	5MHz	QPSK,16QAM, 64QAM	1 RB / 0 RB Offset
		132022 to 132622	132022,132322,132622	10MHz	QPSK,16QAM, 64QAM	1 RB / 0 RB Offset
		132047 to 132597	132047,132322,132597	15MHz	QPSK,16QAM, 64QAM	1 RB / 0 RB Offset
		132072 to 132572	132072,132322,132572	20MHz	QPSK,16QAM, 64QAM	1 RB / 0 RB Offset
A	RADIATED EMISSION	131979 to 132665	132322	1.4MHz	QPSK	1 RB / 0 RB Offset
		131987 to 132657	132322	3MHz	QPSK	1 RB / 0 RB Offset
		131997 to 132647	132322	5MHz	QPSK	1 RB / 0 RB Offset
		132022 to 132622	132022,132322,132622	10MHz	QPSK	1 RB / 0 RB Offset
		132047 to 132597	132322	15MHz	QPSK	1 RB / 0 RB Offset
		132072 to 132572	132322	20MHz	QPSK	1 RB / 0 RB Offset

Note: This device was tested under all bandwidths, RB configurations and modulations. The worst case was found in QPSK modulation.



Test Report No.: W7L-P23100014RF07

TEST CONDITION:

TEST ITEM	ENVIRONMENTAL CONDITIONS	INPUT POWER	TESTED BY
ERP&EIRP	23deg. C, 70%RH	DC 5V By Adapter	Jace Hu
FREQUENCY STABILITY	23deg. C, 70%RH	DC 3.6V/3.7V/4.2V By DC Supply	James Fu
OCCUPIED BANDWIDTH	23deg. C, 70%RH	DC5V By Adapter	James Fu
BAND EDGE	23deg. C, 70%RH	DC 5V By Adapter	James Fu
CONDCUDETED EMISSION	23deg. C, 70%RH	DC5V By Adapter	James Fu
RADIATED EMISSION	23deg. C, 70%RH	DC5V By Adapter	Jace Hu
PEAK TO AVERAGE RATIO	23deg. C, 70%RH	DC5V By Adapter	James Fu



Test Report No.: W7L-P23100014RF07

2.5 GENERAL DESCRIPTION OF APPLIED STANDARDS

The EUT is a RF product. According to the specifications of the manufacturer, it must comply with the requirements of the following standards:

FCC 47 CFR Part 2

FCC 47 CFR Part 27

KDB 971168 D01 Power Meas License Digital Systems v03r01

ANSI/TIA/EIA-603-D

ANSI/TIA/EIA-603-E

ANSI C63.26-2015

NOTE: All test items have been performed and recorded as per the above standards.



3 TEST TYPES AND RESULTS

3.1 OUTPUT POWER MEASUREMENT

3.1.1 LIMITS OF OUTPUT POWER MEASUREMENT

The radiated peak output power shall be according to the specific rule Part 27.50(h)(2) that “User stations are limited to 2 watts” and 27.50(i) specific that “Peak transmit power must be measure over any interval of continuous transmission using instrumentation calibration in terms of rms-equivalent voltage.”

Fixed, mobile, and portable (hand-held) stations operating in the 1710-1755 MHz band and mobile and portable stations operating in the 1695-1710 MHz and 1755-1780 MHz bands are limited to 1 watt EIRP

According to the specific rule Part 27.50 (k)(3) Mobile devices are limited to 1Watt (30 dBm) EIRP, Mobile devices operating inl these bands must employ a means for limiting power to the minimum necessary for successful communications

3.1.2 TEST PROCEDURES

EIRP MEASUREMENT:

Per KDB 971168 D01 Power Meas License Digital Systems v03r01 or subclause 5.2.5.5 of ANSI C63.26-2015, the relevant equation for determing the ERP or EIRP from the conducted RF output power measured using the guidance provided above is:

$$ERP \text{ or } EIRP = P_{Meas} + G_T - L_c$$

Where:

ERP or EIRP = effective radiated power or equivalent isotropically radiated power, respectively
(expressed in the same units as P_{Meas} , typically dBW or dBm);

P_{Meas} = measured transmitter output power or PSD, in dBm or dBW;

G_T = gain of the transmitting antenna, in dBd (ERP) or dBi (EIRP);

L_c = signal attenuation in the connecting cable between the transmitter and antenna, in dB.

CONDUCTED POWER MEASUREMENT:

- a. The EUT was set up for the maximum power with LTE link data modulation and link up with simulator.
- b. Set the EUT to transmit under low, middle and high channel and record the power level shown on simulator.



Test Report No.: W7L-P23100014RF07

3.1.3 TEST SETUP

CONDUCTED POWER MEASUREMENT:

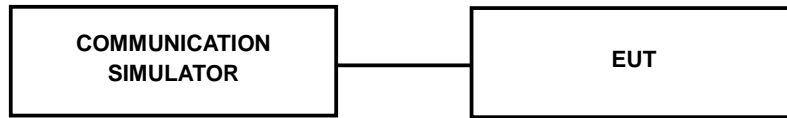

For the actual test configuration, please refer to the attached file (Test Setup Photo).

3.1.4 TEST RESULTS

AVERAGE CONDUCTED OUTPUT POWER (dBm)

LTE Band 4

Band/BW	Modulation	RB Size	RB Offset	Low CH 19957	Mid CH 20175	High CH 20393
				Frequency 1710.7 MHz	Frequency 1732.5 MHz	Frequency 1754.3 MHz
4/ 1.4	QPSK	1	0	22.81	22.87	23.03
		1	2	22.62	22.70	22.86
		1	5	22.61	22.67	22.88
		3	0	22.75	22.82	23.00
		3	1	22.80	22.90	23.04
		3	3	22.78	22.82	23.00
		6	0	21.82	21.89	22.03
	16QAM	1	0	22.07	22.14	22.34
		1	2	21.93	22.01	22.21
		1	5	21.99	22.00	22.29
		3	0	21.75	21.88	22.02
		3	1	21.81	21.95	22.10
		3	3	21.81	21.86	22.02
		6	0	20.78	20.95	21.06
	64QAM	1	0	20.91	20.98	21.18
		1	2	21.03	21.17	21.35
		1	5	21.14	21.17	21.32
		3	0	20.68	20.79	20.94
		3	1	20.83	20.98	21.06
		3	3	20.78	20.79	21.08
		6	0	19.85	19.88	20.10



Test Report No.: W7L-P23100014RF07

Band/BW	Modulation	RB Size	RB Offset	Low CH 19965	Mid CH 20175	High CH 20385
				Frequency 1711.5 MHz	Frequency 1732.5 MHz	Frequency 1753.5 MHz
4/3	QPSK	1	0	22.76	22.86	23.00
		1	7	22.58	22.71	22.86
		1	14	22.55	22.72	22.87
		8	0	21.73	21.89	22.00
		8	3	21.77	21.87	22.04
		8	7	21.75	21.89	22.04
		15	0	21.78	21.90	22.01
	16QAM	1	0	22.10	22.13	22.38
		1	7	21.87	22.05	22.18
		1	14	22.01	22.02	22.28
		8	0	20.77	20.86	21.02
		8	3	20.83	20.88	21.13
		8	7	20.84	20.89	20.95
		15	0	20.79	20.89	21.05
	64QAM	1	0	20.97	20.97	21.18
		1	7	21.06	21.17	21.33
		1	14	21.14	21.17	21.33
		8	0	19.68	19.81	19.97
		8	3	19.87	19.92	20.11
		8	7	19.75	19.83	20.04
		15	0	19.87	19.85	20.14



Test Report No.: W7L-P23100014RF07

Band/BW	Modulation	RB Size	RB Offset	Low CH 19975	Mid CH 20175	High CH 20375
				Frequency 1712.5 MHz	Frequency 1732.5 MHz	Frequency 1752.5 MHz
4/5	QPSK	1	0	22.77	22.85	23.04
		1	12	22.61	22.71	22.83
		1	24	22.55	22.73	22.88
		12	0	21.77	21.85	22.01
		12	6	21.75	21.90	22.07
		12	13	21.76	21.85	22.04
		25	0	21.75	21.93	22.00
	16QAM	1	0	22.10	22.13	22.37
		1	12	21.87	22.03	22.15
		1	24	21.98	22.06	22.24
		12	0	20.72	20.88	21.05
		12	6	20.83	20.89	21.10
		12	13	20.78	20.86	21.01
		25	0	20.76	20.95	21.05
	64QAM	1	0	20.90	21.02	21.18
		1	12	21.07	21.14	21.32
		1	24	21.08	21.24	21.32
		12	0	19.72	19.80	19.94
		12	6	19.83	19.98	20.09
		12	13	19.79	19.82	20.01
		25	0	19.83	19.91	20.12



Test Report No.: W7L-P23100014RF07

Band/BW	Modulation	RB Size	RB Offset	Low CH 20000	Mid CH 20175	High CH 20350
				Frequency 1715 MHz	Frequency 1732.5 MHz	Frequency 1750 MHz
4/ 10	QPSK	1	0	22.74	22.89	23.00
		1	24	22.62	22.70	22.86
		1	49	22.61	22.67	22.88
		25	0	21.75	21.82	22.00
		25	12	21.80	21.90	22.04
		25	25	21.76	21.82	22.00
		50	0	21.80	21.89	22.03
	16QAM	1	0	22.10	22.14	22.34
		1	24	21.89	22.01	22.21
		1	49	22.02	22.00	22.29
		25	0	20.71	20.89	21.02
		25	12	20.87	20.88	21.14
		25	25	20.77	20.87	20.98
		50	0	20.81	20.91	21.09
	64QAM	1	0	20.96	20.96	21.15
		1	24	21.05	21.11	21.38
		1	49	21.15	21.23	21.26
		25	0	19.71	19.77	19.96
		25	12	19.88	19.94	20.10
		25	25	19.78	19.79	20.03
		50	0	19.88	19.87	20.13



Test Report No.: W7L-P23100014RF07

Band/BW	Modulation	RB Size	RB Offset	Low CH 20025	Mid CH 20175	High CH 20325
				Frequency 1717.5 MHz	Frequency 1732.5 MHz	Frequency 1747.5 MHz
4/ 15	QPSK	1	0	22.78	22.90	22.99
		1	37	22.63	22.75	22.84
		1	74	22.57	22.69	22.92
		36	0	21.80	21.88	21.97
		36	19	21.73	21.85	22.10
		36	39	21.82	21.86	22.03
		75	0	21.80	21.94	21.99
	16QAM	1	0	22.08	22.16	22.37
		1	37	21.89	22.07	22.20
		1	74	22.02	22.00	22.29
		36	0	20.71	20.89	21.02
		36	19	20.86	20.90	21.13
		36	39	20.84	20.86	20.95
		75	0	20.78	20.94	21.07
	64QAM	1	0	20.96	20.96	21.15
		1	37	21.05	21.11	21.38
		1	74	21.15	21.23	21.26
		36	0	19.69	19.77	19.96
		36	19	19.87	19.99	20.08
		36	39	19.81	19.79	20.08
		75	0	19.87	19.85	20.14



Test Report No.: W7L-P23100014RF07

Band/BW	Modulation	RB Size	RB Offset	Low CH 20050	Mid CH 20175	High CH 20300
				Frequency 1720 MHz	Frequency 1732.5 MHz	Frequency 1745 MHz
4/ 20	QPSK	1	0	22.82	22.93	23.05
		1	50	22.65	22.76	22.88
		1	99	22.63	22.74	22.93
		50	0	21.81	21.90	22.02
		50	25	21.81	21.92	22.12
		50	50	21.83	21.90	22.06
		100	0	21.83	21.95	22.05
	16QAM	1	0	22.12	22.21	22.39
		1	50	21.95	22.09	22.23
		1	99	22.04	22.08	22.30
		50	0	20.79	20.93	21.07
		50	25	20.89	20.96	21.15
		50	50	20.85	20.91	21.03
		100	0	20.84	20.97	21.11
	64QAM	1	0	20.98	21.03	21.20
		1	50	21.11	21.19	21.40
		1	99	21.16	21.25	21.34
		50	0	19.76	19.85	20.02
		50	25	19.89	20.00	20.12
		50	50	19.83	19.87	20.09
		100	0	19.89	19.93	20.15



Test Report No.: W7L-P23100014RF07

LTE Band 38

Band/BW	Modulation	RB Size	RB Offset	Low CH 37775	Mid CH 38000	High CH 38225
				Frequency 2572.5 MHz	Frequency 2595 MHz	Frequency 2617.5MHz
38/ 5	QPSK	1	0	22.71	22.44	22.49
		1	12	22.59	22.32	22.28
		1	24	22.53	22.37	22.33
		12	0	21.68	21.45	21.37
		12	6	21.65	21.47	21.40
		12	13	21.62	21.40	21.41
		25	0	21.68	21.48	21.41
	16QAM	1	0	21.84	21.55	21.61
		1	12	21.74	21.49	21.48
		1	24	21.68	21.55	21.44
		12	0	20.68	20.43	20.47
		12	6	20.69	20.51	20.46
		12	13	20.66	20.44	20.45
		25	0	20.72	20.52	20.44
	64QAM	1	0	20.38	20.22	20.21
		1	12	20.45	20.22	20.07
		1	24	20.41	20.24	20.19
		12	0	19.69	19.42	19.37
		12	6	19.78	19.60	19.47
		12	13	19.70	19.55	19.42
		25	0	19.70	19.46	19.45



Test Report No.: W7L-P23100014RF07

Band/BW	Modulation	RB Size	RB Offset	Low CH 37800	Mid CH 38000	High CH 38200
				Frequency 2575 MHz	Frequency 2595 MHz	Frequency 2615 MHz
38/ 10	QPSK	1	0	22.72	22.47	22.49
		1	24	22.57	22.35	22.28
		1	49	22.54	22.33	22.36
		25	0	21.64	21.48	21.33
		25	12	21.69	21.41	21.43
		25	25	21.61	21.39	21.35
		50	0	21.70	21.48	21.40
	16QAM	1	0	21.79	21.58	21.61
		1	24	21.76	21.48	21.51
		1	49	21.67	21.52	21.48
		25	0	20.67	20.46	20.43
		25	12	20.67	20.57	20.49
		25	25	20.69	20.44	20.39
		50	0	20.72	20.53	20.48
	64QAM	1	0	20.42	20.18	20.15
		1	24	20.43	20.25	20.12
		1	49	20.41	20.24	20.19
		25	0	19.66	19.42	19.43
		25	12	19.76	19.60	19.45
		25	25	19.76	19.48	19.42
		50	0	19.71	19.49	19.44



Test Report No.: W7L-P23100014RF07

Band/BW	Modulation	RB Size	RB Offset	Low CH 37825	Mid CH 38000	High CH 38175
				Frequency 2577.5 MHz	Frequency 2595 MHz	Frequency 2612.5MHz
38/ 15	QPSK	1	0	22.73	22.46	22.48
		1	37	22.61	22.30	22.28
		1	74	22.55	22.30	22.36
		36	0	21.71	21.48	21.30
		36	19	21.64	21.41	21.39
		36	39	21.66	21.39	21.41
		75	0	21.74	21.43	21.41
	16QAM	1	0	21.80	21.55	21.61
		1	37	21.80	21.47	21.55
		1	74	21.66	21.53	21.45
		36	0	20.73	20.40	20.48
		36	19	20.67	20.54	20.46
		36	39	20.70	20.43	20.45
		75	0	20.78	20.47	20.45
	64QAM	1	0	20.40	20.15	20.21
		1	37	20.48	20.25	20.07
		1	74	20.44	20.17	20.15
		36	0	19.72	19.41	19.43
		36	19	19.83	19.60	19.42
		36	39	19.77	19.54	19.36
		75	0	19.75	19.44	19.42



Test Report No.: W7L-P23100014RF07

Band/BW	Modulation	RB Size	RB Offset	Low CH 37850	Mid CH 38000	High CH 38150
				Frequency 2580 MHz	Frequency 2595 MHz	Frequency 2610 MHz
38/ 20	QPSK	1	0	22.76	22.52	22.50
		1	50	22.63	22.37	22.33
		1	99	22.61	22.38	22.38
		50	0	21.72	21.50	21.38
		50	25	21.71	21.49	21.45
		50	50	21.69	21.45	21.43
		100	0	21.76	21.50	21.46
	16QAM	1	0	21.86	21.63	21.63
		1	50	21.82	21.55	21.56
		1	99	21.74	21.57	21.50
		50	0	20.75	20.48	20.49
		50	25	20.75	20.58	20.51
		50	50	20.73	20.49	20.47
		100	0	20.80	20.54	20.50
	64QAM	1	0	20.46	20.23	20.23
		1	50	20.49	20.27	20.15
		1	99	20.49	20.25	20.21
		50	0	19.73	19.47	19.45
		50	25	19.84	19.62	19.50
		50	50	19.78	19.56	19.44
		100	0	19.77	19.51	19.47



BUREAU
VERITAS

Test Report No.: W7L-P23100014RF07

LTE Band 41

Band/BW	Modulation	RB Size	RB Offset	Low CH (39675)	Mid CH (40620)	High CH (41565)
				Frequency (2498.5)MHz	Frequency (2593)MHz	Frequency (2687.5)MHz
41/ 5	QPSK	1	0	22.81	22.59	22.34
		1	12	22.47	22.30	22.03
		1	24	22.53	22.40	22.07
		12	0	21.70	21.59	21.31
		12	6	21.75	21.59	21.28
		12	13	21.65	21.59	21.28
		25	0	21.77	21.61	21.36
	16QAM	1	0	21.78	21.65	21.40
		1	12	21.64	21.54	21.27
		1	24	21.64	21.52	21.22
		12	0	20.72	20.58	20.38
		12	6	20.72	20.60	20.35
		12	13	20.69	20.60	20.34
		25	0	20.81	20.60	20.40
	64QAM	1	0	20.38	20.30	20.04
		1	12	20.36	20.20	19.92
		1	24	20.27	20.22	19.98
		12	0	19.76	19.50	19.35
		12	6	19.74	19.66	19.39
		12	13	19.78	19.57	19.37
		25	0	19.78	19.67	19.34



Test Report No.: W7L-P23100014RF07

Band/BW	Modulation	RB Size	RB Offset	Low CH (39700)	Mid CH (40620)	High CH (41540)
				Frequency (2501)MHz	Frequency (2593)MHz	Frequency (2685)MHz
41/ 10	QPSK	1	0	22.78	22.59	22.32
		1	24	22.47	22.31	22.08
		1	49	22.50	22.36	22.05
		25	0	21.71	21.62	21.35
		25	12	21.81	21.59	21.34
		25	25	21.63	21.58	21.29
		50	0	21.82	21.58	21.36
	16QAM	1	0	21.78	21.61	21.40
		1	24	21.69	21.57	21.26
		1	49	21.64	21.49	21.19
		25	0	20.74	20.64	20.34
		25	12	20.76	20.65	20.34
		25	25	20.68	20.57	20.29
		50	0	20.85	20.64	20.33
	64QAM	1	0	20.37	20.27	20.07
		1	24	20.41	20.24	19.89
		1	49	20.33	20.19	19.93
		25	0	19.74	19.56	19.30
		25	12	19.81	19.60	19.41
		25	25	19.77	19.59	19.39
		50	0	19.83	19.68	19.36



Test Report No.: W7L-P23100014RF07

Band/BW	Modulation	RB Size	RB Offset	Low CH (39725)	Mid CH (40620)	High CH (41515)
				Frequency (2503.5)MHz	Frequency (2593)MHz	Frequency (2682.5)MHz
41/ 15	QPSK	1	0	22.85	22.56	22.34
		1	37	22.45	22.26	22.08
		1	74	22.56	22.37	22.07
		36	0	21.68	21.63	21.37
		36	19	21.82	21.59	21.29
		36	39	21.61	21.58	21.32
		75	0	21.82	21.63	21.33
	16QAM	1	0	21.82	21.61	21.43
		1	37	21.68	21.57	21.21
		1	74	21.60	21.51	21.23
		36	0	20.78	20.65	20.39
		36	19	20.70	20.61	20.35
		36	39	20.73	20.60	20.34
		75	0	20.86	20.57	20.35
	64QAM	1	0	20.39	20.28	20.08
		1	37	20.42	20.21	19.89
		1	74	20.29	20.22	19.98
		36	0	19.79	19.50	19.34
		36	19	19.75	19.62	19.40
		36	39	19.80	19.61	19.39
		75	0	19.82	19.69	19.39



Test Report No.: W7L-P23100014RF07

Band/BW	Modulation	RB Size	RB Offset	Low CH (39750)	Mid CH (40620)	High CH (41490)
				Frequency (2506)MHz	Frequency (2593)MHz	Frequency (2680)MHz
41/ 20	QPSK	1	0	22.86	22.64	22.40
		1	50	22.49	22.32	22.10
		1	99	22.58	22.41	22.13
		50	0	21.74	21.64	21.38
		50	25	21.83	21.64	21.36
		50	50	21.69	21.60	21.34
		100	0	21.83	21.66	21.38
	16QAM	1	0	21.85	21.67	21.45
		1	50	21.72	21.59	21.28
		1	99	21.66	21.54	21.27
		50	0	20.80	20.66	20.40
		50	25	20.78	20.66	20.40
		50	50	20.76	20.62	20.36
		100	0	20.87	20.65	20.41
	64QAM	1	0	20.45	20.32	20.09
		1	50	20.44	20.26	19.97
		1	99	20.35	20.24	19.99
		50	0	19.80	19.58	19.37
		50	25	19.82	19.68	19.44
		50	50	19.82	19.65	19.41
		100	0	19.84	19.70	19.42



BUREAU
VERITAS

Test Report No.: W7L-P23100014RF07

LTE band 42:

Band/BW	Modulation	RB Size	RB Offset	Low CH (42115)	Mid CH (42590)	High CH (43065)
				Frequency (3452.5)MHz	Frequency (3500)MHz	Frequency (3547.5)MHz
42/ 5	QPSK	1	0	22.70	22.51	22.53
		1	12	22.66	22.42	22.53
		1	24	22.52	22.41	22.45
		12	0	21.67	21.51	21.53
		12	6	21.60	21.50	21.46
		12	13	21.55	21.40	21.48
		25	0	21.66	21.57	21.46
	16QAM	1	0	21.63	21.52	21.55
		1	12	21.54	21.45	21.44
		1	24	21.52	21.29	21.35
		12	0	20.56	20.44	20.46
		12	6	20.65	20.51	20.52
		12	13	20.47	20.41	20.41
		25	0	20.63	20.44	20.51
	64QAM	1	0	20.20	20.14	20.14
		1	12	20.17	20.08	20.06
		1	24	20.09	19.99	19.98
		12	0	19.60	19.45	19.46
		12	6	19.56	19.50	19.41
		12	13	19.52	19.36	19.33
		25	0	19.61	19.48	19.49



Test Report No.: W7L-P23100014RF07

Band/BW	Modulation	RB Size	RB Offset	Low CH (42140)	Mid CH (42590)	High CH (43040)
				Frequency (3455)MHz	Frequency (3500)MHz	Frequency (3545)MHz
42/ 10	QPSK	1	0	22.68	22.53	22.53
		1	24	22.60	22.49	22.49
		1	49	22.56	22.40	22.49
		25	0	21.64	21.55	21.50
		25	12	21.55	21.52	21.49
		25	25	21.53	21.46	21.45
		50	0	21.65	21.51	21.52
	16QAM	1	0	21.62	21.54	21.53
		1	24	21.51	21.49	21.40
		1	49	21.47	21.31	21.38
		25	0	20.56	20.45	20.43
		25	12	20.60	20.54	20.51
		25	25	20.47	20.43	20.40
		50	0	20.57	20.51	20.50
	64QAM	1	0	20.24	20.13	20.11
		1	24	20.12	20.13	20.06
		1	49	20.07	20.01	19.95
		25	0	19.60	19.51	19.45
		25	12	19.49	19.51	19.47
		25	25	19.53	19.39	19.31
		50	0	19.56	19.52	19.48



Test Report No.: W7L-P23100014RF07

Band/BW	Modulation	RB Size	RB Offset	Low CH (42165)	Mid CH (42590)	High CH (43015)
				Frequency (3457.5)MHz	Frequency (3500)MHz	Frequency (3542.5)MHz
42/ 15	QPSK	1	0	22.67	22.51	22.53
		1	37	22.66	22.42	22.52
		1	74	22.55	22.37	22.49
		36	0	21.66	21.52	21.50
		36	19	21.54	21.56	21.46
		36	39	21.57	21.43	21.49
		75	0	21.61	21.57	21.49
	16QAM	1	0	21.63	21.55	21.59
		1	37	21.49	21.49	21.41
		1	74	21.52	21.28	21.38
		36	0	20.54	20.46	20.40
		36	19	20.61	20.57	20.47
		36	39	20.48	20.40	20.44
		75	0	20.59	20.45	20.47
	64QAM	1	0	20.21	20.13	20.17
		1	37	20.12	20.12	20.02
		1	74	20.03	20.05	20.01
		36	0	19.62	19.48	19.40
		36	19	19.49	19.51	19.47
		36	39	19.53	19.39	19.31
		75	0	19.56	19.52	19.48



Test Report No.: W7L-P23100014RF07

Band/BW	Modulation	RB Size	RB Offset	Low CH (42190)	Mid CH (42590)	High CH (42990)
				Frequency (3460)MHz	Frequency (3500)MHz	Frequency (3540)MHz
42/ 20	QPSK	1	0	22.72	22.58	22.60
		1	50	22.68	22.50	22.54
		1	99	22.60	22.45	22.50
		50	0	21.70	21.57	21.55
		50	25	21.62	21.57	21.51
		50	50	21.61	21.48	21.50
		100	0	21.67	21.59	21.54
	16QAM	1	0	21.70	21.60	21.61
		1	50	21.57	21.51	21.46
		1	99	21.54	21.36	21.40
		50	0	20.62	20.52	20.48
		50	25	20.67	20.59	20.53
		50	50	20.55	20.45	20.46
		100	0	20.65	20.52	20.52
	64QAM	1	0	20.28	20.18	20.19
		1	50	20.20	20.14	20.08
		1	99	20.11	20.06	20.03
		50	0	19.66	19.53	19.48
		50	25	19.57	19.52	19.49
		50	50	19.57	19.44	19.39
		100	0	19.62	19.54	19.51



Test Report No.: W7L-P23100014RF07

LTE Band 66

Band/BW	Modulation	RB Size	RB Offset	Low CH 131979	Mid CH 132322	High CH 132665
				Frequency 1710.7MHz	Frequency 1745MHz	Frequency 1779.3MHz
66/ 1.4	QPSK	1	0	22.87	23.03	23.49
		1	2	22.94	23.01	23.59
		1	5	23.06	23.08	23.63
		3	0	22.81	22.89	23.49
		3	1	22.88	23.01	23.42
		3	3	22.82	22.94	23.46
		6	0	22.17	22.19	22.71
	16QAM	1	0	22.42	22.55	23.07
		1	2	22.53	22.55	23.13
		1	5	22.59	22.58	23.23
		3	0	22.49	22.60	23.10
		3	1	22.44	22.56	23.07
		3	3	22.47	22.49	23.06
		6	0	21.40	21.50	22.04
	64QAM	1	0	21.77	21.86	22.34
		1	2	21.68	21.79	22.29
		1	5	21.76	21.73	22.34
		3	0	21.50	21.63	22.07
		3	1	21.48	21.54	22.08
		3	3	21.41	21.50	22.07
		6	0	20.44	20.45	21.03



Test Report No.: W7L-P23100014RF07

Band/BW	Modulation	RB Size	RB Offset	Low CH 131987	Mid CH 132322	High CH 132657
				Frequency 1711.5MHz	Frequency 1745MHz	Frequency 1778.5MHz
66/ 3	QPSK	1	0	22.89	23.02	23.53
		1	7	22.96	23.05	23.56
		1	14	23.00	23.08	23.66
		8	0	22.16	22.23	22.78
		8	3	22.16	22.32	22.74
		8	7	22.13	22.27	22.80
		15	0	22.12	22.23	22.70
	16QAM	1	0	22.45	22.54	23.11
		1	7	22.47	22.59	23.10
		1	14	22.61	22.60	23.22
		8	0	21.52	21.60	22.07
		8	3	21.46	21.54	22.08
		8	7	21.49	21.47	22.02
		15	0	21.40	21.44	22.07
	64QAM	1	0	21.83	21.89	22.28
		1	7	21.69	21.73	22.28
		1	14	21.76	21.80	22.32
		8	0	20.56	20.61	21.14
		8	3	20.52	20.48	21.13
		8	7	20.44	20.57	21.04
		15	0	20.45	20.49	21.02



Test Report No.: W7L-P23100014RF07

Band/BW	Modulation	RB Size	RB Offset	Low CH 131997	Mid CH 132322	High CH 132647
				Frequency 1712.5MHz	Frequency 1745MHz	Frequency 1777.5MHz
66/ 5	QPSK	1	0	22.90	23.00	23.49
		1	12	22.95	22.99	23.59
		1	24	23.03	23.07	23.67
		12	0	22.13	22.22	22.76
		12	6	22.11	22.32	22.75
		12	13	22.13	22.27	22.81
		25	0	22.12	22.23	22.68
	16QAM	1	0	22.40	22.57	23.10
		1	12	22.47	22.61	23.10
		1	24	22.62	22.58	23.22
		12	0	21.45	21.59	22.07
		12	6	21.46	21.55	22.06
		12	13	21.44	21.49	22.05
		25	0	21.40	21.45	22.04
	64QAM	1	0	21.77	21.86	22.34
		1	12	21.68	21.79	22.28
		1	24	21.70	21.80	22.34
		12	0	20.54	20.64	21.07
		12	6	20.46	20.55	21.12
		12	13	20.42	20.53	21.00
		25	0	20.42	20.48	21.05



Test Report No.: W7L-P23100014RF07

Band/BW	Modulation	RB Size	RB Offset	Low CH 132022	Mid CH 132322	High CH 132622
				Frequency 1715MHz	Frequency 1745MHz	Frequency 1775MHz
66/ 10	QPSK	1	0	22.92	23.01	23.52
		1	24	22.95	22.99	23.60
		1	49	23.00	23.11	23.63
		25	0	22.14	22.21	22.79
		25	12	22.17	22.26	22.75
		25	25	22.11	22.24	22.80
		50	0	22.17	22.23	22.65
	16QAM	1	0	22.40	22.54	23.06
		1	24	22.52	22.57	23.13
		1	49	22.62	22.59	23.19
		25	0	21.47	21.57	22.13
		25	12	21.50	21.49	22.11
		25	25	21.43	21.50	22.02
		50	0	21.44	21.44	22.08
	64QAM	1	0	21.76	21.87	22.31
		1	24	21.73	21.75	22.32
		1	49	21.76	21.74	22.31
		25	0	20.52	20.61	21.13
		25	12	20.53	20.54	21.06
		25	25	20.41	20.50	21.02
		50	0	20.47	20.44	21.06



Test Report No.: W7L-P23100014RF07

Band/BW	Modulation	RB Size	RB Offset	Low CH 132072	Mid CH 132322	High CH 132572
				Frequency 1720MHz	Frequency 1745MHz	Frequency 1770MHz
66/ 15	QPSK	1	0	22.89	23.05	23.48
		1	37	22.90	23.02	23.59
		1	74	23.02	23.08	23.63
		36	0	22.10	22.22	22.79
		36	19	22.11	22.31	22.74
		36	39	22.09	22.31	22.80
		75	0	22.14	22.20	22.65
	16QAM	1	0	22.39	22.61	23.10
		1	37	22.50	22.58	23.11
		1	74	22.62	22.58	23.23
		36	0	21.45	21.61	22.10
		36	19	21.49	21.51	22.10
		36	39	21.49	21.47	22.02
		75	0	21.40	21.44	22.07
	64QAM	1	0	21.83	21.89	22.28
		1	37	21.71	21.73	22.28
		1	74	21.77	21.75	22.34
		36	0	20.53	20.67	21.08
		36	19	20.52	20.48	21.13
		36	39	20.38	20.54	21.03
		75	0	20.46	20.42	21.07



Test Report No.: W7L-P23100014RF07

Band/BW	Modulation	RB Size	RB Offset	Low CH 132072	Mid CH 132322	High CH 132572
				Frequency 1720MHz	Frequency 1745MHz	Frequency 1770MHz
66/ 20	QPSK	1	0	22.95	23.07	23.54
		1	50	22.97	23.07	23.61
		1	99	23.08	23.15	23.68
		50	0	22.17	22.27	22.81
		50	25	22.19	22.33	22.80
		50	50	22.17	22.32	22.82
		100	0	22.18	22.25	22.73
	16QAM	1	0	22.47	22.62	23.12
		1	50	22.55	22.63	23.15
		1	99	22.64	22.66	23.24
		50	0	21.53	21.65	22.15
		50	25	21.52	21.57	22.12
		50	50	21.51	21.54	22.07
		100	0	21.46	21.52	22.09
	64QAM	1	0	21.84	21.91	22.36
		1	50	21.76	21.81	22.34
		1	99	21.78	21.81	22.36
		50	0	20.58	20.69	21.15
		50	25	20.54	20.56	21.14
		50	50	20.46	20.58	21.08
		100	0	20.48	20.50	21.08



Test Report No.: W7L-P23100014RF07

EIRP
LTE BAND 4
CHANNEL BANDWIDTH: 1.4MHz QPSK

Channel	Frequency (MHz)	Conducted Power (dBm)	G _T -L _c (dB)	EIRP (dBm)	EIRP (mW)	Limit (W)
19957	1710.7	22.81	0.4	23.21	209.41	1
20175	1732.5	22.9	0.4	23.3	213.8	1
20393	1754.3	23.04	0.4	23.44	220.8	1

CHANNEL BANDWIDTH: 1.4MHz 16QAM

Channel	Frequency (MHz)	Conducted Power (dBm)	G _T -L _c (dB)	EIRP (dBm)	EIRP (mW)	Limit (W)
19957	1710.7	22.07	0.4	22.47	176.6	1
20175	1732.5	22.14	0.4	22.54	179.47	1
20393	1754.3	22.34	0.4	22.74	187.93	1

CHANNEL BANDWIDTH: 1.4MHz 64QAM

Channel	Frequency (MHz)	Conducted Power (dBm)	G _T -L _c (dB)	EIRP (dBm)	EIRP (mW)	Limit (W)
19957	1710.7	21.14	0.4	21.54	142.56	1
20175	1732.5	21.17	0.4	21.57	143.55	1
20393	1754.3	21.35	0.4	21.75	149.62	1

CHANNEL BANDWIDTH: 3MHz QPSK

Channel	Frequency (MHz)	Conducted Power (dBm)	G _T -L _c (dB)	EIRP (dBm)	EIRP (mW)	Limit (W)
19965	1711.5	22.76	0.4	23.16	207.01	1
20175	1732.5	22.86	0.4	23.26	211.84	1
20385	1753.5	23	0.4	23.4	218.78	1

CHANNEL BANDWIDTH: 3MHz 16QAM

Channel	Frequency (MHz)	Conducted Power (dBm)	G _T -L _c (dB)	EIRP (dBm)	EIRP (mW)	Limit (W)
19965	1711.5	22.1	0.4	22.5	177.83	1
20175	1732.5	22.01	0.4	22.41	174.18	1
20385	1753.5	22.01	0.4	22.41	174.18	1

CHANNEL BANDWIDTH: 3MHz 64QAM

Channel	Frequency (MHz)	Conducted Power (dBm)	G _T -L _c (dB)	EIRP (dBm)	EIRP (mW)	Limit (W)
19965	1711.5	21.14	0.4	21.54	142.56	1
20175	1732.5	21.17	0.4	21.57	143.55	1
20385	1753.5	21.33	0.4	21.73	148.94	1

CHANNEL BANDWIDTH: 5MHz QPSK

Channel	Frequency (MHz)	Conducted Power (dBm)	G _T -L _c (dB)	EIRP (dBm)	EIRP (mW)	Limit (W)
19975	1712.5	22.77	0.4	23.17	207.49	1
20175	1732.5	22.85	0.4	23.25	211.35	1
20375	1752.5	23.04	0.4	23.44	220.8	1

CHANNEL BANDWIDTH: 5MHz 16QAM

Channel	Frequency (MHz)	Conducted Power (dBm)	G _T -L _c (dB)	EIRP (dBm)	EIRP (mW)	Limit (W)
19975	1712.5	22.1	0.4	22.5	177.83	1
20175	1732.5	22.13	0.4	22.53	179.06	1
20375	1752.5	22.37	0.4	22.77	189.23	1

CHANNEL BANDWIDTH: 5MHz 64QAM

Channel	Frequency (MHz)	Conducted Power (dBm)	G _T -L _c (dB)	EIRP (dBm)	EIRP (mW)	Limit (W)
19975	1712.5	21.08	0.4	21.48	140.6	1
20175	1732.5	21.24	0.4	21.64	145.88	1
20375	1752.5	21.32	0.4	21.72	148.59	1

CHANNEL BANDWIDTH: 10MHz QPSK

Channel	Frequency (MHz)	Conducted Power (dBm)	G _{T-Lc} (dB)	EIRP (dBm)	EIRP (mW)	Limit (W)
20000	1715	22.74	0.4	23.14	206.06	1
20175	1732.5	22.89	0.4	23.29	213.3	1
20350	1750	23	0.4	23.4	218.78	1

CHANNEL BANDWIDTH: 10MHz 16QAM

Channel	Frequency (MHz)	Conducted Power (dBm)	G _{T-Lc} (dB)	EIRP (dBm)	EIRP (mW)	Limit (W)
20000	1715	22.1	0.4	22.5	177.83	1
20175	1732.5	22.14	0.4	22.54	179.47	1
20350	1750	22.34	0.4	22.74	187.93	1

CHANNEL BANDWIDTH: 10MHz 64QAM

Channel	Frequency (MHz)	Conducted Power (dBm)	G _{T-Lc} (dB)	EIRP (dBm)	EIRP (mW)	Limit (W)
20000	1715	21.15	0.4	21.55	142.89	1
20175	1732.5	21.23	0.4	21.63	145.55	1
20350	1750	21.38	0.4	21.78	150.66	1

CHANNEL BANDWIDTH: 15MHz QPSK

Channel	Frequency (MHz)	Conducted Power (dBm)	G _{T-Lc} (dB)	EIRP (dBm)	EIRP (mW)	Limit (W)
20025	1717.5	22.78	0.4	23.18	207.97	1
20175	1732.5	22.9	0.4	23.3	213.8	1
20325	1747.5	22.99	0.4	23.39	218.27	1

CHANNEL BANDWIDTH: 15MHz 16QAM

Channel	Frequency (MHz)	Conducted Power (dBm)	G _{T-Lc} (dB)	EIRP (dBm)	EIRP (mW)	Limit (W)
20025	1717.5	22.08	0.4	22.48	177.01	1
20175	1732.5	22.16	0.4	22.56	180.3	1
20325	1747.5	22.37	0.4	22.77	189.23	1



Test Report No.: W7L-P23100014RF07

CHANNEL BANDWIDTH: 15MHz 64QAM

Channel	Frequency (MHz)	Conducted Power (dBm)	G _{T-Lc} (dB)	EIRP (dBm)	EIRP (mW)	Limit (W)
20025	1717.5	21.15	0.4	21.55	142.89	1
20175	1732.5	21.23	0.4	21.63	145.55	1
20325	1747.5	21.38	0.4	21.78	150.66	1

CHANNEL BANDWIDTH: 20MHz QPSK

Channel	Frequency (MHz)	Conducted Power (dBm)	G _{T-Lc} (dB)	EIRP (dBm)	EIRP (mW)	Limit (W)
20050	1720	22.82	0.4	23.22	209.89	1
20175	1732.5	22.93	0.4	23.33	215.28	1
20300	1745	23.05	0.4	23.45	221.31	1

CHANNEL BANDWIDTH: 20MHz 16QAM

Channel	Frequency (MHz)	Conducted Power (dBm)	G _{T-Lc} (dB)	EIRP (dBm)	EIRP (mW)	Limit (W)
20050	1720	22.12	0.4	22.52	178.65	1
20175	1732.5	22.21	0.4	22.61	182.39	1
20300	1745	22.39	0.4	22.79	190.11	1

CHANNEL BANDWIDTH: 20MHz 64QAM

Channel	Frequency (MHz)	Conducted Power (dBm)	G _{T-Lc} (dB)	EIRP (dBm)	EIRP (mW)	Limit (W)
20050	1720	21.16	0.4	21.56	143.22	1
20175	1732.5	21.25	0.4	21.65	146.22	1
20300	1745	21.4	0.4	21.8	151.36	1



Test Report No.: W7L-P23100014RF07

LTE BAND 38

CHANNEL BANDWIDTH: 5MHz QPSK

Channel	Frequency (MHz)	Conducted Power (dBm)	G _T -L _c (dB)	EIRP (dBm)	EIRP (mW)	Limit (W)
37775	2572.5	22.71	-1.5	21.21	132.13	2
38000	2595.0	22.44	-1.5	20.94	124.17	2
38225	2617.5	22.49	-1.5	20.99	125.6	2

CHANNEL BANDWIDTH: 5MHz 16QAM

Channel	Frequency (MHz)	Conducted Power (dBm)	G _T -L _c (dB)	EIRP (dBm)	EIRP (mW)	Limit (W)
37775	2572.5	21.84	-1.5	20.34	108.14	2
38000	2595.0	21.55	-1.5	20.05	101.16	2
38225	2617.5	21.61	-1.5	20.11	102.57	2

CHANNEL BANDWIDTH: 5MHz 64QAM

Channel	Frequency (MHz)	Conducted Power (dBm)	G _T -L _c (dB)	EIRP (dBm)	EIRP (mW)	Limit (W)
37775	2572.5	20.45	-1.5	18.95	78.52	2
38000	2595	20.24	-1.5	18.74	74.82	2
38225	2617.5	20.21	-1.5	18.71	74.3	2



Test Report No.: W7L-P23100014RF07

CHANNEL BANDWIDTH: 10MHz QPSK

Channel	Frequency (MHz)	Conducted Power (dBm)	G _{T-Lc} (dB)	EIRP (dBm)	EIRP (mW)	Limit (W)
37800	2575.0	22.72	-1.5	21.22	132.43	2
38000	2595.0	22.47	-1.5	20.97	125.03	2
38200	2615.0	22.49	-1.5	20.99	125.6	2

CHANNEL BANDWIDTH: 10MHz 16QAM

Channel	Frequency (MHz)	Conducted Power (dBm)	G _{T-Lc} (dB)	EIRP (dBm)	EIRP (mW)	Limit (W)
37800	2575.0	21.79	-1.5	20.29	106.91	2
38000	2595.0	21.58	-1.5	20.08	101.86	2
38200	2615.0	21.61	-1.5	20.11	102.57	2

CHANNEL BANDWIDTH: 10MHz 64QAM

Channel	Frequency (MHz)	Conducted Power (dBm)	G _{T-Lc} (dB)	EIRP (dBm)	EIRP (mW)	Limit (W)
37800	2575	20.43	-1.5	18.93	78.16	2
38000	2595	20.25	-1.5	18.75	74.99	2
38200	2615	20.19	-1.5	18.69	73.96	2



Test Report No.: W7L-P23100014RF07

CHANNEL BANDWIDTH: 15MHz QPSK

Channel	Frequency (MHz)	Conducted Power (dBm)	G _{T-Lc} (dB)	EIRP (dBm)	EIRP (mW)	Limit (W)
37825	2577.5	22.73	-1.5	21.23	132.74	2
38000	2595.0	22.46	-1.5	20.96	124.74	2
38175	2612.5	22.48	-1.5	20.98	125.31	2

CHANNEL BANDWIDTH: 15MHz 16QAM

Channel	Frequency (MHz)	Conducted Power (dBm)	G _{T-Lc} (dB)	EIRP (dBm)	EIRP (mW)	Limit (W)
37825	2577.5	21.8	-1.5	20.3	107.15	2
38000	2595.0	21.55	-1.5	20.05	101.16	2
38175	2612.5	21.61	-1.5	20.11	102.57	2

CHANNEL BANDWIDTH: 15MHz 64QAM

Channel	Frequency (MHz)	Conducted Power (dBm)	G _{T-Lc} (dB)	EIRP (dBm)	EIRP (mW)	Limit (W)
37825	2577.5	20.48	-1.5	18.98	79.07	2
38000	2595	20.25	-1.5	18.75	74.99	2
38175	2612.5	20.21	-1.5	18.71	74.3	2



Test Report No.: W7L-P23100014RF07

CHANNEL BANDWIDTH: 20MHz QPSK

Channel	Frequency (MHz)	Conducted Power (dBm)	G _{T-LC} (dB)	EIRP (dBm)	EIRP (mW)	Limit (W)
37850	2580.0	22.76	-1.5	21.26	133.66	2
38000	2595.0	22.52	-1.5	21.02	126.47	2
38150	2610.0	22.5	-1.5	21	125.89	2

CHANNEL BANDWIDTH: 20MHz 16QAM

Channel	Frequency (MHz)	Conducted Power (dBm)	G _{T-LC} (dB)	EIRP (dBm)	EIRP (mW)	Limit (W)
37850	2580.0	21.86	-1.5	20.36	108.64	2
38000	2595.0	21.63	-1.5	20.13	103.04	2
38150	2610.0	21.63	-1.5	20.13	103.04	2

CHANNEL BANDWIDTH: 20MHz 64QAM

Channel	Frequency (MHz)	Conducted Power (dBm)	G _{T-LC} (dB)	EIRP (dBm)	EIRP (mW)	Limit (W)
37850	2580	20.49	-1.5	18.99	79.25	2
38000	2595	20.27	-1.5	18.77	75.34	2
38150	2610	20.23	-1.5	18.73	74.64	2



BUREAU
VERITAS

Test Report No.: W7L-P23100014RF07

LTE BAND 41

CHANNEL BANDWIDTH: 5MHz QPSK

Channel	Frequency (MHz)	Conducted Power (dBm)	G _{T-Lc} (dB)	EIRP (dBm)	EIRP (mW)	Limit (W)
39675	2498.5	22.81	-1.5	21.31	135.21	2
40620	2593.0	22.59	-1.5	21.09	128.53	2
41565	2687.5	22.34	-1.5	20.84	121.34	2

CHANNEL BANDWIDTH: 5MHz 16QAM

Channel	Frequency (MHz)	Conducted Power (dBm)	G _{T-Lc} (dB)	EIRP (dBm)	EIRP (mW)	Limit (W)
39675	2498.5	21.78	-1.5	20.28	106.66	2
40620	2593.0	21.65	-1.5	20.15	103.51	2
41565	2687.5	21.4	-1.5	19.9	97.72	2

CHANNEL BANDWIDTH: 5MHz 64QAM

Channel	Frequency (MHz)	Conducted Power (dBm)	G _{T-Lc} (dB)	EIRP (dBm)	EIRP (mW)	Limit (W)
39675	2498.5	20.38	-1.5	18.88	77.27	2
40620	2593.0	20.3	-1.5	18.8	75.86	2
41565	2687.5	20.04	-1.5	18.54	71.45	2



Test Report No.: W7L-P23100014RF07

CHANNEL BANDWIDTH: 10MHz QPSK

Channel	Frequency (MHz)	Conducted Power (dBm)	G _{T-Lc} (dB)	EIRP (dBm)	EIRP (mW)	Limit (W)
39700	2501.0	22.78	-1.5	21.28	134.28	2
40620	2593.0	22.59	-1.5	21.09	128.53	2
41540	2685.0	22.32	-1.5	20.82	120.78	2

CHANNEL BANDWIDTH: 10MHz 16QAM

Channel	Frequency (MHz)	Conducted Power (dBm)	G _{T-Lc} (dB)	EIRP (dBm)	EIRP (mW)	Limit (W)
39700	2501.0	21.78	-1.5	20.28	106.66	2
40620	2593.0	21.61	-1.5	20.11	102.57	2
41540	2685.0	21.4	-1.5	19.9	97.72	2

CHANNEL BANDWIDTH: 10MHz 64QAM

Channel	Frequency (MHz)	Conducted Power (dBm)	G _{T-Lc} (dB)	EIRP (dBm)	EIRP (mW)	Limit (W)
39700	2501.0	20.41	-1.5	18.91	77.8	2
40620	2593.0	20.27	-1.5	18.77	75.34	2
41540	2685.0	20.07	-1.5	18.57	71.94	2



BUREAU
VERITAS

Test Report No.: W7L-P23100014RF07

CHANNEL BANDWIDTH: 15MHz QPSK

Channel	Frequency (MHz)	Conducted Power (dBm)	G _{T-Lc} (dB)	EIRP (dBm)	EIRP (mW)	Limit (W)
39725	2503.5	22.85	-1.5	21.35	136.46	2
40620	2593.0	22.56	-1.5	21.06	127.64	2
41515	2682.5	22.34	-1.5	20.84	121.34	2

CHANNEL BANDWIDTH: 15MHz 16QAM

Channel	Frequency (MHz)	Conducted Power (dBm)	G _{T-Lc} (dB)	EIRP (dBm)	EIRP (mW)	Limit (W)
39725	2503.5	21.82	-1.5	20.32	107.65	2
40620	2593.0	21.61	-1.5	20.11	102.57	2
41515	2682.5	21.43	-1.5	19.93	98.4	2

CHANNEL BANDWIDTH: 15MHz 64QAM

Channel	Frequency (MHz)	Conducted Power (dBm)	G _{T-Lc} (dB)	EIRP (dBm)	EIRP (mW)	Limit (W)
39725	2503.5	20.42	-1.5	18.92	77.98	2
40620	2593.0	20.28	-1.5	18.78	75.51	2
41515	2682.5	20.08	-1.5	18.58	72.11	2



**BUREAU
VERITAS**

Test Report No.: W7L-P23100014RF07

CHANNEL BANDWIDTH: 20MHz QPSK

Channel	Frequency (MHz)	Conducted Power (dBm)	G _{T-L_C} (dB)	EIRP (dBm)	EIRP (mW)	Limit (W)
39750	2506.0	22.86	-1.5	21.36	136.77	2
40620	2593.0	22.64	-1.5	21.14	130.02	2
41490	2680.0	22.4	-1.5	20.9	123.03	2

CHANNEL BANDWIDTH: 20MHz 16QAM

Channel	Frequency (MHz)	Conducted Power (dBm)	G _{T-L_C} (dB)	EIRP (dBm)	EIRP (mW)	Limit (W)
39750	2506.0	21.85	-1.5	20.35	108.39	2
40620	2593.0	21.67	-1.5	20.17	103.99	2
41490	2680.0	21.45	-1.5	19.95	98.86	2

CHANNEL BANDWIDTH: 20 MHz 64QAM

Channel	Frequency (MHz)	Conducted Power (dBm)	G _{T-L_C} (dB)	EIRP (dBm)	EIRP (mW)	Limit (W)
39750	2506.0	20.45	-1.5	18.95	78.52	2
40620	2593.0	20.32	-1.5	18.82	76.21	2
41490	2680.0	20.09	-1.5	18.59	72.28	2



Test Report No.: W7L-P23100014RF07

LTE Band 42

CHANNEL BANDWIDTH: 5MHz QPSK

Channel	Frequency (MHz)	Conducted Power (dBm)	G _T -L _c (dB)	EIRP (dBm)	EIRP (mW)	Limit (W)
42115	3452.5	22.7	-1.3	21.4	138.04	1
42590	3500	22.51	-1.3	21.21	132.13	1
43065	3547.5	22.53	-1.3	21.23	132.74	1

CHANNEL BANDWIDTH: 5MHz 16QAM

Channel	Frequency (MHz)	Conducted Power (dBm)	G _T -L _c (dB)	EIRP (dBm)	EIRP (mW)	Limit (W)
42115	3452.5	21.63	-1.3	20.33	107.89	1
42590	3500	21.52	-1.3	20.22	105.2	1
43065	3547.5	21.55	-1.3	20.25	105.93	1

CHANNEL BANDWIDTH: 5MHz 64QAM

Channel	Frequency (MHz)	Conducted Power (dBm)	G _T -L _c (dB)	EIRP (dBm)	EIRP (mW)	Limit (W)
42115	3452.5	20.2	-1.3	18.9	77.62	1
42590	3500	20.14	-1.3	18.84	76.56	1
43065	3547.5	20.14	-1.3	18.84	76.56	1



Test Report No.: W7L-P23100014RF07

CHANNEL BANDWIDTH: 10MHz QPSK

Channel	Frequency (MHz)	Conducted Power (dBm)	G _T -L _c (dB)	EIRP (dBm)	EIRP (mW)	Limit (W)
42140	3455	22.68	-1.3	21.38	137.4	1
42590	3500	22.53	-1.3	21.23	132.74	1
43040	3545	22.53	-1.3	21.23	132.74	1

CHANNEL BANDWIDTH: 10MHz 16QAM

Channel	Frequency (MHz)	Conducted Power (dBm)	G _T -L _c (dB)	EIRP (dBm)	EIRP (mW)	Limit (W)
42140	3455	21.62	-1.3	20.32	107.65	1
42590	3500	21.54	-1.3	20.24	105.68	1
43040	3545	21.53	-1.3	20.23	105.44	1

CHANNEL BANDWIDTH: 10MHz 64QAM

Channel	Frequency (MHz)	Conducted Power (dBm)	G _T -L _c (dB)	EIRP (dBm)	EIRP (mW)	Limit (W)
42140	3455	20.24	-1.3	18.94	78.34	1
42590	3500	20.13	-1.3	18.83	76.38	1
43040	3545	20.11	-1.3	18.81	76.03	1



Test Report No.: W7L-P23100014RF07

CHANNEL BANDWIDTH: 15MHz QPSK

Channel	Frequency (MHz)	Conducted Power (dBm)	G _T -L _c (dB)	EIRP (dBm)	EIRP (mW)	Limit (W)
42165	3457.5	22.67	-1.3	21.37	137.09	1
42590	3500	22.51	-1.3	21.21	132.13	1
43015	3542.5	22.53	-1.3	21.23	132.74	1

CHANNEL BANDWIDTH: 15MHz 16QAM

Channel	Frequency (MHz)	Conducted Power (dBm)	G _T -L _c (dB)	EIRP (dBm)	EIRP (mW)	Limit (W)
42165	3457.5	21.63	-1.3	20.33	107.89	1
42590	3500	21.55	-1.3	20.25	105.93	1
43015	3542.5	21.59	-1.3	20.29	106.91	1

CHANNEL BANDWIDTH: 15MHz 64QAM

Channel	Frequency (MHz)	Conducted Power (dBm)	G _T -L _c (dB)	EIRP (dBm)	EIRP (mW)	Limit (W)
42165	3457.5	20.21	-1.3	18.91	77.8	1
42590	3500	20.13	-1.3	18.83	76.38	1
43015	3542.5	20.17	-1.3	18.87	77.09	1



Test Report No.: W7L-P23100014RF07

CHANNEL BANDWIDTH: 20MHz QPSK

Channel	Frequency (MHz)	Conducted Power (dBm)	G _T -L _c (dB)	EIRP (dBm)	EIRP (mW)	Limit (W)
42190	3460	22.72	-1.3	21.42	138.68	1
42590	3500	22.58	-1.3	21.28	134.28	1
42990	3540	22.6	-1.3	21.3	134.9	1

CHANNEL BANDWIDTH: 20MHz 16QAM

Channel	Frequency (MHz)	Conducted Power (dBm)	G _T -L _c (dB)	EIRP (dBm)	EIRP (mW)	Limit (W)
42190	3460	21.7	-1.3	20.4	109.65	1
42590	3500	21.6	-1.3	20.3	107.15	1
42990	3540	21.61	-1.3	20.31	107.4	1

CHANNEL BANDWIDTH: 20MHz 64QAM

Channel	Frequency (MHz)	Conducted Power (dBm)	G _T -L _c (dB)	EIRP (dBm)	EIRP (mW)	Limit (W)
42190	3460	20.28	-1.3	18.98	79.07	1
42590	3500	20.18	-1.3	18.88	77.27	1
42990	3540	20.19	-1.3	18.89	77.45	1



Test Report No.: W7L-P23100014RF07

LTE BAND 66

CHANNEL BANDWIDTH: 1.4MHz QPSK

Channel	Frequency (MHz)	Conducted Power (dBm)	G _T -L _C (dB)	EIRP (dBm)	EIRP (mW)	Limit (W)
131979	1710.7	23.06	0.4	23.46	221.82	1
132322	1745	23.08	0.4	23.48	222.84	1
132665	1779.3	23.63	0.4	24.03	252.93	1

CHANNEL BANDWIDTH: 1.4MHz 16QAM

Channel	Frequency (MHz)	Conducted Power (dBm)	G _T -L _C (dB)	EIRP (dBm)	EIRP (mW)	Limit (W)
131979	1710.7	22.59	0.4	22.99	199.07	1
132322	1745	22.6	0.4	23	199.53	1
132665	1779.3	23.23	0.4	23.63	230.67	1

CHANNEL BANDWIDTH: 1.4MHz 64QAM

Channel	Frequency (MHz)	Conducted Power (dBm)	G _T -L _C (dB)	EIRP (dBm)	EIRP (mW)	Limit (W)
131979	1710.7	21.77	0.4	22.17	164.82	1
132322	1745	21.86	0.4	22.26	168.27	1
132665	1779.3	22.34	0.4	22.74	187.93	1

CHANNEL BANDWIDTH: 3MHz QPSK

Channel	Frequency (MHz)	Conducted Power (dBm)	G _T -L _c (dB)	EIRP (dBm)	EIRP (mW)	Limit (W)
131987	1711.5	23	0.4	23.4	218.78	1
132322	1745	23.08	0.4	23.48	222.84	1
132657	1778.5	23.66	0.4	24.06	254.68	1

CHANNEL BANDWIDTH: 3MHz 16QAM

Channel	Frequency (MHz)	Conducted Power (dBm)	G _T -L _c (dB)	EIRP (dBm)	EIRP (mW)	Limit (W)
131987	1711.5	22.61	0.4	23.01	199.99	1
132322	1745	22.6	0.4	23	199.53	1
132657	1778.5	23.22	0.4	23.62	230.14	1

CHANNEL BANDWIDTH: 3MHz 64QAM

Channel	Frequency (MHz)	Conducted Power (dBm)	G _T -L _c (dB)	EIRP (dBm)	EIRP (mW)	Limit (W)
131987	1711.5	21.83	0.4	22.23	167.11	1
132322	1745	21.89	0.4	22.29	169.43	1
132657	1778.5	22.32	0.4	22.72	187.07	1

CHANNEL BANDWIDTH: 5MHz QPSK

Channel	Frequency (MHz)	Conducted Power (dBm)	G _T -L _c (dB)	EIRP (dBm)	EIRP (mW)	Limit (W)
131997	1712.5	23.03	0.4	23.43	220.29	1
132322	1745	23.07	0.4	23.47	222.33	1
132647	1777.5	23.67	0.4	24.07	255.27	1

CHANNEL BANDWIDTH: 5MHz 16QAM

Channel	Frequency (MHz)	Conducted Power (dBm)	G _T -L _c (dB)	EIRP (dBm)	EIRP (mW)	Limit (W)
131997	1712.5	22.62	0.4	23.02	200.45	1
132322	1745	22.61	0.4	23.01	199.99	1
132647	1777.5	23.22	0.4	23.62	230.14	1



Test Report No.: W7L-P23100014RF07

CHANNEL BANDWIDTH: 5MHz 64QAM

Channel	Frequency (MHz)	Conducted Power (dBm)	G _T -L _C (dB)	EIRP (dBm)	EIRP (mW)	Limit (W)
131997	1712.5	21.77	0.4	22.17	164.82	1
132322	1745	21.86	0.4	22.26	168.27	1
132647	1777.5	22.34	0.4	22.74	187.93	1

CHANNEL BANDWIDTH: 10MHz QPSK

Channel	Frequency (MHz)	Conducted Power (dBm)	G _T -L _C (dB)	EIRP (dBm)	EIRP (mW)	Limit (W)
132022	1715	23	0.4	23.4	218.78	1
132322	1745	23.11	0.4	23.51	224.39	1
132622	1775	23.63	0.4	24.03	252.93	1

CHANNEL BANDWIDTH: 10MHz 16QAM

Channel	Frequency (MHz)	Conducted Power (dBm)	G _T -L _C (dB)	EIRP (dBm)	EIRP (mW)	Limit (W)
132022	1715	22.62	0.4	23.02	200.45	1
132322	1745	22.59	0.4	22.99	199.07	1
132622	1775	23.19	0.4	23.59	228.56	1

CHANNEL BANDWIDTH: 10MHz 64QAM

Channel	Frequency (MHz)	Conducted Power (dBm)	G _T -L _C (dB)	EIRP (dBm)	EIRP (mW)	Limit (W)
132022	1715	21.76	0.4	22.16	164.44	1
132322	1745	21.87	0.4	22.27	168.66	1
132622	1775	22.32	0.4	22.72	187.07	1



Test Report No.: W7L-P23100014RF07

CHANNEL BANDWIDTH: 15MHz QPSK

Channel	Frequency (MHz)	Conducted Power (dBm)	G _{T-Lc} (dB)	EIRP (dBm)	EIRP (mW)	Limit (W)
132047	1717.5	23.02	0.4	23.42	219.79	1
132322	1745	23.08	0.4	23.48	222.84	1
132597	1772.5	23.63	0.4	24.03	252.93	1

CHANNEL BANDWIDTH: 15MHz 16QAM

Channel	Frequency (MHz)	Conducted Power (dBm)	G _{T-Lc} (dB)	EIRP (dBm)	EIRP (mW)	Limit (W)
132047	1715	22.62	0.4	23.02	200.45	1
132322	1745	22.61	0.4	23.01	199.99	1
132622	1775	23.23	0.4	23.63	230.67	1

CHANNEL BANDWIDTH: 15MHz 64QAM

Channel	Frequency (MHz)	Conducted Power (dBm)	G _{T-Lc} (dB)	EIRP (dBm)	EIRP (mW)	Limit (W)
132047	1715	21.83	0.4	22.23	167.11	1
132322	1745	21.89	0.4	22.29	169.43	1
132622	1775	22.34	0.4	22.74	187.93	1



Test Report No.: W7L-P23100014RF07

CHANNEL BANDWIDTH: 20MHz QPSK

Channel	Frequency (MHz)	Conducted Power (dBm)	G _{T-Lc} (dB)	EIRP (dBm)	EIRP (mW)	Limit (W)
132072	1720	23.08	0.4	23.48	222.84	1
132322	1745	23.15	0.4	23.55	226.46	1
132572	1770	23.68	0.4	24.08	255.86	1

CHANNEL BANDWIDTH: 20MHz 16QAM

Channel	Frequency (MHz)	Conducted Power (dBm)	G _{T-Lc} (dB)	EIRP (dBm)	EIRP (mW)	Limit (W)
132072	1720	22.64	0.4	23.04	201.37	1
132322	1745	22.66	0.4	23.06	202.3	1
132572	1770	23.24	0.4	23.64	231.21	1

CHANNEL BANDWIDTH: 20MHz 64QAM

Channel	Frequency (MHz)	Conducted Power (dBm)	G _{T-Lc} (dB)	EIRP (dBm)	EIRP (mW)	Limit (W)
132072	1720	21.84	0.4	22.24	167.49	1
132322	1745	21.91	0.4	22.31	170.22	1
132572	1770	22.36	0.4	22.76	188.8	1

REMARKS: EIRP Output Power (dBm) = EIRP (dBm) -2.15(dB).

3.2 FREQUENCY STABILITY MEASUREMENT

3.2.1 LIMITS OF FREQUENCY STABILITY MEASUREMENT

The frequency stability shall be sufficient to ensure that the fundamental emissions stay within the authorized bands of operation.

3.2.2 TEST PROCEDURE

- a. Device is placed at the oven room. The oven room could control the temperatures and humidity. Power warm up is at least 15 min and power applied should perform before recording frequency error.
- b. EUT is connected the external power supply to control the DC input power. The test voltage range is from minimum to maximum working voltage. Each step shall be record the frequency error rate.
- c. The temperature range step is 10 degrees in this test items. All temperature levels shall be hold the $\pm 0.5^{\circ}\text{C}$ during the measurement testing. The each temperature step shall be at least 0.5 hours, consider the EUT could be test under the stability condition.

NOTE: The frequency error was recorded frequency error from the communication simulator.

3.2.3 TEST SETUP

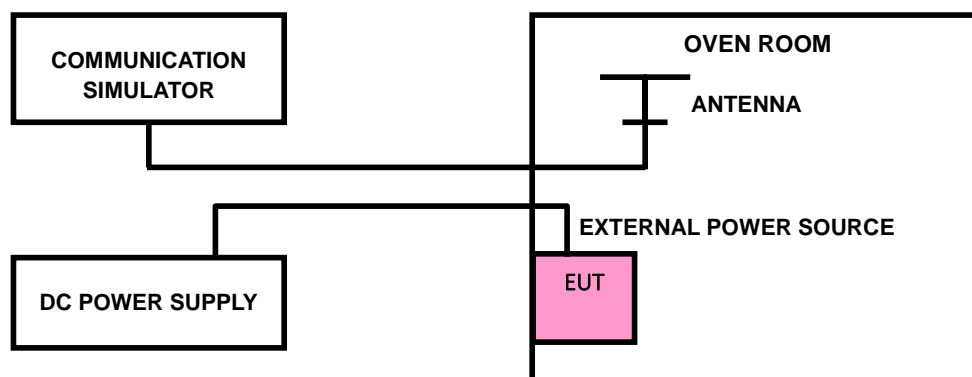



Test Report No.: W7L-P23100014RF07

3.2.4 TEST RESULTS

Please Refer to Appendix Of this test report.

Note: VL = Low voltage(3.6V); VN/NV = Normal voltage(3.7V); VH = High voltage(4.2V);
NT = Normal temperature (25°C)

3.3 OCCUPIED BANDWIDTH MEASUREMENT

3.3.1 LIMITS OF OCCUPIED BANDWIDTH MEASUREMENT

The width of a frequency band such that, below the lower and above the upper frequency limits, the mean powers emitted are each equal to a specified percentage 0.5 %of the total mean power of a given emission.

3.3.2 TEST SETUP

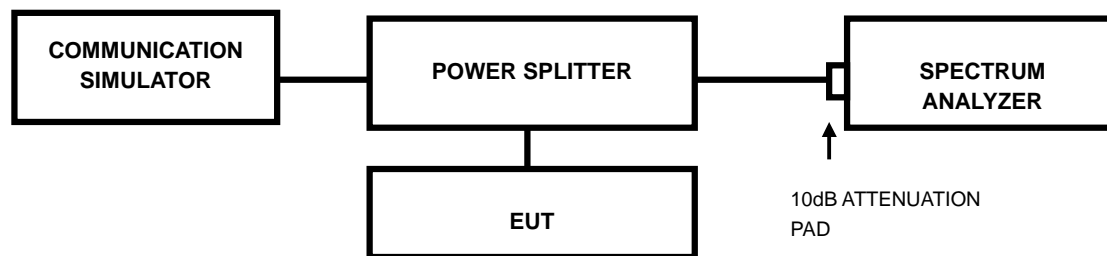

3.3.3 TEST PROCEDURES

- The conducted occupied bandwidth used the power splitter via EUT RF power connector between simulation base station and spectrum analyzer.
- Use OBW measurement function of Spectrum analyzer to measure 99 % occupied bandwidth.



Test Report No.: W7L-P23100014RF07

3.3.4 TEST RESULTS

Please Refer to Appendix Of this test report.



3.4 BAND EDGE MEASUREMENT

3.4.1 LIMITS OF BAND EDGE MEASUREMENT

According to FCC Part 27.53(h) specified that For operations in the 1710-1755 MHz band, the power of any emission outside a licensee's frequency band(s) of operation shall be attenuated below the transmitter power (P) within the licensed band(s) of operation, measured in watts, by at least $43 + 10 \log (P)$ dB. However, in the 1 megahertz bands immediately outside and adjacent to the licensee's frequency block, a resolution bandwidth of at least one percent of the emission bandwidth of the fundamental emission of the transmitter may be employed.

According to FCC Part 27.53(m)(4) specified that For mobile digital stations, the attenuation factor shall be not less than $40 + 10 \log (P)$ dB on all frequencies between the channel edge and 5 megahertz from the channel edge, $43 + 10 \log (P)$ dB on all frequencies between 5 megahertz and X megahertz from the channel edge, and $55 + 10 \log (P)$ dB on all frequencies more than X megahertz from the channel edge, where X is the greater of 6 megahertz or the actual emission bandwidth as defined in paragraph (m)(6) of this section. In addition, the attenuation factor shall not be less that $43 + 10 \log (P)$ dB on all frequencies between 2490.5 MHz and 2496 MHz and $55 + 10 \log (P)$ dB at or below 2490.5 MHz. Mobile Satellite Service licensees operating on frequencies below 2495 MHz may also submit a documented interference complaint against BRS licensees operating on channel BRS Channel 1 on the same terms and conditions as adjacent channel BRS or EBS licensees. For mobile digital stations, in the 1 megahertz bands immediately outside and adjacent to the frequency block a resolution bandwidth of at least two percent may be employed.

According to FCC Part 27.53 (n)(2)For mobile operations in the 3450-3550 MHz band, the conducted power of any emission outside the licensee's authorized bandwidth shall not exceed -13 dBm/MHz. Compliance with this paragraph is based on the use of measurement instrumentation employing a lresolution bandwidth of 1 megahertz or greater. However, in the 1 megahertz bands immediately outside and adjacent to the licensee's frequency block, a resolution bandwidth of at least one percent of the emission bandwidth of the fundamental emission of the transmitter may be employed, but limited to a maximum of 200 kHz. In the bands between 1 and 5 MHz removed from the licensee's frequency block, the minimum resolution bandwidth for the measurement shall be 500 kHz.

3.4.2 TEST SETUP

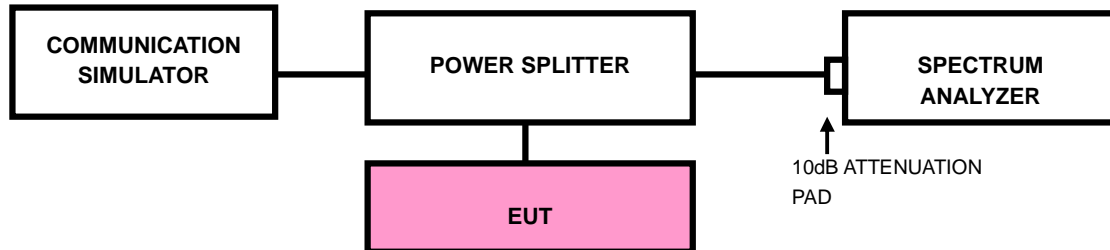



3.4.3 TEST PROCEDURES

- a) Connect the transmitter to the spectrum analyzer via coaxial cable while ensuring proper impedance matching.
- b) Tune the analyzer to the nominal center frequency of the emission bandwidth (EBW).
- c) Set the resolution bandwidth (RBW) $\geq 1\%$ EBW in the 1MHz band immediately outside and adjacent to the band edge.
- d) Beyond the 1MHz band from the band edge, RBW=1MHz was used.
- e) Set the video bandwidth (VBW) to $\geq 3 \times$ RBW.
- f) Select the average power (RMS) display detector.
- g) Set the number of measurement points to ≥ 1001 .
- h) Use auto-coupled sweep time.
- i) Perform the measurement over an interval of time when the transmission is continuous and at its maximum power level.
- j) The RF fundamental frequency should be excluded against the limit line in the operating frequency band and use RBW is 10KHz or 100KHz.
- k) Record the max trace plot into the test report.



Test Report No.: W7L-P23100014RF07

3.4.4 TEST RESULTS

Please Refer to Appendix Of this test report.

3.5 CONDUCTED SPURIOUS EMISSIONS

3.5.1 LIMITS OF CONDUCTED SPURIOUS EMISSIONS MEASUREMENT

The power of any emission outside of the authorized operating frequency ranges must be attenuated below the transmitting power (P) by a factor of at least $43 + 10 \log(P)$ dB. The emission limit equal to -13dBm .

For: LTE Band7/Band41

The power of any emission outside a licensee's frequency block shall be attenuated below the transmitter power (P) by at least $55 + 10 \log_{10}(P)$ dB. The limit of emission is equal to -25dBm .

3.5.2 TEST PROCEDURE

- a. The EUT makes a phone call to the communication simulator. All measurements were done at low, middle and high operational frequency range.
- b. Measuring frequency range is from 9kHz up to a frequency including its 10th harmonic. 10dB attenuation pad is connected with spectrum. RBW=1MHz and VBW=3MHz is used for conducted emission measurement.

3.5.3 TEST SETUP

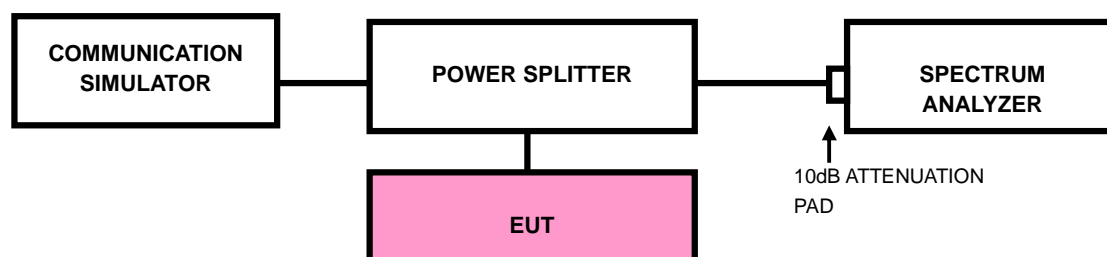



Test Report No.: W7L-P23100014RF07

3.5.4 TEST RESULTS

NOTE : The 9K~30MHz amplitude of spurious emissions attenuated more than 20 dB below the permissible value is not required in the report.

Please Refer to Appendix Of this test report.



3.6 RADIATED EMISSION MEASUREMENT

3.6.1 LIMITS OF RADIATED EMISSION MEASUREMENT

The power of any emission outside of the authorized operating frequency ranges must be attenuated below the transmitting power (P) by a factor of at least $43 + 10 \log(P)$ dB. The emission limit equal to -13dBm .

For: LTE Band7/ Band41

The power of any emission outside a licensee's frequency block shall be attenuated below the transmitter power (P) by at least $55 + 10 \log_{10}(P)$ dB. The limit of emission is equal to -25dBm .

3.6.2 TEST PROCEDURES

- a. Substitution method is used for E.I.R.P measurement. In the semi-anechoic chamber, EUT placed on the 0.8m height of Turn Table, rotated the table around 360 degrees to search the maximum radiation power and receiver antenna shall be rotated vertical and horizontal polarization and moved height from 1m to 4m to find the maximum polar radiated power. The "Read Value" is the spectrum reading the maximum power value.
- b. The substitution horn antenna is substituted for EUT at the same position and signals generator export the CW signal to the substitution antenna via a TX cable. Rotated the Turn Table and moved receiving antenna to find the maximum radiation power. Adjust output power level of S.G to get a Value of spectrum reading equal to "Read Value" of step a. Record the power level of S.G.
- c. $\text{EIRP} = \text{Output power level of S.G} - \text{TX cable loss} + \text{Antenna gain of substitution horn}$.
- d. E.R.P power can be calculated form E.I.R.P power by subtracting the gain of dipole, $\text{E.R.P power} = \text{E.I.P.R power} - 2.15\text{dBi}$.

NOTE: The resolution bandwidth of spectrum analyzer is 1 MHz and the video bandwidth is 3 MHz.

3.6.3 DEVIATION FROM TEST STANDARD

No deviation

3.6.4 TEST SETUP

< Frequency Range below 30MHz >

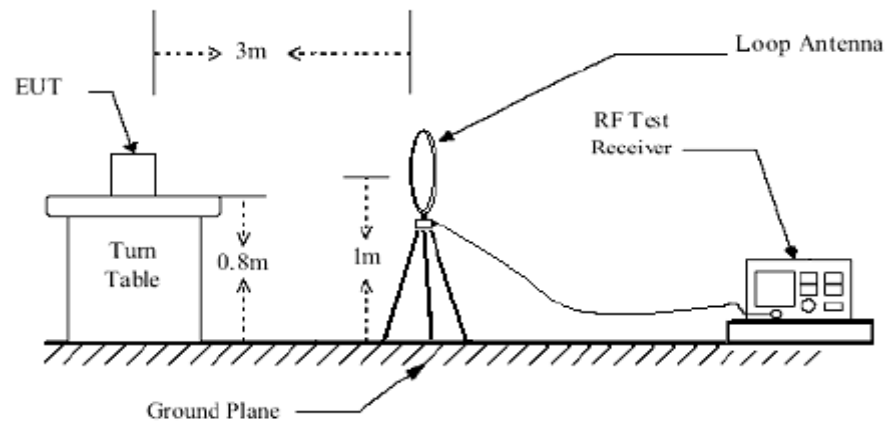

< Frequency Range 30MHz~1GHz >

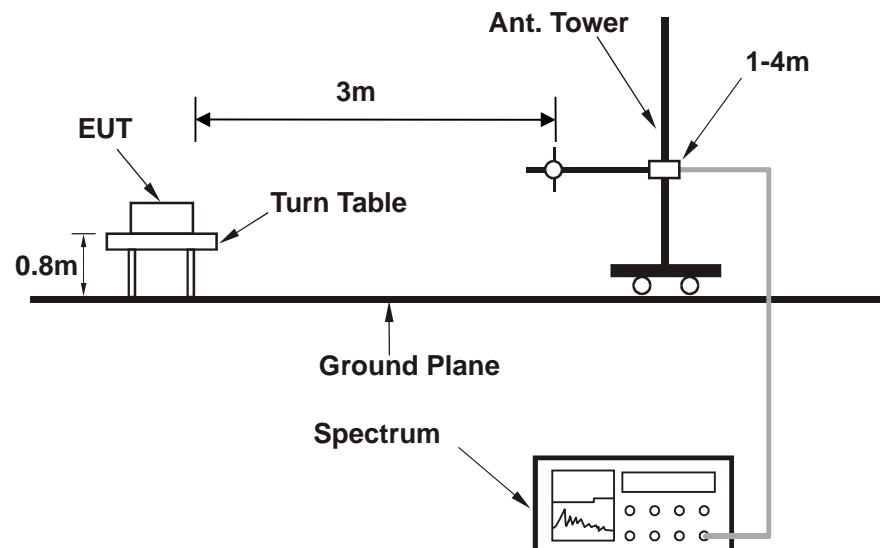

<Frequency Range above 1GHz>

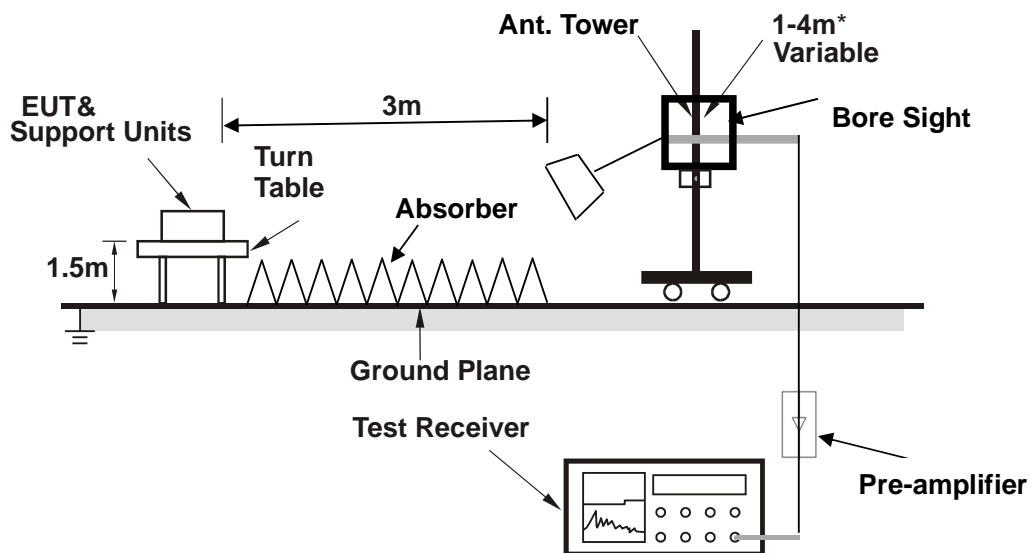

Note: Above 1G is a directional antenna depends on the EUT height and the antenna 3dB beamwidth both, refer to section 7.3 of CISPR 16-2-3.

For the actual test configuration, please refer to the attached file (Test Setup Photo).



3.6.5 TEST RESULTS

NOTE : The 9K~30MHz amplitude of spurious emissions attenuated more than 20 dB below the permissible value is not required in the report.

BELOW 1GHz WORST-CASE DATA

30 MHz – 1GHz data:

LTE Band 41

CHANNEL BANDWIDTH: 10MHz / QPSK

MODE	TX channel 40620	FREQUENCY RANGE	Below 1000MHz
ENVIRONMENTAL CONDITIONS	23deg. C, 70%RH	INPUT POWER	AC 120V/60HZ
TESTED BY	Jace Hu		
ANTENNA POLARITY & TEST DISTANCE: HORIZONTAL AT 3 M			

Rg	Frequency [MHz]	PK+ Level [dBm]	PK+ Limit [dBm]	PK+ Margin [dB]	Correction [dB]	Polarization	Azimuth [deg]	Antenna Height [m]
1	33.900	-76.98	-25.00	51.98	-9.44	H	210.2	1
1	56.850	-74.56	-25.00	49.56	-5.15	H	210.2	1
1	152.800	-82.39	-25.00	57.39	-16.31	H	151	2
1	250.050	-73.91	-25.00	48.91	-7.42	H	151	2
1	307.050	-77.39	-25.00	52.39	-7.25	H	210.2	1
2	940.829	-74.75	-25.00	49.75	3.74	H	0.1	1

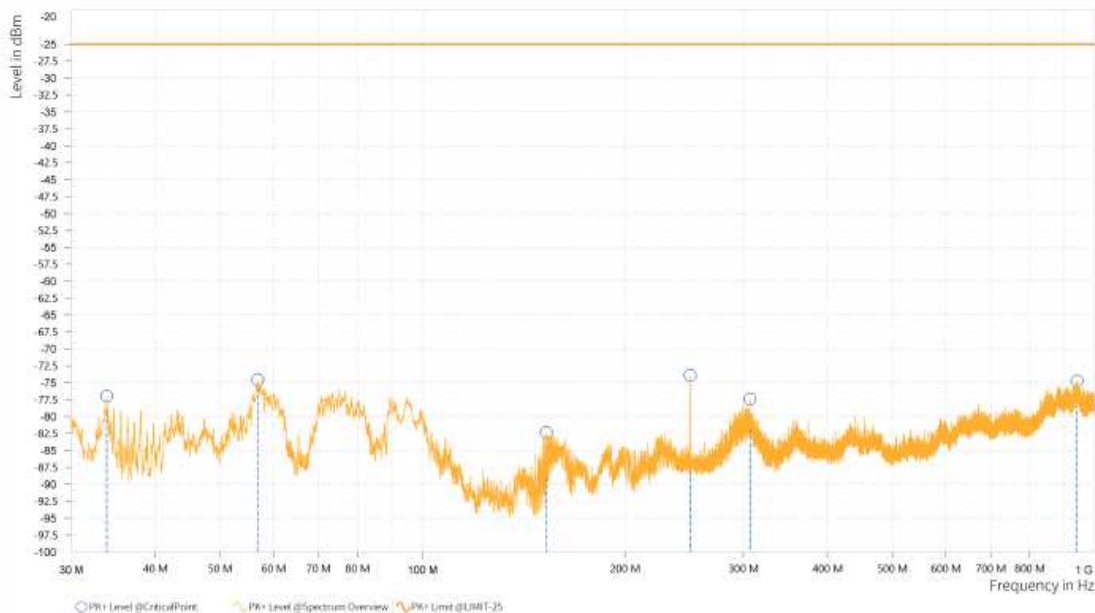



Test Report No.: W7L-P23100014RF07

MODE	TX channel 40620	FREQUENCY RANGE	Below 1000MHz
ENVIRONMENTAL CONDITIONS	23deg. C, 70%RH	INPUT POWER	AC 120V/60HZ
TESTED BY	Jace Hu		
ANTENNA POLARITY & TEST DISTANCE: VERTICAL AT 3 M			

Rg	Frequency [MHz]	PK+ Level [dBm]	PK+ Limit [dBm]	PK+ Margin [dB]	Correction [dB]	Polarization	Azimuth [deg]	Antenna Height [m]
1	34.000	-68.12	-25.00	43.12	-11.28	V	360	1
1	56.800	-72.73	-25.00	47.73	-4.03	V	152.2	2
1	125.000	-81.54	-25.00	56.54	-13.57	V	1.4	2
1	250.000	-76.07	-25.00	51.07	-9.47	V	152.2	2
2	562.521	-79.90	-25.00	54.90	-3.73	V	0	2
2	841.417	-74.85	-25.00	49.85	2.25	V	0.1	1





Test Report No.: W7L-P23100014RF07

ABOVE 1GHz

Note: For higher frequency, the emission is too low to be detected.

LTE BAND 41

CHANNEL BANDWIDTH: 5MHz / QPSK

MODE	TX channel 40620	FREQUENCY RANGE	Above 1000MHz
ENVIRONMENTAL CONDITIONS	23deg. C, 70%RH	INPUT POWER	AC 120V/60Hz
TESTED BY	Jace Hu		
ANTENNA POLARITY & TEST DISTANCE: HORIZONTAL AT 3 M			

Rg	Frequency [MHz]	PK+ Level [dBm]	PK+ Limit [dBm]	PK+ Margin [dB]	Correction [dB]	Polarization	Azimuth [deg]	Antenna Height [m]
4	5,182.000	-45.29	-25.00	20.29	26.11	H	183.7	1
5	7,737.500	-39.35	-25.00	14.35	32.82	H	269.8	1

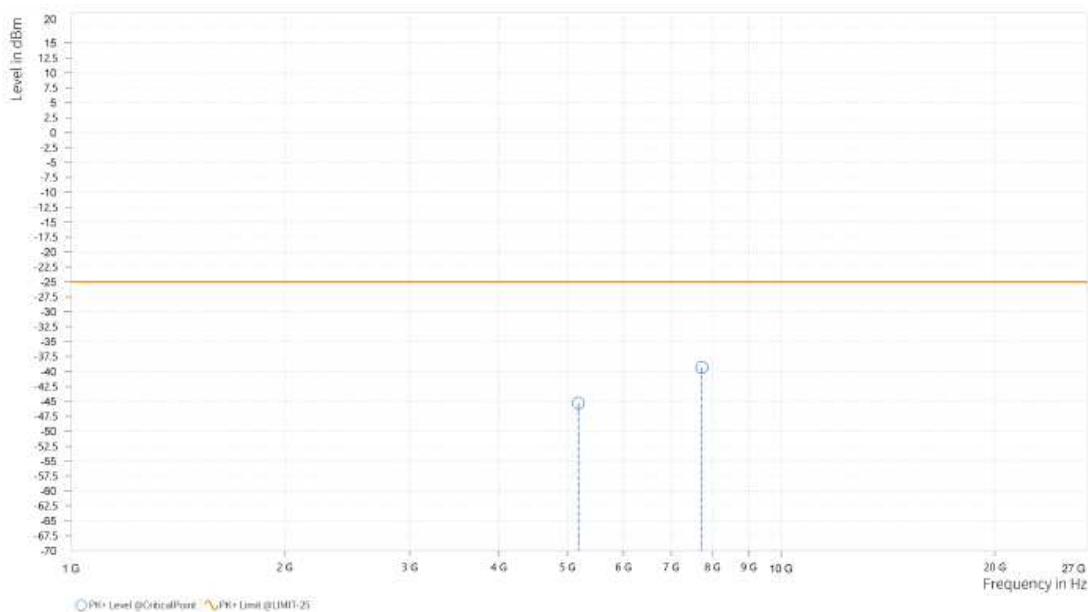



Test Report No.: W7L-P23100014RF07

MODE	TX channel 40620	FREQUENCY RANGE	Above 1000MHz
ENVIRONMENTAL CONDITIONS	23deg. C, 70%RH	INPUT POWER	AC 120V/60Hz
TESTED BY	Jace Hu		
ANTENNA POLARITY & TEST DISTANCE: VERTICAL AT 3 M			

Rg	Frequency [MHz]	PK+ Level [dBm]	PK+ Limit [dBm]	PK+ Margin [dB]	Correction [dB]	Polarization	Azimuth [deg]	Antenna Height [m]
4	5,181.500	-47.39	-25.00	22.39	25.91	V	186	1
5	7,766.500	-39.35	-25.00	14.35	33.02	V	359.1	1

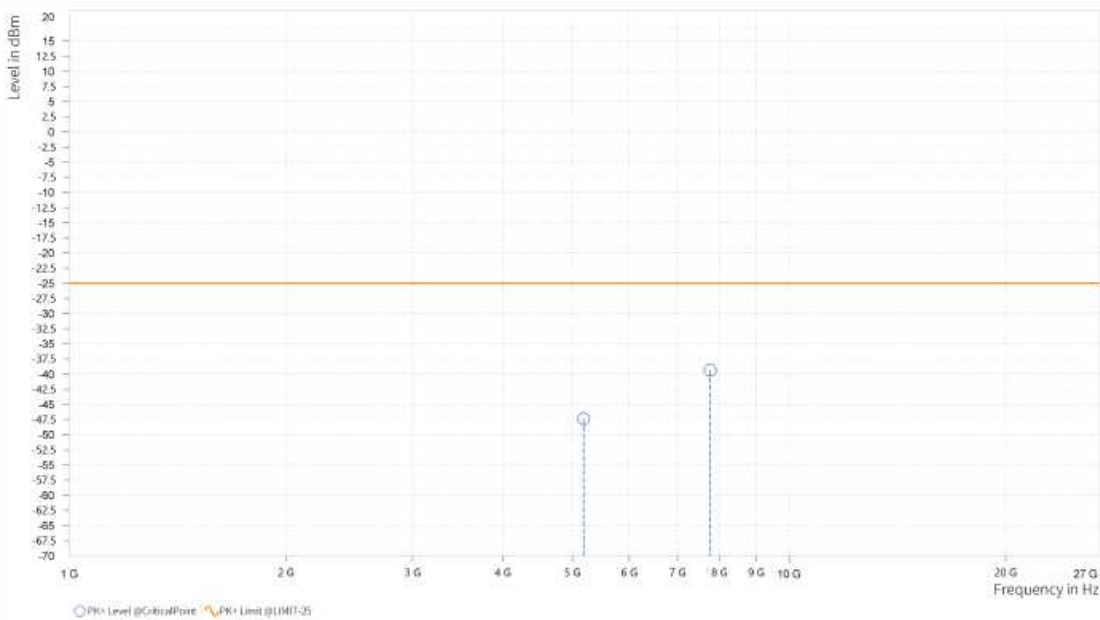



Test Report No.: W7L-P23100014RF07

CHANNEL BANDWIDTH: 10MHz / QPSK
CH39700

MODE	TX channel 39700	FREQUENCY RANGE	Above 1000MHz
ENVIRONMENTAL CONDITIONS	23deg. C, 70%RH	INPUT POWER	AC 120V/60Hz
TESTED BY	Jace Hu		
ANTENNA POLARITY & TEST DISTANCE: HORIZONTAL AT 3 M			

Rg	Frequency [MHz]	PK+ Level [dBm]	PK+ Limit [dBm]	PK+ Margin [dB]	Correction [dB]	Polarization	Azimuth [deg]	Antenna Height [m]
4	4,993.000	-47.80	-25.00	22.80	25.47	H	1	2
5	7,692.000	-39.51	-25.00	14.51	32.71	H	359.1	1

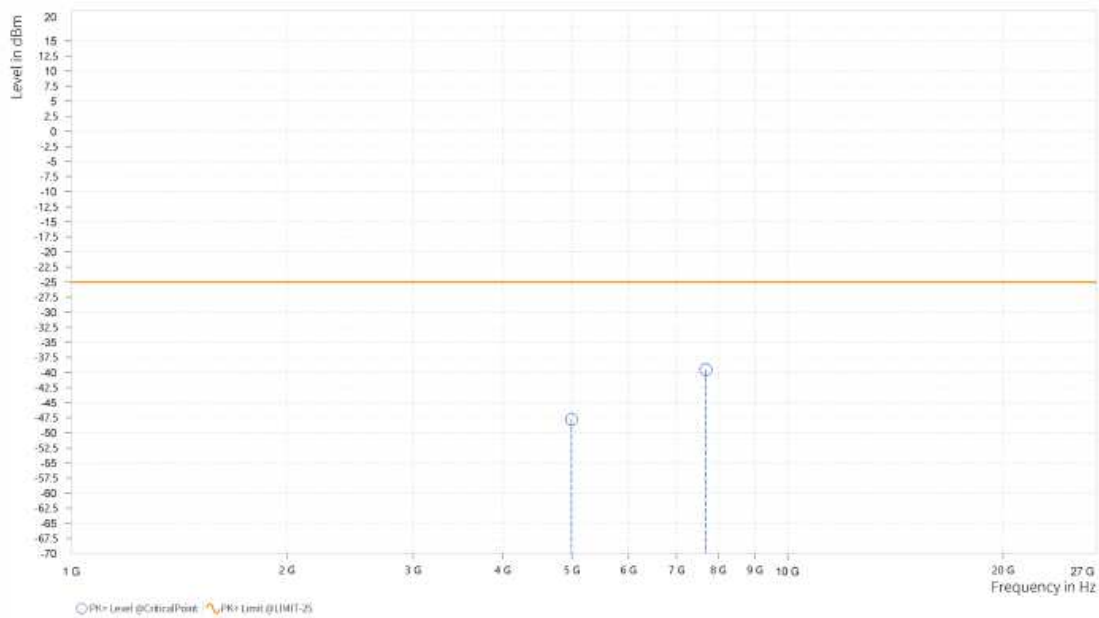



Test Report No.: W7L-P23100014RF07

MODE	TX channel 39700	FREQUENCY RANGE	Above 1000MHz
ENVIRONMENTAL CONDITIONS	23deg. C, 70%RH	INPUT POWER	AC 120V/60Hz
TESTED BY	Jace Hu		
ANTENNA POLARITY & TEST DISTANCE: VERTICAL AT 3 M			

Rg	Frequency [MHz]	PK+ Level [dBm]	PK+ Limit [dBm]	PK+ Margin [dB]	Correction [dB]	Polarization	Azimuth [deg]	Antenna Height [m]
4	4,993.000	-48.36	-25.00	23.36	25.29	V	158.4	2
5	7,458.000	-39.20	-25.00	14.20	31.72	V	0.9	2

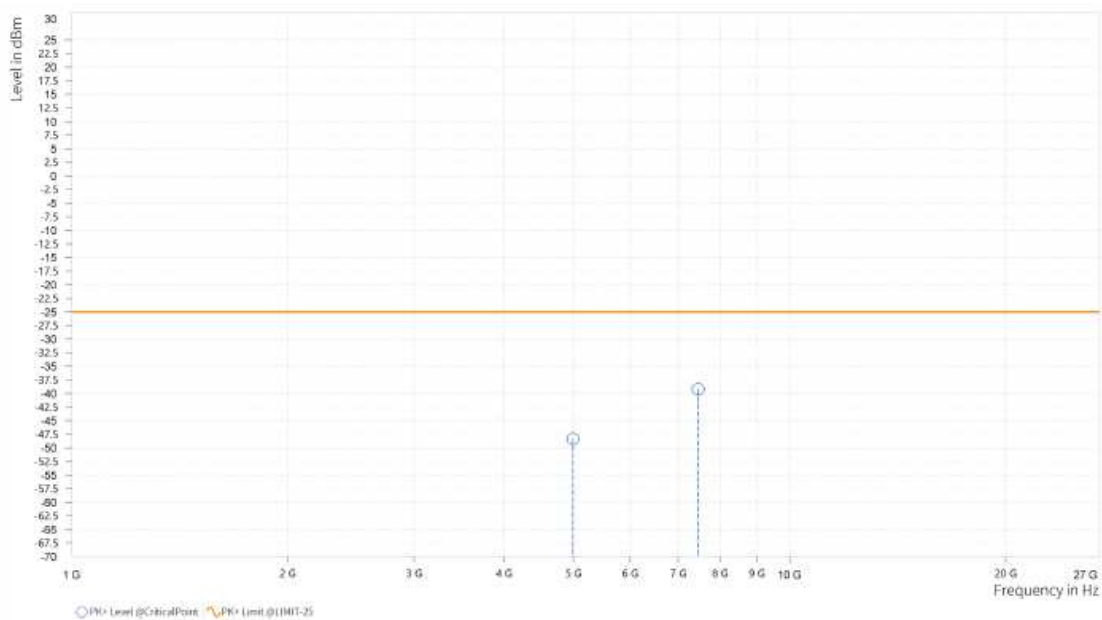



Test Report No.: W7L-P23100014RF07

CH40620

MODE	TX channel 40620	FREQUENCY RANGE	Above 1000MHz
ENVIRONMENTAL CONDITIONS	23deg. C, 70%RH	INPUT POWER	AC 120V/60Hz
TESTED BY	Jace Hu		
ANTENNA POLARITY & TEST DISTANCE: HORIZONTAL AT 3 M			

Rg	Frequency [MHz]	PK+ Level [dBm]	PK+ Limit [dBm]	PK+ Margin [dB]	Correction [dB]	Polarization	Azimuth [deg]	Antenna Height [m]
4	5,177.500	-45.42	-25.00	20.42	26.13	H	184.8	1
5	7,489.500	-39.41	-25.00	14.41	31.79	H	359	1

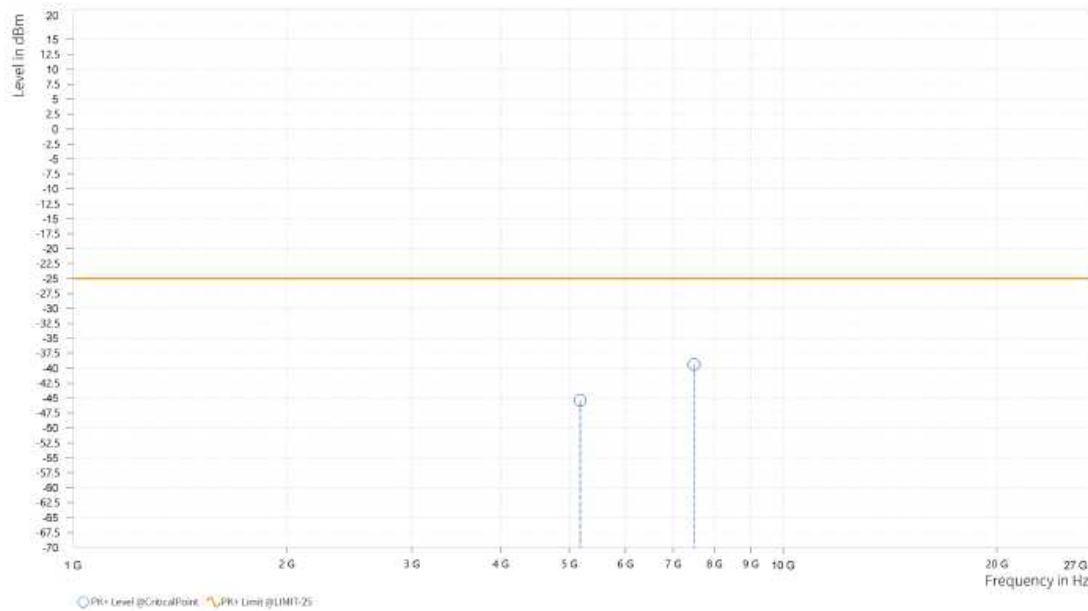



Test Report No.: W7L-P23100014RF07

MODE	TX channel 40620	FREQUENCY RANGE	Above 1000MHz
ENVIRONMENTAL CONDITIONS	23deg. C, 70%RH	INPUT POWER	AC 120V/60Hz
TESTED BY	Jace Hu		
ANTENNA POLARITY & TEST DISTANCE: VERTICAL AT 3 M			

Rg	Frequency [MHz]	PK+ Level [dBm]	PK+ Limit [dBm]	PK+ Margin [dB]	Correction [dB]	Polarization	Azimuth [deg]	Antenna Height [m]
4	5,177.500	-47.85	-25.00	22.85	25.95	V	184.8	1
5	7,477.000	-38.55	-25.00	13.55	31.79	V	359	2

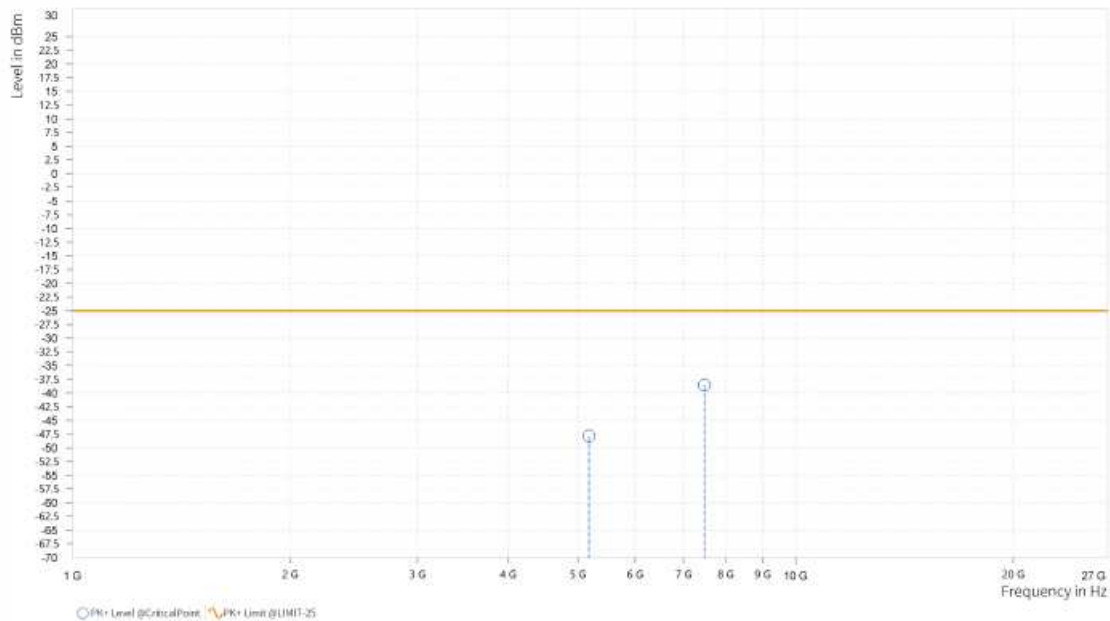



BUREAU VERITAS

Test Report No.: W7L-P23100014RF07

CH41540

MODE	TX channel 41540	FREQUENCY RANGE	Above 1000MHz
ENVIRONMENTAL CONDITIONS	23deg. C, 70%RH	INPUT POWER	AC 120V/60Hz
TESTED BY	Jace Hu		
ANTENNA POLARITY & TEST DISTANCE: HORIZONTAL AT 3 M			

Rg	Frequency [MHz]	PK+ Level [dBm]	PK+ Limit [dBm]	PK+ Margin [dB]	Correction [dB]	Polarization	Azimuth [deg]	Antenna Height [m]
4	5,361.500	-46.68	-25.00	21.68	27.17	H	1	2
5	7,774.000	-39.46	-25.00	14.46	32.85	H	269.7	1

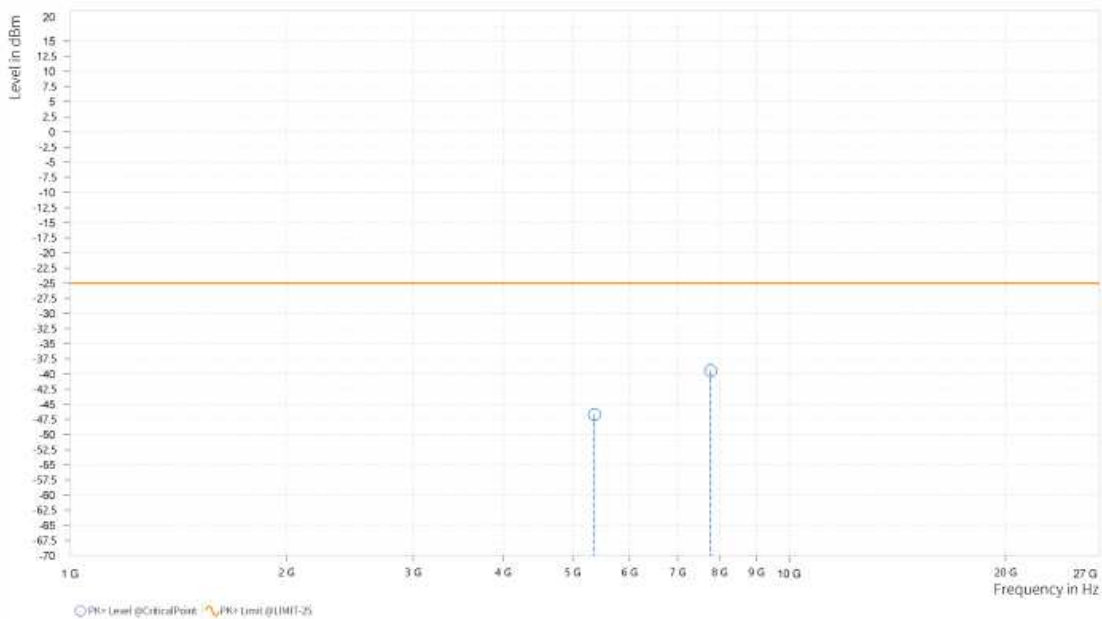



Test Report No.: W7L-P23100014RF07

MODE	TX channel 41540	FREQUENCY RANGE	Above 1000MHz
ENVIRONMENTAL CONDITIONS	23deg. C, 70%RH	INPUT POWER	AC 120V/60Hz
TESTED BY	Jace Hu		
ANTENNA POLARITY & TEST DISTANCE: VERTICAL AT 3 M			

Rg	Frequency [MHz]	PK+ Level [dBm]	PK+ Limit [dBm]	PK+ Margin [dB]	Correction [dB]	Polarization	Azimuth [deg]	Antenna Height [m]
4	5,361.500	-47.86	-25.00	22.86	26.51	V	359	1
5	7,896.000	-39.43	-25.00	14.43	33.05	V	89	2

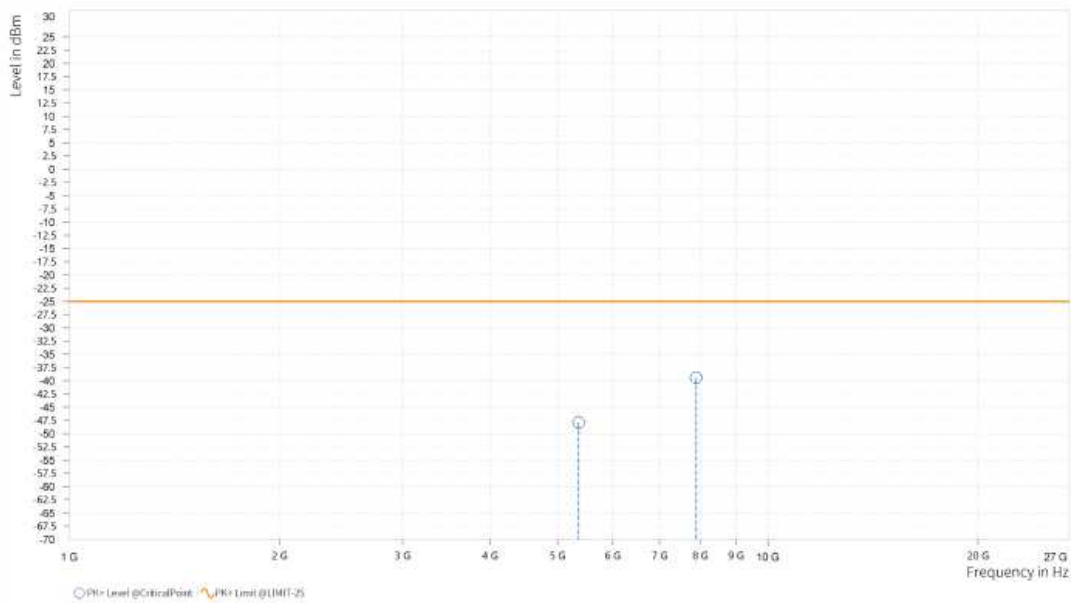



Test Report No.: W7L-P23100014RF07

CHANNEL BANDWIDTH: 15MHz / QPSK

MODE	TX channel 40620	FREQUENCY RANGE	Above 1000MHz
ENVIRONMENTAL CONDITIONS	23deg. C, 70%RH	INPUT POWER	AC 120V/60Hz
TESTED BY	Jace Hu		
ANTENNA POLARITY & TEST DISTANCE: HORIZONTAL AT 3 M			

Rg	Frequency [MHz]	PK+ Level [dBm]	PK+ Limit [dBm]	PK+ Margin [dB]	Correction [dB]	Polarization	Azimuth [deg]	Antenna Height [m]
4	5,173.000	-50.59	-25.00	25.59	26.16	H	0.9	2
5	7,749.000	-39.52	-25.00	14.52	32.83	H	359	2

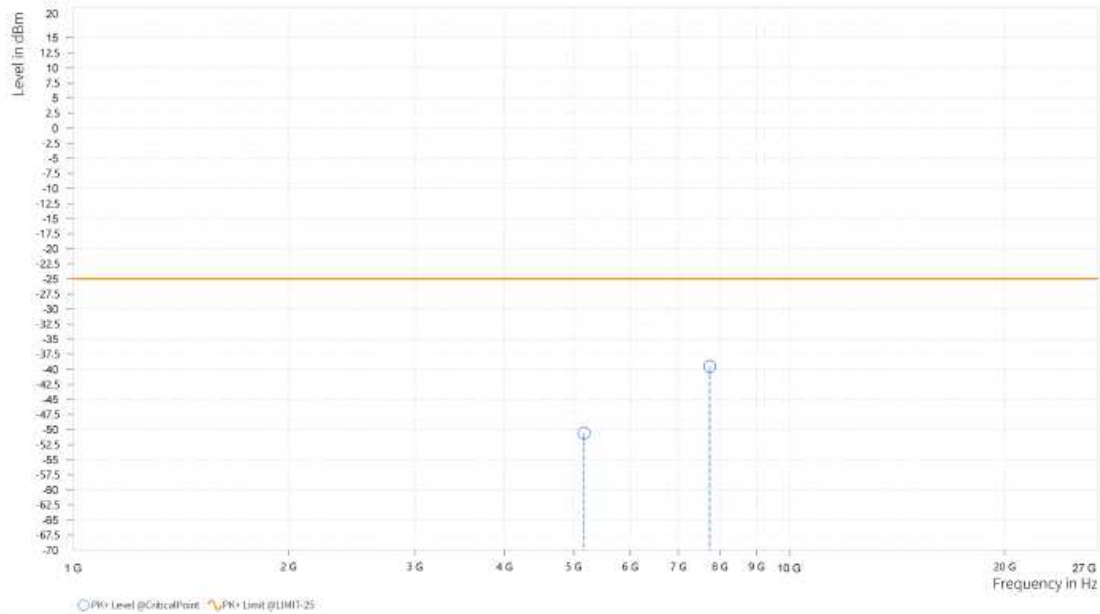



Test Report No.: W7L-P23100014RF07

MODE	TX channel 40620	FREQUENCY RANGE	Above 1000MHz
ENVIRONMENTAL CONDITIONS	23deg. C, 70%RH	INPUT POWER	AC 120V/60Hz
TESTED BY	Jace Hu		
ANTENNA POLARITY & TEST DISTANCE: VERTICAL AT 3 M			

Rg	Frequency [MHz]	PK+ Level [dBm]	PK+ Limit [dBm]	PK+ Margin [dB]	Correction [dB]	Polarization	Azimuth [deg]	Antenna Height [m]
4	5,173.500	-49.44	-25.00	24.44	25.99	V	183.7	1
5	7,709.500	-39.19	-25.00	14.19	32.93	V	90.2	2

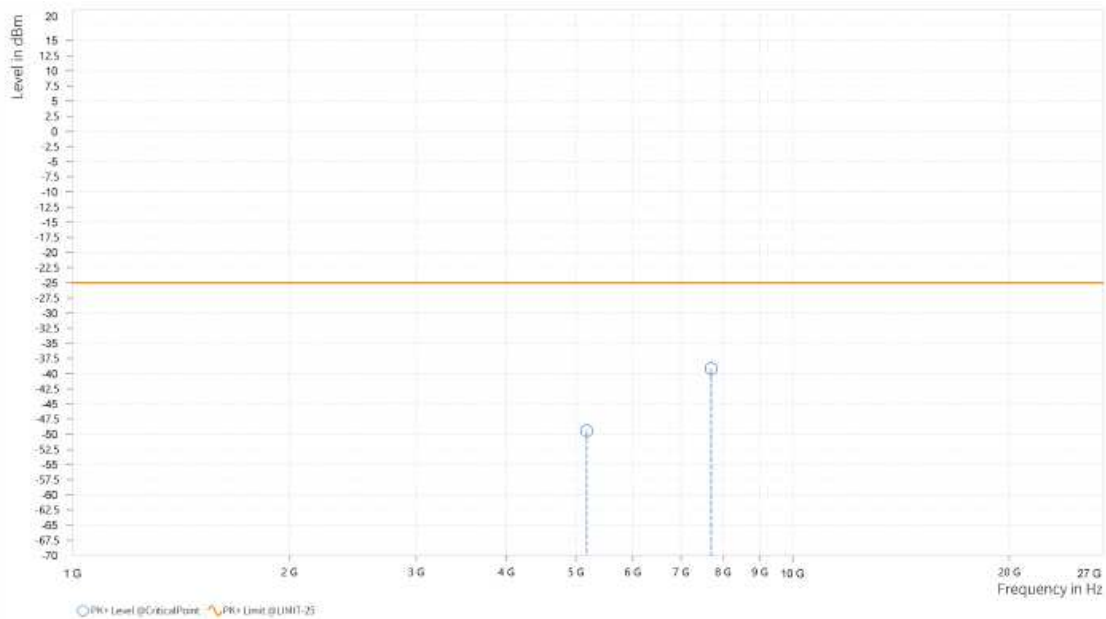



Test Report No.: W7L-P23100014RF07

CHANNEL BANDWIDTH: 20MHz / QPSK

MODE	TX channel 40620	FREQUENCY RANGE	Above 1000MHz
ENVIRONMENTAL CONDITIONS	23deg. C, 70%RH	INPUT POWER	AC 120V/60Hz
TESTED BY	Jace Hu		
ANTENNA POLARITY & TEST DISTANCE: HORIZONTAL AT 3 M			

Rg	Frequency [MHz]	PK+ Level [dBm]	PK+ Limit [dBm]	PK+ Margin [dB]	Correction [dB]	Polarization	Azimuth [deg]	Antenna Height [m]
4	5,168.000	-43.00	-25.00	18.00	26.18	H	1	2
5	7,487.000	-39.53	-25.00	14.53	31.77	H	1	1

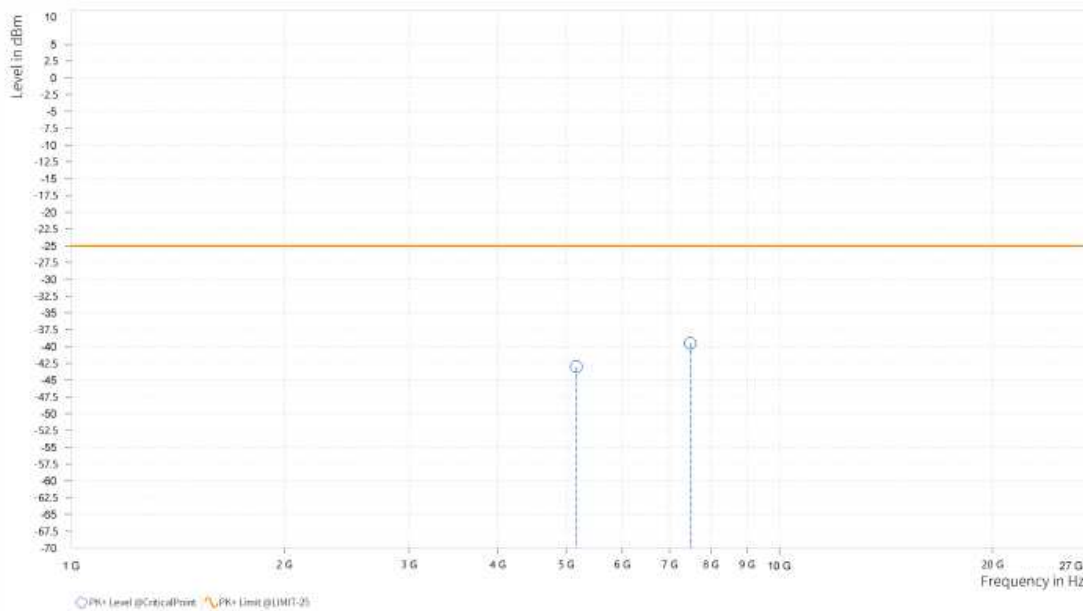



Test Report No.: W7L-P23100014RF07

MODE	TX channel 40620	FREQUENCY RANGE	Above 1000MHz
ENVIRONMENTAL CONDITIONS	23deg. C, 70%RH	INPUT POWER	AC 120V/60Hz
TESTED BY	Jace Hu		
ANTENNA POLARITY & TEST DISTANCE: VERTICAL AT 3 M			

Rg	Frequency [MHz]	PK+ Level [dBm]	PK+ Limit [dBm]	PK+ Margin [dB]	Correction [dB]	Polarization	Azimuth [deg]	Antenna Height [m]
4	5,168.500	-46.69	-25.00	21.69	26.05	V	359.1	1
5	7,735.000	-39.16	-25.00	14.16	33.03	V	268.6	1

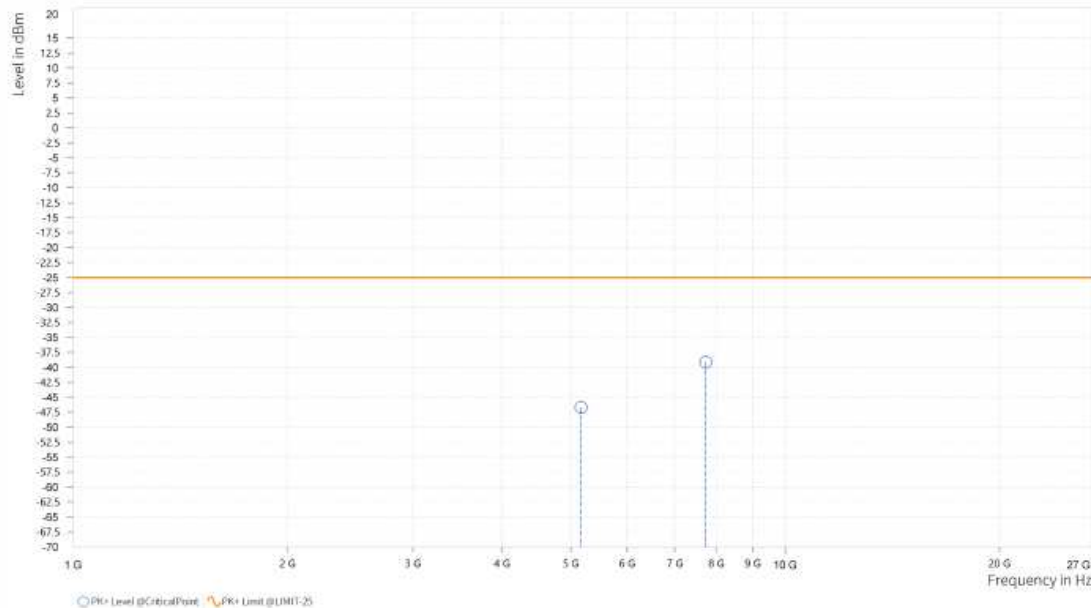



Test Report No.: W7L-P23100014RF07

LTE BAND 42

Note: For frequency above 27GHz, the emission was tested 20db below the limit so the data not recorded in the sheet.

CHANNEL BANDWIDTH: 5MHz / QPSK

MODE	TX channel 42840	FREQUENCY RANGE	Above 1000MHz
ENVIRONMENTAL CONDITIONS	23deg. C, 70%RH	INPUT POWER	AC 120V/60Hz
TESTED BY	Tony Xiong		
ANTENNA POLARITY & TEST DISTANCE: HORIZONTAL AT 3 M			

	Freq	Level	Read Level	Limit Line	Over Limit	Factor	Remark	Pol/Phase
	MHz	dBm/m	dBm	dBm/m	dB	dB/m		
1	7006.000	-51.80	-64.02	-13.00	-38.80	12.22	Peak	Horizontal
2	PP10500.000	-46.08	-64.67	-13.00	-33.08	18.59	Peak	Horizontal

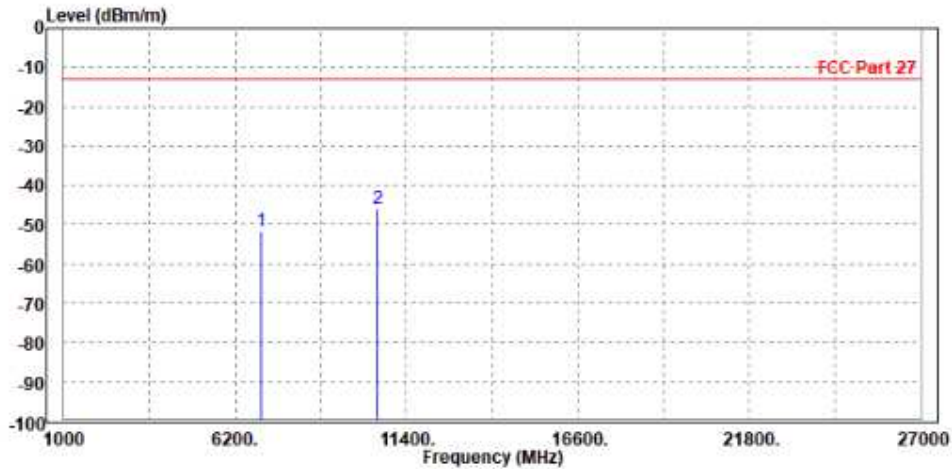



Test Report No.: W7L-P23100014RF07

MODE	TX channel 42840	FREQUENCY RANGE	Above 1000MHz
ENVIRONMENTAL CONDITIONS	23deg. C, 70%RH	INPUT POWER	AC 120V/60Hz
TESTED BY	Tony Xiong		
ANTENNA POLARITY & TEST DISTANCE: VERTICAL AT 3 M			

	Freq	Level	Read Level	Limit Line	Over Limit	Factor	Remark	Pol/Phase
	MHz	dBm/m	dBm	dBm/m	dB	dB/m		
1	7000.000	-51.50	-64.23	-13.00	-38.50	12.73	Peak	Vertical
2	PP10490.000	-46.37	-64.28	-13.00	-33.37	17.91	Peak	Vertical

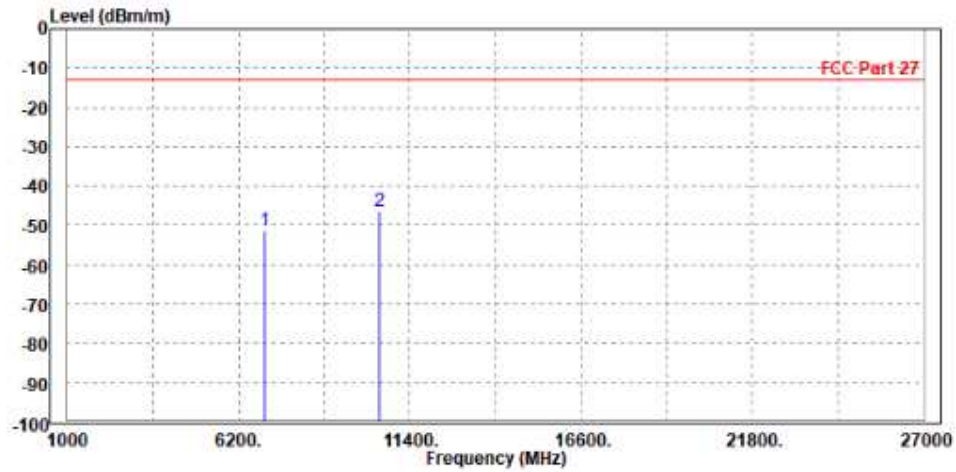



Test Report No.: W7L-P23100014RF07

CHANNEL BANDWIDTH: 10MHz / QPSK

MODE	TX channel 42840	FREQUENCY RANGE	Above 1000MHz
ENVIRONMENTAL CONDITIONS	23deg. C, 70%RH	INPUT POWER	AC 120V/60Hz
TESTED BY	Tony Xiong		
ANTENNA POLARITY & TEST DISTANCE: HORIZONTAL AT 3 M			

	Freq	Level	Read Level	Limit Line	Over Limit	Factor	Remark	Pol/Phase
	MHz	dBm/m	dBm	dBm/m	dB	dB/m		
1	7006.000	-51.46	-63.68	-13.00	-38.46	12.22	Peak	Horizontal
2	PP10500.000	-45.78	-64.37	-13.00	-32.78	18.59	Peak	Horizontal

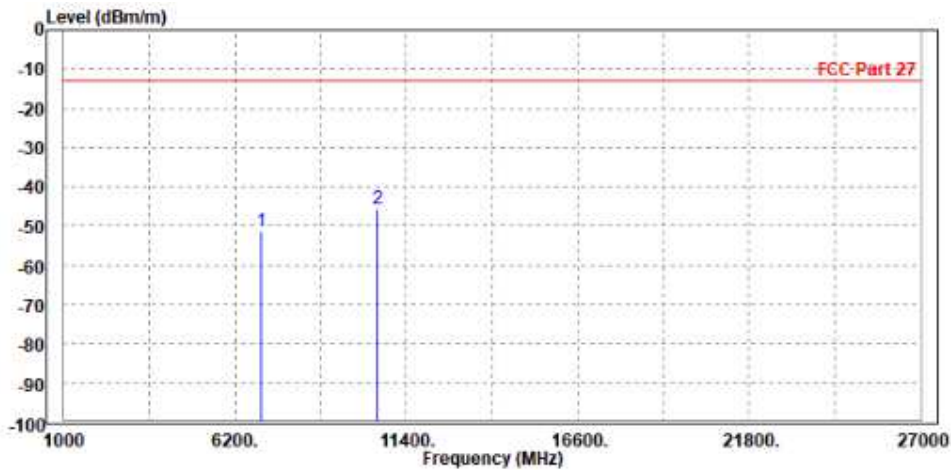



Test Report No.: W7L-P23100014RF07

MODE	TX channel 42840	FREQUENCY RANGE	Above 1000MHz
ENVIRONMENTAL CONDITIONS	23deg. C, 70%RH	INPUT POWER	AC 120V/60Hz
TESTED BY	Tony Xiong		
ANTENNA POLARITY & TEST DISTANCE: VERTICAL AT 3 M			

	Freq	Level	Read Level	Limit Line	Over Limit	Factor	Remark	Pol/Phase
	MHz	dBm/m	dBm	dBm/m	dB	dB/m		
1	7006.000	-51.31	-64.06	-13.00	-38.31	12.75	Peak	Vertical
2	PP10500.000	-46.12	-64.03	-13.00	-33.12	17.91	Peak	Vertical

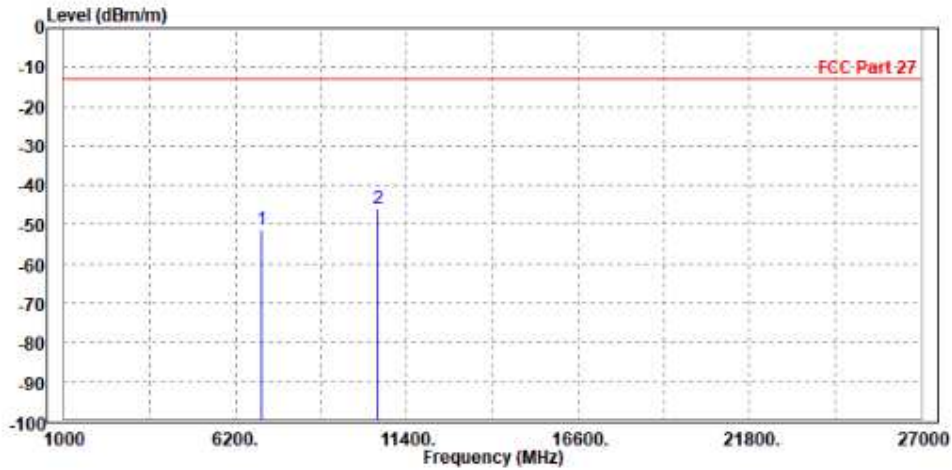



Test Report No.: W7L-P23100014RF07

CHANNEL BANDWIDTH: 15MHz / QPSK

MODE	TX channel 42840	FREQUENCY RANGE	Above 1000MHz
ENVIRONMENTAL CONDITIONS	23deg. C, 70%RH	INPUT POWER	AC 120V/60Hz
TESTED BY	Tony Xiong		
ANTENNA POLARITY & TEST DISTANCE: HORIZONTAL AT 3 M			

	Freq	Level	Read Level	Limit Line	Over Limit	Factor	Remark	Pol/Phase
	MHz	dBm/m	dBm	dBm/m	dB	dB/m		
1	7000.000	-52.23	-64.46	-13.00	-39.23	12.23	Peak	Horizontal
2	PP10490.000	-45.63	-64.23	-13.00	-32.63	18.60	Peak	Horizontal

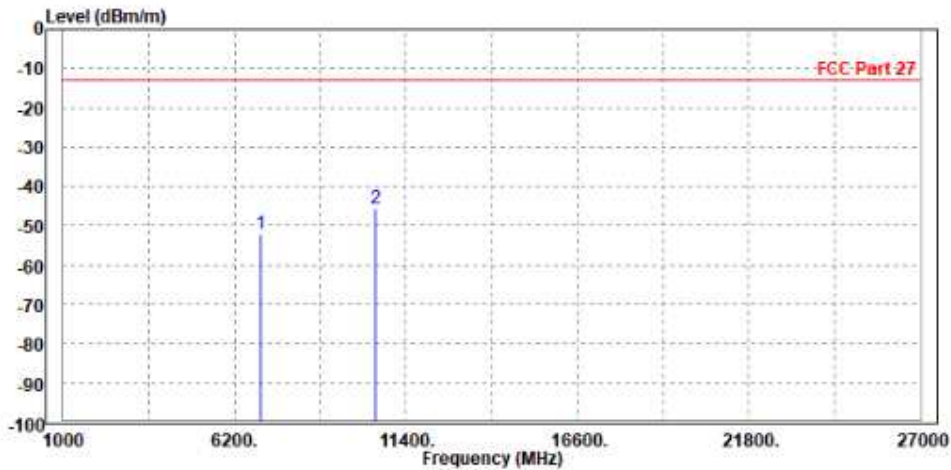



Test Report No.: W7L-P23100014RF07

MODE	TX channel 42840	FREQUENCY RANGE	Above 1000MHz
ENVIRONMENTAL CONDITIONS	23deg. C, 70%RH	INPUT POWER	AC 120V/60Hz
TESTED BY	Tony Xiong		
ANTENNA POLARITY & TEST DISTANCE: VERTICAL AT 3 M			

	Freq	Level	Read Level	Limit Line	Over Limit	Factor	Remark	Pol/Phase
	MHz	dBm/m	dBm	dBm/m	dB	dB/m		
1	7006.000	-51.09	-63.84	-13.00	-38.09	12.75	Peak	Vertical
2	PP10500.000	-46.59	-64.50	-13.00	-33.59	17.91	Peak	Vertical

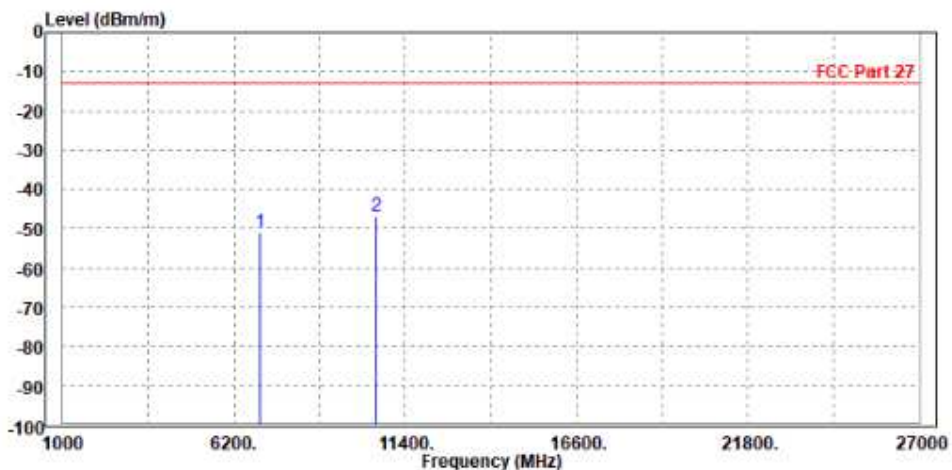



Test Report No.: W7L-P23100014RF07

CHANNEL BANDWIDTH: 20MHz / QPSK

CH 42190

MODE	TX channel 42190	FREQUENCY RANGE	Above 1000MHz
ENVIRONMENTAL CONDITIONS	23deg. C, 70%RH	INPUT POWER	AC 120V/60Hz
TESTED BY	Tony Xiong		
ANTENNA POLARITY & TEST DISTANCE: HORIZONTAL AT 3 M			

	Freq	Level	Read Level	Limit Line	Over Limit	Factor	Remark	Pol/Phase
	MHz	dBm/m	dBm	dBm/m	dB	dB/m		
1	6928.000	-51.59	-63.73	-13.00	-38.59	12.14	Peak	Horizontal
2	PP10380.000	-46.93	-65.63	-13.00	-33.93	18.70	Peak	Horizontal

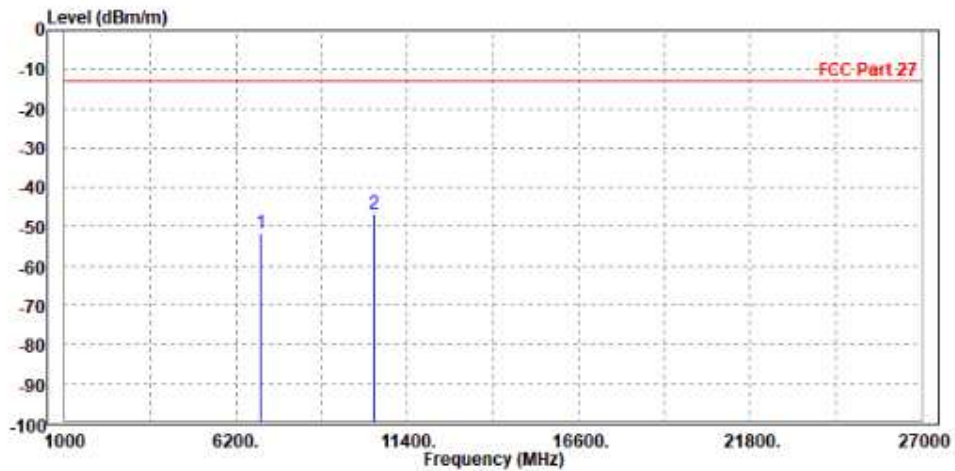



Test Report No.: W7L-P23100014RF07

MODE	TX channel 42190	FREQUENCY RANGE	Above 1000MHz
ENVIRONMENTAL CONDITIONS	23deg. C, 70%RH	INPUT POWER	AC 120V/60Hz
TESTED BY	Tony Xiong		
ANTENNA POLARITY & TEST DISTANCE: VERTICAL AT 3 M			

	Freq	Level	Read Level	Limit Line	Over Limit	Factor	Remark	Pol/Phase
	MHz	dBm/m	dBm	dBm/m	dB	dB/m		
1	6920.000	-50.95	-63.64	-13.00	-37.95	12.69	Peak	Vertical
2	PP10386.000	-47.49	-65.40	-13.00	-34.49	17.91	Peak	Vertical

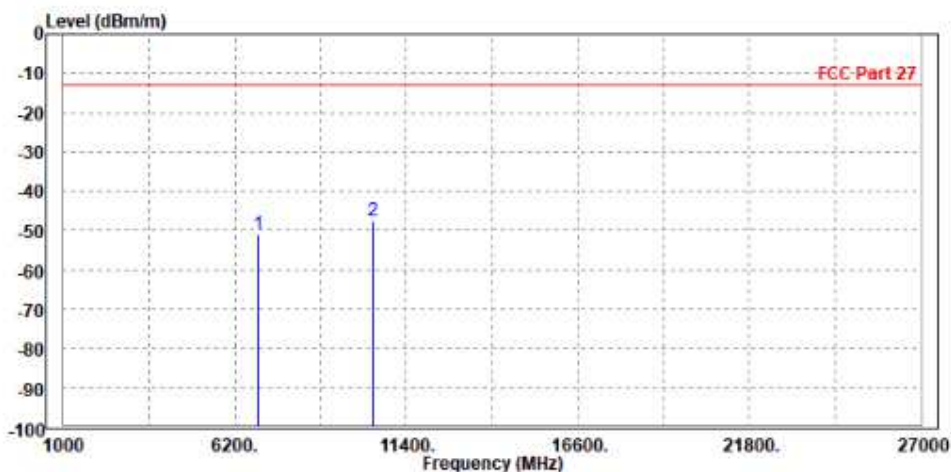



**BUREAU
VERITAS**

Test Report No.: W7L-P23100014RF07

CH 42840

MODE	TX channel 42840	FREQUENCY RANGE	Above 1000MHz
ENVIRONMENTAL CONDITIONS	23deg. C, 70%RH	INPUT POWER	AC 120V/60Hz
TESTED BY	Tony Xiong		
ANTENNA POLARITY & TEST DISTANCE: HORIZONTAL AT 3 M			

	Freq	Level	Read Level	Limit Line	Over Limit	Factor	Remark	Pol/Phase
	MHz	dBm/m	dBm	dBm/m	dB	dB/m		
1	7006.000	-52.22	-64.44	-13.00	-39.22	12.22	Peak	Horizontal
2	PP10500.000	-45.01	-63.60	-13.00	-32.01	18.59	Peak	Horizontal

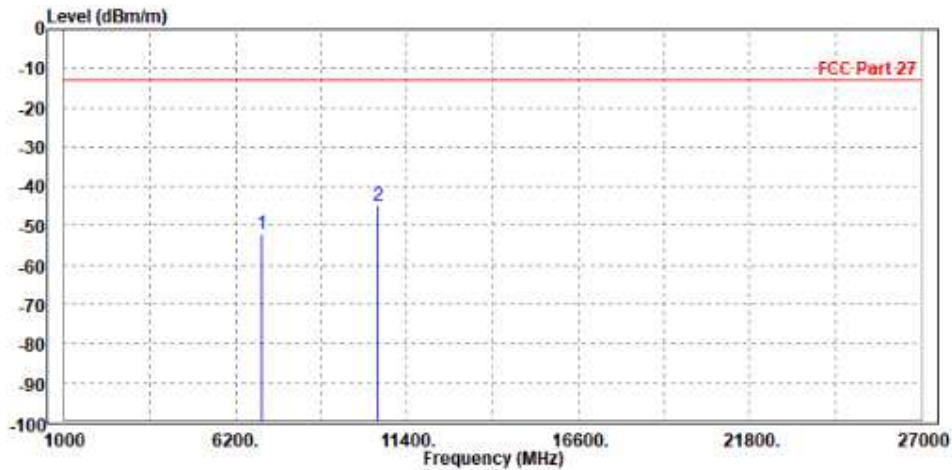



Test Report No.: W7L-P23100014RF07

MODE	TX channel 42840	FREQUENCY RANGE	Above 1000MHz
ENVIRONMENTAL CONDITIONS	23deg. C, 70%RH	INPUT POWER	AC 120V/60Hz
TESTED BY	Tony Xiong		
ANTENNA POLARITY & TEST DISTANCE: VERTICAL AT 3 M			

	Freq	Level	Read Level	Limit Line	Over Limit	Factor	Remark	Pol/Phase
	MHz	dBm/m	dBm	dBm/m	dB	dB/m		
1	7000.000	-52.58	-65.31	-13.00	-39.58	12.73	Peak	Vertical
2	PP10490.000	-46.33	-64.24	-13.00	-33.33	17.91	Peak	Vertical

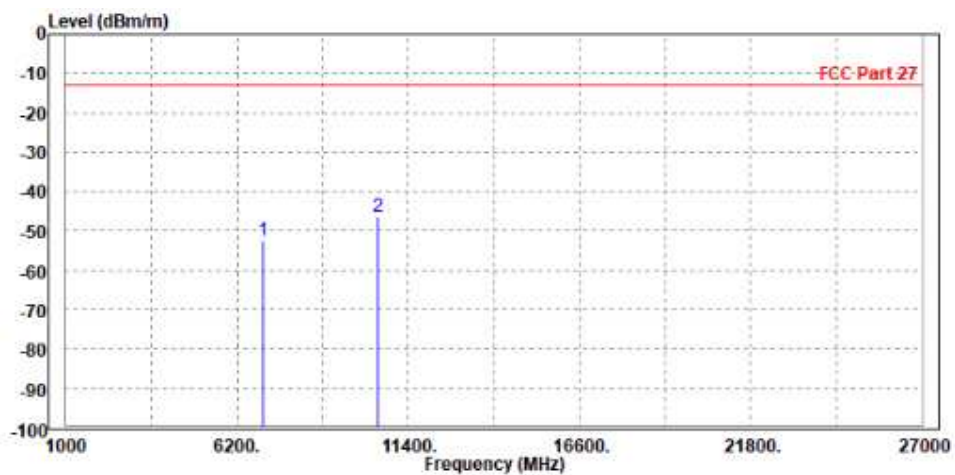



**BUREAU
VERITAS**

Test Report No.: W7L-P23100014RF07

CH 43490

MODE	TX channel 43490	FREQUENCY RANGE	Above 1000MHz
ENVIRONMENTAL CONDITIONS	23deg. C, 70%RH	INPUT POWER	AC 120V/60Hz
TESTED BY	Tony Xiong		
ANTENNA POLARITY & TEST DISTANCE: HORIZONTAL AT 3 M			

	Freq	Level	Read Level	Limit Line	Over Limit	Factor	Remark	Pol/Phase
	MHz	dBm/m	dBm	dBm/m	dB	dB/m		
1	7080.000	-52.11	-64.21	-13.00	-39.11	12.10	Peak	Horizontal
2	PP10620.000	-46.05	-64.97	-13.00	-33.05	18.92	Peak	Horizontal

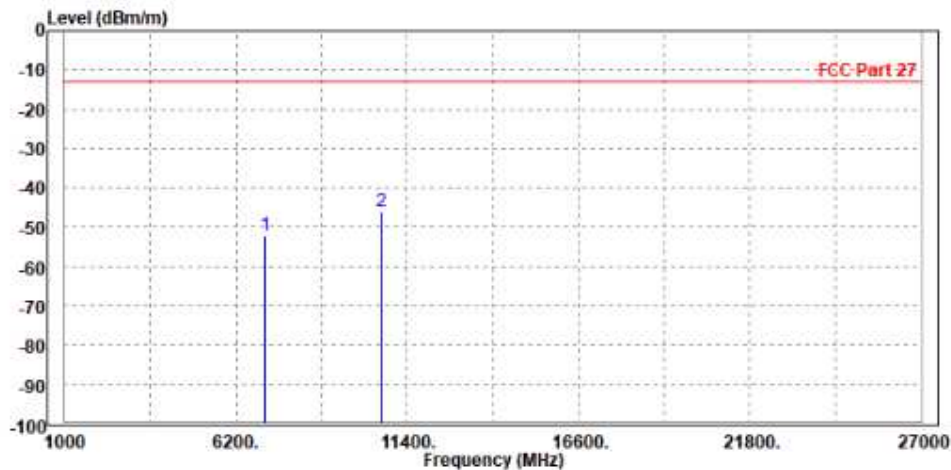



Test Report No.: W7L-P23100014RF07

MODE	TX channel 43490	FREQUENCY RANGE	Above 1000MHz
ENVIRONMENTAL CONDITIONS	23deg. C, 70%RH	INPUT POWER	AC 120V/60Hz
TESTED BY	Tony Xiong		
ANTENNA POLARITY & TEST DISTANCE: VERTICAL AT 3 M			

	Freq	Level	Read Level	Limit Line	Over Limit	Factor	Remark	Pol/Phase
	MHz	dBm/m	dBm	dBm/m	dB	dB/m		
1	7084.000	-51.97	-65.03	-13.00	-38.97	13.06	Peak	Vertical
2	PP10620.000	-46.67	-65.14	-13.00	-33.67	18.47	Peak	Vertical

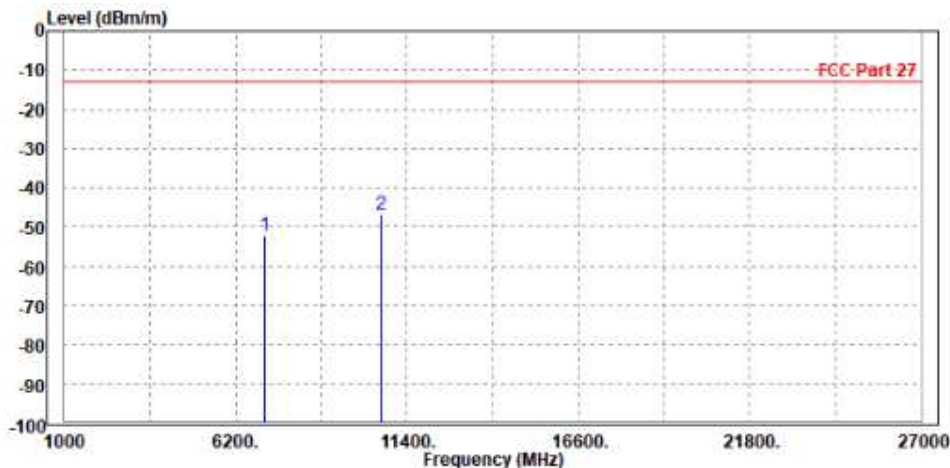



Test Report No.: W7L-P23100014RF07

LTE B66

CHANNEL BANDWIDTH: 1.4MHz / QPSK

MODE	TX channel 132322	FREQUENCY RANGE	Above 1000MHz
ENVIRONMENTAL CONDITIONS	23deg. C, 70%RH	INPUT POWER	AC 120V/60HZ
TESTED BY	Jace Hu		
ANTENNA POLARITY & TEST DISTANCE: HORIZONTAL AT 3 M			

Rg	Frequency [MHz]	PK+ Level [dBm]	PK+ Limit [dBm]	PK+ Margin [dB]	Correction [dB]	Polarization	Azimuth [deg]	Antenna Height [m]
4	3,489.000	-53.23	-13.00	40.23	21.84	H	158.3	2
4	5,233.500	-46.03	-13.00	33.03	26.10	H	215.9	1
5	7,478.500	-39.73	-13.00	26.73	31.72	H	301.8	1

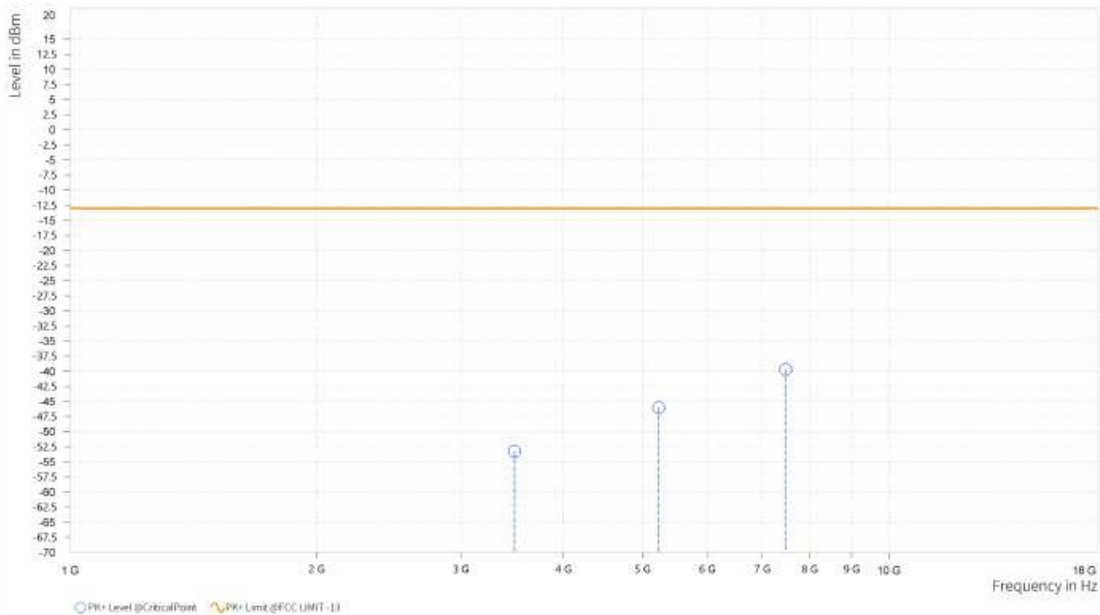



Test Report No.: W7L-P23100014RF07

MODE	TX channel 132322	FREQUENCY RANGE	Above 1000MHz
ENVIRONMENTAL CONDITIONS	23deg. C, 70%RH	INPUT POWER	AC 120V/60HZ
TESTED BY	Jace Hu		
ANTENNA POLARITY & TEST DISTANCE: VERTICAL AT 3 M			

Rg	Frequency [MHz]	PK+ Level [dBm]	PK+ Limit [dBm]	PK+ Margin [dB]	Correction [dB]	Polarization	Azimuth [deg]	Antenna Height [m]
4	3,489.000	-50.43	-13.00	37.43	21.93	V	173.8	2
4	5,234.000	-44.77	-13.00	31.77	25.82	V	173.8	2
5	7,455.000	-38.86	-13.00	25.86	31.72	V	290.1	1

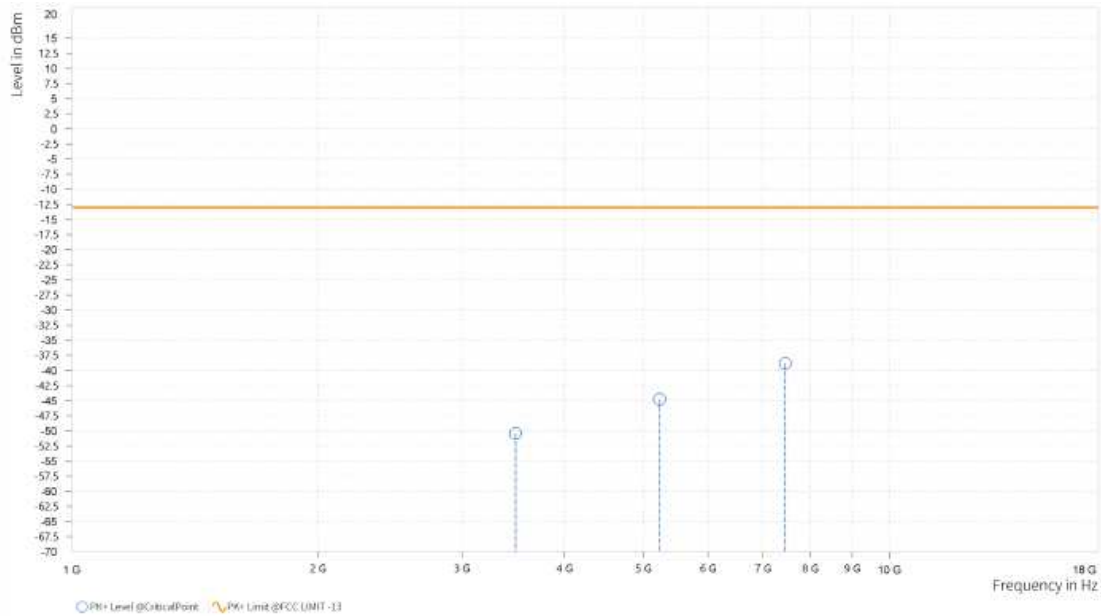



Test Report No.: W7L-P23100014RF07

CHANNEL BANDWIDTH: 3MHz / QPSK

MODE	TX channel 132322	FREQUENCY RANGE	Above 1000MHz
ENVIRONMENTAL CONDITIONS	23deg. C, 70%RH	INPUT POWER	AC 120V/60HZ
TESTED BY	Jace Hu		
ANTENNA POLARITY & TEST DISTANCE: HORIZONTAL AT 3 M			

Rg	Frequency [MHz]	PK+ Level [dBm]	PK+ Limit [dBm]	PK+ Margin [dB]	Correction [dB]	Polarization	Azimuth [deg]	Antenna Height [m]
4	3,487.000	-52.44	-13.00	39.44	21.84	H	1	1
4	5,231.000	-43.87	-13.00	30.87	26.08	H	199.2	1
5	7,485.500	-38.69	-13.00	25.69	31.76	H	0.9	2

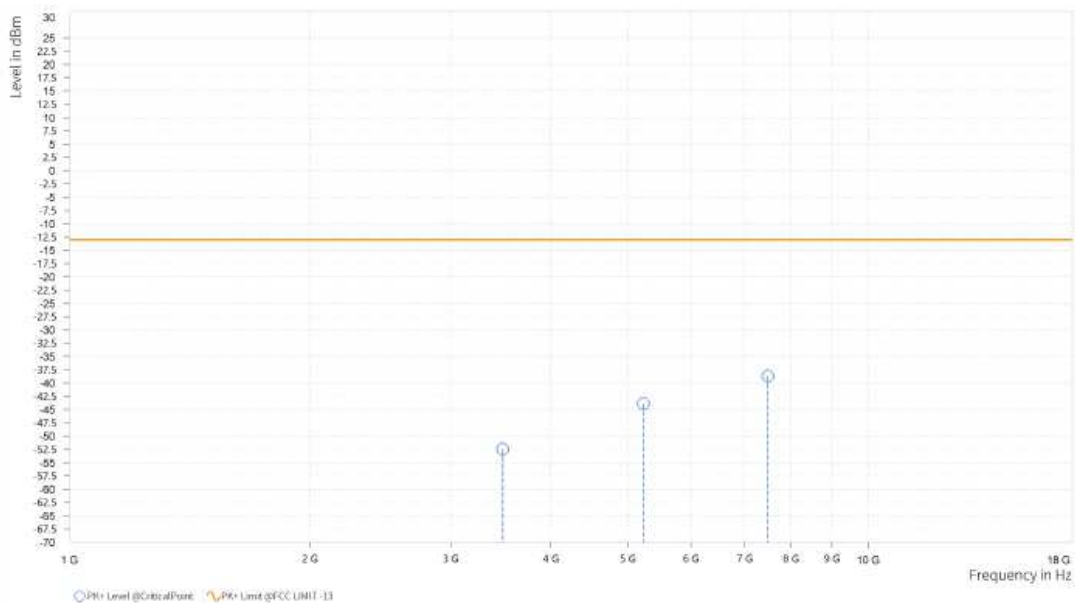



Test Report No.: W7L-P23100014RF07

MODE	TX channel 132322	FREQUENCY RANGE	Above 1000MHz
ENVIRONMENTAL CONDITIONS	23deg. C, 70%RH	INPUT POWER	AC 120V/60HZ
TESTED BY	Jace Hu		
ANTENNA POLARITY & TEST DISTANCE: VERTICAL AT 3 M			

Rg	Frequency [MHz]	PK+ Level [dBm]	PK+ Limit [dBm]	PK+ Margin [dB]	Correction [dB]	Polarization	Azimuth [deg]	Antenna Height [m]
4	3,487.500	-50.64	-13.00	37.64	21.93	V	175.1	2
4	5,231.500	-44.40	-13.00	31.40	25.81	V	175.1	2
5	7,430.500	-39.09	-13.00	26.09	31.74	V	0.9	2

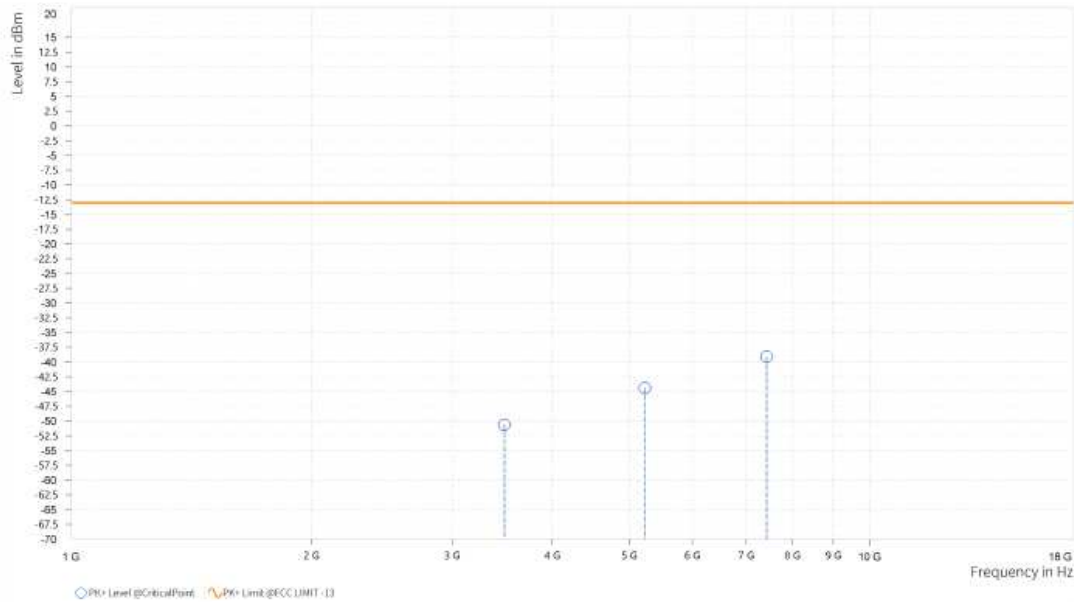



Test Report No.: W7L-P23100014RF07

CHANNEL BANDWIDTH: 5MHz / QPSK

MODE	TX channel 132322	FREQUENCY RANGE	Above 1000MHz
ENVIRONMENTAL CONDITIONS	23deg. C, 70%RH	INPUT POWER	AC 120V/60HZ
TESTED BY	Jace Hu		
ANTENNA POLARITY & TEST DISTANCE: HORIZONTAL AT 3 M			

Rg	Frequency [MHz]	PK+ Level [dBm]	PK+ Limit [dBm]	PK+ Margin [dB]	Correction [dB]	Polarization	Azimuth [deg]	Antenna Height [m]
4	3,485.000	-53.21	-13.00	40.21	21.84	H	1	2
4	5,229.000	-44.40	-13.00	31.40	26.07	H	199.2	1
5	7,502.000	-40.06	-13.00	27.06	31.86	H	1	2

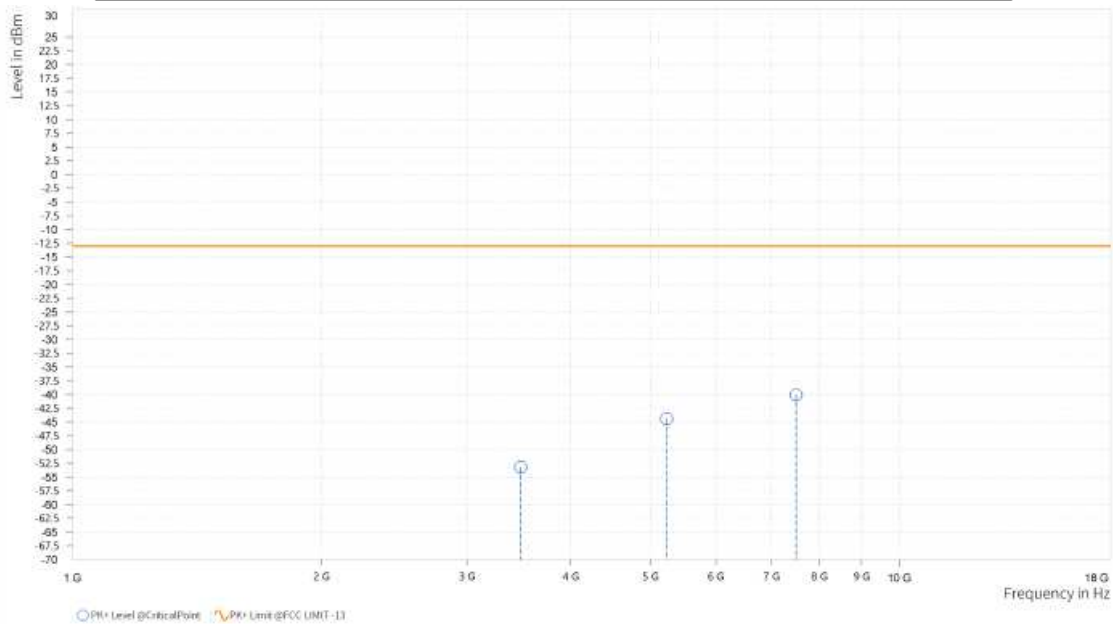



Test Report No.: W7L-P23100014RF07

MODE	TX channel 132322	FREQUENCY RANGE	Above 1000MHz
ENVIRONMENTAL CONDITIONS	23deg. C, 70%RH	INPUT POWER	AC 120V/60HZ
TESTED BY	Jace Hu		
ANTENNA POLARITY & TEST DISTANCE: VERTICAL AT 3 M			

Rg	Frequency [MHz]	PK+ Level [dBm]	PK+ Limit [dBm]	PK+ Margin [dB]	Correction [dB]	Polarization	Azimuth [deg]	Antenna Height [m]
4	3,485.500	-50.17	-13.00	37.17	21.93	V	176.2	2
4	5,228.500	-44.86	-13.00	31.86	25.79	V	176.2	2
5	7,718.000	-39.25	-13.00	26.25	32.96	V	1	1

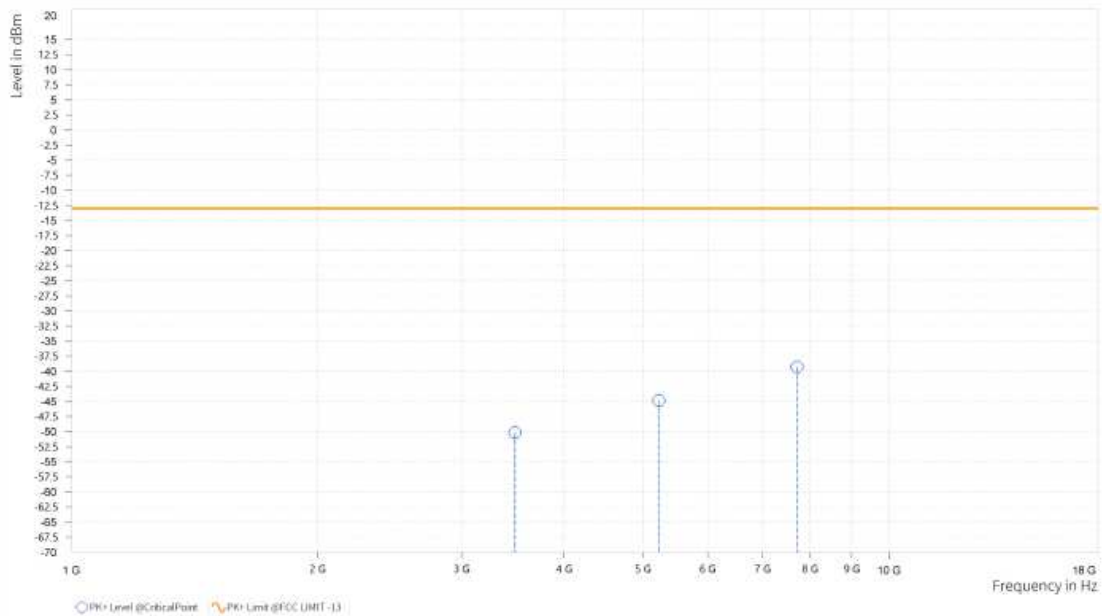



Test Report No.: W7L-P23100014RF07

CHANNEL BANDWIDTH: 10MHz / QPSK

CH132022

MODE	TX channel 132022	FREQUENCY RANGE	Above 1000MHz
ENVIRONMENTAL CONDITIONS	23deg. C, 70%RH	INPUT POWER	AC 120V/60HZ
TESTED BY	Jace Hu		
ANTENNA POLARITY & TEST DISTANCE: HORIZONTAL AT 3 M			

Rg	Frequency [MHz]	PK+ Level [dBm]	PK+ Limit [dBm]	PK+ Margin [dB]	Correction [dB]	Polarization	Azimuth [deg]	Antenna Height [m]
4	3,420.500	-52.40	-13.00	39.40	21.94	H	0.9	2
4	5,132.000	-47.49	-13.00	34.49	26.20	H	196.9	1
5	7,426.500	-39.78	-13.00	26.78	31.59	H	1	1

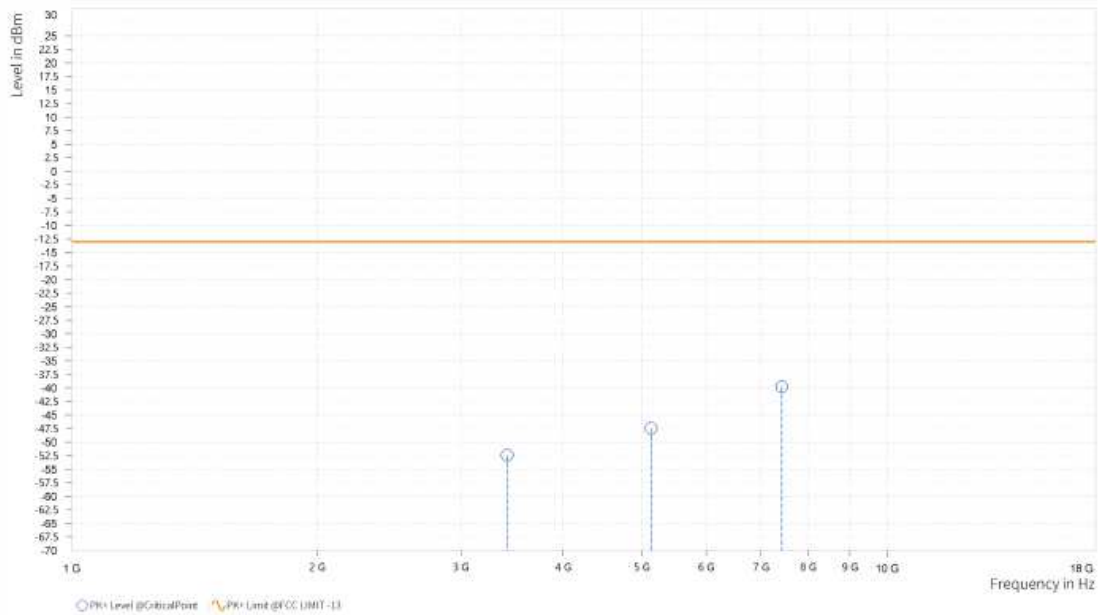



Test Report No.: W7L-P23100014RF07

MODE	TX channel 132022	FREQUENCY RANGE	Above 1000MHz
ENVIRONMENTAL CONDITIONS	23deg. C, 70%RH	INPUT POWER	AC 120V/60HZ
TESTED BY	Jace Hu		
ANTENNA POLARITY & TEST DISTANCE: VERTICAL AT 3 M			

Rg	Frequency [MHz]	PK+ Level [dBm]	PK+ Limit [dBm]	PK+ Margin [dB]	Correction [dB]	Polarization	Azimuth [deg]	Antenna Height [m]
4	3,421.500	-52.66	-13.00	39.66	22.01	V	184.7	1
4	5,132.000	-43.97	-13.00	30.97	26.21	V	173.8	2
5	7,752.000	-39.20	-13.00	26.20	33.03	V	270.9	1

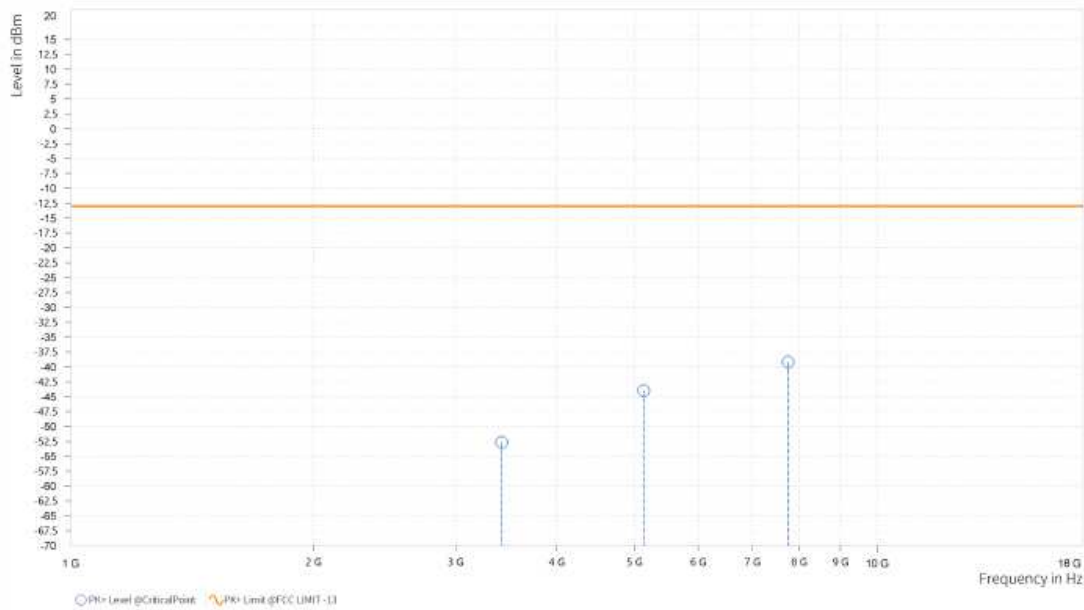



Test Report No.: W7L-P23100014RF07

CH132322

MODE	TX channel 132322	FREQUENCY RANGE	Above 1000MHz
ENVIRONMENTAL CONDITIONS	23deg. C, 70%RH	INPUT POWER	AC 120V/60HZ
TESTED BY	Jace Hu		
ANTENNA POLARITY & TEST DISTANCE: HORIZONTAL AT 3 M			

Rg	Frequency [MHz]	PK+ Level [dBm]	PK+ Limit [dBm]	PK+ Margin [dB]	Correction [dB]	Polarization	Azimuth [deg]	Antenna Height [m]
4	3,482.500	-52.06	-13.00	39.06	21.85	H	198	1
4	5,221.500	-44.40	-13.00	31.40	26.03	H	159.6	2
5	7,490.500	-38.52	-13.00	25.52	31.79	H	1	2

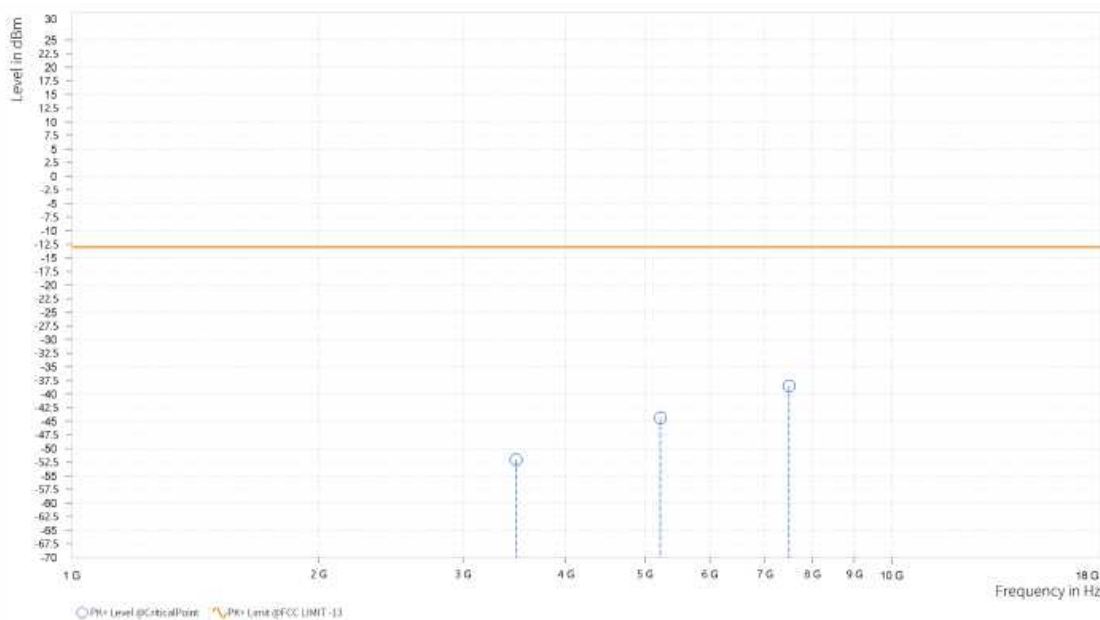



Test Report No.: W7L-P23100014RF07

MODE	TX channel 132322	FREQUENCY RANGE	Above 1000MHz
ENVIRONMENTAL CONDITIONS	23deg. C, 70%RH	INPUT POWER	AC 120V/60HZ
TESTED BY	Jace Hu		
ANTENNA POLARITY & TEST DISTANCE: VERTICAL AT 3 M			

Rg	Frequency [MHz]	PK+ Level [dBm]	PK+ Limit [dBm]	PK+ Margin [dB]	Correction [dB]	Polarization	Azimuth [deg]	Antenna Height [m]
4	3,480.500	-50.80	-13.00	37.80	21.92	V	175.1	2
4	5,221.500	-44.48	-13.00	31.48	25.74	V	175.1	2
5	7,727.500	-38.97	-13.00	25.97	33.00	V	1	1

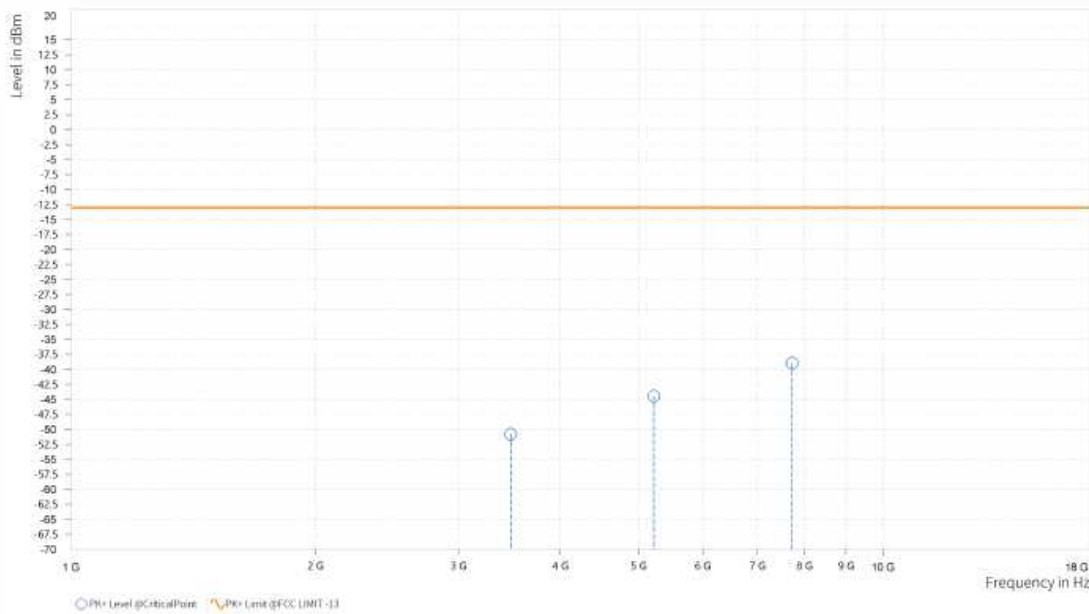



Test Report No.: W7L-P23100014RF07

CH132622

MODE	TX channel 132622	FREQUENCY RANGE	Above 1000MHz
ENVIRONMENTAL CONDITIONS	23deg. C, 70%RH	INPUT POWER	AC 120V/60HZ
TESTED BY	Jace Hu		
ANTENNA POLARITY & TEST DISTANCE: HORIZONTAL AT 3 M			

Rg	Frequency [MHz]	PK+ Level [dBm]	PK+ Limit [dBm]	PK+ Margin [dB]	Correction [dB]	Polarization	Azimuth [deg]	Antenna Height [m]
4	3,541.000	-52.08	-13.00	39.08	21.86	H	359	1
4	5,312.000	-42.23	-13.00	29.23	27.21	H	199.2	1
5	7,448.000	-39.56	-13.00	26.56	31.61	H	74.7	2

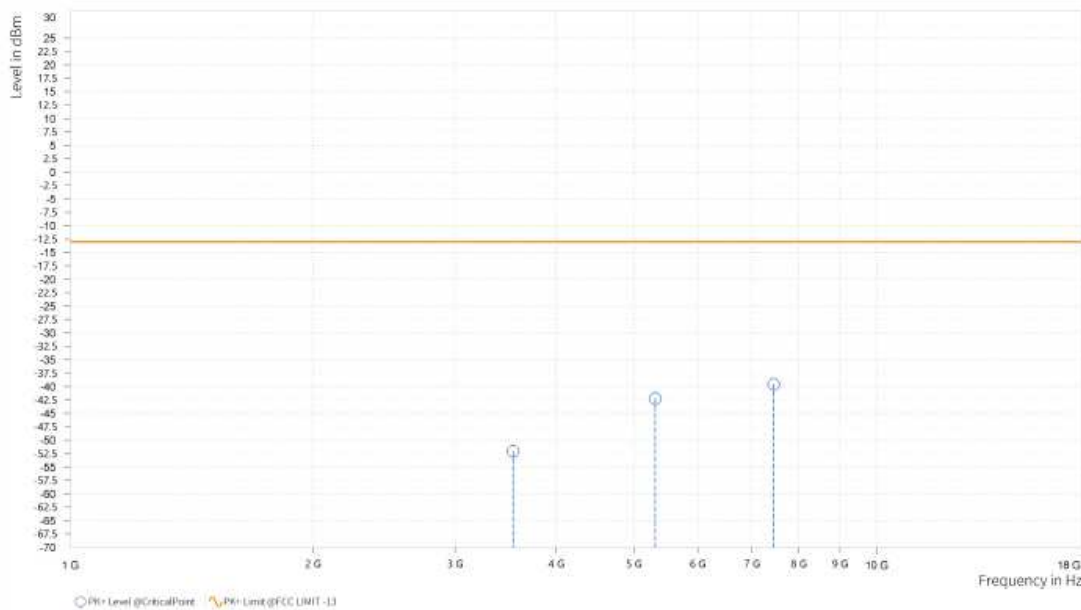



Test Report No.: W7L-P23100014RF07

MODE	TX channel 132622	FREQUENCY RANGE	Above 1000MHz
ENVIRONMENTAL CONDITIONS	23deg. C, 70%RH	INPUT POWER	AC 120V/60HZ
TESTED BY	Jace Hu		
ANTENNA POLARITY & TEST DISTANCE: VERTICAL AT 3 M			

Rg	Frequency [MHz]	PK+ Level [dBm]	PK+ Limit [dBm]	PK+ Margin [dB]	Correction [dB]	Polarization	Azimuth [deg]	Antenna Height [m]
4	3,541.000	-49.40	-13.00	36.40	22.03	V	173.9	2
4	5,312.000	-44.02	-13.00	31.02	26.60	V	184.7	1
5	7,716.500	-39.10	-13.00	26.10	32.96	V	359.1	1

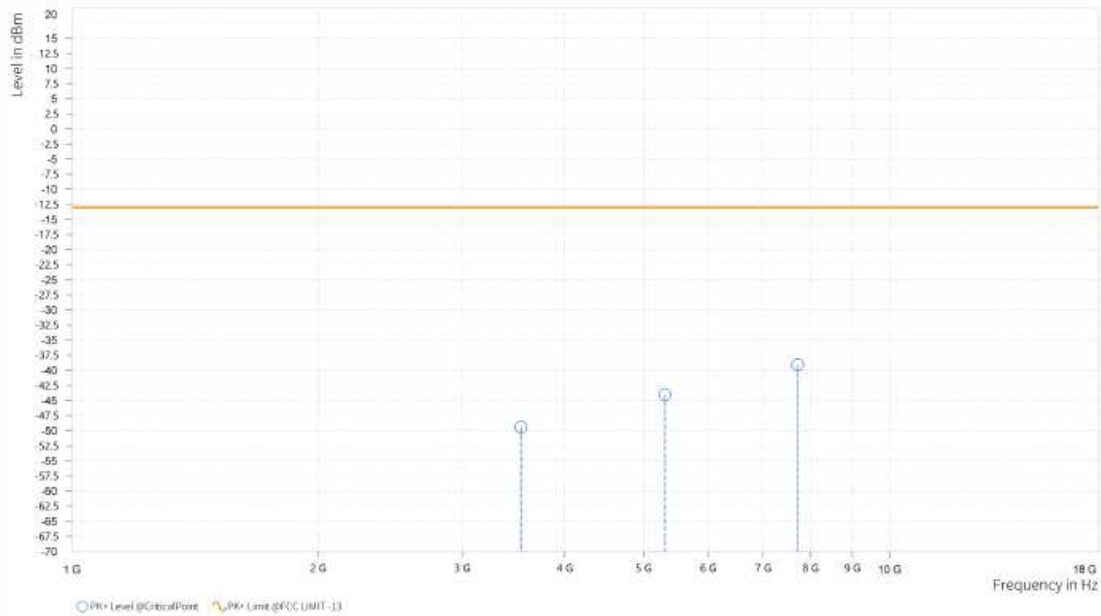



Test Report No.: W7L-P23100014RF07

CHANNEL BANDWIDTH: 15MHz / QPSK

MODE	TX channel 132322	FREQUENCY RANGE	Above 1000MHz
ENVIRONMENTAL CONDITIONS	23deg. C, 70%RH	INPUT POWER	AC 120V/60HZ
TESTED BY	Jace Hu		
ANTENNA POLARITY & TEST DISTANCE: HORIZONTAL AT 3 M			

Rg	Frequency [MHz]	PK+ Level [dBm]	PK+ Limit [dBm]	PK+ Margin [dB]	Correction [dB]	Polarization	Azimuth [deg]	Antenna Height [m]
4	3,477.000	-53.49	-13.00	40.49	21.85	H	205.1	1
4	5,215.000	-46.39	-13.00	33.39	25.99	H	205.1	1
5	7,782.000	-38.96	-13.00	25.96	32.87	H	291.2	1

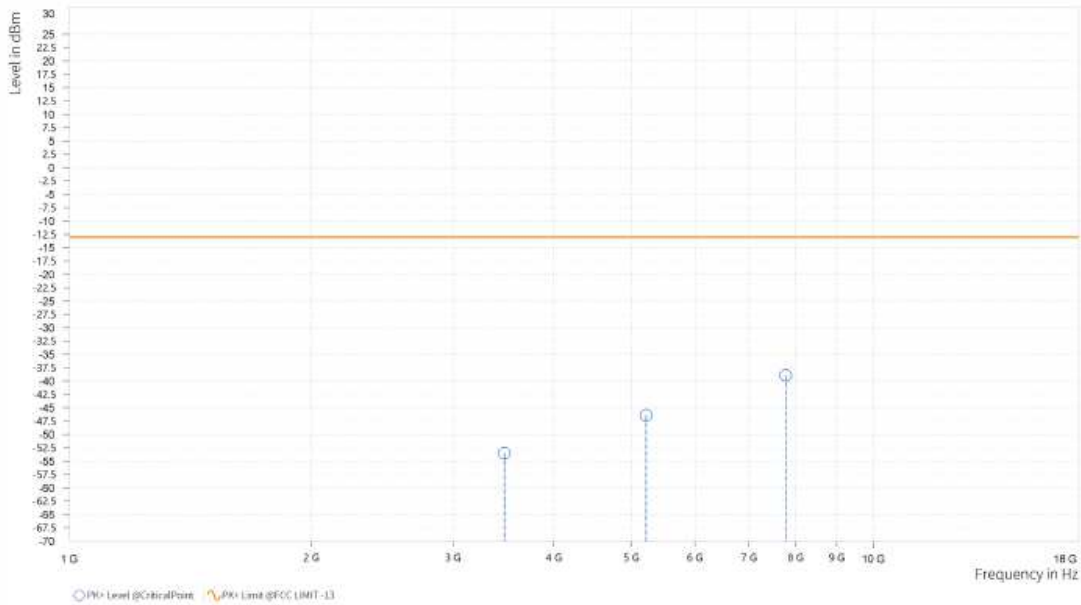



Test Report No.: W7L-P23100014RF07

MODE	TX channel 132322	FREQUENCY RANGE	Above 1000MHz
ENVIRONMENTAL CONDITIONS	23deg. C, 70%RH	INPUT POWER	AC 120V/60HZ
TESTED BY	Jace Hu		
ANTENNA POLARITY & TEST DISTANCE: VERTICAL AT 3 M			

Rg	Frequency [MHz]	PK+ Level [dBm]	PK+ Limit [dBm]	PK+ Margin [dB]	Correction [dB]	Polarization	Azimuth [deg]	Antenna Height [m]
4	3,476.500	-51.42	-13.00	38.42	21.92	V	175.1	2
4	5,215.000	-46.65	-13.00	33.65	25.70	V	175.1	2
5	7,733.000	-38.70	-13.00	25.70	33.02	V	87.8	2

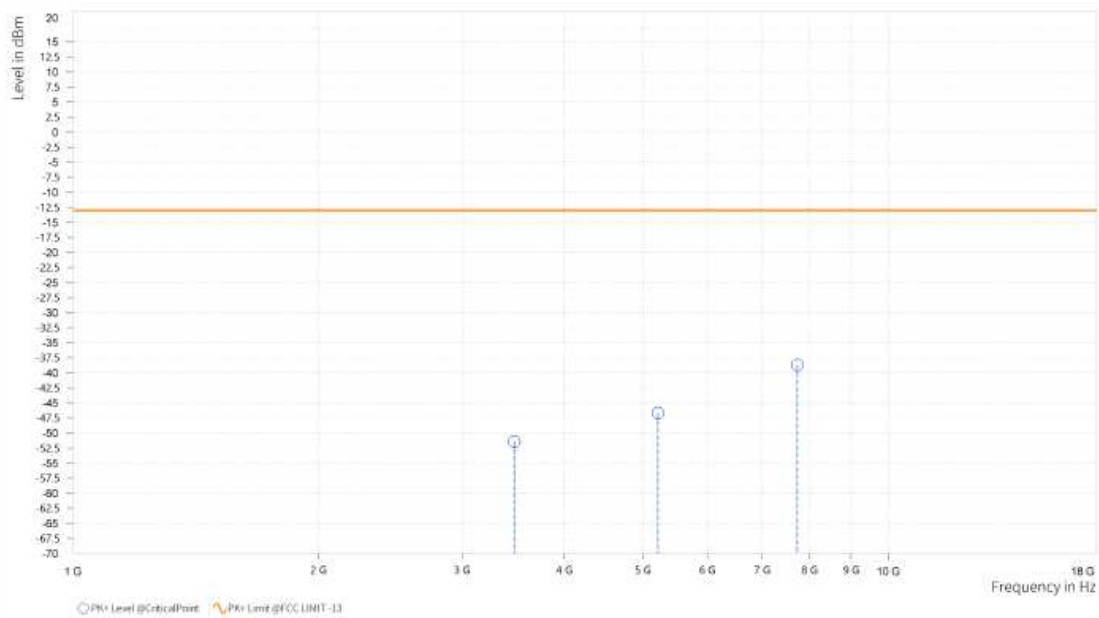



Test Report No.: W7L-P23100014RF07

CHANNEL BANDWIDTH: 20MHz / QPSK

MODE	TX channel 132322	FREQUENCY RANGE	Above 1000MHz
ENVIRONMENTAL CONDITIONS	23deg. C, 70%RH	INPUT POWER	AC 120V/60HZ
TESTED BY	Jace Hu		
ANTENNA POLARITY & TEST DISTANCE: HORIZONTAL AT 3 M			

Rg	Frequency [MHz]	PK+ Level [dBm]	PK+ Limit [dBm]	PK+ Margin [dB]	Correction [dB]	Polarization	Azimuth [deg]	Antenna Height [m]
4	3,471.500	-52.21	-13.00	39.21	21.85	H	151.2	2
4	5,208.500	-46.97	-13.00	33.97	26.00	H	198	1
5	7,496.500	-39.42	-13.00	26.42	31.83	H	49.6	2

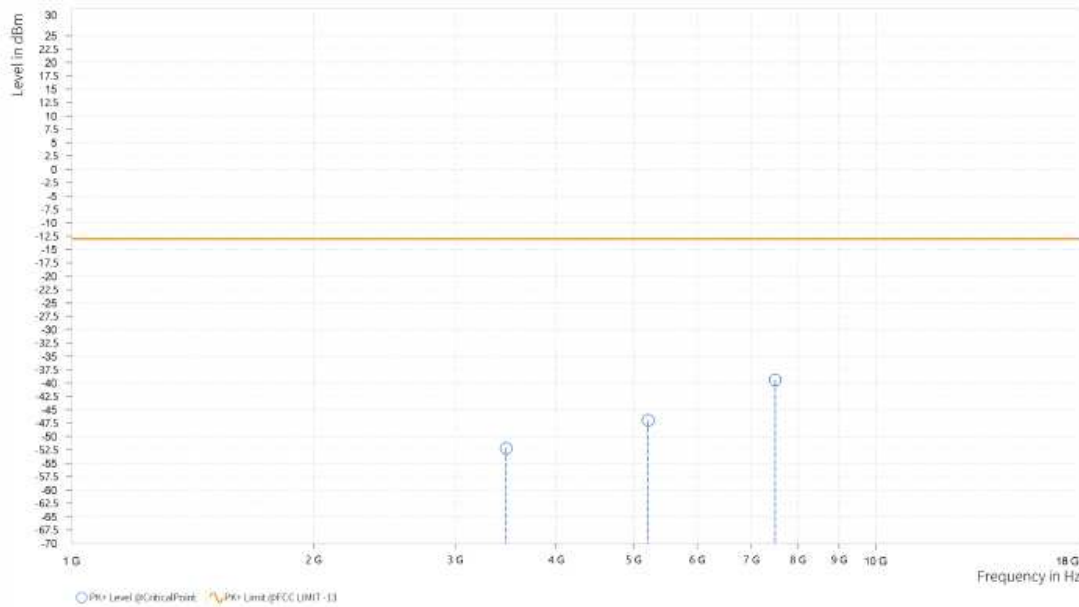



Test Report No.: W7L-P23100014RF07

MODE	TX channel 132322	FREQUENCY RANGE	Above 1000MHz
ENVIRONMENTAL CONDITIONS	23deg. C, 70%RH	INPUT POWER	AC 120V/60HZ
TESTED BY	Jace Hu		
ANTENNA POLARITY & TEST DISTANCE: VERTICAL AT 3 M			

Rg	Frequency [MHz]	PK+ Level [dBm]	PK+ Limit [dBm]	PK+ Margin [dB]	Correction [dB]	Polarization	Azimuth [deg]	Antenna Height [m]
4	3,472.000	-52.09	-13.00	39.09	21.91	V	177.4	2
4	5,208.500	-46.86	-13.00	33.86	25.70	V	177.4	2
5	7,991.000	-39.45	-13.00	26.45	33.33	V	87.8	2

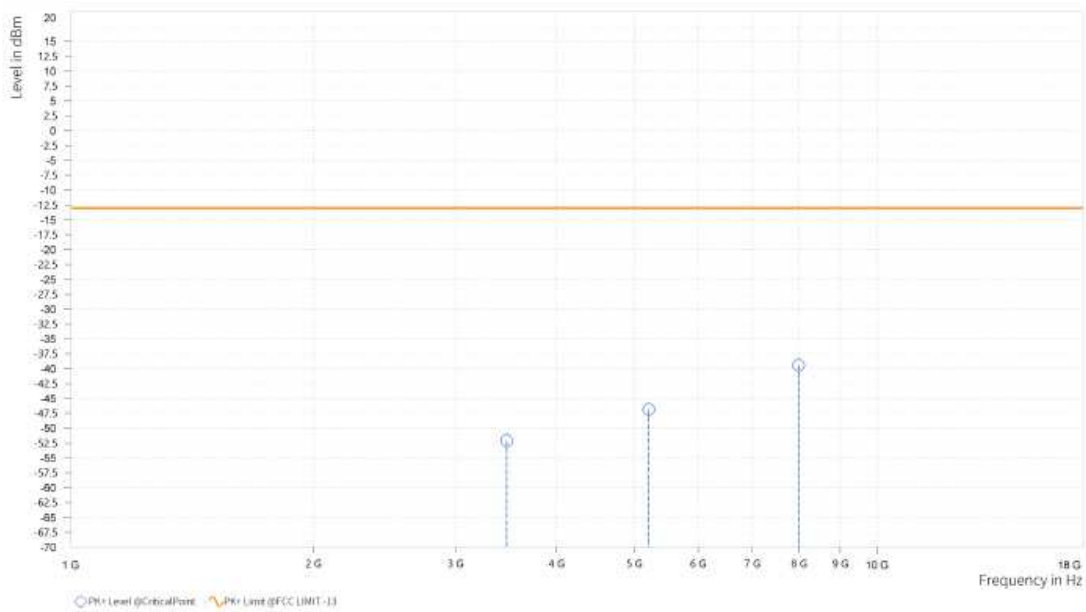

3.7 PEAK TO AVERAGE RATIO

3.7.1 LIMITS OF PEAK TO AVERAGE RATIO MEASUREMENT

In measuring transmissions in this band using an average power technique, the peak to-average ratio (PAR) of the transmission may not exceed 13 dB

3.7.2 TEST SETUP

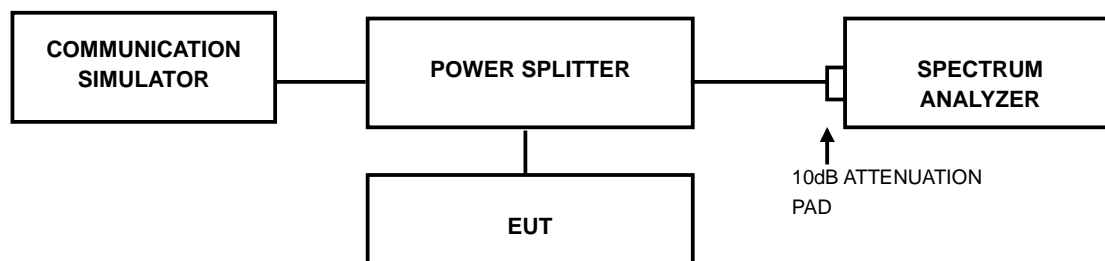

3.7.3 TEST PROCEDURES

1. Set resolution/measurement bandwidth \geq signal's occupied bandwidth;
2. Set the number of counts to a value that stabilizes the measured CCDF curve;
3. Record the maximum PAPR level associated with a probability of 0.1%.



Test Report No.: W7L-P23100014RF07

3.7.4 TEST RESULTS

Please Refer to Appendix Of this test report.



Test Report No.: W7L-P23100014RF07

4 INFORMATION ON THE TESTING LABORATORIES

We, BV 7LAYERS COMMUNICATIONS TECHNOLOGY (SHENZHEN) CO. LTD., were founded in 2015 to provide our best service in EMC, Radio, Telecom and Safety consultation. Our laboratories are accredited and approved according to ISO/IEC 17025.

If you have any comments, please feel free to contact us at the following:

Shenzhen EMC/RF Lab:

Tel: +86-755-88696566

Fax: +86-755-88696577

Email: customerservice.sw@cn.bureauveritas.com

Web Site: www.adt.com.tw

The address and road map of all our labs can be found in our web site also.



Test Report No.: W7L-P23100014RF07

5 MODIFICATIONS RECORDERS FOR ENGINEERING CHANGES TO THE EUT BY THE LAB

No any modifications are made to the EUT by the lab during the test.



6 APPENDIX

LTE BAND41 (INDCLUDING LTE BAND38)

PEAK-TO-AVERAGE RATIO(CCDF)

Test Result

Band	Bandwidth	Modulation	Channel	RB Configuration	Result(dB)	Limit(dB)	Verdict
Band41	5MHz	QPSK	39675	1RB#0	3.73	13	PASS
Band41	5MHz	QPSK	39675	25RB#0	5.04	13	PASS
Band41	5MHz	QPSK	40620	1RB#0	4.07	13	PASS
Band41	5MHz	QPSK	40620	25RB#0	5.80	13	PASS
Band41	5MHz	QPSK	41565	1RB#0	4.19	13	PASS
Band41	5MHz	QPSK	41565	25RB#0	5.40	13	PASS
Band41	5MHz	16QAM	39675	1RB#0	5.45	13	PASS
Band41	5MHz	16QAM	39675	25RB#0	5.77	13	PASS
Band41	5MHz	16QAM	40620	1RB#0	5.91	13	PASS
Band41	5MHz	16QAM	40620	25RB#0	5.90	13	PASS
Band41	5MHz	16QAM	41565	1RB#0	5.34	13	PASS
Band41	5MHz	16QAM	41565	25RB#0	6.64	13	PASS
Band41	5MHz	64QAM	39675	1RB#0	6.40	13	PASS
Band41	5MHz	64QAM	39675	25RB#0	6.60	13	PASS
Band41	5MHz	64QAM	40620	1RB#0	6.73	13	PASS
Band41	5MHz	64QAM	40620	25RB#0	7.06	13	PASS
Band41	5MHz	64QAM	41565	1RB#0	6.97	13	PASS
Band41	5MHz	64QAM	41565	25RB#0	7.25	13	PASS
Band41	10MHz	QPSK	39700	1RB#0	4.25	13	PASS
Band41	10MHz	QPSK	39700	50RB#0	4.90	13	PASS
Band41	10MHz	QPSK	40620	1RB#0	3.82	13	PASS
Band41	10MHz	QPSK	40620	50RB#0	5.15	13	PASS
Band41	10MHz	QPSK	41540	1RB#0	3.81	13	PASS
Band41	10MHz	QPSK	41540	50RB#0	5.02	13	PASS
Band41	10MHz	16QAM	39700	1RB#0	5.43	13	PASS
Band41	10MHz	16QAM	39700	50RB#0	5.87	13	PASS
Band41	10MHz	16QAM	40620	1RB#0	5.73	13	PASS
Band41	10MHz	16QAM	40620	50RB#0	5.98	13	PASS
Band41	10MHz	16QAM	41540	1RB#0	5.85	13	PASS
Band41	10MHz	16QAM	41540	50RB#0	5.88	13	PASS
Band41	10MHz	64QAM	39700	1RB#0	6.79	13	PASS
Band41	10MHz	64QAM	39700	50RB#0	7.28	13	PASS
Band41	10MHz	64QAM	40620	1RB#0	7.36	13	PASS
Band41	10MHz	64QAM	40620	50RB#0	7.29	13	PASS
Band41	10MHz	64QAM	41540	1RB#0	6.94	13	PASS
Band41	10MHz	64QAM	41540	50RB#0	7.30	13	PASS
Band41	15MHz	QPSK	39725	1RB#0	3.82	13	PASS
Band41	15MHz	QPSK	39725	75RB#0	5.22	13	PASS
Band41	15MHz	QPSK	40620	1RB#0	3.93	13	PASS
Band41	15MHz	QPSK	40620	75RB#0	5.42	13	PASS
Band41	15MHz	QPSK	41515	1RB#0	4.37	13	PASS
Band41	15MHz	QPSK	41515	75RB#0	5.32	13	PASS



BUREAU
VERITAS

Test Report No.: W7L-P23100014RF07

Band41	15MHz	16QAM	39725	1RB#0	5.32	13	PASS
Band41	15MHz	16QAM	39725	75RB#0	5.96	13	PASS
Band41	15MHz	16QAM	40620	1RB#0	5.69	13	PASS
Band41	15MHz	16QAM	40620	75RB#0	6.11	13	PASS
Band41	15MHz	16QAM	41515	1RB#0	5.89	13	PASS
Band41	15MHz	16QAM	41515	75RB#0	6.05	13	PASS
Band41	15MHz	64QAM	39725	1RB#0	6.79	13	PASS
Band41	15MHz	64QAM	39725	75RB#0	6.55	13	PASS
Band41	15MHz	64QAM	40620	1RB#0	7.31	13	PASS
Band41	15MHz	64QAM	40620	75RB#0	6.64	13	PASS
Band41	15MHz	64QAM	41515	1RB#0	6.79	13	PASS
Band41	15MHz	64QAM	41515	75RB#0	6.58	13	PASS
Band41	20MHz	QPSK	39750	1RB#0	3.84	13	PASS
Band41	20MHz	QPSK	39750	100RB#0	5.10	13	PASS
Band41	20MHz	QPSK	40620	1RB#0	3.74	13	PASS
Band41	20MHz	QPSK	40620	100RB#0	5.23	13	PASS
Band41	20MHz	QPSK	41490	1RB#0	3.65	13	PASS
Band41	20MHz	QPSK	41490	100RB#0	5.22	13	PASS
Band41	20MHz	16QAM	39750	1RB#0	4.90	13	PASS
Band41	20MHz	16QAM	39750	100RB#0	5.89	13	PASS
Band41	20MHz	16QAM	40620	1RB#0	5.64	13	PASS
Band41	20MHz	16QAM	40620	100RB#0	6.02	13	PASS
Band41	20MHz	16QAM	41490	1RB#0	5.68	13	PASS
Band41	20MHz	16QAM	41490	100RB#0	5.99	13	PASS
Band41	20MHz	64QAM	39750	1RB#0	6.98	13	PASS
Band41	20MHz	64QAM	39750	100RB#0	6.60	13	PASS
Band41	20MHz	64QAM	40620	1RB#0	7.03	13	PASS
Band41	20MHz	64QAM	40620	100RB#0	6.61	13	PASS
Band41	20MHz	64QAM	41490	1RB#0	7.87	13	PASS
Band41	20MHz	64QAM	41490	100RB#0	6.67	13	PASS

Test Graphs

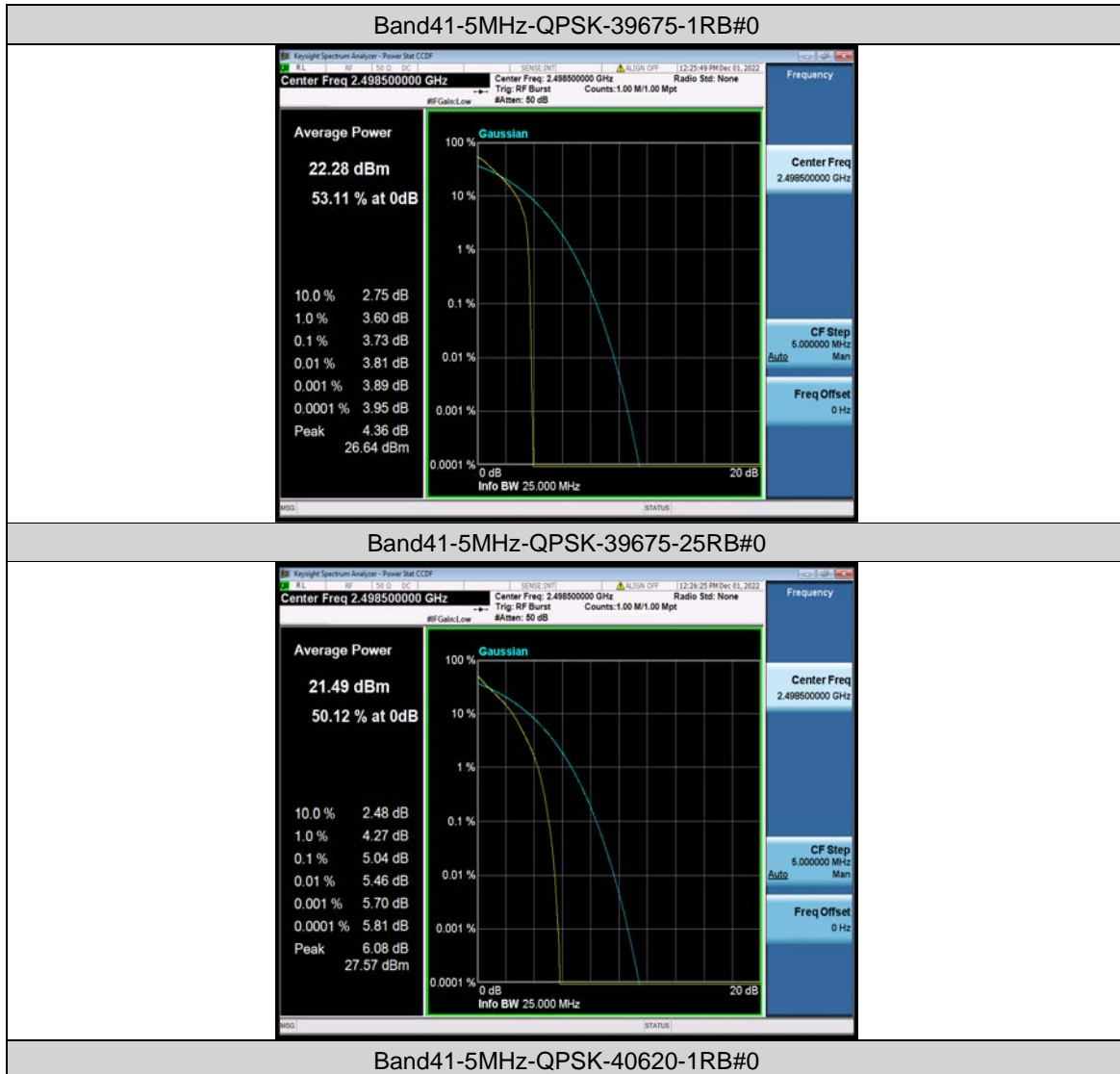



Test Report No.: W7L-P23100014RF07





Test Report No.: W7L-P23100014RF07



Band41-5MHz-16QAM-39675-1RB#0

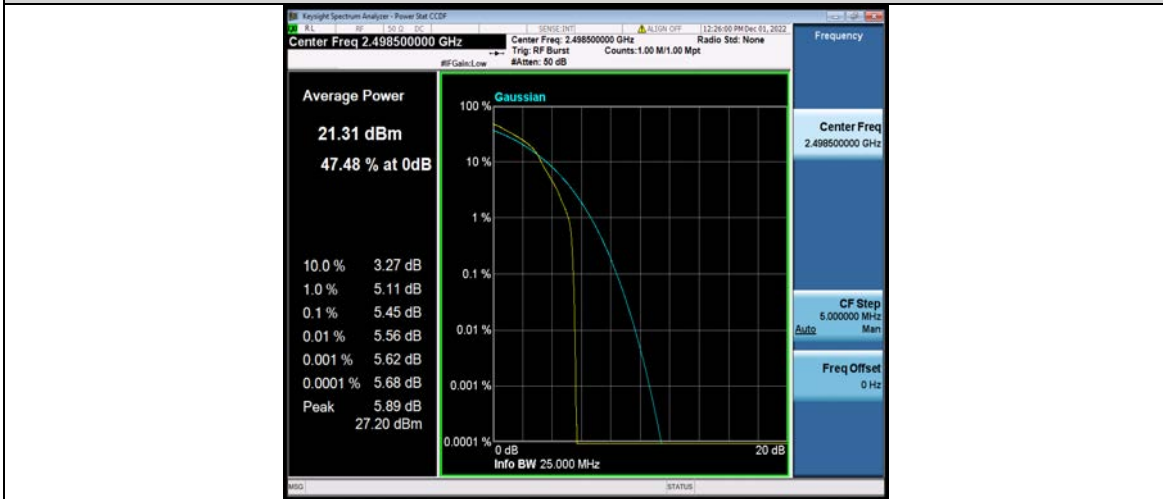

Band41-5MHz-16QAM-39675-25RB#0



Band41-5MHz-16QAM-40620-1RB#0



Test Report No.: W7L-P23100014RF07

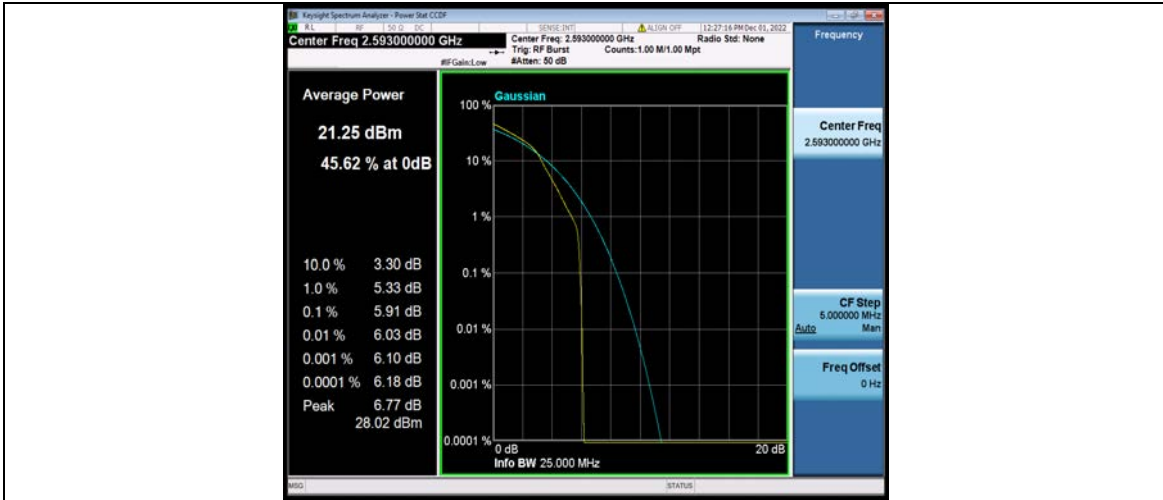

Band41-5MHz-16QAM-40620-25RB#0

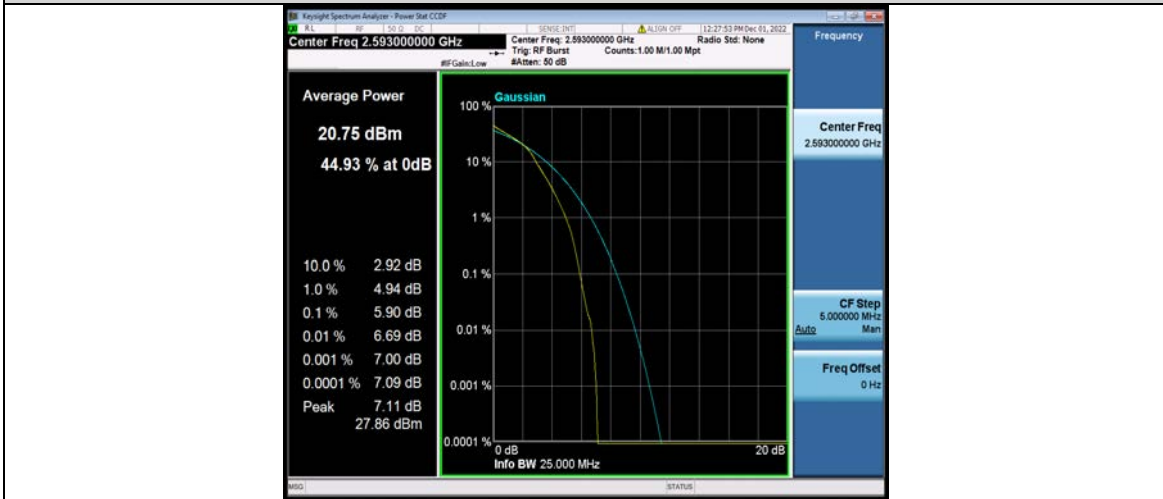

Band41-5MHz-16QAM-41565-1RB#0



Band41-5MHz-16QAM-41565-25RB#0



Test Report No.: W7L-P23100014RF07

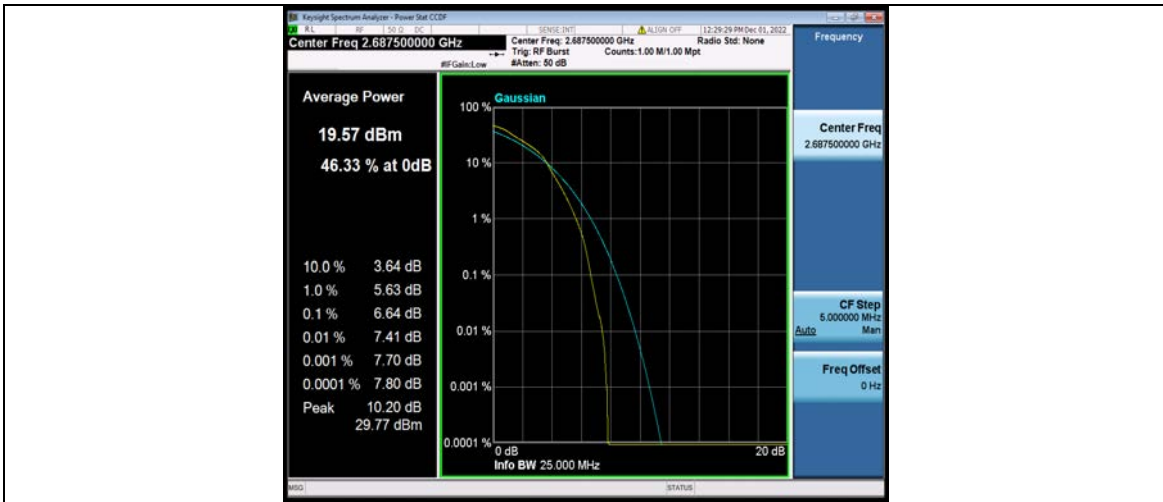

Band41-5MHz-64QAM-39675-1RB#0

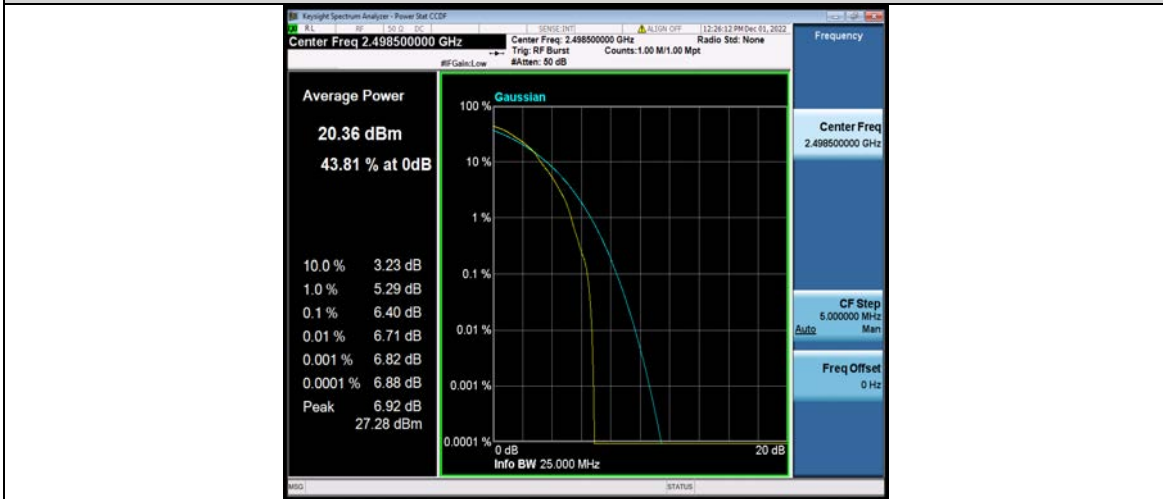

Band41-5MHz-64QAM-39675-25RB#0



Band41-5MHz-64QAM-40620-1RB#0



Test Report No.: W7L-P23100014RF07



Band41-5MHz-64QAM-40620-25RB#0

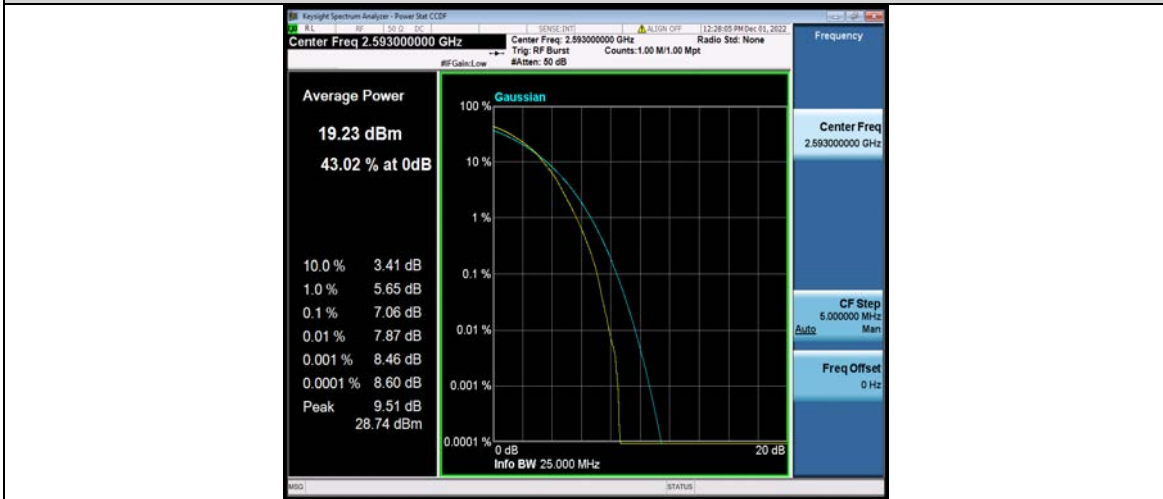

Band41-5MHz-64QAM-41565-1RB#0



Band41-5MHz-64QAM-41565-25RB#0



Test Report No.: W7L-P23100014RF07

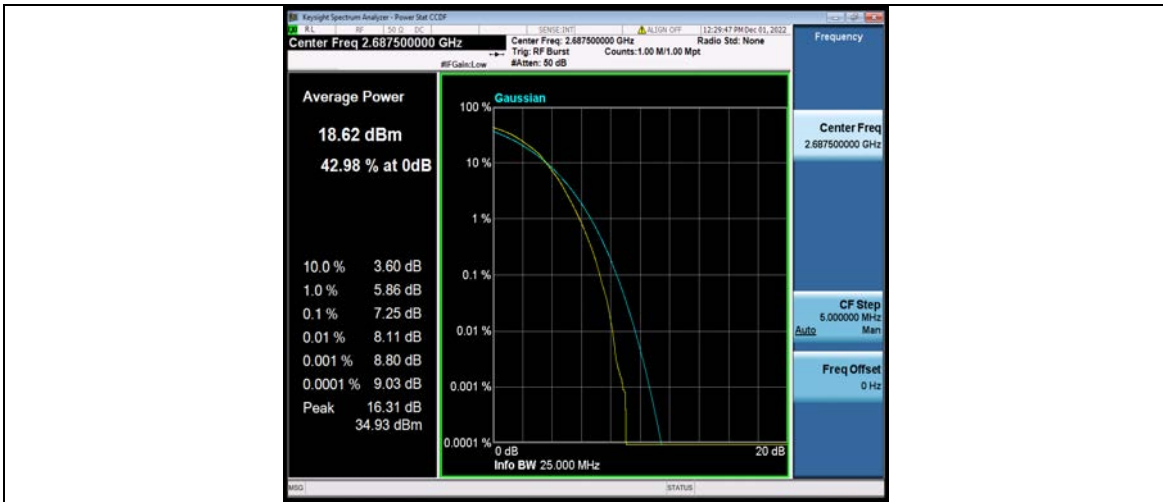

Band41-10MHz-QPSK-39700-1RB#0

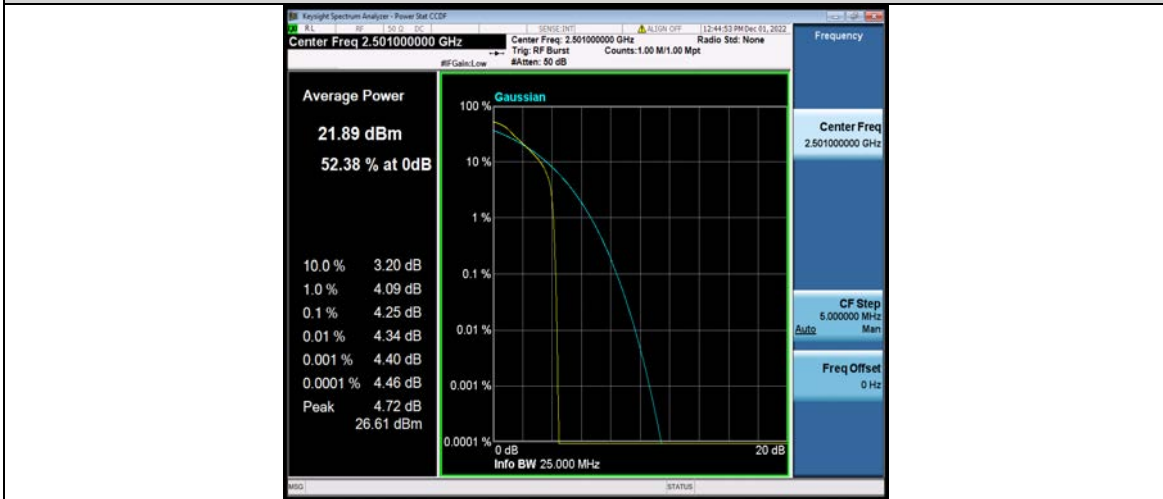

Band41-10MHz-QPSK-39700-50RB#0



Band41-10MHz-QPSK-40620-1RB#0



Test Report No.: W7L-P23100014RF07



Band41-10MHz-QPSK-40620-50RB#0

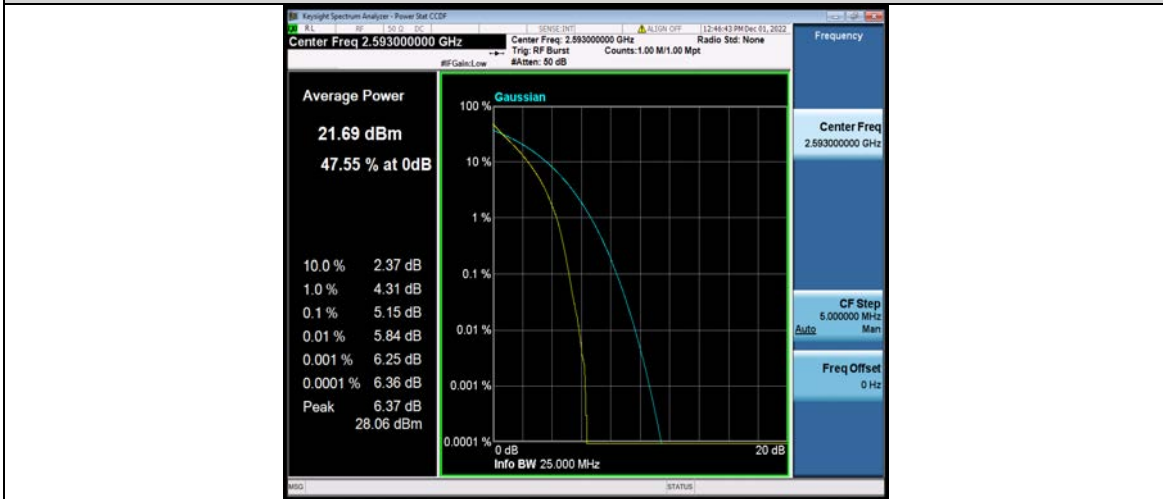

Band41-10MHz-QPSK-41540-1RB#0



Band41-10MHz-QPSK-41540-50RB#0



Test Report No.: W7L-P23100014RF07

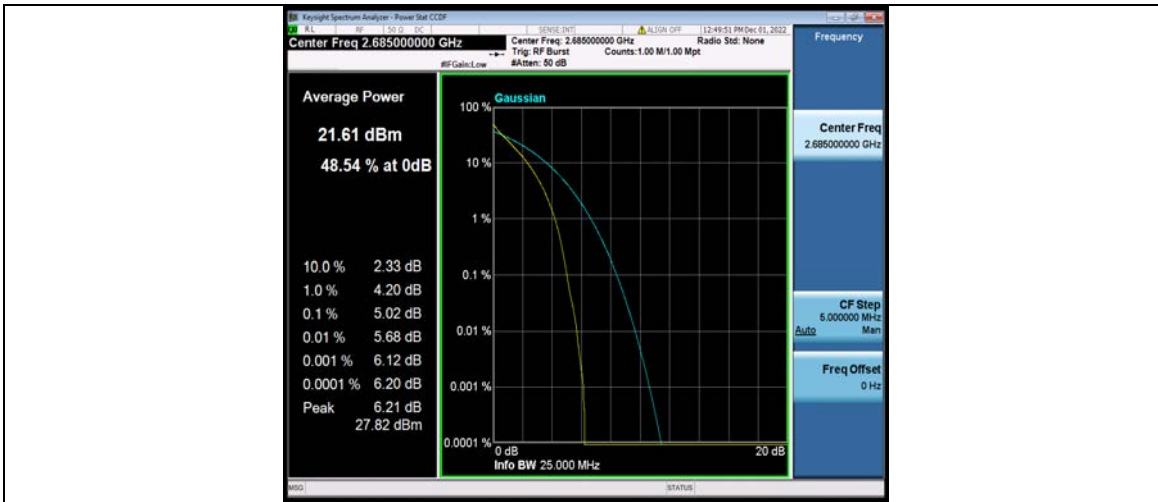

Band41-10MHz-16QAM-39700-1RB#0



Band41-10MHz-16QAM-39700-50RB#0



Band41-10MHz-16QAM-40620-1RB#0



Test Report No.: W7L-P23100014RF07

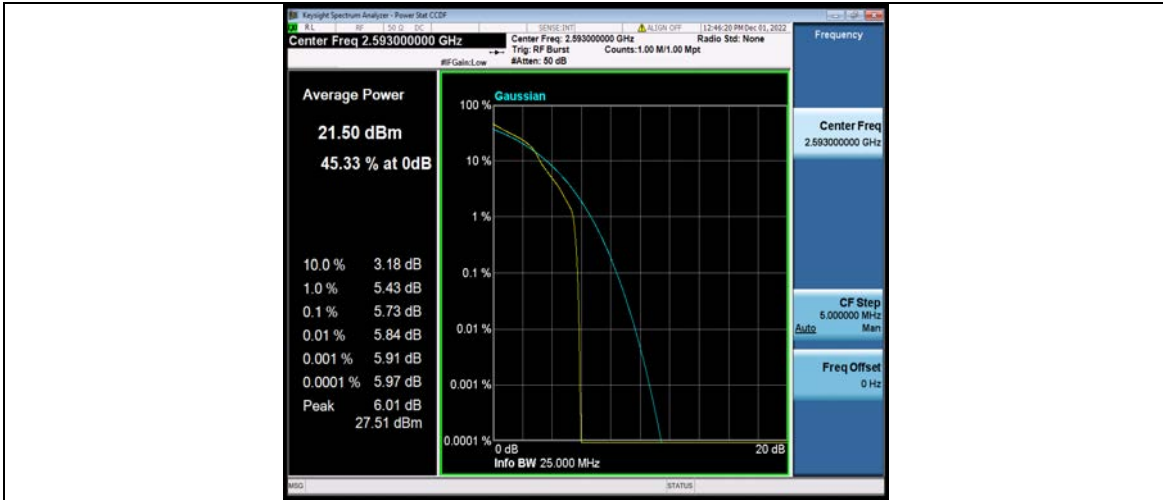

Band41-10MHz-16QAM-40620-50RB#0

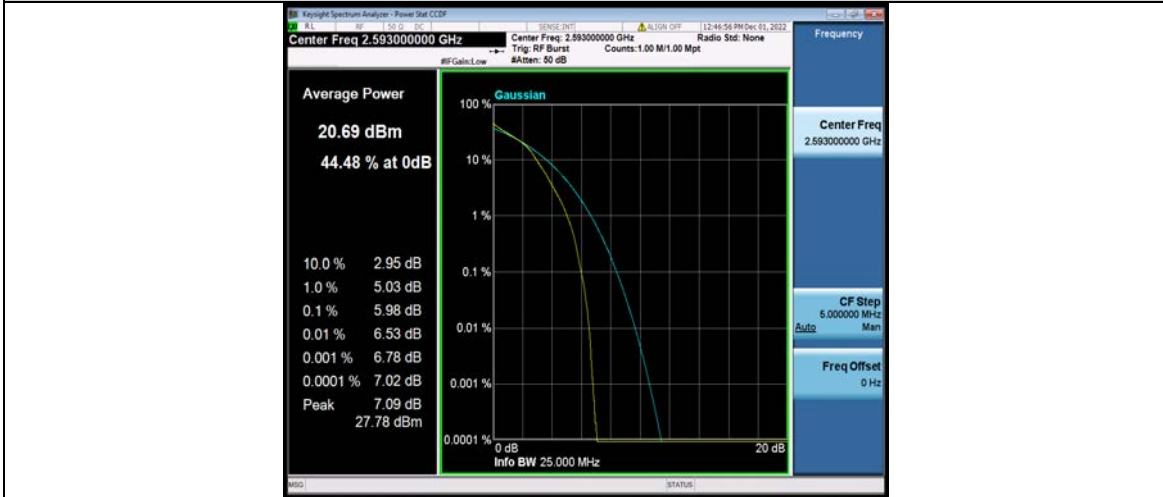

Band41-10MHz-16QAM-41540-1RB#0

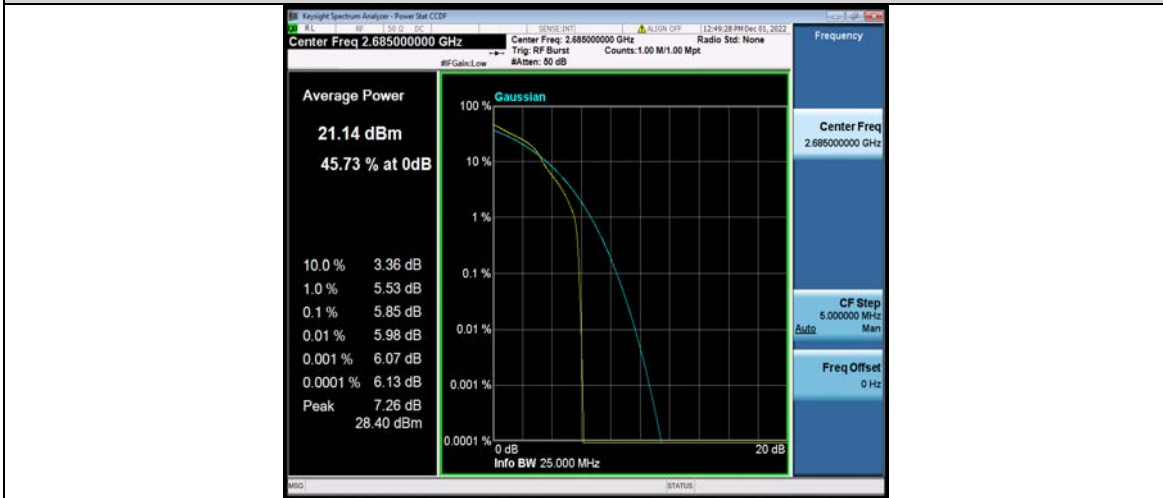

Band41-10MHz-16QAM-41540-50RB#0



Test Report No.: W7L-P23100014RF07

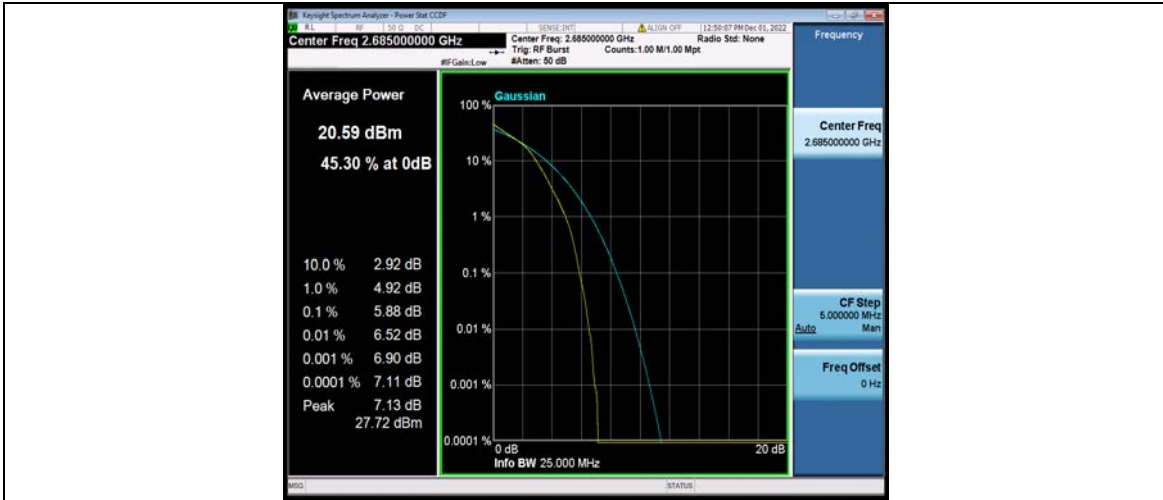

Band41-10MHz-64QAM-39700-1RB#0

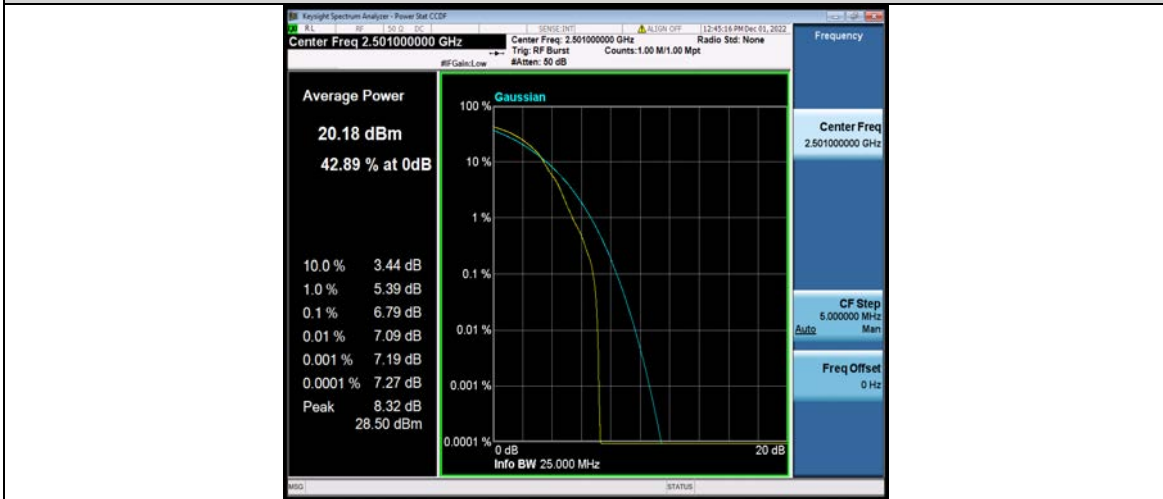

Band41-10MHz-64QAM-39700-50RB#0

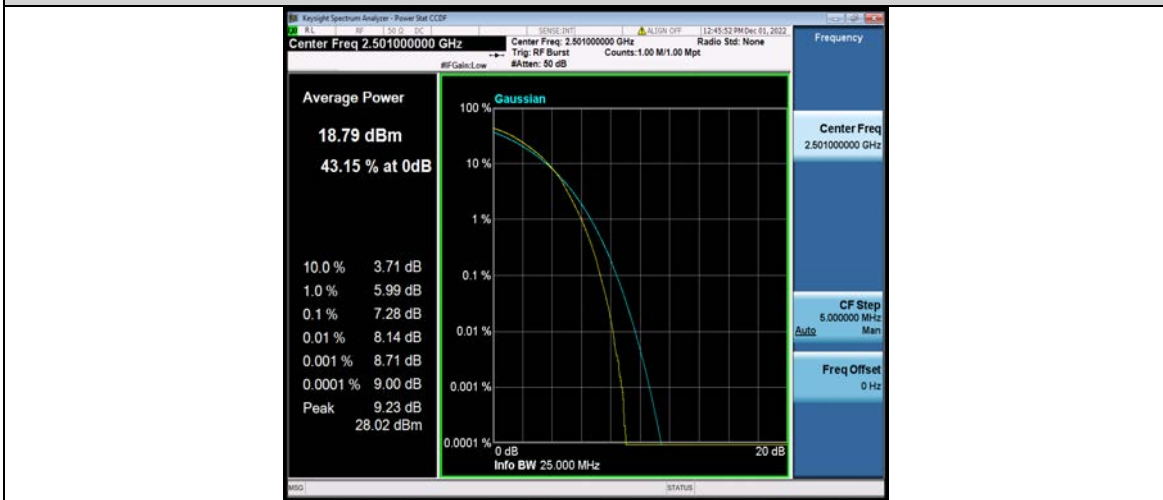

Band41-10MHz-64QAM-40620-1RB#0



Test Report No.: W7L-P23100014RF07



Band41-10MHz-64QAM-40620-50RB#0

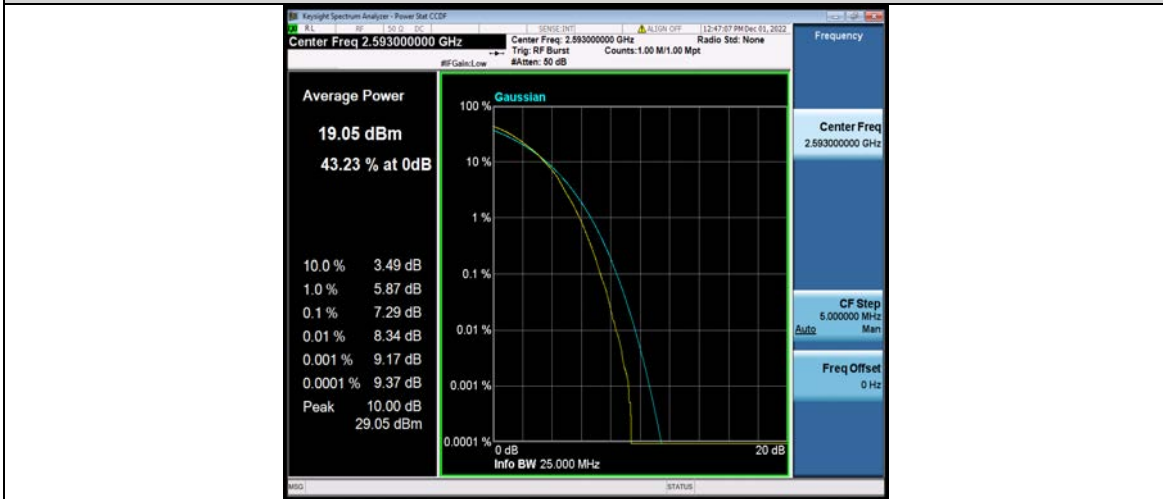

Band41-10MHz-64QAM-41540-1RB#0

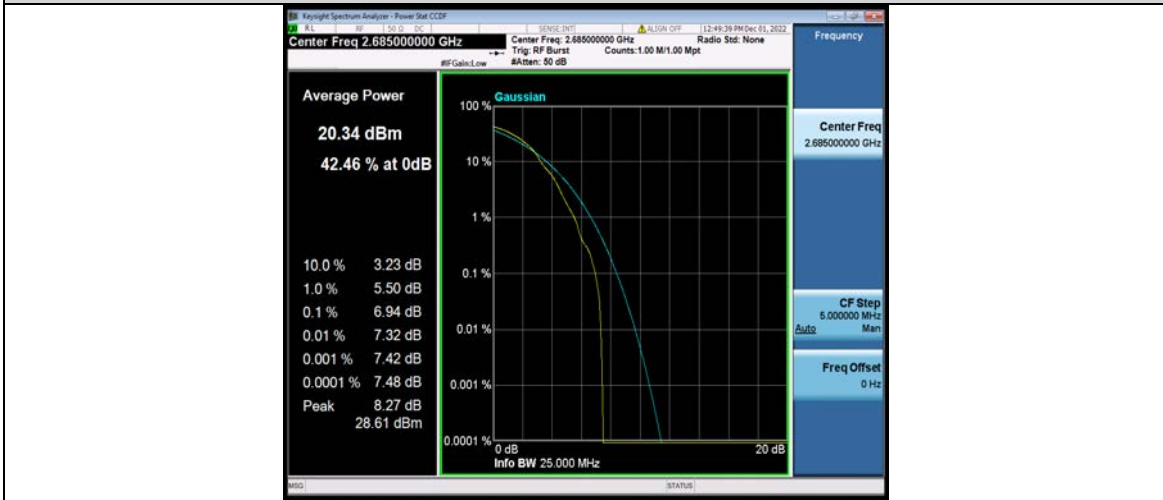

Band41-10MHz-64QAM-41540-50RB#0



Test Report No.: W7L-P23100014RF07

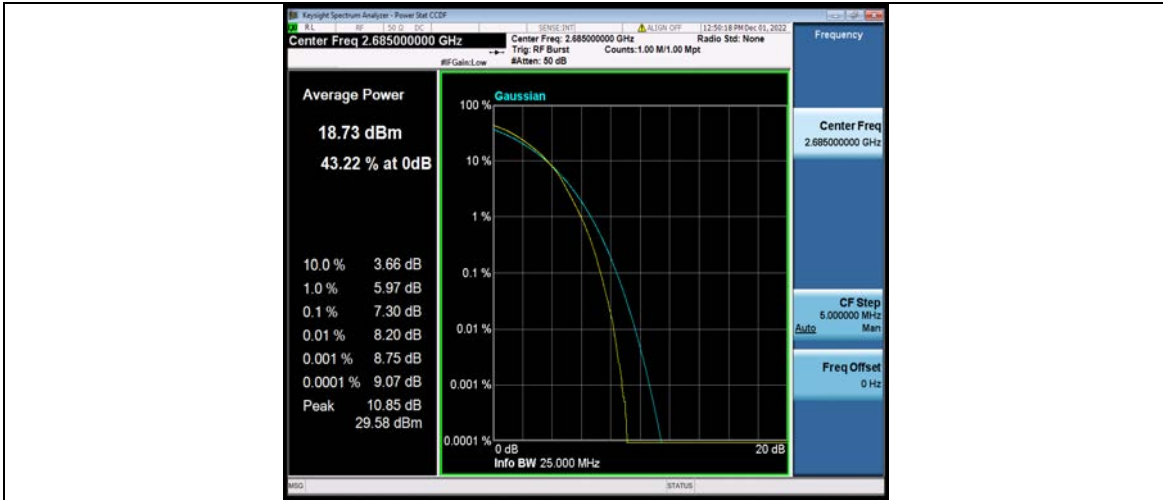

Band41-15MHz-QPSK-39725-1RB#0

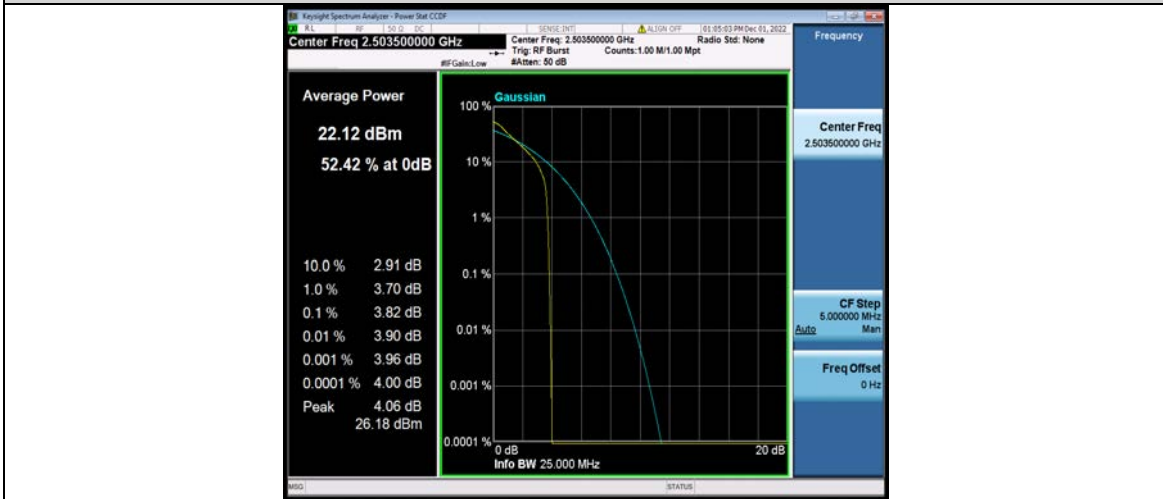

Band41-15MHz-QPSK-39725-75RB#0

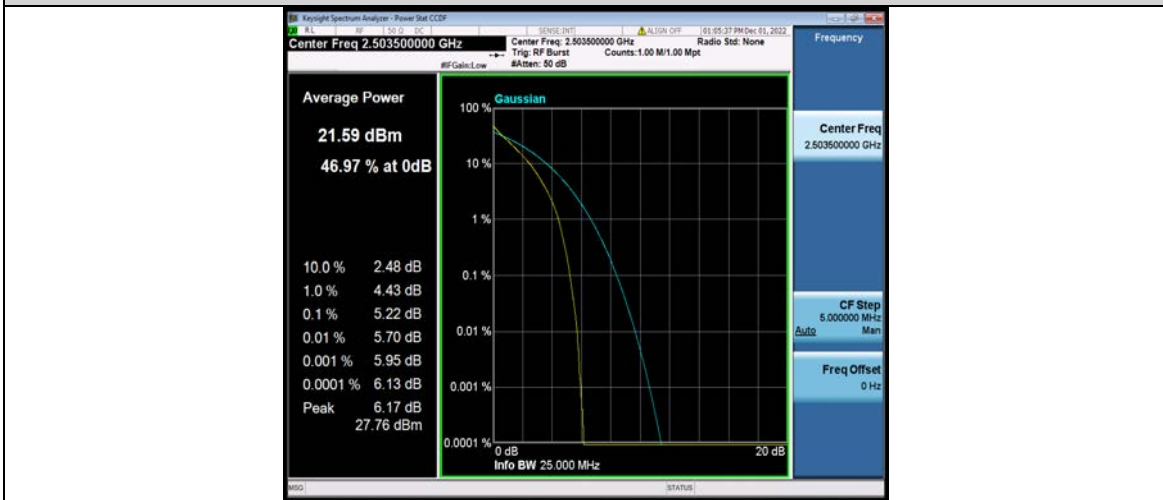

Band41-15MHz-QPSK-40620-1RB#0



Test Report No.: W7L-P23100014RF07



Band41-15MHz-QPSK-40620-75RB#0

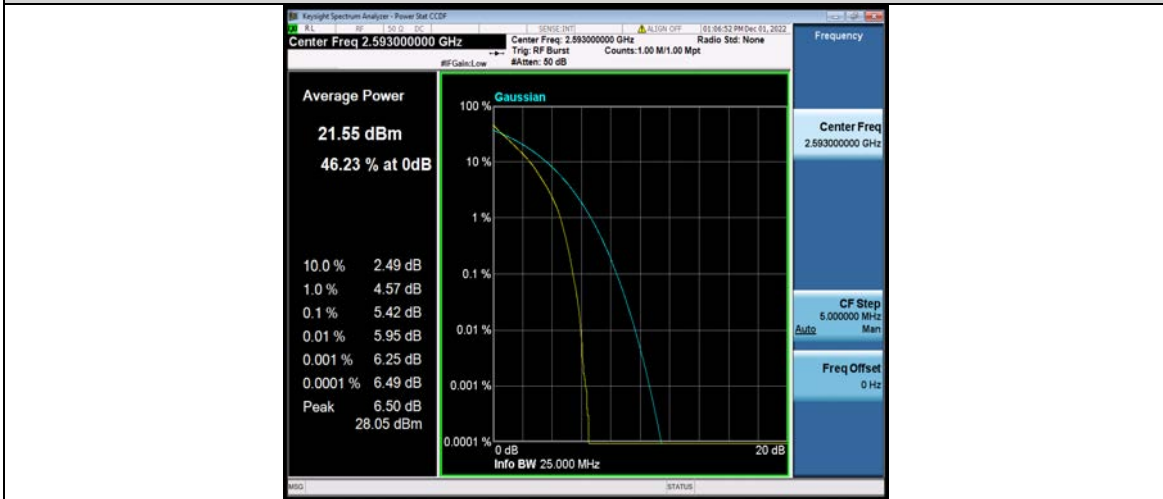

Band41-15MHz-QPSK-41515-1RB#0



Band41-15MHz-QPSK-41515-75RB#0



Test Report No.: W7L-P23100014RF07

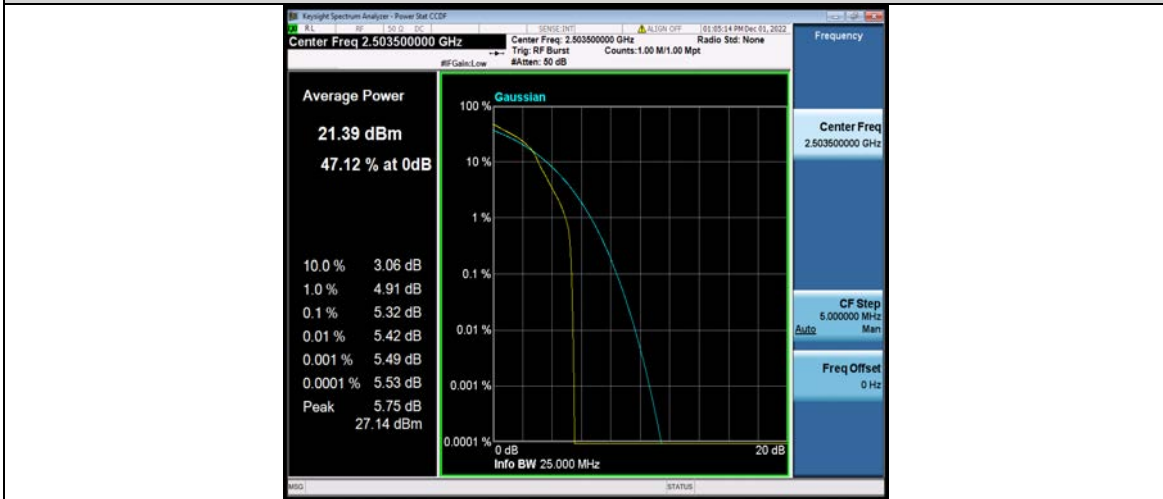
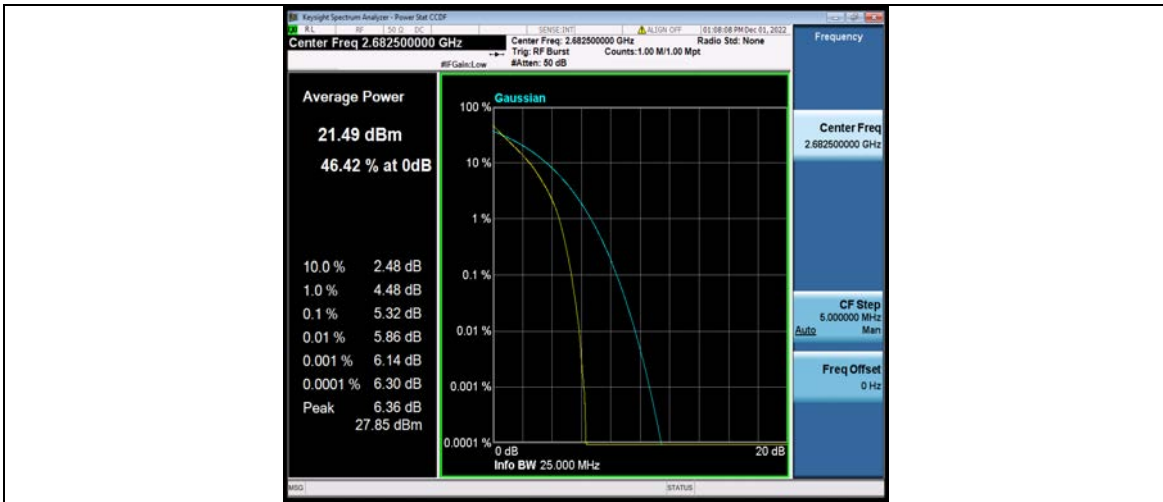



Test Report No.: W7L-P23100014RF07

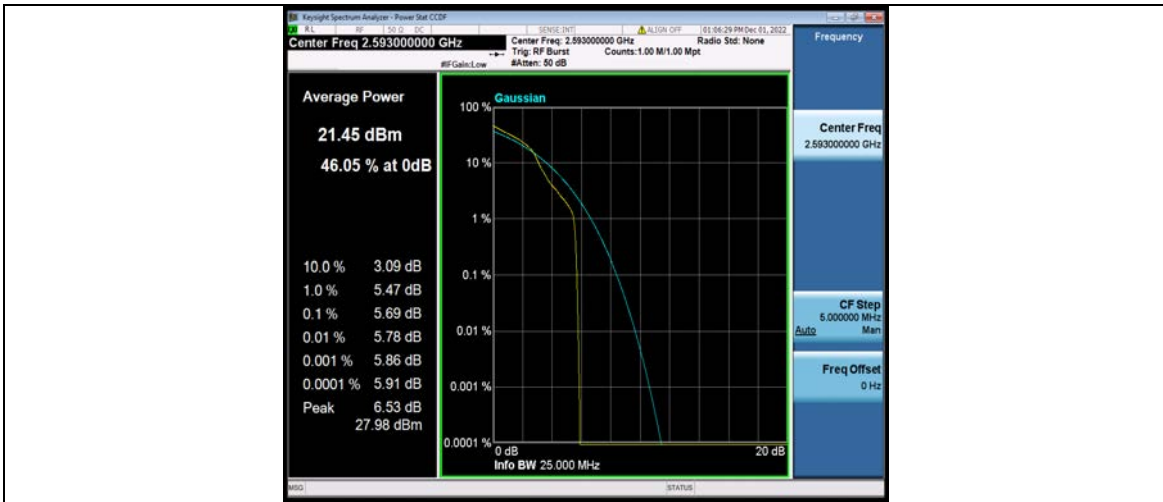

Band41-15MHz-16QAM-40620-75RB#0

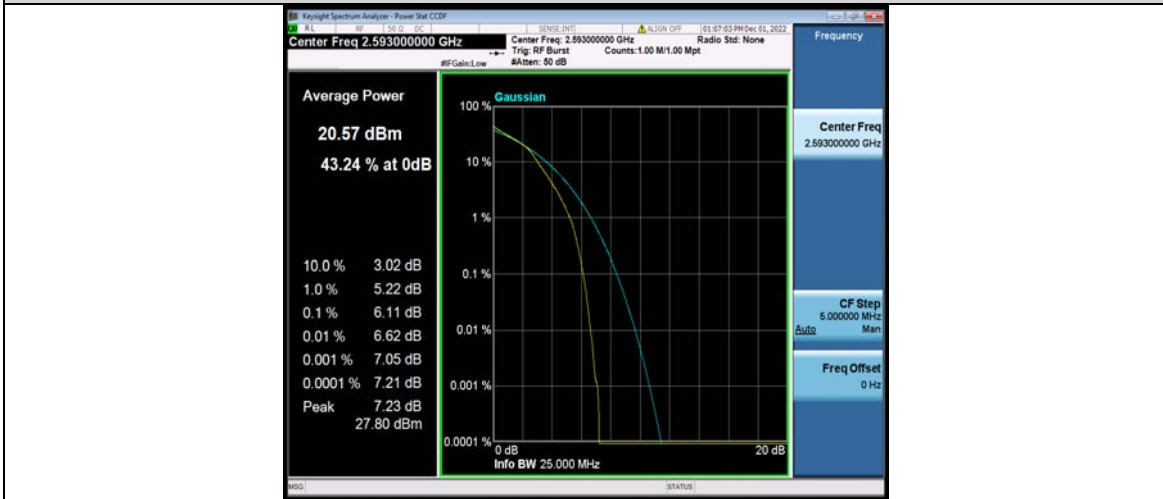

Band41-15MHz-16QAM-41515-1RB#0

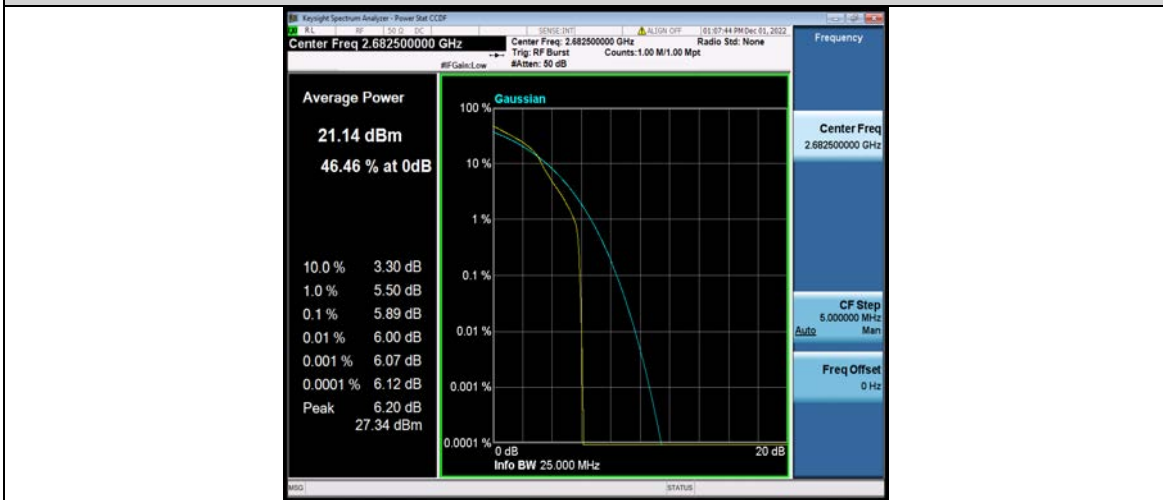

Band41-15MHz-16QAM-41515-75RB#0



Test Report No.: W7L-P23100014RF07



Band41-15MHz-64QAM-39725-1RB#0

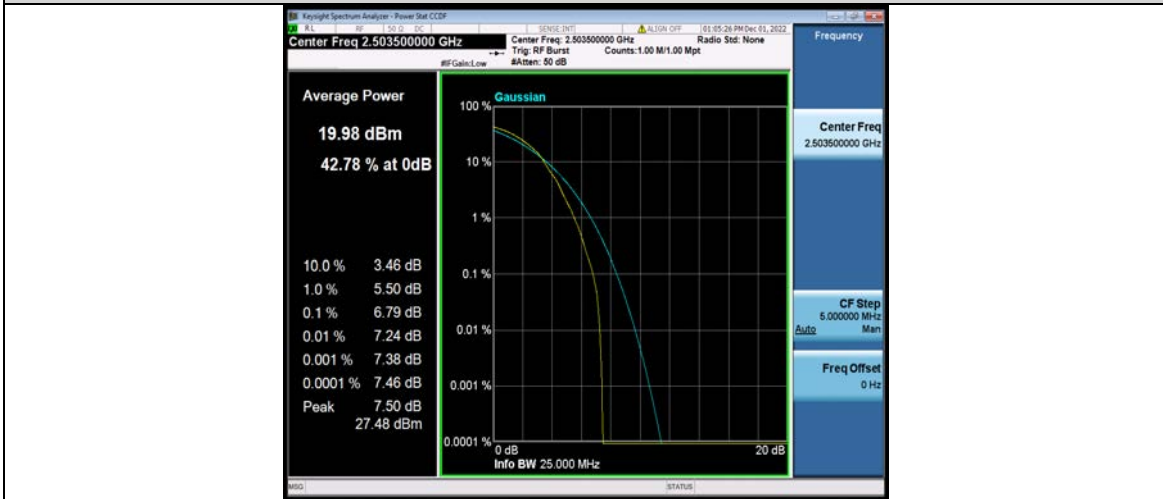

Band41-15MHz-64QAM-39725-75RB#0



Band41-15MHz-64QAM-40620-1RB#0



Test Report No.: W7L-P23100014RF07



Band41-15MHz-64QAM-40620-75RB#0

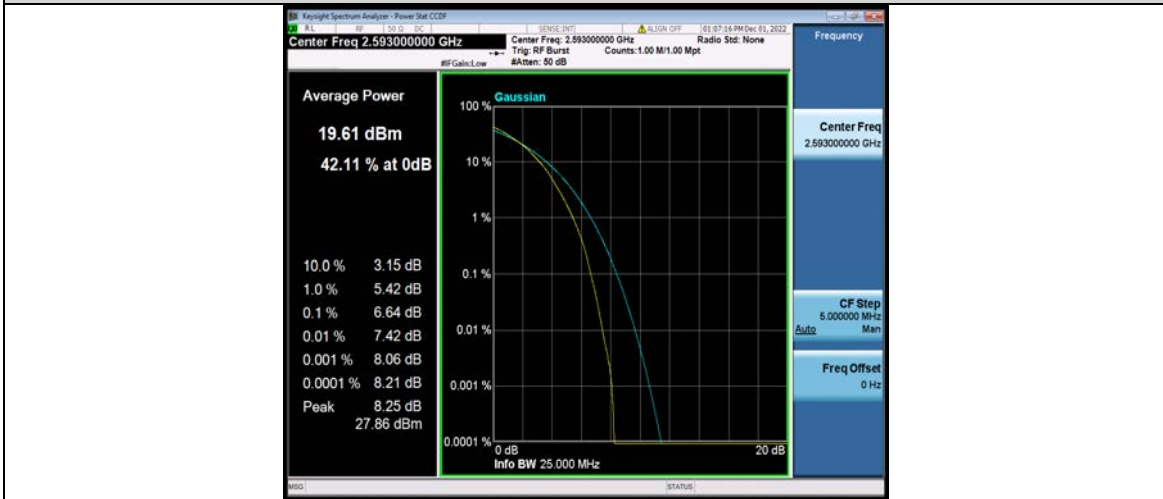

Band41-15MHz-64QAM-41515-1RB#0

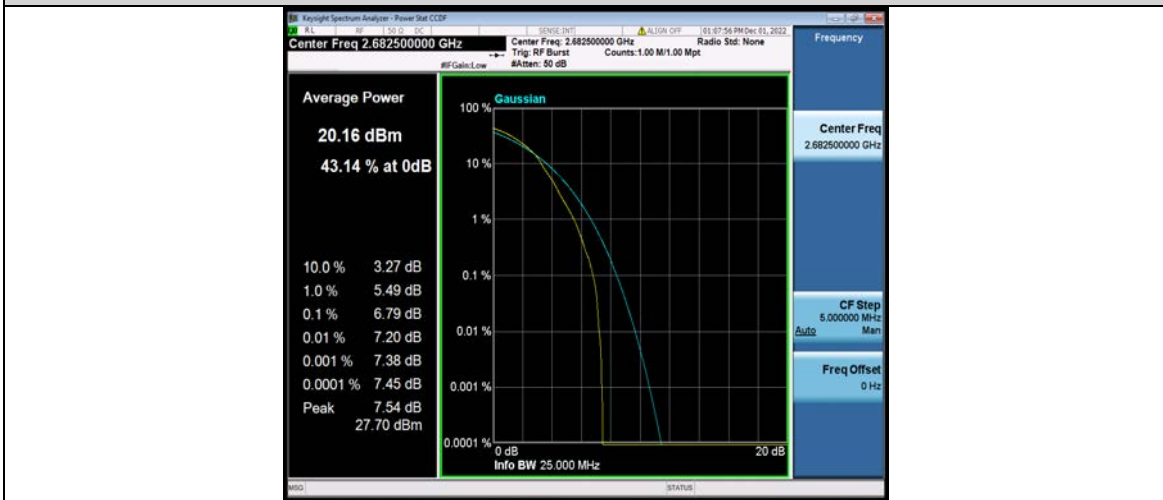

Band41-15MHz-64QAM-41515-75RB#0



Test Report No.: W7L-P23100014RF07

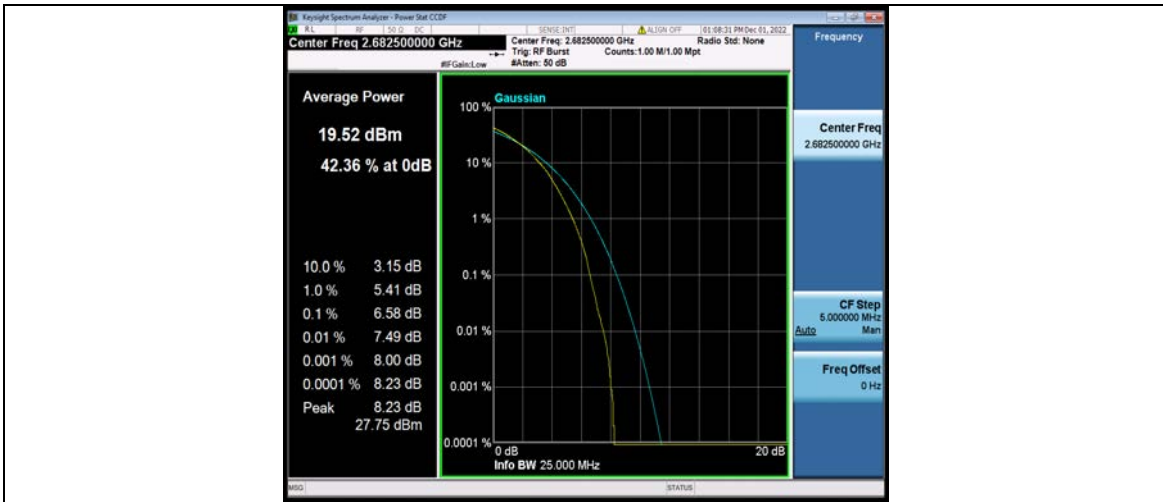

Band41-20MHz-QPSK-39750-1RB#0

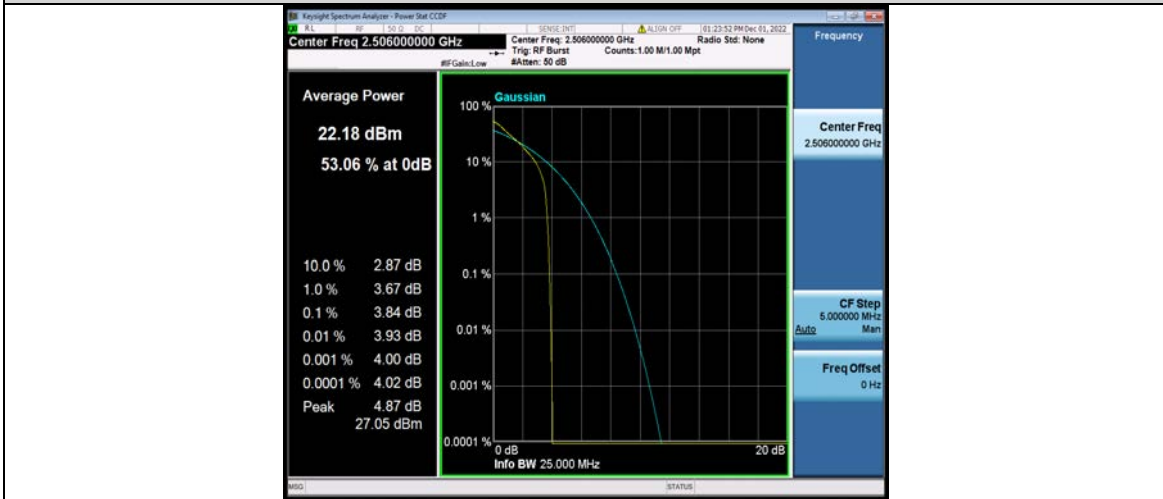

Band41-20MHz-QPSK-39750-100RB#0



Band41-20MHz-QPSK-40620-1RB#0



Test Report No.: W7L-P23100014RF07

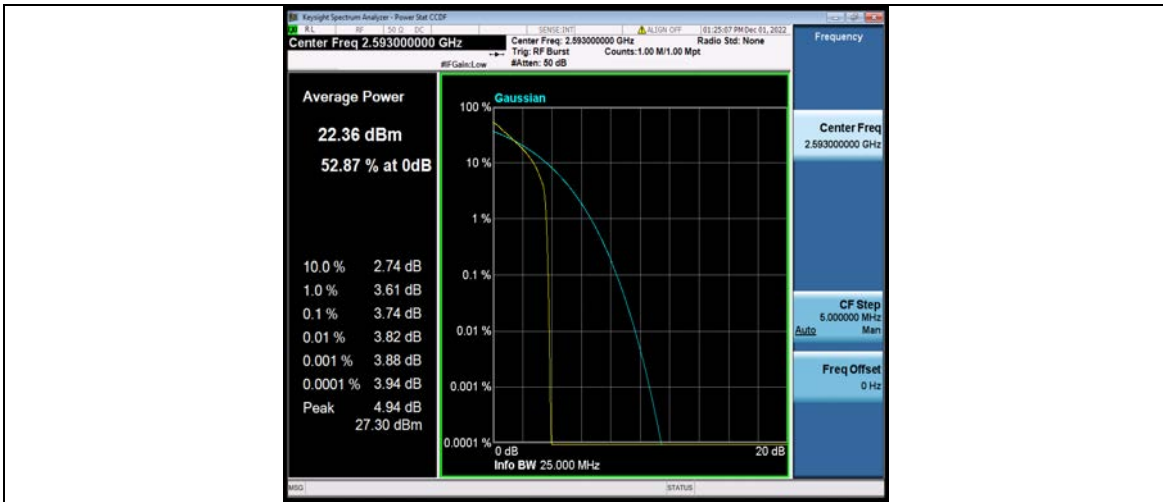

Band41-20MHz-QPSK-40620-100RB#0

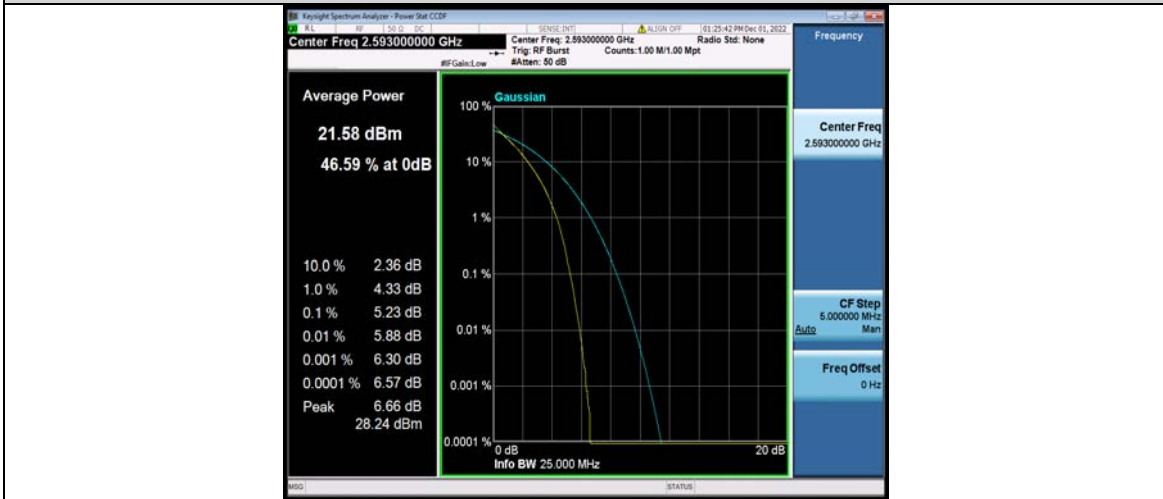

Band41-20MHz-QPSK-41490-1RB#0



Band41-20MHz-QPSK-41490-100RB#0



Test Report No.: W7L-P23100014RF07



Band41-20MHz-16QAM-39750-1RB#0

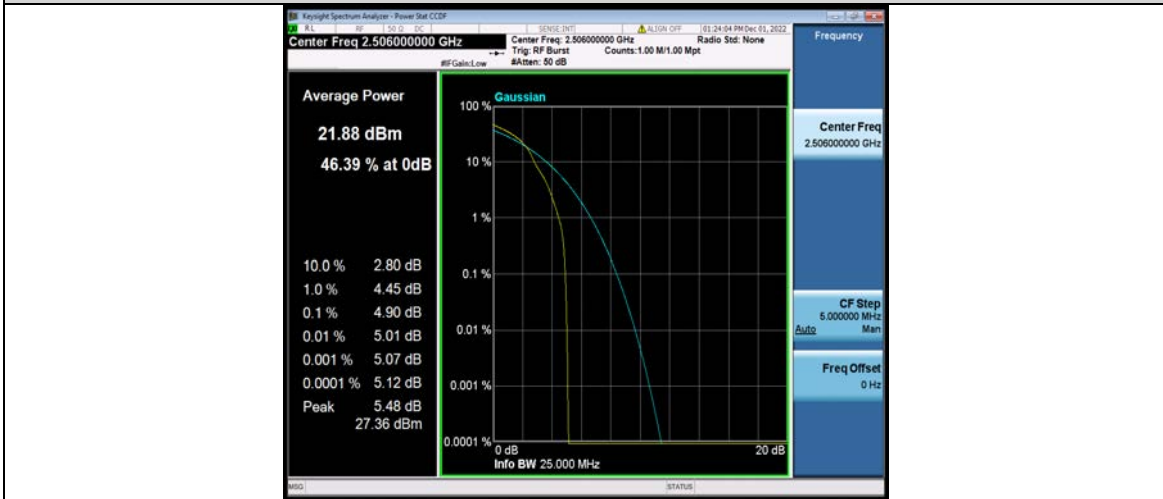

Band41-20MHz-16QAM-39750-100RB#0

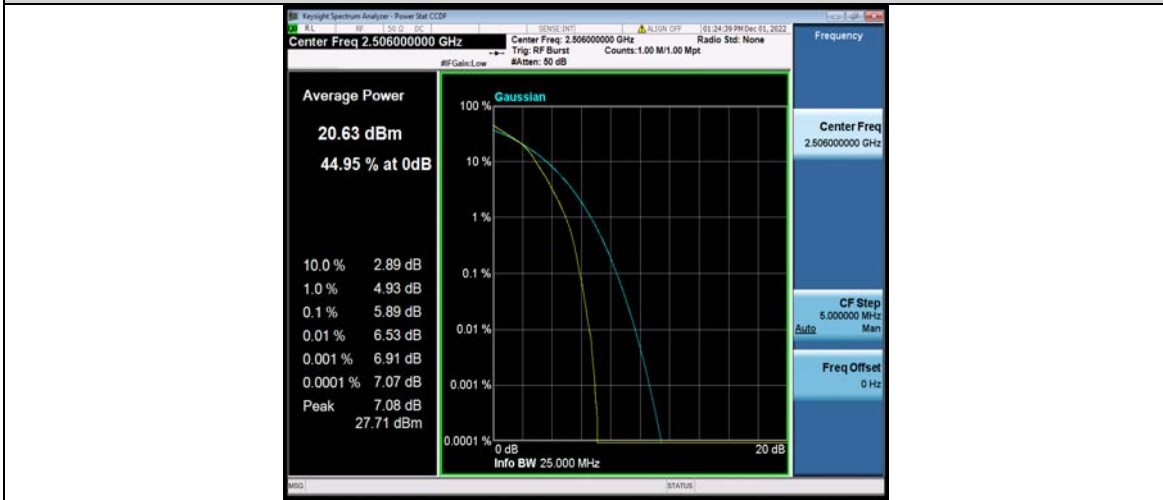

Band41-20MHz-16QAM-40620-1RB#0



Test Report No.: W7L-P23100014RF07



Band41-20MHz-16QAM-40620-100RB#0

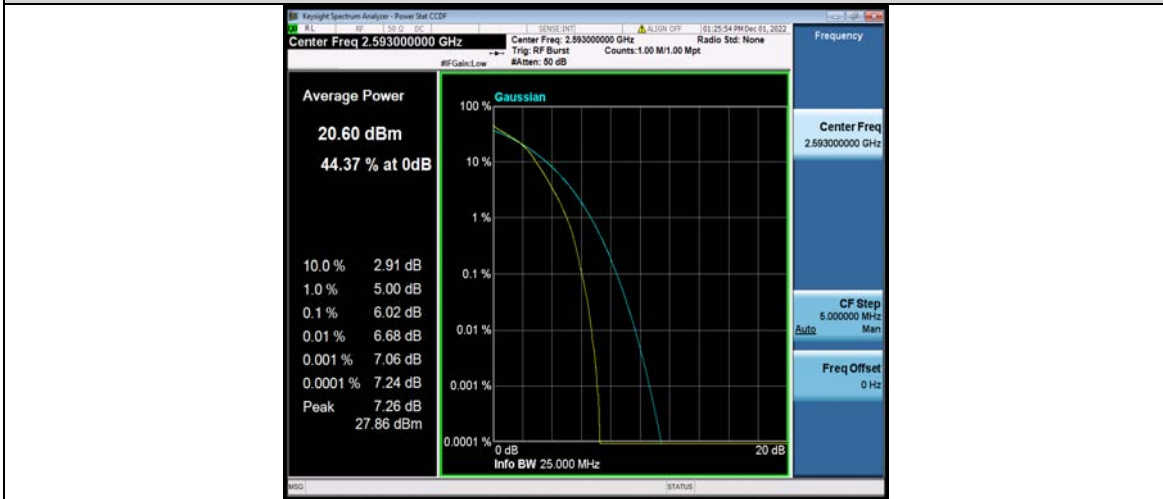

Band41-20MHz-16QAM-41490-1RB#0

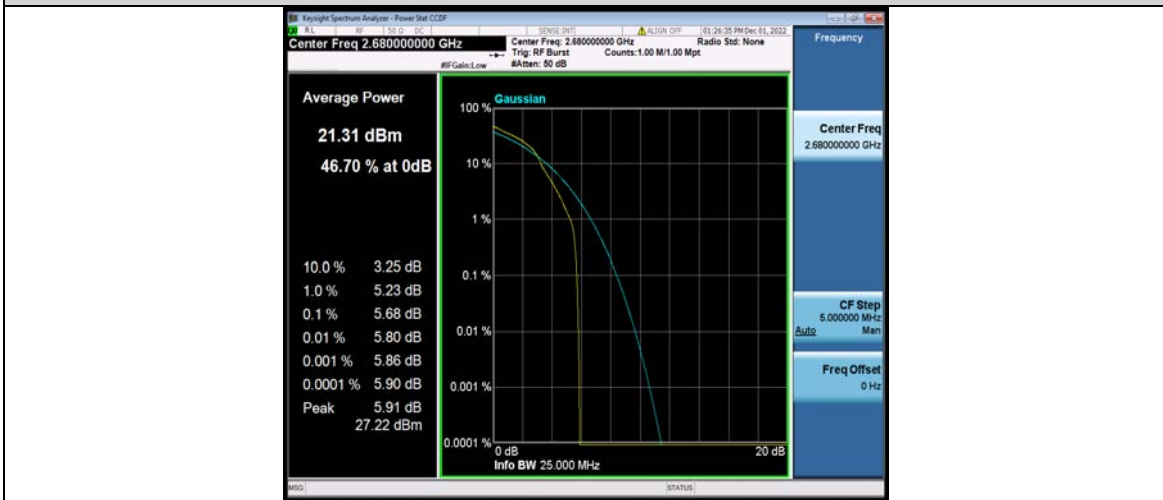

Band41-20MHz-16QAM-41490-100RB#0



Test Report No.: W7L-P23100014RF07

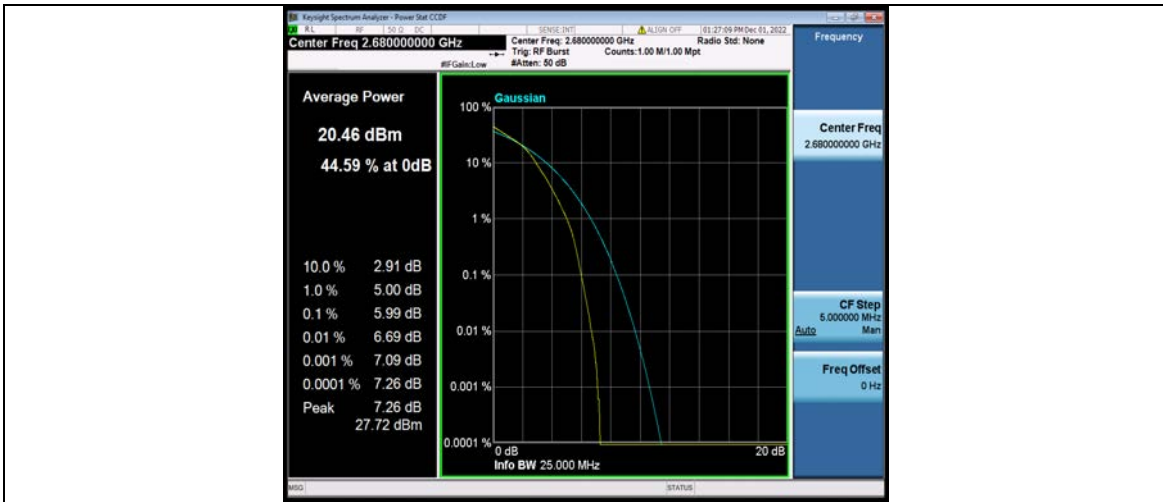

Band41-20MHz-64QAM-39750-1RB#0

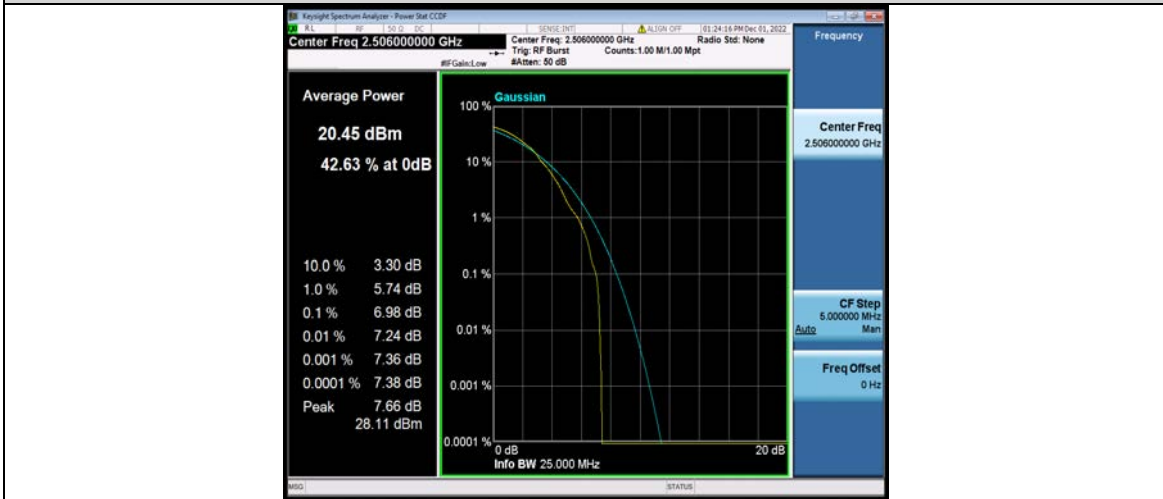

Band41-20MHz-64QAM-39750-100RB#0



Band41-20MHz-64QAM-40620-1RB#0



Test Report No.: W7L-P23100014RF07



Band41-20MHz-64QAM-40620-100RB#0

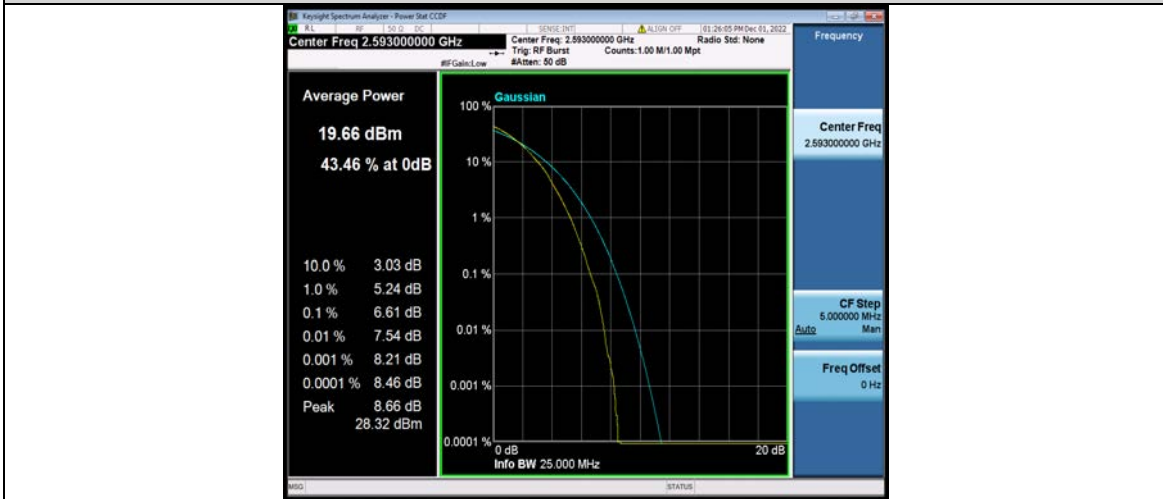

Band41-20MHz-64QAM-41490-1RB#0

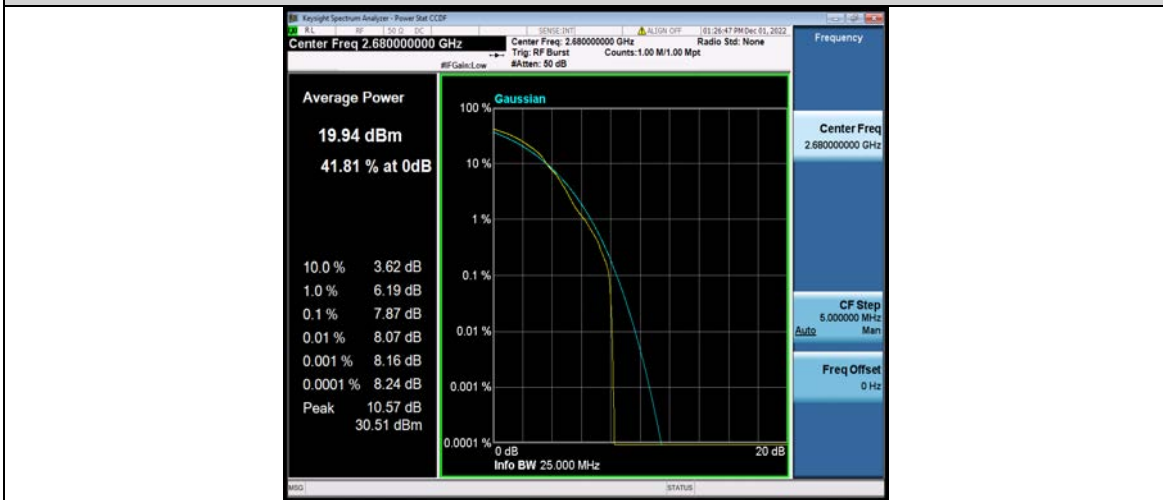

Band41-20MHz-64QAM-41490-100RB#0



Test Report No.: W7L-P23100014RF07





Test Report No.: W7L-P23100014RF07

26DB BANDWIDTH AND OCCUPIED BANDWIDTH

Test Result

Band	Bandwidth	Modulation	Channel	RB Configuration	Occupied Bandwidth (MHz)	26dB Bandwidth (MHz)	Verdict
Band41	5MHz	QPSK	39675	25RB#0	4.4969	4.901	PASS
Band41	5MHz	QPSK	40620	25RB#0	4.4963	4.876	PASS
Band41	5MHz	QPSK	41565	25RB#0	4.4846	4.751	PASS
Band41	5MHz	16QAM	39675	25RB#0	4.4944	4.823	PASS
Band41	5MHz	16QAM	40620	25RB#0	4.5002	4.831	PASS
Band41	5MHz	16QAM	41565	25RB#0	4.4985	4.824	PASS
Band41	5MHz	64QAM	39675	25RB#0	4.5013	4.841	PASS
Band41	5MHz	64QAM	40620	25RB#0	4.4892	4.834	PASS
Band41	5MHz	64QAM	41565	25RB#0	4.4883	4.845	PASS
Band41	10MHz	QPSK	39700	50RB#0	8.9787	9.495	PASS
Band41	10MHz	QPSK	40620	50RB#0	8.9755	9.498	PASS
Band41	10MHz	QPSK	41540	50RB#0	8.9808	9.509	PASS
Band41	10MHz	16QAM	39700	50RB#0	8.9794	9.532	PASS
Band41	10MHz	16QAM	40620	50RB#0	8.9844	9.515	PASS
Band41	10MHz	16QAM	41540	50RB#0	8.9606	9.522	PASS
Band41	10MHz	64QAM	39700	50RB#0	8.9659	9.501	PASS
Band41	10MHz	64QAM	40620	50RB#0	8.9778	9.512	PASS
Band41	10MHz	64QAM	41540	50RB#0	8.9664	9.532	PASS
Band41	15MHz	QPSK	39725	75RB#0	13.464	14.28	PASS
Band41	15MHz	QPSK	40620	75RB#0	13.459	14.25	PASS
Band41	15MHz	QPSK	41515	75RB#0	13.477	14.27	PASS
Band41	15MHz	16QAM	39725	75RB#0	13.464	14.28	PASS
Band41	15MHz	16QAM	40620	75RB#0	13.453	14.25	PASS
Band41	15MHz	16QAM	41515	75RB#0	13.465	14.30	PASS
Band41	15MHz	64QAM	39725	75RB#0	13.455	14.25	PASS
Band41	15MHz	64QAM	40620	75RB#0	13.465	14.27	PASS
Band41	15MHz	64QAM	41515	75RB#0	13.467	14.26	PASS
Band41	20MHz	QPSK	39750	100RB#0	17.951	19.00	PASS
Band41	20MHz	QPSK	40620	100RB#0	17.915	18.98	PASS
Band41	20MHz	QPSK	41490	100RB#0	17.967	18.97	PASS
Band41	20MHz	16QAM	39750	100RB#0	17.953	18.93	PASS
Band41	20MHz	16QAM	40620	100RB#0	17.942	18.95	PASS
Band41	20MHz	16QAM	41490	100RB#0	17.944	18.97	PASS
Band41	20MHz	64QAM	39750	100RB#0	17.961	18.96	PASS
Band41	20MHz	64QAM	40620	100RB#0	17.964	18.98	PASS
Band41	20MHz	64QAM	41490	100RB#0	17.970	18.96	PASS



Test Graphs

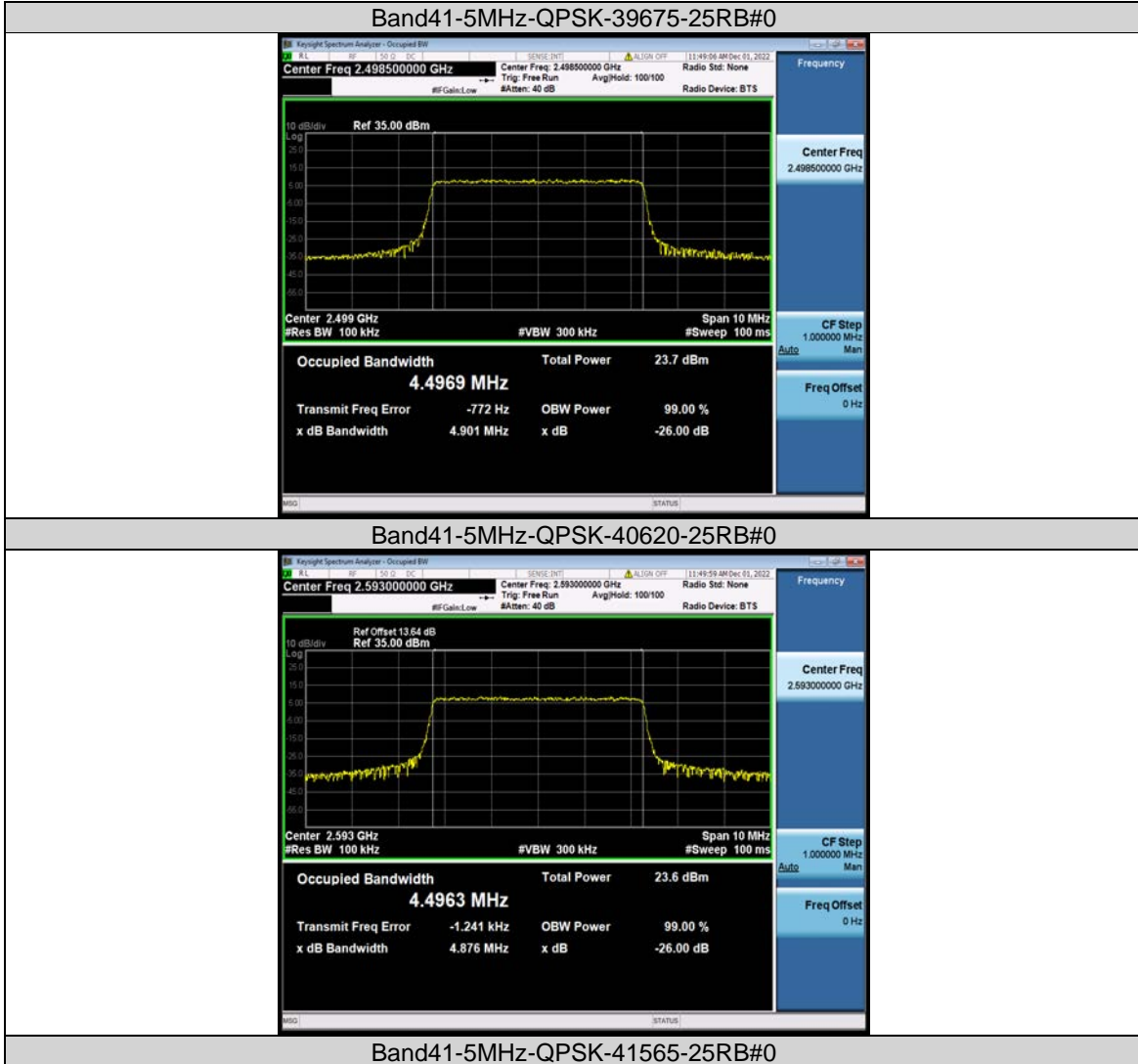



Test Report No.: W7L-P23100014RF07

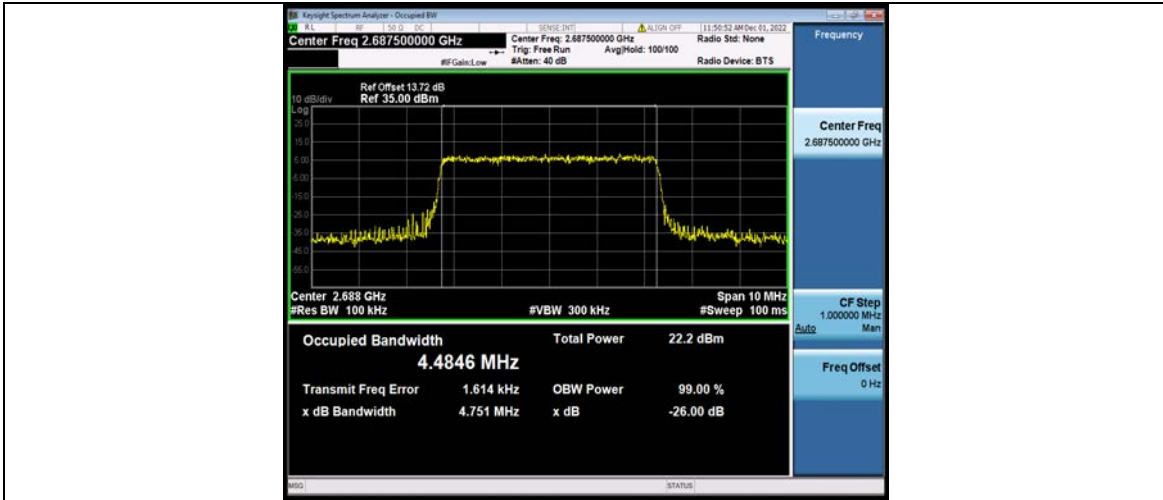

Band41-5MHz-16QAM-39675-25RB#0

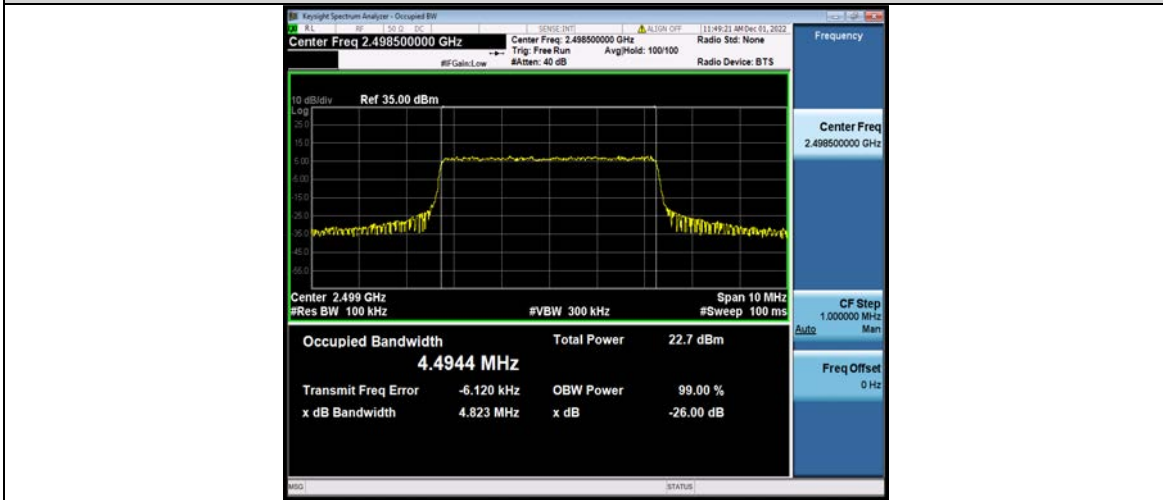

Band41-5MHz-16QAM-40620-25RB#0

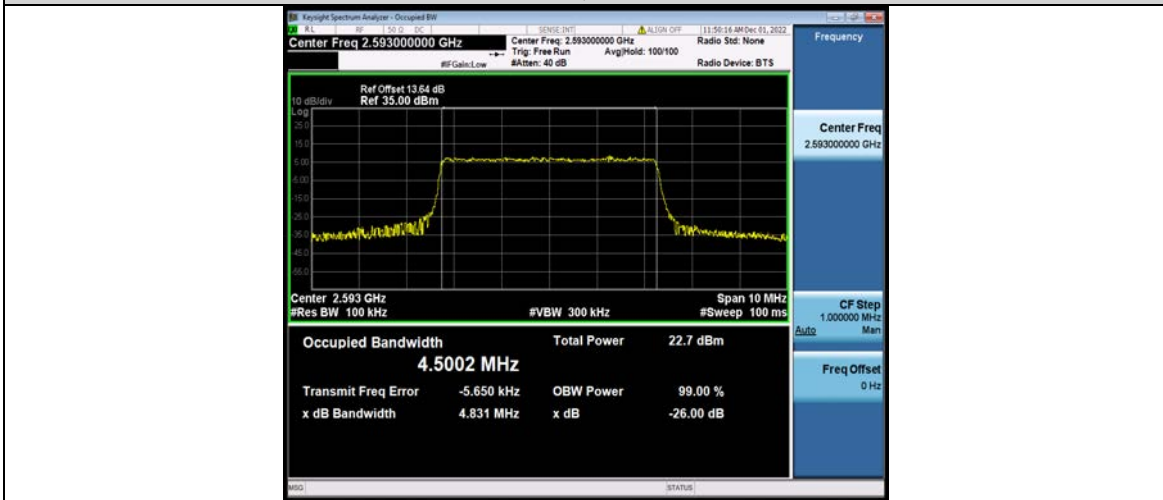

Band41-5MHz-16QAM-41565-25RB#0



Test Report No.: W7L-P23100014RF07

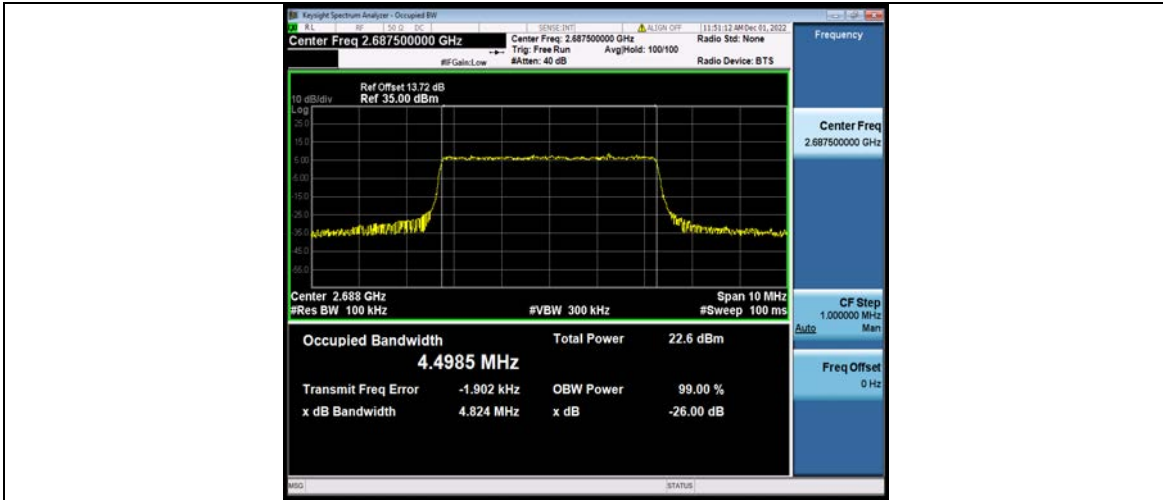

Band41-5MHz-64QAM-39675-25RB#0

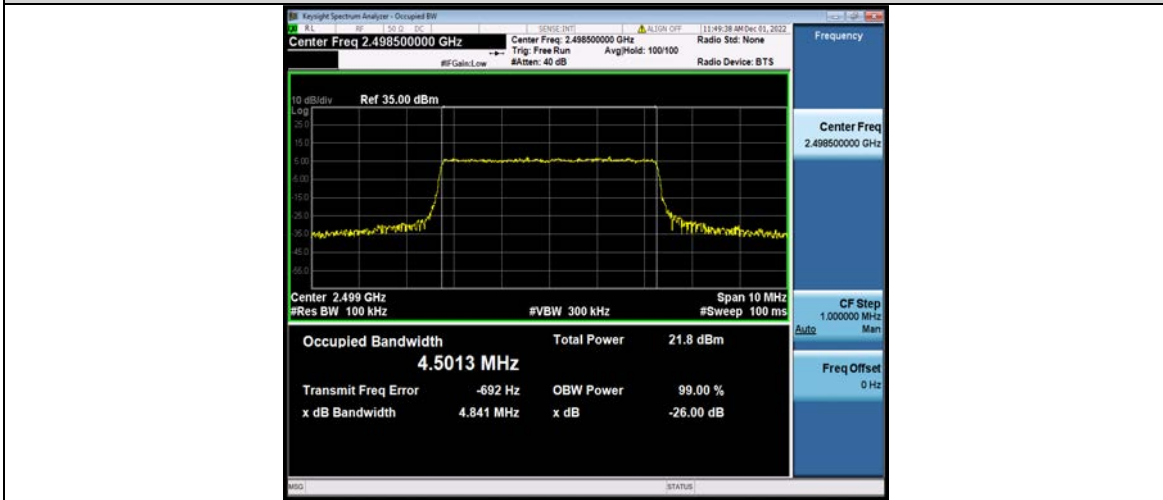

Band41-5MHz-64QAM-40620-25RB#0

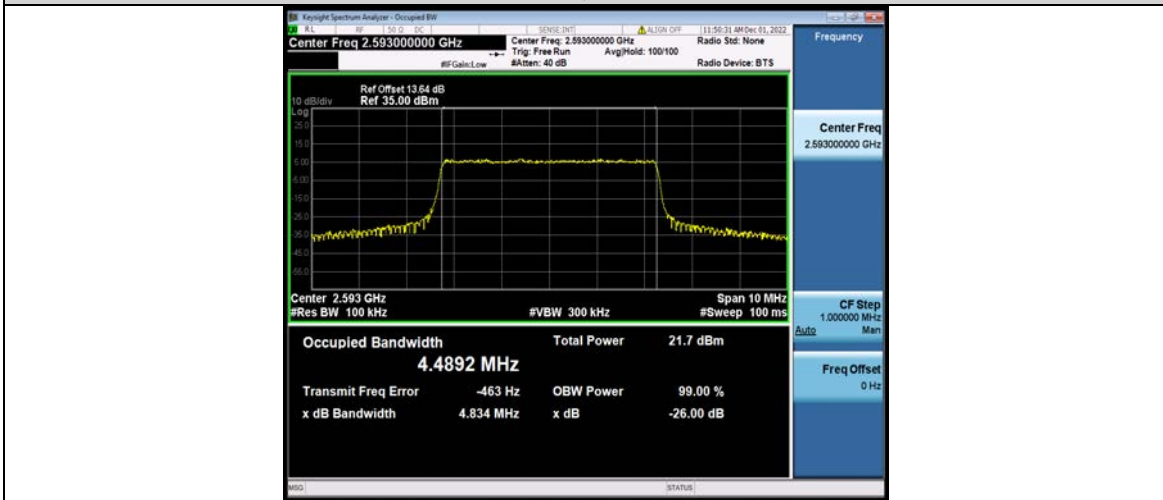

Band41-5MHz-64QAM-41565-25RB#0



Test Report No.: W7L-P23100014RF07

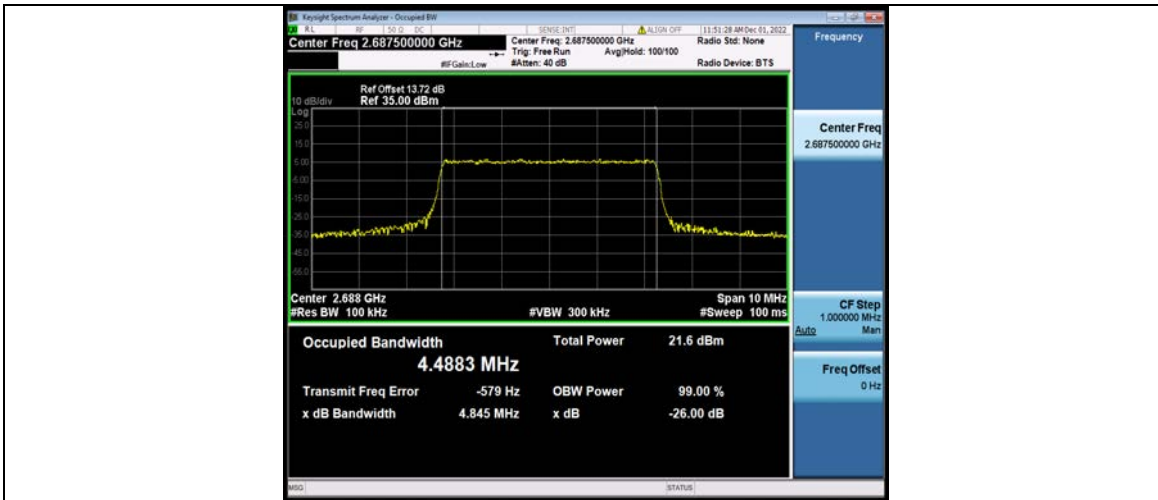

Band41-10MHz-QPSK-39700-50RB#0



Band41-10MHz-QPSK-40620-50RB#0

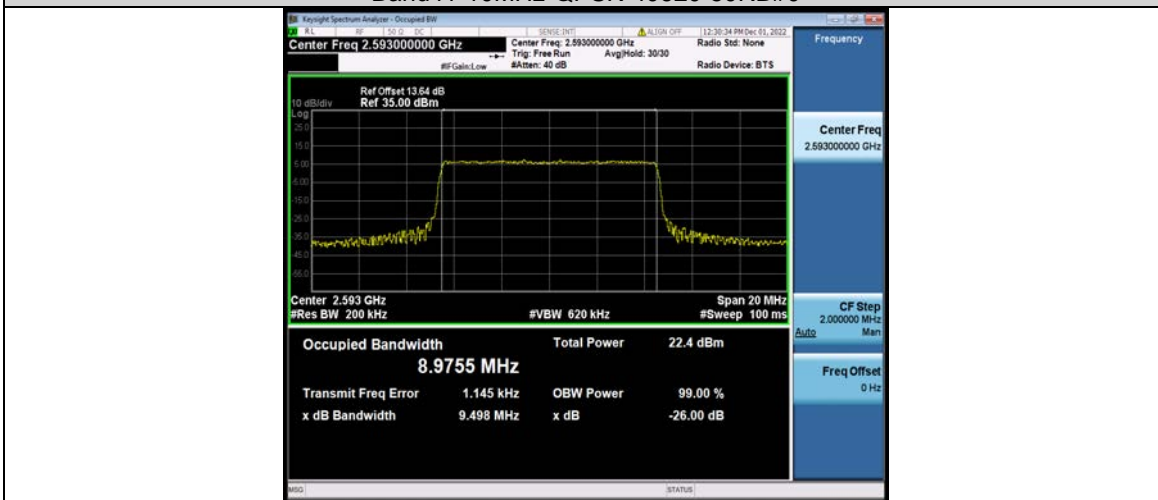

Band41-10MHz-QPSK-41540-50RB#0



Test Report No.: W7L-P23100014RF07

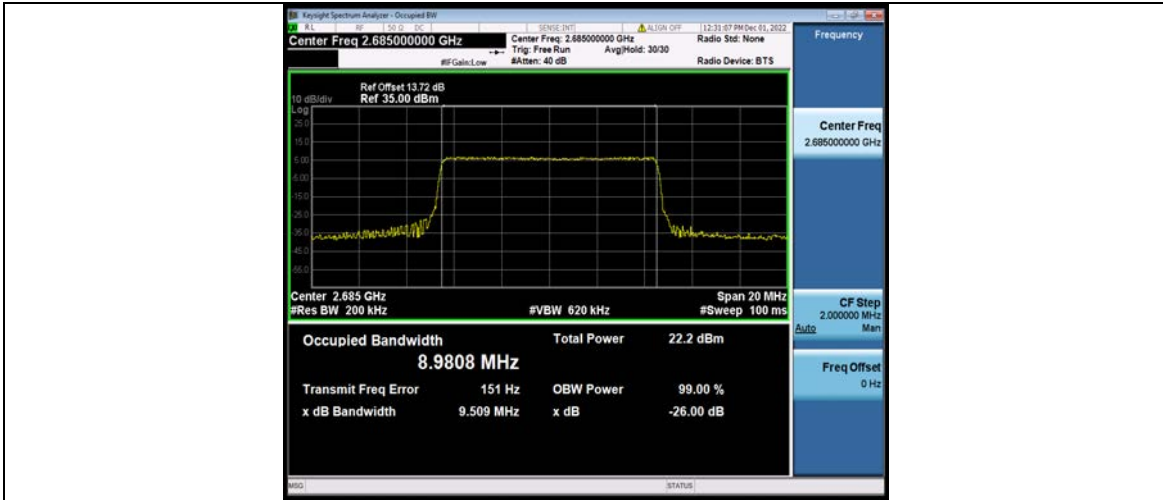

Band41-10MHz-16QAM-39700-50RB#0



Band41-10MHz-16QAM-40620-50RB#0



Band41-10MHz-16QAM-41540-50RB#0



Test Report No.: W7L-P23100014RF07



Band41-10MHz-64QAM-39700-50RB#0

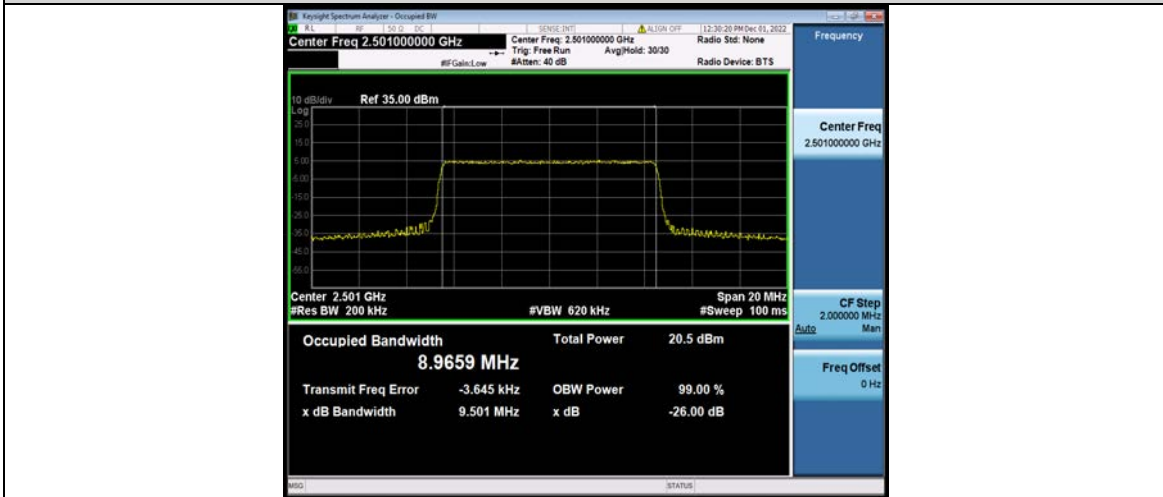

Band41-10MHz-64QAM-40620-50RB#0

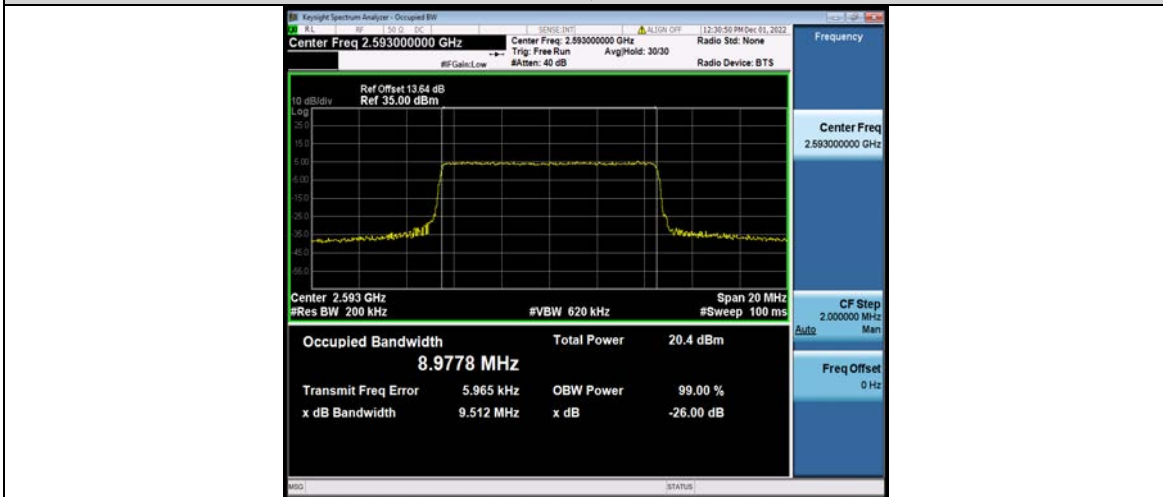

Band41-10MHz-64QAM-41540-50RB#0



Test Report No.: W7L-P23100014RF07

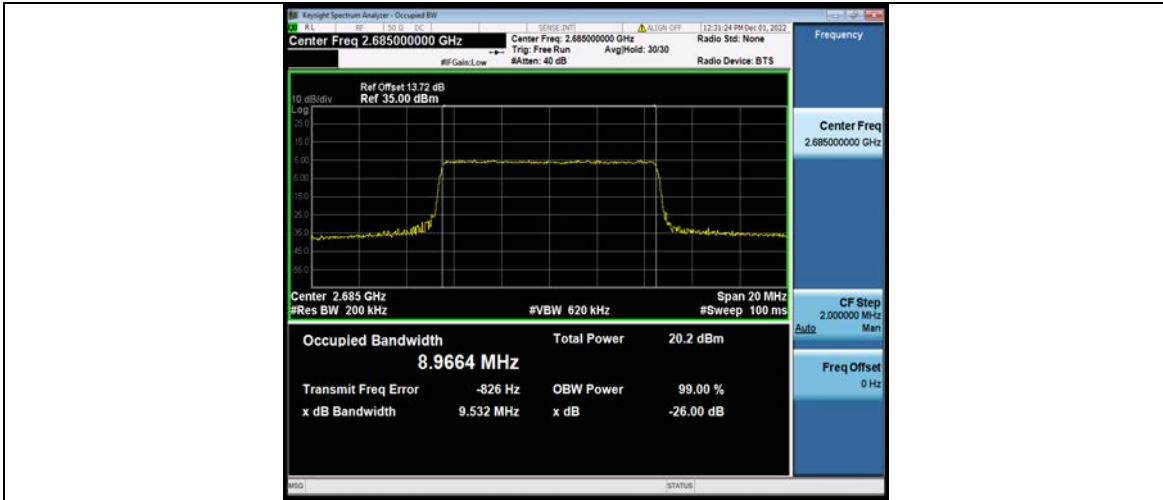

Band41-15MHz-QPSK-39725-75RB#0

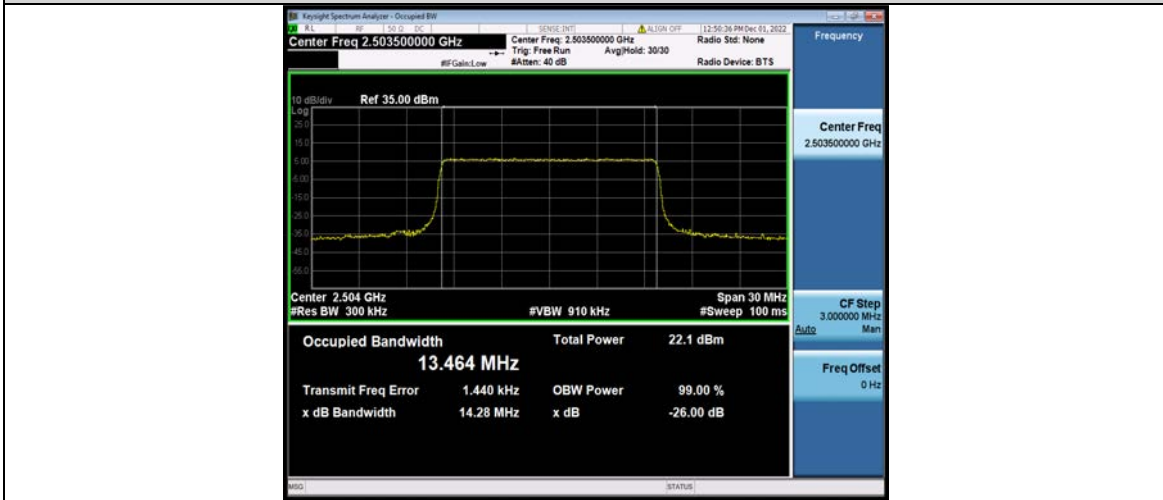

Band41-15MHz-QPSK-40620-75RB#0

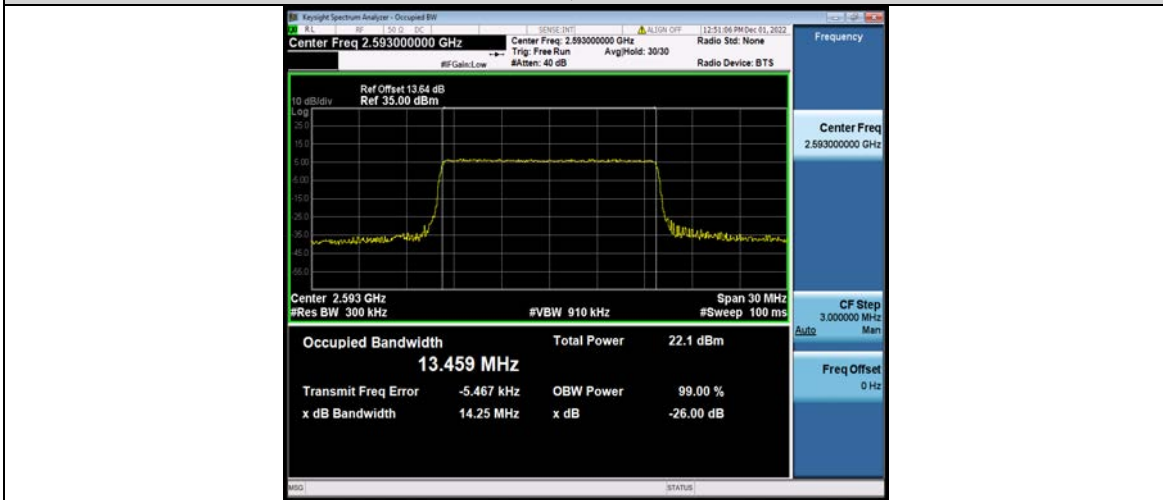

Band41-15MHz-QPSK-41515-75RB#0



Test Report No.: W7L-P23100014RF07



Band41-15MHz-16QAM-39725-75RB#0

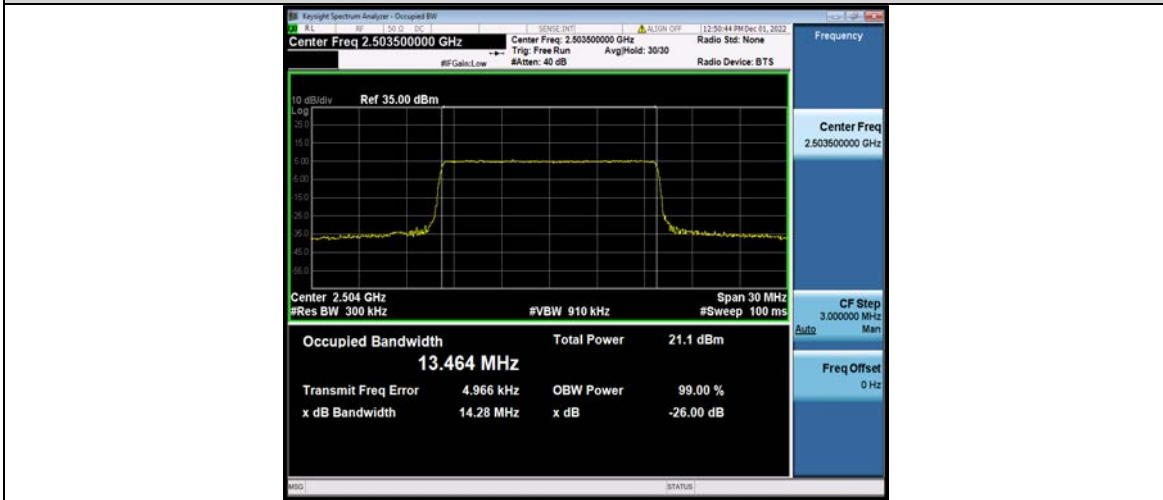

Band41-15MHz-16QAM-40620-75RB#0

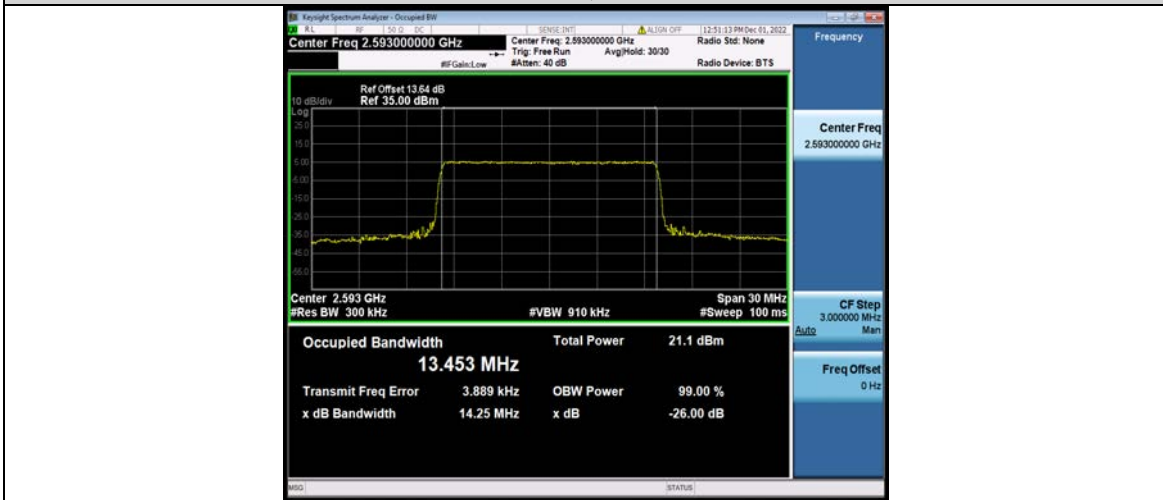

Band41-15MHz-16QAM-41515-75RB#0



Test Report No.: W7L-P23100014RF07



Band41-15MHz-64QAM-39725-75RB#0

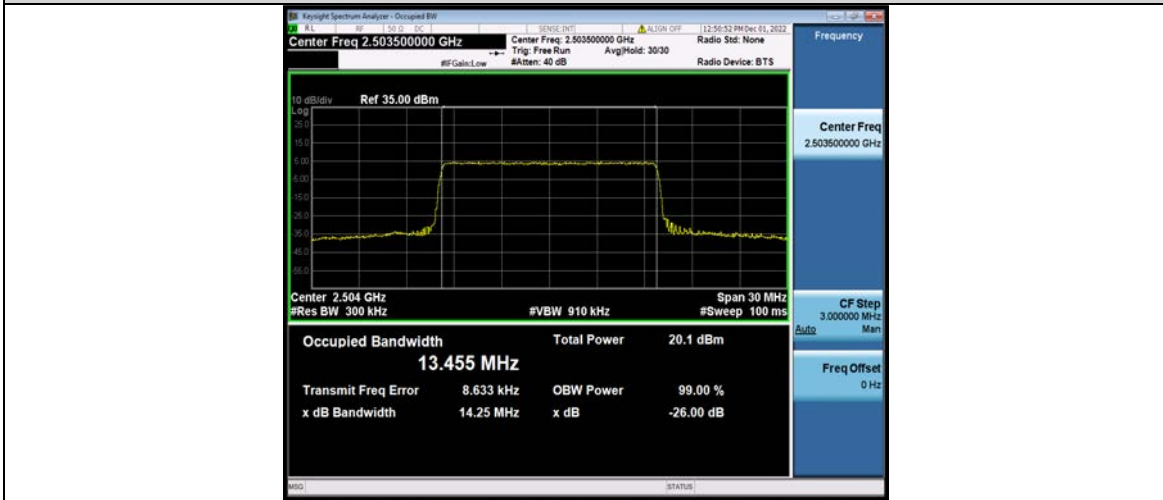

Band41-15MHz-64QAM-40620-75RB#0

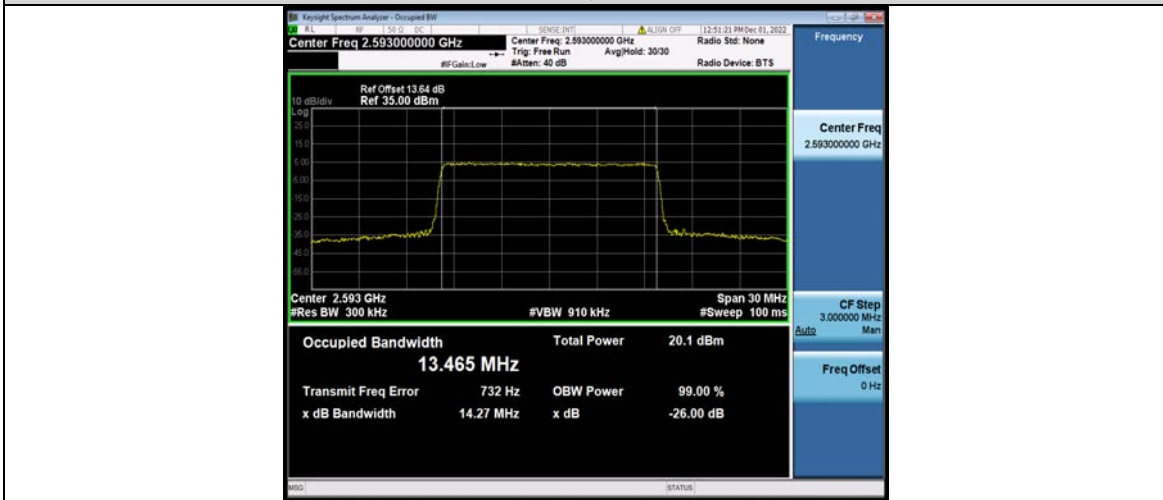

Band41-15MHz-64QAM-41515-75RB#0



Test Report No.: W7L-P23100014RF07



Band41-20MHz-QPSK-39750-100RB#0



Band41-20MHz-QPSK-40620-100RB#0

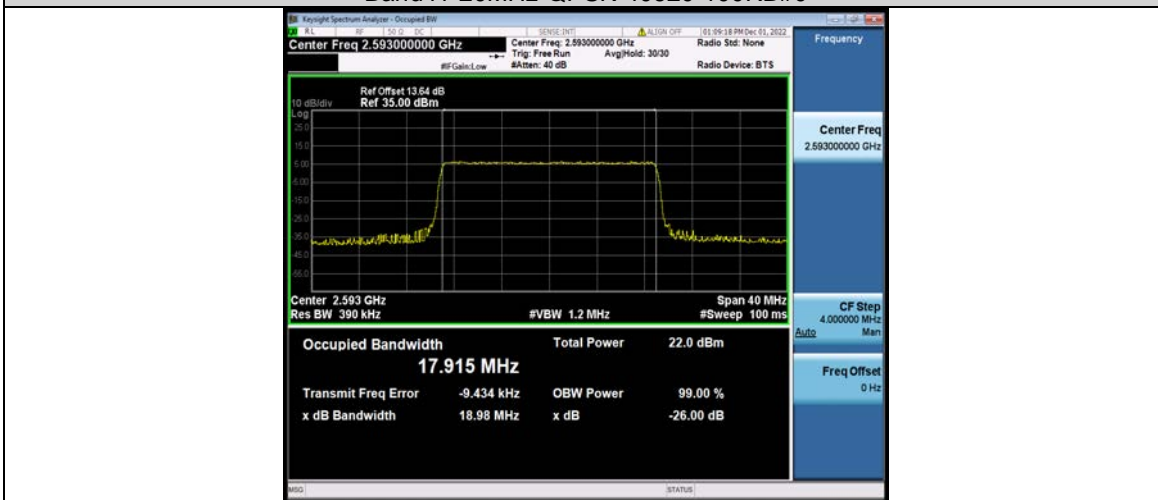

Band41-20MHz-QPSK-41490-100RB#0



Test Report No.: W7L-P23100014RF07

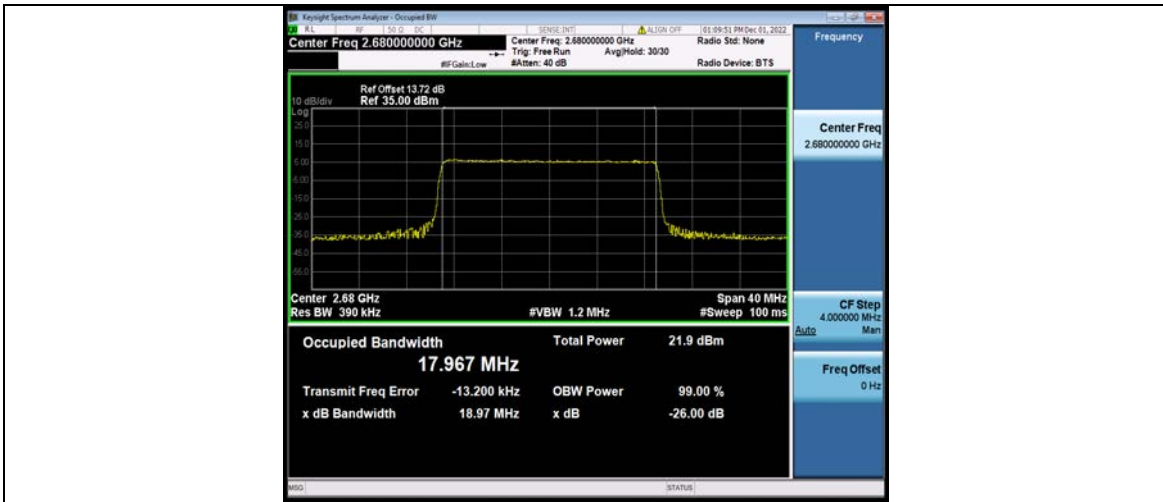

Band41-20MHz-16QAM-39750-100RB#0

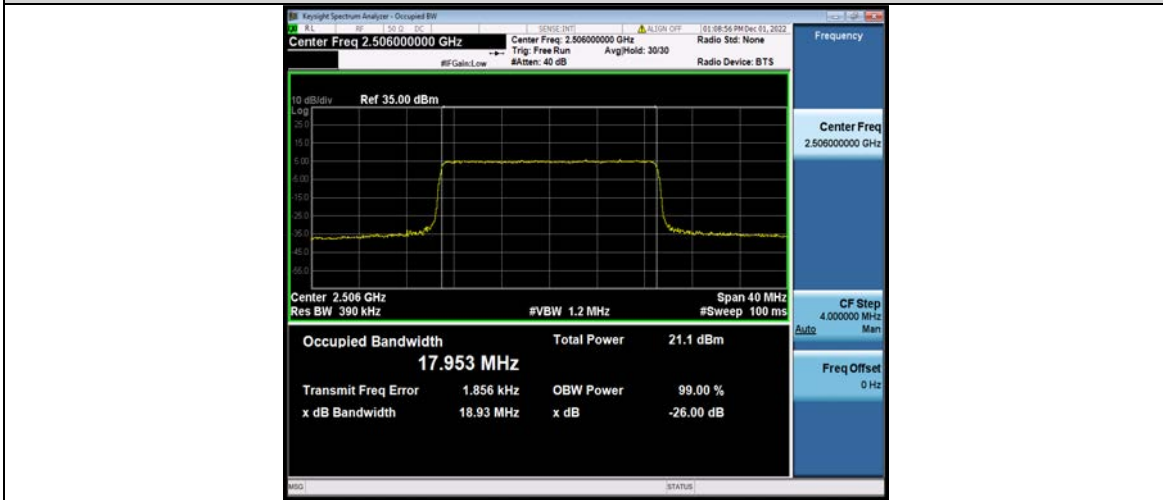

Band41-20MHz-16QAM-40620-100RB#0

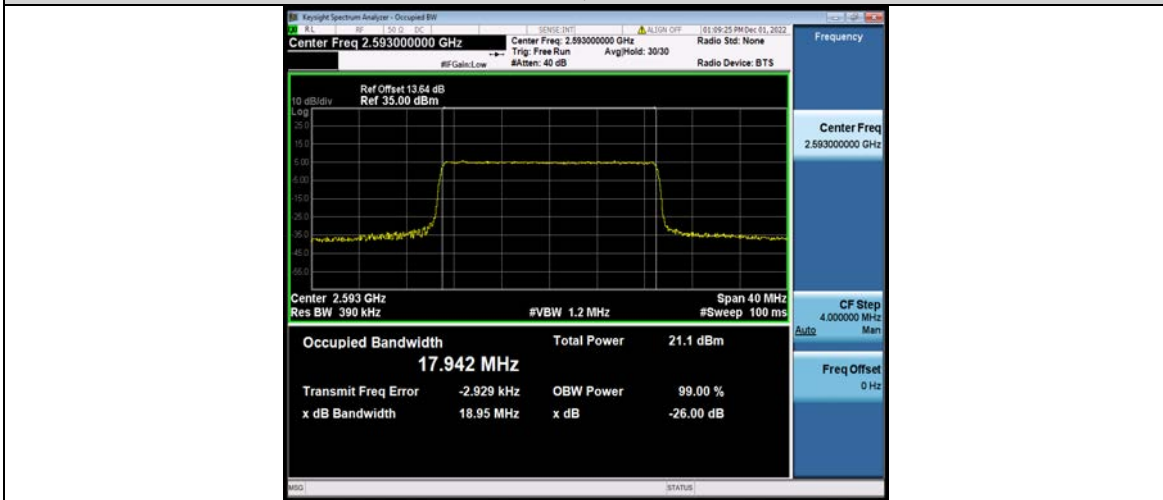

Band41-20MHz-16QAM-41490-100RB#0