



Test Report No.: W7L-P23100014RF06



VARIANT FCC TEST REPORT (PART 27)

Applicant:	Nokia of America Corp
Address:	3201, Olympus Blvd, Dallas, TX 75019, USA

Manufacturer or Supplier:	Nokia of America Corp
Address:	3201, Olympus Blvd, Dallas, TX 75019, USA
Product:	Nokia Industrial 5G handheld HHRA501x
Brand Name:	Nokia
Model Name:	HHRA501a
Marketing Name:	Nokia Industrial 5G handheld HHRA501a
FCC ID:	2AVO2-HHRA501A
Date of tests:	Nov. 24, 2022 ~ Feb. 07, 2023

The tests have been carried out according to the requirements of the following standard:

- FCC Part 27 ANSI/TIA/EIA-603-D
- FCC Part 2 ANSI/TIA/EIA-603-E ANSI C63.26-2015

CONCLUSION: The submitted sample was found to COMPLY with the test requirement

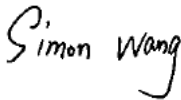
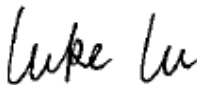
Prepared by Simon Wang Engineer / Mobile Department	Approved by Luke Lu Manager / Mobile Department
	
Date: Oct. 23, 2023	Date: Oct. 23, 2023

This report is governed by, and incorporates by reference, the Conditions of Testing as posted at the date of issuance of this report at <http://www.bureauveritas.com/home/about-us/our-business/cps/about-us/terms-conditions/> and is intended for your exclusive use. Any copying or replication of this report to or for any other person or entity, or use of our name or trademark, is permitted only with our prior written permission. This report sets forth our findings solely with respect to the test samples identified herein. The results set forth in this report are not indicative or representative of the quality or characteristics of the lot from which a test sample was taken or any similar or identical product unless specifically and expressly noted. Our report includes all of the tests requested by you and the results thereof based upon the information that you provided to us. Measurement uncertainty is only provided upon request for accredited tests. Statements of conformity are based on simple acceptance criteria without taking measurement uncertainty into account, unless otherwise requested in writing. You have 60 days from date of issuance of this report to notify us of any material error or omission caused by our negligence or if you require measurement uncertainty; provided, however, that such notice shall be in writing and shall specifically address the issue you wish to raise. A failure to raise such issue within the prescribed time shall constitute your unqualified acceptance of the completeness of this report, the tests conducted and the correctness of the report contents.



TABLE OF CONTENTS

RELEASE CONTROL RECORD	4
1 SUMMARY OF TEST RESULTS	5
1.1 MEASUREMENT UNCERTAINTY	7
1.2 TEST SITE AND INSTRUMENTS	8
2 GENERAL INFORMATION	10
2.1 GENERAL DESCRIPTION OF EUT	10
2.2 CONFIGURATION OF SYSTEM UNDER TEST	15
2.3 DESCRIPTION OF SUPPORT UNITS	16
2.4 TEST ITEM AND TEST CONFIGURATION	16
2.5 GENERAL DESCRIPTION OF APPLIED STANDARDS	22
3 TEST TYPES AND RESULTS	23
3.1 OUTPUT POWER MEASUREMENT	23
3.1.1 LIMITS OF OUTPUT POWER MEASUREMENT	23
3.1.2 TEST PROCEDURES	23
3.1.3 TEST SETUP	25
3.1.4 TEST RESULTS	26
3.2 FREQUENCY STABILITY MEASUREMENT	62
3.2.1 LIMITS OF FREQUENCY STABILITY MEASUREMENT	62
3.2.2 TEST PROCEDURE	62
3.2.3 TEST SETUP	62
3.2.4 TEST RESULTS	63
3.3 OCCUPIED BANDWIDTH MEASUREMENT	64
3.3.1 LIMITS OF OCCUPIED BANDWIDTH MEASUREMENT	64
3.3.2 TEST SETUP	64
3.3.3 TEST PROCEDURES	64
3.3.4 TEST RESULTS	65
3.4 BAND EDGE MEASUREMENT	66
3.4.1 LIMITS OF BAND EDGE MEASUREMENT	66
3.4.2 TEST SETUP	68
3.4.3 TEST PROCEDURES	69
3.4.4 TEST RESULTS	70
3.5 CONDUCTED SPURIOUS EMISSIONS	71
3.5.1 LIMITS OF CONDUCTED SPURIOUS EMISSIONS MEASUREMENT	71
3.5.2 TEST PROCEDURE	71
3.5.3 TEST SETUP	71
3.5.4 TEST RESULTS	72
3.6 RADIATED EMISSION MEASUREMENT	73
3.6.1 LIMITS OF RADIATED EMISSION MEASUREMENT	73
3.6.2 TEST PROCEDURES	73
3.6.3 DEVIATION FROM TEST STANDARD	73
3.6.4 TEST SETUP	74
3.6.5 TEST RESULTS	76
3.7 PEAK TO AVERAGE RATIO	132
3.7.1 LIMITS OF PEAK TO AVERAGE RATIO MEASUREMENT	132
3.7.2 TEST SETUP	132
3.7.3 TEST PROCEDURES	132
3.7.4 TEST RESULTS	133
4 INFORMATION ON THE TESTING LABORATORIES	134



**BUREAU
VERITAS**

Test Report No.: W7L-P23100014RF06

5 MODIFICATIONS RECORDERS FOR ENGINEERING CHANGES TO THE EUT BY THE LAB.	135
6 APPENDIX	136
WCDMA BAND4	136
LTE BAND7	149
LTE BAND12 (INCLUDING B17).....	240
LTE BAND13	342
LTE BAND30	396
LTE BAND71	433



Test Report No.: W7L-P23100014RF06

RELEASE CONTROL RECORD

ISSUE NO.	REASON FOR CHANGE	DATE ISSUED
W7L-P22110036RF06	Original release	Feb. 07, 2023
W7L-P23100014RF06	Based on the original product changing the model name and FCC ID, brand name, marketing name, product name, battery model, applicant and manufacturer information.	Oct. 23, 2023



1 SUMMARY OF TEST RESULTS

The EUT has been tested according to the following specifications:

APPLIED STANDARD: FCC PART 27 & PART 2			
STANDARD SECTION	TEST TYPE AND LIMIT	RESULT	TEST LAB*
§2.1046	Conducted Output Power	Compliance	A
§27.50(b)(10) §27.50(c)(10)	Effective Radiated Power (Band 12) (Band 13) (Band 17) (Band 71)	Compliance	A
§27.50(d)(4) §27.50(h)(2) §27.50(a)(3)	Equivalent Isotropically Radiated Power (WCMDA Band 4)(Band 7)(Band 30)	Compliance	A
§2.1055 §27.54	Frequency Stability	Compliance	A
§2.1049	Occupied Bandwidth	Compliance	A
§2.1051 §27.53(c)(2)(4) §27.53(g) §27.53(h) §27.53(m)(4)(6) §27.53(a)(4)	Conducted Band Edge Measurements (WCMDA Band 4) (Band 7) (Band 12) (Band 13) (Band 17) (Band 30) (Band 71)	Compliance	A
§2.1051 §27.53(c)(2)(4) §27.53(g) §27.53(h) §27.53(m)(4)(6) §27.53(a)(4)	Conducted Spurious Emissions (WCMDA Band 4)(Band 7) (Band 12) (Band 13) (Band 17) (Band 30) (Band 71)	Compliance	A
§2.1053 §27.53(c)(2)(4) §27.53(f) §27.53(g) §27.53(h) §27.53(m)(4)(6) §27.53(a)(4)	Radiated Spurious Emissions (WCMDA Band 4)(Band 7) (Band 12) (Band 13) (Band 17) (Band 30) (Band 71)	Compliance	A/B
NA	Peak to average ratio	Compliance	A



Test Report No.: W7L-P23100014RF06

***Test Lab Information Reference**

Lab A:

BV 7Layers Communications Technology (Shenzhen) Co., Ltd

Lab Address:

No.B102, Dazu Chuangxin Mansion, North of Beihuan Avenue, North Area, Hi-Tech Industrial Park, Nanshan District, Shenzhen, Guangdong, China

Accredited Test Lab Cert 3939.01

The FCC Site Registration No. : 525120; Designation No. : CN1171;

Lab B:

Huarui 7Layers High Technology (Suzhou) Co., Ltd.

Lab Address:

Tower N, Innovation Center, 88 Zhuyi Road, High-tech District, Suzhou City, Anhui Province

Accredited Test Lab Cert 6613.01

The FCC Site Registration No. is 434559; The Designation No. is CN1325.

1.1 MEASUREMENT UNCERTAINTY

Where relevant, the following measurement uncertainty levels have been estimated for tests performed on the EUT as specified in CISPR 16-4-2:

MEASUREMENT	UNCERTAINTY
Frequency Stability	±76.97Hz
Radiated emissions (9KHz~30MHz)	±2.68dB
Radiated emissions & Radiated Power (30MHz~1GHz)	±4.98dB
Radiated emissions & Radiated Power (1GHz ~6GHz)	±4.70dB
Radiated emissions (6GHz ~18GHz)	±4.60dB
Radiated emissions (18GHz ~40GHz)	±4.12dB
Conducted emissions	±4.01dB
Occupied Channel Bandwidth	±43.58KHz
Conducted Output power	±2.06dB
Band Edge Measurements	±4.70dB

This uncertainty represents an expanded uncertainty expressed at approximately the 95% confidence level using a coverage factor of k=2.



1.2 TEST SITE AND INSTRUMENTS

Equipment	Manufacturer	Model No.	Serial No.	Last Cal.	Next Cal.
MXE EMI Receiver	KEYSIGHT	N9038A-544	MY54450026	Feb. 21,22	Feb. 20,23
EXA Signal Analyzer	KEYSIGHT	N9010A-544	MY54510355	May.15,22	May.14,23
Loop Antenna	Schwarzbeck	FMZB 1519B	00173	Sep.04,22	Sep.03,23
Bilog Antenna	ETS-LINDGRE N	3143B	00161965	Mar. 06,22	Mar. 05,23
Horn Antenna	ETS-LINDGRE N	3117	00168692	Mar. 06,22	Mar. 05,23
Horn Antenna (18GHz-40GHz)	N/A	QWH-SL-18-40-K- SG/QMS-00361	15433	Aug. 24, 22	Aug. 23, 23
Radio Communication Analyzer	ANRITSU	MT8820C	6201465426	Feb. 15,22	Feb. 14,23
Signal Pre-Amplifier	EMSI	EMC 9135	980249	May.12,22	May.11,23
Signal Pre-Amplifier	EMSI	EMC 012645B	980257	May.12,22	May.11,23
Signal Pre-Amplifier	EMSI	EMC 184045B	980259	Feb. 21,22	Feb.20,23
3m Semi-anechoic Chamber	ETS-LINDGRE N	9m*6m*6m	Euroshieldpn- CT0001143-121 6	May. 19,20	May. 18,23
Test Software	E3	V 9.160323	N/A	N/A	N/A
Test Software	JS1120	3.1.36	N/A	N/A	N/A
10dB Attenuator	JFW/USA	50HF-010-SMA	1505	May. 07,22	May. 06,23
Power Meter	Anritsu	ML2495A	1506002	Feb. 22,22	Feb. 21,23
Power Sensor	Anritsu	MA2411B	1339352	May. 07,22	May. 06,23
Temperature Chamber	ESPEC	SH-242	93000855	May. 12,22	May. 11,23
MXG Analog Microvave Signal Generator	KEYSIGHT	N5183A	MY50143024	Feb. 18,22	Feb. 17,23
Base station R&S CMW500	Rohde&Schwa rz	CMW500	153085	May.12,22	May.11,23
DC Source	Kikusui/JP	PMX18-5A	0000001	Aug. 24,22	Aug. 23,23

- NOTE:**
1. The calibration interval of the above test instruments is 12 months or 36 months and the calibrations are traceable to CEPREI/CHINA, GRGT/CHINA and NIM/CHINA.
 2. The test was performed in 3m Semi-anechoic Chamber and RF Oven Room.
 3. The horn antenna is used only for the measurement of emission frequency above 1GHz if tested.
 4. The FCC Site Registration No. is 525120; The Designation No. is CN1171.



BUREAU
VERITAS

Test Report No.: W7L-P23100014RF06

Equipment	Manufacturer	Model No.	Serial No.	Last Cal.	Next Cal.
Pre-Amplifier	R&S	SCU18F1	100815	Aug.30,22	Aug.29,24
Pre-Amplifier	R&S	SCU08F1	101028	Sep.16,22	Sep.15,24
Vector Signal Generator	R&S	SMBV100B	102176	Feb.16,22	Feb.15,24
Signal Generator	R&S	SMB100A	182185	Feb.16,22	Feb.15,24
3m Fully-anechoic Chamber	TDK	9m*6m*6m	HRSW-SZ-EMC-01Chamber	Nov.25,22	Nov.24,25
3m Semi-anechoic Chamber	TDK	9m*6m*6m	HRSW-SZ-EMC-02Chamber	Nov.25,22	Nov.24,25
EMI TEST Receiver	R&S	ESR26	101734	Feb.25,22	Feb.24,24
EMI TEST Receiver	R&S	ESW44	101973	Feb.25,22	Feb.24,24
Bilog Antenna	SCHWARZBECK	VULB 9163	1264	Feb.28,22	Feb.27,24
Horn Antenna	ETS-LINDGREN	3117	227836	Aug.22,22	Aug.21,24
Horn Antenna (18GHz-40GHz)	Steatite Q-par Antennas	QMS 00880	23486	Feb.23,22	Feb.22,24
Horn Antenna	Steatite Q-par Antennas	QMS 00208	23485	Aug.22,22	Aug.21,24
Loop Antenna	SCHWARZ	HFH2-Z2/Z2E	100976	Feb.23,22	Feb.22,24
WIDEBANDRADIO COMMUNICATION TESTER	R&S	CMW500	169399	Jun.27,22	Jun.26,24
Test Software	EMC32	EMC32	N/A	N/A	N/A
Test Software	ELEKTRA	ELEKTRA4.32	N/A	N/A	N/A
Open Switch and Control Unit	R&S	OSP220	101964	Oct.01,22	Sep.30,24
DC Source	HYELEC	HY3010B	551016	Aug.31,22	Aug.30,24
Hygrothermograph	DELI	20210528	SZ014	Sep.06,22	Sep.05,24
PC	LENOVO	E14	HRSW0024	N/A	N/A
TMC-AMI18843A(CABLE)	R&S	HF290-NMNM-7.00M	N/A	N/A	N/A
TMC-AMI18843A(CABLE)	R&S	HF290-NMNM-4.00M	N/A	N/A	N/A
CABLE	R&S	W13.02	N/A	Oct.31,22	Apr.29,23
CABLE	R&S	W12.14	N/A	Oct.31,22	Apr.29,23
CABLE	R&S	J12J103539-00-1	SEP-03-20-069	Oct.31,22	Apr.29,23
CABLE	R&S	J12J103539-00-1	SEP-03-20-070	Oct.31,22	Apr.29,23
Temperature Chamber	votsch	VT4002	58566078100050	May.31,22	May.30,24

- NOTE:**
1. The calibration interval of the above test instruments is 12 months or 36 months and the calibrations are traceable to CEPREI/CHINA, GRGT/CHINA and NIM/CHINA.
 2. The test was performed in 3m Semi-anechoic Chamber and RF Oven Room.
 3. The horn antenna is used only for the measurement of emission frequency above 1GHz if tested.
 4. The FCC Site Registration No. is 434559; The Designation No. is CN1325.

2 GENERAL INFORMATION

2.1 GENERAL DESCRIPTION OF EUT

PRODUCT	Nokia Industrial 5G handheld HHRA501x	
BRAND NAME	Nokia	
MODEL NAME	HHRA501a	
MARKETING NAME	Nokia Industrial 5G handheld HHRA501a	
NOMINAL VOLTAGE	5.0Vdc(adapter or host equipment) 3.7Vdc (Li-ion, battery)	
MODULATION TECHNOLOGY	WCDMA IV	BPSK, QPSK
	LTE	QPSK, 16QAM, 64QAM
FREQUENCY RANGE	WCDMA IV	1712.4MHz ~ 1752.6MHz
	LTE Band 7 Channel Bandwidth: 5MHz	2502.5MHz ~ 2567.5MHz
	LTE Band 7 Channel Bandwidth: 10MHz	2505MHz ~ 2565MHz
	LTE Band 7 Channel Bandwidth: 15MHz	2507.5MHz ~ 2562.5MHz
	LTE Band 7 Channel Bandwidth: 20MHz	2510MHz ~ 2560MHz
	LTE Band 12 Channel Bandwidth: 1.4MHz	699.7MHz ~ 715.3MHz
	LTE Band 12 Channel Bandwidth: 3MHz	700.5MHz ~ 714.5MHz
	LTE Band 12 Channel Bandwidth: 5MHz	701.5MHz ~ 713.5MHz
	LTE Band 12 Channel Bandwidth: 10MHz	704MHz ~ 711MHz
	LTE Band 13 Channel Bandwidth: 5MHz	779.5MHz ~ 784.5MHz
	LTE Band 13 Channel Bandwidth: 10MHz	782MHz
	LTE Band 17 Channel Bandwidth: 5MHz	706.5MHz ~ 713.5MHz
	LTE Band 17 Channel Bandwidth: 10MHz	709MHz ~ 711 MHz
	LTE Band 30 Channel Bandwidth: 5MHz	2307.5MHz ~ 2312.5MHz
	LTE Band 30 Channel Bandwidth: 10MHz	2310MHz
	LTE Band 71 Channel Bandwidth: 5MHz	665.5MHz ~ 695.5MHz
	LTE Band 71 Channel Bandwidth: 10MHz	668MHz ~ 693MHz



Test Report No.: W7L-P23100014RF06

FREQUENCY RANGE	LTE Band 71 Channel Bandwidth: 15MHz	670.5MHz ~ 690.5MHz
	LTE Band 71 Channel Bandwidth: 20MHz	673MHz ~ 688MHz
MAX. EIRP POWER	WCDMA IV	236.05mW
	LTE Band 7 Channel Bandwidth: 5MHz	146.55mW
	LTE Band 7 Channel Bandwidth: 10MHz	145.21mW
	LTE Band 7 Channel Bandwidth: 15MHz	146.89mW
	LTE Band 7 Channel Bandwidth: 20MHz	147.91mW
	LTE Band 12 Channel Bandwidth: 1.4MHz	59.16mW
	LTE Band 12 Channel Bandwidth: 3MHz	59.16mW
	LTE Band 12 Channel Bandwidth: 5MHz	59.7mW
	LTE Band 12 Channel Bandwidth: 10MHz	59.84mW
	LTE Band 13 Channel Bandwidth: 5MHz	56.1mW
	LTE Band 13 Channel Bandwidth: 10MHz	56.23mW
	LTE Band 17 Channel Bandwidth: 5MHz	63.68mW
	LTE Band 17 Channel Bandwidth: 10MHz	63.83mW
	LTE Band 30 Channel Bandwidth: 5MHz	112.98mW
	LTE Band 30 Channel Bandwidth: 10MHz	114.02mW
	LTE Band 71 Channel Bandwidth: 5MHz	22.96mW
	LTE Band 71 Channel Bandwidth: 10MHz	23.17mW
	LTE Band 71 Channel Bandwidth: 15MHz	23.07mW
	LTE Band 71 Channel Bandwidth: 20MHz	23.39mW
	EMISSION DESIGNATOR	WCDMA IV



Test Report No.: W7L-P23100014RF06

EMISSION DESIGNATOR	LTE Band 7 Channel Bandwidth: 5MHz	QPSK: 4M50G7D
		16QAM: 4M50W7D
		64QAM: 4M50W7D
	LTE Band 7 Channel Bandwidth: 10MHz	QPSK: 8M99G7D
		16QAM: 8M98W7D
		64QAM: 8M98W7D
	LTE Band 7 Channel Bandwidth: 15MHz	QPSK: 13M5G7D
		16QAM: 13M5W7D
		64QAM: 13M5W7D
	LTE Band 7 Channel Bandwidth: 20MHz	QPSK: 18M0G7D
		16QAM: 17M9W7D
		64QAM: 17M9W7D
	LTE Band 12 Channel Bandwidth: 1.4MHz	QPSK: 1M14G7D
		16QAM: 1M09W7D
		64QAM: 1M09W7D
	LTE Band 12 Channel Bandwidth: 3MHz	QPSK: 2M70G7D
		16QAM: 2M69W7D
		64QAM: 2M70W7D
	LTE Band 12 Channel Bandwidth: 5MHz	QPSK: 4M52G7D
		16QAM: 4M51W7D
		64QAM: 4M51W7D
	LTE Band 12 Channel Bandwidth: 10MHz	QPSK: 8M98G7D
		16QAM: 8M96W7D
		64QAM: 8M95W7D
LTE Band 13 Channel Bandwidth: 5MHz	QPSK: 4M51G7D	
	16QAM: 4M51W7D	
	64QAM: 4M51W7D	
LTE Band 13 Channel Bandwidth: 10MHz	QPSK: 8M94G7D	
	16QAM: 8M92W7D	
	64QAM: 8M92W7D	



Test Report No.: W7L-P23100014RF06

EMISSION DESIGNATOR	LTE Band 30 Channel Bandwidth: 5MHz	QPSK: 4M51G7D
		16QAM: 4M51W7D
		64QAM: 4M50W7D
	LTE Band 30 Channel Bandwidth: 10MHz	QPSK: 9M01G7D
		16QAM: 8M99W7D
		64QAM: 8M99W7D
	LTE Band 71 Channel Bandwidth: 5MHz	QPSK: 4M51G7D
		16QAM: 4M51W7D
		64QAM: 4M50W7D
	LTE Band 71 Channel Bandwidth: 10MHz	QPSK: 8M99G7D
		16QAM: 8M98W7D
		64QAM: 8M99W7D
LTE Band 71 Channel Bandwidth: 15MHz	QPSK: 13M4G7D	
	16QAM: 13M5W7D	
	64QAM: 13M5W7D	
CLTE Band 71 Channel Bandwidth: 20MHz	QPSK: 17M9G7D	
	16QAM: 17M9W7D	
	64QAM: 17M9W7D	
ANTENNA TYPE	PIFA Antenna with 0.4dBi gain for WCDMA IV PIFA Antenna with -1.5dBi gain for LTE7 PIFA Antenna with -2.5dBi gain for LTE12 PIFA Antenna with -3dBi gain for LTE13 PIFA Antenna with -2.5dBi gain for LTE17 PIFA Antenna with -2.8dBi gain for LTE30 PIFA Antenna with -7dBi gain for LTE71	
HW VERSION	V02	
SW VERSION	IS540_ROW_00.00_1_20221017	
I/O PORTS	Refer to user's manual	
CABLE SUPPLIED	USB cable1: non-shielded cable, with w/o ferrite core, 1.0 meter USB cable2: non-shielded cable, with w/o ferrite core, 1.0 meter	
EXTREME TEMPERATURE	-10-50 °C	
EXTREME VOLTAGE	3.6V - 4.2V	

NOTE:

1. For a more detailed features description, please refer to the manufacturer's specifications or the user's manual.
2. The EUT incorporates a SISO function. Physically, the EUT provides one completed transmitter and one receiver.



Test Report No.: W7L-P23100014RF06

MODULATION MODE	TX FUNCTION
WCDMA	1TX/1RX
LTE	1TX/1RX

3. For the test results, the EUT had been tested with all conditions. But only the worst case was shown in test report.

List of Accessory:

ACCESSORIES	BRAND	MANUFACTURER	MODEL	SPECIFICATION
Battery	N/A	FPR Connectivity Technology Inc.	BL440ACP	Capacity: 3.7Vdc, 4400mAh
AC Adapter	N/A	SHENZHEN SHI YINGYUAN POWER SUPPLY TECHNOLOGY CO., LTD.	ICP12-050-2000B	I/P: 100-240Vac, 0.3A, O/P: 5.0Vdc, 2A
USB Cable 1	N/A	Winpower Technology Co., LTD	PROTECTOR 2.0	Signal Line,1.0meter
USB Cable 2	N/A	Winpower Technology Co., LTD	USB2.0	Signal Line,1.0meter

2.2 CONFIGURATION OF SYSTEM UNDER TEST

FOR RADIATION EMISSION TEST

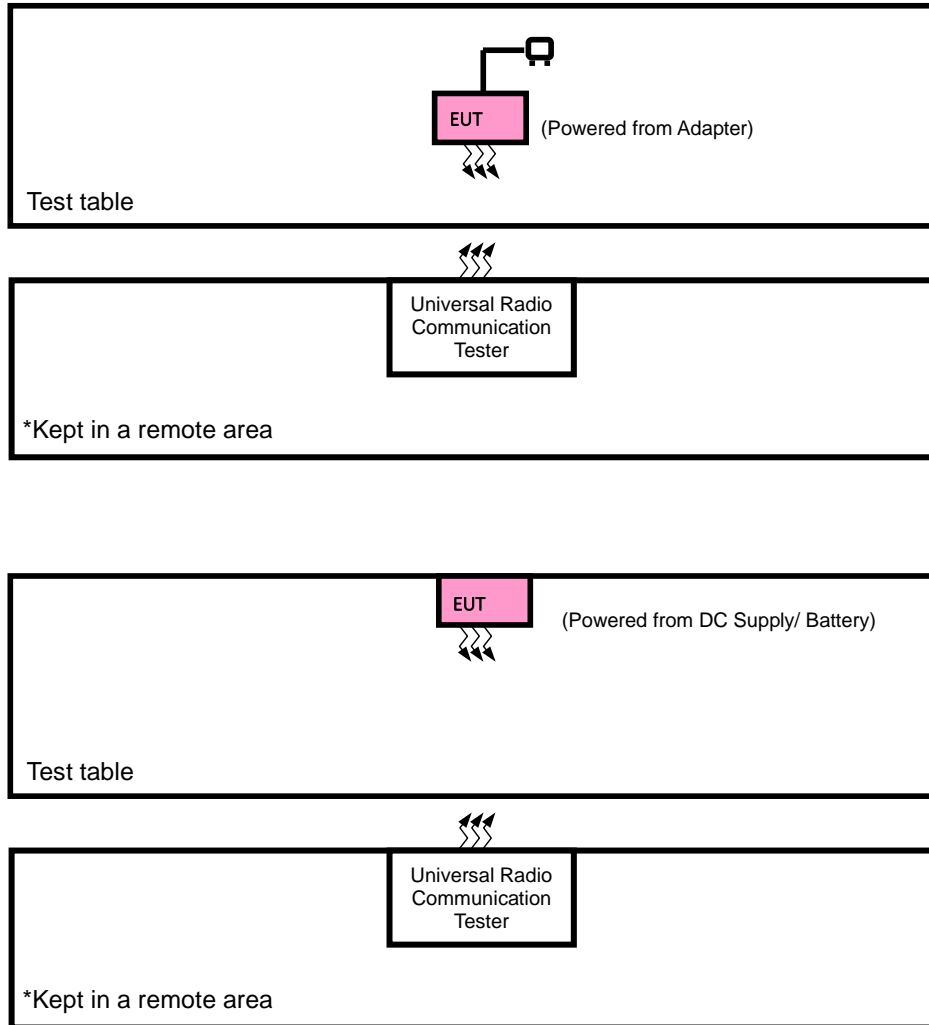

2.3 DESCRIPTION OF SUPPORT UNITS

The EUT has been tested as an independent unit together with other necessary accessories or support units. The following support units or accessories were used to form a representative test configuration during the tests.

NO.	PRODUCT	BRAND	MODEL NO.	SERIAL NO.	FCC ID
1	DC source	LONG WEI	PS-6403D	010934269	N/A

NO.	SIGNAL CABLE DESCRIPTION OF THE ABOVE SUPPORT UNITS
1	DC Line: Unshielded, Detachable 1.8m

2.4 TEST ITEM AND TEST CONFIGURATION

Pre-Scan has been conducted to determine the worst-case mode from all possible combinations between available modulations, data rates, XYZ axis and antenna ports. The worst case was found when positioned on Y-plane for EIRP and X-axis for radiated emission. Following channel(s) was (were) selected for the final test as listed below:

EUT CONFIGURE MODE	DESCRIPTION
A	EUT + Adapter + USB Cable with WCDMA or LTE link
B	EUT + DC Supply with WCDMA or LTE link

WCDMA MODE

EUT CONFIGURE MODE	TEST ITEM	AVAILABLE CHANNEL	TESTED CHANNEL	MODE
A	EIRP	1312 to 1513	1312, 1413, 1513	WCDMA
B	FREQUENCY STABILITY	1312 to 1513	1312, 1413, 1513	WCDMA
A	OCCUPIED BANDWIDTH	1312 to 1513	1312, 1413, 1513	WCDMA
A	BAND EDGE	1312 to 1513, 1413, 1513	1312, 1513	WCDMA
A	PEAK TO AVERAGE RATIO	1312 to 1513	1312, 1413, 1513	WCDMA
A	CONDUCTED EMISSION	1312 to 1513	1312, 1413, 1513	WCDMA
A	RADIATED EMISSION	1312 to 1513	1312, 1413, 1513	WCDMA



Test Report No.: W7L-P23100014RF06

LTE BAND 7 MODE

EUT CONFIGURE MODE	TEST ITEM	AVAILABLE CHANNEL	TESTED CHANNEL	CHANNEL BANDWIDTH	MODULATION	MODE		
A	EIRP	20775 to 21425	20775, 21100, 21425	5MHz	QPSK, 16QAM, 64QAM	1 RB / 0 RB Offset		
		20800 to 21400	20800, 21100, 21400	10MHz	QPSK, 16QAM, 64QAM	1 RB / 0RB Offset		
		20825 to 21375	20825, 21100, 21375	15MHz	QPSK, 16QAM, 64QAM	1 RB / 0 RB Offset		
		20850 to 21350	20850, 21100, 21350	20MHz	QPSK, 16QAM, 64QAM	1 RB / 0 RB Offset		
B	FREQUENCY STABILITY	20775 to 21425	20775, 21100, 21425	5MHz	QPSK, 16QAM, 64QAM	25 RB / 0 RB Offset		
		20800 to 21400	20800, 21100, 21400	10MHz	QPSK, 16QAM, 64QAM	50 RB / 0 RB Offset		
		20825 to 21375	20825, 21100, 21375	15MHz	QPSK, 16QAM, 64QAM	75 RB / 0 RB Offset		
		20850 to 21350	20850, 21100, 21350	20MHz	QPSK, 16QAM, 64QAM	100 RB / 0 RB Offset		
A	OCCUPIED BANDWIDTH	20775 to 21425	20775, 21100, 21425	5MHz	QPSK, 16QAM, 64QAM	25 RB / 0 RB Offset		
		20800 to 21400	20800, 21100, 21400	10MHz	QPSK, 16QAM, 64QAM	50 RB / 0 RB Offset		
		20825 to 21375	20825, 21100, 21375	15MHz	QPSK, 16QAM, 64QAM	75 RB / 0 RB Offset		
		20850 to 21350	20850, 21100, 21350	20MHz	QPSK, 16QAM, 64QAM	100 RB / 0 RB Offset		
A	PEAK TO AVERAGE RATIO	20775 to 21425	20775, 21100, 21425	5MHz	QPSK, 16QAM, 64QAM	1 RB / 0 RB Offset 25 RB / 0 RB Offset		
		20800 to 21400	20800, 21100, 21400	10MHz	QPSK, 16QAM, 64QAM	1 RB / 0 RB Offset 50 RB / 0 RB Offset		
		20825 to 21375	20825, 21100, 21375	15MHz	QPSK, 16QAM, 64QAM	1 RB / 0 RB Offset 75 RB / 0 RB Offset		
		20850 to 21350	20850, 21100, 21350	20MHz	QPSK, 16QAM, 64QAM	1 RB / 0 RB Offset 100 RB / 0 RB Offset		
A	BAND EDGE	20775 to 21425	20775	5MHz	QPSK, 16QAM, 64QAM	1 RB / 0 RB Offset 25 RB / 0 RB Offset		
			21425	5MHz	QPSK, 16QAM, 64QAM	1 RB / 24 RB Offset 25 RB / 0 RB Offset		
		20800 to 21400	20800	10MHz	QPSK, 16QAM, 64QAM	1 RB / 0 RB Offset 50 RB / 0 RB Offset		
			21400	10MHz	QPSK, 16QAM, 64QAM	1 RB / 49 RB Offset 50 RB / 0 RB Offset		
		20825 to 21375	20825	15MHz	QPSK, 16QAM, 64QAM	1 RB / 0 RB Offset 75 RB / 0 RB Offset		
			21375	15MHz	QPSK, 16QAM, 64QAM	1 RB / 74 RB Offset 75 RB / 0 RB Offset		
		20850 to 21350	20850	20MHz	QPSK, 16QAM, 64QAM	1 RB / 0 RB Offset 100 RB / 0 RB Offset		
			21350	20MHz	QPSK, 16QAM, 64QAM	1 RB / 99 RB Offset 100 RB / 0 RB Offset		
		A	CONDUCTED EMISSION	20775 to 21425	20775, 21100, 21425	5MHz	QPSK, 16QAM, 64QAM	1 RB / 0 RB Offset
				20800 to 21400	20800, 21100, 21400	10MHz	QPSK, 16QAM, 64QAM	1 RB / 0RB Offset
				20825 to 21375	20825, 21100, 21375	15MHz	QPSK, 16QAM, 64QAM	1 RB / 0 RB Offset
				20850 to 21350	20850, 21100, 21350	20MHz	QPSK, 16QAM, 64QAM	1 RB / 0 RB Offset
A	RADIATED EMISSION	20775 to 21425	20775, 21100, 21425	5MHz	QPSK	1 RB / 0 RB Offset		
		20800 to 21400	21100	10MHz	QPSK	1 RB / 0 RB Offset		
		20825 to 21375	21100	15MHz	QPSK	1 RB / 0 RB Offset		
		20850 to 21350	21100	20MHz	QPSK	1 RB / 0 RB Offset		

Note: This device was tested under all bandwidths, RB configurations and modulations. The worst case was found in QPSK modulation.



Test Report No.: W7L-P23100014RF06

LTE BAND 12 MODE

EUT CONFIGURE MODE	TEST ITEM	AVAILABLE CHANNEL	TESTED CHANNEL	CHANNEL BANDWIDTH	MODULATION	MODE		
A	ERP	23017 to 23173	23017, 23095 , 23173	1.4MHz	QPSK, 16QAM, 64QAM	1 RB / 0 RB Offset		
		23025 to 23165	23025, 23095 ,23165	3MHz	QPSK, 16QAM, 64QAM	1 RB / 0 RB Offset		
		23035 to 23155	23035, 23095 ,23155	5MHz	QPSK, 16QAM, 64QAM	1 RB / 0 RB Offset		
		23060 to 23130	23060, 23095 ,23130	10MHz	QPSK, 16QAM, 64QAM	1 RB / 0 RB Offset		
B	FREQUENCY STABILITY	23017 to 23173	23017, 23095 , 23173	1.4MHz	QPSK, 16QAM, 64QAM	6 RB / 0 RB Offset		
		23025 to 23165	23025, 23095 ,23165	3MHz	QPSK, 16QAM, 64QAM	15 RB / 0 RB Offset		
		23035 to 23155	23035, 23095 ,23155	5MHz	QPSK, 16QAM, 64QAM	25 RB / 0 RB Offset		
		23060 to 23130	23060, 23095 ,23130	10MHz	QPSK, 16QAM, 64QAM	50 RB / 0 RB Offset		
A	OCCUPIED BANDWIDTH	23017 to 23173	23017, 23095 , 23173	1.4MHz	QPSK, 16QAM, 64QAM	6 RB / 0 RB Offset		
		23025 to 23165	23025, 23095 ,23165	3MHz	QPSK, 16QAM, 64QAM	15 RB / 0 RB Offset		
		23035 to 23155	23035, 23095 ,23155	5MHz	QPSK, 16QAM, 64QAM	25 RB / 0 RB Offset		
		23060 to 23130	23060, 23095 ,23130	10MHz	QPSK, 16QAM, 64QAM	50 RB / 0 RB Offset		
A	PEAK TO AVERAGE RATIO	23017 to 23173	23017, 23095 , 23173	1.4MHz	QPSK, 16QAM, 64QAM	1 RB / 0 RB Offset 6 RB / 0 RB Offset		
		23025 to 23165	23025, 23095 ,23165	3MHz	QPSK, 16QAM, 64QAM	1 RB / 0 RB Offset 15 RB / 0 RB Offset		
		23035 to 23155	23035, 23095 ,23155	5MHz	QPSK, 16QAM, 64QAM	1 RB / 0 RB Offset 25 RB / 0 RB Offset		
		23060 to 23130	23060, 23095 ,23130	10MHz	QPSK, 16QAM, 64QAM	1 RB / 0 RB Offset 50 RB / 0 RB Offset		
A	BAND EDGE	23017 to 23173	23017	1.4MHz	QPSK, 16QAM, 64QAM	1 RB / 0 RB Offset 6 RB / 0 RB Offset		
			23173	1.4MHz	QPSK, 16QAM, 64QAM	1 RB / 5 RB Offset 6 RB / 0 RB Offset		
		23025 to 23165	23025	3MHz	QPSK, 16QAM, 64QAM	1 RB / 0 RB Offset 15 RB / 0 RB Offset		
			23165	3MHz	QPSK, 16QAM, 64QAM	1 RB / 14 RB Offset 15 RB / 0 RB Offset		
		23035 to 23155	23035	5MHz	QPSK, 16QAM, 64QAM	1 RB / 0 RB Offset 25 RB / 0 RB Offset		
			23155	5MHz	QPSK, 16QAM, 64QAM	1 RB / 24 RB Offset 25 RB / 0 RB Offset		
		23060 to 23130	23060	10MHz	QPSK, 16QAM, 64QAM	1 RB / 0 RB Offset 50 RB / 0 RB Offset		
			23130	10MHz	QPSK, 16QAM, 64QAM	1 RB / 49 RB Offset 50 RB / 0 RB Offset		
		A	CONDCUDED EMISSION	23017 to 23173	23017, 23095 , 23173	1.4MHz	QPSK, 16QAM, 64QAM	1 RB / 0 RB Offset
				23025 to 23165	23025, 23095 ,23165	3MHz	QPSK, 16QAM, 64QAM	1 RB / 0 RB Offset
				23035 to 23155	23035, 23095 ,23155	5MHz	QPSK, 16QAM, 64QAM	1 RB / 0 RB Offset
				23060 to 23130	23060, 23095 ,23130	10MHz	QPSK, 16QAM, 64QAM	1 RB / 0 RB Offset
A	RADIATED EMISSION	23017 to 23173	23095	1.4MHz	QPSK	1 RB / 0 RB Offset		
		23025 to 23165	23095	3MHz	QPSK	1 RB / 0 RB Offset		
		23035 to 23155	23095	5MHz	QPSK	1 RB / 0 RB Offset		
		23060 to 23130	23060, 23095 ,23130	10MHz	QPSK	1 RB / 0 RB Offset		

Note: This device was tested under all bandwidths, RB configurations and modulations. The worst case was found in QPSK modulation.



LTE BAND 13 MODE

EUT CONFIGURE MODE	TEST ITEM	AVAILABLE CHANNEL	TESTED CHANNEL	CHANNEL BANDWIDTH	MODULATION	MODE
A	ERP	23205 to 23255	20025, 20175, 20325	5MHz	QPSK,16QAM,64QAM	1 RB / 0 RB Offset
		23230	23230	10MHz	QPSK,16QAM,64QAM	1 RB / 0 RB Offset
B	FREQUENCY STABILITY	23205 to 23255	20025, 20325	5MHz	QPSK,16QAM,64QAM	25 RB / 0 RB Offset
		23230	23230	10MHz	QPSK,16QAM,64QAM	50 RB / 0 RB Offset
A	OCCUPIED BANDWIDTH	23205 to 23255	20025, 20175, 20325	5MHz	QPSK,16QAM,64QAM	25 RB / 0 RB Offset
		23230	23230	10MHz	QPSK,16QAM,64QAM	50 RB / 0 RB Offset
A	PEAK TO AVERAGE RATIO	23205 to 23255	20025, 20175, 20325	5MHz	QPSK,16QAM,64QAM	1 RB / 0 RB Offset 25 RB / 0 RB Offset
		23230	23230	10MHz	QPSK,16QAM,64QAM	1 RB / 0 RB Offset 50 RB / 0 RB Offset
A	BAND EDGE	23205 to 23255	23250	5MHz	QPSK,16QAM, 64QAM	1 RB / 0 RB Offset 25 RB / 0 RB Offset
			23255	5MHz	QPSK,16QAM, 64QAM	1 RB / 24 RB Offset 25 RB / 0 RB Offset
		23230	23230	10MHz	QPSK,16QAM, 64QAM	1 RB / 0 RB Offset
						1 RB / 49 RB Offset
						50 RB / 0 RB Offset
						50 RB / 0 RB Offset
A	CONDCUDED EMISSION	23205 to 23255	20025, 20175, 20325	5MHz	QPSK,16QAM,64QAM	1 RB / 0 RB Offset
		23230	23230	10MHz	QPSK,16QAM,64QAM	1 RB / 0 RB Offset
A	RADIATED EMISSION	23205 to 23255	23230	5MHz	QPSK	1 RB / 0 RB Offset
		23230	23230	10MHz	QPSK	1 RB / 0 RB Offset

Note: This device was tested under all bandwidths, RB configurations and modulations. The worst case was found in QPSK modulation.



LTE BAND 17 MODE

EUT CONFIGURE MODE	TEST ITEM	AVAILABLE CHANNEL	TESTED CHANNEL	CHANNEL BANDWIDTH	MODULATION	MODE
A	ERP	23755 to 23825	23755, 23790, 23825	5MHz	QPSK,16QAM,64QAM	1 RB / 0 RB Offset
		23780 to 23800	23780, 23790, 23800	10MHz	QPSK,16QAM,64QAM	1 RB / 0 RB Offset

Note: 1.This device was tested under all bandwidths, RB configurations and modulations. The worst case was found in QPSK modulation.

2. LTE Band 17 are covered by LTE Band 12, Because it is a subset of LTE Band 12 with the same output power and supported bandwidths, So the conducted test data and RSE test data please refer to LTE Band 12

LTE BAND 30

EUT CONFIGURE MODE	TEST ITEM	AVAILABLE CHANNEL	TESTED CHANNEL	CHANNEL BANDWIDTH	MODULATION	MODE
A	ERP	27685 to 27735	27685, 27710, 27735	5MHz	QPSK,16QAM,64QAM	1 RB / 0 RB Offset
		27710	27710	10MHz	QPSK,16QAM,64QAM	1 RB / 0 RB Offset
B	FREQUENCY STABILITY	27685 to 27735	27685, 27735	5MHz	QPSK,16QAM,64QAM	25 RB / 0 RB Offset
		27710	27710	10MHz	QPSK,16QAM,64QAM	50 RB / 0 RB Offset
A	OCCUPIED BANDWIDTH	27685 to 27735	27685, 27710, 27735	5MHz	QPSK,16QAM,64QAM	25 RB / 0 RB Offset
		27710	27710	10MHz	QPSK,16QAM,64QAM	50 RB / 0 RB Offset
A	PEAK TO AVERAGE RATIO	27685 to 27735	27685, 27710, 27735	5MHz	QPSK,16QAM,64QAM	1 RB / 0 RB Offset 25 RB / 0 RB Offset
		27710	27710	10MHz	QPSK,16QAM,64QAM	1 RB / 0 RB Offset 50 RB / 0 RB Offset
A	BAND EDGE	27685 to 27735	27685	5MHz	QPSK,16QAM,64QAM	1 RB / 0 RB Offset 25 RB / 0 RB Offset
			27735	5MHz	QPSK,16QAM,64QAM	1 RB / 24 RB Offset 25 RB / 0 RB Offset
		27710	27710	10MHz	QPSK,16QAM,64QAM	1 RB / 0 RB Offset
						50 RB / 0 RB Offset
						1 RB / 49 RB Offset
						/
A	CONDCUDED EMISSION	27685 to 27735	27685, 27710, 27735	5MHz	QPSK,16QAM,64QAM	1 RB / 0 RB Offset
		27710	27710	10MHz	QPSK,16QAM,64QAM	1 RB / 0 RB Offset
A	RADIATED EMISSION	27685 to 27735	27685, 27710, 27735	5MHz	QPSK	1 RB / 0 RB Offset
		27710	27710	10MHz	QPSK	1 RB / 0 RB Offset

Note: This device was tested under all bandwidths, RB configurations and modulations. The worst case was found in QPSK modulation.



Test Report No.: W7L-P23100014RF06

TEST CONDITION:

TEST ITEM	ENVIRONMENTAL CONDITIONS	INPUT POWER	TESTED BY
ERP&EIRP	23deg. C, 70%RH	DC 5V By Adapter	Jace Hu
FREQUENCY STABILITY	23deg. C, 70%RH	DC 3.6V/3.7V/4.2V By DC Supply	James Fu
OCCUPIED BANDWIDTH	23deg. C, 70%RH	DC5V By Adapter	James Fu
BAND EDGE	23deg. C, 70%RH	DC 5V By Adapter	James Fu
CONDCUDETED EMISSION	23deg. C, 70%RH	DC5V By Adapter	James Fu
RADIATED EMISSION	23deg. C, 70%RH	DC5V By Adapter	Jace Hu
PEAK TO AVERAGE RATIO	23deg. C, 70%RH	DC5V By Adapter	James Fu



Test Report No.: W7L-P23100014RF06

2.5 GENERAL DESCRIPTION OF APPLIED STANDARDS

The EUT is a RF product. According to the specifications of the manufacturer, it must comply with the requirements of the following standards:

FCC 47 CFR Part 2

FCC 47 CFR Part 27

KDB 971168 D01 Power Meas License Digital Systems v03r01

ANSI/TIA/EIA-603-D

ANSI/TIA/EIA-603-E

ANSI C63.26-2015

NOTE: All test items have been performed and recorded as per the above standards.



3 TEST TYPES AND RESULTS

3.1 OUTPUT POWER MEASUREMENT

3.1.1 LIMITS OF OUTPUT POWER MEASUREMENT

The radiated peak output power shall be according to the specific rule Part 27.50(h)(2) that “User stations are limited to 2 watts” and 27.50(i) specific that “Peak transmit power must be measure over any interval of continuous transmission using instrumentation calibration in terms of rms-equivalent voltage.”

Fixed, mobile, and portable (hand-held) stations operating in the 1710-1755 MHz band and mobile and portable stations operating in the 1695-1710 MHz and 1755-1780 MHz bands are limited to 1 watt EIRP

According to the specific rule Part 27.50(b)(10) and 27.50(c)(10) Fixed, mobile, and Portable stations (hand-held devices) transmitting in the 698-746 MHz, 746-757 MHz, 776-788 MHz, and 805-806 MHz bands are limited to 3 watts ERP.

For mobile and portable stations transmitting in the 2305-2315 MHz band or the 2350-2360 MHz band, the average EIRP must not exceed 50 milliwatts within any 1 megahertz of authorized bandwidth, except that for mobile and portable stations compliant with 3GPP LTE standards or another advanced mobile broadband protocol that avoids concentrating energy at the edge of the operating band the average EIRP must not exceed 250 milliwatts within any 5 megahertz of authorized bandwidth but may exceed 50 milliwatts within any 1 megahertz of authorized bandwidth. For mobile and portable stations using time division duplexing (TDD) technology, the duty cycle must not exceed 38 percent in the 2305-2315 MHz and 2350-2360 MHz bands. Mobile and portable stations using FDD technology are restricted to transmitting in the 2305-2315 MHz band. Power averaging shall not include intervals in which the transmitter is off.

3.1.2 TEST PROCEDURES

EIRP MEASUREMENT:

Per KDB 971168 D01 Power Meas License Digital Systems v03r01 or subclause 5.2.5.5 of ANSI C63.26-2015, the relevant equation for determining the ERP or EIRP from the conducted RF output power measured using the guidance provided above is:

$$ERP \text{ or } EIRP = P_{Meas} + G_T - L_c$$

Where:

ERP or EIRP = effective radiated power or equivalent isotropically radiated power, respectively
(expressed in the same units as P_{Meas} , typically dBW or dBm);



Test Report No.: W7L-P23100014RF06

P_{Meas} = measured transmitter output power or PSD, in dBm or dBW;

G_{T} = gain of the transmitting antenna, in dBd (ERP) or dBi (EIRP);

L_{c} = signal attenuation in the connecting cable between the transmitter and antenna, in dB.

CONDUCTED POWER MEASUREMENT:

- a. The EUT was set up for the maximum power with LTE link data modulation and link up with simulator.
- b. Set the EUT to transmit under low, middle and high channel and record the power level shown on simulator.



Test Report No.: W7L-P23100014RF06

3.1.3 TEST SETUP

CONDUCTED POWER MEASUREMENT:

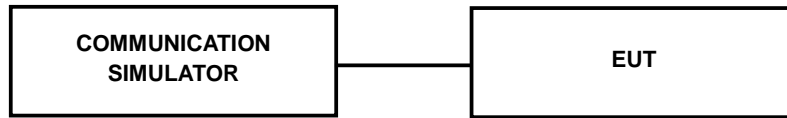

For the actual test configuration, please refer to the attached file (Test Setup Photo).



3.1.4 TEST RESULTS

AVERAGE CONDUCTED OUTPUT POWER (dBm)

Band	WCDMA IV		
	1312	1413	1513
Channel	1712.4	1732.6	1752.6
Frequency (MHz)	1712.4	1732.6	1752.6
RMC 12.2K	23.24	23.26	23.33
HSDPA Subtest-1	22.22	22.25	22.29
HSDPA Subtest-2	22.20	22.23	22.27
HSDPA Subtest-3	21.68	21.71	21.82
HSDPA Subtest-4	21.73	21.74	21.78
DC-HSDPA Subtest-1	22.23	22.22	22.30
DC-HSDPA Subtest-2	22.16	22.19	22.31
DC-HSDPA Subtest-3	21.71	21.75	21.77
DC-HSDPA Subtest-4	21.70	21.71	21.81
HSUPA Subtest-1	19.68	19.74	19.80
HSUPA Subtest-2	19.72	19.68	19.82
HSUPA Subtest-3	19.66	19.72	19.78
HSUPA Subtest-4	19.71	19.70	19.81
HSUPA Subtest-5	22.23	22.21	22.25



Test Report No.: W7L-P23100014RF06

LTE Band 7

Band/BW	Modulation	RB Size	RB Offset	Low CH	Mid CH	High CH
				20775	21100	21425
				Frequency	Frequency	Frequency
				2502.5 MHz	2535 MHz	2567.5 MHz
7/5	QPSK	1	0	23.04	22.96	22.83
		1	12	23.05	23.05	22.96
		1	24	23.16	23.06	23.07
		12	0	22.16	22.09	22.01
		12	6	22.25	22.19	22.21
		12	13	22.27	22.21	22.18
		25	0	22.25	22.17	22.15
	16QAM	1	0	22.11	22.01	21.99
		1	12	22.01	22.03	21.91
		1	24	22.18	22.11	22.11
		12	0	21.21	21.09	21.06
		12	6	21.27	21.21	21.23
		12	13	21.30	21.29	21.12
		25	0	21.24	21.22	21.16
	64QAM	1	0	21.33	21.21	21.15
		1	12	21.37	21.33	21.27
		1	24	21.44	21.35	21.31
		12	0	20.24	20.21	20.07
		12	6	20.26	20.26	20.20
		12	13	20.34	20.28	20.15
		25	0	20.31	20.23	20.22



Test Report No.: W7L-P23100014RF06

Band/BW	Modulation	RB Size	RB Offset	Low CH 20800	Mid CH 21100	High CH 21400
				Frequency 2505 MHz	Frequency 2535 MHz	Frequency 2565 MHz
7/ 10	QPSK	1	0	23.02	22.93	22.86
		1	24	23.11	22.98	23.00
		1	49	23.12	23.07	23.03
		25	0	22.20	22.03	22.05
		25	12	22.24	22.20	22.18
		25	25	22.32	22.17	22.21
		50	0	22.25	22.18	22.12
	16QAM	1	0	22.13	21.99	22.05
		1	24	22.06	22.03	21.89
		1	49	22.20	22.08	22.07
		25	0	21.26	21.10	21.09
		25	12	21.32	21.18	21.24
		25	25	21.30	21.27	21.13
		50	0	21.30	21.15	21.17
	64QAM	1	0	21.29	21.22	21.18
		1	24	21.42	21.28	21.27
		1	49	21.46	21.33	21.34
		25	0	20.24	20.15	20.08
		25	12	20.33	20.25	20.14
		25	25	20.33	20.25	20.17
		50	0	20.36	20.19	20.23



Test Report No.: W7L-P23100014RF06

Band/BW	Modulation	RB Size	RB Offset	Low CH 20825	Mid CH 21100	High CH 21375
				Frequency 2507.5 MHz	Frequency 2535 MHz	Frequency 2562.5 MHz
7/ 15	QPSK	1	0	23.07	22.99	22.80
		1	37	23.06	22.98	22.95
		1	74	23.17	23.05	23.06
		36	0	22.20	22.04	22.01
		36	19	22.26	22.16	22.21
		36	39	22.33	22.15	22.22
		75	0	22.19	22.21	22.12
	16QAM	1	0	22.17	21.99	22.06
		1	37	21.99	22.01	21.92
		1	74	22.22	22.10	22.11
		36	0	21.25	21.09	21.06
		36	19	21.28	21.18	21.23
		36	39	21.37	21.29	21.10
		75	0	21.27	21.15	21.12
	64QAM	1	0	21.36	21.20	21.21
		1	37	21.43	21.27	21.24
		1	74	21.42	21.32	21.37
		36	0	20.29	20.21	20.02
		36	19	20.27	20.19	20.16
		36	39	20.36	20.32	20.19
		75	0	20.35	20.17	20.24



Test Report No.: W7L-P23100014RF06

Band/BW	Modulation	RB Size	RB Offset	Low CH 20850	Mid CH 21100	High CH 21350
				Frequency 2510 MHz	Frequency 2535 MHz	Frequency 2560 MHz
7/20	QPSK	1	0	23.08	23.01	22.88
		1	50	23.13	23.06	23.01
		1	99	23.20	23.11	23.08
		50	0	22.22	22.11	22.06
		50	25	22.32	22.24	22.23
		50	50	22.35	22.23	22.23
		100	0	22.27	22.25	22.17
	16QAM	1	0	22.19	22.07	22.07
		1	50	22.07	22.05	21.97
		1	99	22.25	22.16	22.13
		50	0	21.27	21.16	21.11
		50	25	21.34	21.26	21.25
		50	50	21.38	21.31	21.18
		100	0	21.32	21.23	21.18
	64QAM	1	0	21.37	21.26	21.23
		1	50	21.45	21.34	21.29
		1	99	21.48	21.40	21.39
		50	0	20.30	20.23	20.10
		50	25	20.34	20.27	20.22
		50	50	20.38	20.33	20.23
		100	0	20.37	20.25	20.25



**BUREAU
VERITAS**

Test Report No.: W7L-P23100014RF06

LTE Band 12

Band/BW	Modulation	RB Size	RB Offset	Low CH 23017	Mid CH 23095	High CH 23173
				Frequency 699.7 MHz	Frequency 707.5 MHz	Frequency 715.3 MHz
12/ 1.4	QPSK	1	0	22.24	22.21	22.30
		1	2	22.28	22.14	22.32
		1	5	22.33	22.20	22.37
		3	0	21.99	21.91	22.05
		3	1	22.03	22.04	22.02
		3	3	22.06	21.97	22.11
		6	0	21.26	21.20	21.29
	16QAM	1	0	21.49	21.44	21.57
		1	2	21.42	21.37	21.48
		1	5	21.57	21.43	21.64
		3	0	21.35	21.31	21.37
		3	1	21.37	21.43	21.43
		3	3	21.46	21.42	21.57
		6	0	20.23	20.21	20.28
	64QAM	1	0	20.47	20.46	20.60
		1	2	20.47	20.54	20.55
		1	5	20.60	20.56	20.69
		3	0	20.26	20.22	20.25
		3	1	20.26	20.32	20.35
		3	3	20.36	20.27	20.39
		6	0	19.33	19.31	19.38



Test Report No.: W7L-P23100014RF06

Band/BW	Modulation	RB Size	RB Offset	Low CH 23025	Mid CH 23095	High CH 23165
				Frequency 700.5 MHz	Frequency 707.5 MHz	Frequency 714.5 MHz
12/ 3	QPSK	1	0	22.26	22.23	22.29
		1	7	22.24	22.15	22.32
		1	14	22.29	22.20	22.37
		8	0	21.28	21.24	21.35
		8	3	21.26	21.34	21.34
		8	7	21.33	21.34	21.45
		15	0	21.23	21.21	21.23
	16QAM	1	0	21.46	21.50	21.60
		1	7	21.39	21.40	21.46
		1	14	21.60	21.43	21.64
		8	0	20.31	20.32	20.37
		8	3	20.42	20.38	20.46
		8	7	20.48	20.40	20.53
		15	0	20.23	20.15	20.31
	64QAM	1	0	20.53	20.49	20.54
		1	7	20.50	20.48	20.54
		1	14	20.61	20.58	20.69
		8	0	19.29	19.26	19.26
		8	3	19.30	19.26	19.40
		8	7	19.33	19.31	19.35
		15	0	19.35	19.28	19.42



Test Report No.: W7L-P23100014RF06

Band/BW	Modulation	RB Size	RB Offset	Low CH 23035	Mid CH 23095	High CH 23155
				Frequency 701.5 MHz	Frequency 707.5 MHz	Frequency 713.5 MHz
12/ 5	QPSK	1	0	22.27	22.18	22.30
		1	12	22.29	22.12	22.32
		1	24	22.30	22.19	22.41
		12	0	21.31	21.24	21.32
		12	6	21.26	21.35	21.35
		12	13	21.37	21.30	21.46
		25	0	21.21	21.24	21.26
	16QAM	1	0	21.47	21.46	21.60
		1	12	21.36	21.43	21.45
		1	24	21.60	21.43	21.63
		12	0	20.31	20.30	20.34
		12	6	20.39	20.42	20.42
		12	13	20.43	20.42	20.56
		25	0	20.23	20.16	20.28
	64QAM	1	0	20.47	20.46	20.60
		1	12	20.47	20.54	20.54
		1	24	20.54	20.63	20.69
		12	0	19.30	19.23	19.25
		12	6	19.24	19.33	19.39
		12	13	19.37	19.30	19.32
		25	0	19.31	19.34	19.40



Test Report No.: W7L-P23100014RF06

Band/BW	Modulation	RB Size	RB Offset	Low CH 23060	Mid CH 23095	High CH 23130
				Frequency 704 MHz	Frequency 707.5 MHz	Frequency 711 MHz
12/ 10	QPSK	1	0	22.32	22.25	22.35
		1	24	22.31	22.20	22.34
		1	49	22.35	22.27	22.42
		25	0	21.35	21.29	21.37
		25	12	21.34	21.36	21.40
		25	25	21.41	21.35	21.47
		50	0	21.27	21.26	21.31
	16QAM	1	0	21.54	21.51	21.62
		1	24	21.44	21.45	21.50
		1	49	21.62	21.51	21.65
		25	0	20.39	20.36	20.42
		25	12	20.45	20.44	20.48
		25	25	20.50	20.47	20.58
		50	0	20.29	20.23	20.33
	64QAM	1	0	20.54	20.51	20.62
		1	24	20.55	20.56	20.60
		1	49	20.62	20.64	20.71
		25	0	19.34	19.28	19.33
		25	12	19.32	19.34	19.41
		25	25	19.41	19.35	19.40
		50	0	19.37	19.36	19.43



**BUREAU
VERITAS**

Test Report No.: W7L-P23100014RF06

LTE Band 13

Band/BW	Modulation	RB Size	RB Offset	Low CH 23205	Mid CH 23230	High CH 23255
				Frequency 779.5 MHz	Frequency 782.0 MHz	Frequency 784.5 MHz
13/ 5	QPSK	1	0	22.36	22.40	22.39
		1	12	22.63	22.57	22.64
		1	24	22.39	22.43	22.42
		12	0	21.71	21.68	21.72
		12	6	21.77	21.72	21.74
		12	13	21.70	21.68	21.74
		25	0	21.72	21.71	21.65
	16QAM	1	0	21.64	21.63	21.65
		1	12	21.81	21.78	21.82
		1	24	21.66	21.61	21.63
		12	0	20.65	20.63	20.69
		12	6	20.75	20.69	20.76
		12	13	20.66	20.70	20.69
		25	0	20.73	20.67	20.74
	64QAM	1	0	20.71	20.75	20.74
		1	12	20.99	20.96	21.00
		1	24	20.82	20.77	20.79
		12	0	19.71	19.69	19.75
		12	6	19.79	19.78	19.72
		12	13	19.68	19.65	19.67
		25	0	19.81	19.76	19.80



Test Report No.: W7L-P23100014RF06

Band/BW	Modulation	RB Size	RB Offset	/	Mid CH 23230	/
				/	Frequency 782.0 MHz	/
13/ 10	QPSK	1	0	/	22.44	/
		1	24	/	22.65	/
		1	49	/	22.47	/
		25	0	/	21.74	/
		25	12	/	21.79	/
		25	25	/	21.76	/
		50	0	/	21.73	/
	16QAM	1	0	/	21.71	/
		1	24	/	21.84	/
		1	49	/	21.68	/
		25	0	/	20.71	/
		25	12	/	20.77	/
		25	25	/	20.74	/
		50	0	/	20.75	/
	64QAM	1	0	/	20.79	/
		1	24	/	21.02	/
		1	49	/	20.84	/
		25	0	/	19.77	/
		25	12	/	19.80	/
		25	25	/	19.73	/
		50	0	/	19.82	/



**BUREAU
VERITAS**

Test Report No.: W7L-P23100014RF06

LTE Band 17

Band/BW	Modulation	RB Size	RB Offset	Low CH 23755	Mid CH 23790	High CH 23825
				Frequency 706.5 MHz	Frequency 710 MHz	Frequency 713.5 MHz
17/5	QPSK	1	0	22.04	22.28	22.69
		1	12	22.07	22.26	21.69
		1	24	20.78	20.68	20.90
		12	0	21.37	21.49	21.28
		12	6	21.39	21.12	20.91
		12	13	20.64	20.20	19.90
		25	0	20.96	20.97	20.68
	16QAM	1	0	21.61	21.40	21.81
		1	12	21.57	21.41	20.95
		1	24	20.30	19.88	20.10
		12	0	20.37	20.46	20.33
		12	6	20.40	20.18	20.00
		12	13	19.76	19.19	18.97
		25	0	19.99	19.99	19.82
	64QAM	1	0	20.26	20.55	20.89
		1	12	20.19	20.56	20.08
		1	24	19.06	18.98	19.22
		12	0	19.35	19.46	19.24
		12	6	19.31	19.26	18.81
		12	13	18.68	18.27	17.83
		25	0	18.96	18.93	18.68



Test Report No.: W7L-P23100014RF06

Band/BW	Modulation	RB Size	RB Offset	Low CH 23780	Mid CH 23790	High CH 23800
				Frequency 709 MHz	Frequency 710 MHz	Frequency 711 MHz
17/ 10	QPSK	1	0	22.08	22.33	22.70
		1	24	22.13	22.28	21.74
		1	49	20.85	20.73	20.92
		25	0	21.45	21.51	21.33
		25	12	21.41	21.20	20.93
		25	25	20.72	20.26	19.98
		50	0	21.02	20.99	20.74
	16QAM	1	0	21.68	21.45	21.83
		1	24	21.63	21.48	21.00
		1	49	20.37	19.93	20.12
		25	0	20.45	20.48	20.39
		25	12	20.48	20.19	20.02
		25	25	19.80	19.24	19.05
		50	0	20.07	20.00	19.84
	64QAM	1	0	20.30	20.60	20.97
		1	24	20.25	20.58	20.11
		1	49	19.12	19.05	19.27
		25	0	19.42	19.51	19.26
		25	12	19.39	19.28	18.87
		25	25	18.76	18.33	17.91
		50	0	19.00	18.98	18.76



BUREAU
VERITAS

Test Report No.: W7L-P23100014RF06

LTE Band 30

Band/BW	Modulation	RB Size	RB Offset	Low CH 27685	Mid CH 27710	High CH 27735
				2307.5 MHz	2310.0 MHz	2312.5 MHz
30/ 5	QPSK	1	0	23.33	23.32	23.32
		1	12	23.24	23.31	23.27
		1	24	23.18	23.17	23.21
		12	0	22.35	22.39	22.36
		12	6	22.31	22.33	22.36
		12	13	22.37	22.43	22.40
		25	0	22.35	22.29	22.35
	16QAM	1	0	22.60	22.62	22.60
		1	12	22.54	22.58	22.54
		1	24	22.56	22.58	22.61
		12	0	21.45	21.44	21.46
		12	6	21.46	21.48	21.51
		12	13	21.47	21.53	21.49
		25	0	21.39	21.46	21.45
	64QAM	1	0	21.70	21.69	21.66
		1	12	21.73	21.80	21.79
		1	24	21.84	21.83	21.80
		12	0	20.35	20.39	20.38
		12	6	20.34	20.41	20.40
		12	13	20.37	20.43	20.40
		25	0	20.43	20.37	20.43



Test Report No.: W7L-P23100014RF06

Band/BW	Modulation	RB Size	RB Offset	/	Mid CH 27710	/
				/	2310.0 MHz	/
30/ 10	QPSK	1	0	/	23.37	/
		1	24	/	23.32	/
		1	49	/	23.22	/
		25	0	/	22.41	/
		25	12	/	22.38	/
		25	25	/	22.45	/
		50	0	/	22.37	/
	16QAM	1	0	/	22.68	/
		1	24	/	22.60	/
		1	49	/	22.63	/
		25	0	/	21.51	/
		25	12	/	21.53	/
		25	25	/	21.55	/
		50	0	/	21.47	/
	64QAM	1	0	/	21.74	/
		1	24	/	21.81	/
		1	49	/	21.88	/
		25	0	/	20.41	/
		25	12	/	20.42	/
		25	25	/	20.45	/
		50	0	/	20.45	/



**BUREAU
VERITAS**

Test Report No.: W7L-P23100014RF06

LTE Band 71

Band/BW	Modulation	RB Size	RB Offset	Low CH 133147	Mid CH 133247	High CH 133447
				Frequency 665.5MHz	Frequency 675.5MHz	Frequency 695.5MHz
71/ 5	QPSK	1	0	22.65	22.76	22.66
		1	12	22.61	22.66	22.53
		1	24	22.66	22.76	22.72
		12	0	21.68	21.76	21.61
		12	6	21.51	21.72	21.47
		12	13	21.56	21.66	21.57
		25	0	21.48	21.68	21.48
	16QAM	1	0	22.05	22.13	22.07
		1	12	21.92	22.14	21.94
		1	24	22.14	22.17	22.11
		12	0	20.58	20.68	20.47
		12	6	20.52	20.71	20.50
		12	13	20.51	20.60	20.49
		25	0	20.45	20.54	20.46
	64QAM	1	0	20.92	21.05	20.86
		1	12	20.76	20.93	20.75
		1	24	20.84	21.04	20.84
		12	0	20.33	20.38	20.26
		12	6	20.10	20.28	20.13
		12	13	20.21	20.34	20.10
		25	0	20.18	20.37	20.19



Test Report No.: W7L-P23100014RF06

Band/BW	Modulation	RB Size	RB Offset	Low CH 133172	Mid CH 133272	High CH 133172
				Frequency 668MHz	Frequency 678MHz	Frequency 693MHz
71/ 10	QPSK	1	0	22.62	22.79	22.66
		1	24	22.61	22.66	22.54
		1	49	22.63	22.80	22.68
		25	0	21.69	21.75	21.64
		25	12	21.57	21.66	21.47
		25	25	21.54	21.63	21.56
		50	0	21.53	21.68	21.45
	16QAM	1	0	22.05	22.10	22.03
		1	24	21.97	22.10	21.97
		1	49	22.14	22.18	22.08
		25	0	20.60	20.66	20.53
		25	12	20.56	20.65	20.55
		25	25	20.50	20.61	20.46
		50	0	20.49	20.53	20.50
	64QAM	1	0	20.91	21.06	20.83
		1	24	20.81	20.89	20.79
		1	49	20.90	20.98	20.81
		25	0	20.31	20.35	20.32
		25	12	20.17	20.27	20.07
		25	25	20.20	20.31	20.12
		50	0	20.23	20.33	20.20



Test Report No.: W7L-P23100014RF06

Band/BW	Modulation	RB Size	RB Offset	Low CH 133197	Mid CH 133297	High CH 133397
				Frequency 670.5MHz	Frequency 680.5MHz	Frequency 690.5MHz
71/ 15	QPSK	1	0	22.64	22.78	22.70
		1	37	22.62	22.72	22.50
		1	74	22.63	22.77	22.71
		36	0	21.71	21.77	21.63
		36	19	21.56	21.72	21.46
		36	39	21.56	21.66	21.56
		75	0	21.48	21.68	21.50
	16QAM	1	0	22.10	22.10	22.08
		1	37	21.92	22.12	21.94
		1	74	22.13	22.19	22.11
		36	0	20.65	20.69	20.47
		36	19	20.52	20.70	20.52
		36	39	20.56	20.58	20.46
		75	0	20.45	20.53	20.49
	64QAM	1	0	20.98	21.08	20.80
		1	37	20.77	20.87	20.75
		1	74	20.90	21.04	20.82
		36	0	20.35	20.35	20.33
		36	19	20.11	20.21	20.09
		36	39	20.22	20.38	20.12
		75	0	20.18	20.36	20.18



Test Report No.: W7L-P23100014RF06

Band/BW	Modulation	RB Size	RB Offset	Low CH 133222	Mid CH 133322	High CH 133372
				Frequency 673MHz	Frequency 683MHz	Frequency 688MHz
71/ 20	QPSK	1	0	22.70	22.83	22.71
		1	50	22.63	22.74	22.55
		1	99	22.71	22.84	22.73
		50	0	21.72	21.81	21.66
		50	25	21.59	21.73	21.52
		50	50	21.60	21.71	21.58
		100	0	21.54	21.70	21.53
	16QAM	1	0	22.12	22.18	22.09
		1	50	22.00	22.16	21.99
		1	99	22.16	22.25	22.13
		50	0	20.66	20.74	20.55
		50	25	20.58	20.73	20.56
		50	50	20.58	20.65	20.51
		100	0	20.51	20.61	20.51
	64QAM	1	0	20.99	21.10	20.88
		1	50	20.84	20.95	20.81
		1	99	20.92	21.05	20.86
		50	0	20.37	20.43	20.34
		50	25	20.18	20.29	20.15
		50	50	20.25	20.39	20.18
		100	0	20.24	20.39	20.22



Test Report No.: W7L-P23100014RF06

EIRP

WCDMA IV

Channel	Frequency (MHz)	Conducted Power (dBm)	G _T -L _c (dB)	EIRP (dBm)	EIRP (mW)	Limit (W)
1312	1712.4	23.24	0.4	23.64	231.21	1
1413	1732.6	23.26	0.4	23.66	232.27	1
1513	1752.6	23.33	0.4	23.73	236.05	1

LTE BAND 7

CHANNEL BANDWIDTH: 5MHz QPSK

Channel	Frequency (MHz)	Conducted Power (dBm)	G _T -L _c (dB)	EIRP (dBm)	EIRP (mW)	Limit (W)
20775	2502.5	23.16	-1.5	21.66	146.55	2
21100	2535.0	23.06	-1.5	21.56	143.22	2
21425	2567.5	23.07	-1.5	21.57	143.55	2

CHANNEL BANDWIDTH: 5MHz 16QAM

Channel	Frequency (MHz)	Conducted Power (dBm)	G _T -L _c (dB)	EIRP (dBm)	EIRP (mW)	Limit (W)
20775	2502.5	22.18	-1.5	20.68	116.95	2
21100	2535.0	22.11	-1.5	20.61	115.08	2
21425	2567.5	22.11	-1.5	20.61	115.08	2

CHANNEL BANDWIDTH: 5MHz 64QAM

Channel	Frequency (MHz)	Conducted Power (dBm)	G _T -L _c (dB)	EIRP (dBm)	EIRP (mW)	Limit (W)
20775	2502.5	21.44	-1.5	19.94	98.63	2
21100	2535	21.35	-1.5	19.85	96.61	2
21425	2567.5	21.31	-1.5	19.81	95.72	2



Test Report No.: W7L-P23100014RF06

CHANNEL BANDWIDTH: 10MHz QPSK

Channel	Frequency (MHz)	Conducted Power (dBm)	G _T -L _c (dB)	EIRP (dBm)	EIRP (mW)	Limit (W)
20800	2505.0	23.12	-1.5	21.62	145.21	2
21100	2535.0	23.07	-1.5	21.57	143.55	2
21400	2565.0	23.03	-1.5	21.53	142.23	2

CHANNEL BANDWIDTH: 10MHz 16QAM

Channel	Frequency (MHz)	Conducted Power (dBm)	G _T -L _c (dB)	EIRP (dBm)	EIRP (mW)	Limit (W)
20800	2505.0	22.2	-1.5	20.7	117.49	2
21100	2535.0	22.08	-1.5	20.58	114.29	2
21400	2565.0	22.07	-1.5	20.57	114.02	2

CHANNEL BANDWIDTH: 10MHz 64QAM

Channel	Frequency (MHz)	Conducted Power (dBm)	G _T -L _c (dB)	EIRP (dBm)	EIRP (mW)	Limit (W)
20800	2505	21.46	-1.5	19.96	99.08	2
21100	2535	21.33	-1.5	19.83	96.16	2
21400	2565	21.34	-1.5	19.84	96.38	2



Test Report No.: W7L-P23100014RF06

CHANNEL BANDWIDTH: 15MHz QPSK

Channel	Frequency (MHz)	Conducted Power (dBm)	G _T -L _C (dB)	EIRP (dBm)	EIRP (mW)	Limit (W)
20825	2507.5	23.17	-1.5	21.67	146.89	2
21100	2535.0	23.05	-1.5	21.55	142.89	2
21375	2562.5	23.06	-1.5	21.56	143.22	2

CHANNEL BANDWIDTH: 15MHz 16QAM

Channel	Frequency (MHz)	Conducted Power (dBm)	G _T -L _C (dB)	EIRP (dBm)	EIRP (mW)	Limit (W)
20825	2507.5	22.22	-1.5	20.72	118.03	2
21100	2535.0	22.1	-1.5	20.6	114.82	2
21375	2562.5	22.11	-1.5	20.61	115.08	2

CHANNEL BANDWIDTH: 15MHz 64QAM

Channel	Frequency (MHz)	Conducted Power (dBm)	G _T -L _C (dB)	EIRP (dBm)	EIRP (mW)	Limit (W)
20825	2507.5	21.43	-1.5	19.93	98.4	2
21100	2535	21.32	-1.5	19.82	95.94	2
21375	2562.5	21.37	-1.5	19.87	97.05	2



BUREAU
VERITAS

Test Report No.: W7L-P23100014RF06

CHANNEL BANDWIDTH: 20MHz QPSK

Channel	Frequency (MHz)	Conducted Power (dBm)	G _{T-Lc} (dB)	EIRP (dBm)	EIRP (mW)	Limit (W)
20850	2510.0	23.2	-1.5	21.7	147.91	2
21100	2535.0	23.11	-1.5	21.61	144.88	2
21350	2560.0	23.08	-1.5	21.58	143.88	2

CHANNEL BANDWIDTH: 20MHz 16QAM

Channel	Frequency (MHz)	Conducted Power (dBm)	G _{T-Lc} (dB)	EIRP (dBm)	EIRP (mW)	Limit (W)
20850	2510.0	22.25	-1.5	20.75	118.85	2
21100	2535.0	22.16	-1.5	20.66	116.41	2
21350	2560.0	22.13	-1.5	20.63	115.61	2

CHANNEL BANDWIDTH: 20MHz 64QAM

Channel	Frequency (MHz)	Conducted Power (dBm)	G _{T-Lc} (dB)	EIRP (dBm)	EIRP (mW)	Limit (W)
20850	2510	21.48	-1.5	19.98	99.54	2
21100	2535	21.4	-1.5	19.9	97.72	2
21350	2560	21.39	-1.5	19.89	97.5	2

REMARKS: ERP Output Power (dBm) = EIRP (dBm) -2.15(dB).



BUREAU
VERITAS

Test Report No.: W7L-P23100014RF06

LTE BAND 12

CHANNEL BANDWIDTH: 1.4MHz QPSK

Channel	Frequency (MHz)	Conducted Power (dBm)	G _T -L _c (dB)	ERP (dBm)	ERP (mW)	Limit (W)
23017	699.7	22.33	-2.5	17.68	58.61	3
23095	707.5	22.21	-2.5	17.56	57.02	3
23173	715.3	22.37	-2.5	17.72	59.16	3

CHANNEL BANDWIDTH: 1.4MHz 16QAM

Channel	Frequency (MHz)	Conducted Power (dBm)	G _T -L _c (dB)	ERP (dBm)	ERP (mW)	Limit (W)
23017	699.7	21.57	-2.5	16.92	49.2	3
23095	707.5	21.44	-2.5	16.79	47.75	3
23173	715.3	21.64	-2.5	16.99	50	3

CHANNEL BANDWIDTH: 1.4MHz 64QAM

Channel	Frequency (MHz)	Conducted Power (dBm)	G _T -L _c (dB)	ERP (dBm)	ERP (mW)	Limit (W)
23017	699.7	20.6	-2.5	15.95	39.36	3
23095	707.5	20.56	-2.5	15.91	38.99	3
23173	715.3	20.69	-2.5	16.04	40.18	3

CHANNEL BANDWIDTH: 3MHz QPSK

Channel	Frequency (MHz)	Conducted Power (dBm)	G _T -L _c (dB)	ERP (dBm)	ERP (mW)	Limit (W)
23025	700.5	22.29	-2.5	17.64	58.08	3
23095	707.5	22.23	-2.5	17.58	57.28	3
23165	714.5	22.37	-2.5	17.72	59.16	3

CHANNEL BANDWIDTH: 3MHz 16QAM

Channel	Frequency (MHz)	Conducted Power (dBm)	G _T -L _c (dB)	ERP (dBm)	ERP (mW)	Limit (W)
23025	700.5	21.6	-2.5	16.95	49.55	3
23095	707.5	21.5	-2.5	16.85	48.42	3
23165	714.5	21.64	-2.5	16.99	50	3



Test Report No.: W7L-P23100014RF06

CHANNEL BANDWIDTH: 3MHz 64QAM

Channel	Frequency (MHz)	Conducted Power (dBm)	G _{T-Lc} (dB)	ERP (dBm)	ERP (mW)	Limit (W)
23025	700.5	20.61	-2.5	15.96	39.45	3
23095	707.5	20.58	-2.5	15.93	39.17	3
23165	714.5	20.69	-2.5	16.04	40.18	3

CHANNEL BANDWIDTH: 5MHz QPSK

Channel	Frequency (MHz)	Conducted Power (dBm)	G _{T-Lc} (dB)	ERP (dBm)	ERP (mW)	Limit (W)
23035	701.5	22.3	-2.5	17.65	58.21	3
23095	707.5	22.19	-2.5	17.54	56.75	3
23155	713.5	22.41	-2.5	17.76	59.7	3

CHANNEL BANDWIDTH: 5MHz 16QAM

Channel	Frequency (MHz)	Conducted Power (dBm)	G _{T-Lc} (dB)	ERP (dBm)	ERP (mW)	Limit (W)
23035	701.5	21.6	-2.5	16.95	49.55	3
23095	707.5	21.46	-2.5	16.81	47.97	3
23155	713.5	21.63	-2.5	16.98	49.89	3

CHANNEL BANDWIDTH: 5MHz 64QAM

Channel	Frequency (MHz)	Conducted Power (dBm)	G _{T-Lc} (dB)	ERP (dBm)	ERP (mW)	Limit (W)
23035	701.5	20.54	-2.5	15.89	38.82	3
23095	707.5	20.63	-2.5	15.98	39.63	3
23155	713.5	20.69	-2.5	16.04	40.18	3



BUREAU
VERITAS

Test Report No.: W7L-P23100014RF06

CHANNEL BANDWIDTH: 10MHz QPSK

Channel	Frequency (MHz)	Conducted Power (dBm)	G _T -L _c (dB)	ERP (dBm)	ERP (mW)	Limit (W)
23060	704	22.35	-2.5	17.7	58.88	3
23095	707.5	22.27	-2.5	17.62	57.81	3
23130	711	22.42	-2.5	17.77	59.84	3

CHANNEL BANDWIDTH: 10MHz 16QAM

Channel	Frequency (MHz)	Conducted Power (dBm)	G _T -L _c (dB)	ERP (dBm)	ERP (mW)	Limit (W)
23060	704	21.62	-2.5	16.97	49.77	3
23095	707.5	21.51	-2.5	16.86	48.53	3
23130	711	21.65	-2.5	17	50.12	3

CHANNEL BANDWIDTH: 10MHz 64QAM

Channel	Frequency (MHz)	Conducted Power (dBm)	G _T -L _c (dB)	ERP (dBm)	ERP (mW)	Limit (W)
23060	704	20.62	-2.5	15.97	39.54	3
23095	707.5	20.64	-2.5	15.99	39.72	3
23130	711	20.71	-2.5	16.06	40.36	3

REMARKS: ERP Output Power (dBm) = EIRP (dBm) -2.15(dB).



BUREAU
VERITAS

Test Report No.: W7L-P23100014RF06

LTE BAND 13

CHANNEL BANDWIDTH: 5MHz QPSK

Channel	Frequency (MHz)	Conducted Power (dBm)	G _T -L _c (dB)	ERP (dBm)	ERP (mW)	Limit (W)
23205	779.5	22.63	-3	17.48	55.98	3
23230	782	22.57	-3	17.42	55.21	3
23255	784.5	22.64	-3	17.49	56.1	3

CHANNEL BANDWIDTH: 5MHz 16QAM

Channel	Frequency (MHz)	Conducted Power (dBm)	G _T -L _c (dB)	ERP (dBm)	ERP (mW)	Limit (W)
23205	779.5	21.81	-3	16.66	46.34	3
23230	782	21.78	-3	16.63	46.03	3
23255	784.5	21.82	-3	16.67	46.45	3

CHANNEL BANDWIDTH: 5MHz 64QAM

Channel	Frequency (MHz)	Conducted Power (dBm)	G _T -L _c (dB)	ERP (dBm)	ERP (mW)	Limit (W)
23205	779.5	20.99	-3	15.84	38.37	3
23230	782	20.96	-3	15.81	38.11	3
23255	784.5	21	-3	15.85	38.46	3



Test Report No.: W7L-P23100014RF06

CHANNEL BANDWIDTH: 10MHz QPSK

Channel	Frequency (MHz)	Conducted Power (dBm)	G _{T-LC} (dB)	ERP (dBm)	ERP (mW)	Limit (W)
-	-	-	-	-	-	-
23230	782	22.65	-3	17.5	56.23	3
-	-	-	-	-	-	-

CHANNEL BANDWIDTH: 10MHz 16QAM

Channel	Frequency (MHz)	Conducted Power (dBm)	G _{T-LC} (dB)	ERP (dBm)	ERP (mW)	Limit (W)
-	-	-	-	-	-	-
23230	782	21.84	-3	16.69	46.67	3
-	-	-	-	-	-	-

CHANNEL BANDWIDTH: 10MHz 64QAM

Channel	Frequency (MHz)	Conducted Power (dBm)	G _{T-LC} (dB)	ERP (dBm)	ERP (mW)	Limit (W)
-	-	-	-	-	-	-
23230	782	21.02	-3	15.87	38.64	3
-	-	-	-	-	-	-

REMARKS: ERP Output Power (dBm) = EIRP (dBm) -2.15(dB).



Test Report No.: W7L-P23100014RF06

LTE BAND 17

CHANNEL BANDWIDTH: 5MHz QPSK

Channel	Frequency (MHz)	Conducted Power (dBm)	G _{T-Lc} (dB)	ERP (dBm)	ERP (mW)	Limit (W)
23755	706.5	22.07	-2.5	17.42	55.21	3
23790	710	22.28	-2.5	17.63	57.94	3
23825	713.5	22.69	-2.5	18.04	63.68	3

CHANNEL BANDWIDTH: 5MHz 16QAM

Channel	Frequency (MHz)	Conducted Power (dBm)	G _{T-Lc} (dB)	ERP (dBm)	ERP (mW)	Limit (W)
23755	706.5	21.61	-2.5	16.96	49.66	3
23790	710	21.41	-2.5	16.76	47.42	3
23825	713.5	21.81	-2.5	17.16	52	3

CHANNEL BANDWIDTH: 5MHz 64QAM

Channel	Frequency (MHz)	Conducted Power (dBm)	G _{T-Lc} (dB)	ERP (dBm)	ERP (mW)	Limit (W)
23755	706.5	20.26	-2.5	15.61	36.39	3
23790	710	20.56	-2.5	15.91	38.99	3
23825	713.5	20.89	-2.5	16.24	42.07	3



Test Report No.: W7L-P23100014RF06

CHANNEL BANDWIDTH: 10MHz QPSK

Channel	Frequency (MHz)	Conducted Power (dBm)	G _{T-Lc} (dB)	ERP (dBm)	ERP (mW)	Limit (W)
23780	709	22.13	-2.5	17.48	55.98	3
23790	710	22.33	-2.5	17.68	58.61	3
23800	711	22.7	-2.5	18.05	63.83	3

CHANNEL BANDWIDTH: 10MHz 16QAM

Channel	Frequency (MHz)	Conducted Power (dBm)	G _{T-Lc} (dB)	ERP (dBm)	ERP (mW)	Limit (W)
23780	709	21.68	-2.5	17.03	50.47	3
23790	710	21.48	-2.5	16.83	48.19	3
23800	711	21.83	-2.5	17.18	52.24	3

CHANNEL BANDWIDTH: 10MHz 64QAM

Channel	Frequency (MHz)	Conducted Power (dBm)	G _{T-Lc} (dB)	ERP (dBm)	ERP (mW)	Limit (W)
23780	709	20.3	-2.5	15.65	36.73	3
23790	710	20.6	-2.5	15.95	39.36	3
23800	711	20.97	-2.5	16.32	42.85	3

REMARKS: ERP Output Power (dBm) = EIRP (dBm) -2.15(dB).



BUREAU
VERITAS

Test Report No.: W7L-P23100014RF06

LTE BAND 30

CHANNEL BANDWIDTH: 5MHz QPSK

Channel	Frequency (MHz)	Conducted Power (dBm)	G _T -L _c (dB)	EIRP (dBm)	EIRP (mW)	Limit (W/5MHz)
27685	2307.5	23.33	-2.8	20.53	112.98	0.25
27710	2310	23.32	-2.8	20.52	112.72	0.25
27735	2312.5	23.32	-2.8	20.52	112.72	0.25

CHANNEL BANDWIDTH: 5MHz 16QAM

Channel	Frequency (MHz)	Conducted Power (dBm)	G _T -L _c (dB)	EIRP (dBm)	EIRP (mW)	Limit (W/5MHz)
27685	2307.5	22.6	-2.8	19.8	95.5	0.25
27710	2310	22.62	-2.8	19.82	95.94	0.25
27735	2312.5	22.61	-2.8	19.81	95.72	0.25

CHANNEL BANDWIDTH: 5MHz 64QAM

Channel	Frequency (MHz)	Conducted Power (dBm)	G _T -L _c (dB)	EIRP (dBm)	EIRP (mW)	Limit (W/5MHz)
27685	2307.5	21.84	-2.8	19.04	80.17	0.25
27710	2310	21.83	-2.8	19.03	79.98	0.25
27735	2312.5	21.8	-2.8	19	79.43	0.25

CHANNEL BANDWIDTH: 10MHz QPSK

Channel	Frequency (MHz)	Conducted Power (dBm)	G _T -L _c (dB)	EIRP (dBm)	EIRP (mW)	Limit (W/5MHz)
-	-	-	-	-	-	-
27710	2310	23.37	-2.8	20.57	114.02	0.25
-	-	-	-	-	-	-

CHANNEL BANDWIDTH: 10MHz 16QAM

Channel	Frequency (MHz)	Conducted Power (dBm)	G _T -L _c (dB)	EIRP (dBm)	EIRP (mW)	Limit (W/5MHz)
-	-	-	-	-	-	-
27710	2310	22.68	-2.8	19.88	97.27	0.25
-	-	-	-	-	-	-



Test Report No.: W7L-P23100014RF06

CHANNEL BANDWIDTH: 10MHz 64QAM

Channel	Frequency (MHz)	Conducted Power (dBm)	G _T -L _c (dB)	EIRP (dBm)	EIRP (mW)	Limit (W/5MHz)
-	-	-	-	-	-	-
27710	2310	21.88	-2.8	19.08	80.91	0.25
-	-	-	-	-	-	-

REMARKS: ERP Output Power (dBm) = EIRP (dBm) -2.15(dB).



BUREAU
VERITAS

Test Report No.: W7L-P23100014RF06

LTE BAND 71

CHANNEL BANDWIDTH: 5MHz QPSK

Channel	Frequency (MHz)	Conducted Power (dBm)	G _{T-Lc} (dB)	ERP (dBm)	ERP (mW)	Limit (W)
133147	665.5	22.66	-7	13.51	22.44	3
133247	675.5	22.76	-7	13.61	22.96	3
133447	695.5	22.72	-7	13.57	22.75	3

CHANNEL BANDWIDTH: 5MHz 16QAM

Channel	Frequency (MHz)	Conducted Power (dBm)	G _{T-Lc} (dB)	ERP (dBm)	ERP (mW)	Limit (W)
133147	665.5	22.14	-7	12.99	19.91	3
133247	675.5	22.17	-7	13.02	20.04	3
133447	695.5	22.11	-7	12.96	19.77	3

CHANNEL BANDWIDTH: 5MHz 64QAM

Channel	Frequency (MHz)	Conducted Power (dBm)	G _{T-Lc} (dB)	ERP (dBm)	ERP (mW)	Limit (W)
133147	665.5	20.92	-7	11.77	15.03	3
133247	675.5	21.05	-7	11.9	15.49	3
133447	695.5	20.86	-7	11.71	14.83	3



Test Report No.: W7L-P23100014RF06

CHANNEL BANDWIDTH: 10MHz QPSK

Channel	Frequency (MHz)	Conducted Power (dBm)	G _T -L _c (dB)	ERP (dBm)	ERP (mW)	Limit (W)
133172	668	22.63	-7	13.48	22.28	3
133272	678	22.8	-7	13.65	23.17	3
133422	693	22.68	-7	13.53	22.54	3

CHANNEL BANDWIDTH: 10MHz 16QAM

Channel	Frequency (MHz)	Conducted Power (dBm)	G _T -L _c (dB)	ERP (dBm)	ERP (mW)	Limit (W)
133172	668	22.14	-7	12.99	19.91	3
133272	678	22.18	-7	13.03	20.09	3
133422	693	22.08	-7	12.93	19.63	3

CHANNEL BANDWIDTH: 10MHz 64QAM

Channel	Frequency (MHz)	Conducted Power (dBm)	G _T -L _c (dB)	ERP (dBm)	ERP (mW)	Limit (W)
133172	668	20.91	-7	11.76	15	3
133272	678	21.06	-7	11.91	15.52	3
133422	693	20.83	-7	11.68	14.72	3



Test Report No.: W7L-P23100014RF06

CHANNEL BANDWIDTH: 15MHz QPSK

Channel	Frequency (MHz)	Conducted Power (dBm)	G _T -L _C (dB)	ERP (dBm)	ERP (mW)	Limit (W)
133197	670.5	22.64	-7	13.49	22.34	3
133297	680.5	22.78	-7	13.63	23.07	3
133397	690.5	22.71	-7	13.56	22.7	3

CHANNEL BANDWIDTH: 15MHz 16QAM

Channel	Frequency (MHz)	Conducted Power (dBm)	G _T -L _C (dB)	ERP (dBm)	ERP (mW)	Limit (W)
133197	670.5	22.13	-7	12.98	19.86	3
133297	680.5	22.19	-7	13.04	20.14	3
133397	690.5	22.11	-7	12.96	19.77	3

CHANNEL BANDWIDTH: 15MHz 64QAM

Channel	Frequency (MHz)	Conducted Power (dBm)	G _T -L _C (dB)	ERP (dBm)	ERP (mW)	Limit (W)
133197	670.5	20.98	-7	11.83	15.24	3
133297	680.5	21.08	-7	11.93	15.6	3
133397	690.5	20.82	-7	11.67	14.69	3



Test Report No.: W7L-P23100014RF06

CHANNEL BANDWIDTH: 20MHz QPSK

Channel	Frequency (MHz)	Conducted Power (dBm)	G _T -L _c (dB)	ERP (dBm)	ERP (mW)	Limit (W)
133222	673	22.71	-7	13.56	22.7	3
133322	683	22.84	-7	13.69	23.39	3
133372	688	22.73	-7	13.58	22.8	3

CHANNEL BANDWIDTH: 20MHz 16QAM

Channel	Frequency (MHz)	Conducted Power (dBm)	G _T -L _c (dB)	ERP (dBm)	ERP (mW)	Limit (W)
133222	673	22.16	-7	13.01	20	3
133322	683	22.25	-7	13.1	20.42	3
133372	688	22.13	-7	12.98	19.86	3

CHANNEL BANDWIDTH: 20MHz 64QAM

Channel	Frequency (MHz)	Conducted Power (dBm)	G _T -L _c (dB)	ERP (dBm)	ERP (mW)	Limit (W)
133222	673	20.99	-7	11.84	15.28	3
133322	683	21.1	-7	11.95	15.67	3
133372	688	20.88	-7	11.73	14.89	3

REMARKS: ERP Output Power (dBm) = EIRP (dBm) -2.15(dB).

3.2 FREQUENCY STABILITY MEASUREMENT

3.2.1 LIMITS OF FREQUENCY STABILITY MEASUREMENT

The frequency stability shall be sufficient to ensure that the fundamental emissions stay within the authorized bands of operation.

3.2.2 TEST PROCEDURE

- a. Device is placed at the oven room. The oven room could control the temperatures and humidity. Power warm up is at least 15 min and power applied should perform before recording frequency error.
- b. EUT is connected the external power supply to control the DC input power. The test voltage range is from minimum to maximum working voltage. Each step shall be record the frequency error rate.
- c. The temperature range step is 10 degrees in this test items. All temperature levels shall be hold the $\pm 0.5^{\circ}\text{C}$ during the measurement testing. The each temperature step shall be at least 0.5 hours, consider the EUT could be test under the stability condition.

NOTE: The frequency error was recorded frequency error from the communication simulator.

3.2.3 TEST SETUP

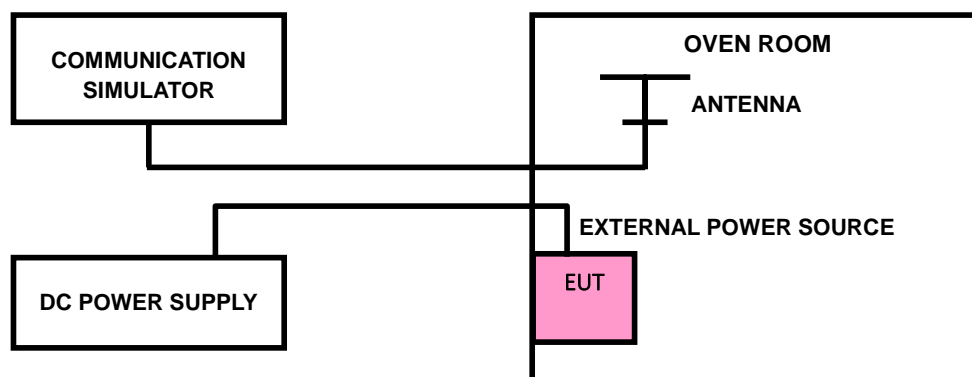



Test Report No.: W7L-P23100014RF06

3.2.4 TEST RESULTS

Please Refer to Appendix Of this test report.

Note: VL = Low voltage(3.6V); VN/NV = Normal voltage(3.7V); VH = High voltage(4.2V);
NT = Normal temperature (25°C)

3.3 OCCUPIED BANDWIDTH MEASUREMENT

3.3.1 LIMITS OF OCCUPIED BANDWIDTH MEASUREMENT

The width of a frequency band such that, below the lower and above the upper frequency limits, the mean powers emitted are each equal to a specified percentage 0.5 % of the total mean power of a given emission.

3.3.2 TEST SETUP

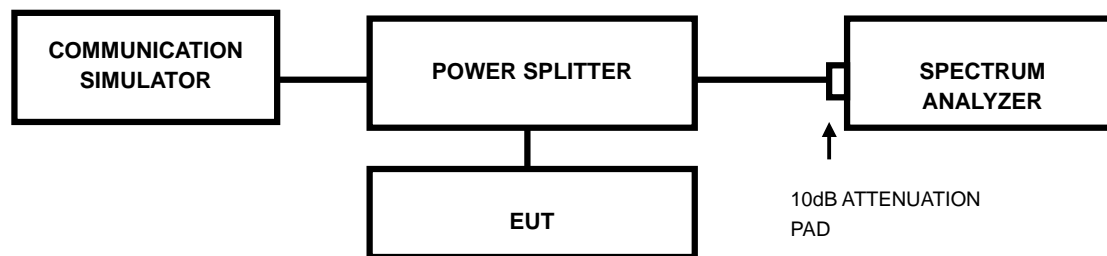

3.3.3 TEST PROCEDURES

- The conducted occupied bandwidth used the power splitter via EUT RF power connector between simulation base station and spectrum analyzer.
- Use OBW measurement function of Spectrum analyzer to measure 99 % occupied bandwidth.



Test Report No.: W7L-P23100014RF06

3.3.4 TEST RESULTS

Please Refer to Appendix Of this test report.

3.4 BAND EDGE MEASUREMENT

3.4.1 LIMITS OF BAND EDGE MEASUREMENT

According to FCC 27.53(c) specified that For operations in the 746-758 MHz band and the 776-788 MHz band , the power of any emission shall be attenuated outside the band below the transmitter power (P) by at least $43 + 10 \log (P)$ dB. However, in the 100 kilohertz bands immediately outside and adjacent to a licensee's frequency block, a resolution bandwidth of at least 30 kHz may be employed. In addition, the power of any unwanted emission in an 6.25kHz bandwidth for all frequencies between 763-775 MHz and 793-806 MHz shall be attenuated below the transmitter power, P(dBW), by at least $65 + 10 \log 10 P(P)$, dB, for mobile and portable equipment.

According to FCC 27.53(g) specified that For operations in the 600 MHz band and the 698-746 MHz band, the power of any emission outside a licensee's frequency band(s) of operation shall be attenuated below the transmitter power (P) within the licensed band(s) of operation, measured in watts, by at least $43 + 10 \log (P)$ dB. However, in the 100 kilohertz bands immediately outside and adjacent to a licensee's frequency block, a resolution bandwidth of at least 30 kHz may be employed.

According to FCC 27.53(h) specified that For operations in the 1710-1755 MHz band, the power of any emission outside a licensee's frequency band(s) of operation shall be attenuated below the transmitter power (P) within the licensed band(s) of operation, measured in watts, by at least $43 + 10 \log (P)$ dB. However, in the 1 megahertz bands immediately outside and adjacent to the licensee's frequency block, a resolution bandwidth of at least one percent of the emission bandwidth of the fundamental emission of the transmitter may be employed.

According to FCC 27.53(m)(4) specified that For mobile digital stations, the attenuation factor shall be not less than $40 + 10 \log (P)$ dB on all frequencies between the channel edge and 5 megahertz from the channel edge, $43 + 10 \log (P)$ dB on all frequencies between 5 megahertz and X megahertz from the channel edge, and $55 + 10 \log (P)$ dB on all frequencies more than X megahertz from the channel edge, where X is the greater of 6 megahertz or the actual emission bandwidth as defined in paragraph (m)(6) of this section. In addition, the attenuation factor shall not be less that $43 + 10 \log (P)$ dB on all frequencies between 2490.5 MHz and 2496 MHz and $55 + 10 \log (P)$ dB at or below 2490.5 MHz. Mobile Satellite Service licensees operating on frequencies below 2495 MHz may also submit a documented interference complaint against BRS licensees operating on channel BRS Channel 1 on the same terms and conditions as adjacent channel BRS or EBS licensees. For mobile digital stations, in the 1 megahertz bands immediately outside and adjacent to the frequency block a resolution bandwidth of at least two percent may be employed.



Test Report No.: W7L-P23100014RF06

According to FCC 27.53(a)(4) specified that For mobile and portable stations operating in the 2305-2315 MHz and 2350-2360 MHz bands:

- (i) By a factor of not less than: $43 + 10 \log (P)$ dB on all frequencies between 2305 and 2320 MHz and on all frequencies between 2345 and 2360 MHz that are outside the licensed band(s) of operation, not less than $55 + 10 \log (P)$ dB on all frequencies between 2320 and 2324 MHz and on all frequencies between 2341 and 2345 MHz, not less than $61 + 10 \log (P)$ dB on all frequencies between 2324 and 2328 MHz and on all frequencies between 2337 and 2341 MHz, and not less than $67 + 10 \log (P)$ dB on all frequencies between 2328 and 2337 MHz;
- (ii) By a factor of not less than $43 + 10 \log (P)$ dB on all frequencies between 2300 and 2305 MHz, $55 + 10 \log (P)$ dB on all frequencies between 2296 and 2300 MHz, $61 + 10 \log (P)$ dB on all frequencies between 2292 and 2296 MHz, $67 + 10 \log (P)$ dB on all frequencies between 2288 and 2292 MHz, and $70 + 10 \log (P)$ dB below 2288 MHz;
- (iii) By a factor of not less than $43 + 10 \log (P)$ dB on all frequencies between 2360 and 2365 MHz, and not less than $70 + 10 \log (P)$ dB above 2365 MHz.

3.4.2 TEST SETUP

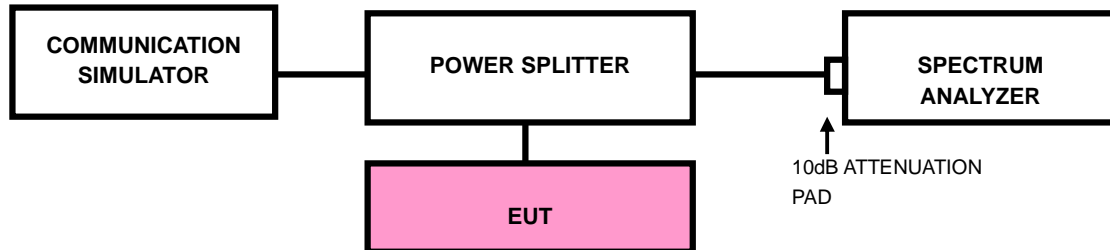



3.4.3 TEST PROCEDURES

- a) All measurements were done at low and high operational frequency range
- b) Connect the transmitter to the spectrum analyzer via coaxial cable while ensuring proper impedance matching.
- c) Tune the analyzer to the nominal center frequency of the emission bandwidth
(EBW)
- d) .Set the resolution bandwidth (RBW) $\geq 1\%$ EBW in the 1MHz band immediately outside and adjacent to the band edge.
- e) Beyond the 1MHz band from the band edge, RBW=1MHz was used.
- f) Set the video bandwidth (VBW) to $\geq 3 \times$ RBW.
- g) Select the average power (RMS) display detector.
- h) Set the number of measurement points to ≥ 1001 .
- i) Use auto-coupled sweep time.
- j) Perform the measurement over an interval of time when the transmission is continuous and at its maximum power level.
- k) The RF fundamental frequency should be excluded against the limit line in the operating frequency band and use RBW is 10KHz or 100KHz.
- l) Record the max trace plot into the test report.



Test Report No.: W7L-P23100014RF06

3.4.4 TEST RESULTS

Please Refer to Appendix Of this test report.

3.5 CONDUCTED SPURIOUS EMISSIONS

3.5.1 LIMITS OF CONDUCTED SPURIOUS EMISSIONS MEASUREMENT

The power of any emission outside of the authorized operating frequency ranges must be attenuated below the transmitting power (P) by a factor of at least $43 + 10 \log(P)$ dB. The emission limit equal to -13dBm .

For: LTE Band7

The power of any emission outside a licensee's frequency block shall be attenuated below the transmitter power (P) by at least $55 + 10 \log_{10}(P)$ dB. The limit of emission is equal to -25dBm .

For: LTE Band30

The power of any emission outside a licensee's frequency block shall be attenuated below the transmitter power (P) by at least $70 + 10 \log_{10}(P)$ dB. The limit of emission is equal to -40dBm .

3.5.2 TEST PROCEDURE

- a. The EUT makes a phone call to the communication simulator. All measurements were done at low, middle and high operational frequency range.
- b. Measuring frequency range is from 9kHz up to a frequency including its 10th harmonic. 10dB attenuation pad is connected with spectrum. RBW=1MHz and VBW=3MHz is used for conducted emission measurement.

3.5.3 TEST SETUP

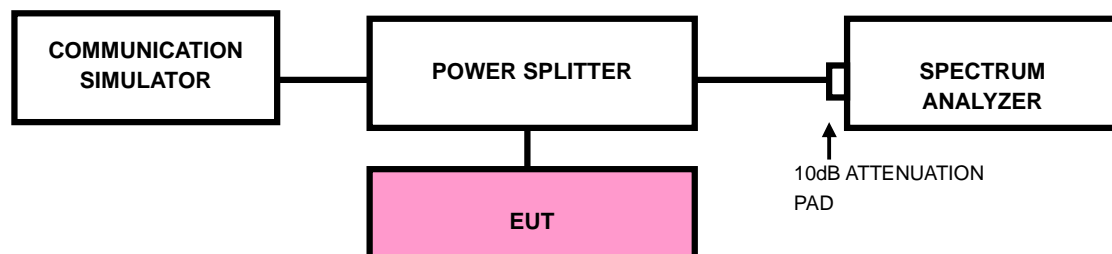



Test Report No.: W7L-P23100014RF06

3.5.4 TEST RESULTS

NOTE : The 9K~30MHz amplitude of spurious emissions attenuated more than 20 dB below the permissible value is not required in the report.

Please Refer to Appendix Of this test report.



3.6 RADIATED EMISSION MEASUREMENT

3.6.1 LIMITS OF RADIATED EMISSION MEASUREMENT

The power of any emission outside of the authorized operating frequency ranges must be attenuated below the transmitting power (P) by a factor of at least $43 + 10 \log(P)$ dB. The emission limit equal to -13dBm .

For: LTE Band7/ Band41

The power of any emission outside a licensee's frequency block shall be attenuated below the transmitter power (P) by at least $55 + 10 \log_{10}(P)$ dB. The limit of emission is equal to -25dBm .

3.6.2 TEST PROCEDURES

- a. Substitution method is used for E.I.R.P measurement. In the semi-anechoic chamber, EUT placed on the 0.8m height of Turn Table, rotated the table around 360 degrees to search the maximum radiation power and receiver antenna shall be rotated vertical and horizontal polarization and moved height from 1m to 4m to find the maximum polar radiated power. The "Read Value" is the spectrum reading the maximum power value.
- b. The substitution horn antenna is substituted for EUT at the same position and signals generator export the CW signal to the substitution antenna via a TX cable. Rotated the Turn Table and moved receiving antenna to find the maximum radiation power. Adjust output power level of S.G to get a Value of spectrum reading equal to "Read Value" of step a. Record the power level of S.G.
- c. $\text{EIRP} = \text{Output power level of S.G} - \text{TX cable loss} + \text{Antenna gain of substitution horn}$.
- d. E.R.P power can be calculated form E.I.R.P power by subtracting the gain of dipole, $\text{E.R.P power} = \text{E.I.P.R power} - 2.15\text{dBi}$.

NOTE: The resolution bandwidth of spectrum analyzer is 1 MHz and the video bandwidth is 3 MHz.

3.6.3 DEVIATION FROM TEST STANDARD

No deviation

3.6.4 TEST SETUP

< Frequency Range below 30MHz >

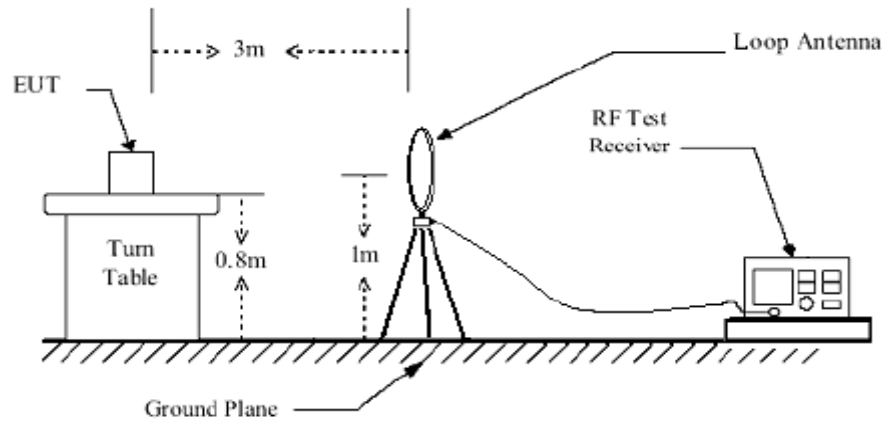

< Frequency Range 30MHz~1GHz >

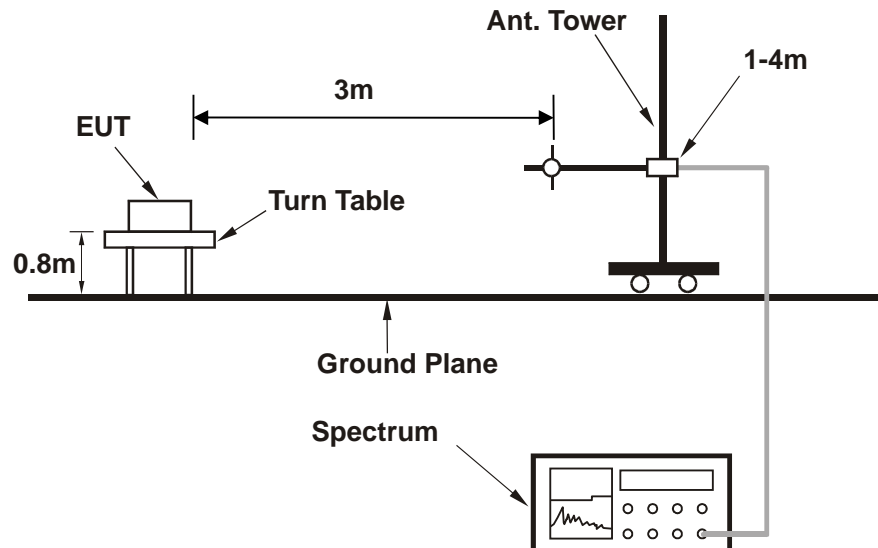

<Frequency Range above 1GHz>

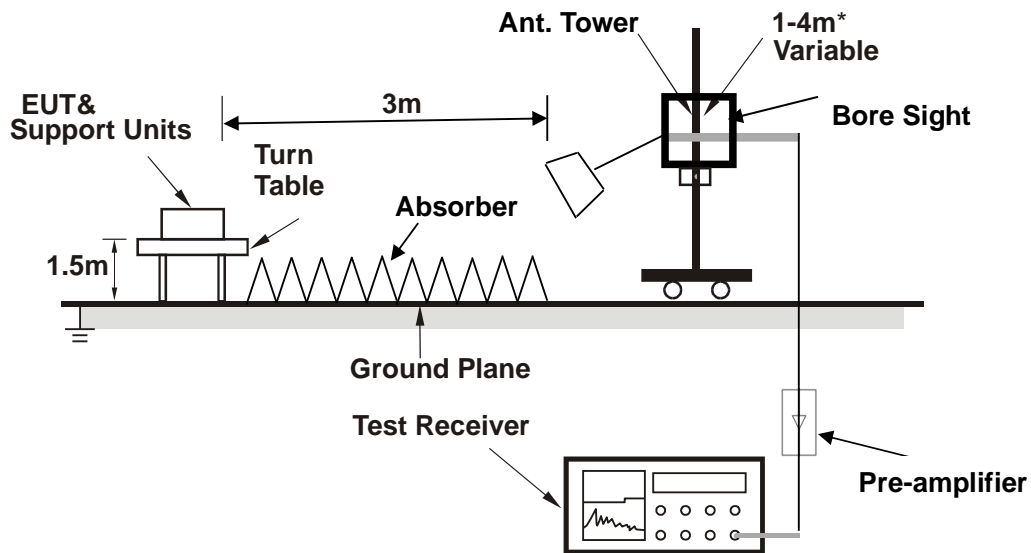

Note: Above 1G is a directional antenna depends on the EUT height and the antenna 3dB beamwidth both, refer to section 7.3 of CISPR 16-2-3.

For the actual test configuration, please refer to the attached file (Test Setup Photo).



3.6.5 TEST RESULTS

NOTE : The 9K~30MHz amplitude of spurious emissions attenuated more than 20 dB below the permissible value is not required in the report.

BELOW 1GHz WORST-CASE DATA

30 MHz – 1GHz data:

LTE Band 30

CHANNEL BANDWIDTH: 5MHz / QPSK

MODE	TX channel 27710	FREQUENCY RANGE	Below 1000MHz
ENVIRONMENTAL CONDITIONS	23deg. C, 70%RH	INPUT POWER	AC 120V/60HZ
TESTED BY	Jace Hu		
ANTENNA POLARITY & TEST DISTANCE: HORIZONTAL AT 3 M			

	Freq	Level	Read Level	Limit Line	Over Limit	Factor	Remark	Pol/Phase
	MHz	dBm/m	dBm	dBm/m	dB	dB/m		
1	34.850	-66.14	-54.10	-40.00	-26.14	-12.04	Peak	Horizontal
2	72.680	-63.87	-42.62	-40.00	-23.87	-21.25	Peak	Horizontal
3	216.240	-68.47	-52.99	-40.00	-28.47	-15.48	Peak	Horizontal
4 PP	245.340	-62.95	-50.94	-40.00	-22.95	-12.01	Peak	Horizontal
5	342.340	-68.87	-57.44	-40.00	-28.87	-11.43	Peak	Horizontal
6	422.850	-70.51	-60.89	-40.00	-30.51	-9.62	Peak	Horizontal

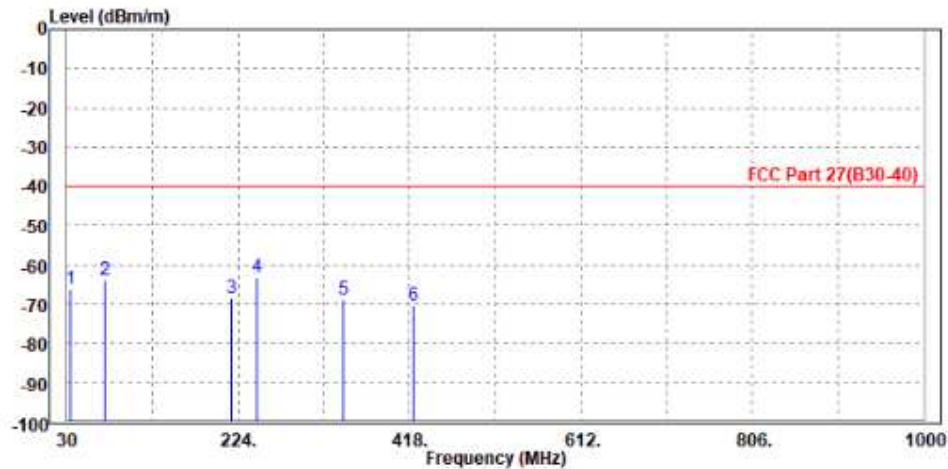



Test Report No.: W7L-P23100014RF06

MODE	TX channel 27710	FREQUENCY RANGE	Below 1000MHz
ENVIRONMENTAL CONDITIONS	23deg. C, 70%RH	INPUT POWER	AC 120V/60HZ
TESTED BY	Jace Hu		
ANTENNA POLARITY & TEST DISTANCE: VERTICAL AT 3 M			

	Freq	Level	Read Level	Limit Line	Over Limit	Factor	Remark	Pol/Phase
	MHz	dBm/m	dBm	dBm/m	dB	dB/m		
1	34.850	-64.16	-43.59	-40.00	-24.16	-20.57	Peak	Vertical
2	84.320	-59.41	-41.73	-40.00	-19.41	-17.68	Peak	Vertical
3 PP	100.810	-57.57	-50.87	-40.00	-17.57	-6.70	Peak	Vertical
4	141.550	-69.39	-55.65	-40.00	-29.39	-13.74	Peak	Vertical
5	243.400	-69.17	-54.99	-40.00	-29.17	-14.18	Peak	Vertical
6	341.370	-70.46	-60.40	-40.00	-30.46	-10.06	Peak	Vertical

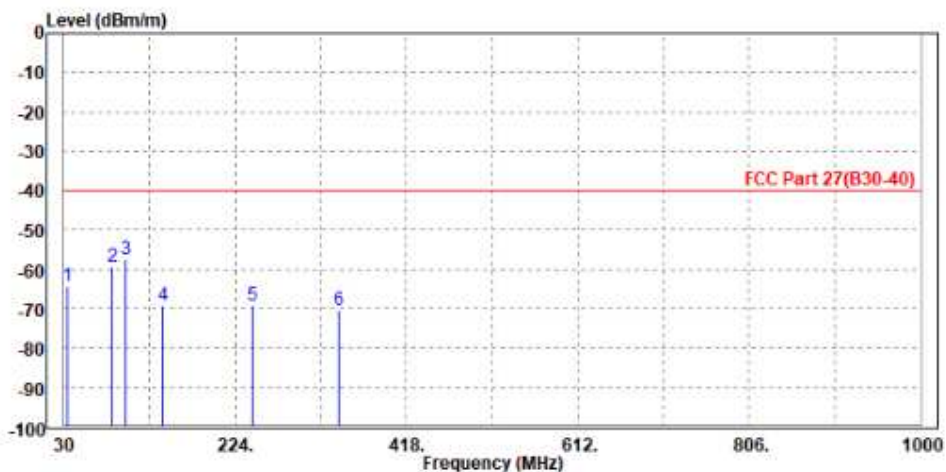



Test Report No.: W7L-P23100014RF06

ABOVE 1GHz

Note: For higher frequency, the emission is too low to be detected.

WCDMA Band IV:

CH 1312

MODE	TX channel 1312	FREQUENCY RANGE	Above 1000MHz
ENVIRONMENTAL CONDITIONS	23deg. C, 70%RH	INPUT POWER	AC 120V/60HZ
TESTED BY	Jace Hu		
ANTENNA POLARITY & TEST DISTANCE: HORIZONTAL AT 3 M			

Rg	Frequency [MHz]	PK+ Level [dBm]	PK+ Limit [dBm]	PK+ Margin [dB]	Correction [dB]	Polarization	Azimuth [deg]	Antenna Height [m]
4	3,423.000	-52.67	-13.00	39.67	21.92	H	181.2	1
5	7,897.500	-43.72	-13.00	30.72	33.01	H	1	1

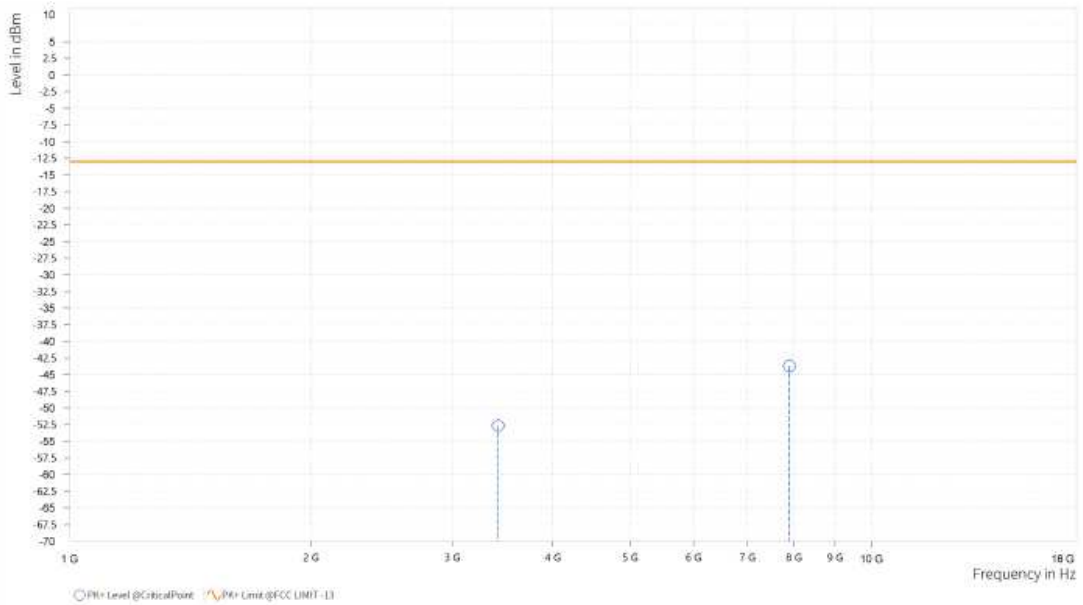



Test Report No.: W7L-P23100014RF06

MODE	TX channel 1312	FREQUENCY RANGE	Above 1000MHz
ENVIRONMENTAL CONDITIONS	23deg. C, 70%RH	INPUT POWER	AC 120V/60HZ
TESTED BY	Jace Hu		
ANTENNA POLARITY & TEST DISTANCE: VERTICAL AT 3 M			

Rg	Frequency [MHz]	PK+ Level [dBm]	PK+ Limit [dBm]	PK+ Margin [dB]	Correction [dB]	Polarization	Azimuth [deg]	Antenna Height [m]
4	3,425.500	-53.01	-13.00	40.01	22.00	V	359	2
5	7,978.000	-43.90	-13.00	30.90	33.29	V	1	1

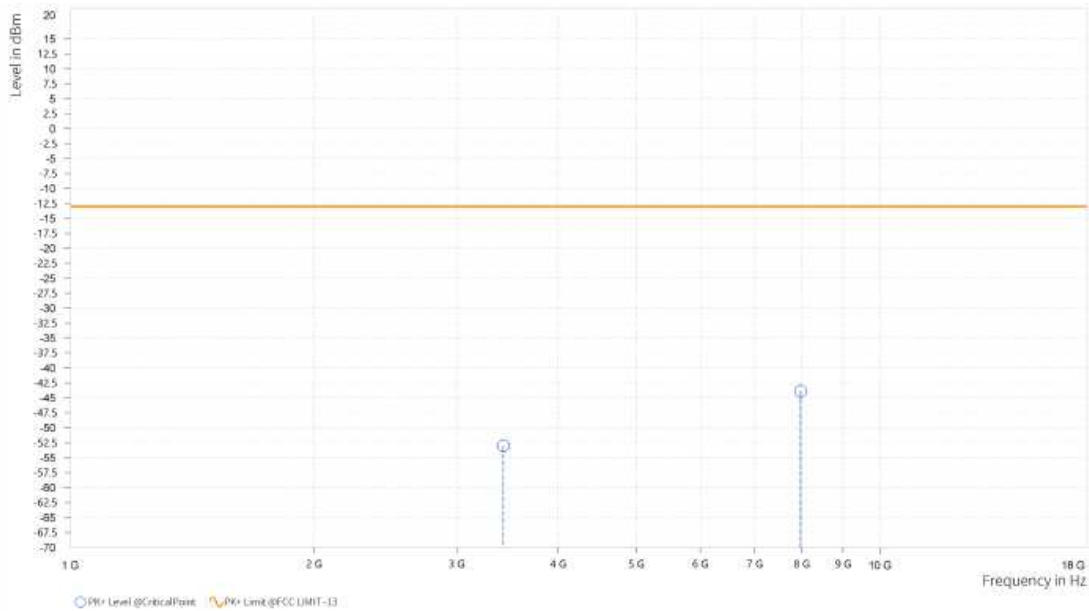



Test Report No.: W7L-P23100014RF06

CH 1413

MODE	TX channel 1413	FREQUENCY RANGE	Above 1000MHz
ENVIRONMENTAL CONDITIONS	23deg. C, 70%RH	INPUT POWER	AC 120V/60HZ
TESTED BY	Jace Hu		
ANTENNA POLARITY & TEST DISTANCE: HORIZONTAL AT 3 M			

Rg	Frequency [MHz]	PK+ Level [dBm]	PK+ Limit [dBm]	PK+ Margin [dB]	Correction [dB]	Polarization	Azimuth [deg]	Antenna Height [m]
4	3,462.500	-53.81	-13.00	40.81	21.84	H	1	2
5	7,938.500	-44.01	-13.00	31.01	32.99	H	1	1

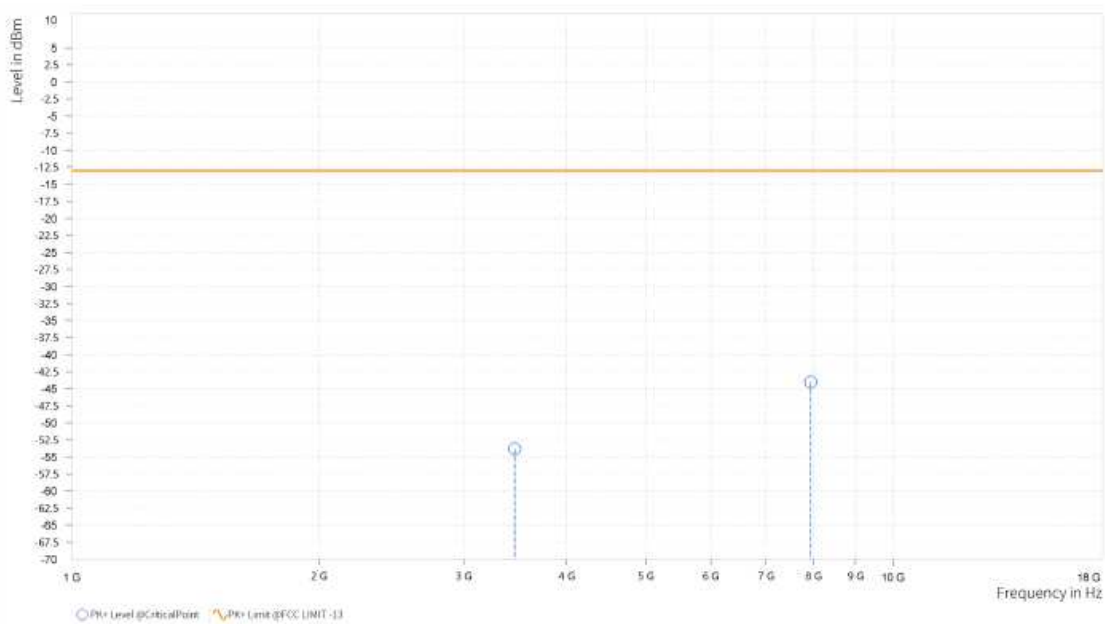



Test Report No.: W7L-P23100014RF06

MODE	TX channel 1413	FREQUENCY RANGE	Above 1000MHz
ENVIRONMENTAL CONDITIONS	23deg. C, 70%RH	INPUT POWER	AC 120V/60HZ
TESTED BY	Jace Hu		
ANTENNA POLARITY & TEST DISTANCE: VERTICAL AT 3 M			

Rg	Frequency [MHz]	PK+ Level [dBm]	PK+ Limit [dBm]	PK+ Margin [dB]	Correction [dB]	Polarization	Azimuth [deg]	Antenna Height [m]
4	3,468.500	-53.43	-13.00	40.43	21.90	V	1	2
5	7,987.000	-43.31	-13.00	30.31	33.32	V	359	1

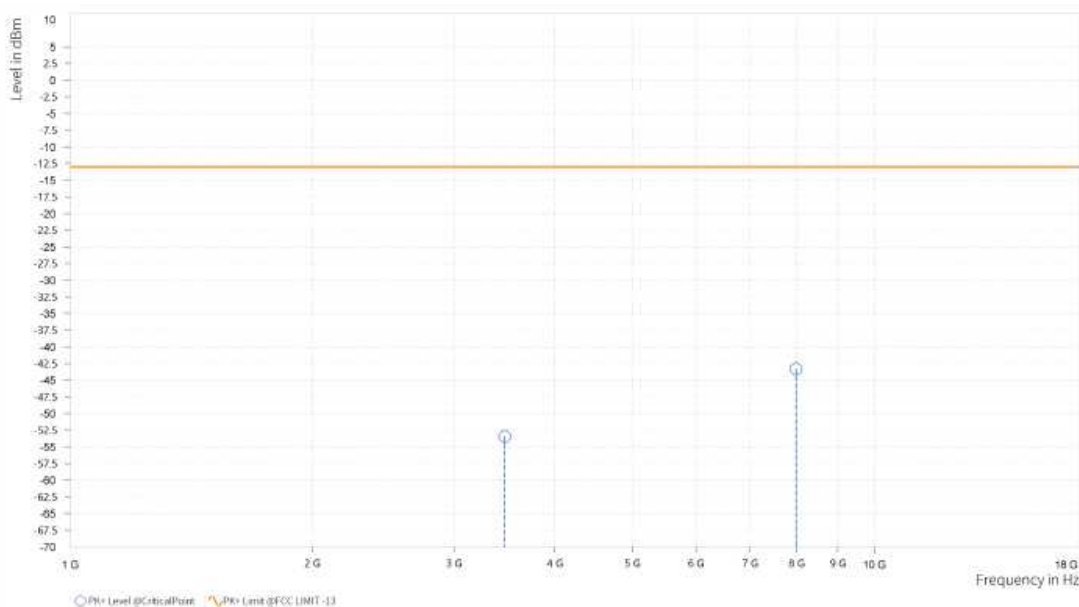



Test Report No.: W7L-P23100014RF06

CH 1513

MODE	TX channel 1513	FREQUENCY RANGE	Above 1000MHz
ENVIRONMENTAL CONDITIONS	23deg. C, 70%RH	INPUT POWER	AC 120V/60HZ
TESTED BY	Jace Hu		
ANTENNA POLARITY & TEST DISTANCE: HORIZONTAL AT 3 M			

Rg	Frequency [MHz]	PK+ Level [dBm]	PK+ Limit [dBm]	PK+ Margin [dB]	Correction [dB]	Polarization	Azimuth [deg]	Antenna Height [m]
4	3,502.000	-53.28	-13.00	40.28	21.81	H	180	1
5	7,875.500	-43.91	-13.00	30.91	33.00	H	0.9	2

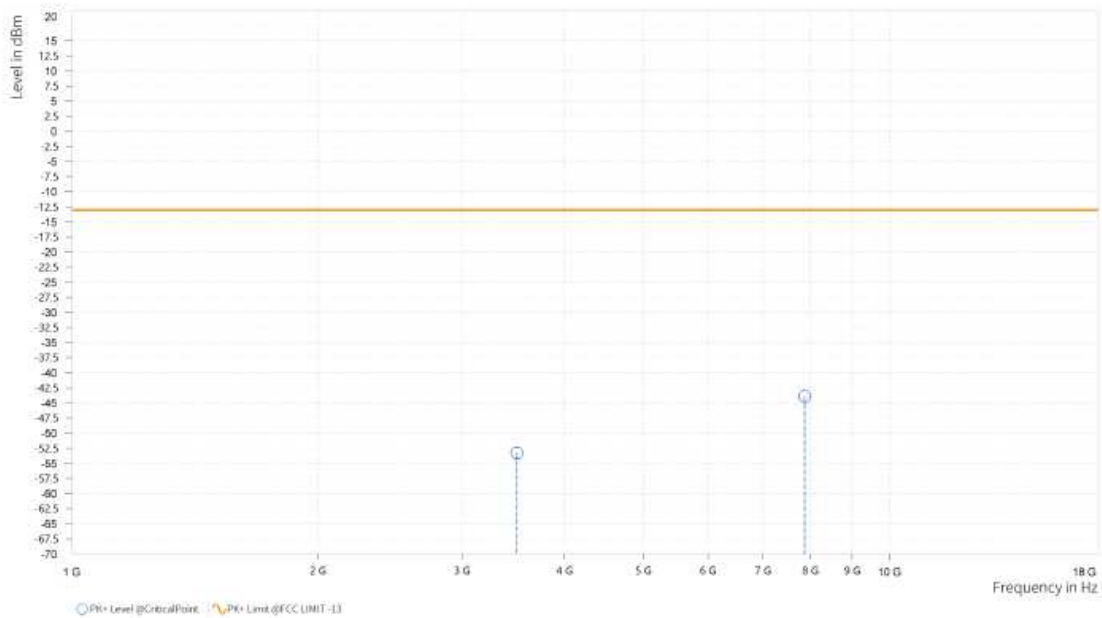



Test Report No.: W7L-P23100014RF06

MODE	TX channel 1513	FREQUENCY RANGE	Above 1000MHz
ENVIRONMENTAL CONDITIONS	23deg. C, 70%RH	INPUT POWER	AC 120V/60HZ
TESTED BY	Jace Hu		
ANTENNA POLARITY & TEST DISTANCE: VERTICAL AT 3 M			

Rg	Frequency [MHz]	PK+ Level [dBm]	PK+ Limit [dBm]	PK+ Margin [dB]	Correction [dB]	Polarization	Azimuth [deg]	Antenna Height [m]
4	3,504.000	-53.94	-13.00	40.94	21.95	V	359	2
5	7,841.500	-44.14	-13.00	31.14	33.06	V	359	2

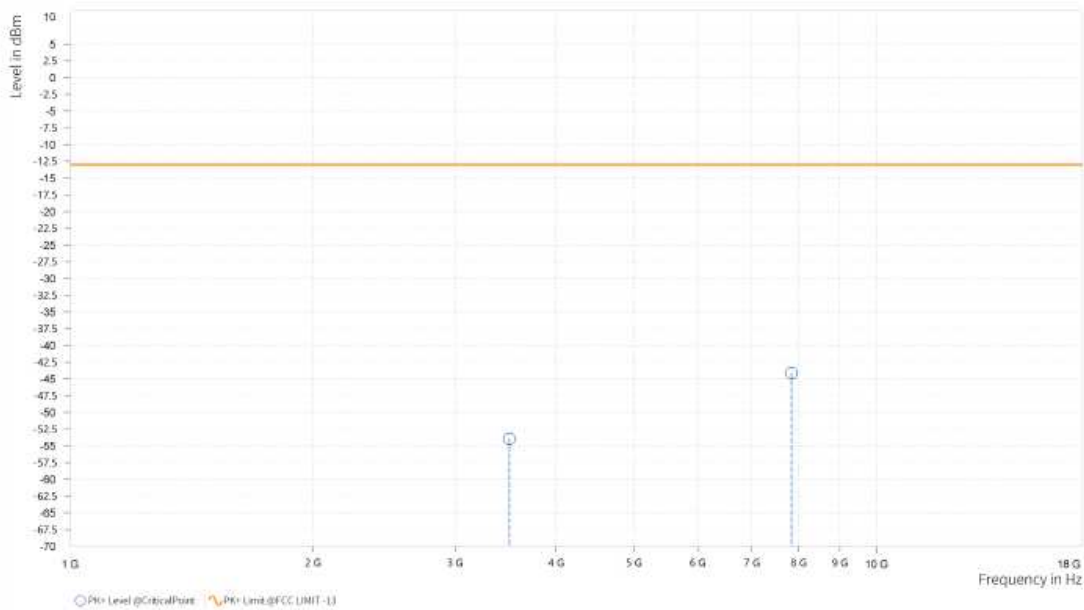



Test Report No.: W7L-P23100014RF06

LTE Band 7
 CHANNEL BANDWIDTH: 5MHz / QPSK
 CH 20775

MODE	TX channel 20775	FREQUENCY RANGE	Above 1000MHz
ENVIRONMENTAL CONDITIONS	23deg. C, 70%RH	INPUT POWER	AC 120V/60HZ
TESTED BY	Jace Hu		
ANTENNA POLARITY & TEST DISTANCE: HORIZONTAL AT 3 M			

Rg	Frequency [MHz]	PK+ Level [dBm]	PK+ Limit [dBm]	PK+ Margin [dB]	Correction [dB]	Polarization	Azimuth [deg]	Antenna Height [m]
4	5,001.500	-50.03	-25.00	25.03	25.51	H	171.5	2
5	7,825.500	-39.75	-25.00	14.75	32.95	H	359	2

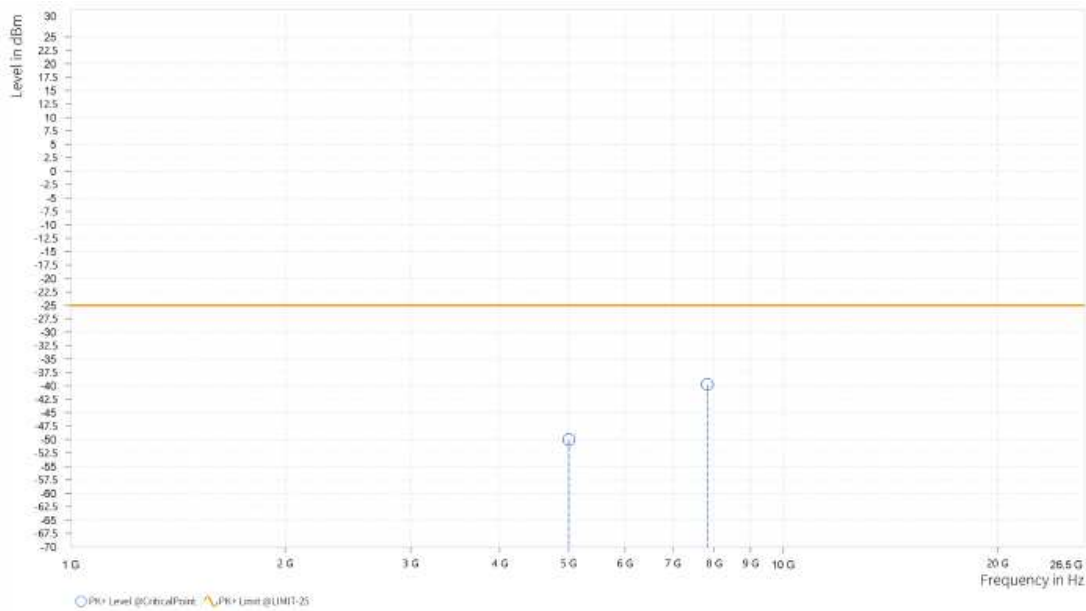



Test Report No.: W7L-P23100014RF06

MODE	TX channel 20775	FREQUENCY RANGE	Above 1000MHz
ENVIRONMENTAL CONDITIONS	23deg. C, 70%RH	INPUT POWER	AC 120V/60HZ
TESTED BY	Jace Hu		
ANTENNA POLARITY & TEST DISTANCE: VERTICAL AT 3 M			

Rg	Frequency [MHz]	PK+ Level [dBm]	PK+ Limit [dBm]	PK+ Margin [dB]	Correction [dB]	Polarization	Azimuth [deg]	Antenna Height [m]
4	5,001.000	-47.83	-25.00	22.83	25.34	V	165.5	2
5	7,882.500	-43.31	-25.00	18.31	33.04	V	1	1

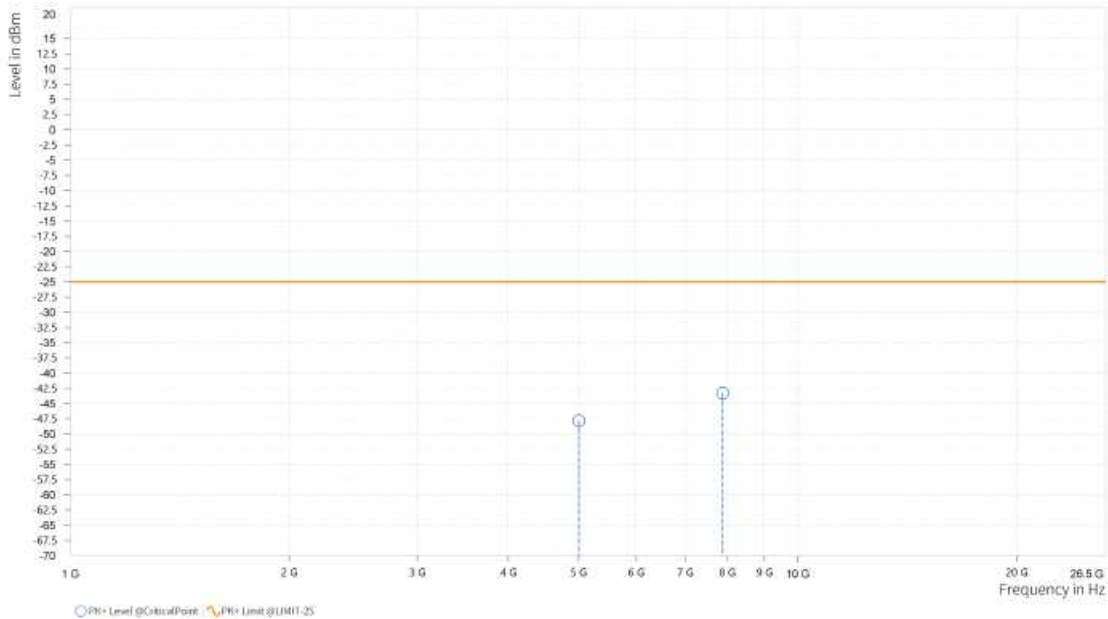



BUREAU
VERITAS

Test Report No.: W7L-P23100014RF06

CH 21100

MODE	TX channel 21100	FREQUENCY RANGE	Above 1000MHz
ENVIRONMENTAL CONDITIONS	23deg. C, 70%RH	INPUT POWER	AC 120V/60HZ
TESTED BY	Jace Hu		
ANTENNA POLARITY & TEST DISTANCE: HORIZONTAL AT 3 M			

Rg	Frequency [MHz]	PK+ Level [dBm]	PK+ Limit [dBm]	PK+ Margin [dB]	Correction [dB]	Polarization	Azimuth [deg]	Antenna Height [m]
4	5,066.000	-48.16	-25.00	23.16	25.73	H	359	2
5	7,504.000	-39.63	-25.00	14.63	31.87	H	269.7	1

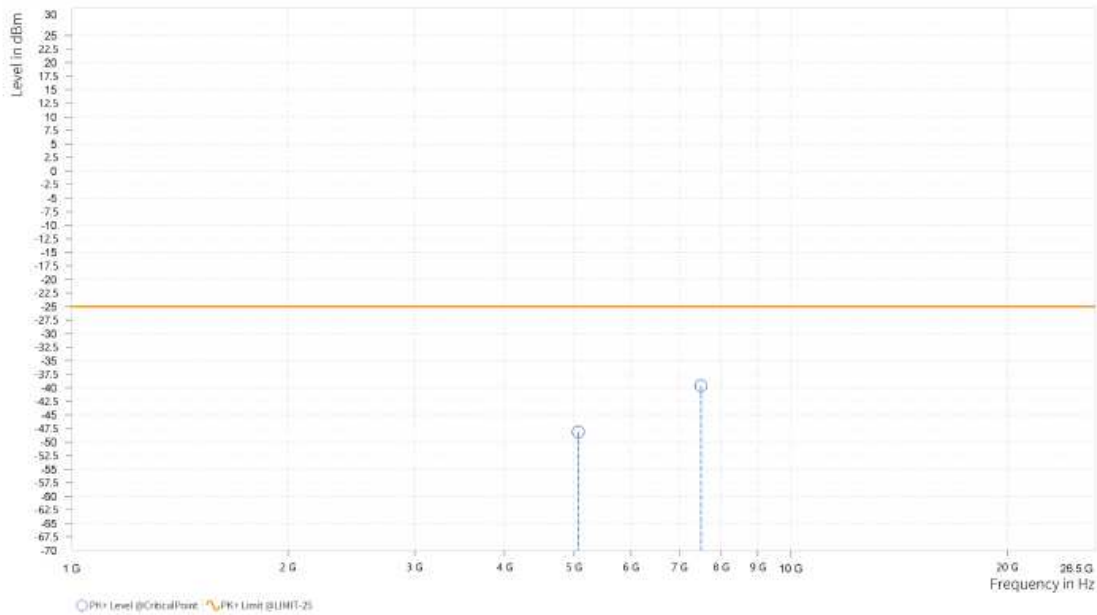



Test Report No.: W7L-P23100014RF06

MODE	TX channel 21100	FREQUENCY RANGE	Above 1000MHz
ENVIRONMENTAL CONDITIONS	23deg. C, 70%RH	INPUT POWER	AC 120V/60HZ
TESTED BY	Jace Hu		
ANTENNA POLARITY & TEST DISTANCE: VERTICAL AT 3 M			

Rg	Frequency [MHz]	PK+ Level [dBm]	PK+ Limit [dBm]	PK+ Margin [dB]	Correction [dB]	Polarization	Azimuth [deg]	Antenna Height [m]
4	5,066.000	-48.37	-25.00	23.37	25.66	V	1	1
5	7,434.500	-38.73	-25.00	13.73	31.74	V	1	1

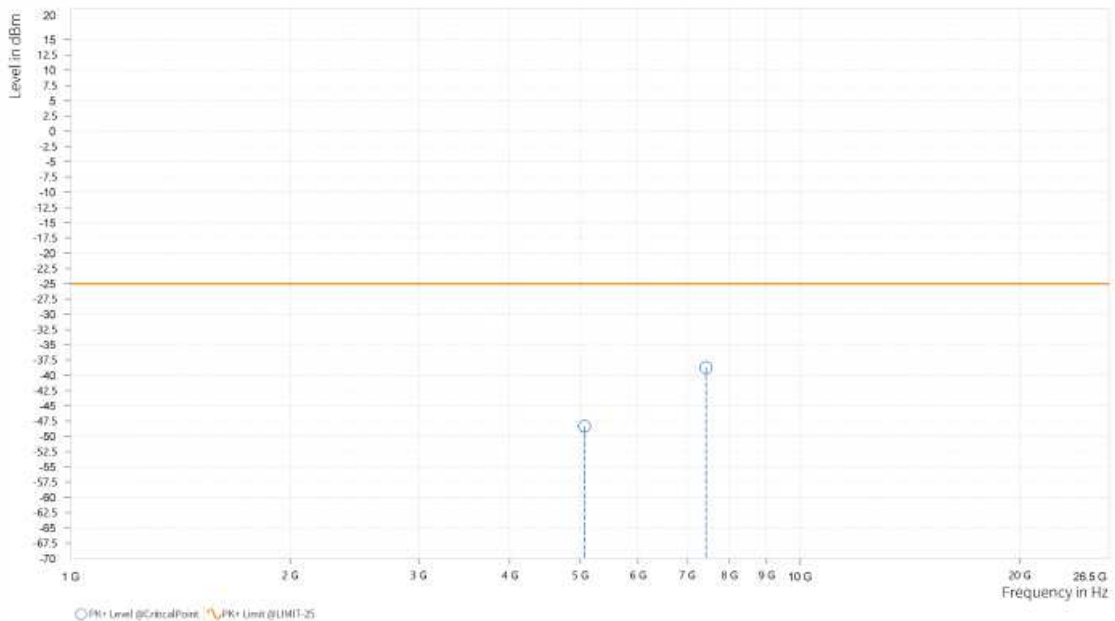



BUREAU
VERITAS

Test Report No.: W7L-P23100014RF06

CH 21425

MODE	TX channel 21425	FREQUENCY RANGE	Above 1000MHz
ENVIRONMENTAL CONDITIONS	23deg. C, 70%RH	INPUT POWER	AC 120V/60HZ
TESTED BY	Jace Hu		
ANTENNA POLARITY & TEST DISTANCE: HORIZONTAL AT 3 M			

Rg	Frequency [MHz]	PK+ Level [dBm]	PK+ Limit [dBm]	PK+ Margin [dB]	Correction [dB]	Polarization	Azimuth [deg]	Antenna Height [m]
4	5,130.500	-49.04	-25.00	24.04	26.20	H	170.3	2
5	7,752.000	-39.55	-25.00	14.55	32.83	H	1	1

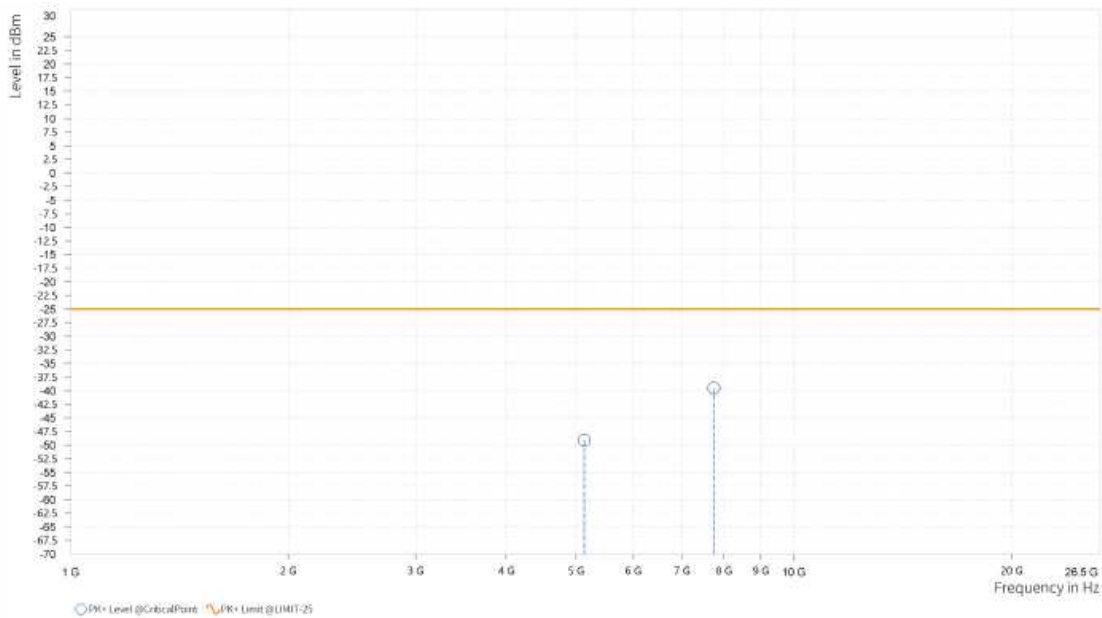



Test Report No.: W7L-P23100014RF06

MODE	TX channel 21425	FREQUENCY RANGE	Above 1000MHz
ENVIRONMENTAL CONDITIONS	23deg. C, 70%RH	INPUT POWER	AC 120V/60HZ
TESTED BY	Jace Hu		
ANTENNA POLARITY & TEST DISTANCE: VERTICAL AT 3 M			

Rg	Frequency [MHz]	PK+ Level [dBm]	PK+ Limit [dBm]	PK+ Margin [dB]	Correction [dB]	Polarization	Azimuth [deg]	Antenna Height [m]
4	5,130.500	-45.83	-25.00	20.83	26.21	V	359	2
5	7,806.500	-39.42	-25.00	14.42	33.06	V	1	1

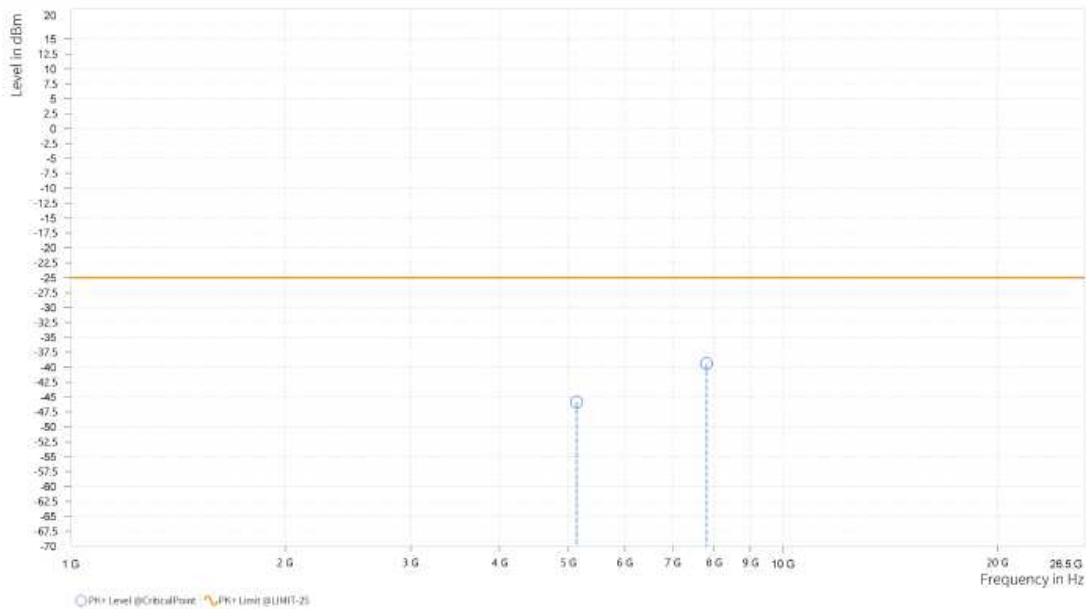



Test Report No.: W7L-P23100014RF06

CHANNEL BANDWIDTH: 10MHz / QPSK

MODE	TX channel 21100	FREQUENCY RANGE	Above 1000MHz
ENVIRONMENTAL CONDITIONS	23deg. C, 70%RH	INPUT POWER	AC 120V/60HZ
TESTED BY	Jace Hu		
ANTENNA POLARITY & TEST DISTANCE: HORIZONTAL AT 3 M			

Rg	Frequency [MHz]	PK+ Level [dBm]	PK+ Limit [dBm]	PK+ Margin [dB]	Correction [dB]	Polarization	Azimuth [deg]	Antenna Height [m]
4	5,061.000	-47.28	-25.00	22.28	25.69	H	359	2
5	7,765.500	-39.97	-25.00	14.97	32.83	H	0.9	2

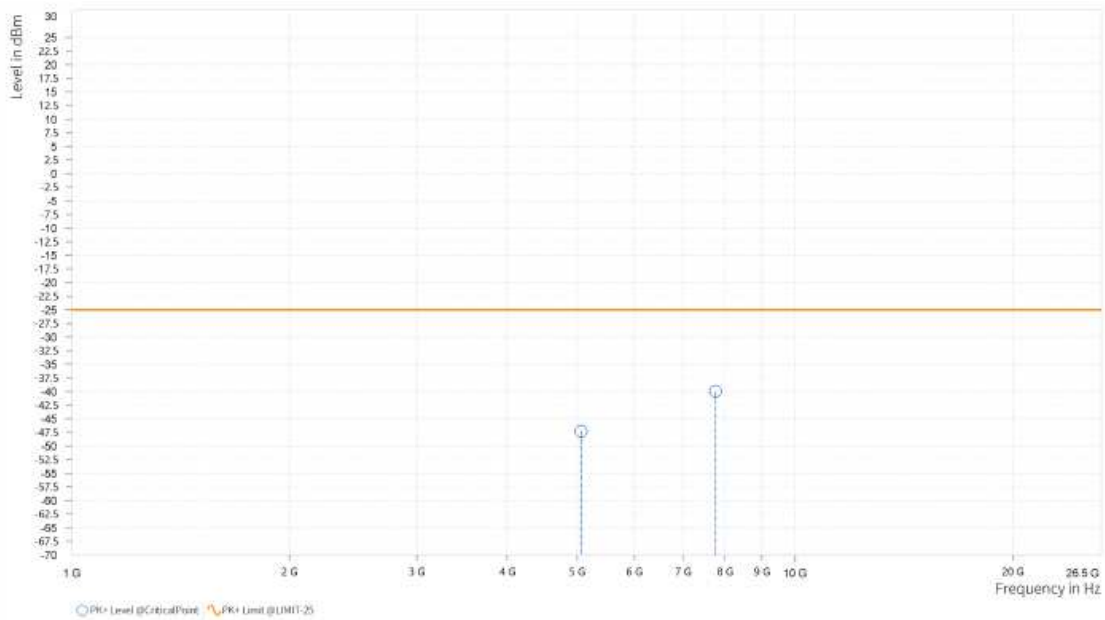



Test Report No.: W7L-P23100014RF06

MODE	TX channel 21100	FREQUENCY RANGE	Above 1000MHz
ENVIRONMENTAL CONDITIONS	23deg. C, 70%RH	INPUT POWER	AC 120V/60HZ
TESTED BY	Jace Hu		
ANTENNA POLARITY & TEST DISTANCE: VERTICAL AT 3 M			

Rg	Frequency [MHz]	PK+ Level [dBm]	PK+ Limit [dBm]	PK+ Margin [dB]	Correction [dB]	Polarization	Azimuth [deg]	Antenna Height [m]
4	5,061.500	-49.42	-25.00	24.42	25.60	V	1	1
5	7,798.000	-39.14	-25.00	14.14	33.05	V	359	2

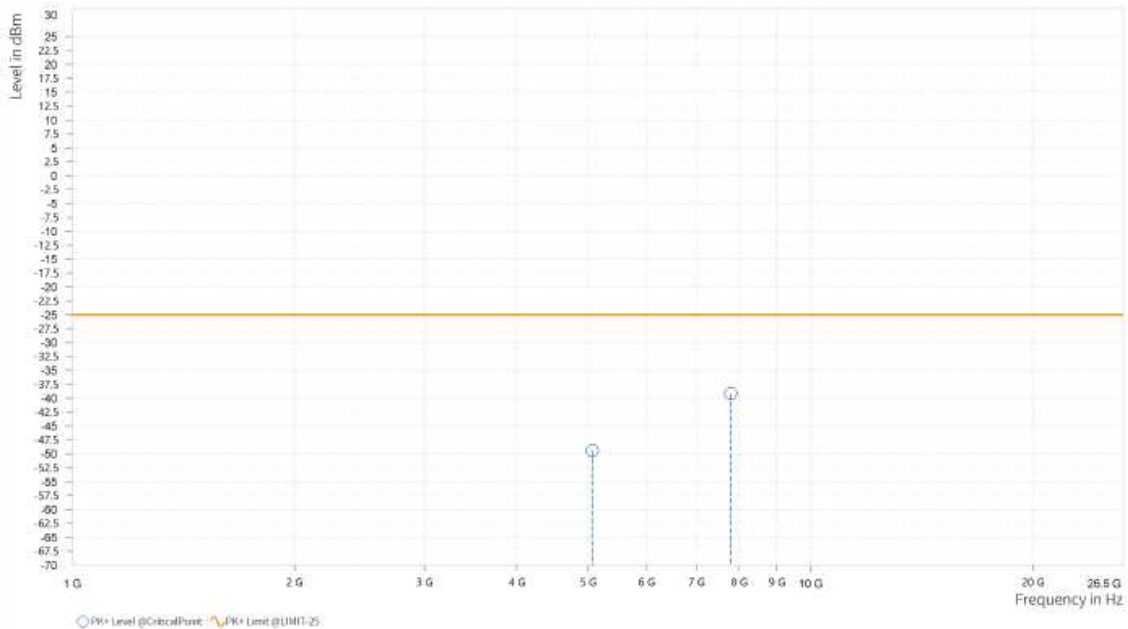



Test Report No.: W7L-P23100014RF06

CHANNEL BANDWIDTH: 15MHz / QPSK

MODE	TX channel 21100	FREQUENCY RANGE	Above 1000MHz
ENVIRONMENTAL CONDITIONS	23deg. C, 70%RH	INPUT POWER	AC 120V/60HZ
TESTED BY	Jace Hu		
ANTENNA POLARITY & TEST DISTANCE: HORIZONTAL AT 3 M			

Rg	Frequency [MHz]	PK+ Level [dBm]	PK+ Limit [dBm]	PK+ Margin [dB]	Correction [dB]	Polarization	Azimuth [deg]	Antenna Height [m]
4	5,071.500	-51.28	-25.00	26.28	25.78	H	359.1	1
5	7,741.500	-39.44	-25.00	14.44	32.82	H	85.4	2

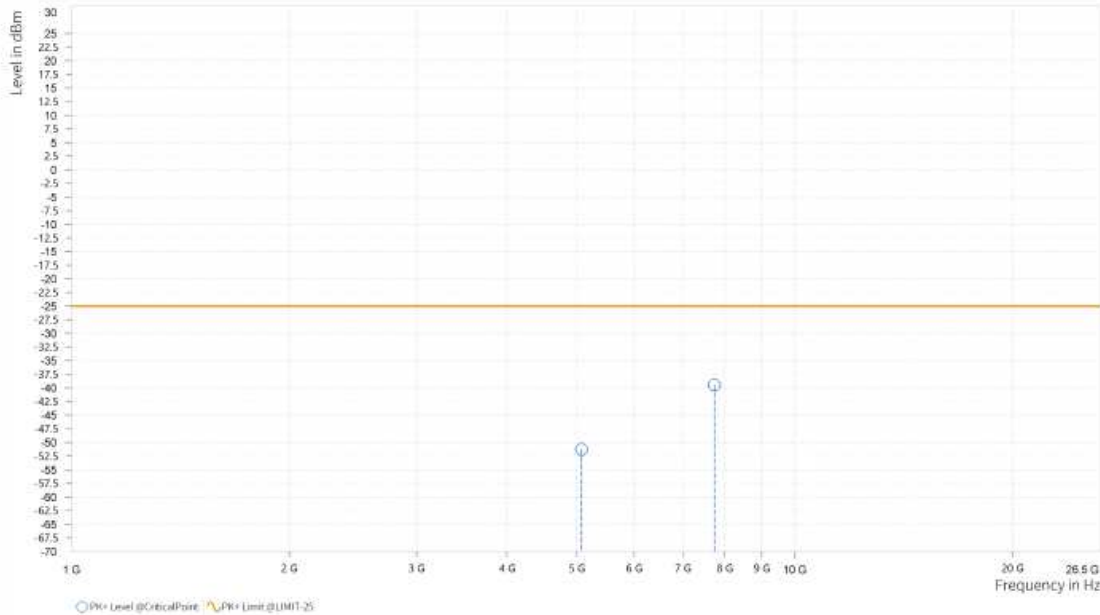



Test Report No.: W7L-P23100014RF06

MODE	TX channel 21100	FREQUENCY RANGE	Above 1000MHz
ENVIRONMENTAL CONDITIONS	23deg. C, 70%RH	INPUT POWER	AC 120V/60HZ
TESTED BY	Jace Hu		
ANTENNA POLARITY & TEST DISTANCE: VERTICAL AT 3 M			

Rg	Frequency [MHz]	PK+ Level [dBm]	PK+ Limit [dBm]	PK+ Margin [dB]	Correction [dB]	Polarization	Azimuth [deg]	Antenna Height [m]
4	5,056.500	-49.40	-25.00	24.40	25.56	V	1	1
5	7,723.000	-38.97	-25.00	13.97	32.98	V	359.1	1

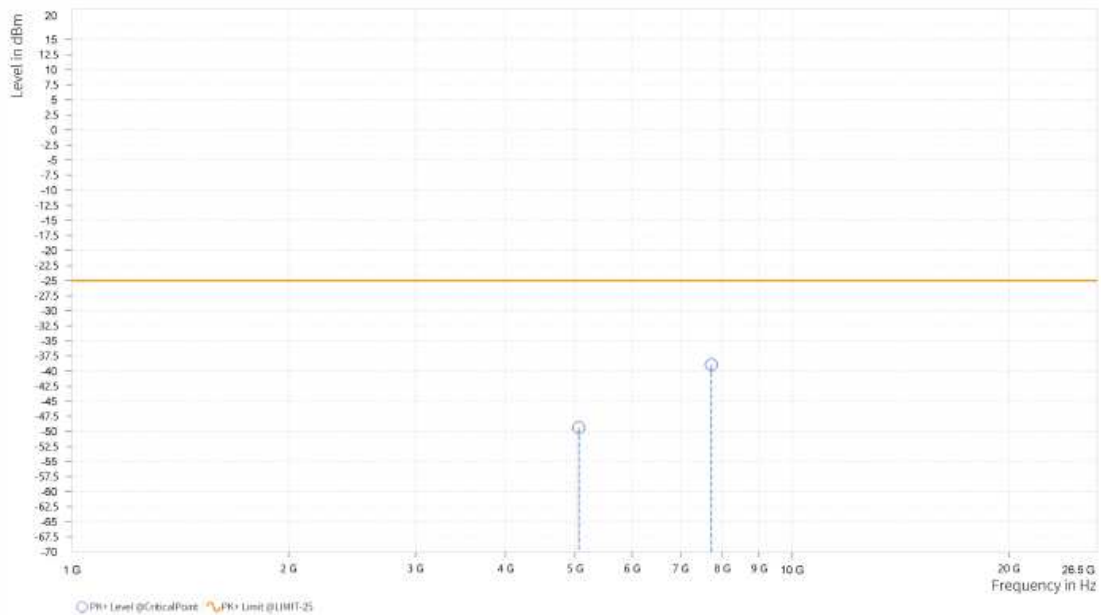



**BUREAU
VERITAS**

Test Report No.: W7L-P23100014RF06

CHANNEL BANDWIDTH: 20MHz / QPSK

MODE	TX channel 21100	FREQUENCY RANGE	Above 1000MHz
ENVIRONMENTAL CONDITIONS	23deg. C, 70%RH	INPUT POWER	AC 120V/60HZ
TESTED BY	Jace Hu		
ANTENNA POLARITY & TEST DISTANCE: HORIZONTAL AT 3 M			

Rg	Frequency [MHz]	PK+ Level [dBm]	PK+ Limit [dBm]	PK+ Margin [dB]	Correction [dB]	Polarization	Azimuth [deg]	Antenna Height [m]
4	5,070.500	-51.91	-25.00	26.91	25.77	H	160.8	2
5	7,496.000	-38.98	-25.00	13.98	31.83	H	0.9	2

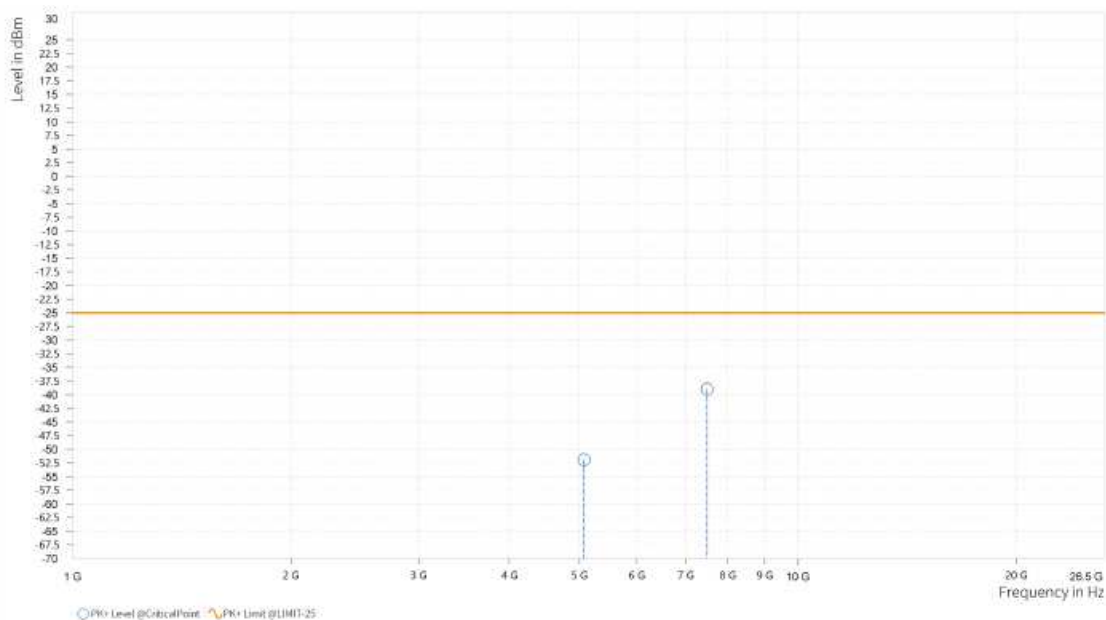



Test Report No.: W7L-P23100014RF06

MODE	TX channel 21100	FREQUENCY RANGE	Above 1000MHz
ENVIRONMENTAL CONDITIONS	23deg. C, 70%RH	INPUT POWER	AC 120V/60HZ
TESTED BY	Jace Hu		
ANTENNA POLARITY & TEST DISTANCE: VERTICAL AT 3 M			

Rg	Frequency [MHz]	PK+ Level [dBm]	PK+ Limit [dBm]	PK+ Margin [dB]	Correction [dB]	Polarization	Azimuth [deg]	Antenna Height [m]
4	5,073.000	-52.25	-25.00	27.25	25.76	V	182.4	1
5	7,492.500	-39.35	-25.00	14.35	31.86	V	0.9	2

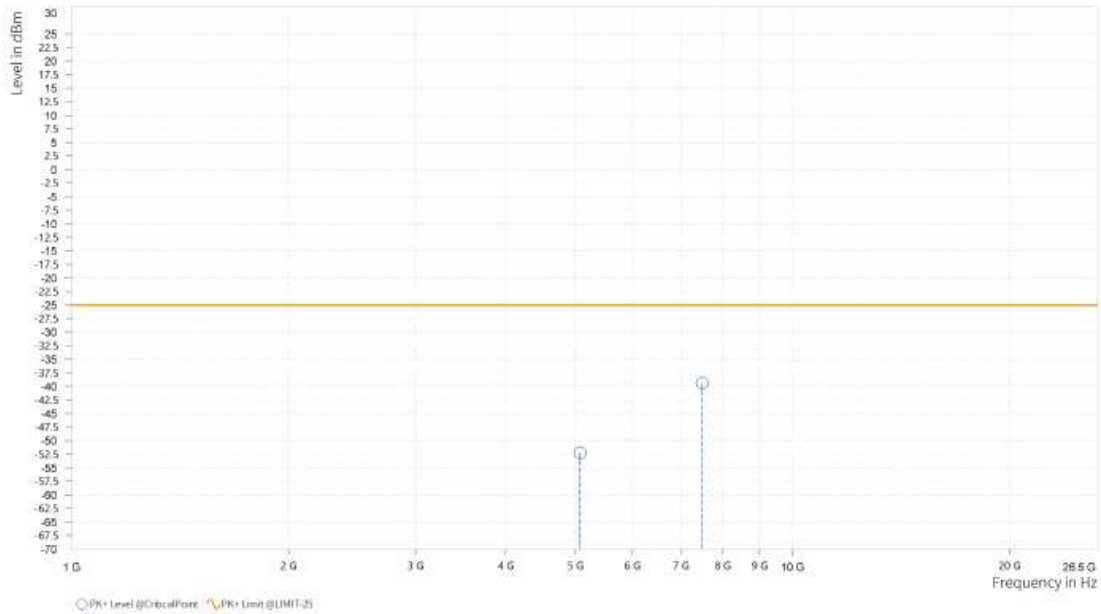



Test Report No.: W7L-P23100014RF06

LTE BAND 12

CHANNEL BANDWIDTH: 1.4MHz / QPSK

MODE	TX channel 23095	FREQUENCY RANGE	Above 1000MHz
ENVIRONMENTAL CONDITIONS	23deg. C, 70%RH	INPUT POWER	AC 120V/60HZ
TESTED BY	Jace Hu		
ANTENNA POLARITY & TEST DISTANCE: HORIZONTAL AT 3 M			

Rg	Frequency [MHz]	PK+ Level [dBm]	PK+ Limit [dBm]	PK+ Margin [dB]	Correction [dB]	Polarization	Azimuth [deg]	Antenna Height [m]
2	1,414.000	-51.05	-13.00	38.05	13.18	H	1	1
5	7,433.500	-38.42	-13.00	25.42	31.60	H	359	2

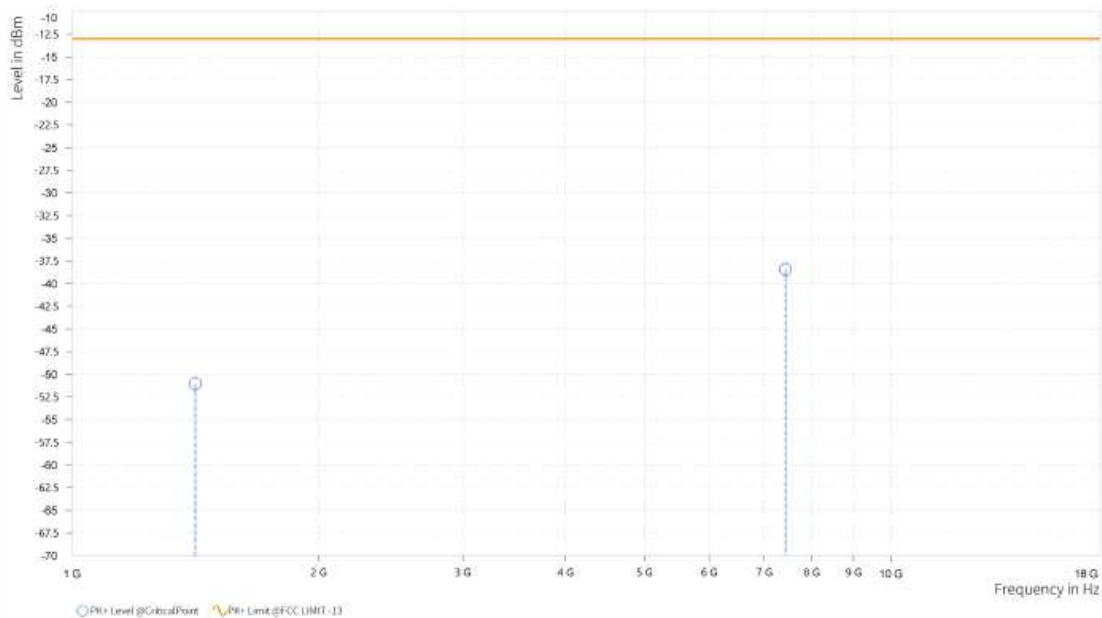



Test Report No.: W7L-P23100014RF06

MODE	TX channel 23095	FREQUENCY RANGE	Above 1000MHz
ENVIRONMENTAL CONDITIONS	23deg. C, 70%RH	INPUT POWER	AC 120V/60HZ
TESTED BY	Jace Hu		
ANTENNA POLARITY & TEST DISTANCE: VERTICAL AT 3 M			

Rg	Frequency [MHz]	PK+ Level [dBm]	PK+ Limit [dBm]	PK+ Margin [dB]	Correction [dB]	Polarization	Azimuth [deg]	Antenna Height [m]
2	1,413.000	-56.90	-13.00	43.90	13.21	V	359	1
5	7,432.000	-38.80	-13.00	25.80	31.74	V	272.1	1

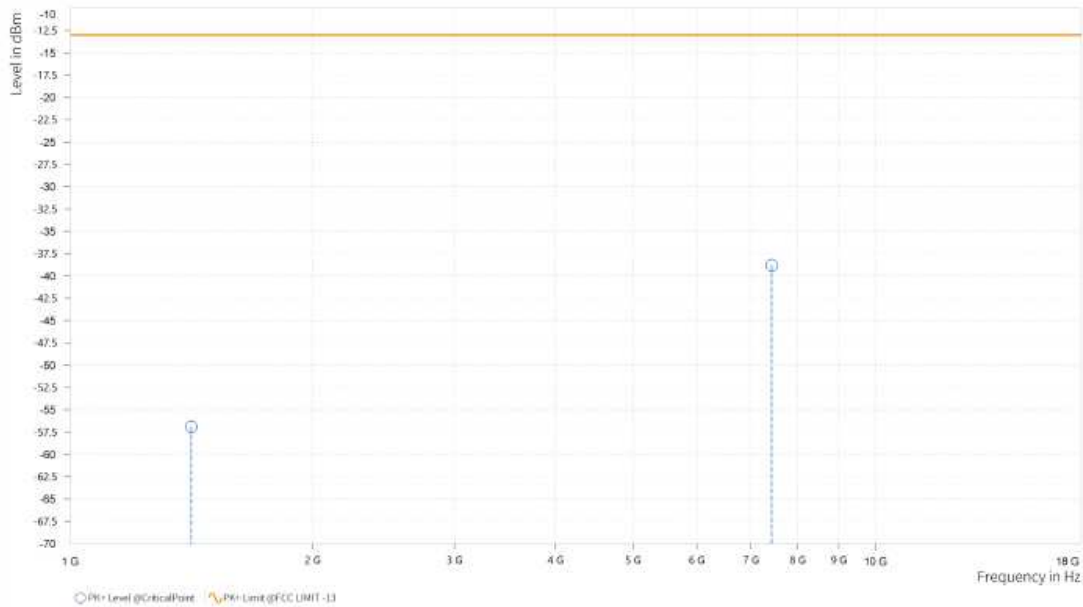



Test Report No.: W7L-P23100014RF06

CHANNEL BANDWIDTH: 3MHz / QPSK

MODE	TX channel 23095	FREQUENCY RANGE	Above 1000MHz
ENVIRONMENTAL CONDITIONS	23deg. C, 70%RH	INPUT POWER	AC 120V/60HZ
TESTED BY	Jace Hu		
ANTENNA POLARITY & TEST DISTANCE: HORIZONTAL AT 3 M			

Rg	Frequency [MHz]	PK+ Level [dBm]	PK+ Limit [dBm]	PK+ Margin [dB]	Correction [dB]	Polarization	Azimuth [deg]	Antenna Height [m]
2	1,412.500	-53.24	-13.00	40.24	13.10	H	1	1
5	7,493.000	-39.71	-13.00	26.71	31.81	H	86.6	2

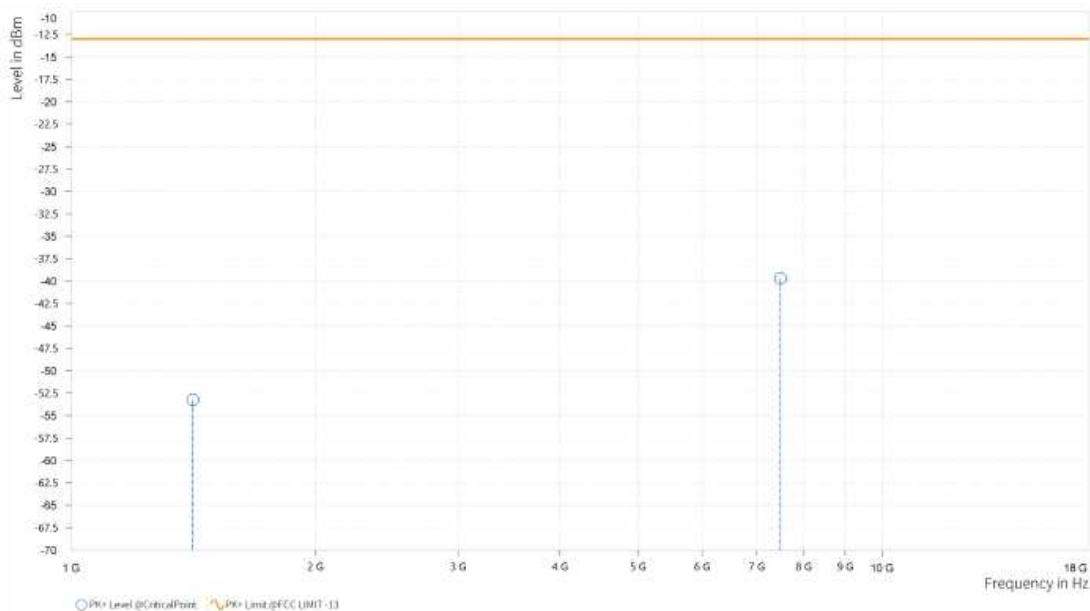



Test Report No.: W7L-P23100014RF06

MODE	TX channel 23095	FREQUENCY RANGE	Above 1000MHz
ENVIRONMENTAL CONDITIONS	23deg. C, 70%RH	INPUT POWER	AC 120V/60HZ
TESTED BY	Jace Hu		
ANTENNA POLARITY & TEST DISTANCE: VERTICAL AT 3 M			

Rg	Frequency [MHz]	PK+ Level [dBm]	PK+ Limit [dBm]	PK+ Margin [dB]	Correction [dB]	Polarization	Azimuth [deg]	Antenna Height [m]
2	1,412.000	-56.13	-13.00	43.13	13.17	V	359	1
5	7,395.500	-39.07	-13.00	26.07	31.72	V	359	2

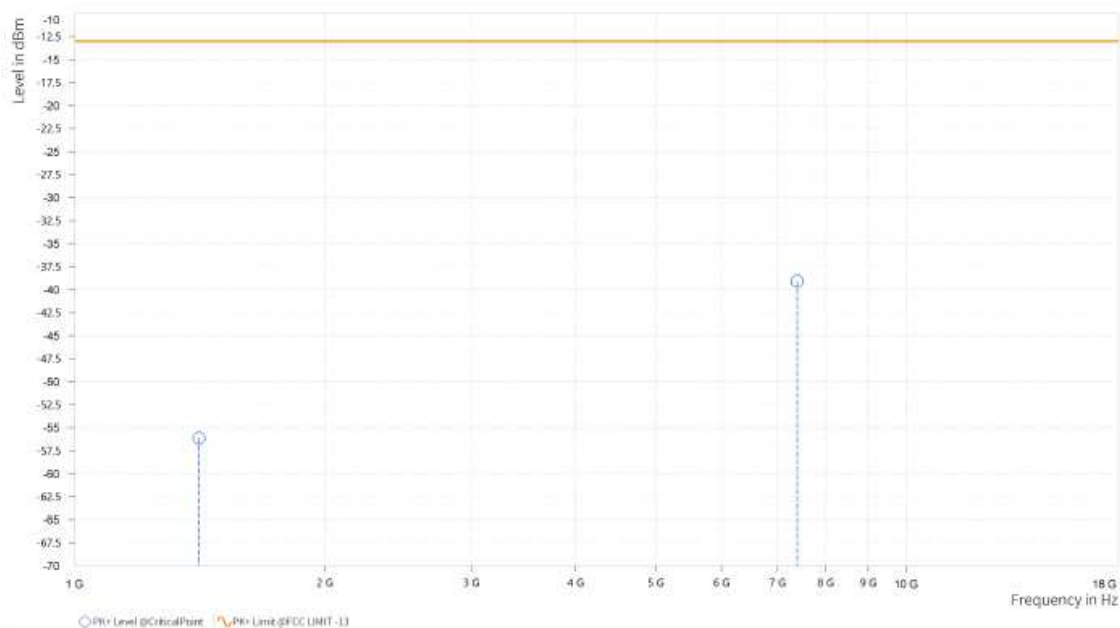



Test Report No.: W7L-P23100014RF06

CHANNEL BANDWIDTH: 5MHz / QPSK

MODE	TX channel 23095	FREQUENCY RANGE	Above 1000MHz
ENVIRONMENTAL CONDITIONS	23deg. C, 70%RH	INPUT POWER	AC 120V/60HZ
TESTED BY	Jace Hu		
ANTENNA POLARITY & TEST DISTANCE: HORIZONTAL AT 3 M			

Rg	Frequency [MHz]	PK+ Level [dBm]	PK+ Limit [dBm]	PK+ Margin [dB]	Correction [dB]	Polarization	Azimuth [deg]	Antenna Height [m]
2	1,410.500	-53.96	-13.00	40.96	13.00	H	0.9	2
5	7,726.500	-39.48	-13.00	26.48	32.80	H	1	1

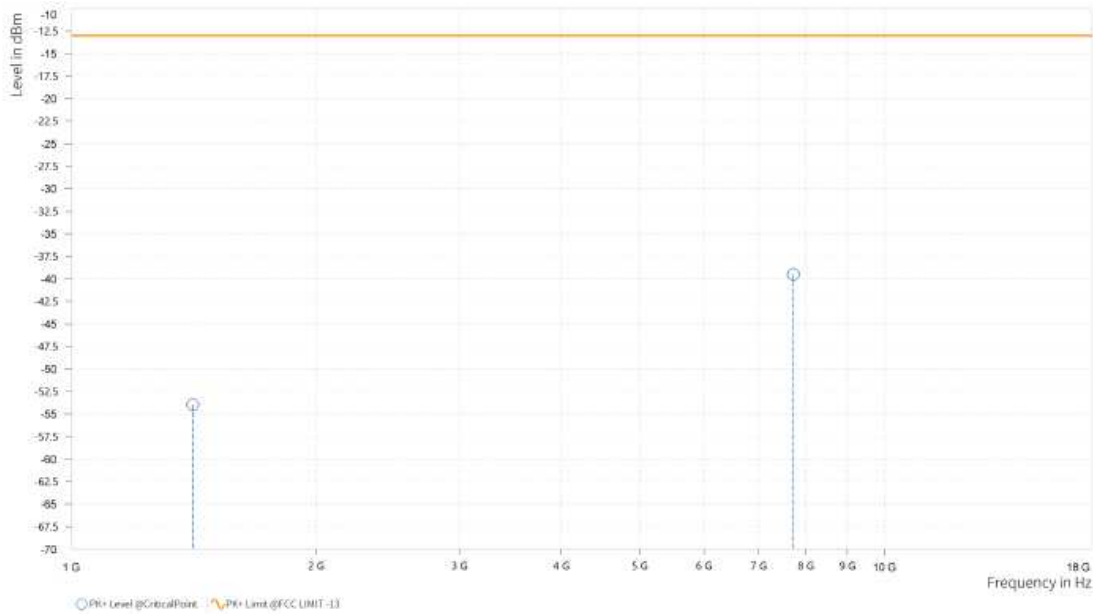



Test Report No.: W7L-P23100014RF06

MODE	TX channel 23095	FREQUENCY RANGE	Above 1000MHz
ENVIRONMENTAL CONDITIONS	23deg. C, 70%RH	INPUT POWER	AC 120V/60HZ
TESTED BY	Jace Hu		
ANTENNA POLARITY & TEST DISTANCE: VERTICAL AT 3 M			

Rg	Frequency [MHz]	PK+ Level [dBm]	PK+ Limit [dBm]	PK+ Margin [dB]	Correction [dB]	Polarization	Azimuth [deg]	Antenna Height [m]
2	1,410.000	-53.79	-13.00	40.79	13.09	V	359	2
5	7,821.500	-39.47	-13.00	26.47	33.07	V	1	1

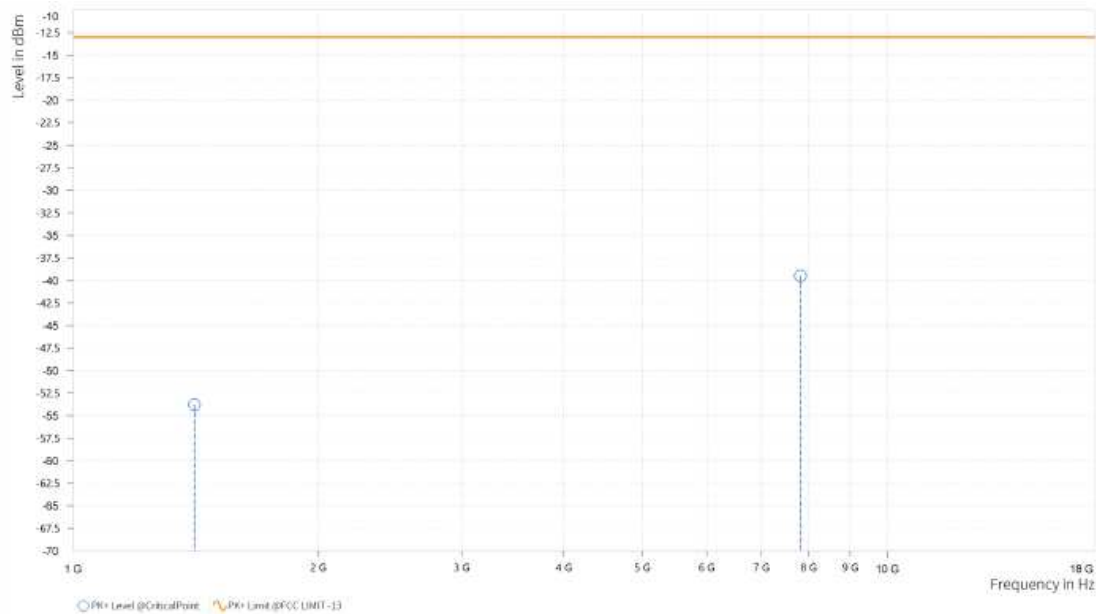



Test Report No.: W7L-P23100014RF06

CHANNEL BANDWIDTH: 10MHz / QPSK

CH23060

MODE	TX channel 23060	FREQUENCY RANGE	Above 1000MHz
ENVIRONMENTAL CONDITIONS	23deg. C, 70%RH	INPUT POWER	AC 120V/60HZ
TESTED BY	Jace Hu		
ANTENNA POLARITY & TEST DISTANCE: HORIZONTAL AT 3 M			

Rg	Frequency [MHz]	PK+ Level [dBm]	PK+ Limit [dBm]	PK+ Margin [dB]	Correction [dB]	Polarization	Azimuth [deg]	Antenna Height [m]
2	1,399.000	-54.15	-13.00	41.15	12.73	H	295.8	2
5	7,879.500	-39.41	-13.00	26.41	33.00	H	89	2

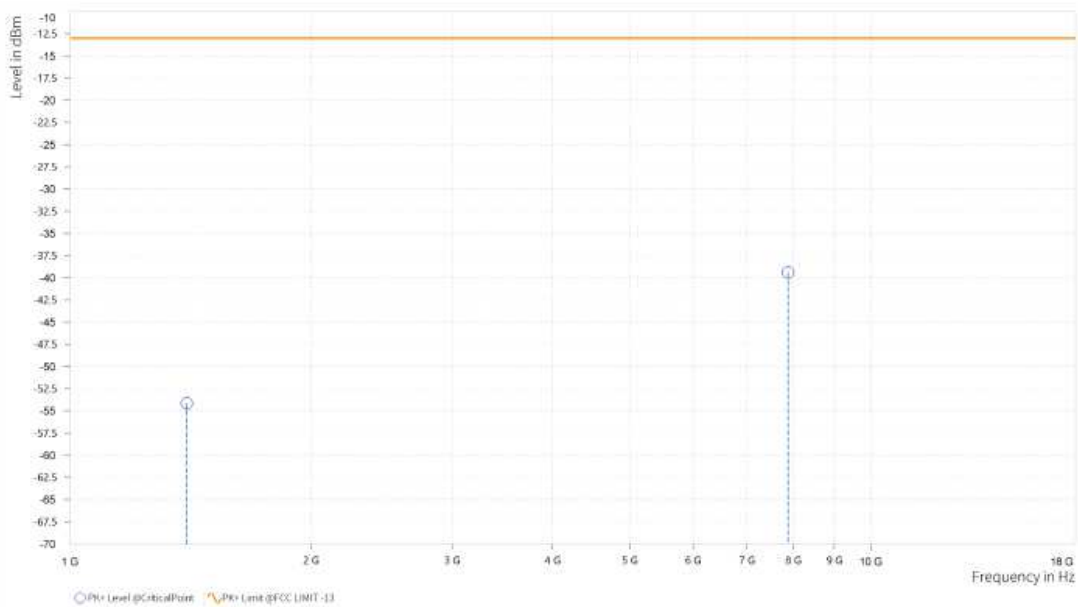



Test Report No.: W7L-P23100014RF06

MODE	TX channel 23060	FREQUENCY RANGE	Above 1000MHz
ENVIRONMENTAL CONDITIONS	23deg. C, 70%RH	INPUT POWER	AC 120V/60HZ
TESTED BY	Jace Hu		
ANTENNA POLARITY & TEST DISTANCE: VERTICAL AT 3 M			

Rg	Frequency [MHz]	PK+ Level [dBm]	PK+ Limit [dBm]	PK+ Margin [dB]	Correction [dB]	Polarization	Azimuth [deg]	Antenna Height [m]
2	1,399.000	-54.10	-13.00	41.10	12.86	V	1	2
5	7,725.000	-39.12	-13.00	26.12	32.99	V	1	1

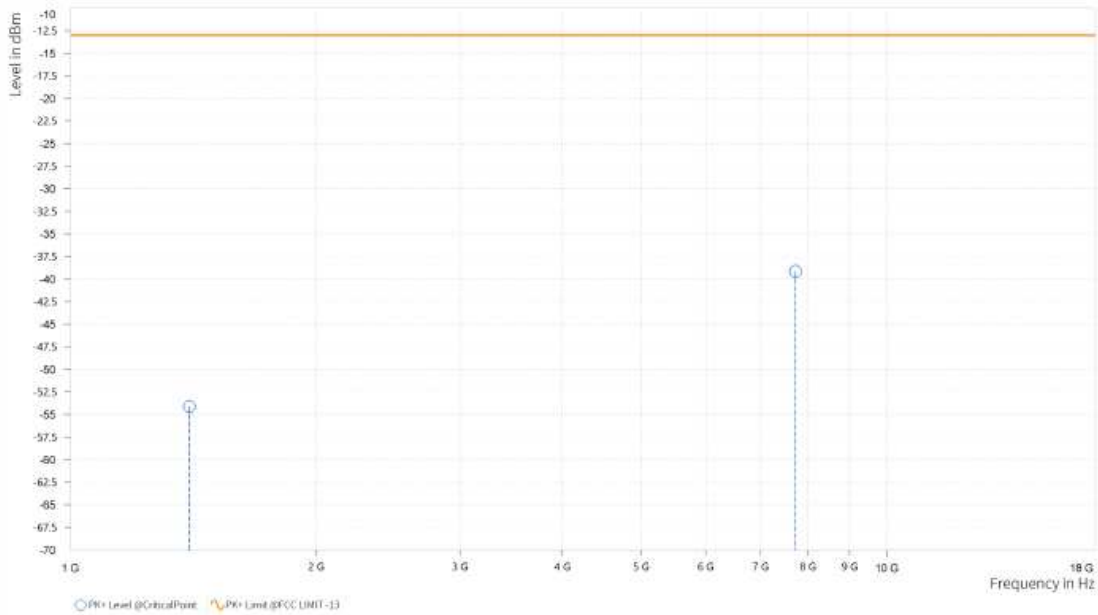



Test Report No.: W7L-P23100014RF06

CH23095

MODE	TX channel 23095	FREQUENCY RANGE	Above 1000MHz
ENVIRONMENTAL CONDITIONS	23deg. C, 70%RH	INPUT POWER	AC 120V/60HZ
TESTED BY	Jace Hu		
ANTENNA POLARITY & TEST DISTANCE: HORIZONTAL AT 3 M			

Rg	Frequency [MHz]	PK+ Level [dBm]	PK+ Limit [dBm]	PK+ Margin [dB]	Correction [dB]	Polarization	Azimuth [deg]	Antenna Height [m]
2	1,406.000	-57.20	-13.00	44.20	12.78	H	1	1
5	7,433.000	-39.23	-13.00	26.23	31.60	H	359	2

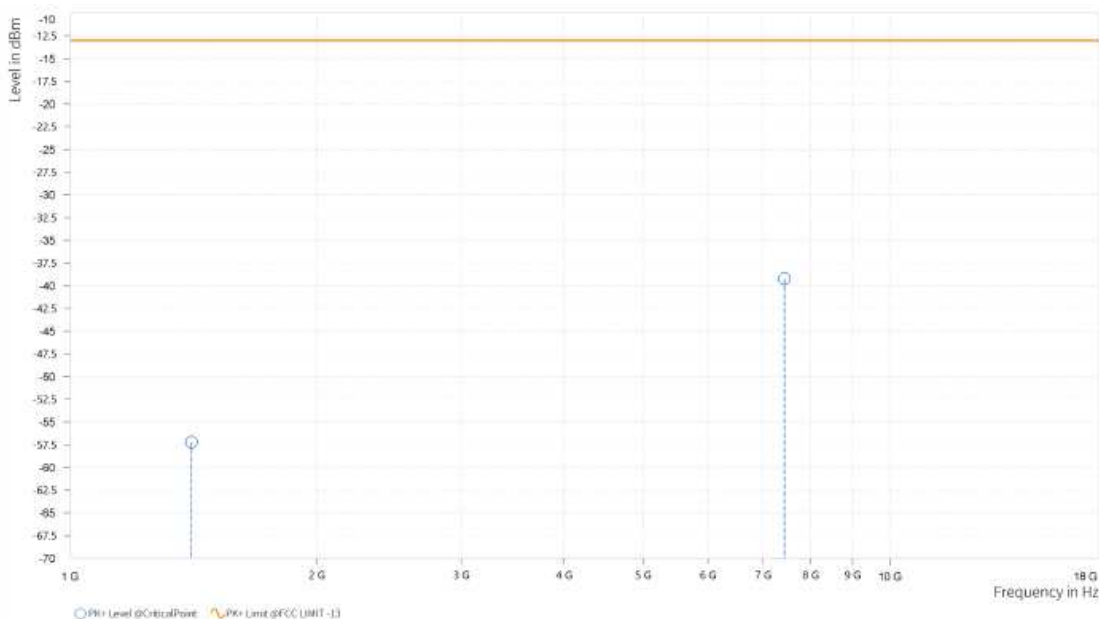



Test Report No.: W7L-P23100014RF06

MODE	TX channel 23095	FREQUENCY RANGE	Above 1000MHz
ENVIRONMENTAL CONDITIONS	23deg. C, 70%RH	INPUT POWER	AC 120V/60HZ
TESTED BY	Jace Hu		
ANTENNA POLARITY & TEST DISTANCE: VERTICAL AT 3 M			

Rg	Frequency [MHz]	PK+ Level [dBm]	PK+ Limit [dBm]	PK+ Margin [dB]	Correction [dB]	Polarization	Azimuth [deg]	Antenna Height [m]
2	1,406.000	-57.16	-13.00	44.16	12.93	V	1	2
5	7,495.500	-38.39	-13.00	25.39	31.88	V	269.8	1

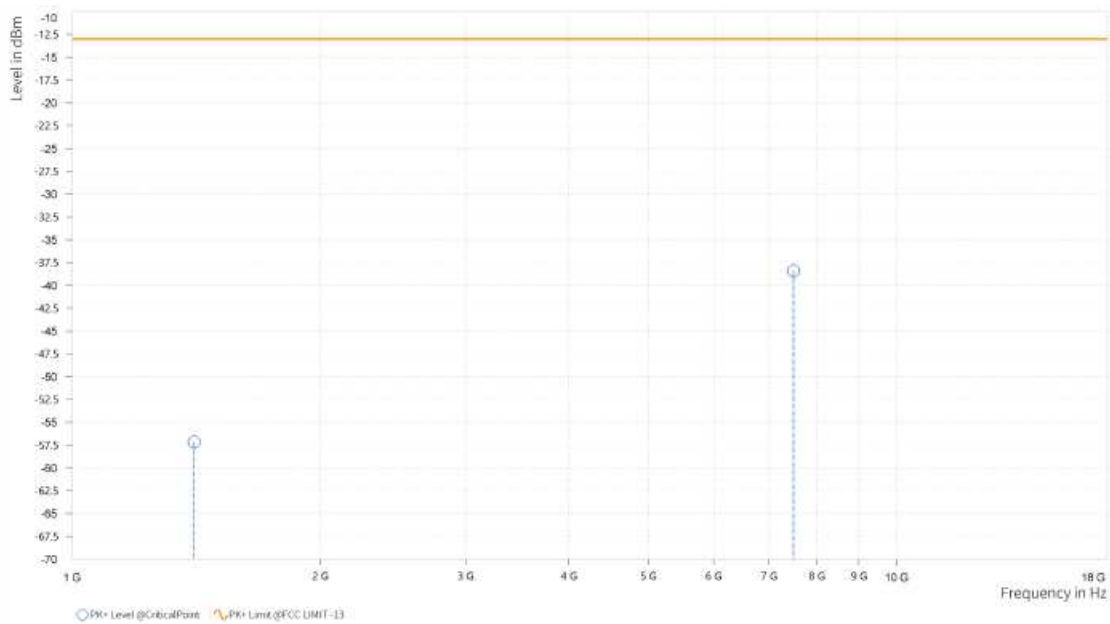



Test Report No.: W7L-P23100014RF06

CH23130

MODE	TX channel 23130	FREQUENCY RANGE	Above 1000MHz
ENVIRONMENTAL CONDITIONS	23deg. C, 70%RH	INPUT POWER	AC 120V/60HZ
TESTED BY	Jace Hu		
ANTENNA POLARITY & TEST DISTANCE: HORIZONTAL AT 3 M			

Rg	Frequency [MHz]	PK+ Level [dBm]	PK+ Limit [dBm]	PK+ Margin [dB]	Correction [dB]	Polarization	Azimuth [deg]	Antenna Height [m]
2	1,413.000	-55.01	-13.00	42.01	13.13	H	1	2
5	7,430.000	-39.51	-13.00	26.51	31.59	H	89	2

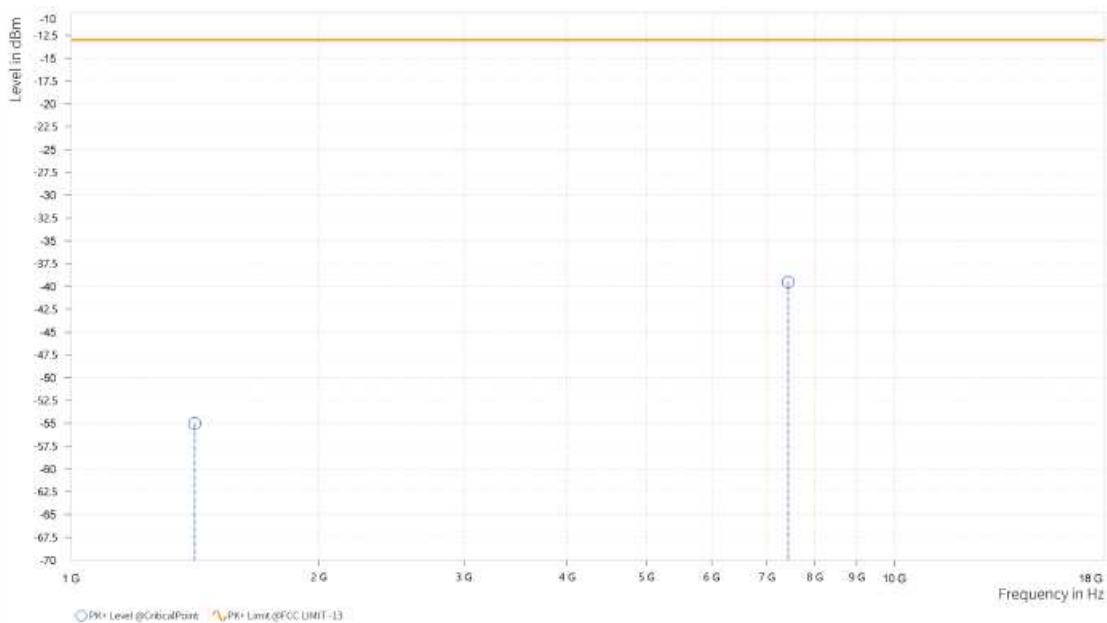



Test Report No.: W7L-P23100014RF06

MODE	TX channel 23130	FREQUENCY RANGE	Above 1000MHz
ENVIRONMENTAL CONDITIONS	23deg. C, 70%RH	INPUT POWER	AC 120V/60HZ
TESTED BY	Jace Hu		
ANTENNA POLARITY & TEST DISTANCE: VERTICAL AT 3 M			

Rg	Frequency [MHz]	PK+ Level [dBm]	PK+ Limit [dBm]	PK+ Margin [dB]	Correction [dB]	Polarization	Azimuth [deg]	Antenna Height [m]
2	1,413.000	-56.09	-13.00	43.09	13.21	V	359	2
5	7,699.000	-39.42	-13.00	26.42	32.88	V	1	2

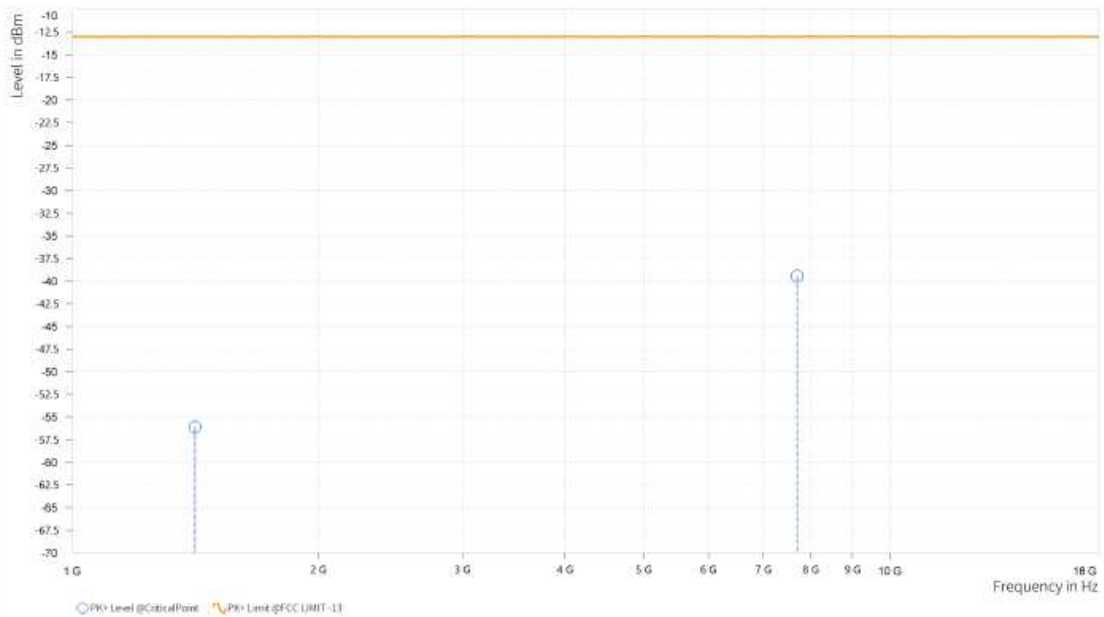



Test Report No.: W7L-P23100014RF06

LTE B13

CHANNEL BANDWIDTH: 5MHz / QPSK

MODE	TX channel 23230	FREQUENCY RANGE	Above 1000MHz
ENVIRONMENTAL CONDITIONS	23deg. C, 70%RH	INPUT POWER	AC 120V/60HZ
TESTED BY	Jace Hu		
ANTENNA POLARITY & TEST DISTANCE: HORIZONTAL AT 3 M			

Rg	Frequency [MHz]	PK+ Level [dBm]	PK+ Limit [dBm]	PK+ Margin [dB]	Correction [dB]	Polarization	Azimuth [deg]	Antenna Height [m]
2	1,556.000	-59.02	-13.00	46.02	13.48	H	65.3	1
5	7,954.000	-43.98	-13.00	30.98	32.98	H	0.9	2

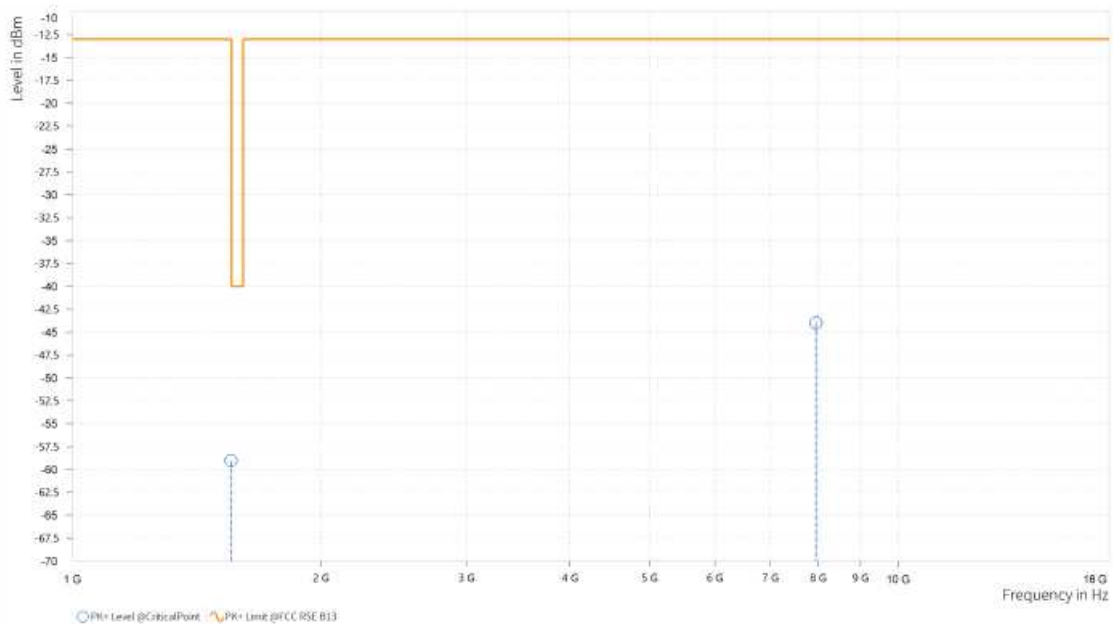



Test Report No.: W7L-P23100014RF06

MODE	TX channel 23230	FREQUENCY RANGE	Above 1000MHz
ENVIRONMENTAL CONDITIONS	23deg. C, 70%RH	INPUT POWER	AC 120V/60HZ
TESTED BY	Jace Hu		
ANTENNA POLARITY & TEST DISTANCE: VERTICAL AT 3 M			

Rg	Frequency [MHz]	PK+ Level [dBm]	PK+ Limit [dBm]	PK+ Margin [dB]	Correction [dB]	Polarization	Azimuth [deg]	Antenna Height [m]
2	1,558.500	-59.01	-13.00	46.01	13.22	V	359.1	1
5	7,784.500	-43.94	-13.00	30.94	33.04	V	1	1

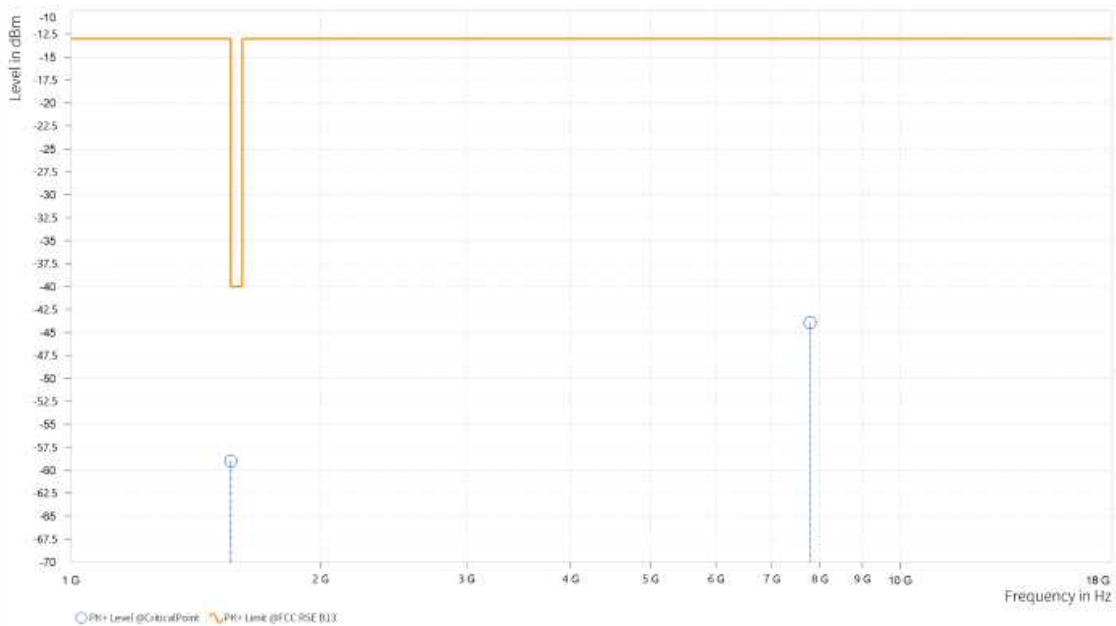



Test Report No.: W7L-P23100014RF06

CHANNEL BANDWIDTH: 10MHz /QPSK

MODE	TX channel 23230	FREQUENCY RANGE	Above 1000MHz
ENVIRONMENTAL CONDITIONS	23deg. C, 70%RH	INPUT POWER	AC 120V/60HZ
TESTED BY	Jace Hu		
ANTENNA POLARITY & TEST DISTANCE: HORIZONTAL AT 3 M			

Rg	Frequency [MHz]	PK+ Level [dBm]	PK+ Limit [dBm]	PK+ Margin [dB]	Correction [dB]	Polarization	Azimuth [deg]	Antenna Height [m]
2	1,555.000	-52.73	-13.00	39.73	13.45	H	359.1	1
5	7,996.500	-39.20	-13.00	26.20	33.14	H	1	1

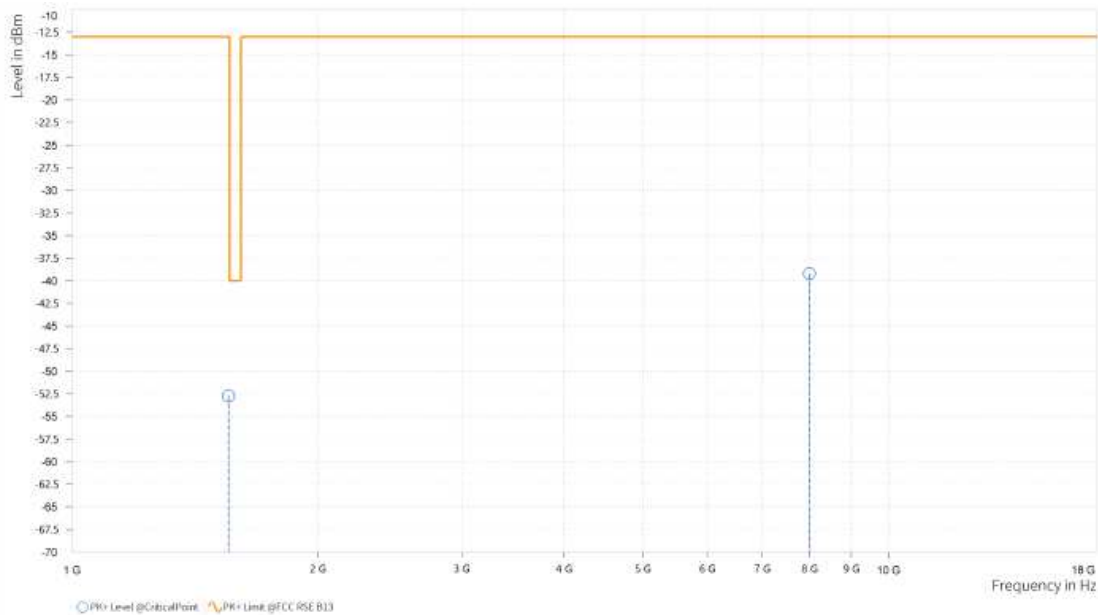



Test Report No.: W7L-P23100014RF06

MODE	TX channel 23230	FREQUENCY RANGE	Above 1000MHz
ENVIRONMENTAL CONDITIONS	23deg. C, 70%RH	INPUT POWER	AC 120V/60HZ
TESTED BY	Jace Hu		
ANTENNA POLARITY & TEST DISTANCE: VERTICAL AT 3 M			

Rg	Frequency [MHz]	PK+ Level [dBm]	PK+ Limit [dBm]	PK+ Margin [dB]	Correction [dB]	Polarization	Azimuth [deg]	Antenna Height [m]
2	1,555.000	-56.84	-13.00	43.84	13.12	V	359	2
5	7,709.500	-38.87	-13.00	25.87	32.93	V	359	2

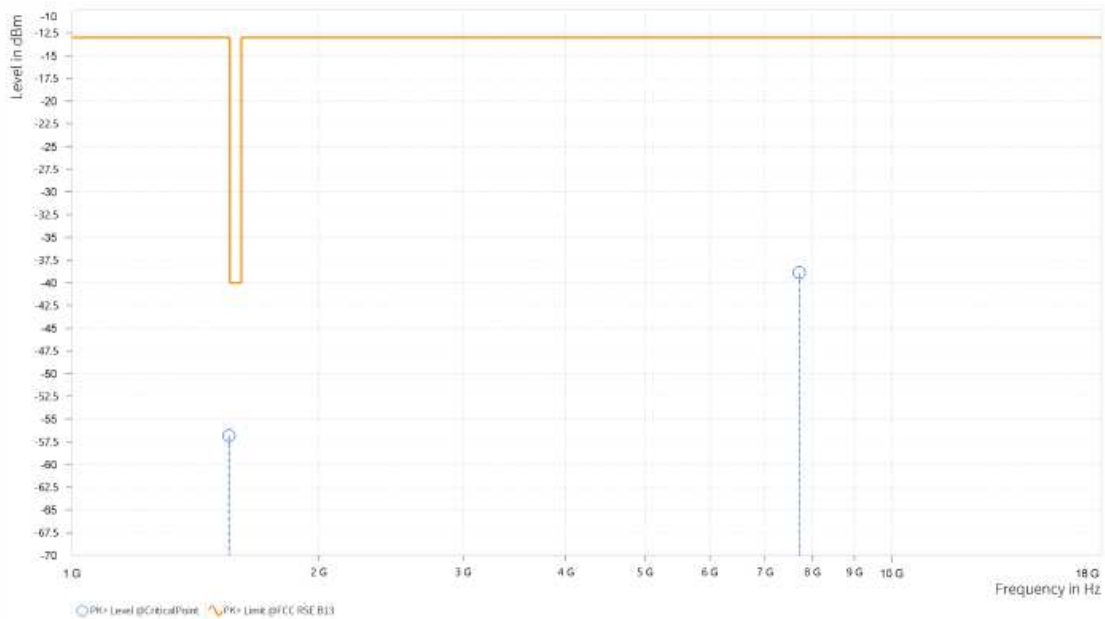



Test Report No.: W7L-P23100014RF06

LTE B30

Note: For frequency above 19GHz, the emission was tested 20db below the limit so the data not recorded in the sheet.

CHANNEL BANDWIDTH: 5MHz / QPSK

CH27685

MODE	TX channel 27685	FREQUENCY RANGE	Above 1000MHz
ENVIRONMENTAL CONDITIONS	23deg. C, 70%RH	INPUT POWER	AC 120V/60Hz
TESTED BY	Jace Hu		
ANTENNA POLARITY & TEST DISTANCE: HORIZONTAL AT 3 M			

	Freq	Level	Read Level	Limit Line	Over Limit	Factor	Remark	Pol/Phase
	MHz	dBm/m	dBm	dBm/m	dB	dB/m		
1	4615.000	-51.06	-60.79	-40.00	-11.06	9.73	Peak	Horizontal
2 PP	6922.000	-51.04	-63.17	-40.00	-11.04	12.13	Peak	Horizontal

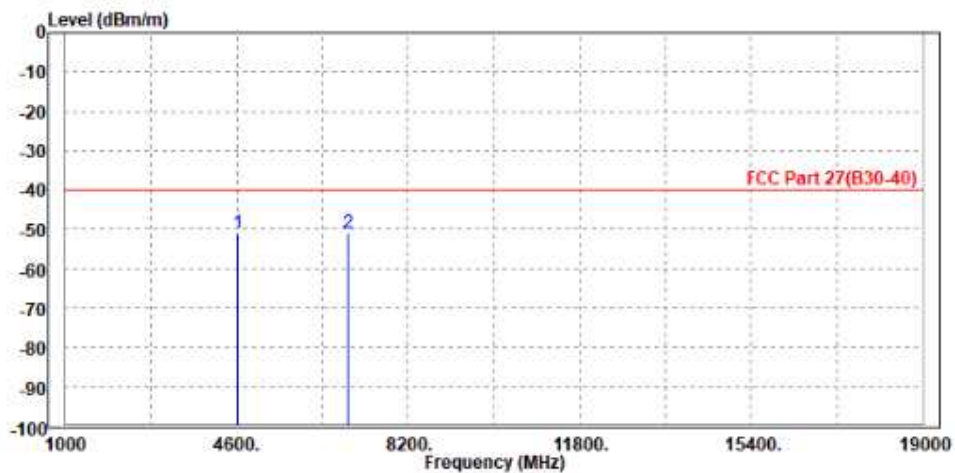



Test Report No.: W7L-P23100014RF06

MODE	TX channel 27685	FREQUENCY RANGE	Above 1000MHz
ENVIRONMENTAL CONDITIONS	23deg. C, 70%RH	INPUT POWER	AC 120V/60Hz
TESTED BY	Jace Hu		
ANTENNA POLARITY & TEST DISTANCE: VERTICAL AT 3 M			

	Freq	Level	Read Level	Limit Line	Over Limit	Factor	Remark	Pol/Phase
	MHz	dBm/m	dBm	dBm/m	dB	dB/m		
1	4618.000	-51.33	-61.00	-40.00	-11.33	9.67	Peak	Vertical
2 PP	6922.500	-50.28	-62.98	-40.00	-10.28	12.70	Peak	Vertical

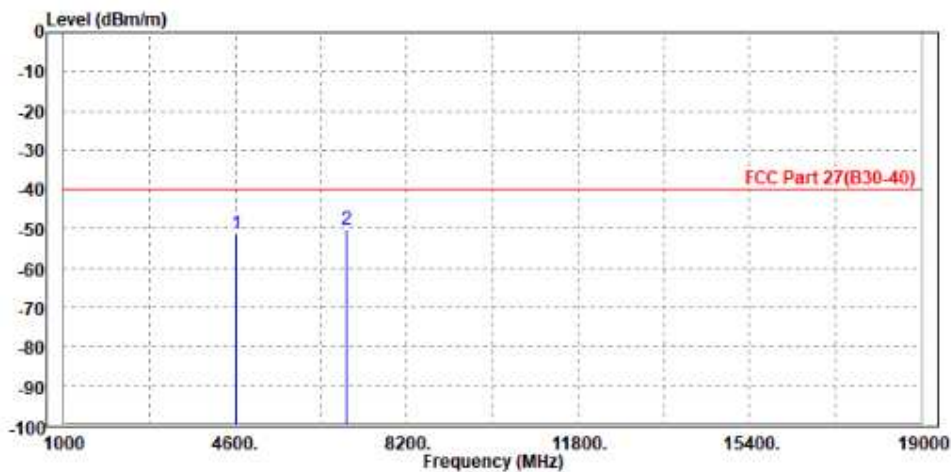



Test Report No.: W7L-P23100014RF06

CH27710

MODE	TX channel 27710	FREQUENCY RANGE	Above 1000MHz
ENVIRONMENTAL CONDITIONS	23deg. C, 70%RH	INPUT POWER	AC 120V/60Hz
TESTED BY	Jace Hu		
ANTENNA POLARITY & TEST DISTANCE: HORIZONTAL AT 3 M			

	Freq	Level	Read Level	Limit Line	Over Limit	Factor	Remark	Pol/Phase
	MHz	dBm/m	dBm	dBm/m	dB	dB/m		
1	4618.000	-51.10	-60.83	-40.00	-11.10	9.73	Peak	Horizontal
2 PP	6930.000	-49.95	-62.09	-40.00	-9.95	12.14	Peak	Horizontal

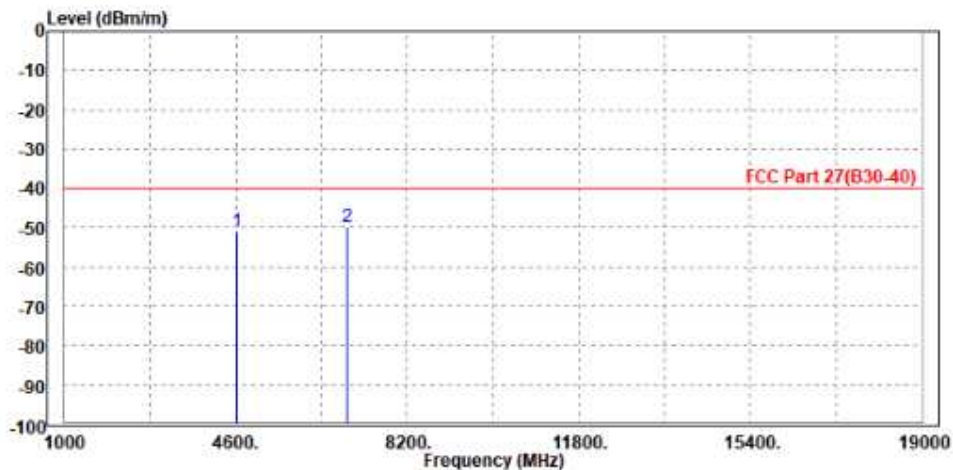



Test Report No.: W7L-P23100014RF06

MODE	TX channel 27710	FREQUENCY RANGE	Above 1000MHz
ENVIRONMENTAL CONDITIONS	23deg. C, 70%RH	INPUT POWER	AC 120V/60Hz
TESTED BY	Jace Hu		
ANTENNA POLARITY & TEST DISTANCE: VERTICAL AT 3 M			

	Freq	Level	Read Level	Limit Line	Over Limit	Factor	Remark	Pol/Phase
	MHz	dBm/m	dBm	dBm/m	dB	dB/m		
1	4620.000	-51.08	-60.75	-40.00	-11.08	9.67	Peak	Vertical
2 PP	6922.000	-50.18	-62.88	-40.00	-10.18	12.70	Peak	Vertical

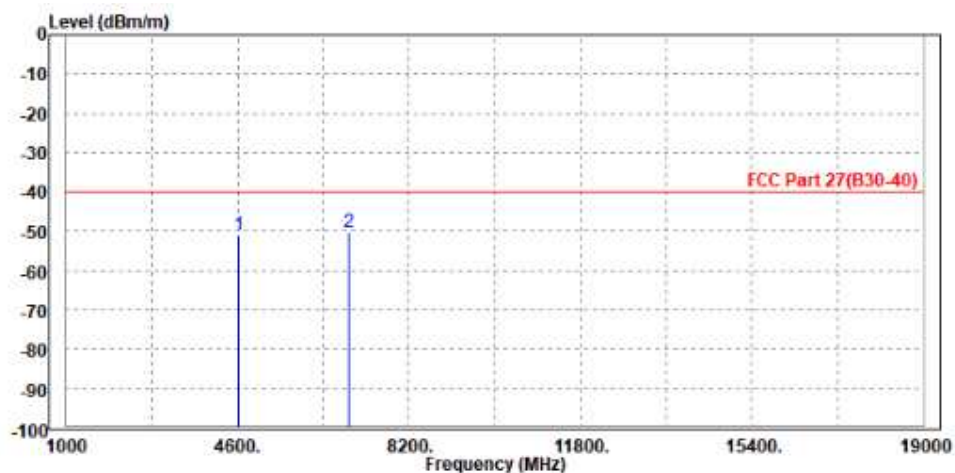



Test Report No.: W7L-P23100014RF06

CH27735

MODE	TX channel 27735	FREQUENCY RANGE	Above 1000MHz
ENVIRONMENTAL CONDITIONS	23deg. C, 70%RH	INPUT POWER	AC 120V/60Hz
TESTED BY	Jace Hu		
ANTENNA POLARITY & TEST DISTANCE: HORIZONTAL AT 3 M			

	Freq	Level	Read Level	Limit Line	Over Limit	Factor	Remark	Pol/Phase
	MHz	dBm/m	dBm	dBm/m	dB	dB/m		
1	PP 4618.000	-50.43	-60.16	-40.00	-10.43	9.73	Peak	Horizontal
2	6937.500	-50.62	-62.77	-40.00	-10.62	12.15	Peak	Horizontal

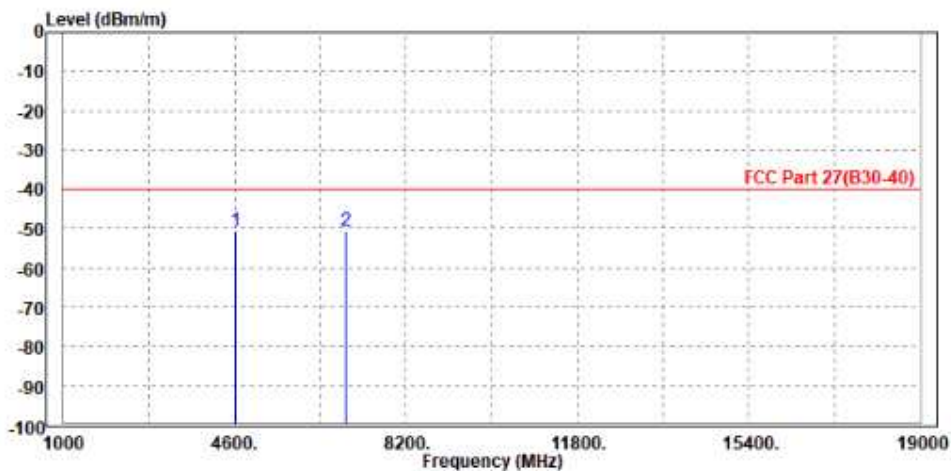



Test Report No.: W7L-P23100014RF06

MODE	TX channel 27735	FREQUENCY RANGE	Above 1000MHz
ENVIRONMENTAL CONDITIONS	23deg. C, 70%RH	INPUT POWER	AC 120V/60Hz
TESTED BY	Jace Hu		
ANTENNA POLARITY & TEST DISTANCE: VERTICAL AT 3 M			

	Freq	Level	Read Level	Limit Line	Over Limit	Factor	Remark	Pol/Phase
	MHz	dBm/m	dBm	dBm/m	dB	dB/m		
1	4625.000	-51.15	-60.83	-40.00	-11.15	9.68	Peak	Vertical
2 PP	6940.000	-50.19	-62.89	-40.00	-10.19	12.70	Peak	Vertical

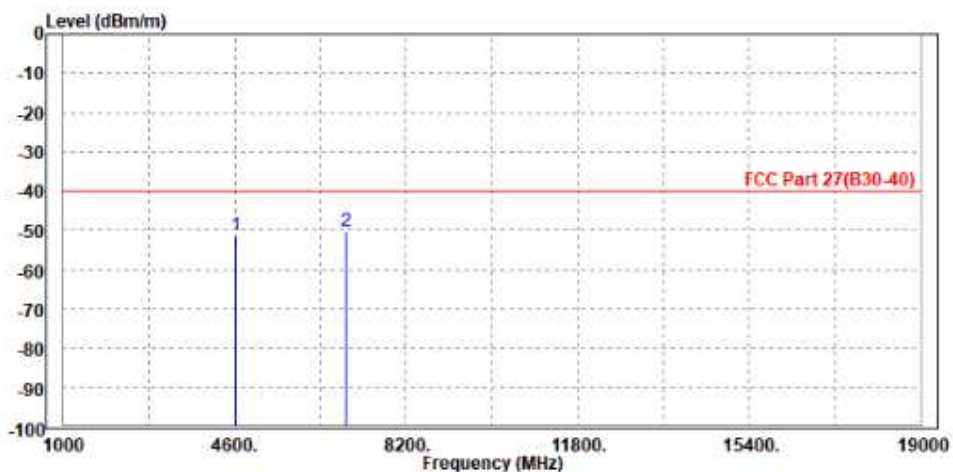



Test Report No.: W7L-P23100014RF06

CHANNEL BANDWIDTH: 10MHz / QPSK

MODE	TX channel 27710	FREQUENCY RANGE	Above 1000MHz
ENVIRONMENTAL CONDITIONS	23deg. C, 70%RH	INPUT POWER	AC 120V/60Hz
TESTED BY	Jace Hu		
ANTENNA POLARITY & TEST DISTANCE: HORIZONTAL AT 3 M			

	Freq	Level	Read Level	Limit Line	Over Limit	Factor	Remark	Pol/Phase
	MHz	dBm/m	dBm	dBm/m	dB	dB/m		
1	4620.000	-51.12	-60.85	-40.00	-11.12	9.73	Peak	Horizontal
2	PP 6922.000	-49.88	-62.01	-40.00	-9.88	12.13	Peak	Horizontal

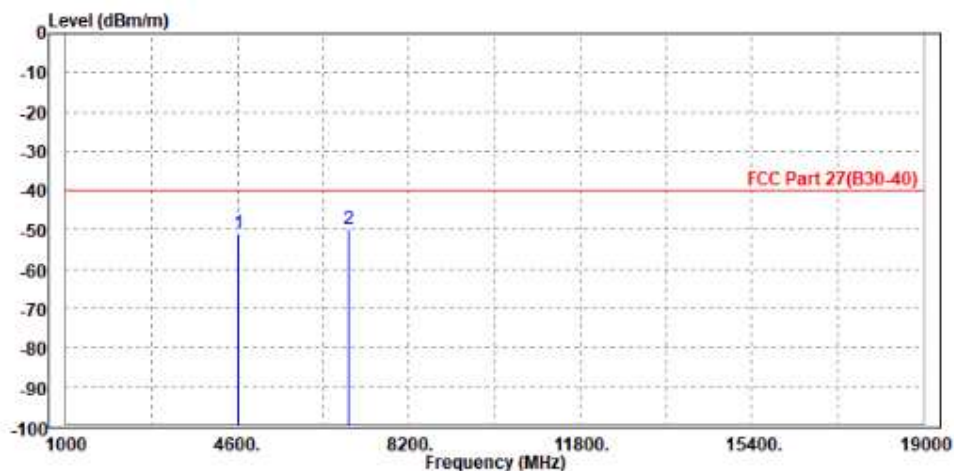



Test Report No.: W7L-P23100014RF06

MODE	TX channel 27710	FREQUENCY RANGE	Above 1000MHz
ENVIRONMENTAL CONDITIONS	23deg. C, 70%RH	INPUT POWER	AC 120V/60Hz
TESTED BY	Jace Hu		
ANTENNA POLARITY & TEST DISTANCE: VERTICAL AT 3 M			

	Freq	Level	Read Level	Limit Line	Over Limit	Factor	Remark	Pol/Phase
	MHz	dBm/m	dBm	dBm/m	dB	dB/m		
1	4618.000	-50.31	-59.98	-40.00	-10.31	9.67	Peak	Vertical
2 PP	6930.000	-49.53	-62.23	-40.00	-9.53	12.70	Peak	Vertical

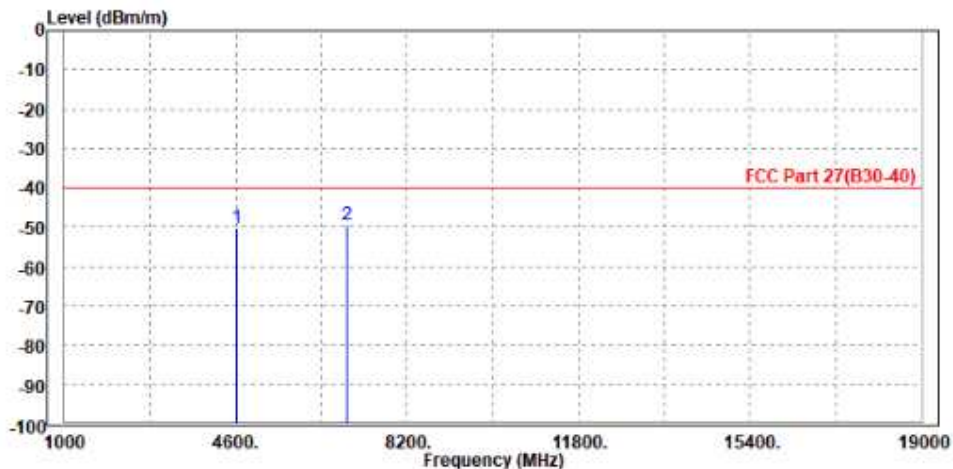



Test Report No.: W7L-P23100014RF06

LTE B71

CHANNEL BANDWIDTH: 5MHz / QPSK

CH133147

MODE	TX channel 133147	FREQUENCY RANGE	Above 1000MHz
ENVIRONMENTAL CONDITIONS	23deg. C, 70%RH	INPUT POWER	AC 120V/60Hz
TESTED BY	Jace Hu		
ANTENNA POLARITY & TEST DISTANCE: HORIZONTAL AT 3 M			

Rg	Frequency [MHz]	PK+ Level [dBm]	PK+ Limit [dBm]	PK+ Margin [dB]	Correction [dB]	Polarization	Azimuth [deg]	Antenna Height [m]
2	1,326.500	-47.67	-13.00	34.67	14.14	H	1	1
5	7,432.500	-39.52	-13.00	26.52	31.60	H	90.2	2

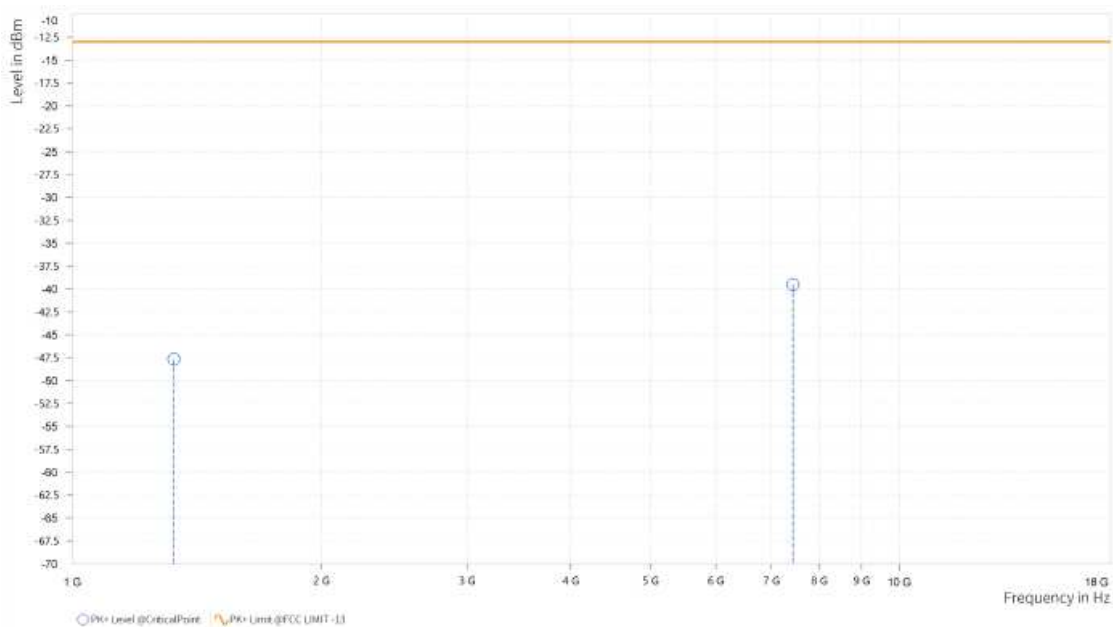



Test Report No.: W7L-P23100014RF06

MODE	TX channel 133147	FREQUENCY RANGE	Above 1000MHz
ENVIRONMENTAL CONDITIONS	23deg. C, 70%RH	INPUT POWER	AC 120V/60Hz
TESTED BY	Jace Hu		
ANTENNA POLARITY & TEST DISTANCE: VERTICAL AT 3 M			

Rg	Frequency [MHz]	PK+ Level [dBm]	PK+ Limit [dBm]	PK+ Margin [dB]	Correction [dB]	Polarization	Azimuth [deg]	Antenna Height [m]
2	1,326.500	-46.46	-13.00	33.46	13.84	V	1	1
5	7,733.000	-39.17	-13.00	26.17	33.02	V	0.9	2

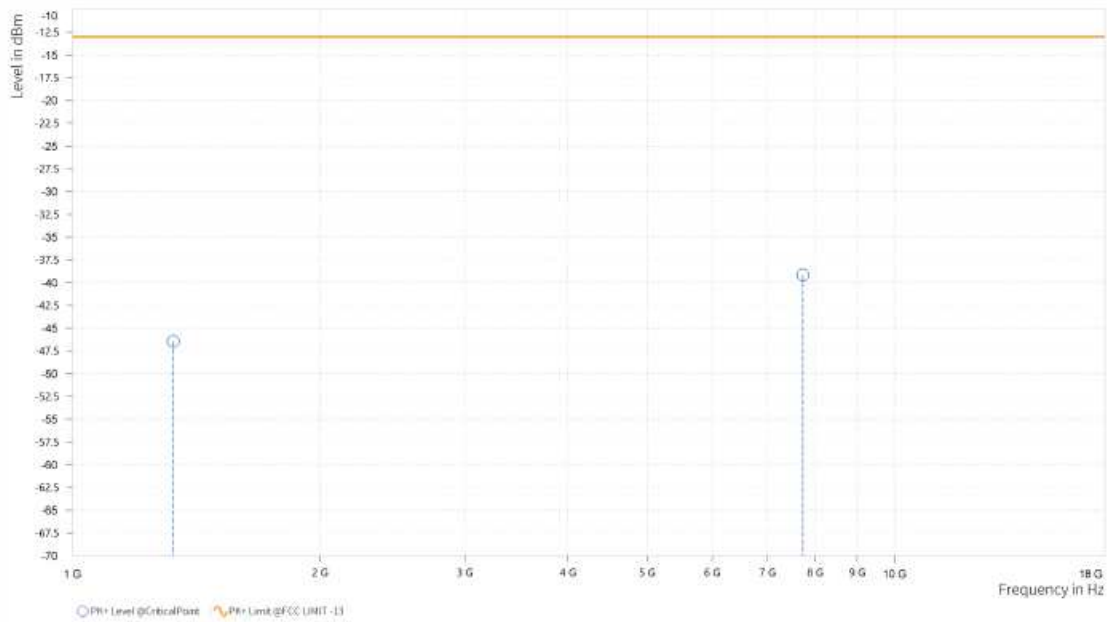



Test Report No.: W7L-P23100014RF06

CH133322

MODE	TX channel 133322	FREQUENCY RANGE	Above 1000MHz
ENVIRONMENTAL CONDITIONS	23deg. C, 70%RH	INPUT POWER	AC 120V/60Hz
TESTED BY	Jace Hu		
ANTENNA POLARITY & TEST DISTANCE: HORIZONTAL AT 3 M			

Rg	Frequency [MHz]	PK+ Level [dBm]	PK+ Limit [dBm]	PK+ Margin [dB]	Correction [dB]	Polarization	Azimuth [deg]	Antenna Height [m]
2	1,357.000	-51.68	-13.00	38.68	14.14	H	63	1
5	7,492.500	-39.58	-13.00	26.58	31.80	H	91.4	2

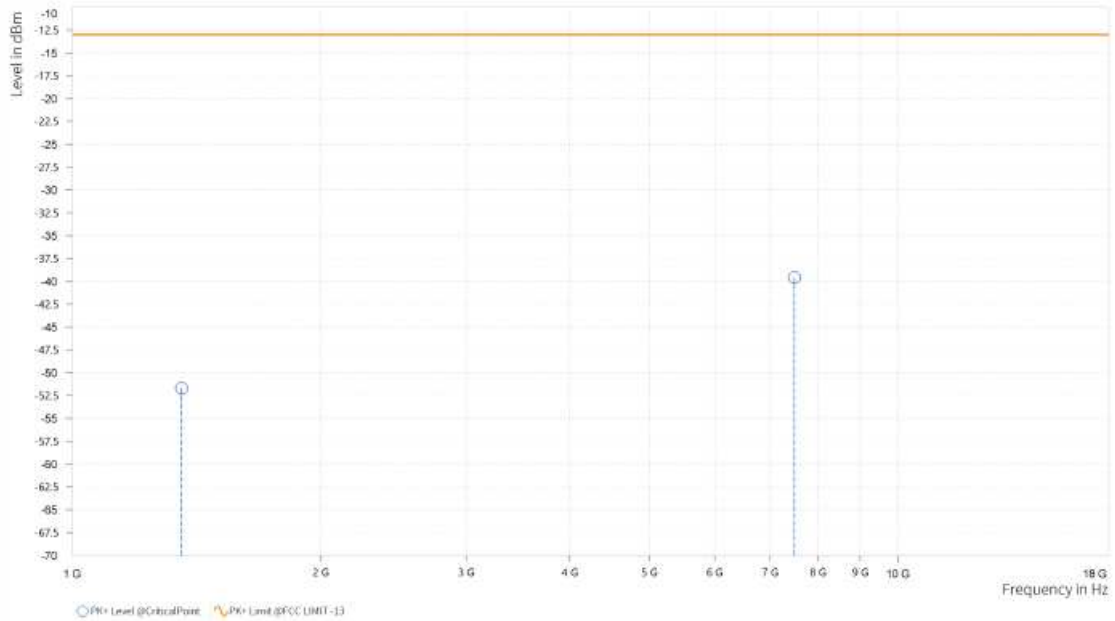



Test Report No.: W7L-P23100014RF06

MODE	TX channel 133322	FREQUENCY RANGE	Above 1000MHz
ENVIRONMENTAL CONDITIONS	23deg. C, 70%RH	INPUT POWER	AC 120V/60Hz
TESTED BY	Jace Hu		
ANTENNA POLARITY & TEST DISTANCE: VERTICAL AT 3 M			

Rg	Frequency [MHz]	PK+ Level [dBm]	PK+ Limit [dBm]	PK+ Margin [dB]	Correction [dB]	Polarization	Azimuth [deg]	Antenna Height [m]
2	1,356.500	-49.39	-13.00	36.39	13.38	V	0.9	2
5	7,479.000	-38.00	-13.00	25.00	31.80	V	90.2	2

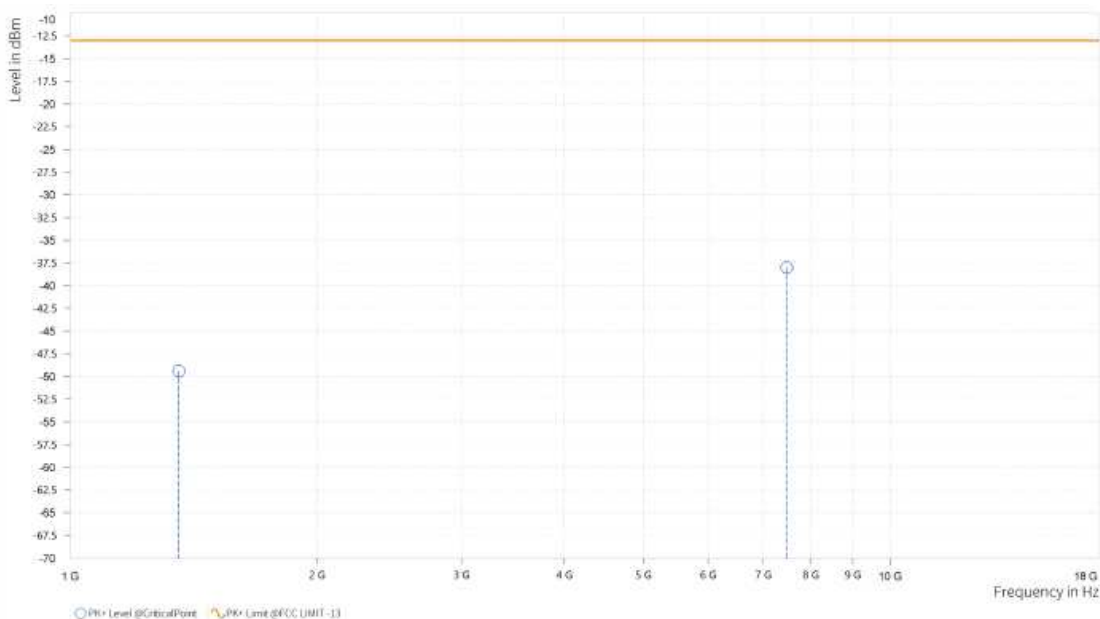



BUREAU
VERITAS

Test Report No.: W7L-P23100014RF06

CH133447

MODE	TX channel 133447	FREQUENCY RANGE	Above 1000MHz
ENVIRONMENTAL CONDITIONS	23deg. C, 70%RH	INPUT POWER	AC 120V/60Hz
TESTED BY	Jace Hu		
ANTENNA POLARITY & TEST DISTANCE: HORIZONTAL AT 3 M			

Rg	Frequency [MHz]	PK+ Level [dBm]	PK+ Limit [dBm]	PK+ Margin [dB]	Correction [dB]	Polarization	Azimuth [deg]	Antenna Height [m]
2	1,386.500	-54.19	-13.00	41.19	13.69	H	359	2
5	7,734.500	-39.13	-13.00	26.13	32.81	H	359	2

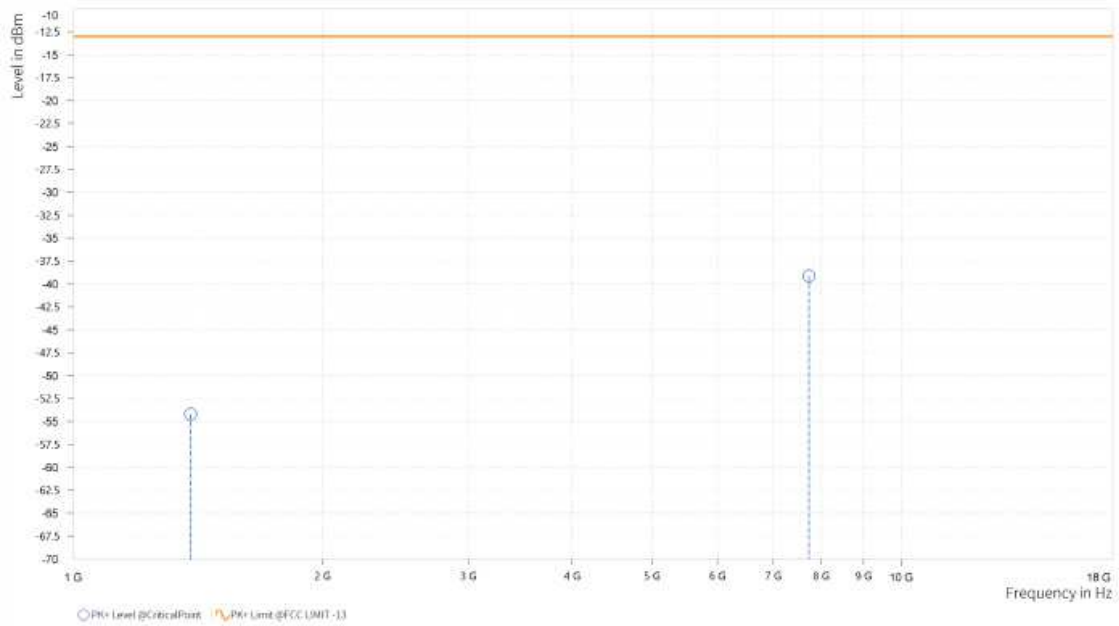



Test Report No.: W7L-P23100014RF06

MODE	TX channel 133447	FREQUENCY RANGE	Above 1000MHz
ENVIRONMENTAL CONDITIONS	23deg. C, 70%RH	INPUT POWER	AC 120V/60Hz
TESTED BY	Jace Hu		
ANTENNA POLARITY & TEST DISTANCE: VERTICAL AT 3 M			

Rg	Frequency [MHz]	PK+ Level [dBm]	PK+ Limit [dBm]	PK+ Margin [dB]	Correction [dB]	Polarization	Azimuth [deg]	Antenna Height [m]
2	1,386.500	-50.08	-13.00	37.08	13.46	V	61.8	1
5	7,825.000	-39.27	-13.00	26.27	33.07	V	359	2

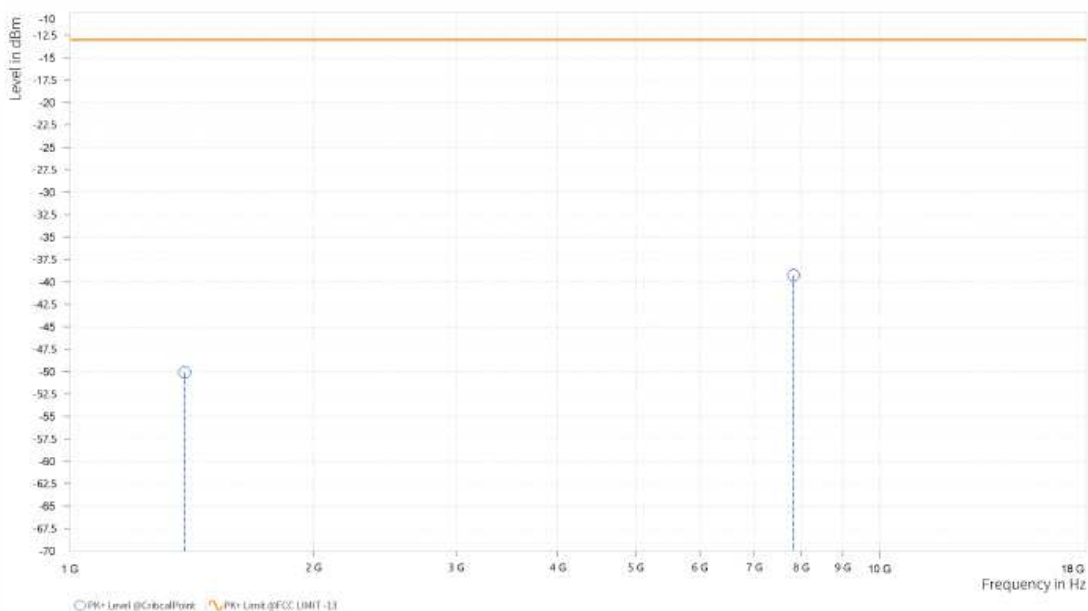



Test Report No.: W7L-P23100014RF06

CHANNEL BANDWIDTH: 10MHz / QPSK

MODE	TX channel 133272	FREQUENCY RANGE	Above 1000MHz
ENVIRONMENTAL CONDITIONS	23deg. C, 70%RH	INPUT POWER	AC 120V/60Hz
TESTED BY	Jace Hu		
ANTENNA POLARITY & TEST DISTANCE: HORIZONTAL AT 3 M			

Rg	Frequency [MHz]	PK+ Level [dBm]	PK+ Limit [dBm]	PK+ Margin [dB]	Correction [dB]	Polarization	Azimuth [deg]	Antenna Height [m]
2	1,352.000	-51.15	-13.00	38.15	14.20	H	297	2
5	7,479.500	-39.16	-13.00	26.16	31.72	H	92.6	2

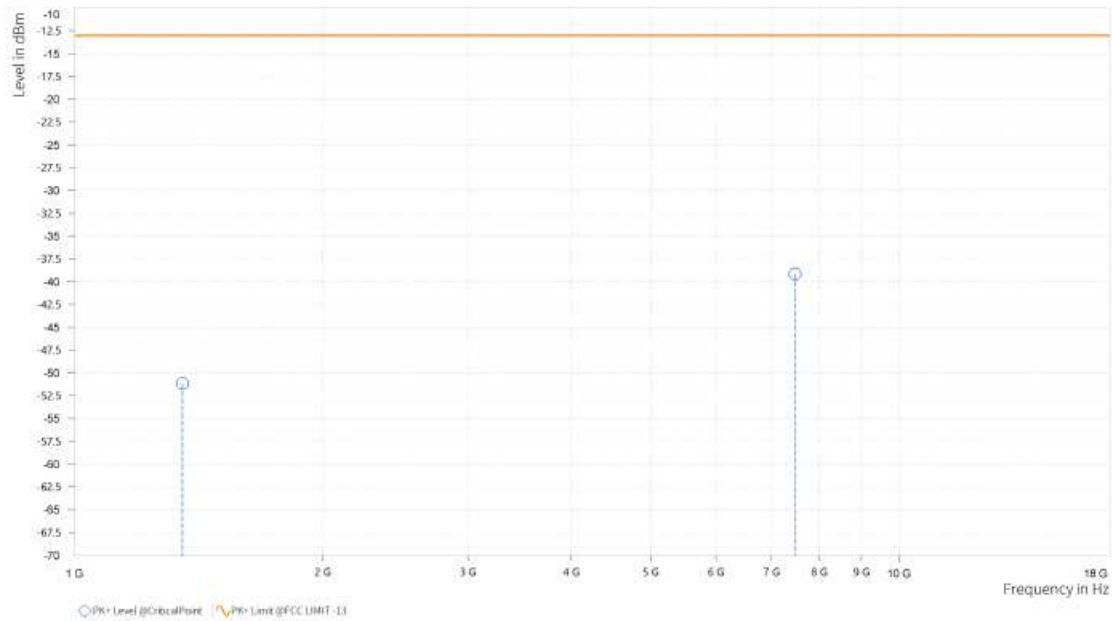



Test Report No.: W7L-P23100014RF06

MODE	TX channel 133272	FREQUENCY RANGE	Above 1000MHz
ENVIRONMENTAL CONDITIONS	23deg. C, 70%RH	INPUT POWER	AC 120V/60Hz
TESTED BY	Jace Hu		
ANTENNA POLARITY & TEST DISTANCE: VERTICAL AT 3 M			

Rg	Frequency [MHz]	PK+ Level [dBm]	PK+ Limit [dBm]	PK+ Margin [dB]	Correction [dB]	Polarization	Azimuth [deg]	Antenna Height [m]
2	1,352.000	-53.70	-13.00	40.70	13.54	V	63	1
5	7,455.000	-38.54	-13.00	25.54	31.72	V	359	2

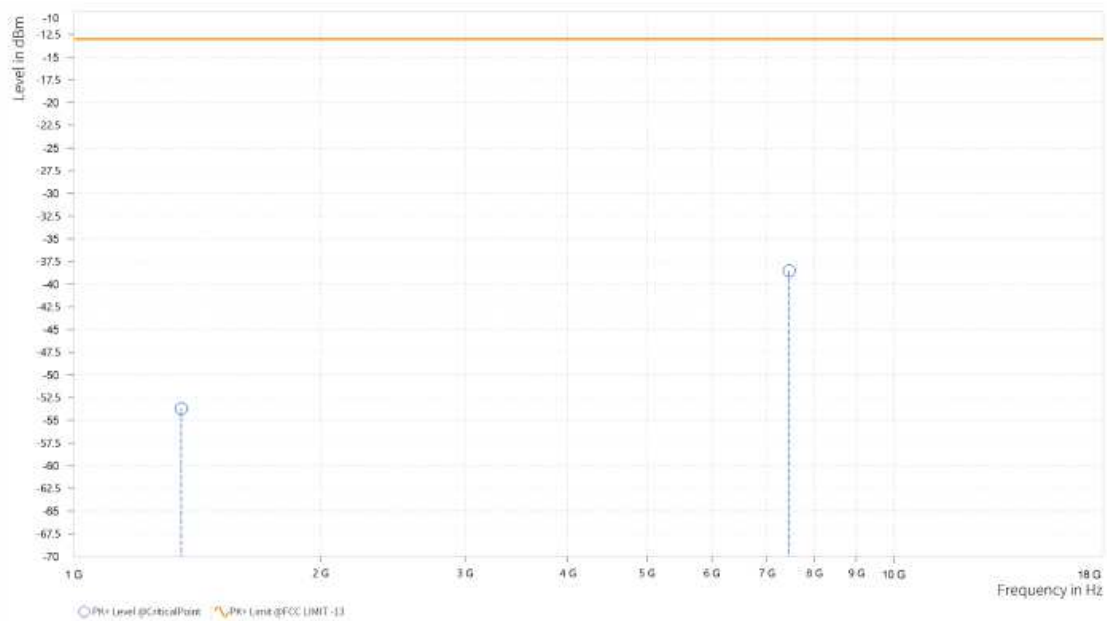



Test Report No.: W7L-P23100014RF06

CHANNEL BANDWIDTH: 15MHz / QPSK

MODE	TX channel 133297	FREQUENCY RANGE	Above 1000MHz
ENVIRONMENTAL CONDITIONS	23deg. C, 70%RH	INPUT POWER	AC 120V/60Hz
TESTED BY	Jace Hu		
ANTENNA POLARITY & TEST DISTANCE: HORIZONTAL AT 3 M			

Rg	Frequency [MHz]	PK+ Level [dBm]	PK+ Limit [dBm]	PK+ Margin [dB]	Correction [dB]	Polarization	Azimuth [deg]	Antenna Height [m]
2	1,347.500	-51.28	-13.00	38.28	14.24	H	297	2
5	7,875.500	-39.27	-13.00	26.27	33.00	H	0.9	2

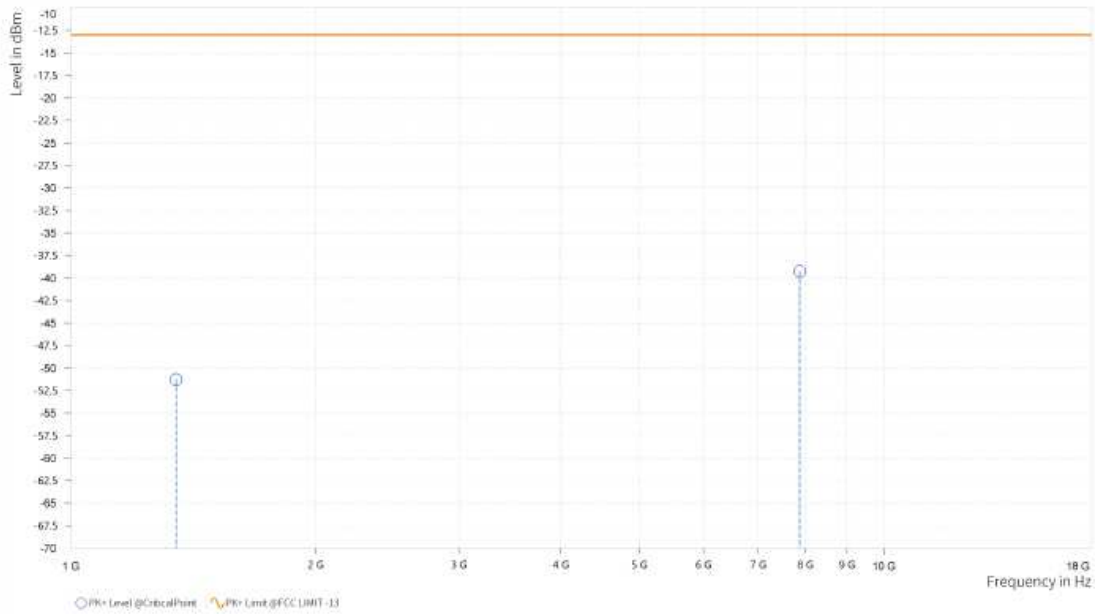



Test Report No.: W7L-P23100014RF06

MODE	TX channel 133297	FREQUENCY RANGE	Above 1000MHz
ENVIRONMENTAL CONDITIONS	23deg. C, 70%RH	INPUT POWER	AC 120V/60Hz
TESTED BY	Jace Hu		
ANTENNA POLARITY & TEST DISTANCE: VERTICAL AT 3 M			

Rg	Frequency [MHz]	PK+ Level [dBm]	PK+ Limit [dBm]	PK+ Margin [dB]	Correction [dB]	Polarization	Azimuth [deg]	Antenna Height [m]
2	1,347.500	-50.10	-13.00	37.10	13.70	V	359	1
5	7,469.500	-38.61	-13.00	25.61	31.75	V	1	2

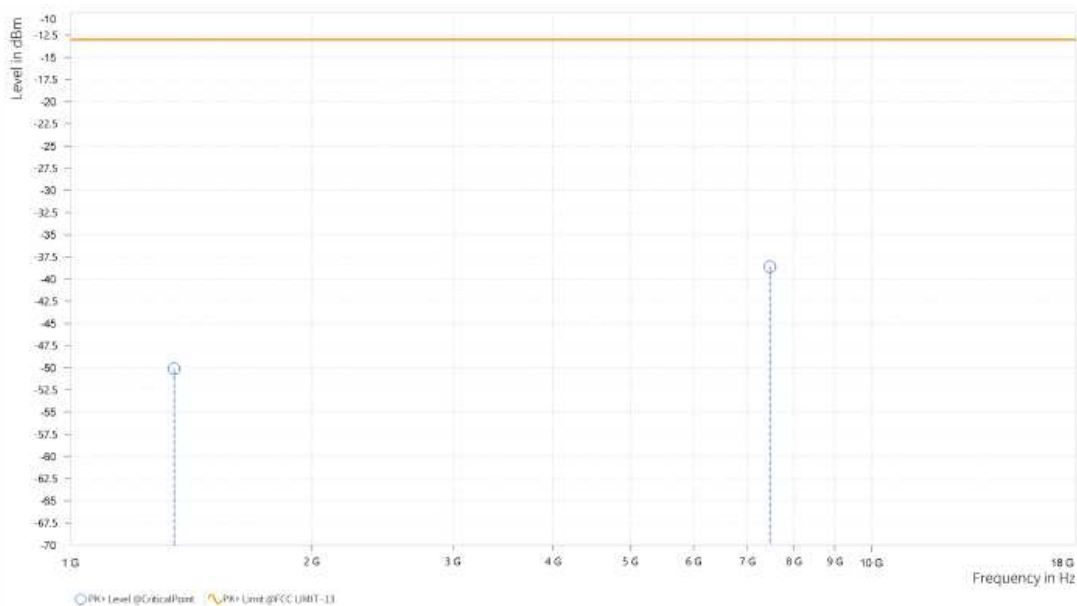



Test Report No.: W7L-P23100014RF06

CHANNEL BANDWIDTH: 20MHz / QPSK

MODE	TX channel 133322	FREQUENCY RANGE	Above 1000MHz
ENVIRONMENTAL CONDITIONS	23deg. C, 70%RH	INPUT POWER	AC 120V/60Hz
TESTED BY	Jace Hu		
ANTENNA POLARITY & TEST DISTANCE: HORIZONTAL AT 3 M			

Rg	Frequency [MHz]	PK+ Level [dBm]	PK+ Limit [dBm]	PK+ Margin [dB]	Correction [dB]	Polarization	Azimuth [deg]	Antenna Height [m]
2	1,348.000	-52.83	-13.00	39.83	14.24	H	359	1
5	7,811.000	-38.31	-13.00	25.31	32.94	H	359	2

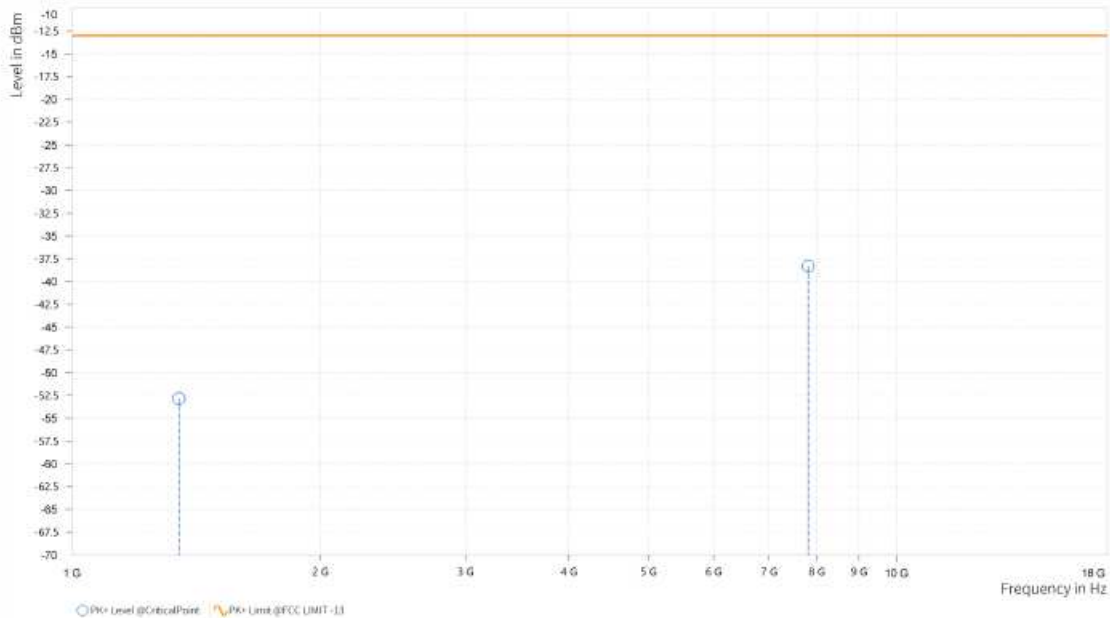



Test Report No.: W7L-P23100014RF06

MODE	TX channel 133322	FREQUENCY RANGE	Above 1000MHz
ENVIRONMENTAL CONDITIONS	23deg. C, 70%RH	INPUT POWER	AC 120V/60Hz
TESTED BY	Jace Hu		
ANTENNA POLARITY & TEST DISTANCE: VERTICAL AT 3 M			

Rg	Frequency [MHz]	PK+ Level [dBm]	PK+ Limit [dBm]	PK+ Margin [dB]	Correction [dB]	Polarization	Azimuth [deg]	Antenna Height [m]
2	1,348.500	-50.29	-13.00	37.29	13.67	V	0.9	2
5	7,716.500	-39.20	-13.00	26.20	32.96	V	268.6	1

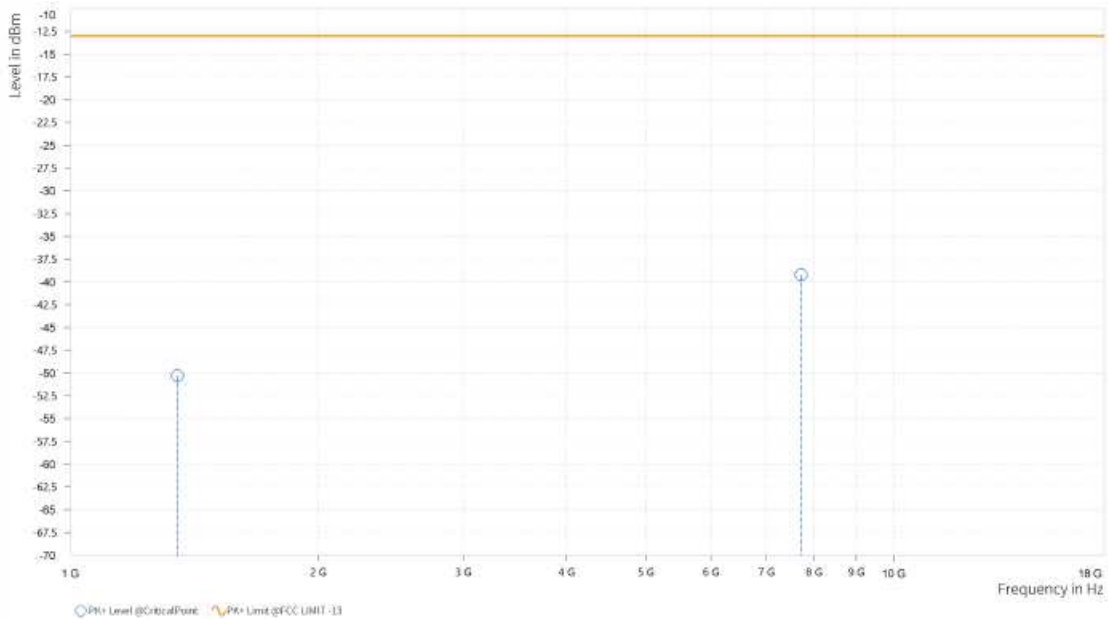

3.7 PEAK TO AVERAGE RATIO

3.7.1 LIMITS OF PEAK TO AVERAGE RATIO MEASUREMENT

In measuring transmissions in this band using an average power technique, the peak to-average ratio (PAR) of the transmission may not exceed 13 dB

3.7.2 TEST SETUP

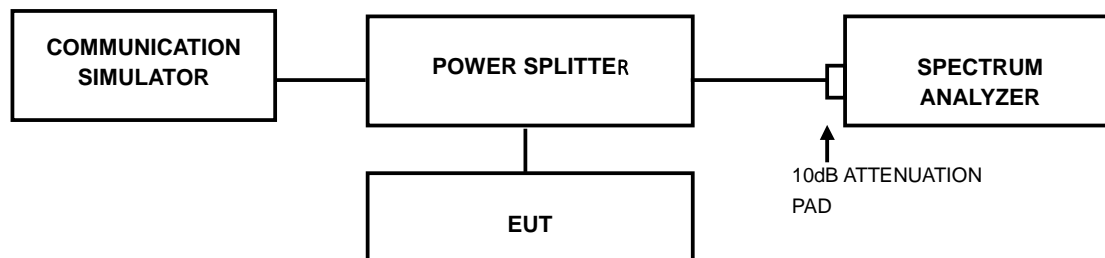

3.7.3 TEST PROCEDURES

1. Set resolution/measurement bandwidth \geq signal's occupied bandwidth;
2. Set the number of counts to a value that stabilizes the measured CCDF curve;
3. Record the maximum PAPR level associated with a probability of 0.1%.



Test Report No.: W7L-P23100014RF06

3.7.4 TEST RESULTS

Please Refer to Appendix Of this test report.



Test Report No.: W7L-P23100014RF06

4 INFORMATION ON THE TESTING LABORATORIES

We, BV 7LAYERS COMMUNICATIONS TECHNOLOGY (SHENZHEN) CO. LTD., were founded in 2015 to provide our best service in EMC, Radio, Telecom and Safety consultation. Our laboratories are accredited and approved according to ISO/IEC 17025.

If you have any comments, please feel free to contact us at the following:

Shenzhen EMC/RF Lab:

Tel: +86-755-88696566

Fax: +86-755-88696577

Email: customerservice.sw@cn.bureauveritas.com

Web Site: www.adt.com.tw

The address and road map of all our labs can be found in our web site also.



Test Report No.: W7L-P23100014RF06

5 MODIFICATIONS RECORDERS FOR ENGINEERING CHANGES TO THE EUT BY THE LAB

No any modifications are made to the EUT by the lab during the test.



Test Report No.: W7L-P23100014RF06

6 APPENDIX

WCDMA BAND4

PEAK-TO-AVERAGE RATIO

Test Result

Band	Channel	Peak-to-Average Ratio(dB)	Limit(dBm)	Verdict
Band4	1312	2.98	13	PASS
Band4	1413	2.88	13	PASS
Band4	1513	3.02	13	PASS



Test Graphs

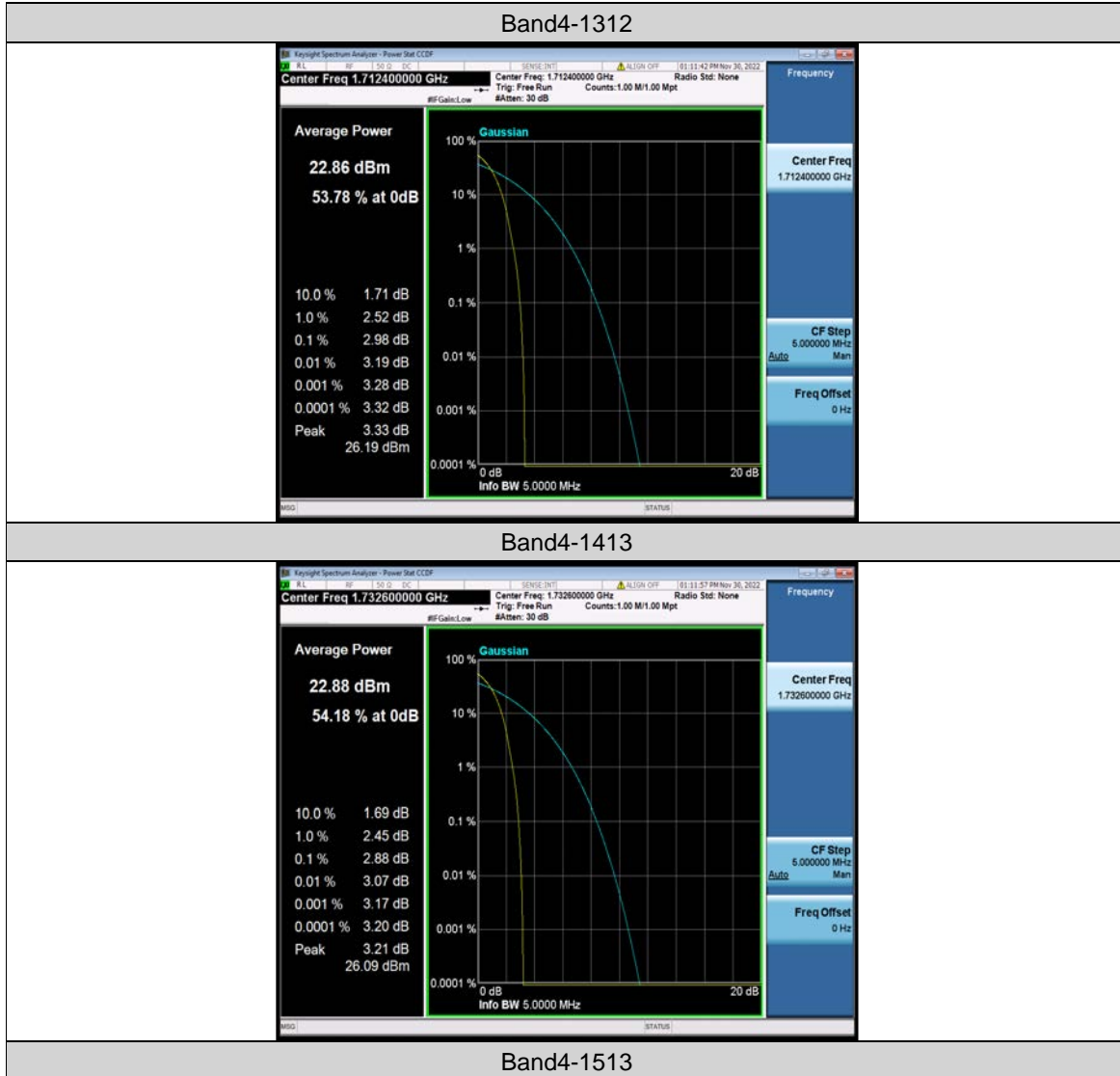



Test Report No.: W7L-P23100014RF06





Test Report No.: W7L-P23100014RF06

26DB BANDWIDTH AND OCCUPIED BANDWIDTH

Test Result

Band	Channel	Occupied Bandwidth (MHz)	26dB Bandwidth (MHz)	Limit(MHz)	Verdict
Band4	1312	4.1751	4.737	---	PASS
Band4	1413	4.1674	4.736	---	PASS
Band4	1513	4.1661	4.737	---	PASS



Test Graphs

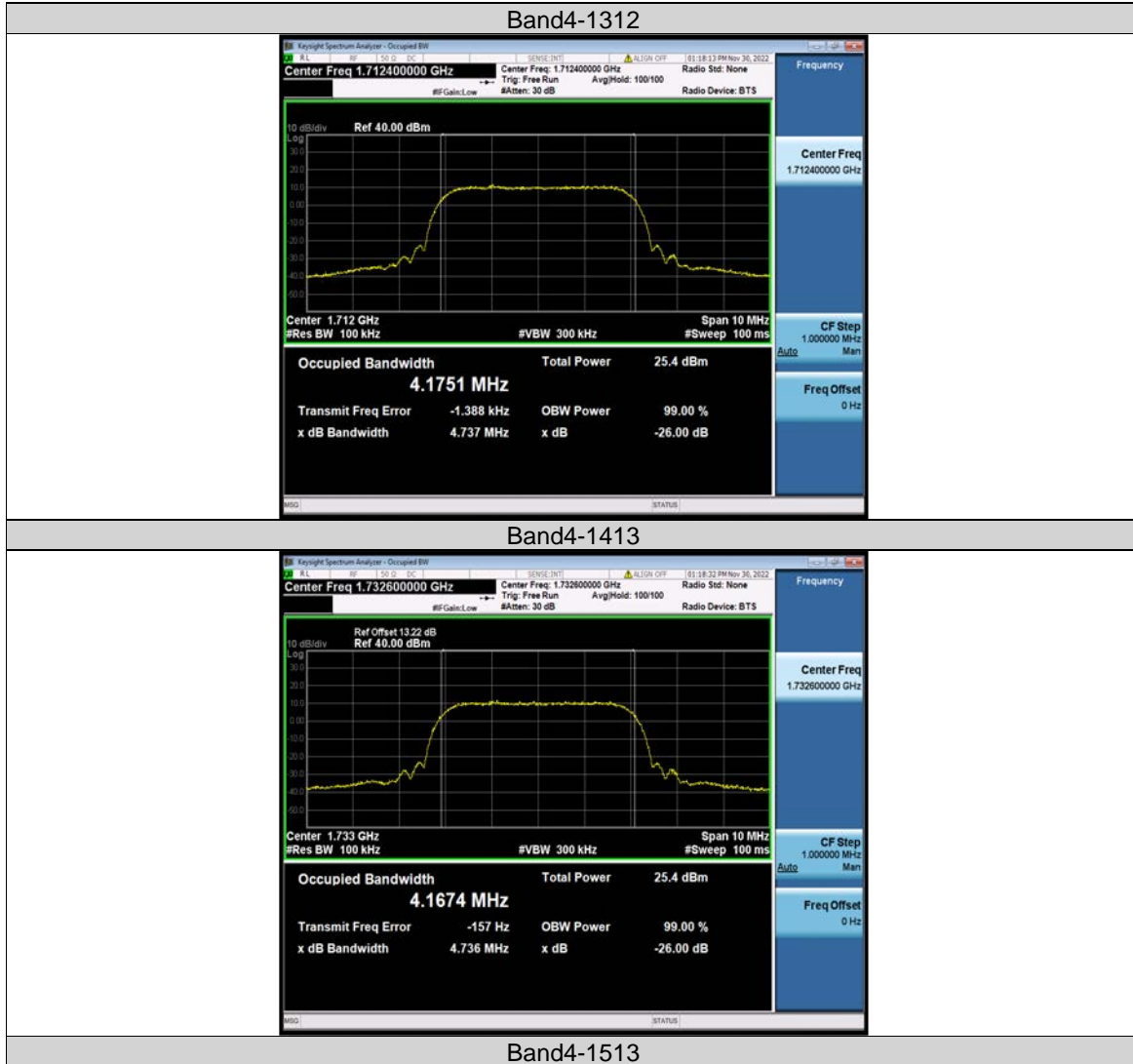



Test Report No.: W7L-P23100014RF06

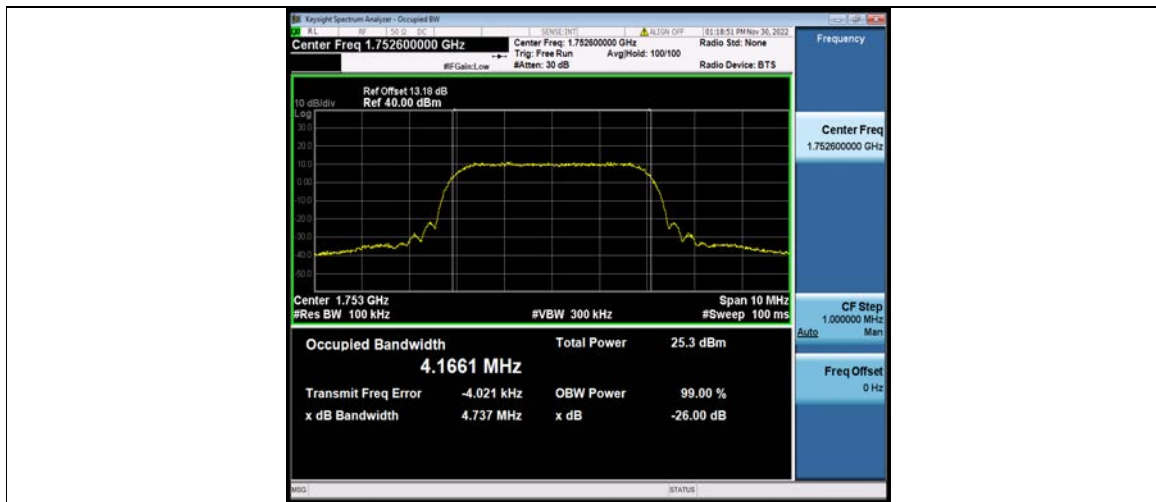



Test Report No.: W7L-P23100014RF06

BAND EDGE

Test Result

Band	Channel	Frequency (MHz)	Result (dBm)	Limit(dBm)	Verdict
Band4	1312	1710.00	-27.15	-13	PASS
Band4	1513	1755.15	-27.24	-13	PASS



Test Graphs





Test Report No.: W7L-P23100014RF06

CONDUCTED SPURIOUS EMISSION

Test Result

Band	Channel	Frequency Range (Mhz)	Frequency (dBm)	Result (dBm)	Limit (dBm)	Verdict
Band4	1312	30~1000MHz	570.19	-40.88	-13	PASS
Band4	1312	1000~20000MHz	18720.03	-32.21	-13	PASS
Band4	1413	30~1000MHz	955.12	-39.73	-13	PASS
Band4	1413	1000~20000MHz	19101.3	-31.76	-13	PASS
Band4	1513	30~1000MHz	872.38	-38.32	-13	PASS
Band4	1513	1000~20000MHz	19102.57	-31.85	-13	PASS



Test Graphs

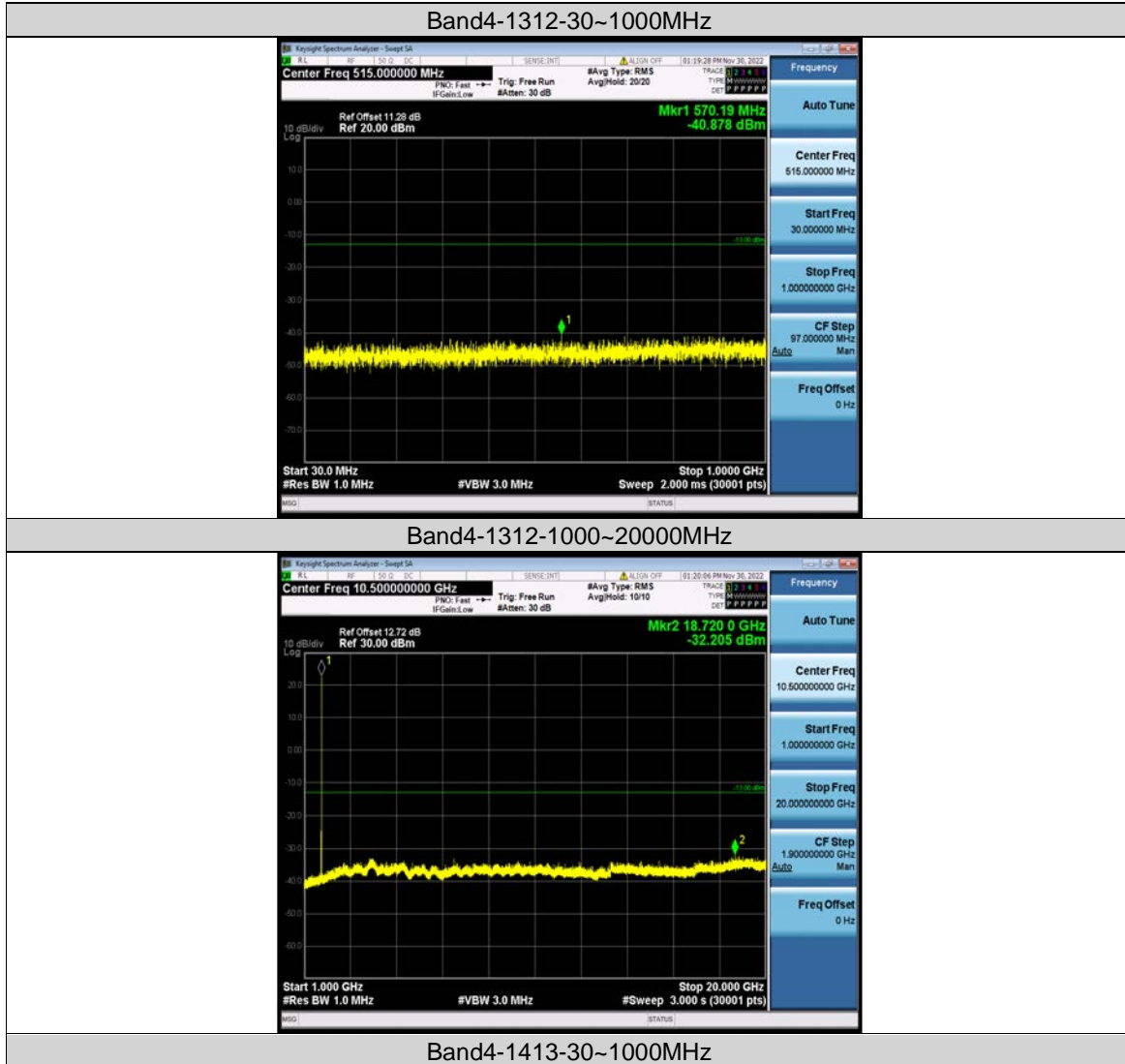



Test Report No.: W7L-P23100014RF06

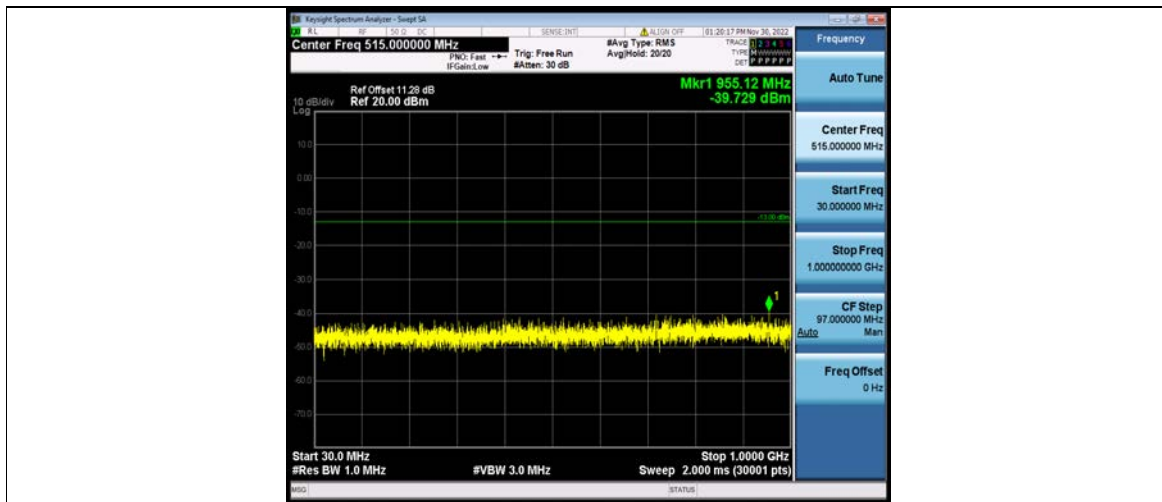

Band4-1413-1000~2000MHz



Band4-1513-30~1000MHz

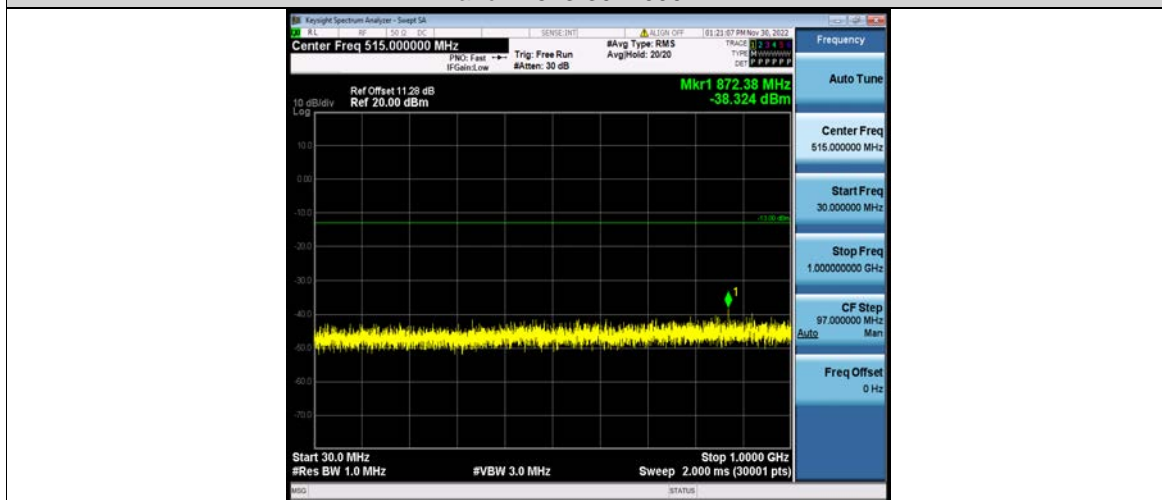

Band4-1513-1000~2000MHz



Test Report No.: W7L-P23100014RF06





FREQUENCY STABILITY

Test Result

Voltage							
Band	Channel	Voltage (Vdc)	Temperature (°C)	Deviation (Hz)	Deviation (ppm)	Limit (ppm)	Verdict
Band4	1312	VL	NT	10.04	0.005863	±2.5	PASS
Band4	1312	VN	NT	9.79	0.005717	±2.5	PASS
Band4	1312	VH	NT	9.85	0.005752	±2.5	PASS
Band4	1413	VL	NT	-2.98	-0.001720	±2.5	PASS
Band4	1413	VN	NT	-3.53	-0.002037	±2.5	PASS
Band4	1413	VH	NT	-3.39	-0.001957	±2.5	PASS
Band4	1513	VL	NT	-8.98	-0.005124	±2.5	PASS
Band4	1513	VN	NT	-8.88	-0.005067	±2.5	PASS
Band4	1513	VH	NT	-8.81	-0.005027	±2.5	PASS

Temperature							
Band	Channel	Voltage (Vdc)	Temperature (°C)	Deviation (Hz)	Deviation (ppm)	Limit (ppm)	Verdict
Band4	1312	NV	-30	9.99	0.005834	±2.5	PASS
Band4	1312	NV	-20	10.26	0.005992	±2.5	PASS
Band4	1312	NV	0	10.06	0.005875	±2.5	PASS
Band4	1312	NV	10	9.88	0.005770	±2.5	PASS
Band4	1312	NV	20	10.23	0.005974	±2.5	PASS
Band4	1312	NV	30	10.03	0.005857	±2.5	PASS
Band4	1312	NV	40	10.39	0.006068	±2.5	PASS
Band4	1312	NV	50	10.54	0.006155	±2.5	PASS
Band4	1413	NV	-30	-3.20	-0.001847	±2.5	PASS
Band4	1413	NV	-20	-2.88	-0.001662	±2.5	PASS
Band4	1413	NV	0	-2.84	-0.001639	±2.5	PASS
Band4	1413	NV	10	-3.07	-0.001772	±2.5	PASS
Band4	1413	NV	20	-3.37	-0.001945	±2.5	PASS
Band4	1413	NV	30	-3.08	-0.001778	±2.5	PASS
Band4	1413	NV	40	-2.99	-0.001726	±2.5	PASS
Band4	1413	NV	50	-2.85	-0.001645	±2.5	PASS
Band4	1513	NV	-30	-8.73	-0.004981	±2.5	PASS
Band4	1513	NV	-20	-9.06	-0.005169	±2.5	PASS
Band4	1513	NV	0	-9.11	-0.005198	±2.5	PASS
Band4	1513	NV	10	-9.53	-0.005438	±2.5	PASS
Band4	1513	NV	20	-9.65	-0.005506	±2.5	PASS
Band4	1513	NV	30	-9.53	-0.005438	±2.5	PASS
Band4	1513	NV	40	-9.71	-0.005540	±2.5	PASS
Band4	1513	NV	50	-9.48	-0.005409	±2.5	PASS



Test Report No.: W7L-P23100014RF06

LTE BAND7

PEAK-TO-AVERAGE RATIO(CCDF)

Test Result

Band	Bandwidth	Modulation	Channel	RB Configuration	Result(dB)	Limit(dB)	Verdict
Band7	5MHz	QPSK	20775	1RB#0	3.54	13	PASS
Band7	5MHz	QPSK	20775	25RB#0	4.99	13	PASS
Band7	5MHz	QPSK	21100	1RB#0	3.54	13	PASS
Band7	5MHz	QPSK	21100	25RB#0	4.70	13	PASS
Band7	5MHz	QPSK	21425	1RB#0	3.23	13	PASS
Band7	5MHz	QPSK	21425	25RB#0	4.52	13	PASS
Band7	5MHz	16QAM	20775	1RB#0	5.18	13	PASS
Band7	5MHz	16QAM	20775	25RB#0	5.78	13	PASS
Band7	5MHz	16QAM	21100	1RB#0	5.06	13	PASS
Band7	5MHz	16QAM	21100	25RB#0	5.57	13	PASS
Band7	5MHz	16QAM	21425	1RB#0	4.54	13	PASS
Band7	5MHz	16QAM	21425	25RB#0	5.35	13	PASS
Band7	5MHz	64QAM	20775	1RB#0	6.00	13	PASS
Band7	5MHz	64QAM	20775	25RB#0	6.42	13	PASS
Band7	5MHz	64QAM	21100	1RB#0	6.37	13	PASS
Band7	5MHz	64QAM	21100	25RB#0	6.51	13	PASS
Band7	5MHz	64QAM	21425	1RB#0	5.81	13	PASS
Band7	5MHz	64QAM	21425	25RB#0	6.17	13	PASS
Band7	10MHz	QPSK	20800	1RB#0	3.47	13	PASS
Band7	10MHz	QPSK	20800	50RB#0	4.97	13	PASS
Band7	10MHz	QPSK	21100	1RB#0	3.31	13	PASS
Band7	10MHz	QPSK	21100	50RB#0	4.67	13	PASS
Band7	10MHz	QPSK	21400	1RB#0	3.25	13	PASS
Band7	10MHz	QPSK	21400	50RB#0	4.65	13	PASS
Band7	10MHz	16QAM	20800	1RB#0	5.13	13	PASS
Band7	10MHz	16QAM	20800	50RB#0	5.83	13	PASS
Band7	10MHz	16QAM	21100	1RB#0	4.81	13	PASS
Band7	10MHz	16QAM	21100	50RB#0	5.53	13	PASS
Band7	10MHz	16QAM	21400	1RB#0	4.96	13	PASS
Band7	10MHz	16QAM	21400	50RB#0	5.50	13	PASS
Band7	10MHz	64QAM	20800	1RB#0	6.21	13	PASS
Band7	10MHz	64QAM	20800	50RB#0	6.51	13	PASS
Band7	10MHz	64QAM	21100	1RB#0	5.95	13	PASS
Band7	10MHz	64QAM	21100	50RB#0	6.46	13	PASS
Band7	10MHz	64QAM	21400	1RB#0	6.08	13	PASS
Band7	10MHz	64QAM	21400	50RB#0	6.25	13	PASS
Band7	15MHz	QPSK	20825	1RB#0	3.44	13	PASS
Band7	15MHz	QPSK	20825	75RB#0	5.22	13	PASS
Band7	15MHz	QPSK	21100	1RB#0	3.36	13	PASS
Band7	15MHz	QPSK	21100	75RB#0	4.99	13	PASS
Band7	15MHz	QPSK	21375	1RB#0	3.48	13	PASS
Band7	15MHz	QPSK	21375	75RB#0	5.04	13	PASS
Band7	15MHz	16QAM	20825	1RB#0	4.94	13	PASS
Band7	15MHz	16QAM	20825	75RB#0	5.95	13	PASS
Band7	15MHz	16QAM	21100	1RB#0	5.16	13	PASS
Band7	15MHz	16QAM	21100	75RB#0	5.73	13	PASS



BUREAU
VERITAS

Test Report No.: W7L-P23100014RF06

Band7	15MHz	16QAM	21375	1RB#0	5.19	13	PASS
Band7	15MHz	16QAM	21375	75RB#0	5.80	13	PASS
Band7	15MHz	64QAM	20825	1RB#0	5.95	13	PASS
Band7	15MHz	64QAM	20825	75RB#0	6.53	13	PASS
Band7	15MHz	64QAM	21100	1RB#0	8.36	13	PASS
Band7	15MHz	64QAM	21100	75RB#0	6.53	13	PASS
Band7	15MHz	64QAM	21375	1RB#0	6.64	13	PASS
Band7	15MHz	64QAM	21375	75RB#0	6.41	13	PASS
Band7	20MHz	QPSK	20850	1RB#0	3.45	13	PASS
Band7	20MHz	QPSK	20850	100RB#0	5.08	13	PASS
Band7	20MHz	QPSK	21100	1RB#0	3.51	13	PASS
Band7	20MHz	QPSK	21100	100RB#0	4.91	13	PASS
Band7	20MHz	QPSK	21350	1RB#0	3.49	13	PASS
Band7	20MHz	QPSK	21350	100RB#0	4.96	13	PASS
Band7	20MHz	16QAM	20850	1RB#0	5.16	13	PASS
Band7	20MHz	16QAM	20850	100RB#0	5.88	13	PASS
Band7	20MHz	16QAM	21100	1RB#0	4.98	13	PASS
Band7	20MHz	16QAM	21100	100RB#0	5.71	13	PASS
Band7	20MHz	16QAM	21350	1RB#0	5.29	13	PASS
Band7	20MHz	16QAM	21350	100RB#0	5.81	13	PASS
Band7	20MHz	64QAM	20850	1RB#0	6.32	13	PASS
Band7	20MHz	64QAM	20850	100RB#0	6.56	13	PASS
Band7	20MHz	64QAM	21100	1RB#0	6.21	13	PASS
Band7	20MHz	64QAM	21100	100RB#0	6.55	13	PASS
Band7	20MHz	64QAM	21350	1RB#0	6.50	13	PASS
Band7	20MHz	64QAM	21350	100RB#0	6.43	13	PASS



Test Graphs

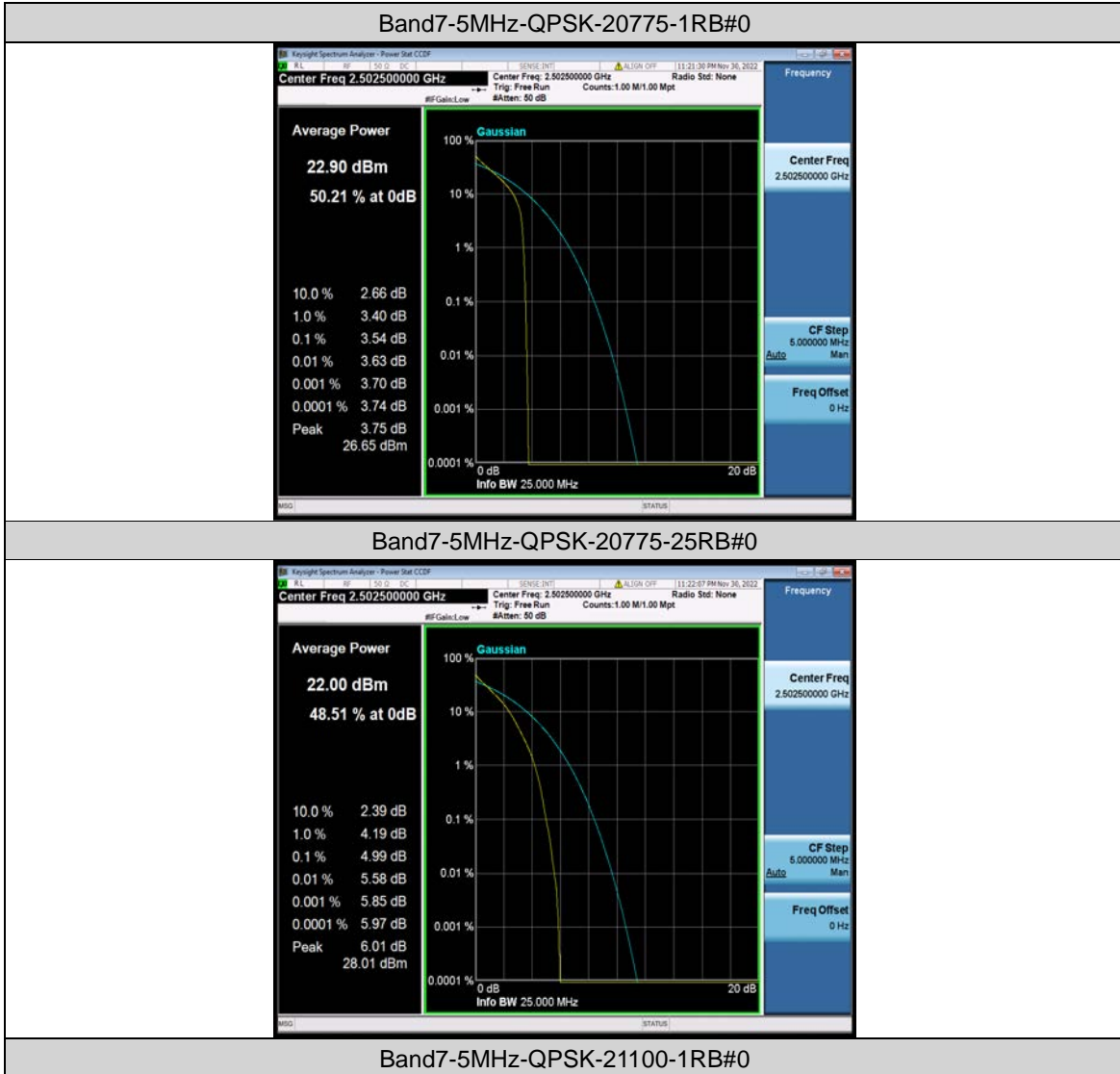



Test Report No.: W7L-P23100014RF06





Test Report No.: W7L-P23100014RF06

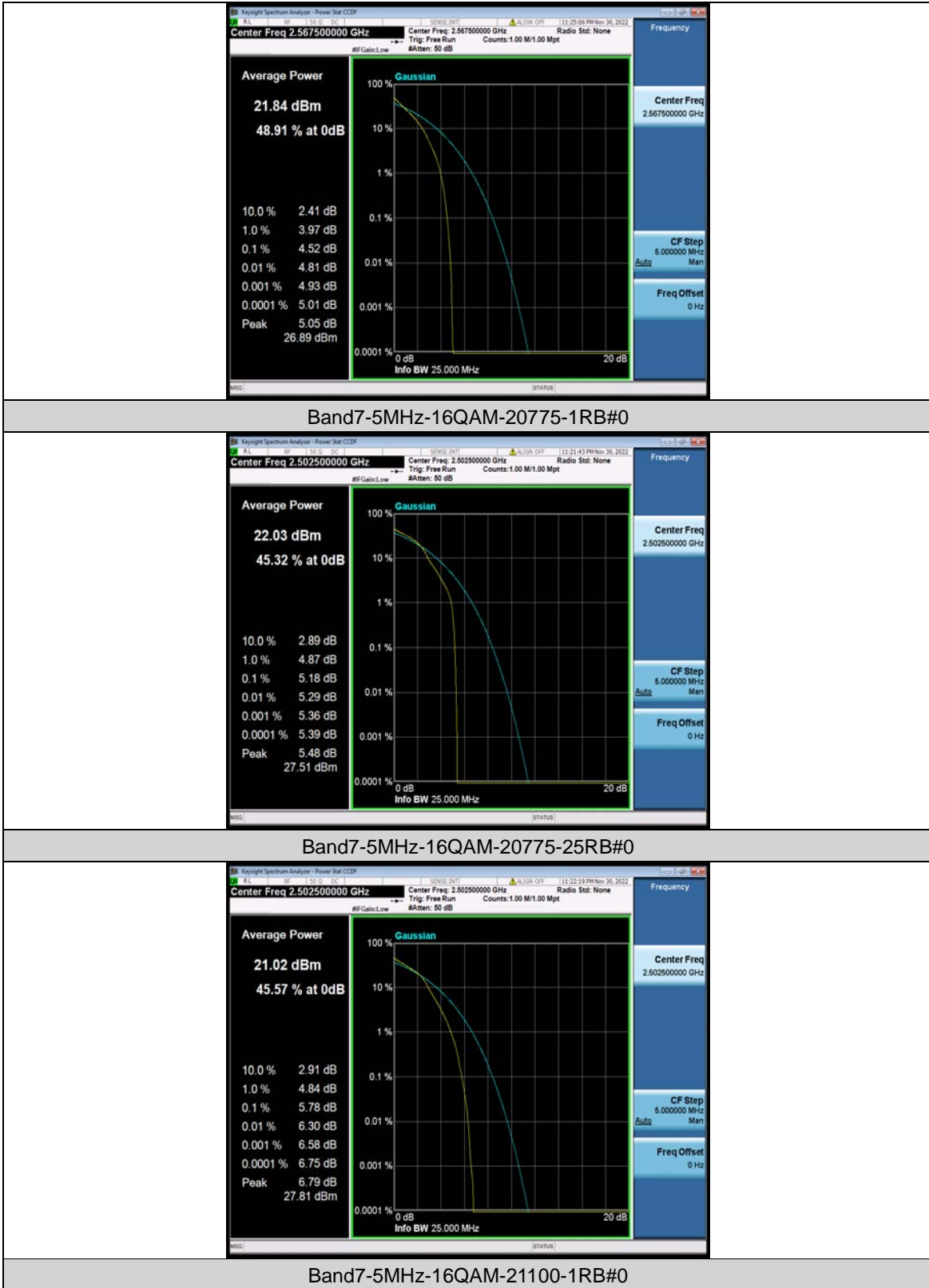



Test Report No.: W7L-P23100014RF06

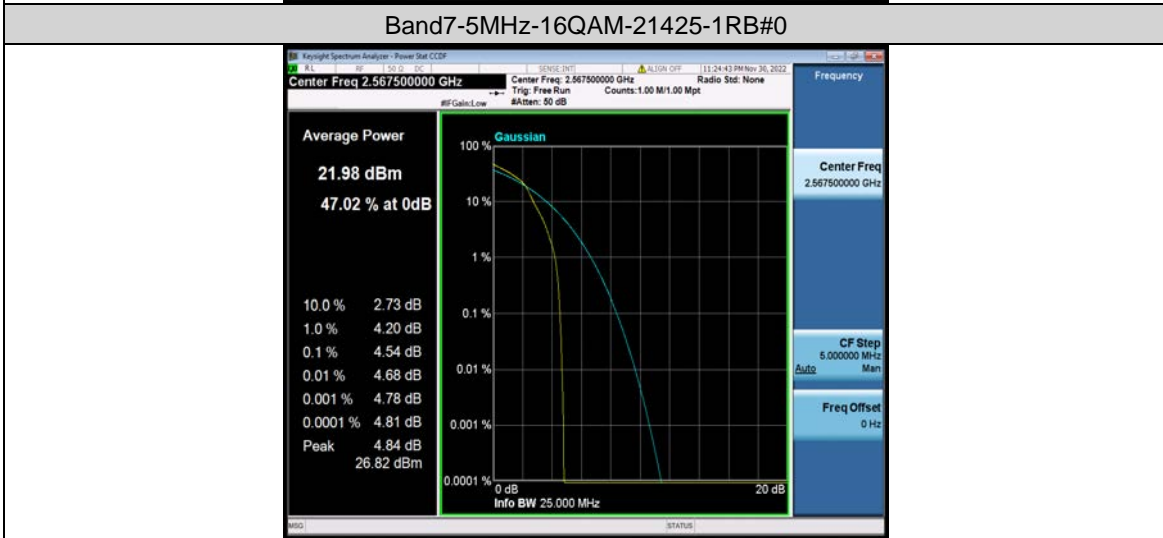
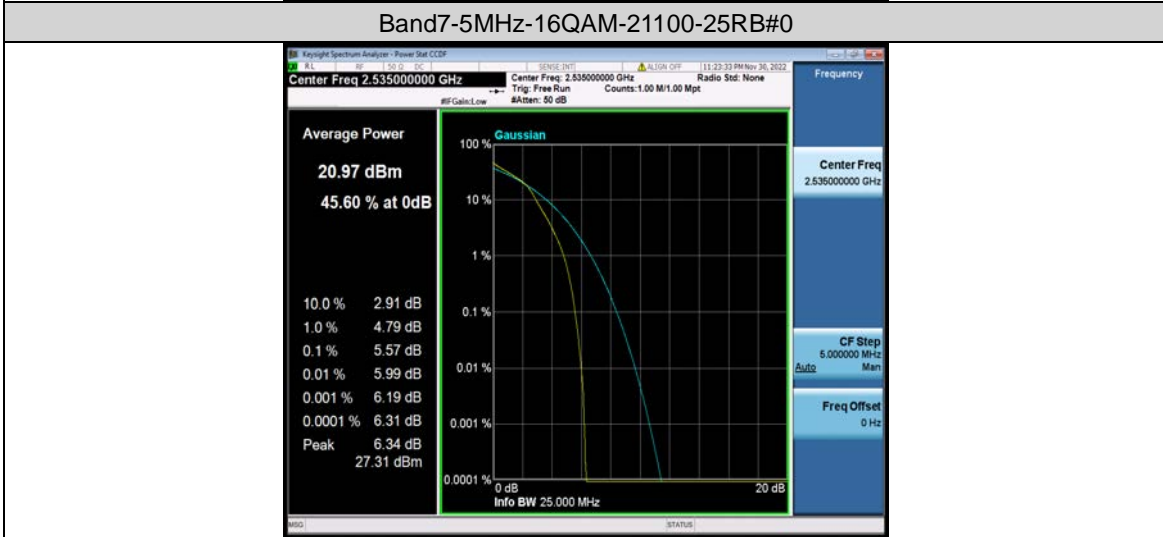
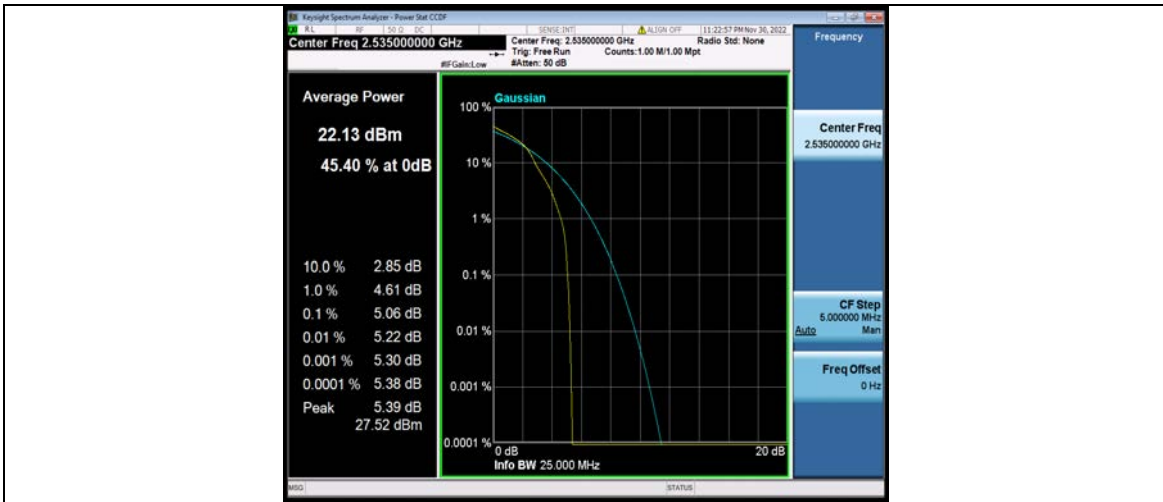



Test Report No.: W7L-P23100014RF06

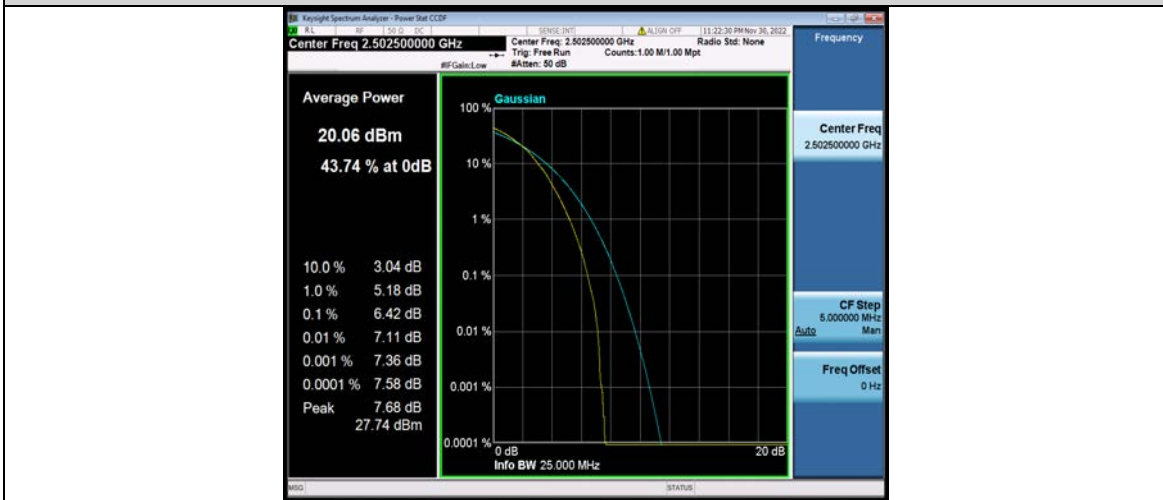
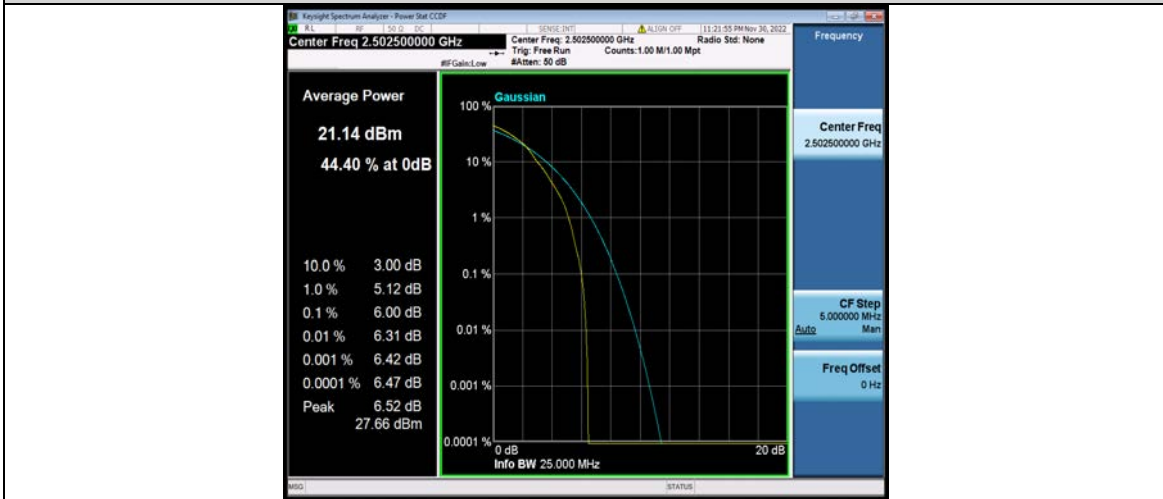



Test Report No.: W7L-P23100014RF06

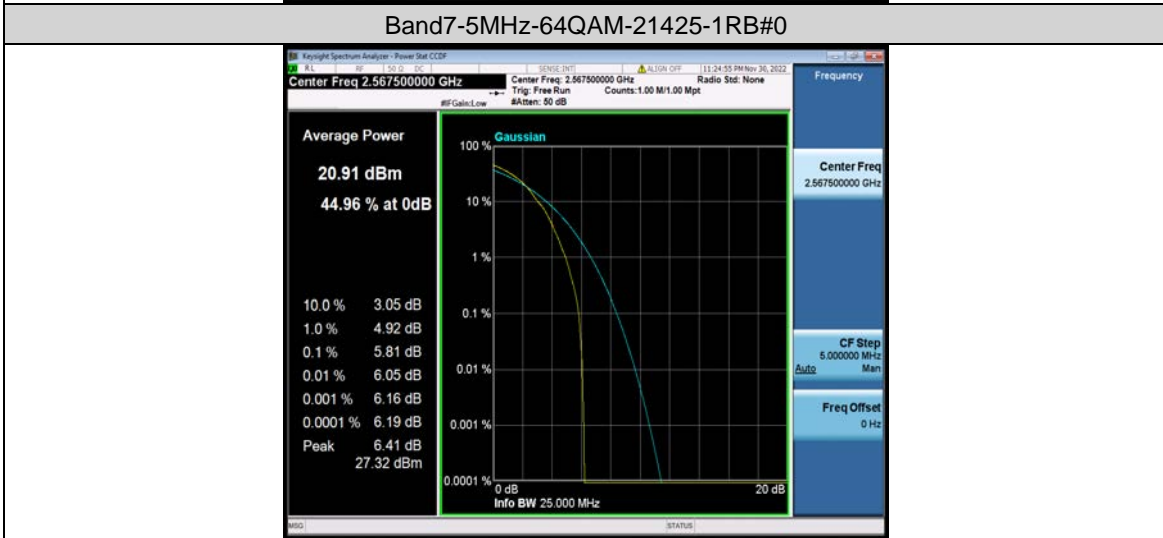
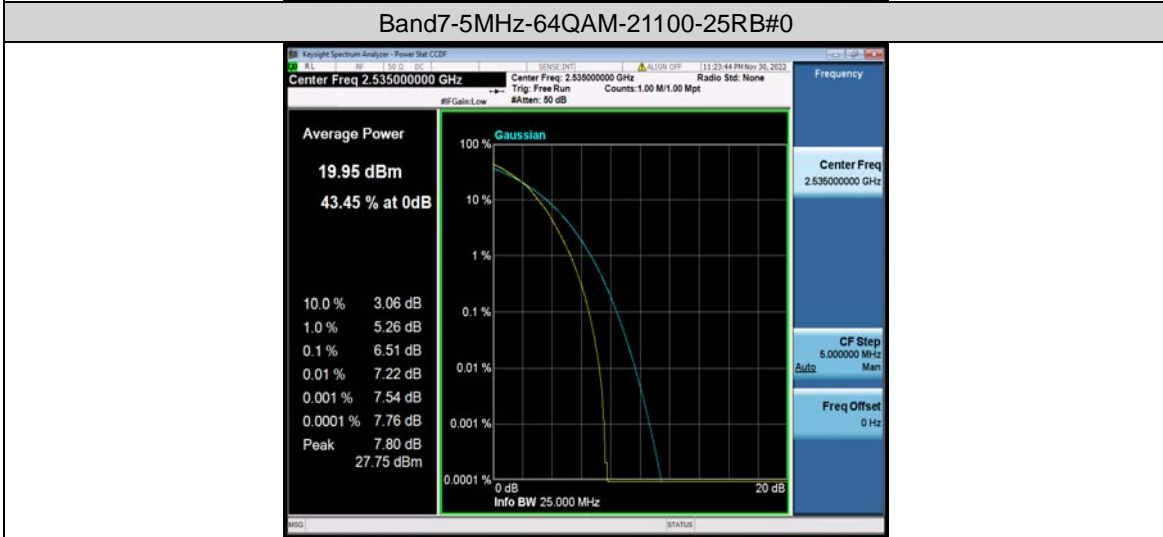



Test Report No.: W7L-P23100014RF06



Band7-10MHz-QPSK-20800-1RB#0

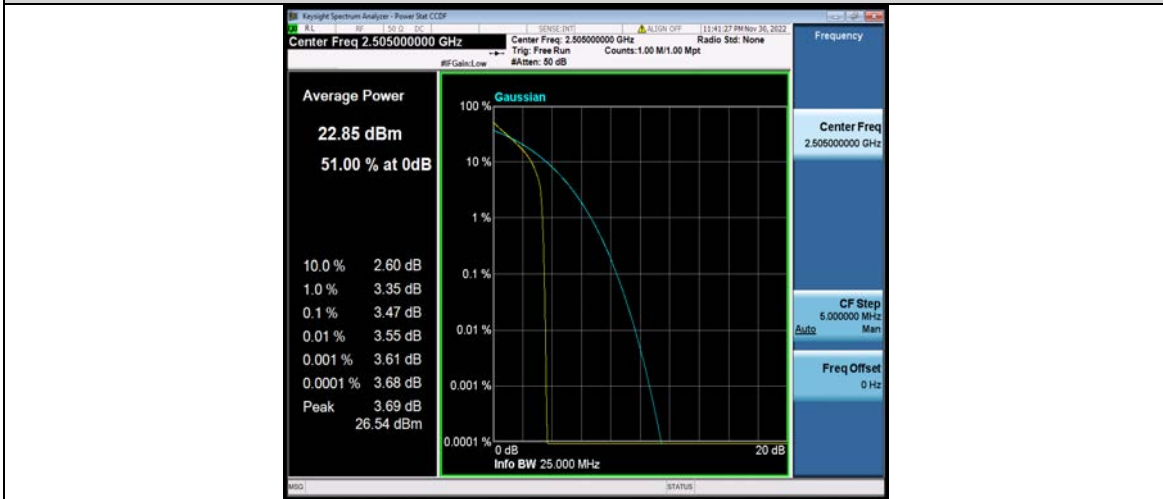

Band7-10MHz-QPSK-20800-50RB#0

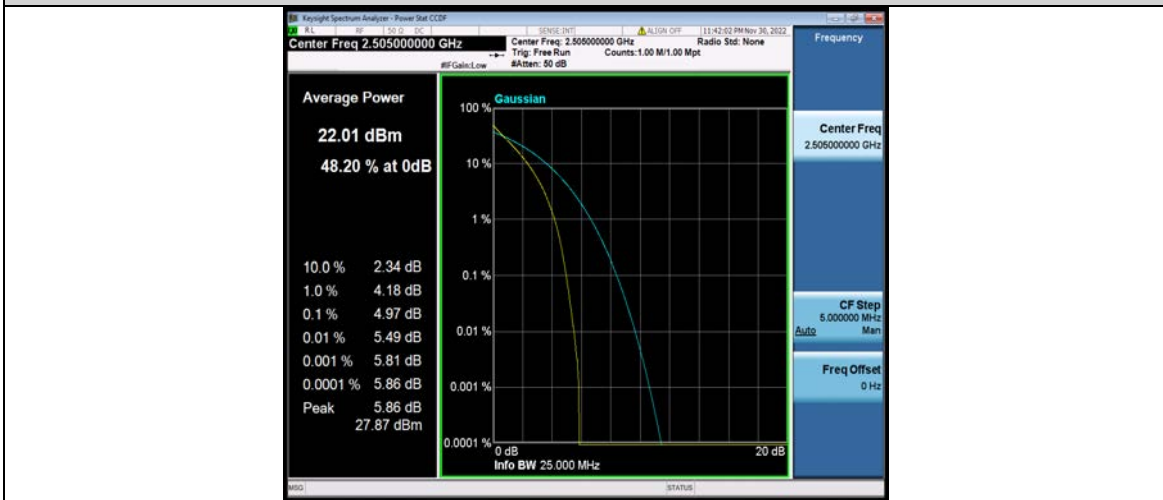

Band7-10MHz-QPSK-21100-1RB#0



Test Report No.: W7L-P23100014RF06

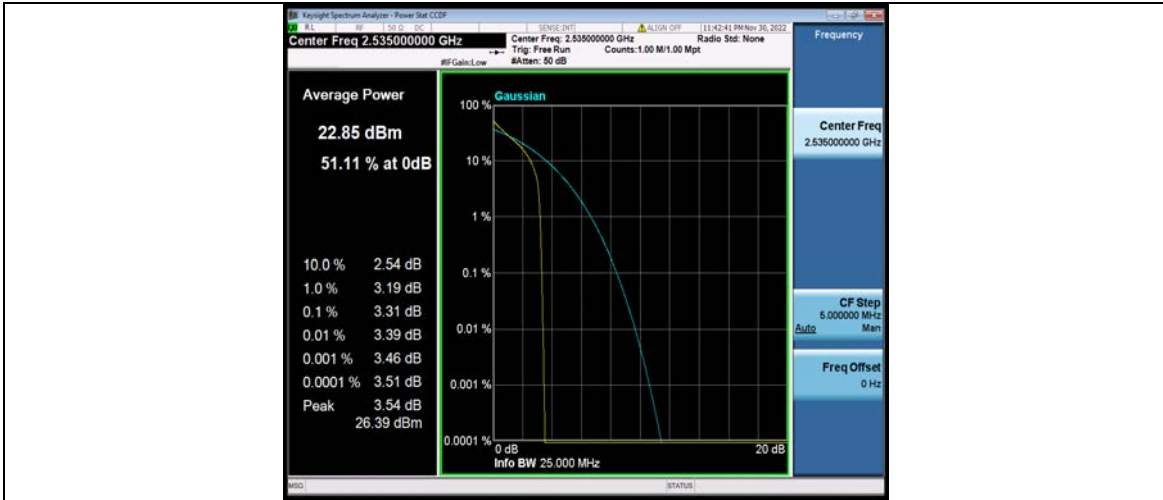

Band7-10MHz-QPSK-21100-50RB#0

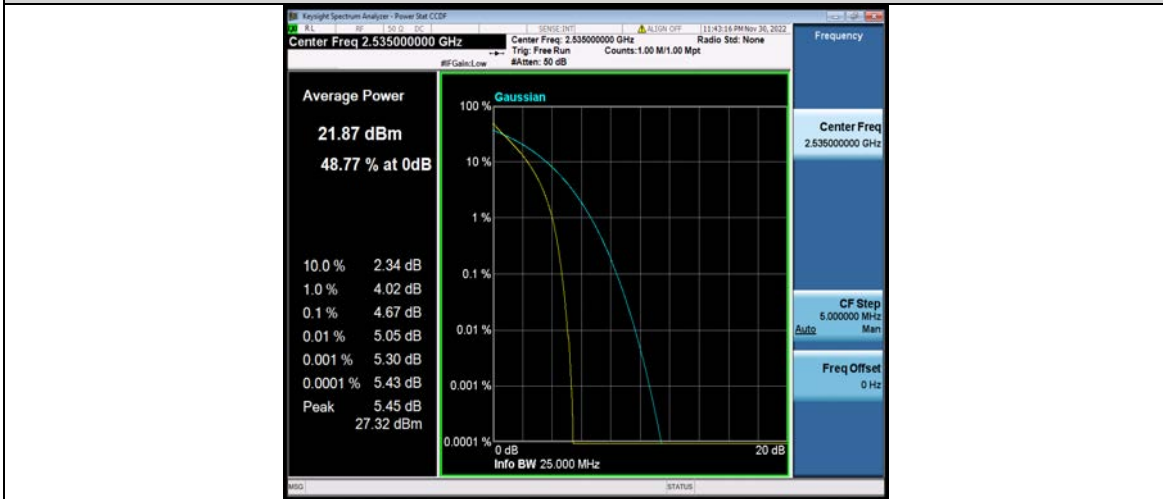

Band7-10MHz-QPSK-21400-1RB#0

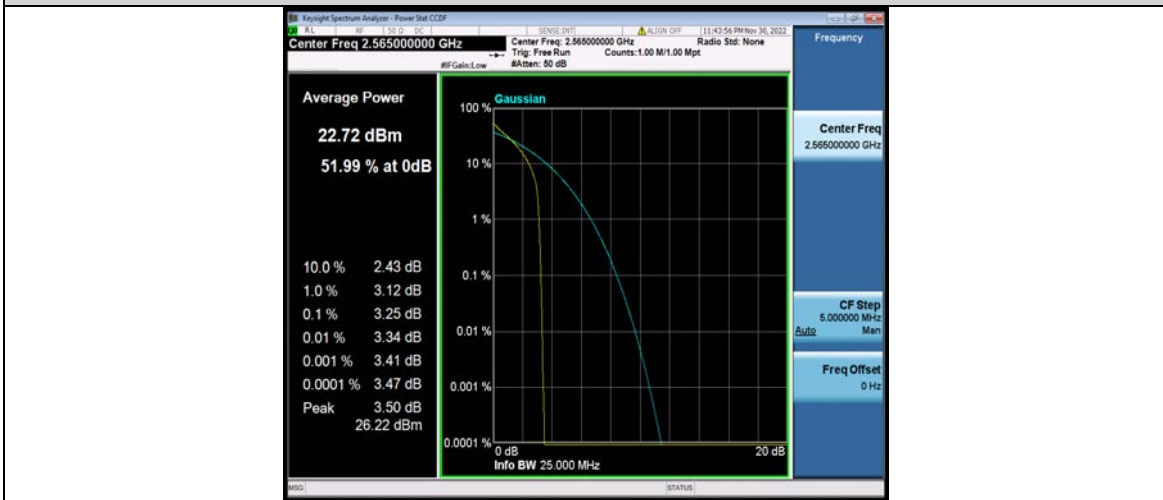

Band7-10MHz-QPSK-21400-50RB#0



Test Report No.: W7L-P23100014RF06



Band7-10MHz-16QAM-20800-1RB#0

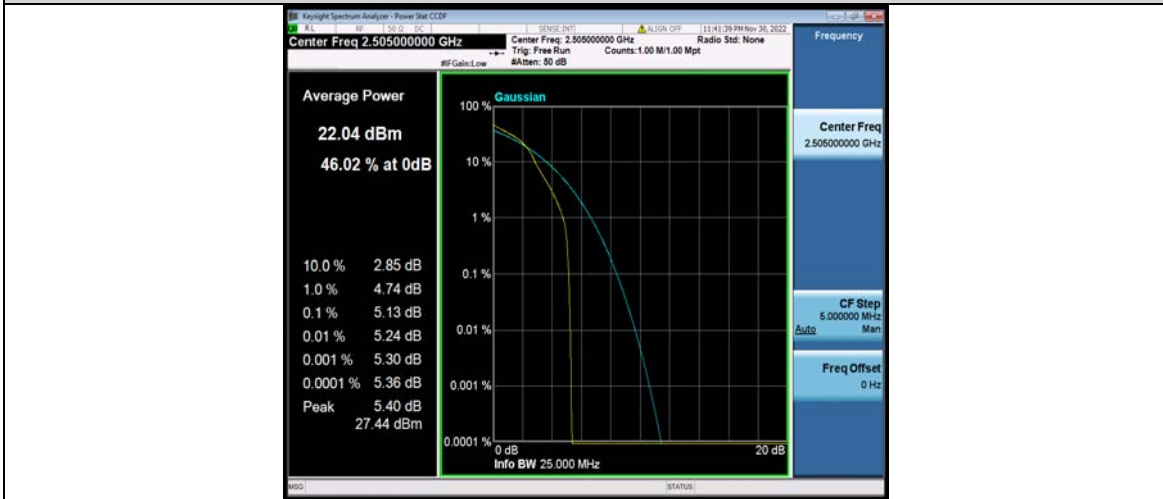

Band7-10MHz-16QAM-20800-50RB#0



Band7-10MHz-16QAM-21100-1RB#0



Test Report No.: W7L-P23100014RF06



Band7-10MHz-16QAM-21100-50RB#0



Band7-10MHz-16QAM-21400-1RB#0



Band7-10MHz-16QAM-21400-50RB#0



Test Report No.: W7L-P23100014RF06

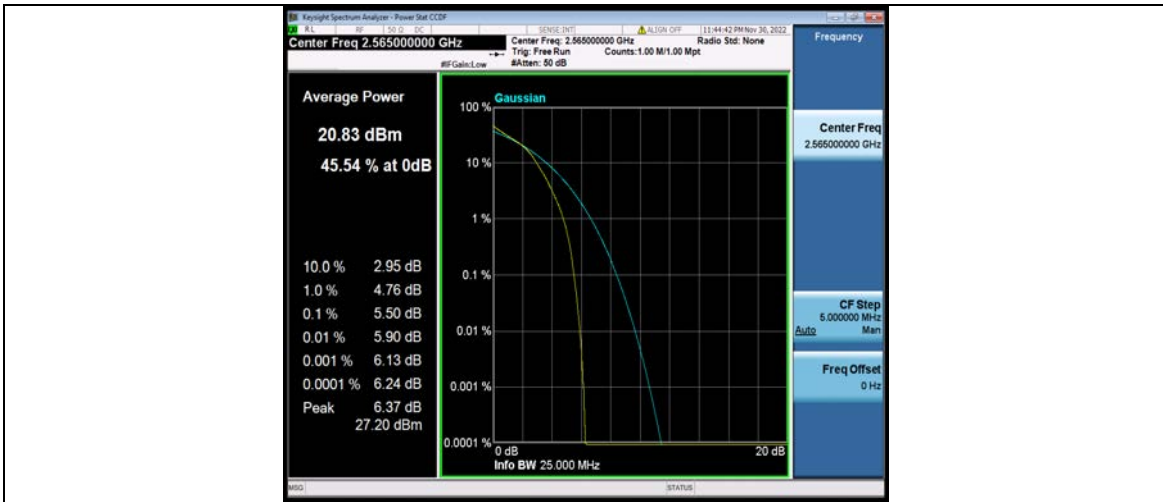

Band7-10MHz-64QAM-20800-1RB#0

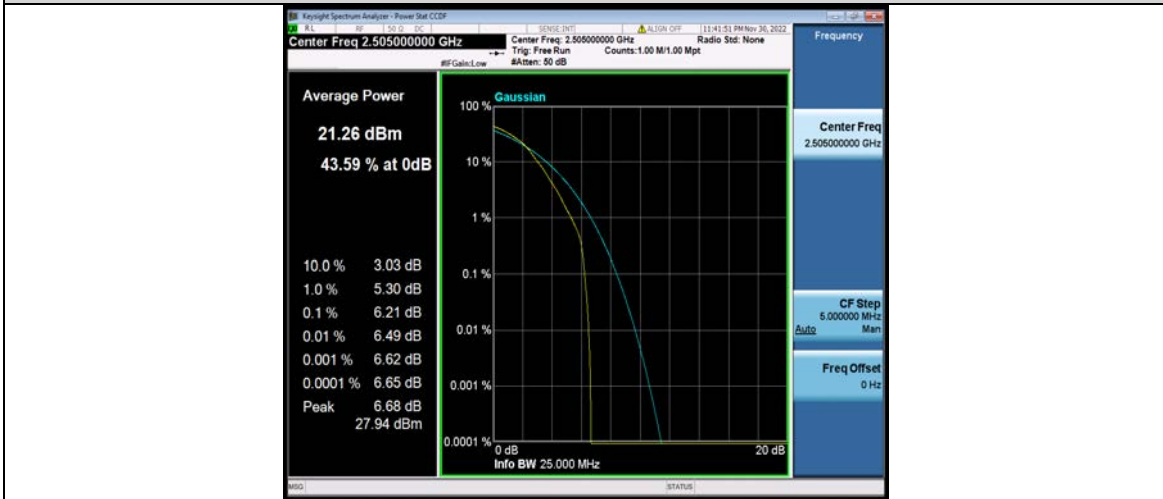

Band7-10MHz-64QAM-20800-50RB#0



Band7-10MHz-64QAM-21100-1RB#0



Test Report No.: W7L-P23100014RF06



Band7-10MHz-64QAM-21100-50RB#0

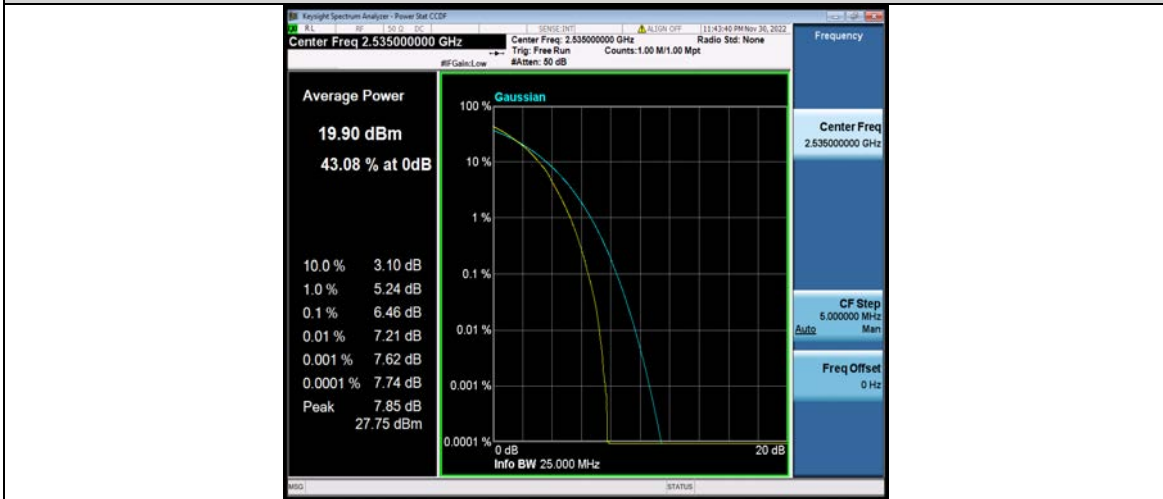

Band7-10MHz-64QAM-21400-1RB#0



Band7-10MHz-64QAM-21400-50RB#0



Test Report No.: W7L-P23100014RF06



Band7-15MHz-QPSK-20825-1RB#0

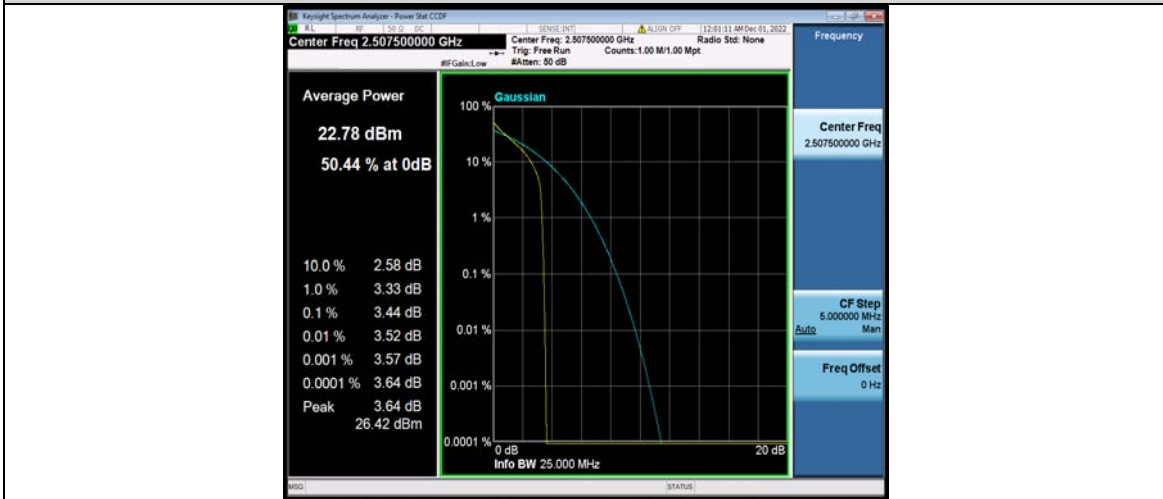

Band7-15MHz-QPSK-20825-75RB#0

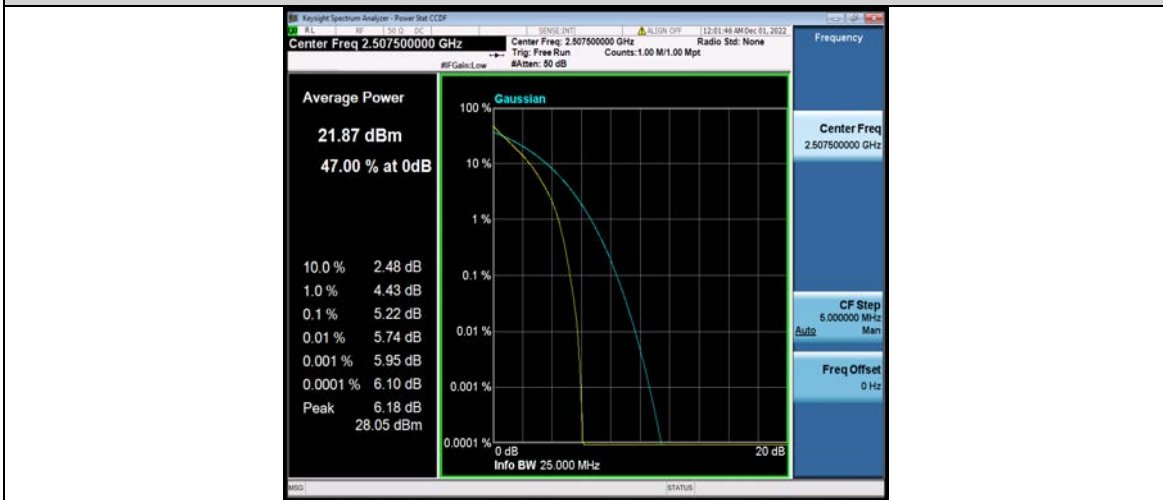

Band7-15MHz-QPSK-21100-1RB#0



Test Report No.: W7L-P23100014RF06



Band7-15MHz-QPSK-21100-75RB#0

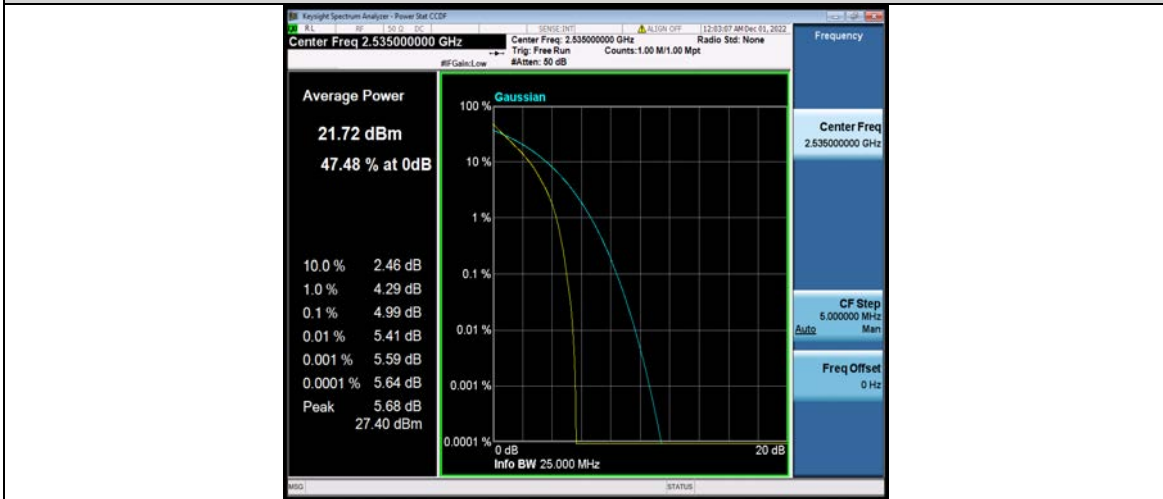

Band7-15MHz-QPSK-21375-1RB#0

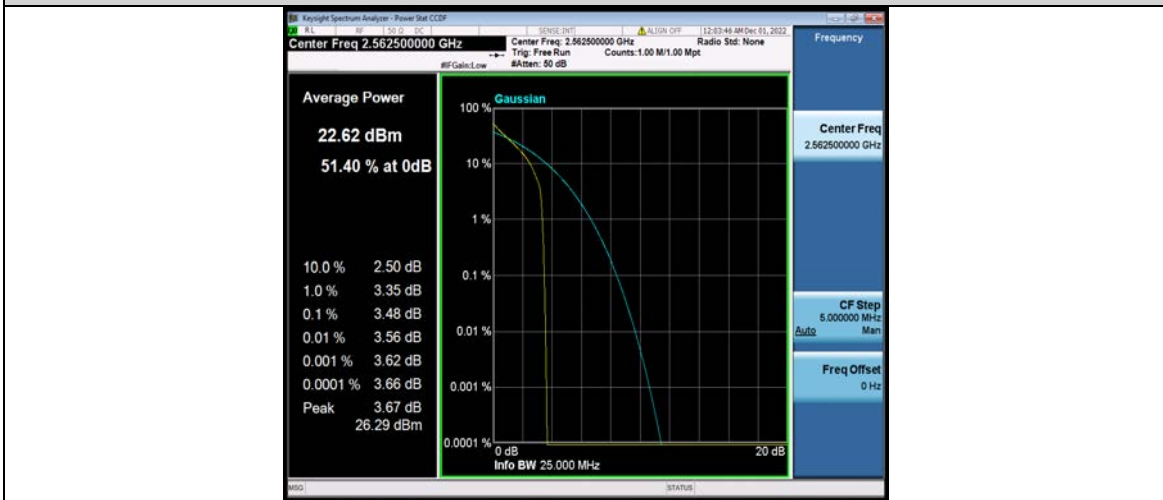

Band7-15MHz-QPSK-21375-75RB#0



Test Report No.: W7L-P23100014RF06



Band7-15MHz-16QAM-20825-1RB#0

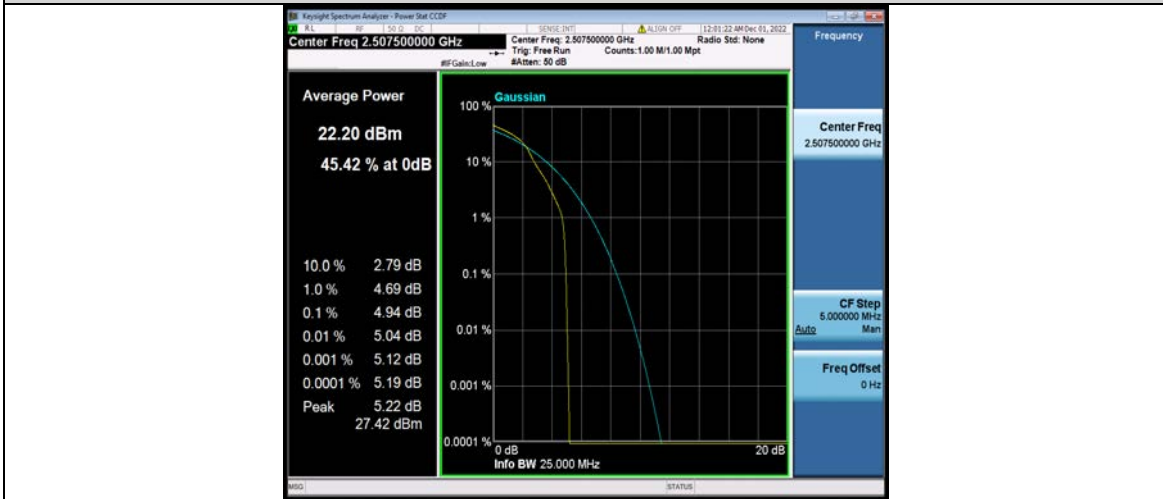

Band7-15MHz-16QAM-20825-75RB#0

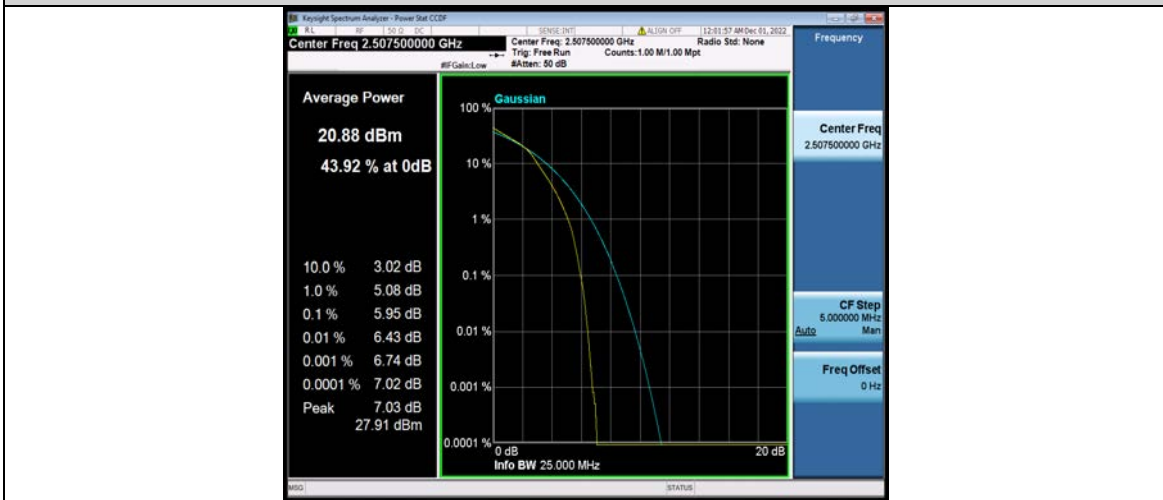

Band7-15MHz-16QAM-21100-1RB#0



Test Report No.: W7L-P23100014RF06



Band7-15MHz-16QAM-21100-75RB#0

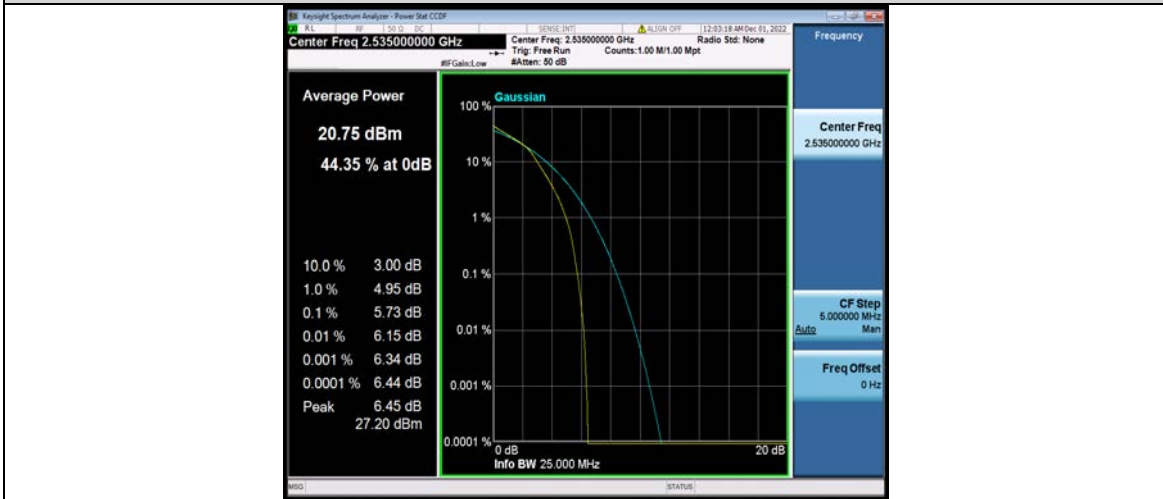

Band7-15MHz-16QAM-21375-1RB#0

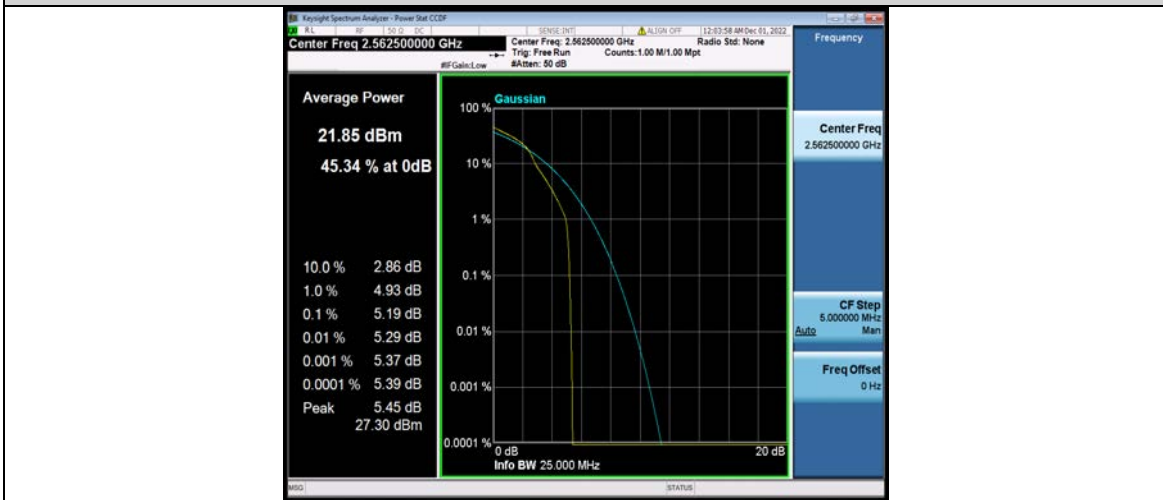

Band7-15MHz-16QAM-21375-75RB#0



Test Report No.: W7L-P23100014RF06

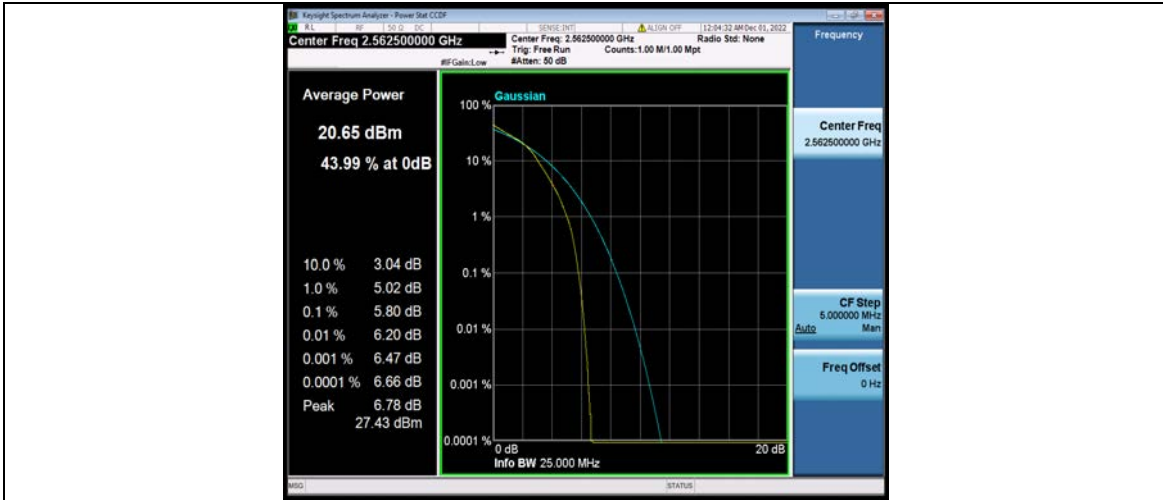

Band7-15MHz-64QAM-20825-1RB#0

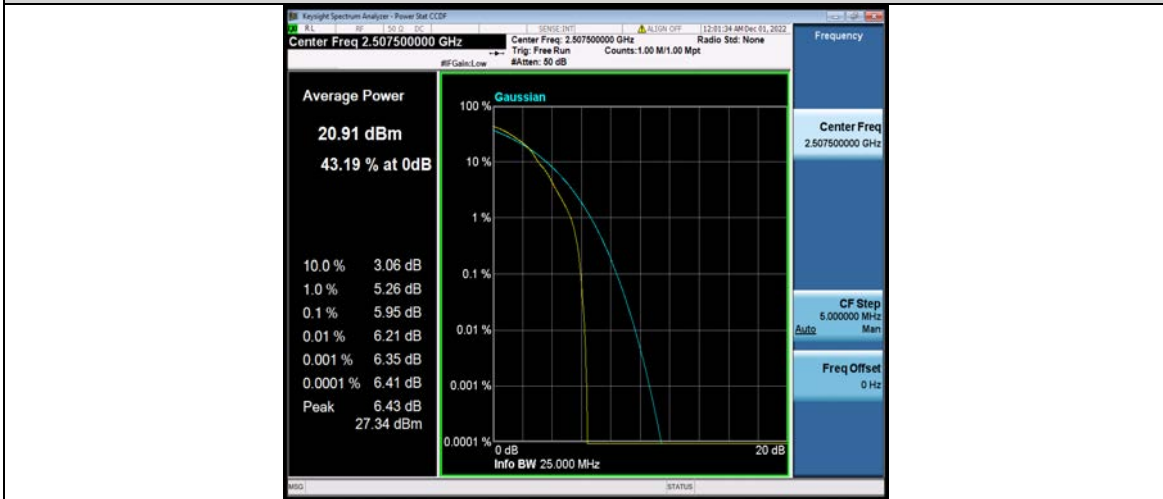

Band7-15MHz-64QAM-20825-75RB#0

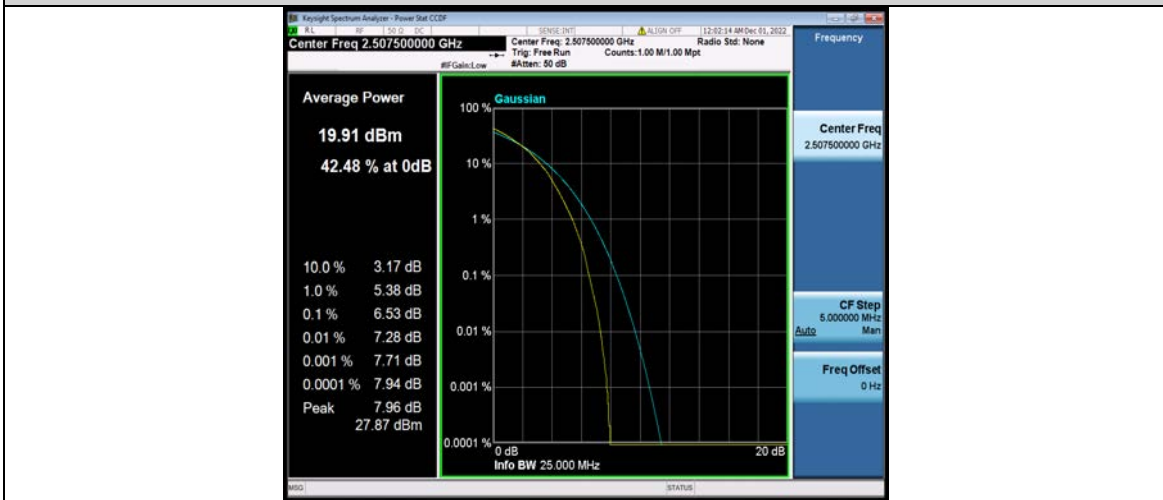

Band7-15MHz-64QAM-21100-1RB#0



Test Report No.: W7L-P23100014RF06



Band7-15MHz-64QAM-21100-75RB#0

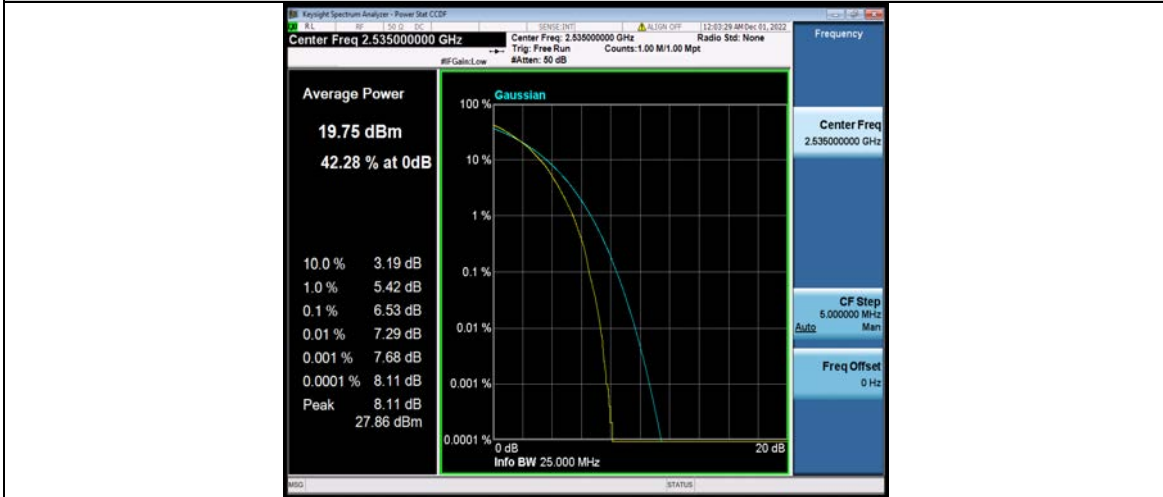

Band7-15MHz-64QAM-21375-1RB#0

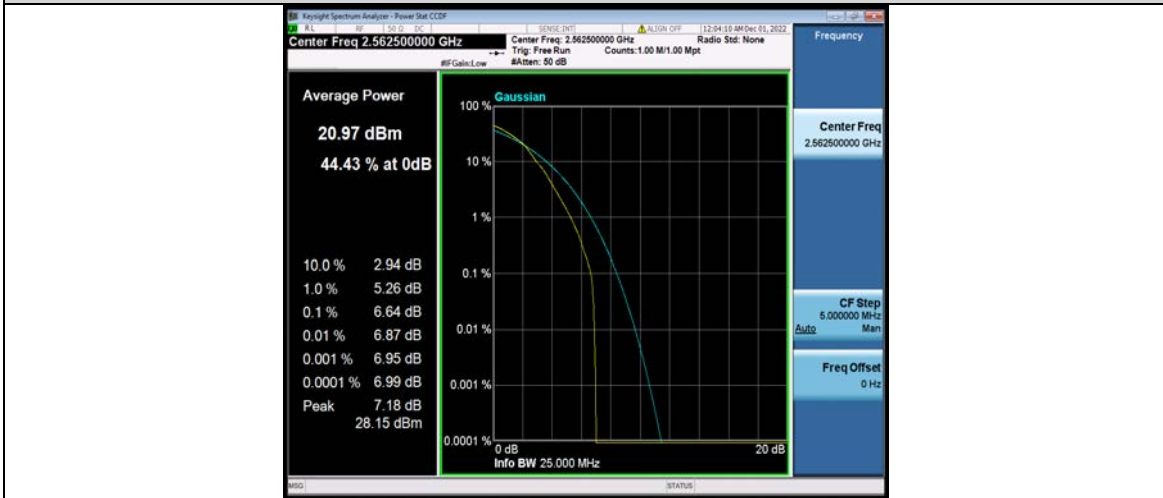

Band7-15MHz-64QAM-21375-75RB#0



Test Report No.: W7L-P23100014RF06

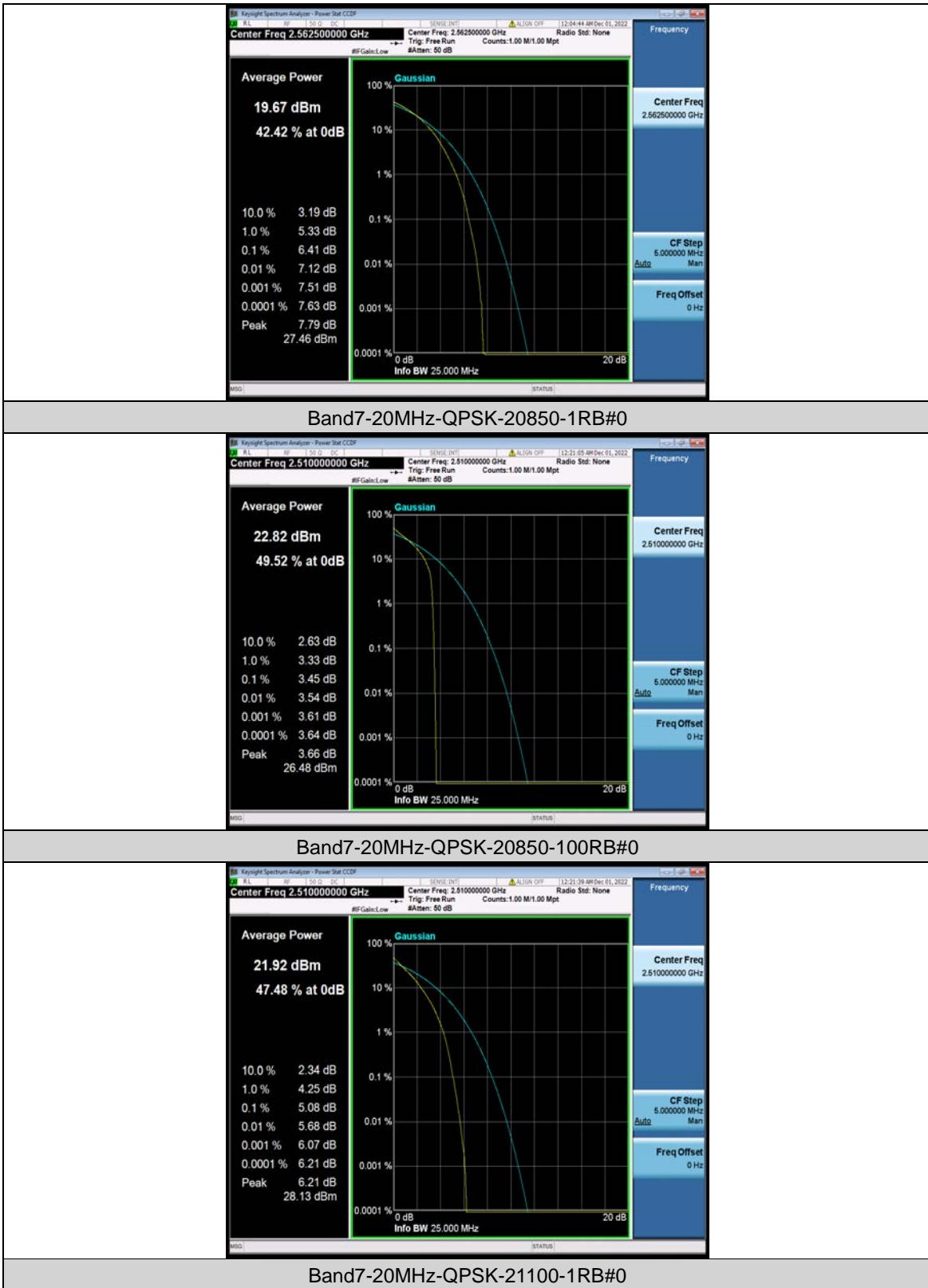



Test Report No.: W7L-P23100014RF06



Band7-20MHz-QPSK-21100-100RB#0

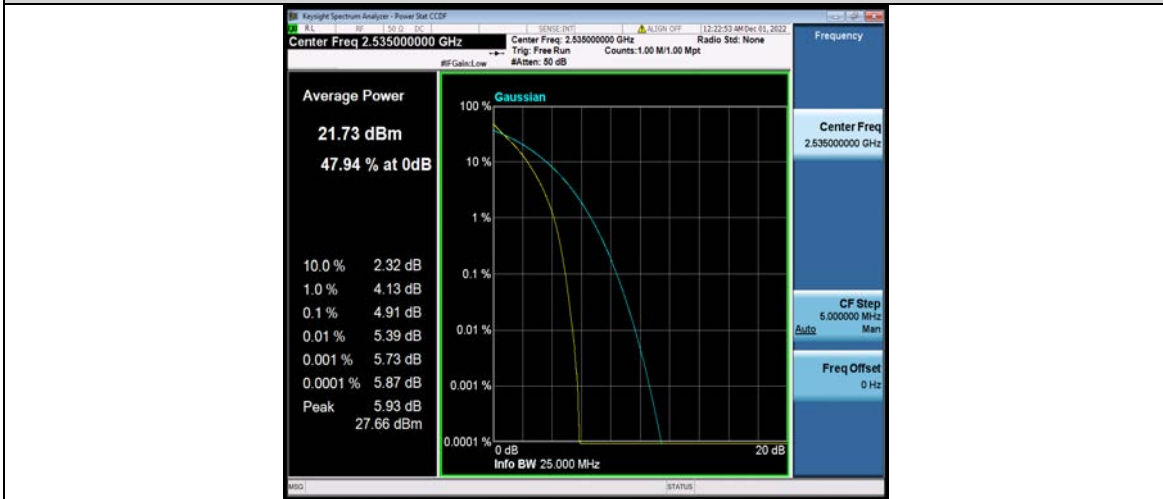

Band7-20MHz-QPSK-21350-1RB#0



Band7-20MHz-QPSK-21350-100RB#0



Test Report No.: W7L-P23100014RF06

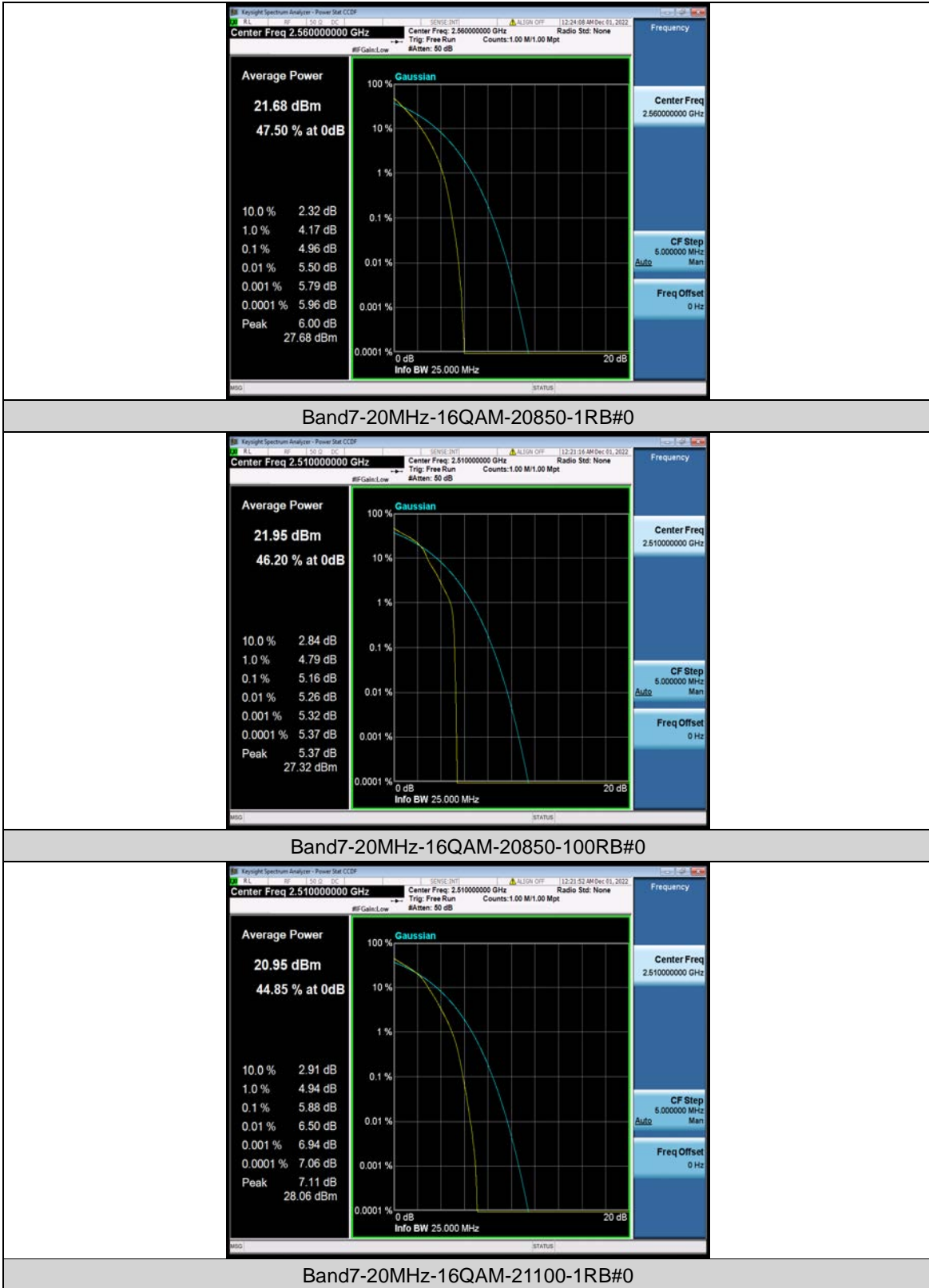



Test Report No.: W7L-P23100014RF06



Band7-20MHz-16QAM-21100-100RB#0

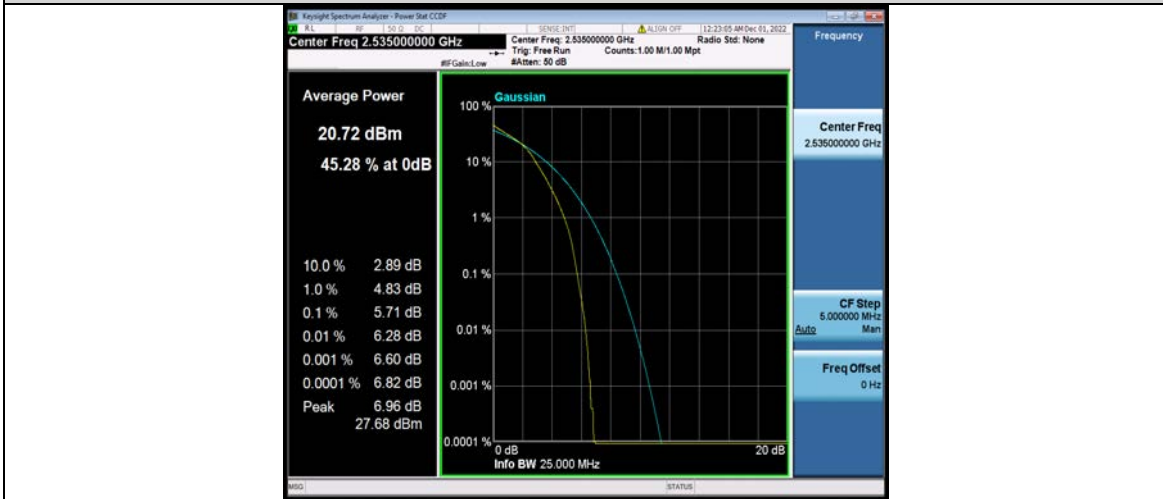

Band7-20MHz-16QAM-21350-1RB#0



Band7-20MHz-16QAM-21350-100RB#0



Test Report No.: W7L-P23100014RF06



Band7-20MHz-64QAM-20850-1RB#0

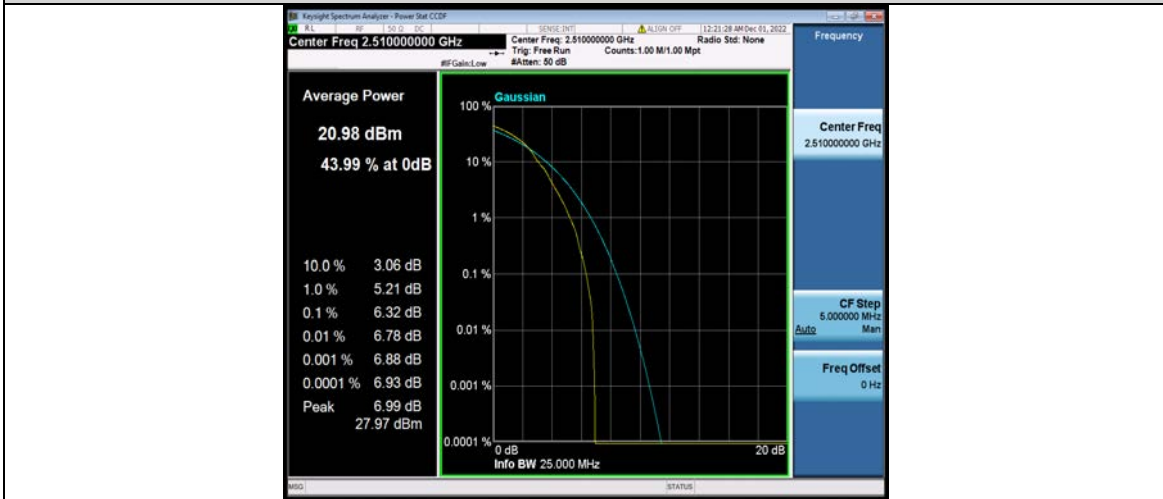

Band7-20MHz-64QAM-20850-100RB#0



Band7-20MHz-64QAM-21100-1RB#0



Test Report No.: W7L-P23100014RF06



Band7-20MHz-64QAM-21100-100RB#0

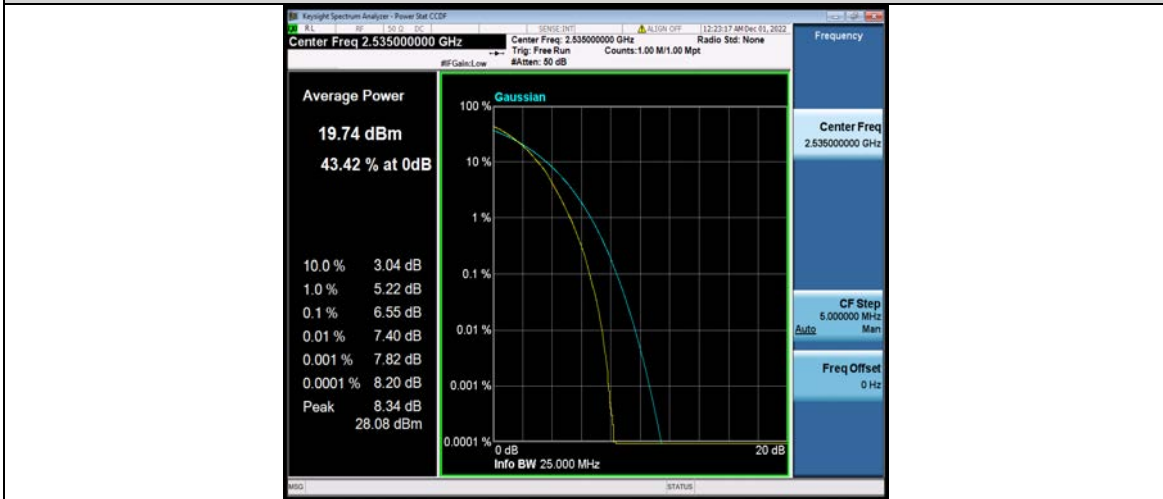

Band7-20MHz-64QAM-21350-1RB#0



Band7-20MHz-64QAM-21350-100RB#0



Test Report No.: W7L-P23100014RF06





Test Report No.: W7L-P23100014RF06

26DB BANDWIDTH AND OCCUPIED BANDWIDTH

Test Result

Band	Bandwidth	Modulation	Channel	RB Configuration	Occupied Bandwidth (MHz)	26dB Bandwidth (MHz)	Verdict
Band7	5MHz	QPSK	20775	25RB#0	4.4941	4.835	PASS
Band7	5MHz	QPSK	21100	25RB#0	4.4990	4.861	PASS
Band7	5MHz	QPSK	21425	25RB#0	4.4970	4.842	PASS
Band7	5MHz	16QAM	20775	25RB#0	4.5011	4.828	PASS
Band7	5MHz	16QAM	21100	25RB#0	4.5021	4.829	PASS
Band7	5MHz	16QAM	21425	25RB#0	4.5020	4.804	PASS
Band7	5MHz	64QAM	20775	25RB#0	4.4939	4.834	PASS
Band7	5MHz	64QAM	21100	25RB#0	4.4999	4.863	PASS
Band7	5MHz	64QAM	21425	25RB#0	4.4936	4.838	PASS
Band7	10MHz	QPSK	20800	50RB#0	8.9886	9.556	PASS
Band7	10MHz	QPSK	21100	50RB#0	8.9715	9.519	PASS
Band7	10MHz	QPSK	21400	50RB#0	8.9714	9.567	PASS
Band7	10MHz	16QAM	20800	50RB#0	8.9720	9.548	PASS
Band7	10MHz	16QAM	21100	50RB#0	8.9809	9.528	PASS
Band7	10MHz	16QAM	21400	50RB#0	8.9714	9.526	PASS
Band7	10MHz	64QAM	20800	50RB#0	8.9671	9.525	PASS
Band7	10MHz	64QAM	21100	50RB#0	8.9830	9.543	PASS
Band7	10MHz	64QAM	21400	50RB#0	8.9738	9.541	PASS
Band7	15MHz	QPSK	20825	75RB#0	13.464	14.31	PASS
Band7	15MHz	QPSK	21100	75RB#0	13.463	14.32	PASS
Band7	15MHz	QPSK	21375	75RB#0	13.436	14.27	PASS
Band7	15MHz	16QAM	20825	75RB#0	13.460	14.28	PASS
Band7	15MHz	16QAM	21100	75RB#0	13.467	14.28	PASS
Band7	15MHz	16QAM	21375	75RB#0	13.444	14.27	PASS
Band7	15MHz	64QAM	20825	75RB#0	13.457	14.27	PASS
Band7	15MHz	64QAM	21100	75RB#0	13.464	14.27	PASS
Band7	15MHz	64QAM	21375	75RB#0	13.448	14.27	PASS
Band7	20MHz	QPSK	20850	100RB#0	17.954	18.97	PASS
Band7	20MHz	QPSK	21100	100RB#0	17.934	19.02	PASS
Band7	20MHz	QPSK	21350	100RB#0	17.920	18.95	PASS
Band7	20MHz	16QAM	20850	100RB#0	17.940	18.96	PASS
Band7	20MHz	16QAM	21100	100RB#0	17.947	18.99	PASS
Band7	20MHz	16QAM	21350	100RB#0	17.921	18.96	PASS
Band7	20MHz	64QAM	20850	100RB#0	17.947	18.98	PASS
Band7	20MHz	64QAM	21100	100RB#0	17.941	18.93	PASS
Band7	20MHz	64QAM	21350	100RB#0	17.912	18.93	PASS



Test Graphs

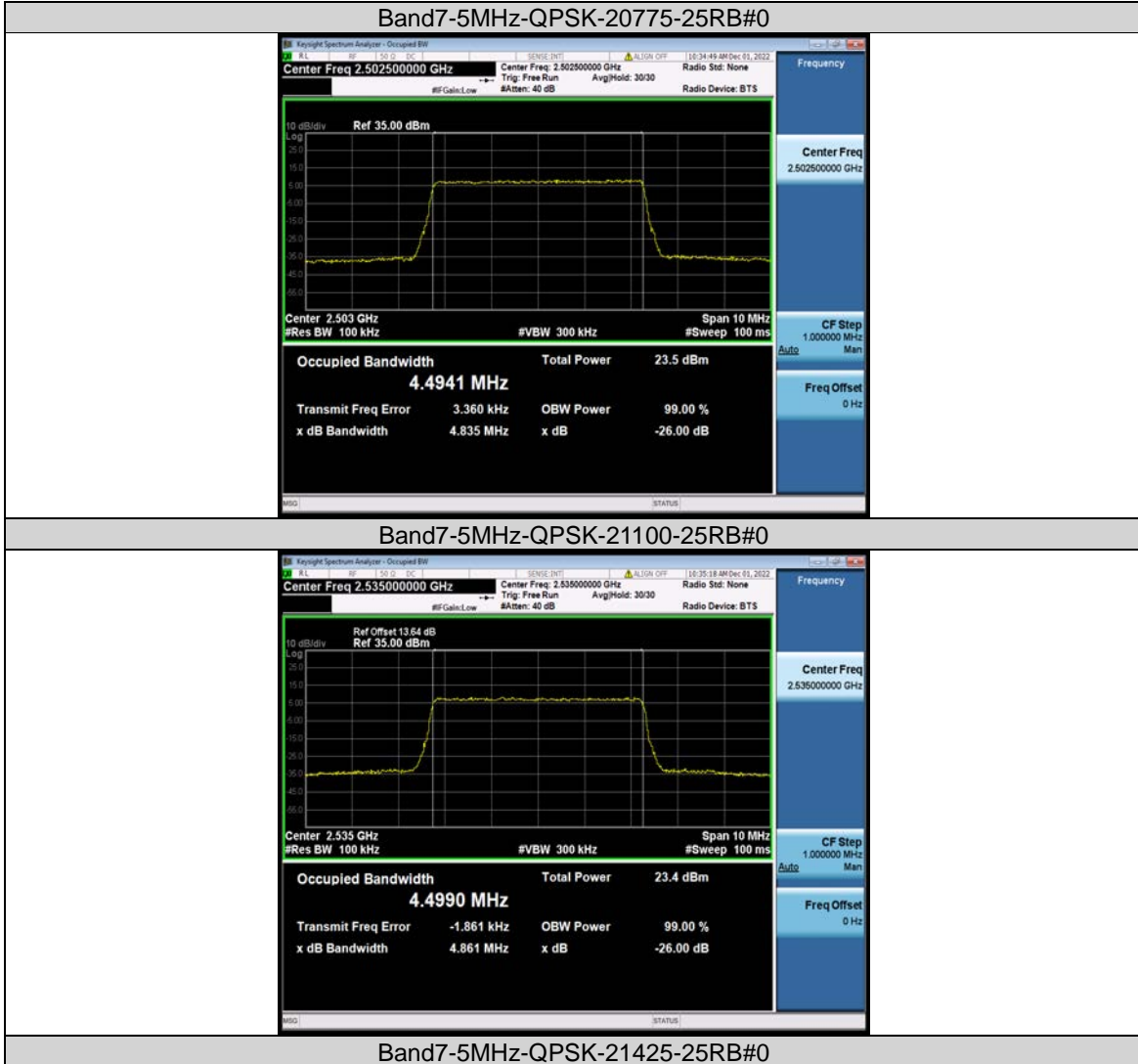



Test Report No.: W7L-P23100014RF06

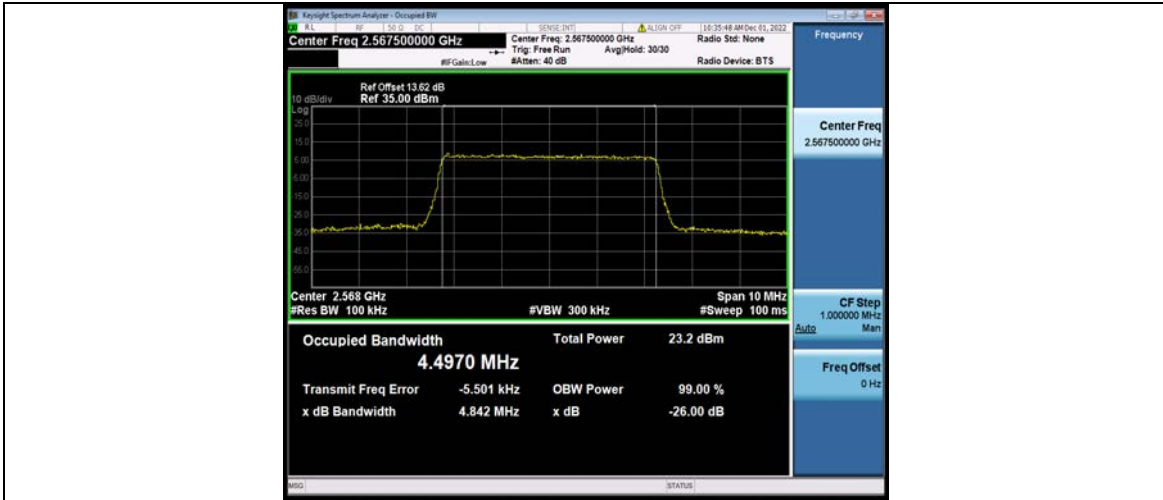

Band7-5MHz-16QAM-20775-25RB#0

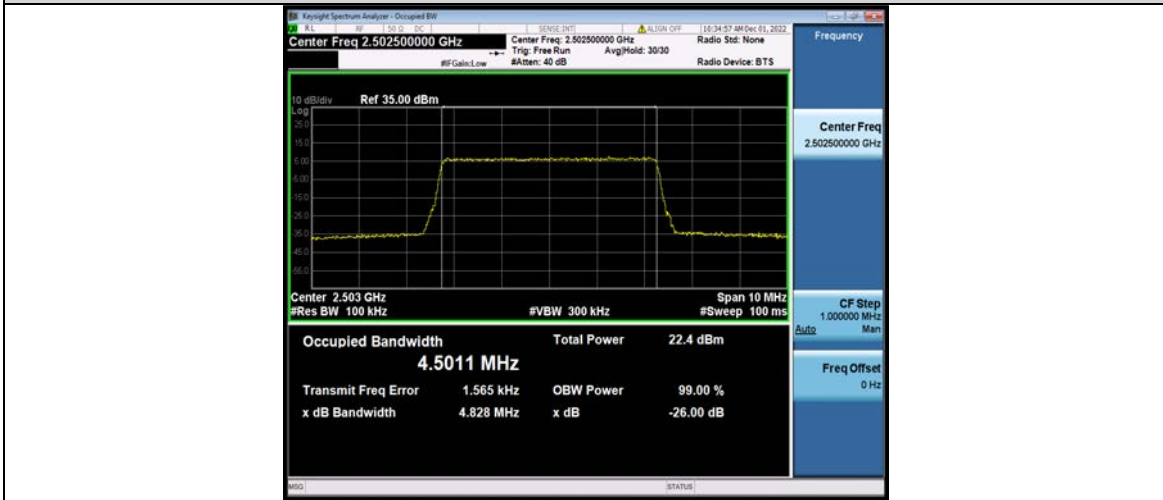

Band7-5MHz-16QAM-21100-25RB#0

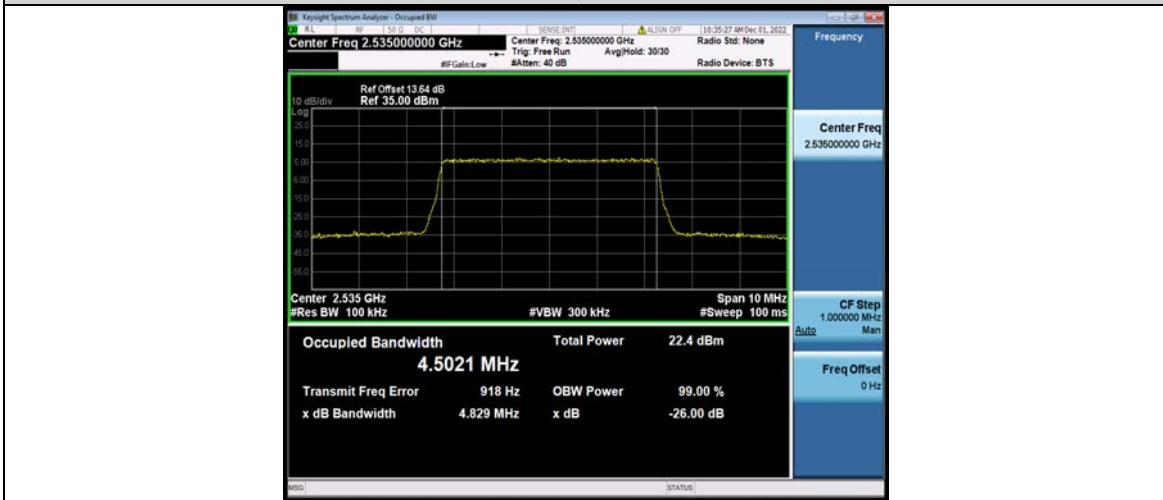

Band7-5MHz-16QAM-21425-25RB#0



Test Report No.: W7L-P23100014RF06

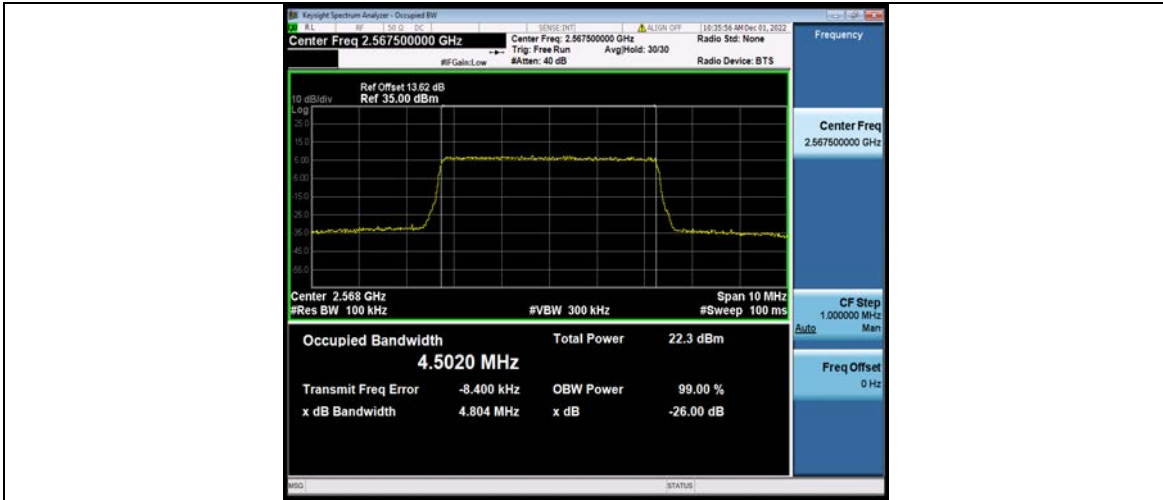

Band7-5MHz-64QAM-20775-25RB#0

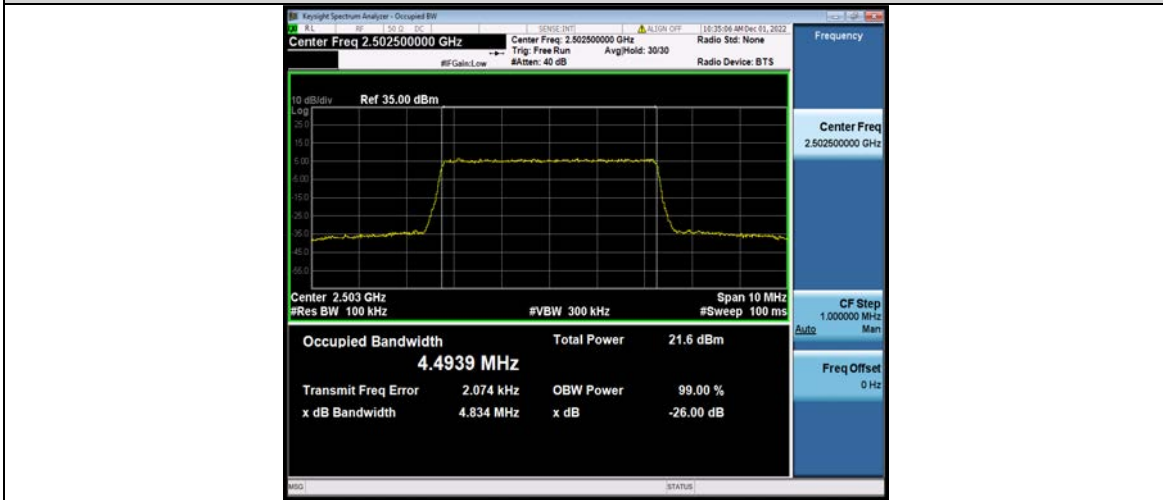

Band7-5MHz-64QAM-21100-25RB#0



Band7-5MHz-64QAM-21425-25RB#0



Test Report No.: W7L-P23100014RF06

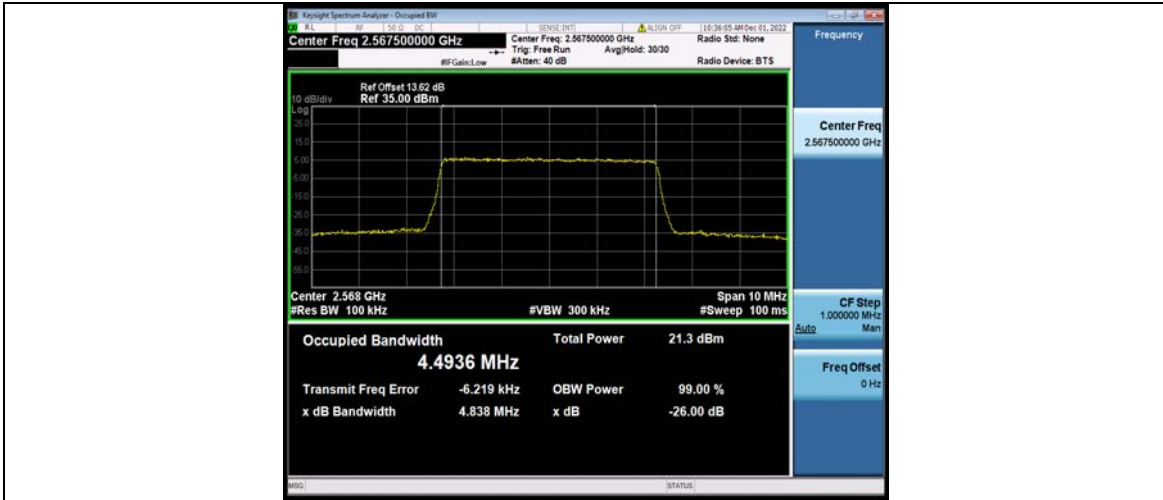

Band7-10MHz-QPSK-20800-50RB#0



Band7-10MHz-QPSK-21100-50RB#0

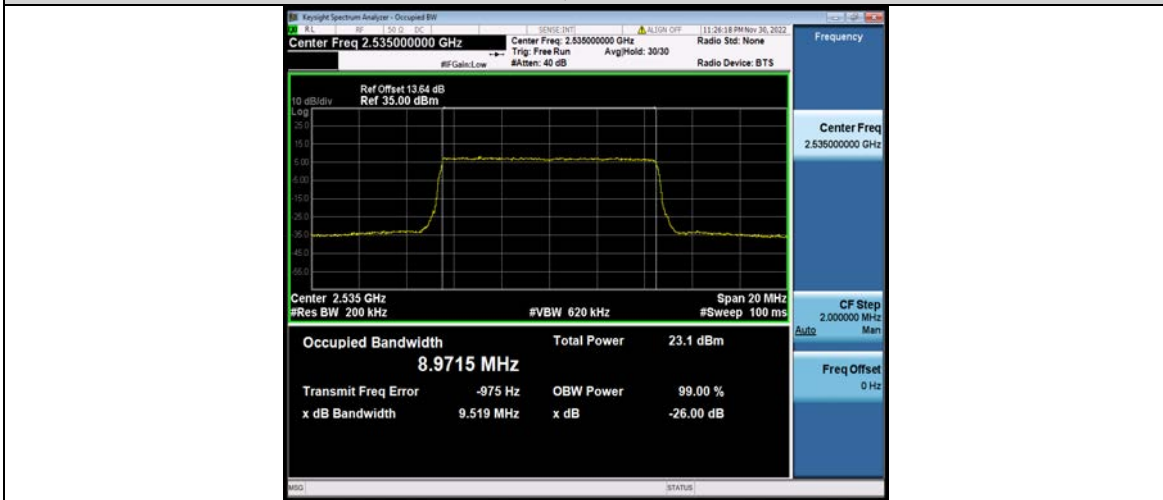

Band7-10MHz-QPSK-21400-50RB#0