



Test Report No.: W7L-P23100014RF11



VARIANT FCC TEST REPORT (PART 96)

Applicant:	Nokia of America Corp
Address:	3201, Olympus Blvd, Dallas, TX 75019, USA

Manufacturer or Supplier:	Nokia of America Corp
Address:	3201, Olympus Blvd, Dallas, TX 75019, USA
Product:	Nokia Industrial 5G handheld HHRA501x
Brand Name:	Nokia
Model Name:	HHRA501a
Marketing Name:	Nokia Industrial 5G handheld HHRA501a
FCC ID:	2AVO2-HHRA501A
Date of tests:	Nov. 24, 2022 ~ Feb. 06, 2023

The tests have been carried out according to the requirements of the following standard:

47 CFR FCC Part 96

CONCLUSION: The submitted sample was found to COMPLY with the test requirement

Prepared by Simon Wang Engineer / Mobile Department	Approved by Luke Lu Manager / Mobile Department
Date: Oct. 23, 2023	Date: Oct. 23, 2023

This report is governed by, and incorporates by reference, the Conditions of Testing as posted at the date of issuance of this report at <http://www.bureauveritas.com/home/about-us/our-business/cps/about-us/terms-conditions/> and is intended for your exclusive use. Any copying or replication of this report to or for any other person or entity, or use of our name or trademark, is permitted only with our prior written permission. This report sets forth our findings solely with respect to the test samples identified herein. The results set forth in this report are not indicative or representative of the quality or characteristics of the lot from which a test sample was taken or any similar or identical product unless specifically and expressly noted. Our report includes all of the tests requested by you and the results thereof based upon the information that you provided to us. Measurement uncertainty is only provided upon request for accredited tests. Statements of conformity are based on simple acceptance criteria without taking measurement uncertainty into account, unless otherwise requested in writing. You have 60 days from date of issuance of this report to notify us of any material error or omission caused by our negligence or if you require measurement uncertainty; provided, however, that such notice shall be in writing and shall specifically address the issue you wish to raise. A failure to raise such issue within the prescribed time shall constitute your unqualified acceptance of the completeness of this report, the tests conducted and the correctness of the report contents.

BV 7Layers Communications Technology
(Shenzhen) Co., Ltd

No.B102, Dazu Chuangxin Mansion, North of Beihuan
Avenue, North Area, Hi-Tech Industrial Park, Nanshan
District, Shenzhen, Guangdong, China

Tel: +86 755 8869 6566
Fax: +86 755 8869 6577
Email: customerservice.sw@bureauveritas.com

TABLE OF CONTENTS

RELEASE CONTROL RECORD	4
1 SUMMARY OF TEST RESULTS.....	5
1.1 MEASUREMENT UNCERTAINTY	5
1.2 TEST SITE AND INSTRUMENTS.....	6
2 GENERAL INFORMATION	7
2.1 GENERAL DESCRIPTION OF EUT	7
2.2 CONFIGURATION OF SYSTEM UNDER TEST	9
2.3 DESCRIPTION OF SUPPORT UNITS	10
2.4 TEST ITEM AND TEST CONFIGURATION	10
2.5 GENERAL DESCRIPTION OF APPLIED STANDARDS.....	13
3 TEST TYPES AND RESULTS	14
3.1 MAXIMUM EIRP MEASUREMENT	14
3.1.1 LIMITS OF MAXIMUM EIRP MEASUREMENT.....	14
3.1.2 TEST SETUP	14
3.1.3 TEST PROCEDURES.....	15
3.1.4 DEVIATION FROM TEST STANDARD.....	15
3.1.5 TEST RESULTS.....	16
3.2 CONDUCTED BAND EDGE	20
3.2.1 LIMITS OF CONDUCTED BAND EDGE MEASUREMENT	20
3.2.2 TEST SETUP	20
3.2.3 TEST INSTRUMENTS	20
3.2.4 TEST PROCEDURE	21
3.2.5 DEVIATION FROM TEST STANDARD.....	21
3.2.6 TEST RESULTS.....	22
3.3 FREQUENCY STABILITY MEASUREMENT	23
3.3.1 LIMITS OF FREQUENCY STABILITY MEASUREMENT	23
3.3.2 TEST PROCEDURE	23
3.3.3 TEST SETUP	23
3.3.4 TEST RESULTS.....	24
3.4 OCCUPIED BANDWIDTH MEASUREMENT	26
3.4.1 OCCUPIED BANDWIDTH MEASUREMENT	26
3.4.2 TEST SETUP	26
3.4.3 TEST INSTRUMENTS.....	26
3.4.4 TEST PROCEDURE	26
3.4.5 DEVIATION FROM TEST STANDARD.....	26
3.4.6 TEST RESULT	27
3.5 CONDUCTED SPURIOUS EMISSIONS	28
3.5.1 LIMITS OF CONDUCTED SPURIOUS EMISSIONS MEASUREMENT	28
3.5.2 TEST SETUP	28
3.5.3 TEST PROCEDURE	28
3.5.4 TEST RESULTS.....	29
3.6 RADIATED EMISSION MEASUREMENT.....	30
3.6.1 LIMITS OF RADIATED EMISSION MEASUREMENT	30
3.6.2 TEST PROCEDURES.....	30
3.6.3 DEVIATION FROM TEST STANDARD.....	30
3.6.4 TEST SET UP	31
3.6.5 TEST RESULTS.....	33



3.7	PEAK TO AVERAGE RATIO	45
3.7.1	LIMITS OF PEAK TO AVERAGE RATIO MEASUREMENT	45
3.7.2	TEST SETUP.....	45
3.7.3	TEST PROCEDURES	45
3.7.4	TEST RESULTS	46
4	INFORMATION ON THE TESTING LABORATORIES.....	47
5	MODIFICATIONS RECORDERS FOR ENGINEERING CHANGES TO THE EUT BY THE LAB	48
6	APPENDIX.....	49
	NR BAND N48	49



BUREAU
VERITAS

Test Report No.: W7L-P23100014RF11

RELEASE CONTROL RECORD

ISSUE NO.	DESCRIPTION	DATE ISSUED
W7L-P22110036RF11	Original release	Feb. 06, 2023
W7L-P23100014RF11	Based on the original product changing the model name and FCC ID, brand name, marketing name, product name, battery model, applicant and manufacturer information.	Oct. 23, 2023

1 SUMMARY OF TEST RESULTS

47 CFR FCC PART 96		
FCC CLAUSE	TEST ITEM	RESULT
2.1046 96.41(b)	Maximum Peak Output Power and Maximum EIRP	Compliance
2.1046 96.41(e)	Conducted Band Edge	Compliance
2.1049	Occupied Bandwidth	Compliance
2.1055	Frequency Stability	Compliance
2.1051 96.41(e)	Conducted Spurious Emissions	Compliance
2.1053 96.41(e)	Radiated Spurious Emissions	Compliance
96.41(g)	Peak-to-Average Power Ratio	Compliance

Note:

Determining compliance based on the results of the compliance measurement, not taking into account measurement instrumentation uncertainty.

1.1 MEASUREMENT UNCERTAINTY

Where relevant, the following measurement uncertainty levels have been estimated for tests performed on the EUT as specified in CISPR 16-4-2:

MEASUREMENT	UNCERTAINTY
Effective Radiated Power	±1.48dB
Frequency Stability	±39.27Hz
Radiated emissions (9KHz~30MHz)	±2.68dB
Radiated emissions	±4.98dB
Conducted emissions	±4.01 dB
Occupied Channel Bandwidth	±21.7KHz
Band Edge Measurements	±1.48dB
Peak to average ratio	±0.76dB

This uncertainty represents an expanded uncertainty expressed at approximately the 95% confidence level using a coverage factor of k=2.

1.2 TEST SITE AND INSTRUMENTS

Equipment	Manufacturer	Model No.	Serial No.	Last Cal.	Next Cal.
MXE EMI Receiver	KEYSIGHT	N9038A-544	MY54450026	Feb. 21,22	Feb. 20,23
EXA Signal Analyzer	KEYSIGHT	N9010A-544	MY54510355	May.15,22	May.14,23
Loop Antenna	Schwarzbeck	FMZB 1519B	00173	Sep.04,22	Sep.03,23
Bilog Antenna	ETS-LINDGRE N	3143B	00161965	Mar. 06,22	Mar. 05,23
Horn Antenna	ETS-LINDGRE N	3117	00168692	Mar. 06,22	Mar. 05,23
Horn Antenna (18GHz-40GHz)	N/A	QWH-SL-18-40-K- SG/QMS-00361	15433	Aug. 24, 22	Aug. 23, 23
Radio Communication Analyzer	ANRITSU	MT8820C	6201465426	Feb. 15,22	Feb. 14,23
Signal Pre-Amplifier	EMSI	EMC 9135	980249	May.12,22	May.11,23
Signal Pre-Amplifier	EMSI	EMC 012645B	980257	May.12,22	May.11,23
Signal Pre-Amplifier	EMSI	EMC 184045B	980259	Feb. 21,22	Feb.20,23
3m Semi-anechoic Chamber	ETS-LINDGRE N	9m*6m*6m	Euroshieldpn- CT0001143-121 6	May. 19,20	May. 18,23
Test Software	E3	V 9.160323	N/A	N/A	N/A
Test Software	JS1120	3.1.36	N/A	N/A	N/A
10dB Attenuator	JFW/USA	50HF-010-SMA	1505	May. 07,22	May. 06,23
Power Meter	Anritsu	ML2495A	1506002	Feb. 22,22	Feb. 21,23
Power Sensor	Anritsu	MA2411B	1339352	May. 07,22	May. 06,23
Temperature Chamber	ESPEC	SH-242	93000855	May. 12,22	May. 11,23
MXG Analog Microvave Signal Generator	KEYSIGHT	N5183A	MY50143024	Feb. 18,22	Feb. 17,23
Base station R&S CMW500	Rohde&Schwa rz	CMW500	153085	May.12,22	May.11,23
DC Source	Kikusui/JP	PMX18-5A	0000001	Aug. 24,22	Aug. 23,23

- NOTE:**
1. The calibration interval of the above test instruments is 12 months or 36 months and the calibrations are traceable to CEPREI/CHINA, GRGT/CHINA and NIM/CHINA.
 2. The test was performed in 3m Semi-anechoic Chamber and RF Oven Room.
 3. The horn antenna is used only for the measurement of emission frequency above 1GHz if tested.
 4. The FCC Site Registration No. is 525120; The Designation No. is CN1171.



2 GENERAL INFORMATION

2.1 GENERAL DESCRIPTION OF EUT

PRODUCT	Nokia Industrial 5G handheld HHRA501x	
BRAND NAME	Nokia	
MODEL NAME	HHRA501a	
MARKETING NAME	Nokia Industrial 5G handheld HHRA501a	
NOMINAL VOLTAGE	5.0Vdc(adapter or host equipment) 3.7Vdc (Li-ion, battery)	
MODULATION TECHNOLOGY	5G NR	DFT-s-OFMA(Pi/2 BPSK,QPSK,16QAM,64QAM,256QAM); CP-OFMA(QPSK,16QAM,64QAM,256QAM);
SUPPORT ENDC COMBINE	NR Band n48	2A_n48
		5A_n48
		13A_n48
		66A_n48
FREQUENCY RANGE	NR Band n48	3555 MHz ~ 3694.98MHz
EMISSION DESIGNATOR	NR Band n48 Channel Bandwidth: 10MHz	Pi/2BPSK: 9M00G7D QPSK: 9M00G7D 16QAM: 9M00W7D 64QAM: 8M95W7D 256QAM: 8M98W7D
	NR Band n48 Channel Bandwidth: 20MHz	Pi/2BPSK: 17M9G7D QPSK: 17M9G7D 16QAM: 17M9W7D 64QAM: 17M9W7D 256QAM: 17M9W7D
	NR Band n48 Channel Bandwidth: 40MHz	Pi/2BPSK: 35M6G7D QPSK: 35M6G7D 16QAM: 35M7W7D 64QAM: 35M7W7D 256QAM: 35M6W7D
MAX. EIRP POWER	NR Band n48 Channel Bandwidth: 10MHz	171.79mW
	NR Band n48 Channel Bandwidth: 20MHz z	170.61mW



	NR Band n48 Channel Bandwidth: 40MHz	178.38mW
ANTENNA GAIN	PIFA Antenna with -1.3dBi gain for NR Band n48	
HW VERSION	V02	
SW VERSION	IS540_ROW_00.00_1_20221017	
I/O PORTS	Refer to user's manual	
DATA CABLE	USB cable1: non-shielded cable, with w/o ferrite core, 1.0 meter USB cable2: non-shielded cable, with w/o ferrite core, 1.0 meter	
EXTREME TEMPERATURE	-10-50 °C	
EXTREME VOLTAGE	3.6V - 4.2V	

NOTE:

- For a more detailed features description, please refer to the manufacturer's specifications or the user's manual.
- The EUT incorporates a SISO function. Physically, the EUT provides one completed transmitter and four receiver.

MODULATION MODE	TX FUNCTION
NR	1TX/4RX

- For the test results, the EUT had been tested with all conditions. But only the worst case was shown in test report.

List of Accessory:

ACCESSORIES	BRAND	MANUFACTURER	MODEL	SPECIFICATION
Battery	N/A	FPR Connectivity Technology Inc.	BL440ACP	Capacity: 3.7Vdc, 4400mAh
AC Adapter	N/A	SHENZHEN SHI YINGYUAN POWER SUPPLY TECHNOLOGY CO., LTD.	ICP12-050-2000B	I/P: 100-240Vac, 0.3A, O/P: 5.0Vdc, 2A
USB Cable 1	N/A	Winpower Technology Co., LTD	PROTECTOR 2.0	Signal Line,1.0meter
USB Cable 2	N/A	Winpower Technology Co., LTD	USB2.0	Signal Line,1.0meter



2.2 CONFIGURATION OF SYSTEM UNDER TEST FOR RADIATION EMISSION TEST

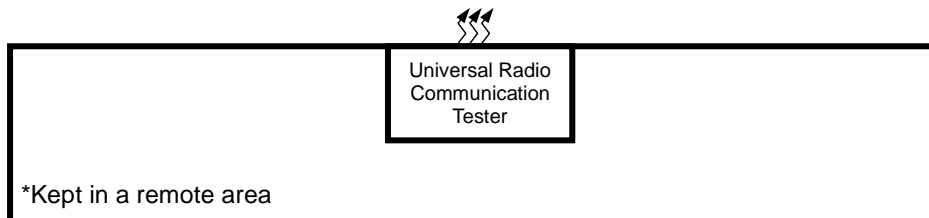
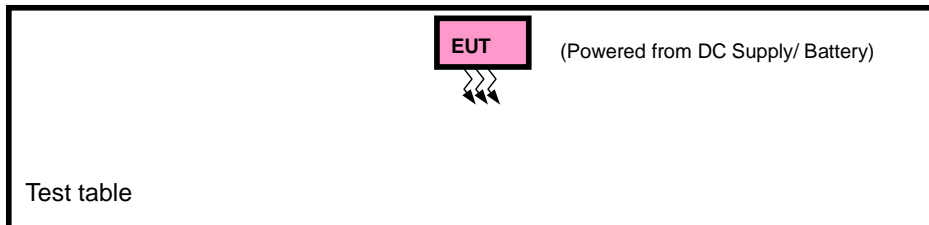
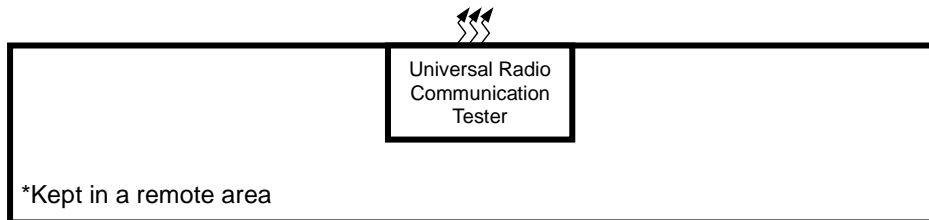
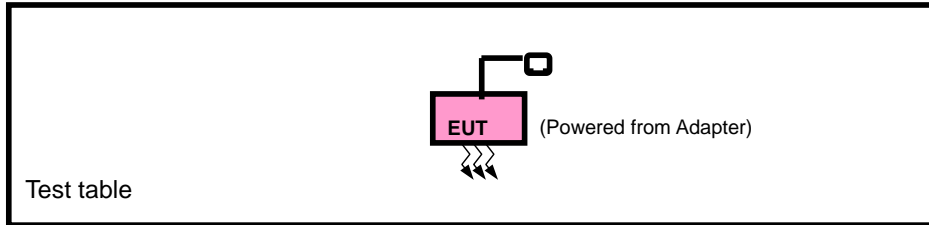

2.3 DESCRIPTION OF SUPPORT UNITS

The EUT has been tested as an independent unit together with other necessary accessories or support units. The following support units or accessories were used to form a representative test configuration during the tests.

NO.	PRODUCT	BRAND	MODEL NO.	SERIAL NO.	FCC ID
1	DC source	LONG WEI	PS-6403D	010934269	N/A

NO.	SIGNAL CABLE DESCRIPTION OF THE ABOVE SUPPORT UNITS
1	DC Line: Unshielded, Detachable 1.8m

2.4 TEST ITEM AND TEST CONFIGURATION

Pre-Scan has been conducted to determine the worst-case mode from all possible combinations between available modulations, data rates, XYZ axis and antenna ports. The worst case was found when positioned on Y-plane for EIRP and X-axis for radiated emission. Following channel(s) was (were) selected for the final test as listed below:

EUT CONFIGURE MODE	DESCRIPTION
A	EUT + Adapter + USB Cable with 5G NR link
B	EUT + DC Supply with 5G NR link

5G NR n48 MODE (SA_n25, DC_2A_n48, DC_5A_n48, DC_13A_n48, DC_66A_n48,)

EUT CONFIGURE MODE	TEST ITEM	AVAILABLE CP-OFDM CHANNEL	AVAILABLE DFT-S-OFDM CHANNEL	TESTED CHANNEL	CHANNEL BANDWIDTH	MODULATION	MODE(DFT-S-OFDM) (INCLUDE CP-OFDM)
A	EIRP	637000 to 646332	637000 to 646332	Low, Middle, High	10MHz	QPSK	1RB/ 0RB Offset
		637334 to 646000	637334 to 646000	Low, Middle, High	20MHz	QPSK,	1RB/ 0RB Offset
		638000 to 645332	638000 to 645332	Low, Middle, High	40MHz	Pi/2BPSK,QPSK, 16QAM, 64QAM, 256QAM	1RB/ 0RB Offset
B	FREQUENCY STABILITY	637334 to 646000	637334 to 646000	Low, Middle, High	20MHz	QPSK	Outer_ Full
A	PEAK TO AVERAGE RATIO	637334 to 646000	637334 to 646000	Low, Middle, High	20MHz	QPSK	Outer_ Full
A	OCCUPIED BANDWIDTH	637000 to 646332	637000 to 646332	Middle	10MHz	Pi/2BPSK,QPSK, 16QAM, 64QAM, 256QAM	Outer_ Full
		637334 to 646000	637334 to 646000	Middle	20MHz	Pi/2BPSK,QPSK, 16QAM, 64QAM, 256QAM	Outer_ Full
		638000 to 645332	638000 to 645332	Middle	40MHz	Pi/2BPSK,QPSK, 16QAM, 64QAM, 256QAM	Outer_ Full



A	BAND EDGE	637000 to 646332	637000 to 646332	Low	10MHz	QPSK	1RB/ 0RB Offset
				Outer_Full			
		637334 to 646000	637334 to 646000	High	10MHz	QPSK	1RB/ max Offset
				Outer_Full			
		638000 to 645332	638000 to 645332	Low	20MHz	QPSK	1RB/ 0RB Offset
				Outer_Full			
		637334 to 646000	637334 to 646000	High	20MHz	QPSK	1RB/ max Offset
				Outer_Full			
638000 to 645332	638000 to 645332	Low	40MHz	QPSK	1RB/ 0RB Offset		
		Outer_Full					
637334 to 646000	637334 to 646000	High	40MHz	QPSK	1RB/ max Offset		
		Outer_Full					
A	CONDUCTED EMISSION	637000 to 646332	637000 to 646332	Low, Middle, High	10MHz	QPSK	1RB/ 0RB Offset
		637334 to 646000	637334 to 646000	Low, Middle, High	20MHz	QPSK	1RB/ 0RB Offset
		638000 to 645332	638000 to 645332	Low, Middle, High	40MHz	QPSK	1RB/ 0RB Offset
A	RADIATED EMISSION	637000 to 646332	637000 to 646332	Low, Middle, High	10MHz	QPSK	1RB/ 0RB Offset
		637334 to 646000	637334 to 646000	Middle	20MHz	QPSK	1RB/ 0RB Offset
		638000 to 645332	638000 to 645332	Middle,	40MHz	QPSK	1RB/ 0RB Offset
A	ACLR	637000 to 646332	637000 to 646332	Low	10MHz	QPSK	1RB/ 0RB Offset
				Outer_Full			
		637334 to 646000	637334 to 646000	High	10MHz	QPSK	1RB/ max Offset
				Outer_Full			
		638000 to 645332	638000 to 645332	Low	20MHz	QPSK	1RB/ 0RB Offset
				Outer_Full			
		637334 to 646000	637334 to 646000	High	20MHz	QPSK	1RB/ max Offset
				Outer_Full			
		638000 to 645332	638000 to 645332	Low	40MHz	QPSK	1RB/ 0RB Offset
				Outer_Full			
		637334 to 646000	637334 to 646000	High	40MHz	QPSK	1RB/ max Offset
				Outer_Full			

Note: 1.This device was tested under all bandwidths, RB configurations and modulations. The worst case was found in QPSK modulation.

2. The test data presented in the report from worst SA_n48



TEST CONDITION:

TEST ITEM	ENVIRONMENTAL CONDITIONS	INPUT POWER	TESTED BY
ERP&EIRP	23deg. C, 70%RH	DC 5V By Adapter	Jace Hu
FREQUENCY STABILITY	23deg. C, 70%RH	DC 3.6V/3.7V/4.2V By DC Supply	James Fu
OCCUPIED BANDWIDTH	23deg. C, 70%RH	DC5V By Adapter	James Fu
BAND EDGE	23deg. C, 70%RH	DC 5V By Adapter	James Fu
CONDCUDED EMISSION	23deg. C, 70%RH	DC5V By Adapter	James Fu
RADIATED EMISSION	23deg. C, 70%RH	DC5V By Adapter	Jace Hu
PEAK TO AVERAGE RATIO	23deg. C, 70%RH	DC5V By Adapter	James Fu



2.5 GENERAL DESCRIPTION OF APPLIED STANDARDS

The EUT is a RF Product. According to the specifications of the manufacturer, it must comply with the requirements of the following standards:

FCC 47 CFR Part 2

FCC 47 CFR Part 96

KDB 971168 D02 Power Meas License Digital Systems v02r02

ANSI/TIA/EIA-603-E 2016

ANSI 63.26-2015

NOTE: All test items have been performed and recorded as per the above standards.

3 TEST TYPES AND RESULTS

3.1 MAXIMUM EIRP MEASUREMENT

3.1.1 LIMITS OF MAXIMUM EIRP MEASUREMENT

Device	Maximum EIRP (dBm/10 MHz)
End User Device	23
Category A CBSD	30
Category B CBSD	47

3.1.2 TEST SETUP

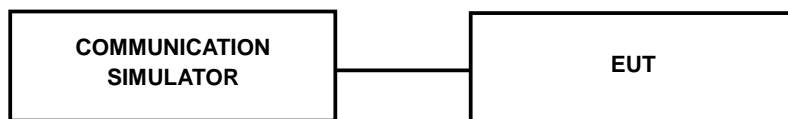

For the actual test configuration, please refer to the attached file (Test Setup Photo).

3.1.3 TEST PROCEDURES

EIRP MEASUREMENT:

Per KDB 971168 D01 Power Meas License Digital Systems v03r01 or subclause 5.2.5.5 of ANSI C63.26-2015, the relevant equation for determining the ERP or EIRP from the conducted RF output power measured using the guidance provided above is:

$$\text{ERP or EIRP} = P_{\text{Meas}} + G_{\text{T}} - L_{\text{C}}$$

Where:

ERP or EIRP = effective radiated power or equivalent isotropically radiated power, respectively

(expressed in the same units as P_{Meas} , typically dBW or dBm);

P_{Meas} = measured transmitter output power or PSD, in dBm or dBW;

G_{T} = gain of the transmitting antenna, in dBd (ERP) or dBi (EIRP);

L_{C} = signal attenuation in the connecting cable between the transmitter and antenna, in dB.

CONDUCTED POWER MEASUREMENT:

- a. The EUT was set up for the maximum power with LTE link data modulation and link up with simulator.
- b. Set the EUT to transmit under low, middle and high channel and record the power level shown on simulator.

3.1.4 DEVIATION FROM TEST STANDARD

No deviation.



3.1.5 TEST RESULTS

5G SA

N48

BW	MCS Index	RB Size	RB Offset	Low CH 637000	Mid CH 641666	High CH 646332
				Frequency 3555MHz	Frequency 3624.99MHz	Frequency 3694.98MHz
10M	CP-OFDM QPSK	1	1	22.13	22.14	22.09

BW	MCS Index	RB Size	RB Offset	Low CH 637334	Mid CH 641666	High CH 646000
				Frequency 3560.01MHz	Frequency 3624.99MHz	Frequency 3690MHz
20M	CP-OFDM QPSK	1	1	22.09	22.09	22.18

BW	MCS Index	RB Size	RB Offset	Low CH 638000	Mid CH 641666	High CH 645332
				Frequency 3570MHz	Frequency 3624.99MHz	Frequency 3679.98MHz
40M	CP-OFDM QPSK	1	1	22.13	22.15	22.17



BW	MCS Index	RB Size	RB Offset	Low CH 637000	Mid CH 641666	High CH 646332
				Frequency 3555MHz	Frequency 3624.99MHz	Frequency 3694.98MHz
10M	DFT-s-OFDM QPSK	1	1	23.63	23.65	23.59

BW	MCS Index	RB Size	RB Offset	Low CH 637334	Mid CH 641666	High CH 646000
				Frequency 3560.01MHz	Frequency 3624.99MHz	Frequency 3690MHz
20M	DFT-s-OFDM QPSK	1	1	23.60	23.62	23.58

BW	MCS Index	RB Size	RB Offset	Low CH 638000	Mid CH 641666	High CH 645332
				Frequency 3570MHz	Frequency 3624.99MHz	Frequency 3679.98MHz
40M	DFT-s-OFDM Pi/2 BPSK	1	1	23.57	23.65	23.67
		1	53	23.41	23.51	23.46
		1	104	23.39	23.57	23.48
		50	0	23.01	23.11	23.10
		50	28	23.35	23.50	23.42
		50	56	22.97	23.10	23.08
		100	0	22.95	23.12	23.04
	DFT-s-OFDM QPSK	1	1	23.63	23.69	23.65
		1	53	23.32	23.45	23.38
		1	104	23.38	23.53	23.44
		50	0	22.46	22.54	22.56
		50	28	23.43	23.53	23.48
		50	56	22.46	22.63	22.55
		100	0	22.41	22.46	22.47
	DFT-s-OFDM 16QAM	1	1	22.29	22.39	22.38
	DFT-s-OFDM 64QAM	1	1	20.48	20.63	20.55
DFT-s-OFDM 256QAM	1	1	18.54	18.67	18.65	



EIRP

N48

CHANNEL BANDWIDTH: 10MHz QPSK

Channel	Frequency (MHz)	Conducted Power (dBm)	G _T -L _C (dB)	EIRP (dBm)	EIRP (mW)	Limit (dBm/10MHz)
637000	3555.00	23.63	-1.3	22.33	171	23
641666	3624.99	23.65	-1.3	22.35	171.79	23
646332	3694.98	23.59	-1.3	22.29	169.43	23

CHANNEL BANDWIDTH: 20MHz QPSK

Channel	Frequency (MHz)	Conducted Power (dBm)	G _T -L _C (dB)	EIRP (dBm)	EIRP (mW)	Limit (dBm/10MHz)
637334	3560.01	23.6	-1.3	22.3	169.82	23
641666	3624.99	23.62	-1.3	22.32	170.61	23
646000	3690.00	23.58	-1.3	22.28	169.04	23

CHANNEL BANDWIDTH: 40MHz Pi/2 BPSK

Channel	Frequency (MHz)	Conducted Power (dBm)	G _T -L _C (dB)	EIRP (dBm)	EIRP (mW)	Limit (dBm/10MHz)
638000	3570.00	23.57	-1.3	22.27	168.66	23
641666	3624.99	23.65	-1.3	22.35	171.79	23
645332	3679.98	23.67	-1.3	22.37	172.58	23

CHANNEL BANDWIDTH: 40MHz QPSK

Channel	Frequency (MHz)	Conducted Power (dBm)	G _T -L _C (dB)	EIRP (dBm)	EIRP (mW)	Limit (dBm/10MHz)
638000	3570.00	23.63	-1.3	22.33	171	23
641666	3624.99	23.69	-1.3	22.39	173.38	23
645332	3679.98	23.65	-1.3	22.35	171.79	23

CHANNEL BANDWIDTH: 40MHz 16QAM

Channel	Frequency (MHz)	Conducted Power (dBm)	G _T -L _C (dB)	EIRP (dBm)	EIRP (mW)	Limit (dBm/10MHz)
638000	3570.00	22.29	-1.3	20.99	125.6	23
641666	3624.99	22.39	-1.3	21.09	128.53	23
645332	3679.98	22.38	-1.3	21.08	128.23	23



CHANNEL BANDWIDTH: 40MHz 64QAM

Channel	Frequency (MHz)	Conducted Power (dBm)	G _T -L _C (dB)	EIRP (dBm)	EIRP (mW)	Limit (dBm/10MHz)
638000	3570.00	20.48	-1.3	19.18	82.79	23
641666	3624.99	20.63	-1.3	19.33	85.7	23
645332	3679.98	20.55	-1.3	19.25	84.14	23

CHANNEL BANDWIDTH: 40MHz 256QAM

Channel	Frequency (MHz)	Conducted Power (dBm)	G _T -L _C (dB)	EIRP (dBm)	EIRP (mW)	Limit (dBm/10MHz)
638000	3570.00	18.54	-1.3	17.24	52.97	23
641666	3624.99	18.67	-1.3	17.37	54.58	23
645332	3679.98	18.65	-1.3	17.35	54.33	23

3.2 CONDUCTED BAND EDGE

3.2.1 LIMITS OF CONDUCTED BAND EDGE MEASUREMENT

The conducted power of any End User Device emission outside the fundamental emission (whether in or outside of the authorized band) shall not exceed -13 dBm/MHz within 0 to B megahertz (where B is the bandwidth in megahertz of the assigned channel or multiple contiguous channels of the End User Device) above the upper CBSD-assigned channel edge and within 0 to B megahertz below the lower CBSD-assigned channel edge. At all frequencies greater than B megahertz above the upper CBSD assigned channel edge and less than B megahertz below the lower CBSD-assigned channel edge, the conducted power of any End User Device emission shall not exceed -25 dBm/MHz. Notwithstanding the emission limits in this paragraph, the Adjacent Channel Leakage Ratio for End User Devices shall be at least 30 dB.

3.2.2 TEST SETUP

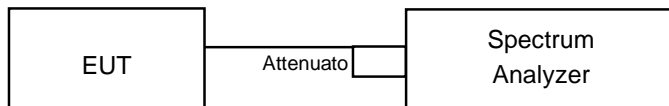

3.2.3 TEST INSTRUMENTS

Refer to section 1.2 to get information of above instrument.

3.2.4 TEST PROCEDURE

For the Conducted Band Edge:

- a. Connect the transmitter to the spectrum analyzer via coaxial cable while ensuring proper impedance matching.
- b. Tune the analyzer to the nominal center frequency of the emission bandwidth (EBW).
- c. Set the resolution bandwidth (RBW) $\geq 1\%$ EBW in the 1MHz band immediately outside and adjacent to the band edge.
- d. Beyond the 1MHz band from the band edge, RBW=1MHz was used.
- e. Set the video bandwidth (VBW) to $\geq 3 \times$ RBW.
- f. Select the average power (RMS) display detector.
- g. Set the number of measurement points to ≥ 1001 .
- h. Use auto-coupled sweep time.
- i. Perform the measurement over an interval of time when the transmission is continuous and at its maximum power level.
- j. The RF fundamental frequency should be excluded against the limit line in the operating frequency band and use RBW is 10KHz or 100KHz.
- k. Record the max trace plot into the test report.

For Adjacent Channel Leakage Ratio (ACLR) measurement:

1. The Adjacent Channel Leakage Ratio (ACLR) is the ratio of the average power in the assigned aggregated channel bandwidth to the average power over the equivalent adjacent channel bandwidth.
2. The option ACLR of spectrum analyzer is used and measures the ACLR ratio by setting equivalent channel bandwidth.
3. The measured ACLR ratio shall be at least 30 dB.

3.2.5 DEVIATION FROM TEST STANDARD

No deviation.



Test Report No.: W7L-P23100014RF11

3.2.6 TEST RESULTS

Please Refer to Appendix Of this test report.



3.3 FREQUENCY STABILITY MEASUREMENT

3.3.1 LIMITS OF FREQUENCY STABILITY MEASUREMENT

The frequency stability shall be sufficient to ensure that the fundamental emission stays within the authorized frequency band.

3.3.2 TEST PROCEDURE

- a. Device is placed at the oven room. The oven room could control the temperatures and humidity. Power warm up is at least 15 min and power applied should perform before recording frequency error.
- b. EUT is connected the external power supply to control the DC input power. The test voltage range is from minimum to maximum working voltage. Each step shall be record the frequency error rate.
- c. The temperature range step is 10 degrees in this test items. All temperature levels shall be hold the $\pm 0.5^{\circ}\text{C}$ during the measurement testing. The each temperature step shall be at least 0.5 hours, consider the EUT could be test under the stability condition.

NOTE: The frequency error was recorded frequency error from the communication simulator.

3.3.3 TEST SETUP

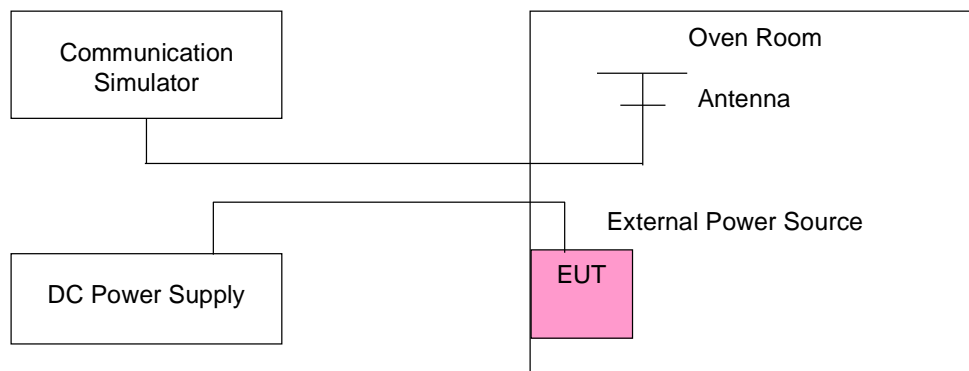

3.3.4 TEST RESULTS

Please Refer to Appendix Of this test report.

LTE BAND CA_48C

LTE BAND CA_48C channel and Frequency List					
BW(MHz)	Channel/Frequency(MHz)		Lowest	Middle	Highest
5+20	PCC	channel	55273	55898	56523
		Frequency	3553.3	3615.8	3678.3
	SCC	channel	55390	56015	56640
		Frequency	3565	3627.5	3690
10+20	PCC	channel	55295	55896	56496
		Frequency	3555.5	3615.6	3675.6
	SCC	channel	55439	56040	56640
		Frequency	3569.9	3630	3690
15+20	PCC	channel	55318	55893	56496
		Frequency	3557.8	3615.3	3672.9
	SCC	channel	55489	55064	56640
		Frequency	3574.9	3632.4	3690
20+5	PCC	channel	55340	55965	56590
		Frequency	3560	3622.5	3685
	SCC	channel	55457	56082	56707
		Frequency	3571.7	3634.2	3696.7
20+10	PCC	channel	55340	55941	56541
		Frequency	3560	3620.1	3680.1
	SCC	channel	55484	56085	56685
		Frequency	3574.4	3634.5	3694.5
20+15	PCC	channel	55340	55916	56491
		Frequency	3560	3617.6	3675.1
	SCC	channel	55511	56087	56662
		Frequency	3577.1	3634.7	3692.2
20+20	PCC	channel	55340	55891	56442
		Frequency	3560	3615.1	3670.2



BUREAU
VERITAS

Test Report No.: W7L-P23100014RF11

	SCC	channel	55538	56089	56640
		Frequency	3579.8	3634.9	3690

Note: VL = Low voltage(3.6V); VN/NV = Normal voltage(3.7V); VH = High voltage(4.2V);
NT = Normal temperature (25°C)



3.4 OCCUPIED BANDWIDTH MEASUREMENT

3.4.1 OCCUPIED BANDWIDTH MEASUREMENT

The width of a frequency band such that, below the lower and above the upper frequency limits, the mean powers emitted are each equal to a specified percentage 0.5 % of the total mean power of a given emission.

3.4.2 TEST SETUP

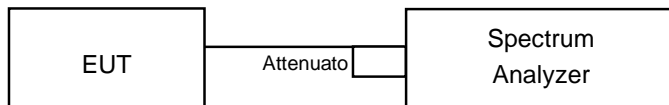

3.4.3 TEST INSTRUMENTS

Refer to section 1.2 to get information of above instrument.

3.4.4 TEST PROCEDURE

- a. The conducted occupied bandwidth used the power splitter via EUT RF power connector between simulation base station and spectrum analyzer.
- b. Use OBW measurement function of Spectrum analyzer to measure 99 % occupied bandwidth.

3.4.5 DEVIATION FROM TEST STANDARD

No deviation.



Test Report No.: W7L-P23100014RF11

3.4.6 TEST RESULT

Please Refer to Appendix Of this test report.

3.5 CONDUCTED SPURIOUS EMISSIONS

3.5.1 LIMITS OF CONDUCTED SPURIOUS EMISSIONS MEASUREMENT

The power of any emissions below 3530 MHz or above 3720 MHz shall not exceed -40dBm/MHz .

3.5.2 TEST SETUP

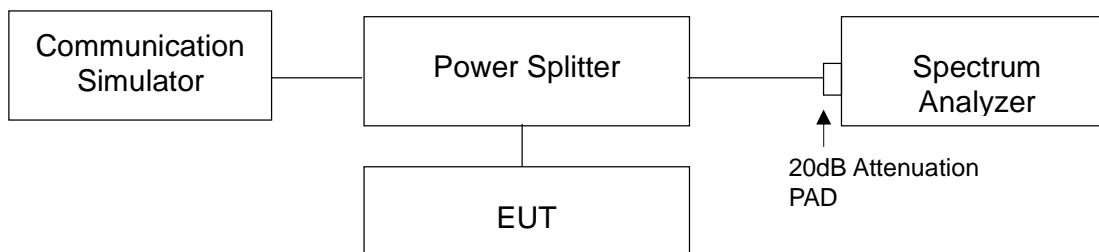

3.5.3 TEST PROCEDURE

- The EUT makes a phone call to the communication simulator. All measurements were done at low, middle and high operational frequency range.
- Measuring frequency range is from 9 kHz to 40 GHz. 20dB attenuation pad is connected with spectrum. RBW=1MHz and VBW=3MHz is used for conducted emission measurement.



Test Report No.: W7L-P23100014RF11

3.5.4 TEST RESULTS

Please Refer to Appendix Of this test report.



3.6 RADIATED EMISSION MEASUREMENT

3.6.1 LIMITS OF RADIATED EMISSION MEASUREMENT

The power of any emissions below 3530 MHz or above 3720 MHz shall not exceed -40dBm/MHz.

3.6.2 TEST PROCEDURES

- a. Substitution method is used for E.I.R.P measurement. In the semi-anechoic chamber, EUT placed on the 0.8m(below or equal 1GHz) and/or 1.5m(above 1GHz) height of Turn Table, rotated the table around 360 degrees to search the maximum radiation power and receiver antenna shall be rotated vertical and horizontal polarization and moved height from 1m to 4m to find the maximum polar radiated power. The "Read Value" is the spectrum reading the maximum power value.
- b. The substitution antenna is substituted for EUT at the same position and signals generator export the CW signal to the substitution antenna via a tx cable. Rotated the Turn Table and moved receiving antenna to find the maximum radiation power. Adjust output power level of S.G to get a Value of spectrum reading equal to "Read Value " of step a. Record the power level of S.G
- c. EIRP = Output power level of S.G – TX cable loss + Antenna gain of substitution horn.
- d. E.R.P power can be calculated form E.I.R.P power by subtracting the gain of dipole,
E.R.P power = E.I.P.R power - 2.15dBi.

Note: The resolution bandwidth of spectrum analyzer is 1 MHz and the video bandwidth is 3 MHz.

3.6.3 DEVIATION FROM TEST STANDARD

No deviation.

3.6.4 TEST SET UP

< Frequency Range below 30MHz >

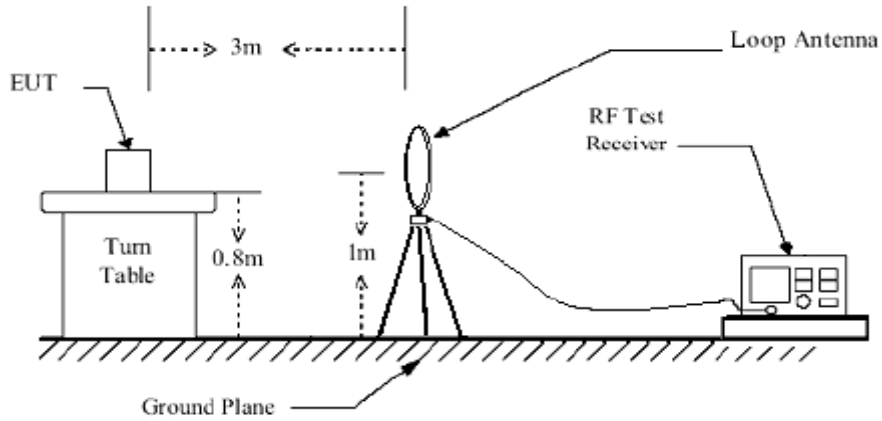

<Frequency Range below 1GHz>

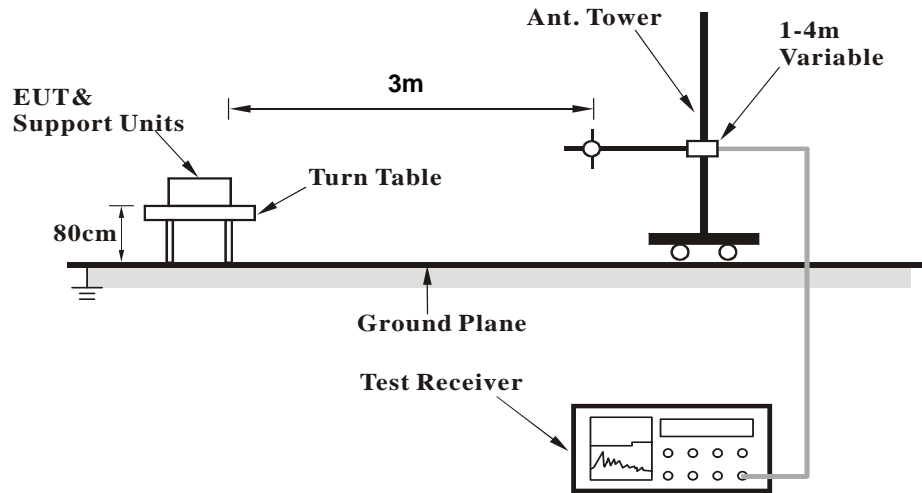



<Frequency Range above 1GHz>

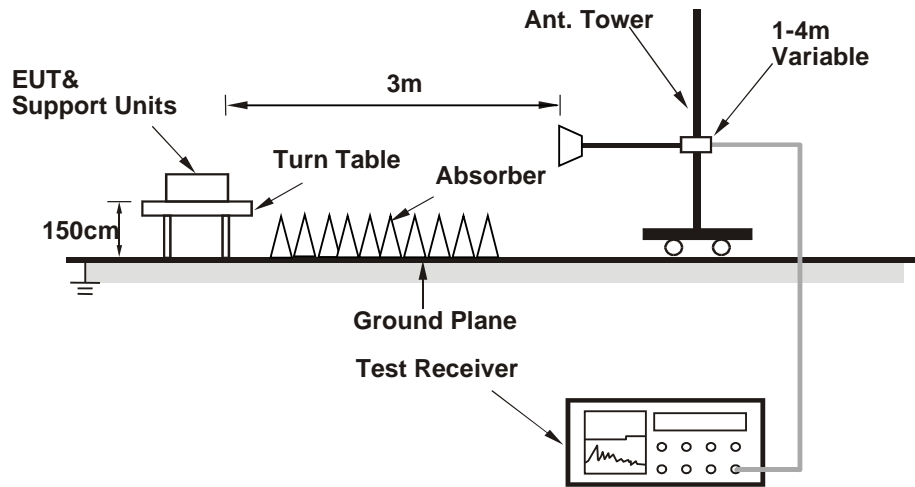

For the actual test configuration, please refer to the attached file (Test Setup Photo).

3.6.5 TEST RESULTS

NOTE : The 9K~30MHz amplitude of spurious emissions attenuated more than 20 dB below the permissible value is not required in the report.

5G SA BELOW 1GHz WORST-CASE DATA

30 MHz – 1GHz data:

N48

CHANNEL BANDWIDTH: 10MHz / QPSK

MODE	TX channel 646332	FREQUENCY RANGE	Below 1000MHz
ENVIRONMENTAL CONDITIONS	23deg. C, 70%RH	INPUT POWER	AC 120V/60HZ
TESTED BY	Jace Hu		
ANTENNA POLARITY & TEST DISTANCE: HORIZONTAL AT 3 M			

	Freq	Level	Read Level	Limit Line	Over Limit	Factor	Remark	Pol/Phase
	MHz	dBm/m	dBm	dBm/m	dB	dB/m		
1	34.850	-65.39	-53.35	-40.00	-25.39	-12.04	Peak	Horizontal
2	72.680	-64.64	-43.39	-40.00	-24.64	-21.25	Peak	Horizontal
3	164.830	-72.53	-56.41	-40.00	-32.53	-16.12	Peak	Horizontal
4 PP	248.250	-63.52	-51.86	-40.00	-23.52	-11.66	Peak	Horizontal
5	349.130	-70.32	-59.05	-40.00	-30.32	-11.27	Peak	Horizontal
6	422.850	-70.30	-60.68	-40.00	-30.30	-9.62	Peak	Horizontal

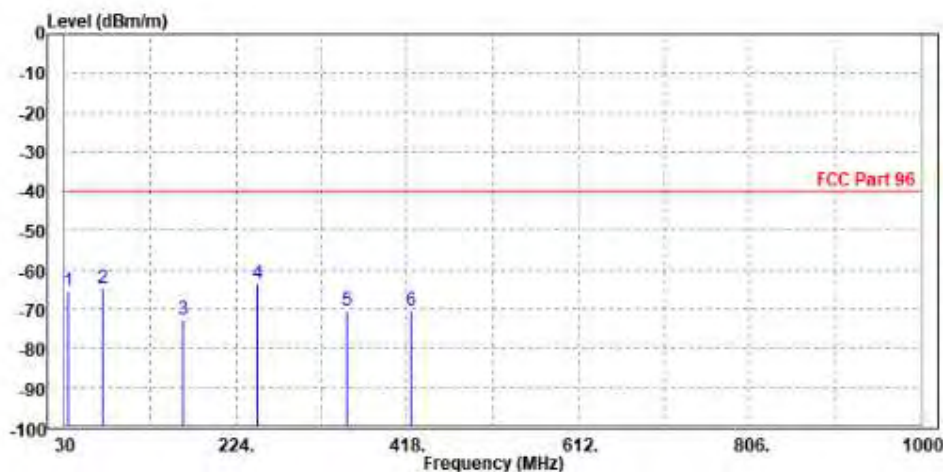



MODE	TX channel 646332	FREQUENCY RANGE	Below 1000MHz
ENVIRONMENTAL CONDITIONS	23deg. C, 70%RH	INPUT POWER	AC 120V/60HZ
TESTED BY	Jace Hu		
ANTENNA POLARITY & TEST DISTANCE: VERTICAL AT 3 M			

	Freq	Level	Read Level	Limit Line	Over Limit	Factor	Remark	Pol/Phase
	MHz	dBm/m	dBm	dBm/m	dB	dB/m		
1	35.820	-63.23	-41.85	-40.00	-23.23	-21.38	Peak	Vertical
2 PP	99.840	-59.31	-52.80	-40.00	-19.31	-6.51	Peak	Vertical
3	142.520	-73.16	-58.91	-40.00	-33.16	-14.25	Peak	Vertical
4	247.280	-69.20	-55.36	-40.00	-29.20	-13.84	Peak	Vertical
5	341.370	-71.28	-61.22	-40.00	-31.28	-10.06	Peak	Vertical
6	454.860	-70.41	-61.92	-40.00	-30.41	-8.49	Peak	Vertical

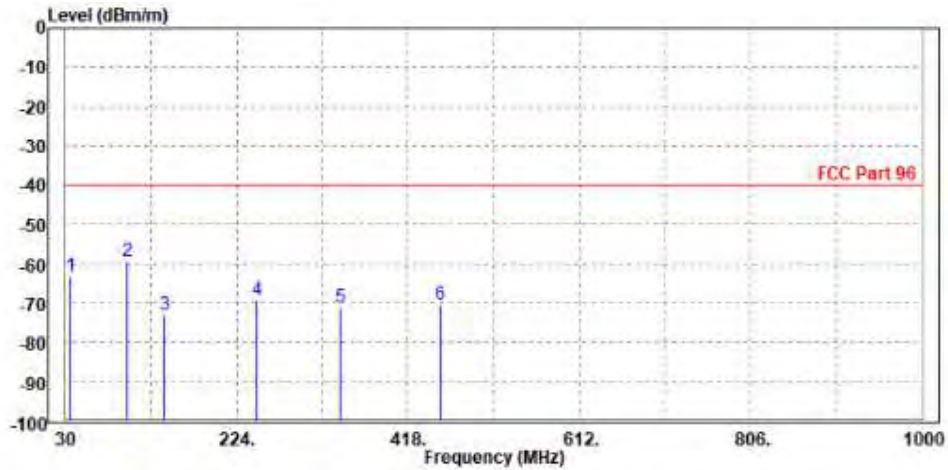



ABOVE 1GHz

Note: For higher frequency, the emission is too low to be detected.

N48

Note: For frequency above 18GHz, the emission was tested 20db below the limit so the data not recorded in the sheet.

CHANNEL BANDWIDTH: 10MHz / QPSK

CH637000

MODE	TX channel 637000	FREQUENCY RANGE	Above 1000MHz
ENVIRONMENTAL CONDITIONS	23deg. C, 70%RH	INPUT POWER	AC 120V/60Hz
TESTED BY	Jace Hu		
ANTENNA POLARITY & TEST DISTANCE: HORIZONTAL AT 3 M			

	Freq	Level	Read Level	Limit Line	Over Limit	Factor	Remark	Pol/Phase
	MHz	dBm/m	dBm	dBm/m	dB	dB/m		
1	7103.000	-51.58	-63.64	-40.00	-11.58	12.06	Peak	Horizontal
2	PP10665.000	-47.36	-66.40	-40.00	-7.36	19.04	Peak	Horizontal

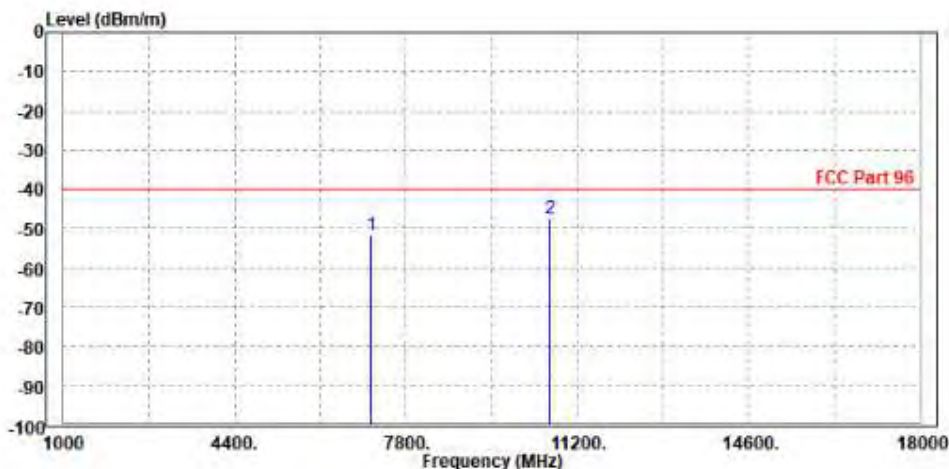



MODE	TX channel 637000	FREQUENCY RANGE	Above 1000MHz
ENVIRONMENTAL CONDITIONS	23deg. C, 70%RH	INPUT POWER	AC 120V/60Hz
TESTED BY	Jace Hu		
ANTENNA POLARITY & TEST DISTANCE: VERTICAL AT 3 M			

	Freq	Level	Read Level	Limit Line	Over Limit	Factor	Remark	Pol/Phase
	MHz	dBm/m	dBm	dBm/m	dB	dB/m		
1	7110.000	-50.48	-63.64	-40.00	-10.48	13.16	Peak	Vertical
2	PP10673.000	-48.77	-67.49	-40.00	-8.77	18.72	Peak	Vertical

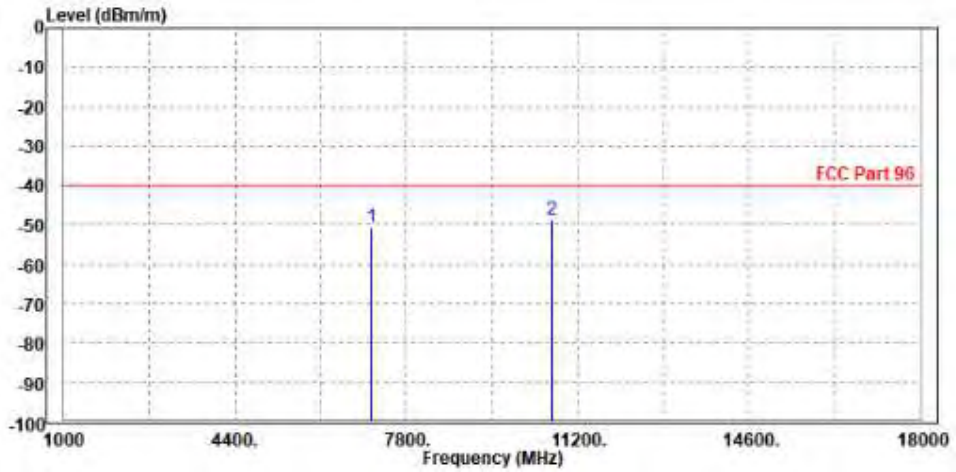



CH641666

MODE	TX channel 641666	FREQUENCY RANGE	Above 1000MHz
ENVIRONMENTAL CONDITIONS	23deg. C, 70%RH	INPUT POWER	AC 120V/60Hz
TESTED BY	Jace Hu		
ANTENNA POLARITY & TEST DISTANCE: HORIZONTAL AT 3 M			

	Freq	Level	Read Level	Limit Line	Over Limit	Factor	Remark	Pol/Phase
	MHz	dBm/m	dBm	dBm/m	dB	dB/m		
1	7249.980	-50.12	-61.94	-40.00	-10.12	11.82	Peak	Horizontal
2	PP10877.000	-44.98	-64.60	-40.00	-4.98	19.62	Peak	Horizontal

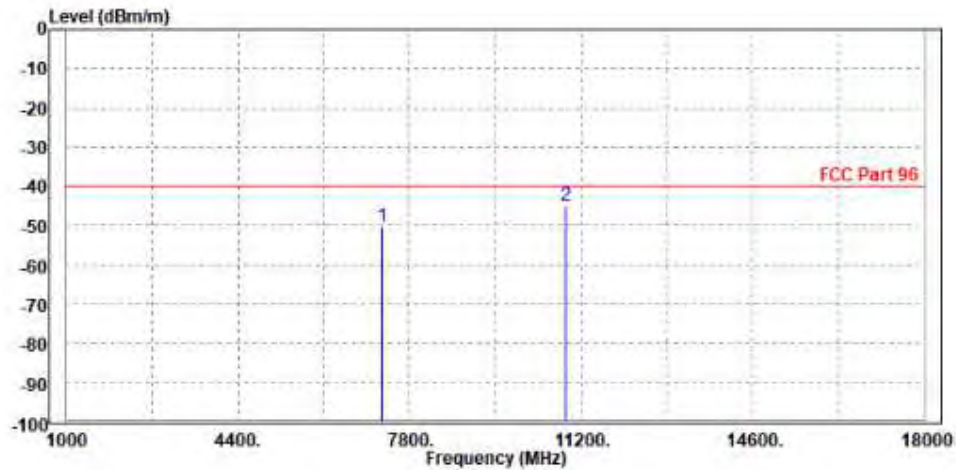



MODE	TX channel 641666	FREQUENCY RANGE	Above 1000MHz
ENVIRONMENTAL CONDITIONS	23deg. C, 70%RH	INPUT POWER	AC 120V/60Hz
TESTED BY	Jace Hu		
ANTENNA POLARITY & TEST DISTANCE: VERTICAL AT 3 M			

	Freq	Level	Read Level	Limit Line	Over Limit	Factor	Remark	Pol/Phase
	MHz	dBm/m	dBm	dBm/m	dB	dB/m		
1	7256.000	-49.49	-63.23	-40.00	-9.49	13.74	Peak	Vertical
2	PP10874.970	-46.15	-65.82	-40.00	-6.15	19.67	Peak	Vertical

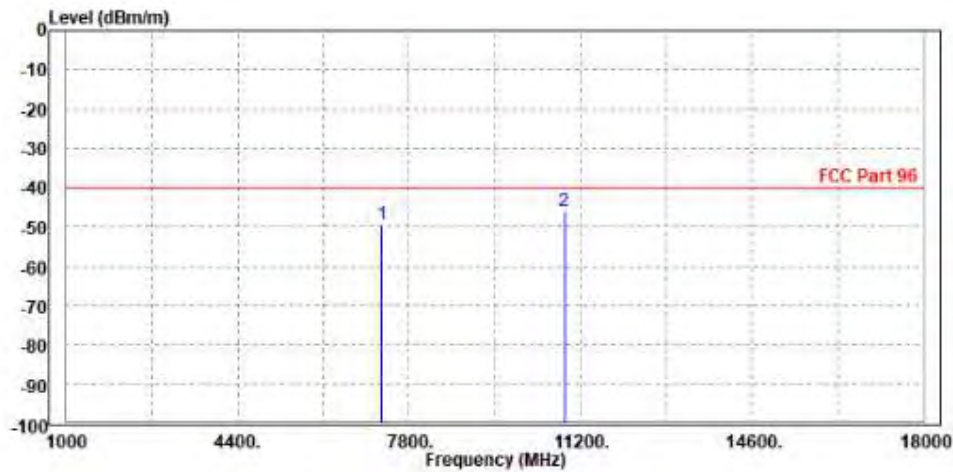



CH646332

MODE	TX channel 646332	FREQUENCY RANGE	Above 1000MHz
ENVIRONMENTAL CONDITIONS	23deg. C, 70%RH	INPUT POWER	AC 120V/60Hz
TESTED BY	Jace Hu		
ANTENNA POLARITY & TEST DISTANCE: HORIZONTAL AT 3 M			

	Freq	Level	Read Level	Limit Line	Over Limit	Factor	Remark	Pol/Phase
	MHz	dBm/m	dBm	dBm/m	dB	dB/m		
1	7389.960	-52.15	-63.75	-40.00	-12.15	11.60	Peak	Horizontal
2	PP11081.000	-44.14	-64.20	-40.00	-4.14	20.06	Peak	Horizontal

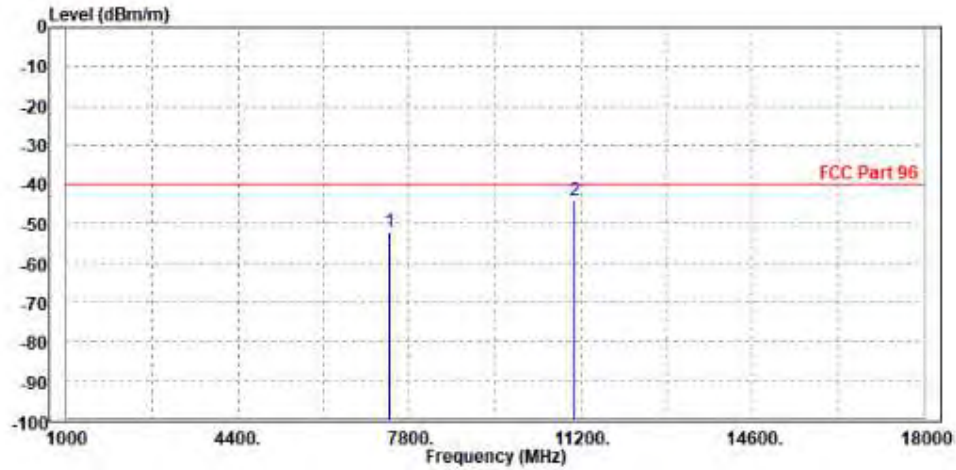



MODE	TX channel 646332	FREQUENCY RANGE	Above 1000MHz
ENVIRONMENTAL CONDITIONS	23deg. C, 70%RH	INPUT POWER	AC 120V/60Hz
TESTED BY	Jace Hu		
ANTENNA POLARITY & TEST DISTANCE: VERTICAL AT 3 M			

	Freq	Level	Read Level	Limit Line	Over Limit	Factor	Remark	Pol/Phase
	MHz	dBm/m	dBm	dBm/m	dB	dB/m		
1	7392.000	-49.49	-63.76	-40.00	-9.49	14.27	Peak	Vertical
2	PP11084.940	-43.97	-63.77	-40.00	-3.97	19.80	Peak	Vertical

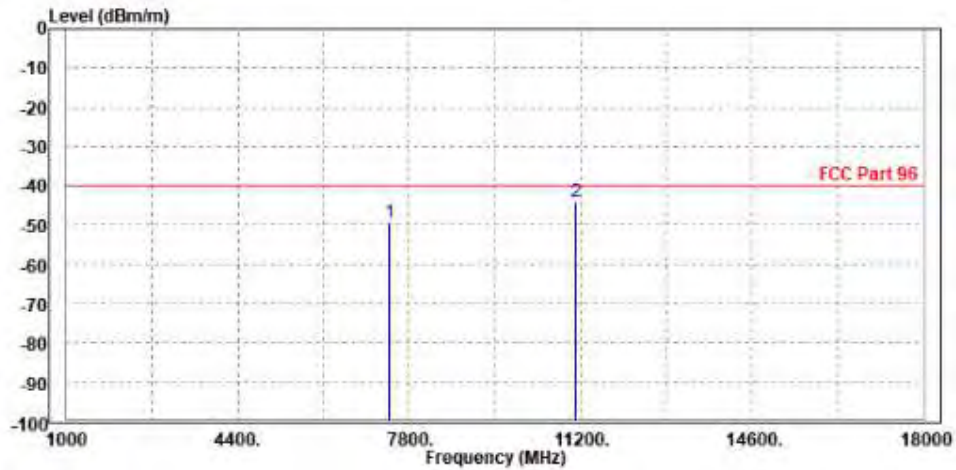



CHANNEL BANDWIDTH: 20MHz / QPSK

MODE	TX channel 641666	FREQUENCY RANGE	Above 1000MHz
ENVIRONMENTAL CONDITIONS	23deg. C, 70%RH	INPUT POWER	AC 120V/60Hz
TESTED BY	Jace Hu		
ANTENNA POLARITY & TEST DISTANCE: HORIZONTAL AT 3 M			

	Freq	Level	Read Level	Limit Line	Over Limit	Factor	Remark	Pol/Phase
	MHz	dBm/m	dBm	dBm/m	dB	dB/m		
1	7256.000	-50.49	-62.30	-40.00	-10.49	11.81	Peak	Horizontal
2	PP10874.970	-45.54	-65.15	-40.00	-5.54	19.61	Peak	Horizontal

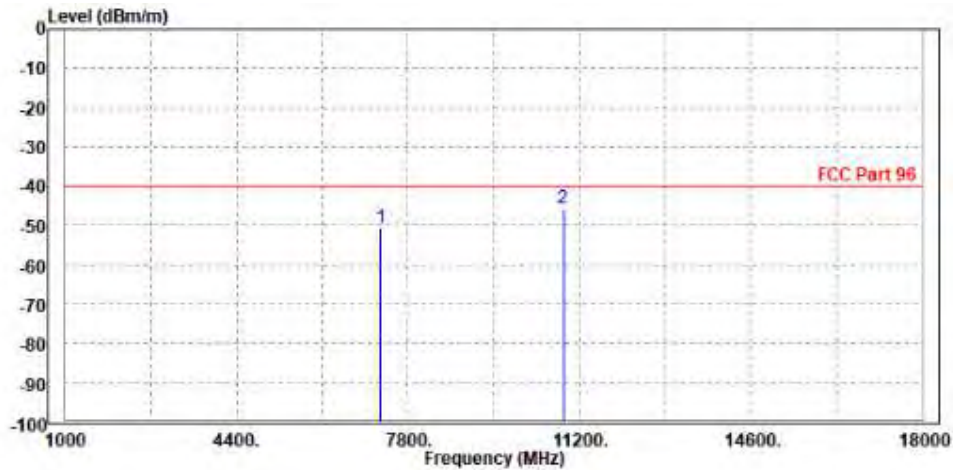



MODE	TX channel 641666	FREQUENCY RANGE	Above 1000MHz
ENVIRONMENTAL CONDITIONS	23deg. C, 70%RH	INPUT POWER	AC 120V/60Hz
TESTED BY	Jace Hu		
ANTENNA POLARITY & TEST DISTANCE: VERTICAL AT 3 M			

	Freq	Level	Read Level	Limit Line	Over Limit	Factor	Remark	Pol/Phase
	MHz	dBm/m	dBm	dBm/m	dB	dB/m		
1	7249.970	-48.74	-62.45	-40.00	-8.74	13.71	Peak	Vertical
2	PP10877.000	-45.98	-65.66	-40.00	-5.98	19.68	Peak	Vertical

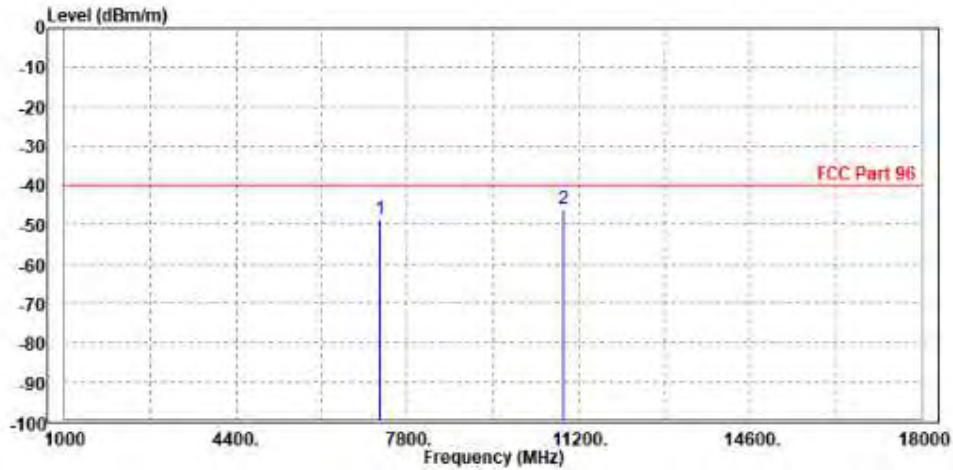



CHANNEL BANDWIDTH: 40MHz / QPSK

MODE	TX channel 641666	FREQUENCY RANGE	Above 1000MHz
ENVIRONMENTAL CONDITIONS	23deg. C, 70%RH	INPUT POWER	AC 120V/60Hz
TESTED BY	Jace Hu		
ANTENNA POLARITY & TEST DISTANCE: HORIZONTAL AT 3 M			

	Freq	Level	Read Level	Limit Line	Over Limit	Factor	Remark	Pol/Phase
	MHz	dBm/m	dBm	dBm/m	dB	dB/m		
1	7249.980	-50.53	-62.35	-40.00	-10.53	11.82	Peak	Horizontal
2	PP10877.000	-45.71	-65.33	-40.00	-5.71	19.62	Peak	Horizontal

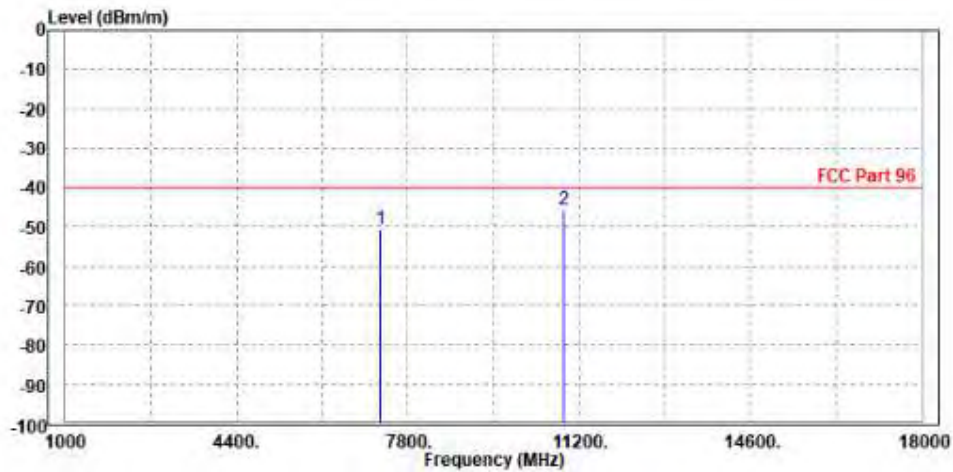



MODE	TX channel 641666	FREQUENCY RANGE	Above 1000MHz
ENVIRONMENTAL CONDITIONS	23deg. C, 70%RH	INPUT POWER	AC 120V/60Hz
TESTED BY	Jace Hu		
ANTENNA POLARITY & TEST DISTANCE: VERTICAL AT 3 M			

	Freq	Level	Read Level	Limit Line	Over Limit	Factor	Remark	Pol/Phase
	MHz	dBm/m	dBm	dBm/m	dB	dB/m		
1	7256.000	-48.53	-62.27	-40.00	-8.53	13.74	Peak	Vertical
2	PP10874.970	-46.05	-65.72	-40.00	-6.05	19.67	Peak	Vertical

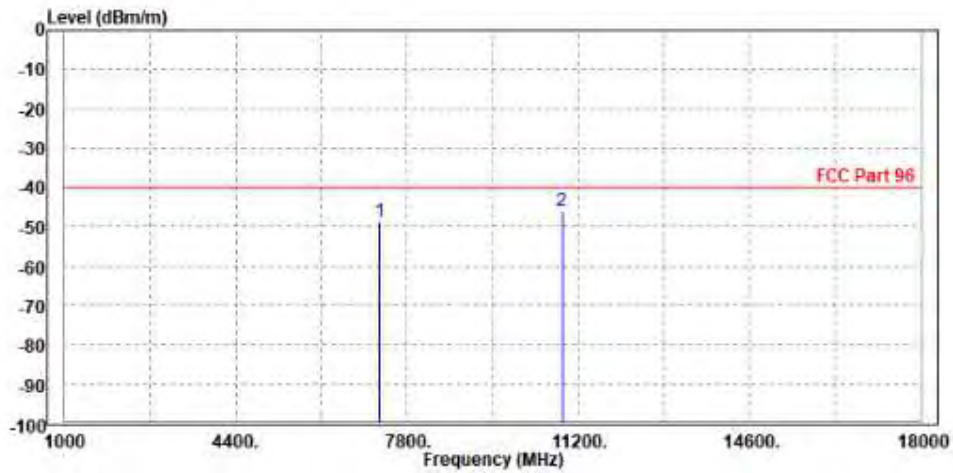

3.7 PEAK TO AVERAGE RATIO

3.7.1 LIMITS OF PEAK TO AVERAGE RATIO MEASUREMENT

In measuring transmissions in this band using an average power technique, the peak to-average ratio (PAR) of the transmission may not exceed 13 dB

3.7.2 TEST SETUP

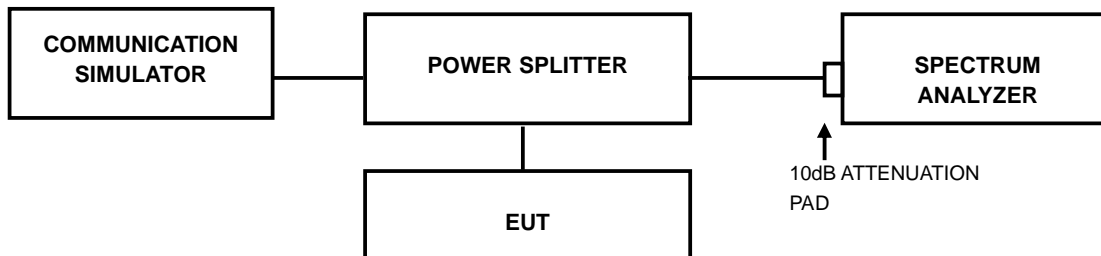

3.7.3 TEST PROCEDURES

1. Set resolution/measurement bandwidth \geq signal's occupied bandwidth;
2. Set the number of counts to a value that stabilizes the measured CCDF curve;
3. Record the maximum PAPR level associated with a probability of 0.1%.



Test Report No.: W7L-P23100014RF11

3.7.4 TEST RESULTS

Please Refer to Appendix Of this test report.



**BUREAU
VERITAS**

Test Report No.: W7L-P23100014RF11

4 INFORMATION ON THE TESTING LABORATORIES

We, BV 7LAYERS COMMUNICATIONS TECHNOLOGY (SHENZHEN) CO. LTD., were founded in 2015 to provide our best service in EMC, Radio, Telecom and Safety consultation. Our laboratories are accredited and approved according to ISO/IEC 17025.

If you have any comments, please feel free to contact us at the following:

Shenzhen EMC/RF Lab:

Tel: +86-755-88696566

Fax: +86-755-88696577

Email: customerservice.sw@cn.bureauveritas.com

Web Site: www.adt.com.tw

The address and road map of all our labs can be found in our web site also.



**BUREAU
VERITAS**

Test Report No.: W7L-P23100014RF11

5 MODIFICATIONS RECORDERS FOR ENGINEERING CHANGES TO THE EUT BY THE LAB

No any modifications are made to the EUT by the lab during the test.



6 Appendix

NR BAND N48 PEAK-TO-AVERAGE RATIO(CCDF) TEST RESULT

Band	Bandwidth	Modulation	Channel	RB Configuration	Result(dB)	Limit(dB)	Verdict
N48	20MHz	QPSK	637334	1RB#0	4.31	13	PASS
N48	20MHz	QPSK	637334	50RB#0	4.70	13	PASS
N48	20MHz	QPSK	641666	1RB#0	3.75	13	PASS
N48	20MHz	QPSK	641666	50RB#0	4.88	13	PASS
N48	20MHz	QPSK	646000	1RB#0	3.97	13	PASS
N48	20MHz	QPSK	646000	50RB#0	4.57	13	PASS



TEST GRAPHS

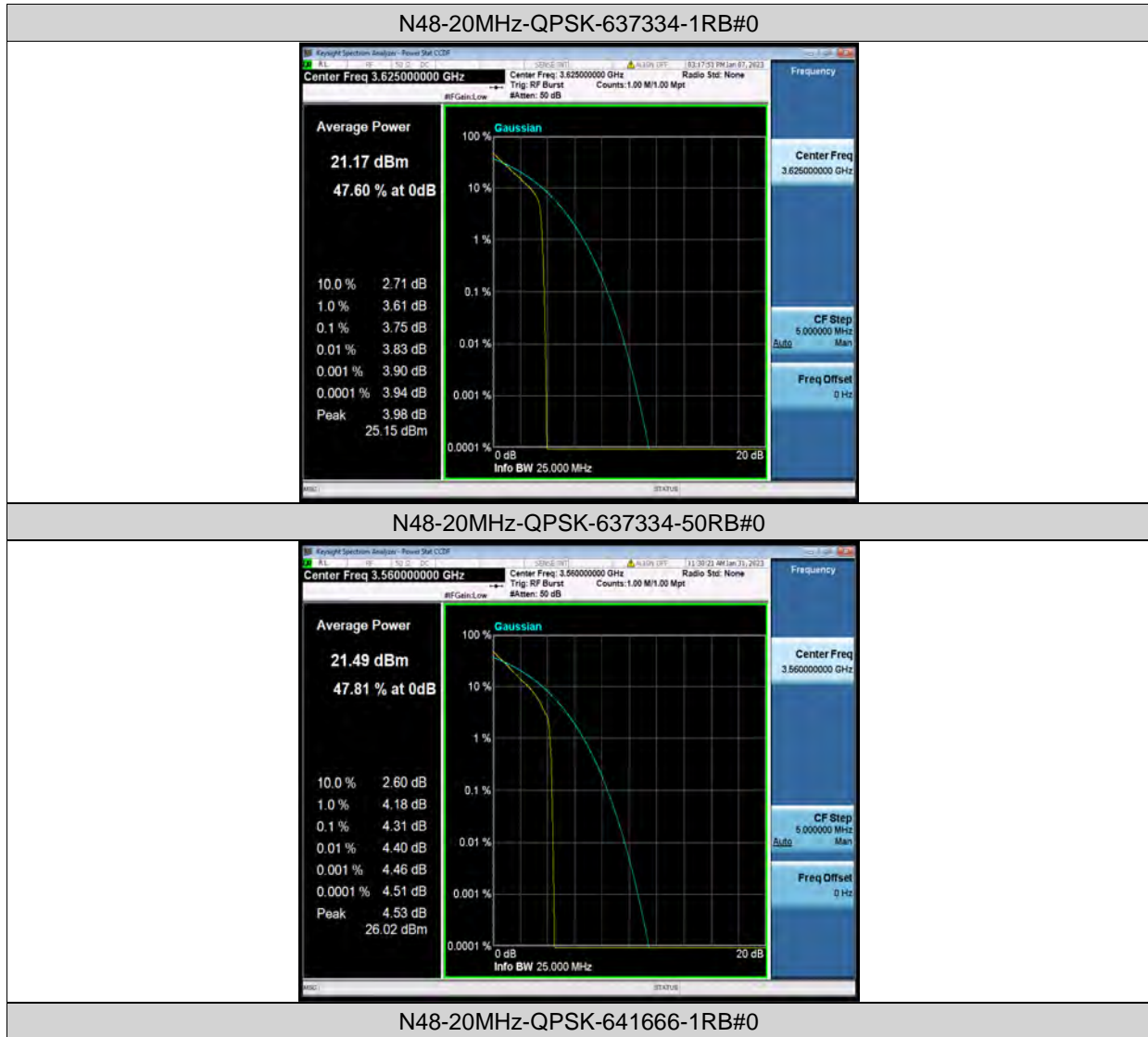

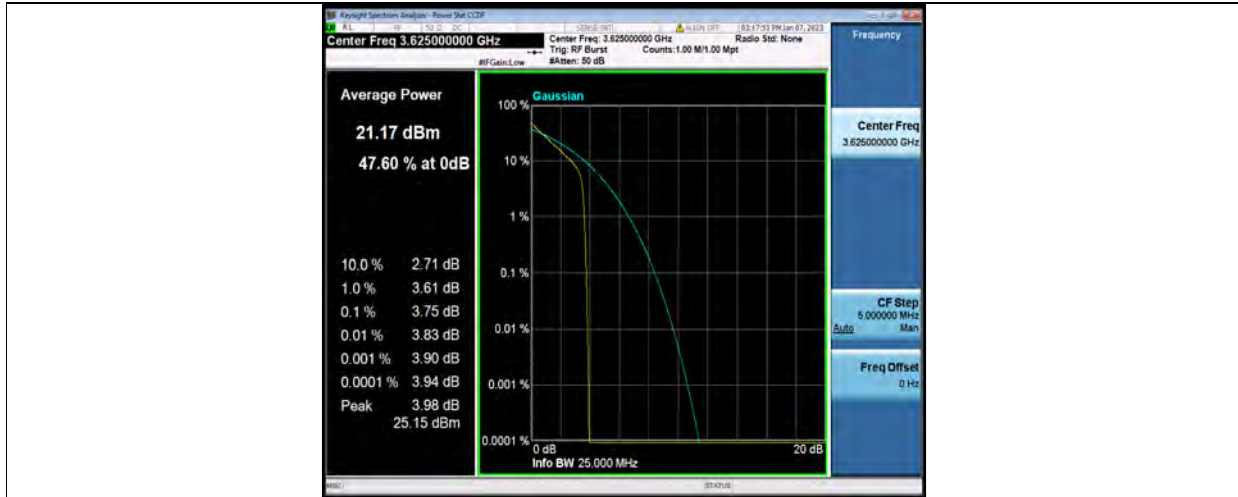

N48-20MHz-QPSK-641666-50RB#0

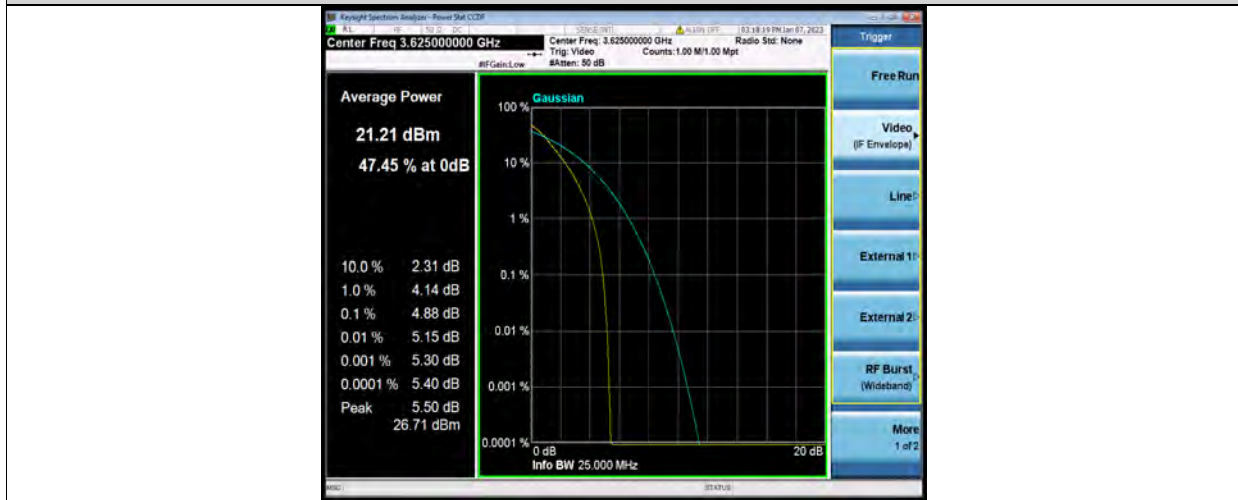

N48-20MHz-QPSK-646000-1RB#0

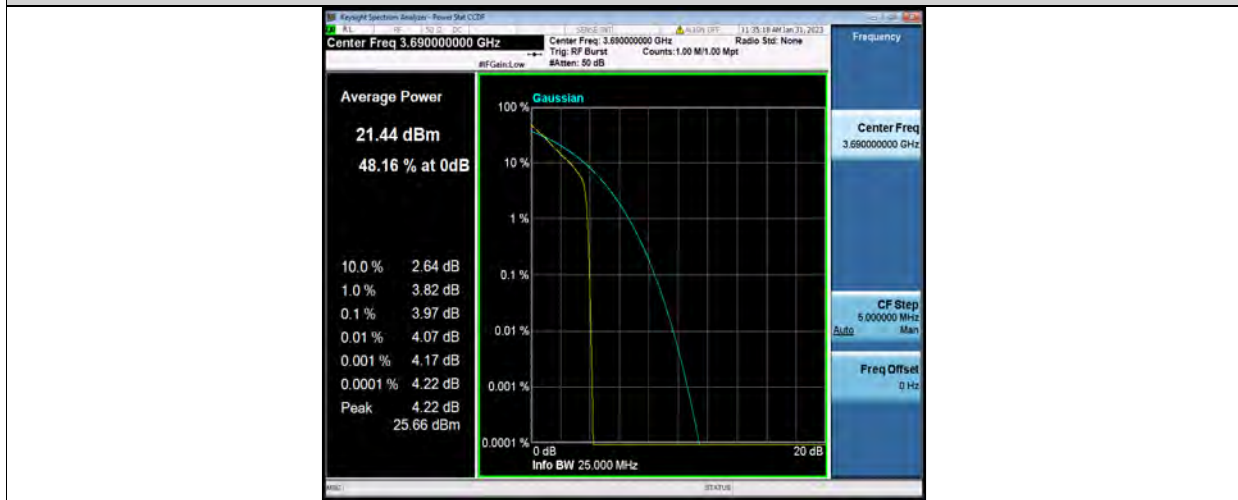

N48-20MHz-QPSK-646000-50RB#0



**BUREAU
VERITAS**

Test Report No.: W7L-P23100014RF11



26DB BANDWIDTH AND OCCUPIED BANDWIDTH TEST RESULT

Band	Bandwidth	Modulation	Channel	RB Configuration	Occupied Bandwidth (MHz)	26dB Bandwidth (MHz)	Verdict
N48	10MHz	QPSK	641666	25RB#0	9.0064	9.699	PASS
N48	10MHz	16QAM	641666	25RB#0	8.9992	9.682	PASS
N48	10MHz	64QAM	641666	25RB#0	8.9542	9.604	PASS
N48	10MHz	256QAM	641666	25RB#0	8.9754	9.659	PASS
N48	10MHz	BPSK	641666	25RB#0	9.0018	9.706	PASS
N48	20MHz	QPSK	641666	50RB#0	17.881	18.79	PASS
N48	20MHz	16QAM	641666	50RB#0	17.872	18.82	PASS
N48	20MHz	64QAM	641666	50RB#0	17.872	18.82	PASS
N48	20MHz	256QAM	641666	50RB#0	17.870	18.75	PASS
N48	20MHz	BPSK	641666	50RB#0	17.877	18.79	PASS
N48	40MHz	QPSK	641666	100RB#0	35.636	37.00	PASS
N48	40MHz	16QAM	641666	100RB#0	35.688	37.05	PASS
N48	40MHz	64QAM	641666	100RB#0	35.681	37.04	PASS
N48	40MHz	256QAM	641666	100RB#0	35.602	36.99	PASS
N48	40MHz	BPSK	641666	100RB#0	35.632	37.01	PASS



BUREAU VERITAS

Test Report No.: W7L-P23100014RF11

TEST GRAPHS





BUREAU VERITAS

Test Report No.: W7L-P23100014RF11



N48-10MHz-256QAM-641666-25RB#0



N48-10MHz-BPSK-641666-25RB#0



N48-20MHz-QPSK-641666-50RB#0



N48-20MHz-16QAM-641666-50RB#0



N48-20MHz-64QAM-641666-50RB#0



N48-20MHz-256QAM-641666-50RB#0



BUREAU VERITAS

Test Report No.: W7L-P23100014RF11



N48-20MHz-BPSK-641666-50RB#0



N48-40MHz-QPSK-641666-100RB#0



N48-40MHz-16QAM-641666-100RB#0



N48-40MHz-64QAM-641666-100RB#0



N48-40MHz-256QAM-641666-100RB#0



N48-40MHz-BPSK-641666-100RB#0



BUREAU VERITAS

Test Report No.: W7L-P23100014RF11





BAND EDGE TEST RESULT

Band	Bandwidth	Modulation	Channel	RB Configuration	Result(dBm)	Verdict
N48	10MHz	QPSK	637000	1RB#0	-49.24,-48.35,-37.81,-29.13	PASS
N48	10MHz	QPSK	637000	1RB#24	-49.42,-49.05,-47.95,-57.04	PASS
N48	10MHz	QPSK	637000	25RB#0	-43.77,-38.22,-25.99,-33.48	PASS
N48	10MHz	QPSK	641666	1RB#0	-55.45,-46.12,-46.58	PASS
N48	10MHz	QPSK	641666	1RB#24	-19.04,-33.99,-46.18	PASS
N48	10MHz	QPSK	641666	25RB#0	-30.88,-26.72,-38.54	PASS
N48	10MHz	QPSK	646332	1RB#0	-54.50,-45.29,-45.72,-45.72	PASS
N48	10MHz	QPSK	646332	1RB#24	-21.64,-35.25,-45.43,-45.68	PASS
N48	10MHz	QPSK	646332	25RB#0	-30.92,-26.85,-39.43,-43.42	PASS
N48	20MHz	QPSK	637334	1RB#0	-49.12,-48.23,-38.24,-31.53	PASS
N48	20MHz	QPSK	637334	1RB#50	-49.31,-48.70,-48.87,-55.47	PASS
N48	20MHz	QPSK	637334	50RB#0	-40.65,-31.89	PASS
N48	20MHz	QPSK	641666	1RB#0	-53.22,-53.01,-46.53	PASS
N48	20MHz	QPSK	641666	1RB#50	-31.95,-39.89,-46.45	PASS
N48	20MHz	QPSK	641666	50RB#0	-35.19,-35.73,-40.62	PASS
N48	20MHz	QPSK	646000	1RB#0	-52.32,-45.68,-45.57,-45.56	PASS
N48	20MHz	QPSK	646000	1RB#50	-32.90,-38.56,-45.26,-45.60	PASS
N48	20MHz	QPSK	646000	50RB#0	-36.44,-31.30,-35.74,-41.60	PASS
N48	40MHz	QPSK	638000	1RB#0	-49.10,-48.25,-36.66,-32.16	PASS
N48	40MHz	QPSK	638000	1RB#104	-49.05,-49.11,-48.84,-53.36	PASS
N48	40MHz	QPSK	638000	100RB#0	-43.97,-40.54,-37.60,-39.71	PASS
N48	40MHz	QPSK	641666	1RB#0	-50.65,-45.99,-45.91	PASS
N48	40MHz	QPSK	641666	1RB#104	-35.68,-35.87,-45.94	PASS
N48	40MHz	QPSK	641666	100RB#0	-36.01,-32.58,-42.53	PASS
N48	40MHz	QPSK	645332	1RB#0	-50.10,-45.88,-45.66,-45.59	PASS
N48	40MHz	QPSK	645332	1RB#104	-35.13,-36.38,-44.53,-45.56	PASS
N48	40MHz	QPSK	645332	100RB#0	-39.56,-37.21,-40.38,-43.36	PASS

TEST GRAPHS

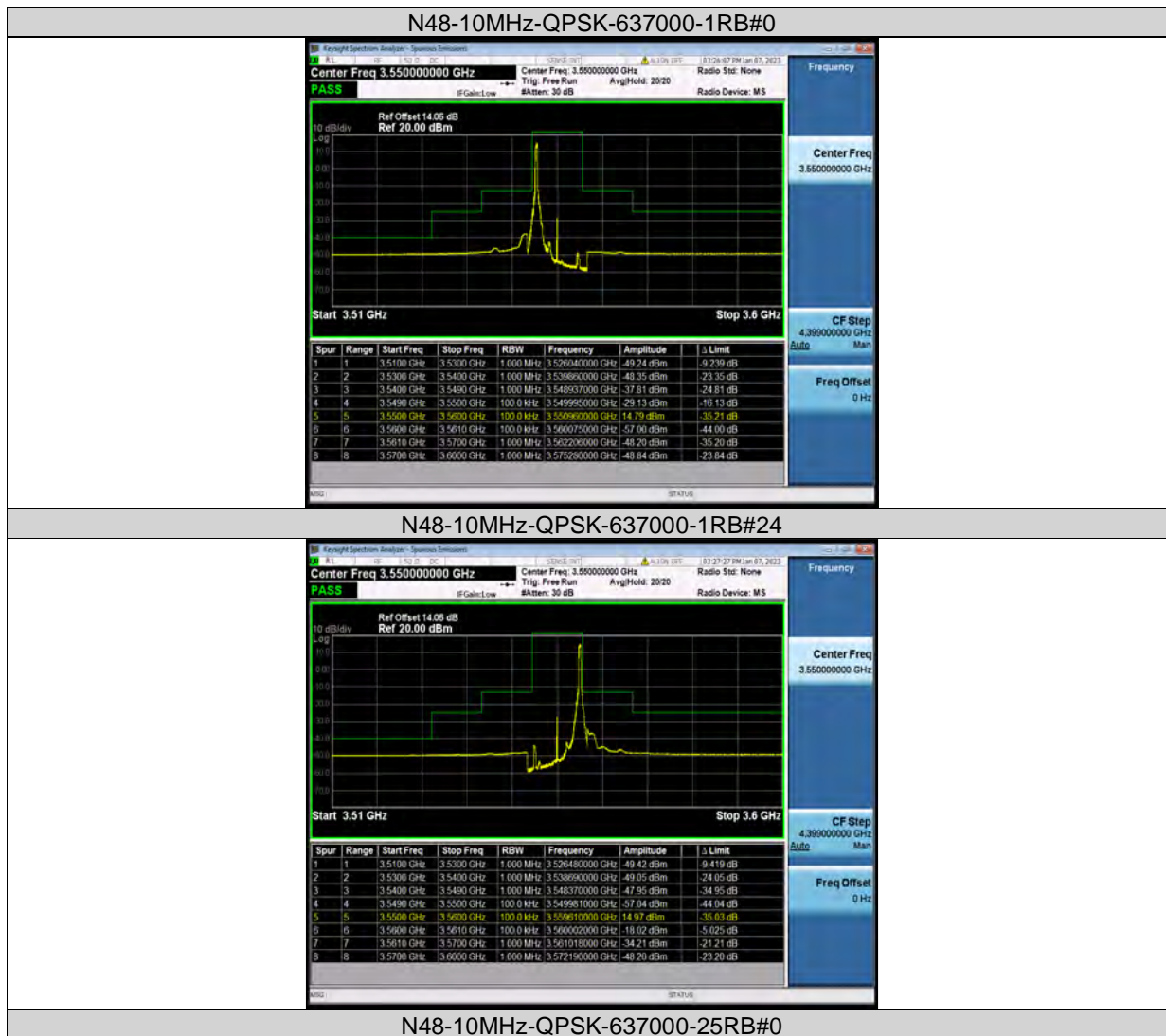



BUREAU VERITAS

Test Report No.: W7L-P23100014RF11



N48-10MHz-QPSK-641666-1RB#0

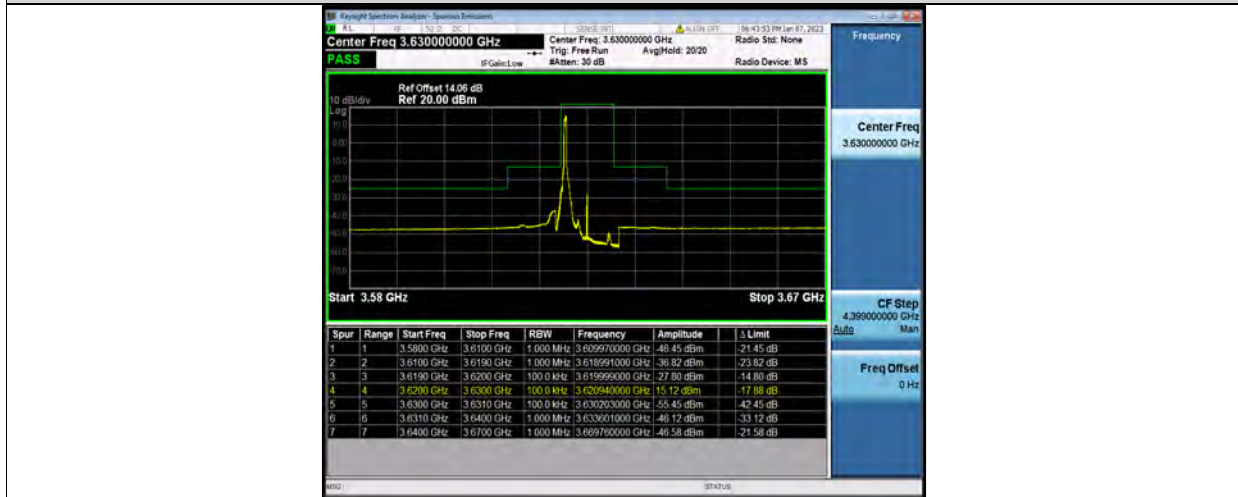

N48-10MHz-QPSK-641666-1RB#24

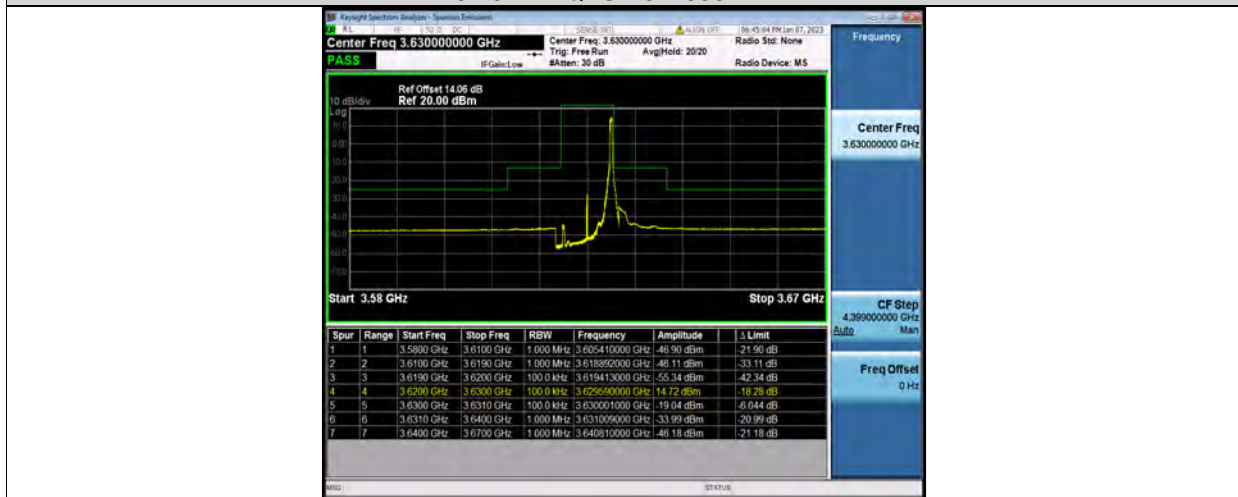

N48-10MHz-QPSK-641666-25RB#0

BV 7Layers Communications Technology (Shenzhen) Co., Ltd

No.B102, Dazu Chuangxin Mansion, North of Beihuan Avenue, North Area, Hi-Tech Industrial Park, Nanshan District, Shenzhen, Guangdong, China

Tel: +86 755 8869 6566
Fax: +86 755 8869 6577
Email: customerservice.sw@bureauveritas.com



BUREAU VERITAS

Test Report No.: W7L-P23100014RF11



N48-10MHz-QPSK-646332-1RB#0

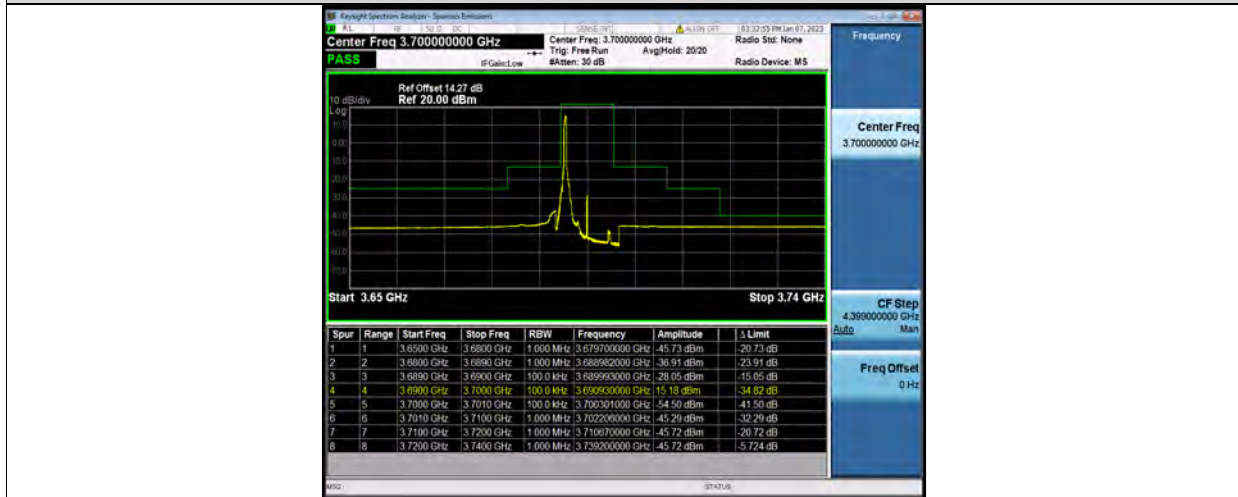

N48-10MHz-QPSK-646332-1RB#24

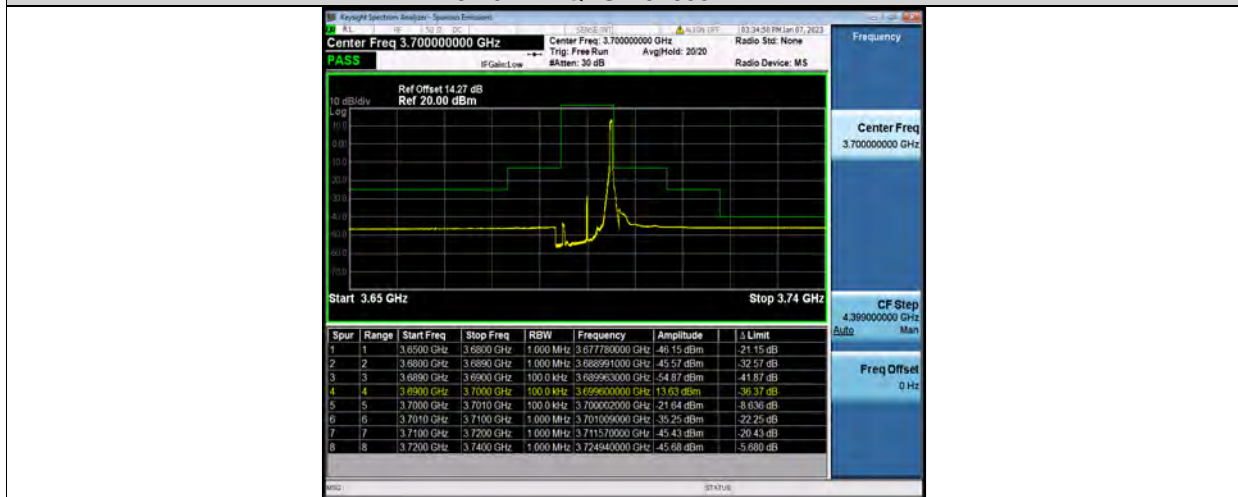

N48-10MHz-QPSK-646332-25RB#0

BV 7Layers Communications Technology (Shenzhen) Co., Ltd

No.B102, Dazu Chuangxin Mansion, North of Beihuan Avenue, North Area, Hi-Tech Industrial Park, Nanshan District, Shenzhen, Guangdong, China

Tel: +86 755 8869 6566 Fax: +86 755 8869 6577 Email: customerservice.sw@bureauveritas.com



BUREAU VERITAS

Test Report No.: W7L-P23100014RF11



N48-20MHz-QPSK-637334-1RB#0



N48-20MHz-QPSK-637334-1RB#50

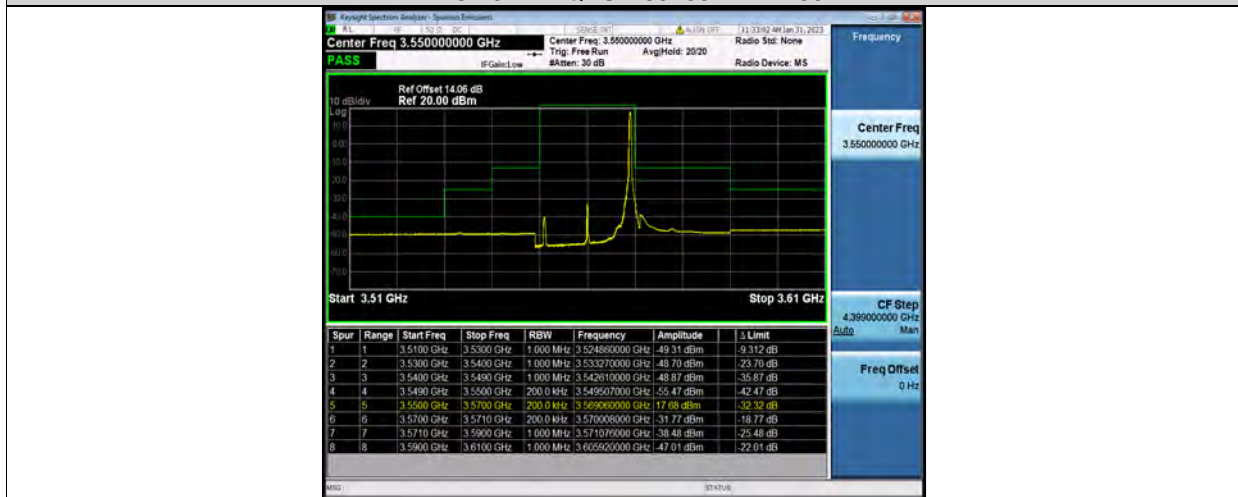

N48-20MHz-QPSK-637334-50RB#0

BV 7Layers Communications Technology (Shenzhen) Co., Ltd

No.B102, Dazu Chuangxin Mansion, North of Beihuan Avenue, North Area, Hi-Tech Industrial Park, Nanshan District, Shenzhen, Guangdong, China

Tel: +86 755 8869 6566
Fax: +86 755 8869 6577
Email: customerservice.sw@bureauveritas.com



BUREAU VERITAS

Test Report No.: W7L-P23100014RF11



N48-20MHz-QPSK-641666-1RB#0

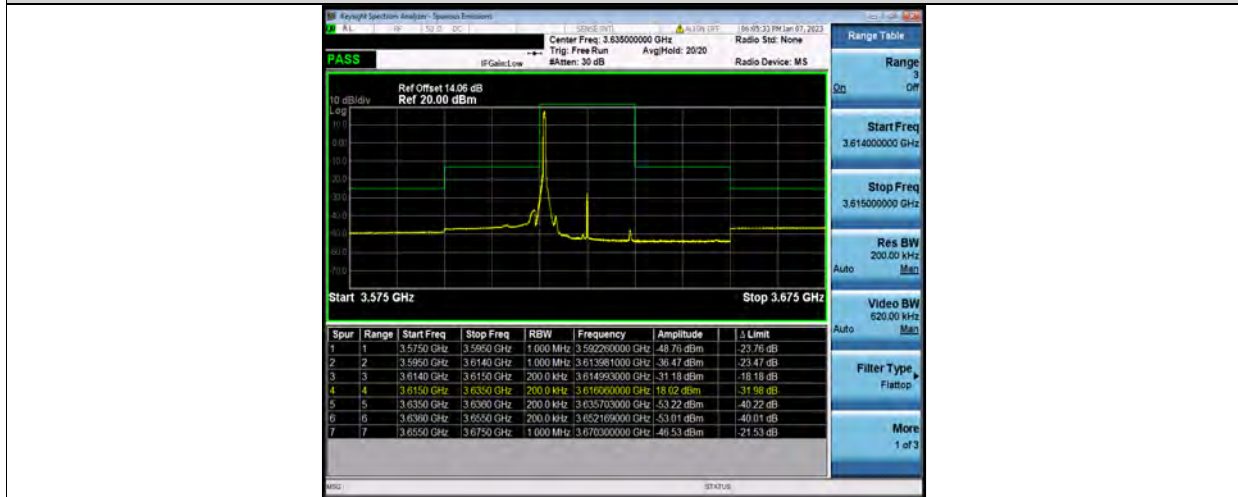

N48-20MHz-QPSK-641666-1RB#50

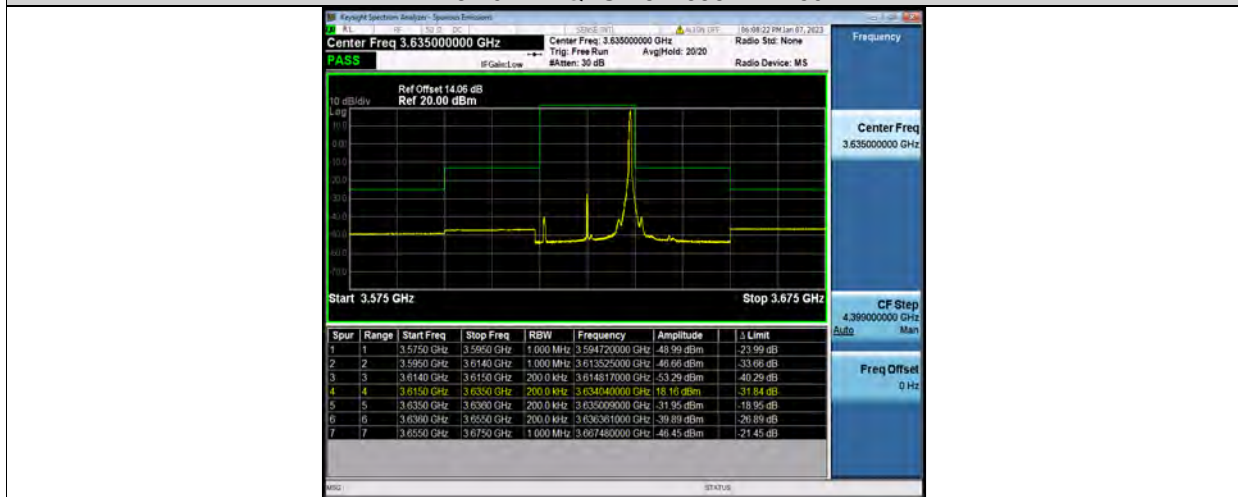

N48-20MHz-QPSK-641666-50RB#0

BV 7Layers Communications Technology (Shenzhen) Co., Ltd

No.B102, Dazu Chuangxin Mansion, North of Beihuan Avenue, North Area, Hi-Tech Industrial Park, Nanshan District, Shenzhen, Guangdong, China

Tel: +86 755 8869 6566
Fax: +86 755 8869 6577
Email: customerservice.sw@bureauveritas.com



BUREAU VERITAS

Test Report No.: W7L-P23100014RF11



N48-20MHz-QPSK-646000-1RB#0

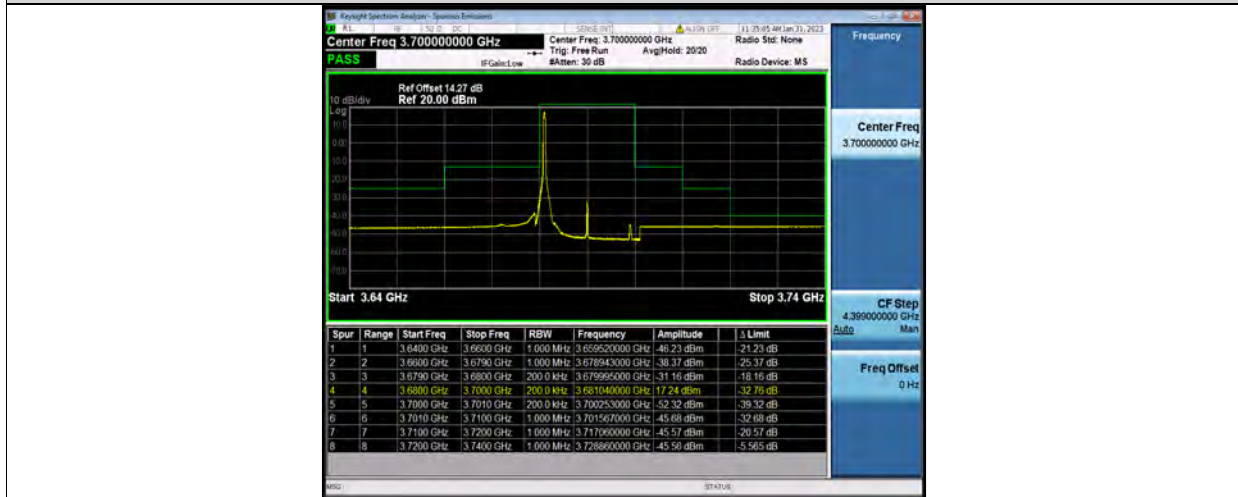

N48-20MHz-QPSK-646000-1RB#0

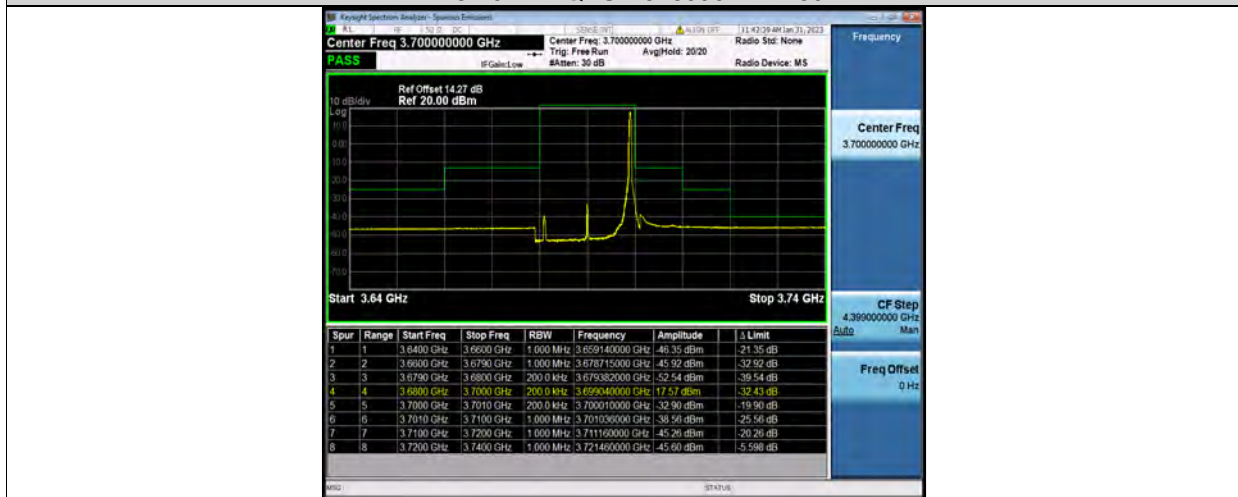

N48-20MHz-QPSK-646000-50RB#0

BV 7Layers Communications Technology (Shenzhen) Co., Ltd

No.B102, Dazu Chuangxin Mansion, North of Beihuan Avenue, North Area, Hi-Tech Industrial Park, Nanshan District, Shenzhen, Guangdong, China

Tel: +86 755 8869 6566
Fax: +86 755 8869 6577
Email: customerservice.sw@bureauveritas.com



BUREAU VERITAS

Test Report No.: W7L-P23100014RF11



N48-40MHz-QPSK-638000-1RB#0



N48-40MHz-QPSK-638000-1RB#104

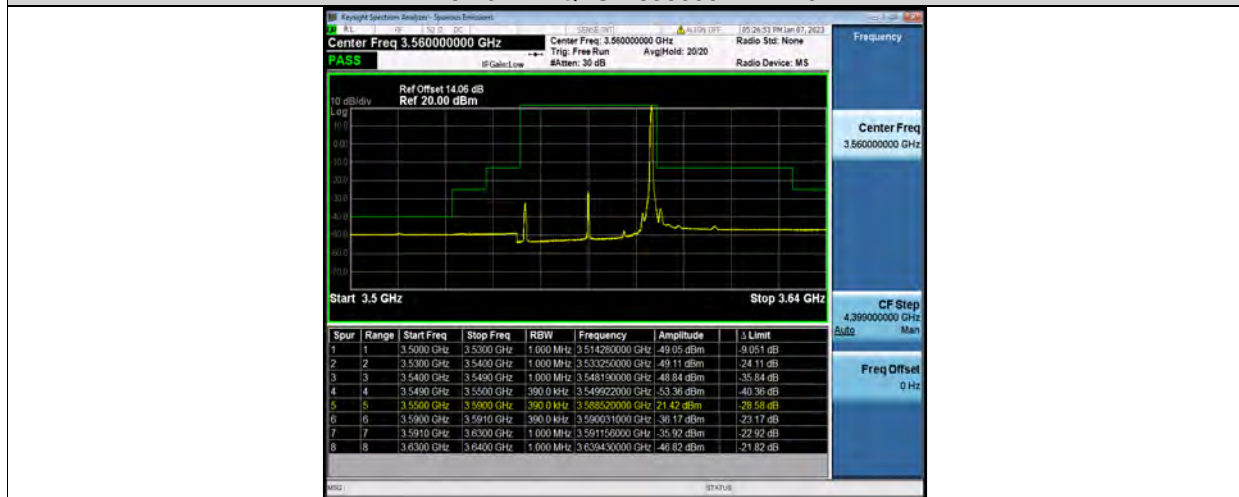

N48-40MHz-QPSK-638000-100RB#0

BV 7Layers Communications Technology (Shenzhen) Co., Ltd

No.B102, Dazu Chuangxin Mansion, North of Beihuan Avenue, North Area, Hi-Tech Industrial Park, Nanshan District, Shenzhen, Guangdong, China

Tel: +86 755 8869 6566 Fax: +86 755 8869 6577 Email: customerservice.sw@bureauveritas.com



BUREAU VERITAS

Test Report No.: W7L-P23100014RF11



N48-40MHz-QPSK-641666-1RB#0

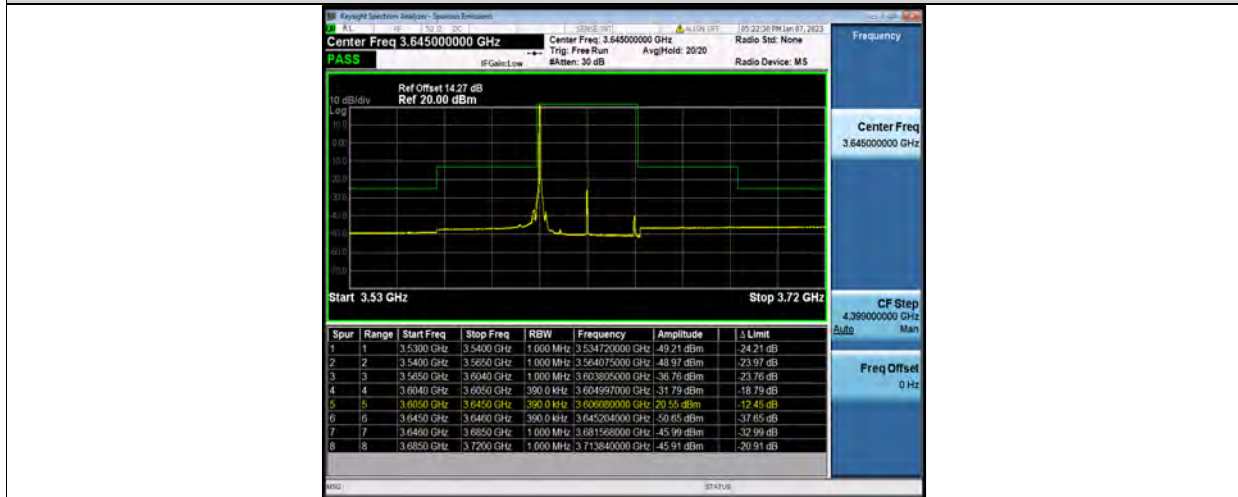

N48-40MHz-QPSK-641666-1RB#104

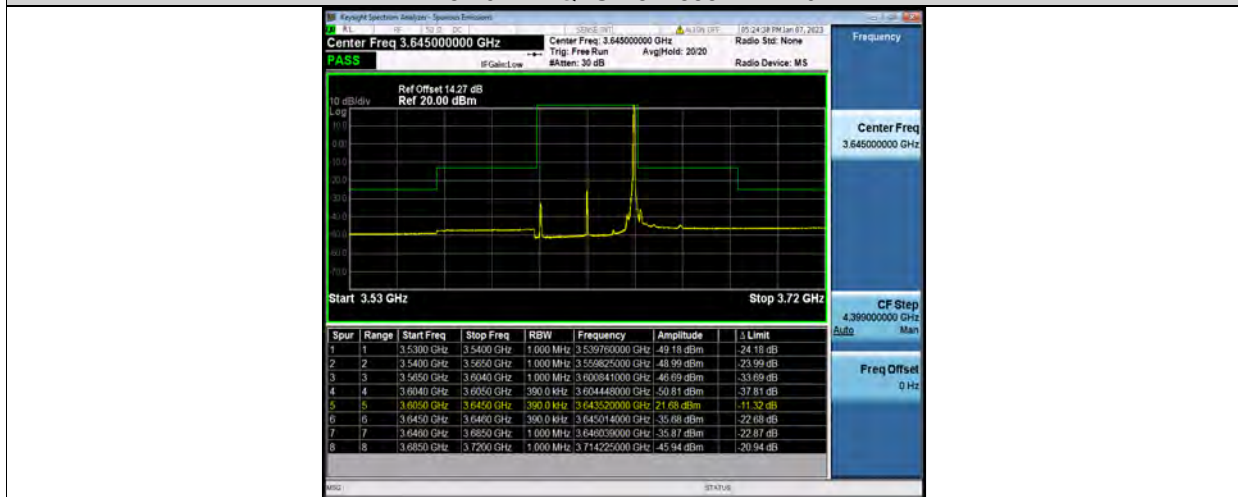

N48-40MHz-QPSK-641666-100RB#0

BV 7Layers Communications Technology (Shenzhen) Co., Ltd

No.B102, Dazu Chuangxin Mansion, North of Beihuan Avenue, North Area, Hi-Tech Industrial Park, Nanshan District, Shenzhen, Guangdong, China

Tel: +86 755 8869 6566
Fax: +86 755 8869 6577
Email: customerservice.sw@bureauveritas.com



BUREAU VERITAS

Test Report No.: W7L-P23100014RF11



N48-40MHz-QPSK-645332-1RB#0



N48-40MHz-QPSK-645332-1RB#104

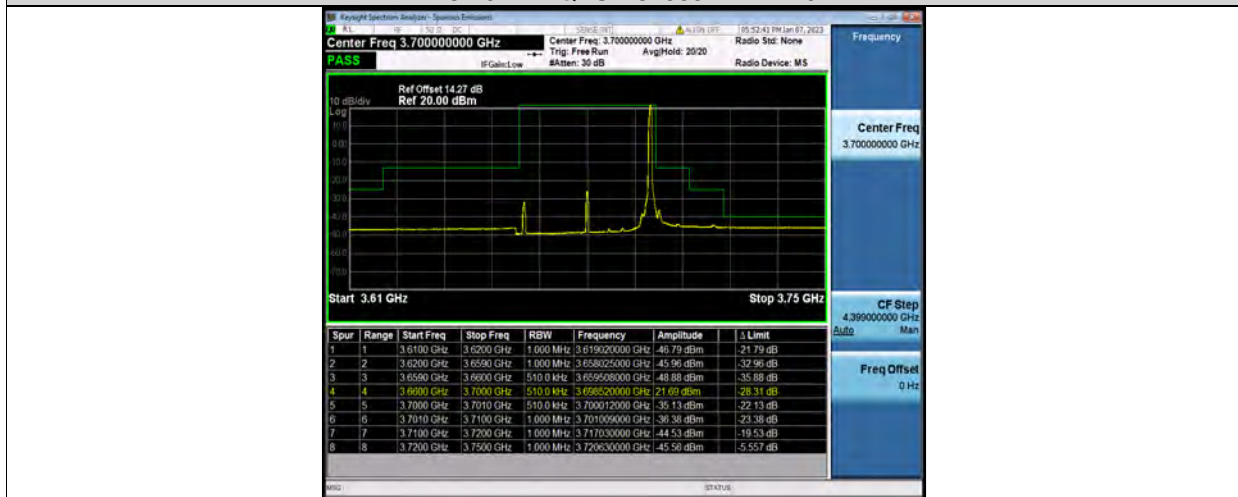

N48-40MHz-QPSK-645332-100RB#0

BV 7Layers Communications Technology (Shenzhen) Co., Ltd

No.B102, Dazu Chuangxin Mansion, North of Beihuan Avenue, North Area, Hi-Tech Industrial Park, Nanshan District, Shenzhen, Guangdong, China

Tel: +86 755 8869 6566
Fax: +86 755 8869 6577
Email: customerservice.sw@bureauveritas.com



BUREAU VERITAS

Test Report No.: W7L-P23100014RF11



BV 7Layers Communications Technology (Shenzhen) Co., Ltd

No.B102, Dazu Chuangxin Mansion, North of Beihuan Avenue, North Area, Hi-Tech Industrial Park, Nanshan District, Shenzhen, Guangdong, China

Tel: +86 755 8869 6566
Fax: +86 755 8869 6577
Email: customerservice.sw@bureauveritas.com

ACLR TEST RESULT

Band	Bandwidth	Modulation	Channel	RB Configuration	Result(dBm)	Verdict
N48	10MHz	QPSK	637000	1RB#0	SeeGarph	PASS
N48	10MHz	QPSK	637000	1RB#24	SeeGarph	PASS
N48	10MHz	QPSK	637000	25RB#0	SeeGarph	PASS
N48	10MHz	QPSK	641666	1RB#0	SeeGarph	PASS
N48	10MHz	QPSK	641666	1RB#24	SeeGarph	PASS
N48	10MHz	QPSK	641666	25RB#0	SeeGarph	PASS
N48	10MHz	QPSK	646332	1RB#0	SeeGarph	PASS
N48	10MHz	QPSK	646332	1RB#24	SeeGarph	PASS
N48	10MHz	QPSK	646332	25RB#0	SeeGarph	PASS
N48	20MHz	QPSK	637334	1RB#0	SeeGarph	PASS
N48	20MHz	QPSK	637334	1RB#50	SeeGarph	PASS
N48	20MHz	QPSK	637334	50RB#0	SeeGarph	PASS
N48	20MHz	QPSK	641666	1RB#0	SeeGarph	PASS
N48	20MHz	QPSK	641666	1RB#50	SeeGarph	PASS
N48	20MHz	QPSK	641666	50RB#0	SeeGarph	PASS
N48	20MHz	QPSK	646000	1RB#0	SeeGarph	PASS
N48	20MHz	QPSK	646000	1RB#50	SeeGarph	PASS
N48	20MHz	QPSK	646000	50RB#0	SeeGarph	PASS
N48	40MHz	QPSK	638000	1RB#0	SeeGarph	PASS
N48	40MHz	QPSK	638000	1RB#104	SeeGarph	PASS
N48	40MHz	QPSK	638000	100RB#0	SeeGarph	PASS
N48	40MHz	QPSK	641666	1RB#0	SeeGarph	PASS
N48	40MHz	QPSK	641666	1RB#104	SeeGarph	PASS
N48	40MHz	QPSK	641666	100RB#0	SeeGarph	PASS
N48	40MHz	QPSK	645332	1RB#0	SeeGarph	PASS
N48	40MHz	QPSK	645332	1RB#104	SeeGarph	PASS
N48	40MHz	QPSK	645332	100RB#0	SeeGarph	PASS



TEST GRAPHS

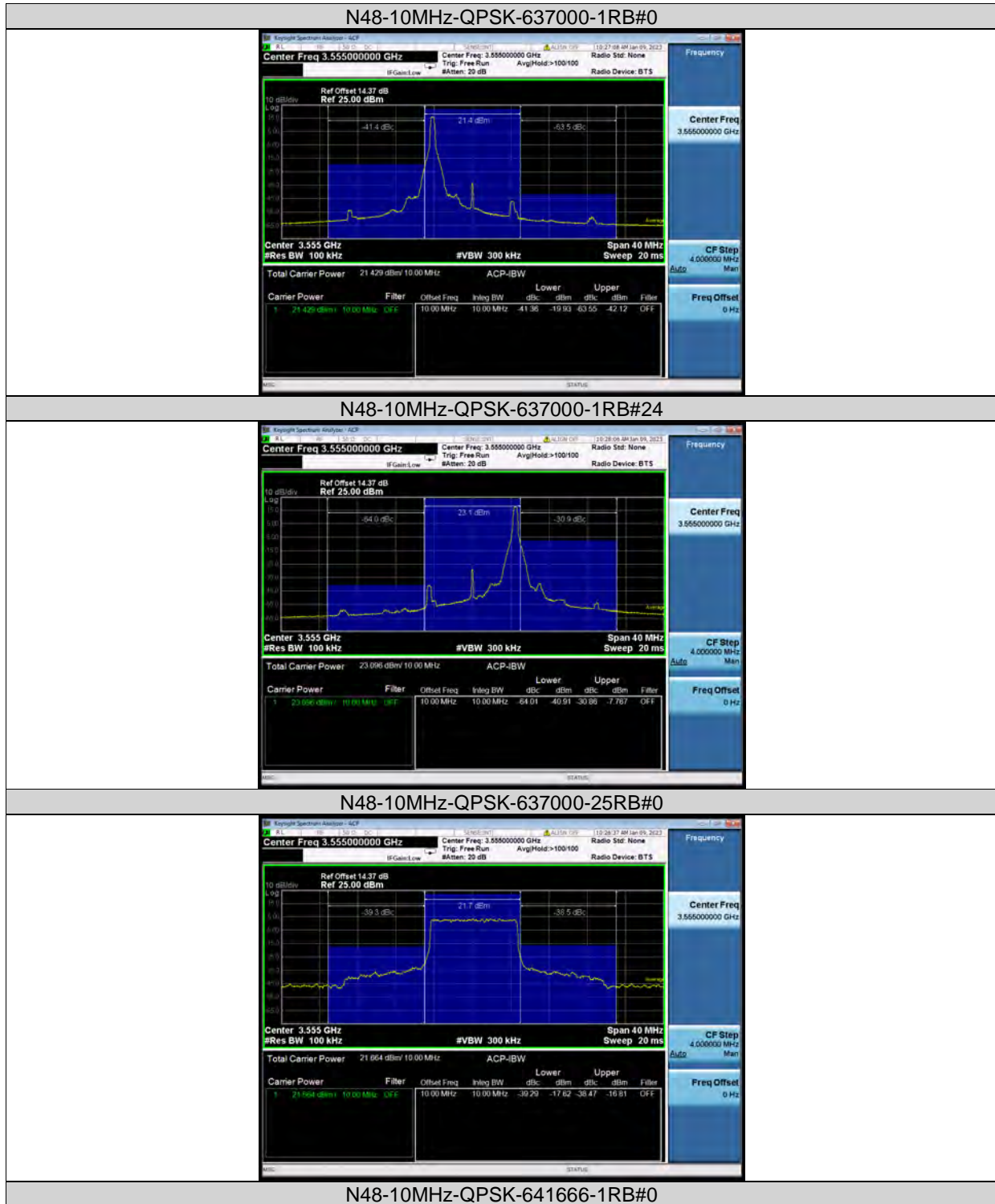



BUREAU VERITAS

Test Report No.: W7L-P23100014RF11

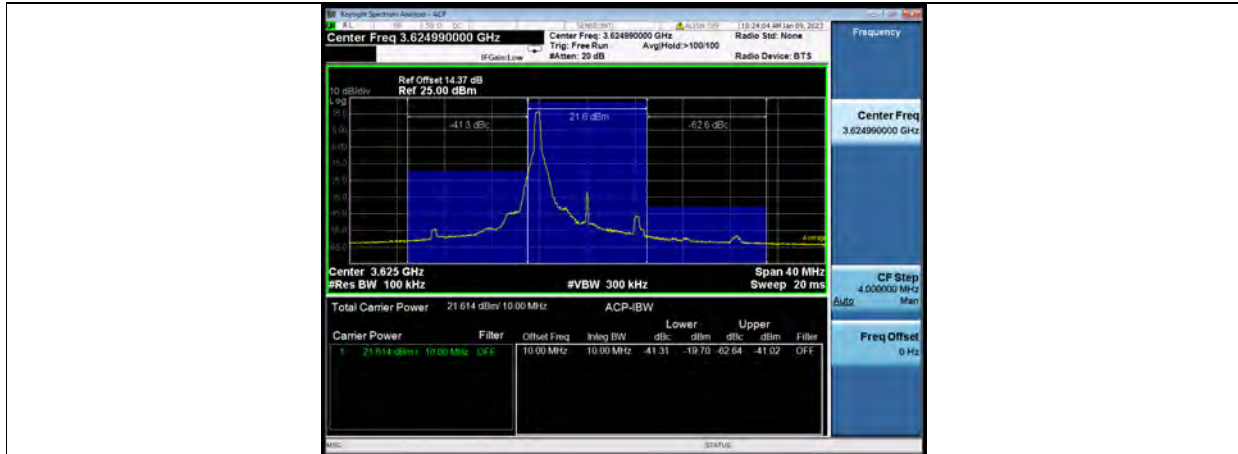

N48-10MHz-QPSK-641666-1RB#24

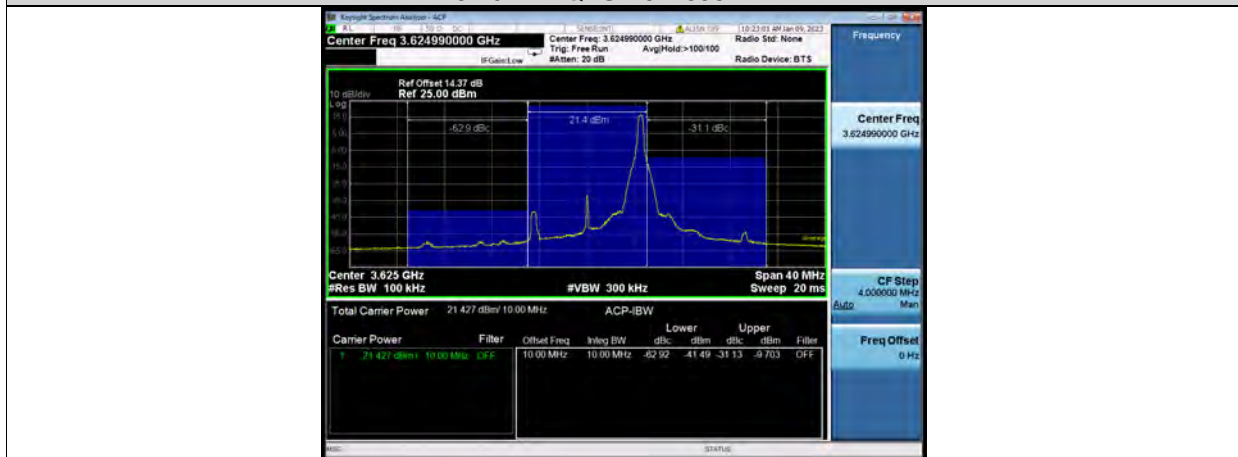

N48-10MHz-QPSK-641666-25RB#0

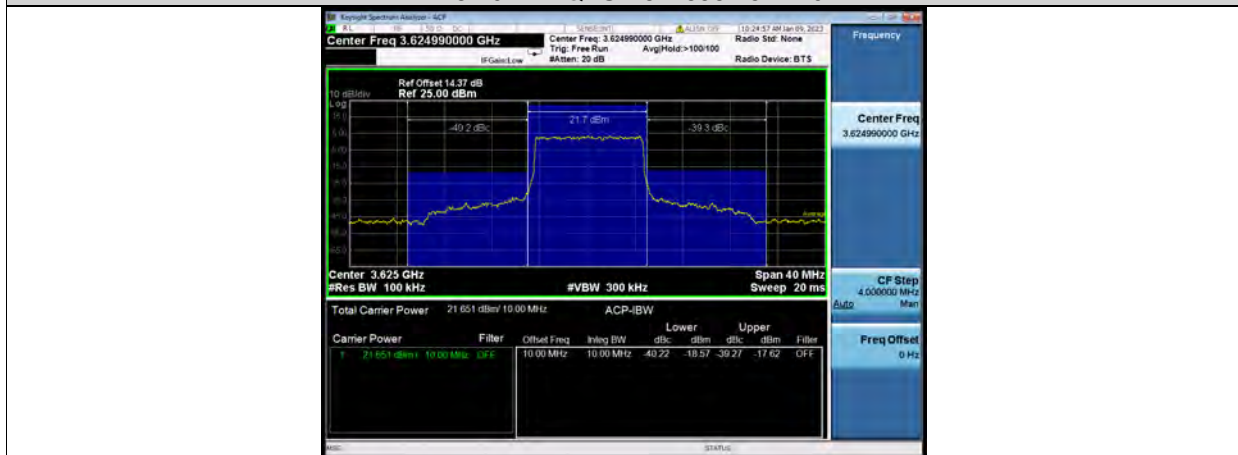

N48-10MHz-QPSK-646332-1RB#0

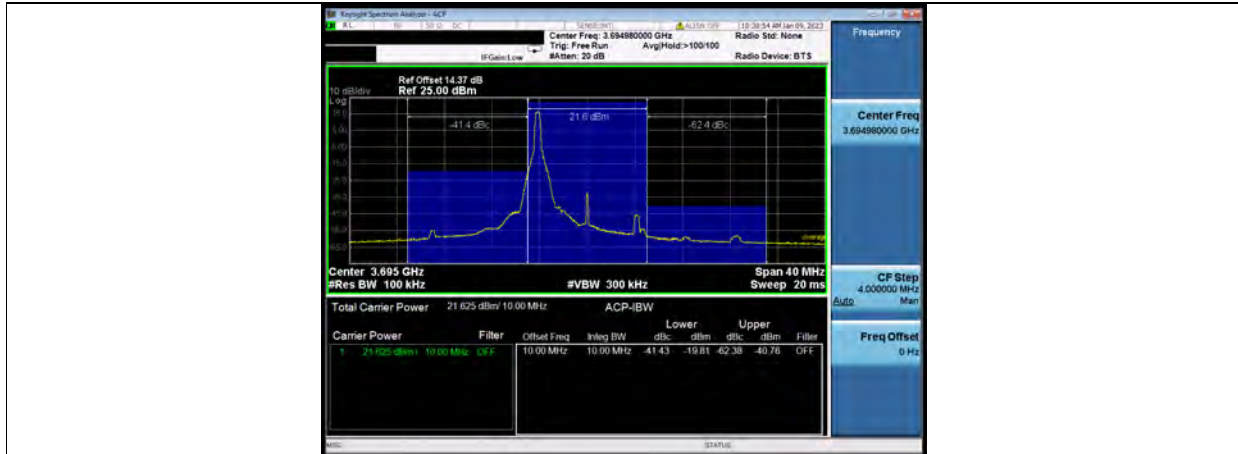

N48-10MHz-QPSK-646332-1RB#24

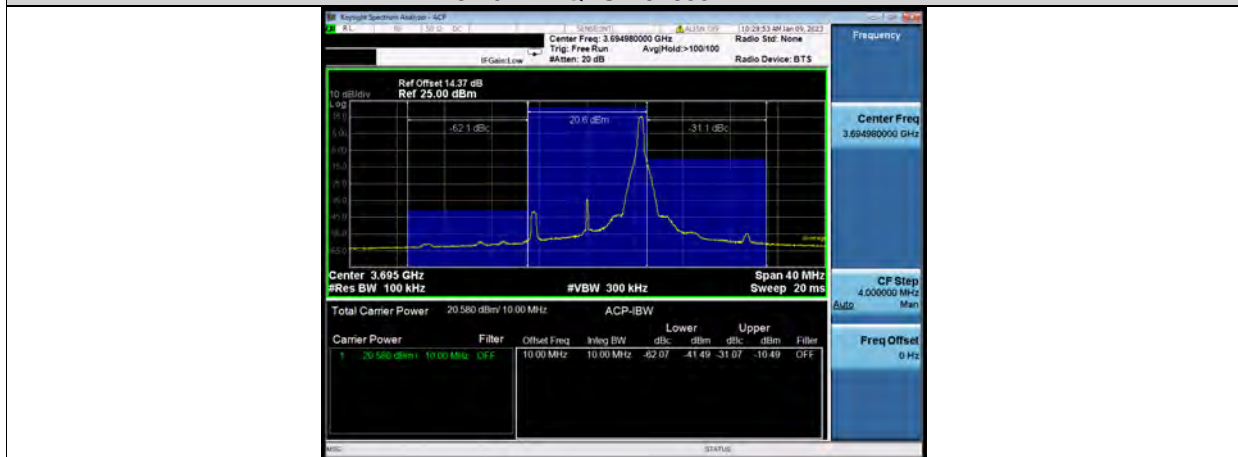

N48-10MHz-QPSK-646332-25RB#0

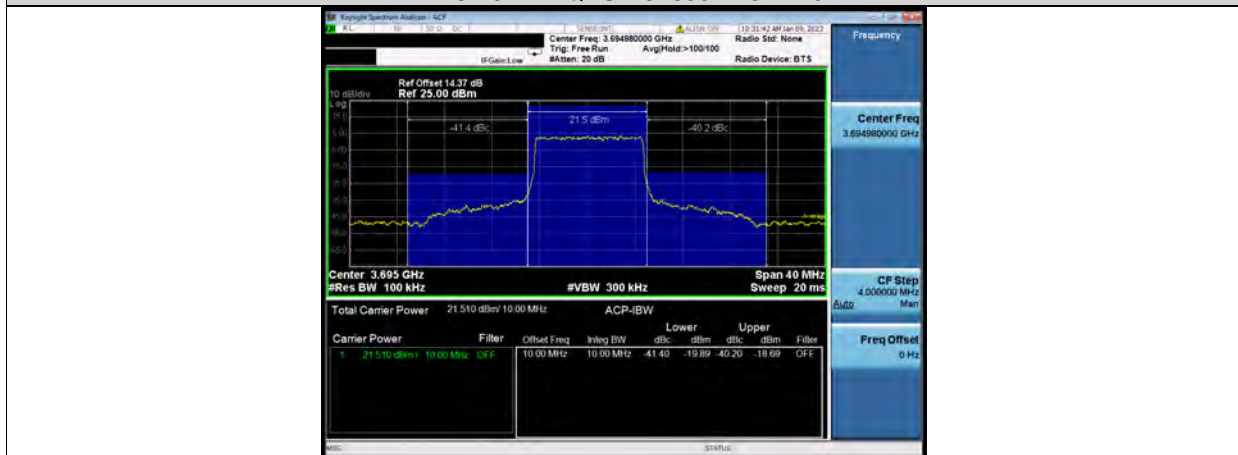

N48-20MHz-QPSK-637334-1RB#0

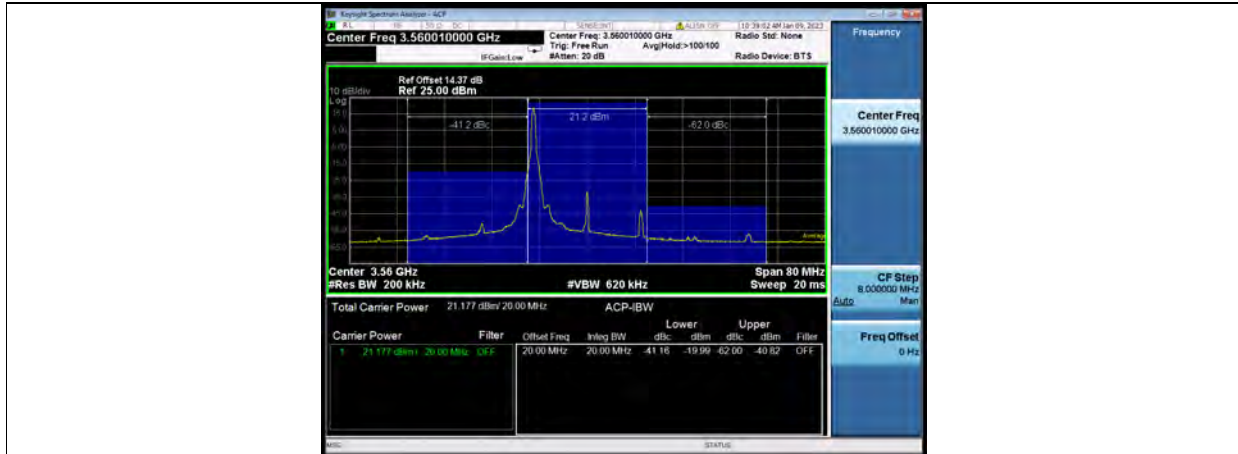

N48-20MHz-QPSK-637334-1RB#50

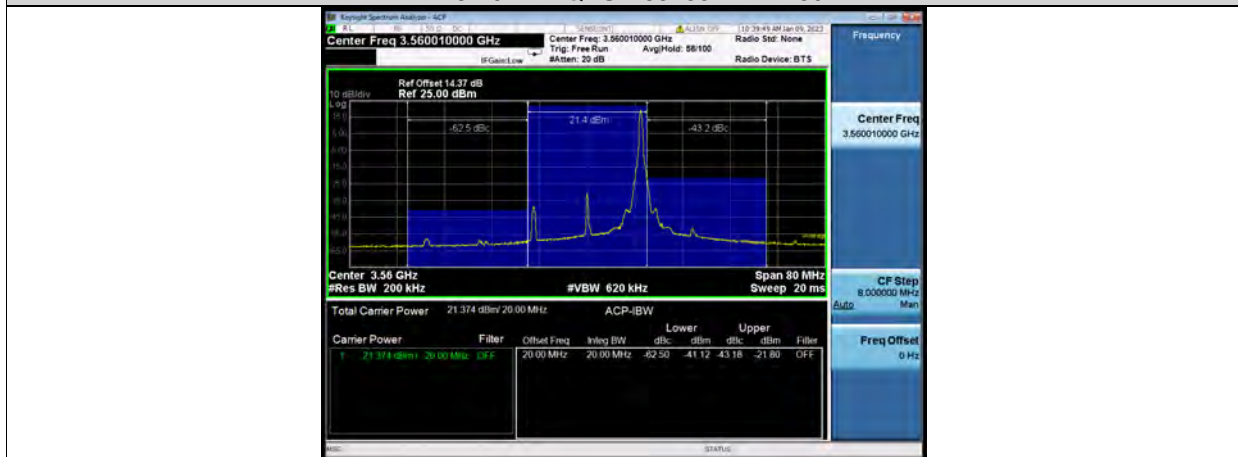

N48-20MHz-QPSK-637334-50RB#0



N48-20MHz-QPSK-641666-1RB#0

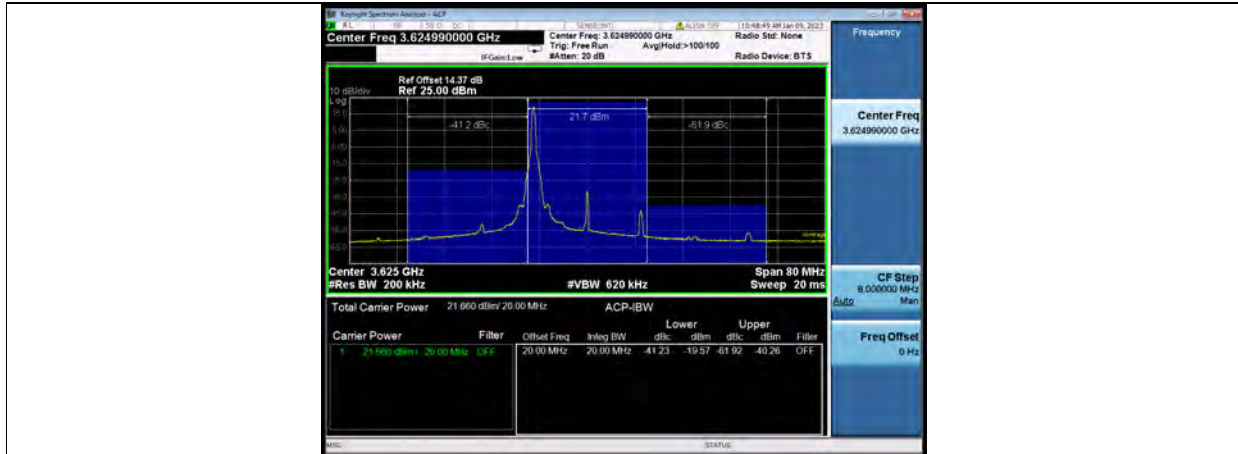

N48-20MHz-QPSK-641666-1RB#50

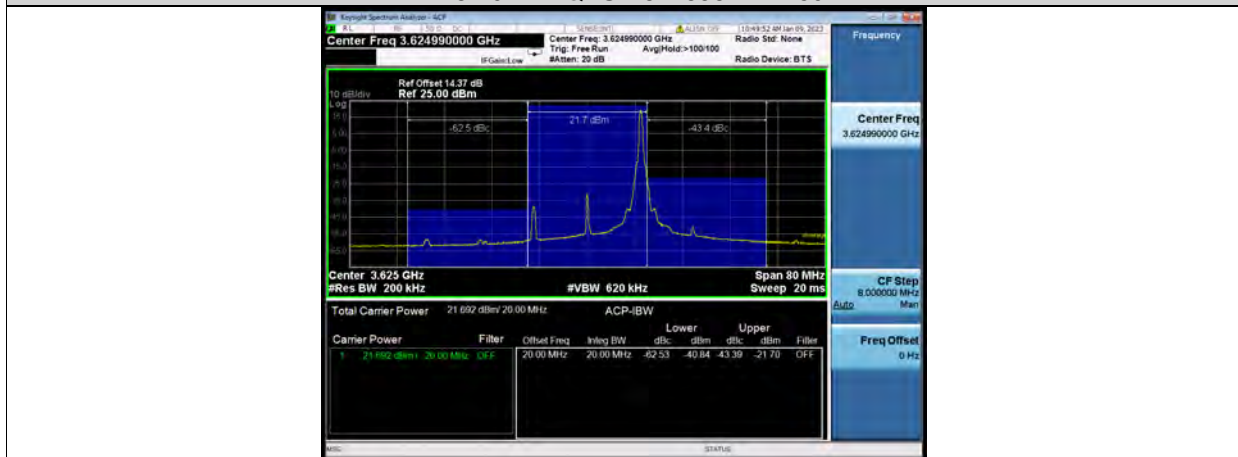

N48-20MHz-QPSK-641666-50RB#0



N48-20MHz-QPSK-646000-1RB#0



BUREAU VERITAS

Test Report No.: W7L-P23100014RF11

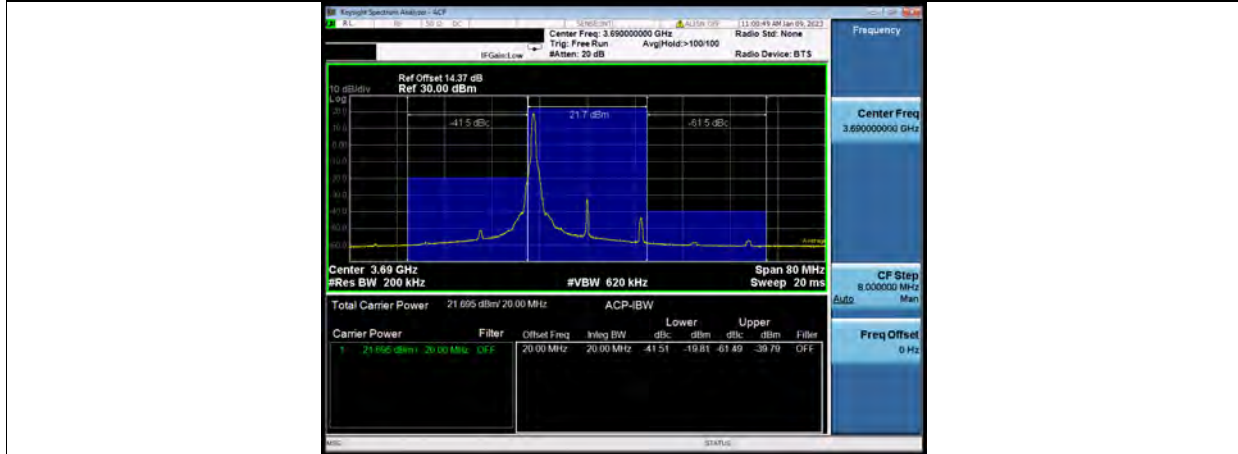

N48-20MHz-QPSK-646000-1RB#50

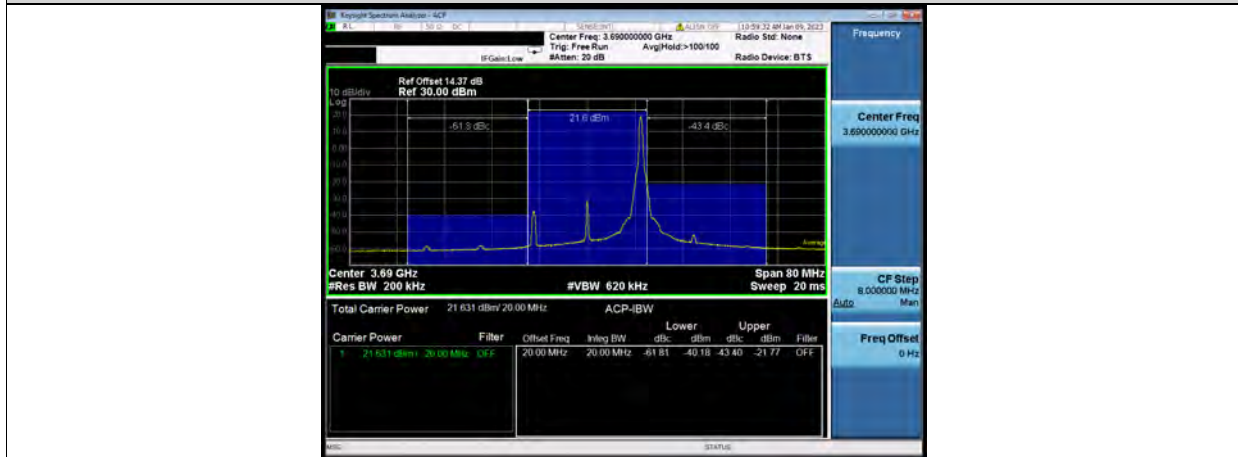

N48-20MHz-QPSK-646000-50RB#0

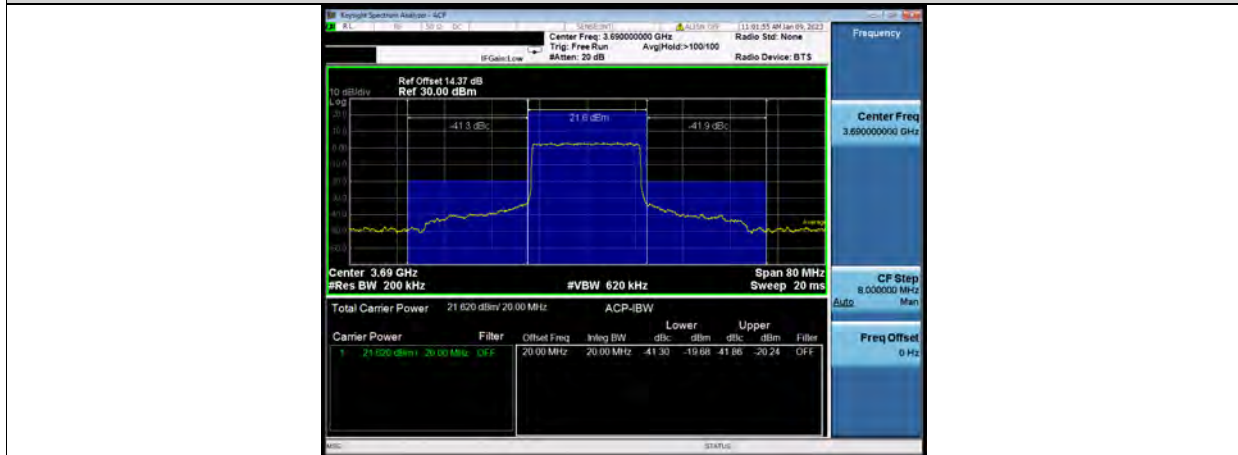

N48-40MHz-QPSK-638000-1RB#0

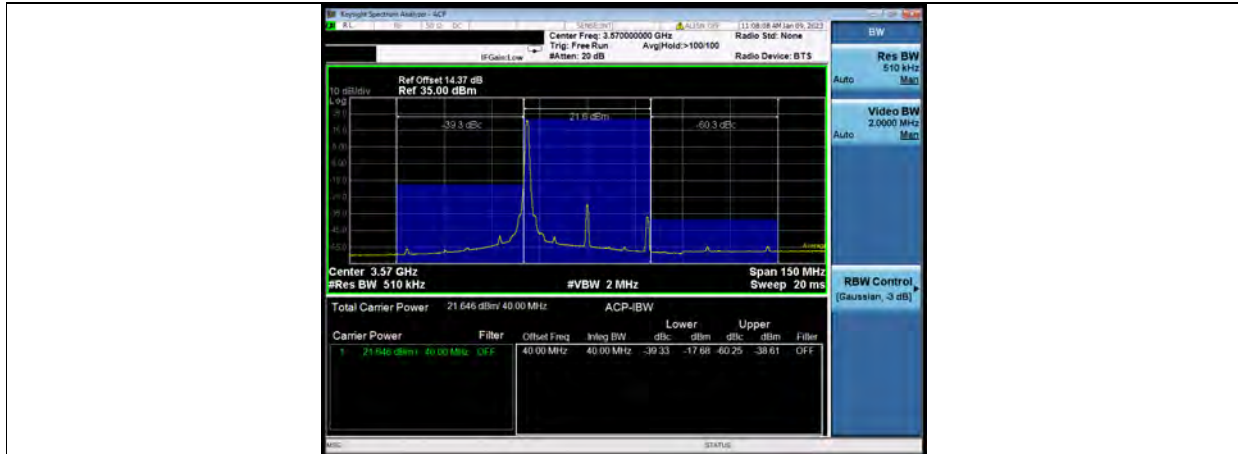

N48-40MHz-QPSK-638000-1RB#104

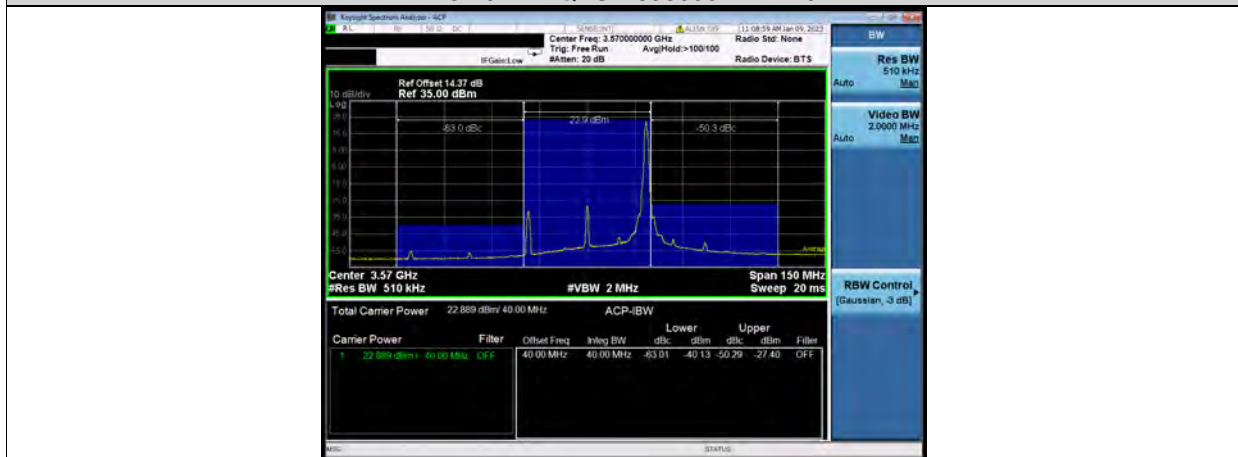

N48-40MHz-QPSK-638000-100RB#0



N48-40MHz-QPSK-641666-1RB#0

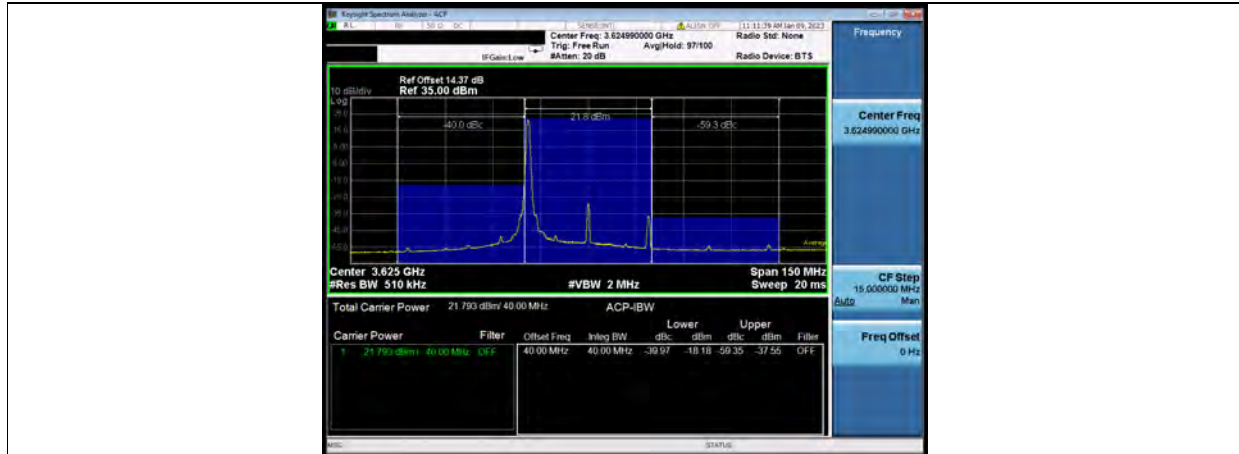

N48-40MHz-QPSK-641666-1RB#104

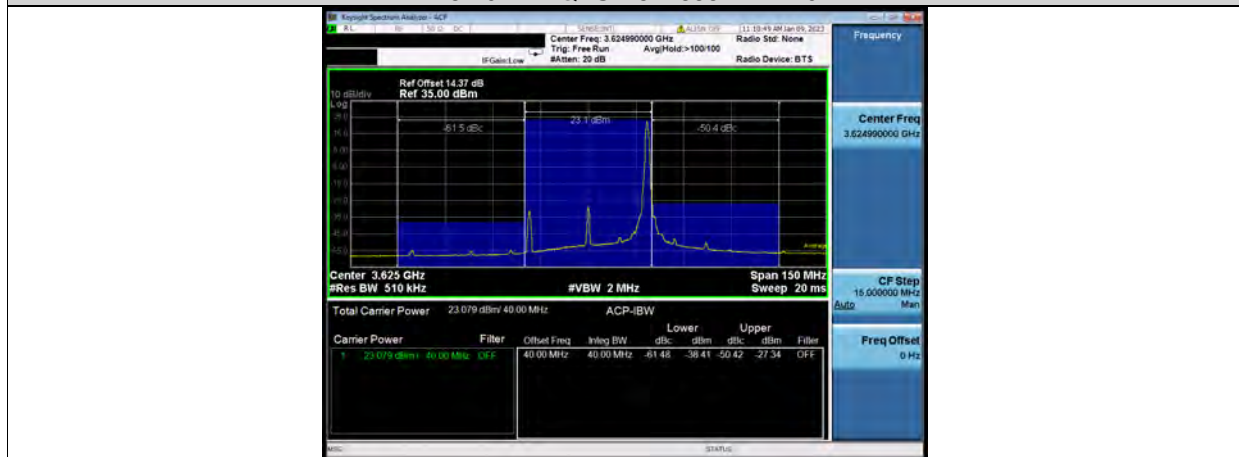

N48-40MHz-QPSK-641666-100RB#0

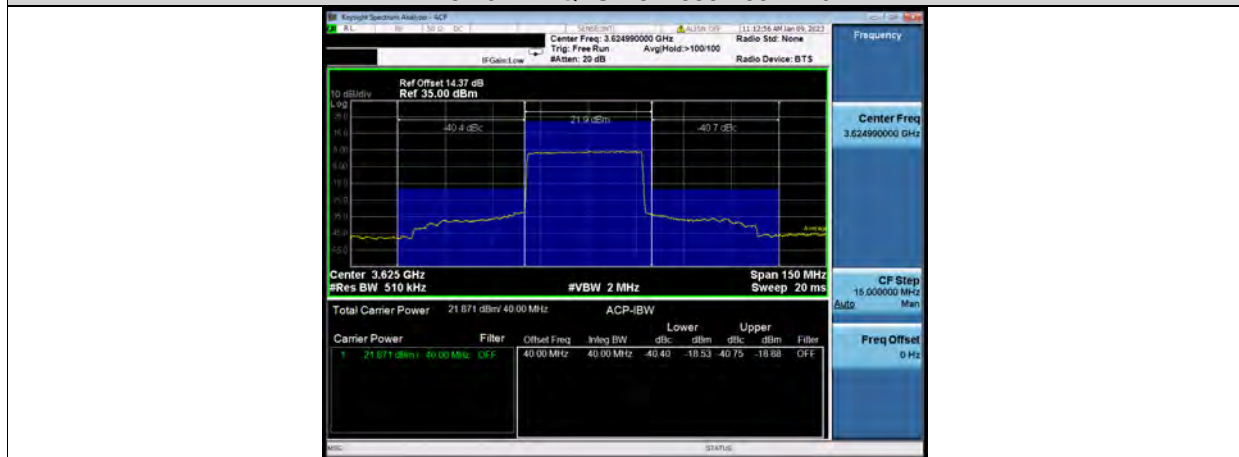

N48-40MHz-QPSK-645332-1RB#0

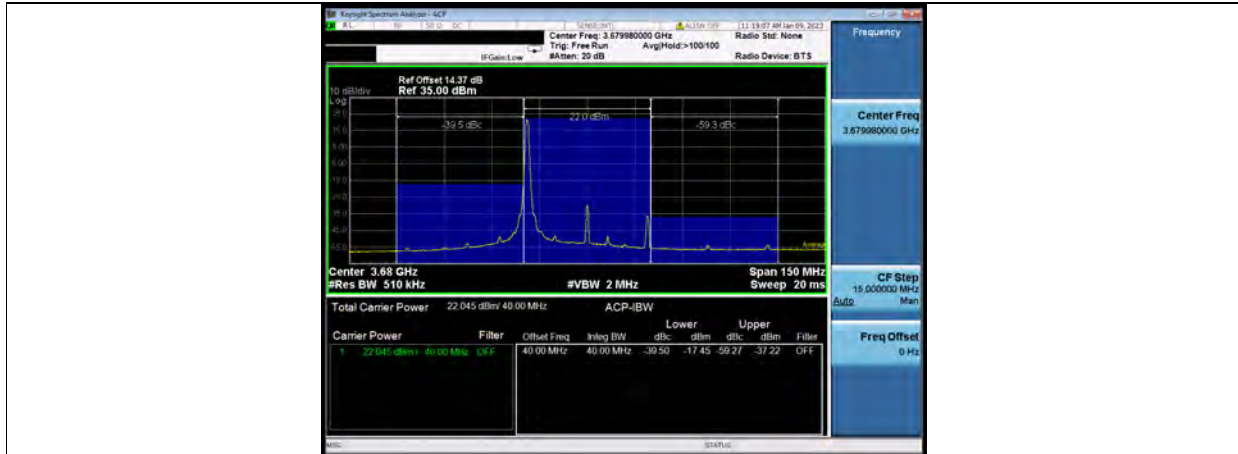

N48-40MHz-QPSK-645332-1RB#104

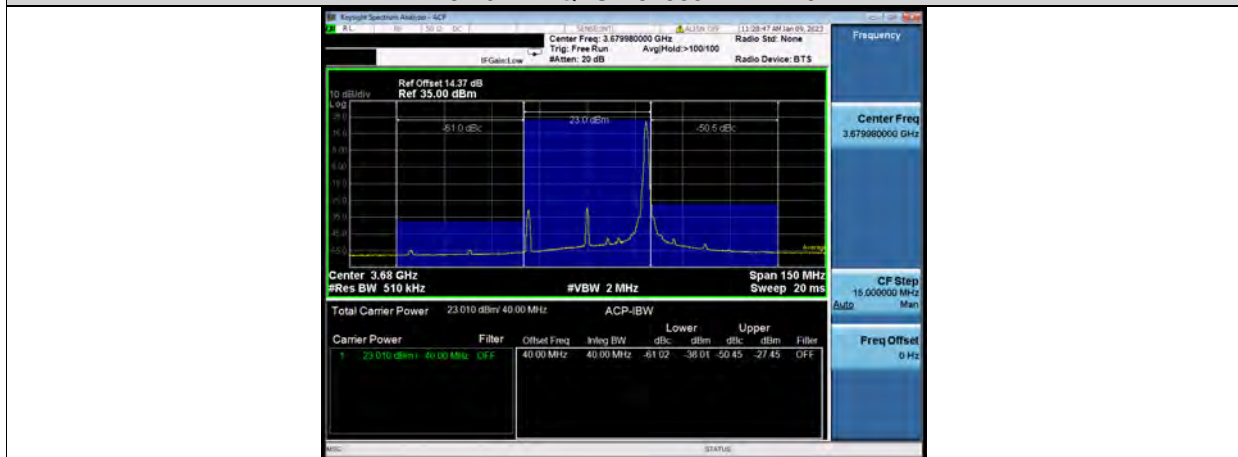

N48-40MHz-QPSK-645332-100RB#0

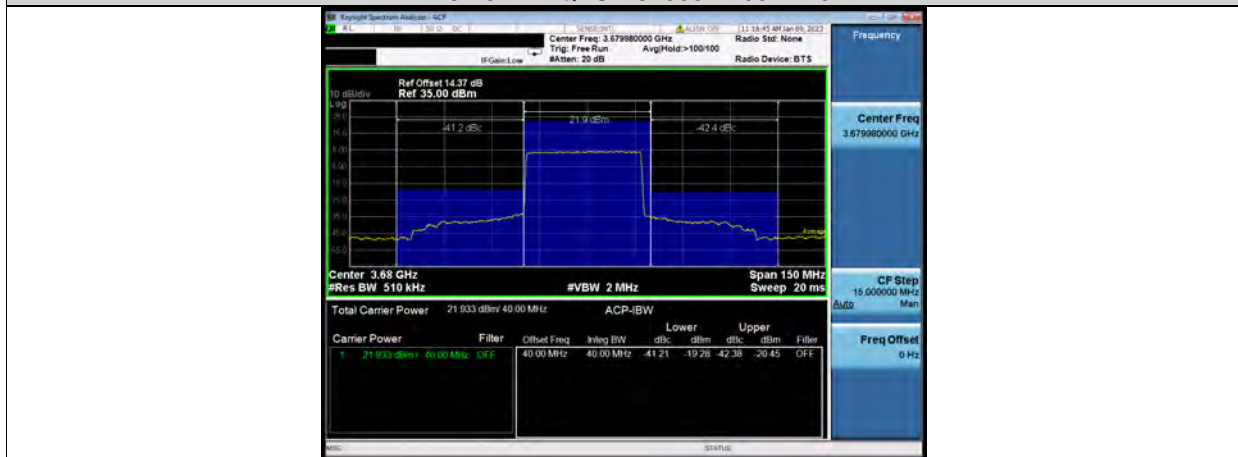

CONDUCTED SPURIOUS EMISSION TEST RESULT

Band	Bandwidth	Modulation	Channel	RB Configuration	Frequency Range	Result (dBm)	Verdict
N48	10MHz	QPSK	637000	1RB#0	Range1:30~40000MHz	-47.62	PASS
N48	10MHz	QPSK	641666	1RB#0	Range1:30~40000MHz	-47.90	PASS
N48	10MHz	QPSK	646332	1RB#0	Range1:30~40000MHz	-47.67	PASS
N48	20MHz	QPSK	637334	1RB#0	Range1:30~40000MHz	-47.86	PASS
N48	20MHz	QPSK	641666	1RB#0	Range1:30~40000MHz	-46.77	PASS
N48	20MHz	QPSK	646000	1RB#0	Range1:30~40000MHz	-47.99	PASS
N48	40MHz	QPSK	638000	1RB#0	Range1:30~40000MHz	-48.10	PASS
N48	40MHz	QPSK	641666	1RB#0	Range1:30~40000MHz	-47.33	PASS
N48	40MHz	QPSK	645332	1RB#0	Range1:30~40000MHz	-47.47	PASS



BUREAU VERITAS

Test Report No.: W7L-P23100014RF11

TEST GRAPHS

N48-10MHz-QPSK-637000-1RB#0-Range1:30~4000MHz

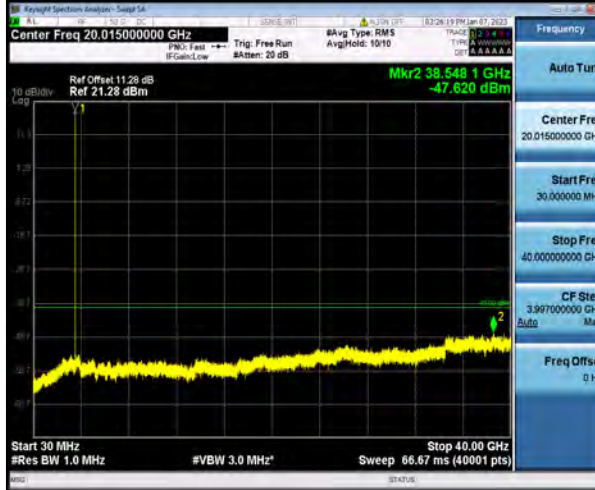

N48-10MHz-QPSK-641666-1RB#0-Range1:30~4000MHz

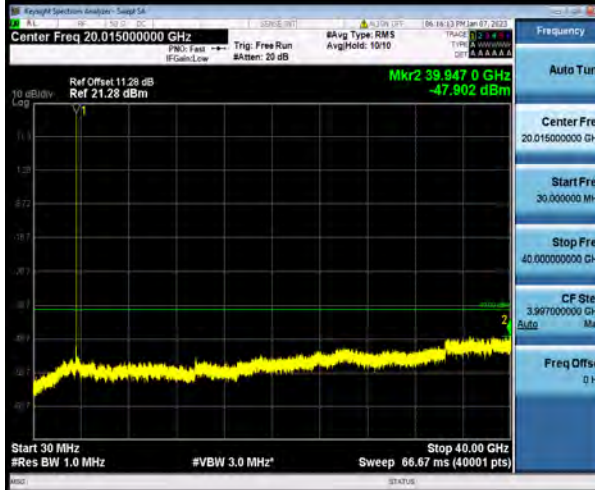

N48-10MHz-QPSK-646332-1RB#0-Range1:30~4000MHz



BUREAU VERITAS

Test Report No.: W7L-P23100014RF11

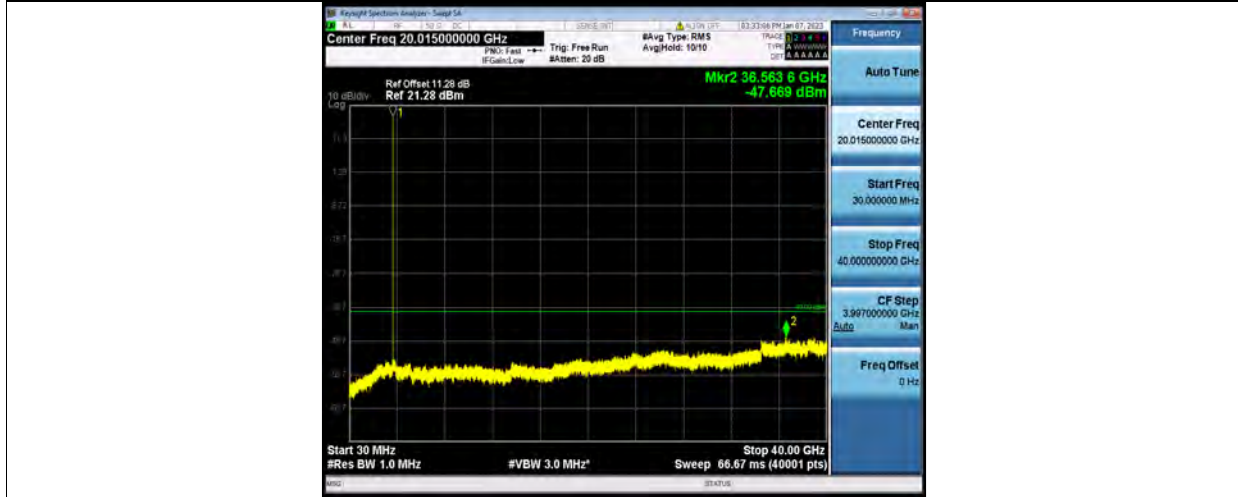

N48-20MHz-QPSK-637334-1RB#0-Range1:30~40000MHz

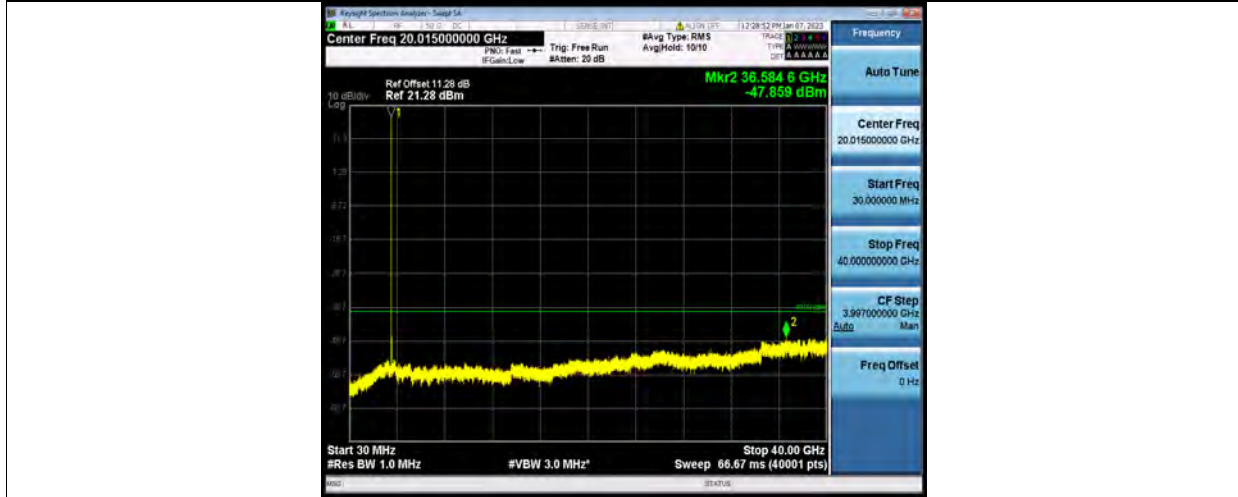

N48-20MHz-QPSK-641666-1RB#0-Range1:30~40000MHz



N48-20MHz-QPSK-646000-1RB#0-Range1:30~40000MHz

BV 7Layers Communications Technology (Shenzhen) Co., Ltd

No.B102, Dazu Chuangxin Mansion, North of Beihuan Avenue, North Area, Hi-Tech Industrial Park, Nanshan District, Shenzhen, Guangdong, China

Tel: +86 755 8869 6566
Fax: +86 755 8869 6577
Email: customerservice.sw@bureauveritas.com



BUREAU VERITAS

Test Report No.: W7L-P23100014RF11



N48-40MHz-QPSK-638000-1RB#0-Range1:30~40000MHz



N48-40MHz-QPSK-641666-1RB#0-Range1:30~40000MHz

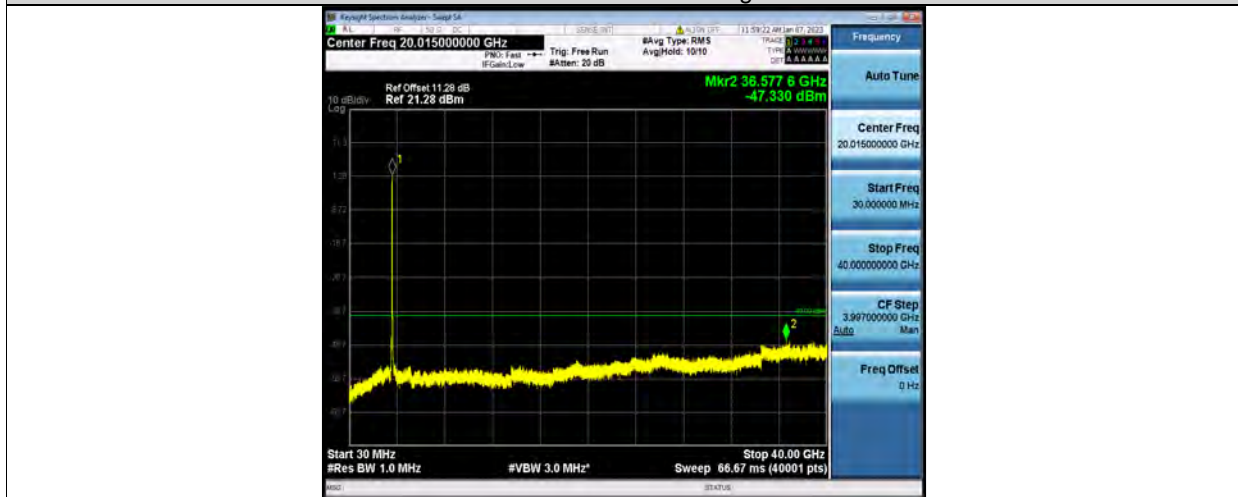

N48-40MHz-QPSK-645332-1RB#0-Range1:30~40000MHz



BUREAU
VERITAS

Test Report No.: W7L-P23100014RF11

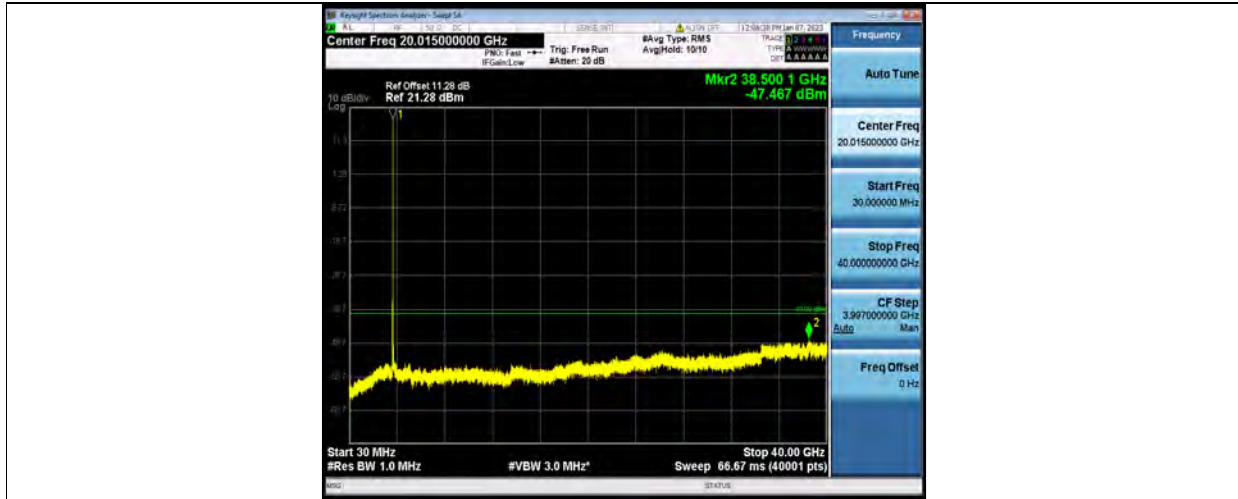

BV 7Layers Communications Technology
(Shenzhen) Co., Ltd

No.B102, Dazu Chuangxin Mansion, North of Beihuan
Avenue, North Area, Hi-Tech Industrial Park, Nanshan
District, Shenzhen, Guangdong, China

Tel: +86 755 8869 6566
Fax: +86 755 8869 6577
Email: customerservice.sw@bureauveritas.com



FREQUENCY STABILITY TEST RESULT

Voltage&Temperature										
Band	Bandwidth	Modulation	Channel	RB Configure	Voltage [Vdc]	Temperature (°C)	Deviation (Hz)	Deviation (ppm)	Limit (ppm)	Verdict
N48	20MHz	QPSK	641666	50RB#0	VL	NT	23.24	0.006412	±2.5	PASS
N48	20MHz	QPSK	641666	50RB#0	VN	NT	44.71	0.012334	±2.5	PASS
N48	20MHz	QPSK	641666	50RB#0	VH	NT	31.82	0.008779	±2.5	PASS
N48	20MHz	QPSK	641666	50RB#0	NV	-30	45.35	0.012512	±2.5	PASS
N48	20MHz	QPSK	641666	50RB#0	NV	-20	34.27	0.009454	±2.5	PASS
N48	20MHz	QPSK	641666	50RB#0	NV	0	49.80	0.013738	±2.5	PASS
N48	20MHz	QPSK	641666	50RB#0	NV	10	40.22	0.011095	±2.5	PASS
N48	20MHz	QPSK	641666	50RB#0	NV	20	42.59	0.011749	±2.5	PASS
N48	20MHz	QPSK	641666	50RB#0	NV	30	47.02	0.012971	±2.5	PASS
N48	20MHz	QPSK	641666	50RB#0	NV	40	21.05	0.005806	±2.5	PASS
N48	20MHz	QPSK	641666	50RB#0	NV	50	22.08	0.006090	±2.5	PASS

---END---