



# FCC TEST REPORT

**Test report  
On Behalf of  
GIVEITAWAY SLU  
For  
Rechargeable wireless mouse  
Model No.: GG-1725  
FCC ID: 2AVM8-GG1725**

**Prepared for :** GIVEITAWAY SLU  
RAMBLA PAISOS CATALANS, 8-1RA. PLANTA / PUERDA LADO IZQUIERDO,  
VILANOVA I LA GELTRU, BARCELONA, SPAIN

**Prepared By :** Shenzhen HUAKE Testing Technology Co., Ltd.  
1F, B2 Building, Junfeng Zhongcheng Zhizao Innovation Park, Fuhai Street,  
Bao'an District, Shenzhen City, China

**Date of Test:** Jan. 09, 2020 ~ Jan. 16, 2020

**Date of Report:** Jan. 16, 2020

**Report Number:** HK2001100138-E



### TEST RESULT CERTIFICATION

**Applicant's name** ..... : GIVEITAWAY SLU  
 Address ..... : RAMBLA PAISOS CATALANS, 8-1RA. PLANTA / PUERDA LADO IZQUIERDO, VILANOVA I LA GELTRU, BARCELONA, SPAIN  
**Manufacture's Name** ..... : SHENZHEN TALYTEC LIMITED  
 Address ..... : 4F JINLIHUA BUILDING, 31# BAO'AN DISCTRICT, SHENZHEN, CHINA

#### Product description

Trade Mark: N/A  
 Product name ..... : Rechargeable wireless mouse  
 Model and/or type reference : GG-1725

**Standards** ..... : FCC Rules and Regulations Part 15 Subpart C Section 15.249  
 ANSI C63.10: 2013

This publication may be reproduced in whole or in part for non-commercial purposes as long as the Shenzhen HUAKE Testing Technology Co., Ltd. is acknowledged as copyright owner and source of the material. Shenzhen HUAKE Testing Technology Co., Ltd. takes no responsibility for and will not assume liability for damages resulting from the reader's interpretation of the reproduced material due to its placement and context.

**Date of Test** ..... :  
 Date (s) of performance of tests ..... : Jan. 09, 2020 ~ Jan. 16, 2020  
 Date of Issue ..... : Jan. 16, 2020  
 Test Result ..... : **Pass**

Testing Engineer : 

(Gary Qian)

Technical Manager : 

(Eden Hu)

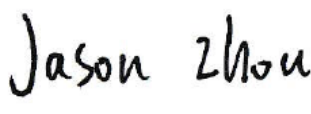
Authorized Signatory : 

(Jason Zhou)



<b>Table of Contents</b>	<b>Page</b>
1 . TEST SUMMARY	4
2 . GENERAL INFORMATION	5
2.1 GENERAL DESCRIPTION OF EUT	5
2.2 Carrier Frequency of Channels	6
2.3 Operation of EUT during testing	6
2.4 DESCRIPTION OF TEST SETUP	7
2.5 MEASUREMENT INSTRUMENTS LIST	8
3 . CONDUCTED EMISSIONS TEST	9
3.1 Conducted Power Line Emission Limit	9
3.2 Test Setup	9
3.3 Test Procedure	9
3.4 Test Result	9
4 RADIATED EMISSION TEST	12
4.1 Radiation Limit	12
4.2 Test Setup	12
4.3 Test Procedure	13
4.4 Test Result	13
5 BAND EDGE	19
5.1 Limits	19
5.2 Test Procedure	19
5.3 Test Result	20
6 OCCUPIED BANDWIDTH MEASUREMENT	22
6.1 Test Setup	22
6.2 Test Procedure	22
6.3 Measurement Equipment Used	22
6.4 Test Result	22
7 ANTENNA REQUIREMENT	24
8 PHOTOGRAPH OF TEST	25
8.1 Radiated Emission	25
8.2 Conducted Emission	26
9 PHOTOS OF THE EUT	27



## 1. TEST SUMMARY

### 1.1 TEST PROCEDURES AND RESULTS

FCC PART 15.249		
CONDUCTED EMISSIONS TEST	§15.207	PASS
RADIATED EMISSION TEST	§15.249 (a) (d)/ §15.209	PASS
out of Band Emissions	§15.249 (d)/ §15.205	PASS
OCCUPIED BANDWIDTH MEASUREMENT	§15.215 (c)	PASS
ANTENNA REQUIREMENT	§15.203	PASS

### 1.2 TEST FACILITY

Test Firm	:	Shenzhen HUAKE Testing Technology Co., Ltd.
Address	:	1F, B2 Building, Junfeng Zhongcheng Zhizao Innovation Park, Fuhai Street, Bao'an District, Shenzhen City, China

### 1.3 MEASUREMENT UNCERTAINTY

Measurement Uncertainty		
Conducted Emission Expanded Uncertainty	=	2.23dB, k=2
Radiated emission expanded uncertainty(9kHz-30MHz)	=	3.08dB, k=2
Radiated emission expanded uncertainty(30MHz-1000MHz)	=	4.42dB, k=2
Radiated emission expanded uncertainty(Above 1GHz)	=	4.06dB, k=2



## 2. GENERAL INFORMATION

### 2.1 GENERAL DESCRIPTION OF EUT

Equipment	Rechargeable wireless mouse
Model Name	GG-1725
Serial Model	N/A
Model Difference	N/A
FCC ID	2AVM8-GG1725
Antenna Type	PCB Antenna
Antenna Gain	0dBi
Equipment	Rechargeable wireless mouse
Operation frequency	2402-2480MHz
Number of Channels	79CH
Modulation Type	GFSK
Power Source	DC 5V from USB or DC 3.7V from battery
Power Rating	DC 5V from USB or DC 3.7V from battery



## 2.2 Carrier Frequency of Channels

Channel	Frequency (MHz)
00	2402
01	2403
⋮	⋮
38	2440
39	2441
40	2442
⋮	⋮
77	2479
78	2480

## 2.3 Operation of EUT during testing

### Operating Mode

The mode is used: **Transmitting mode**

Low Channel: 2402MHz

Middle Channel: 2440MHz

High Channel: 2480MHz



## 2.4 DESCRIPTION OF TEST SETUP

Operation of EUT during conducted testing and Radiation testing:

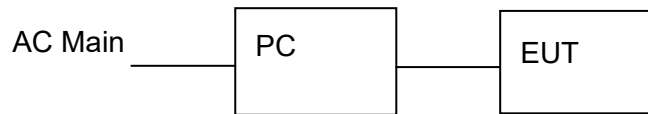

Operation of EUT Above 1GHz Radiation testing:



- PC information

Model: TP00067A

Input: AC120V~240V/60Hz

Output: 5VDC, 0.5A

The sample was placed (0.8m below 1GHz, 1.5m above 1GHz) above the ground plane of 3m chamber. Measurements in both horizontal and vertical polarities were performed. During the test, each emission was maximized by: having the EUT continuously working, investigated all operating modes, rotated about all 3 axis (X, Y & Z) and considered typical configuration to obtain worst position, manipulating interconnecting cables, rotating the turntable, varying antenna height from 1m to 4m in both horizontal and vertical polarizations. The emissions worst-case are shown in Test Results of the following pages. The worst case is X position.



## 2.5 MEASUREMENT INSTRUMENTS LIST

Item	Equipment	Manufacturer	Model No.	Serial No.	Last Cal.	Cal. Interval
1.	L.I.S.N. Artificial Mains Network	R&S	ENV216	HKE-002	Dec. 26, 2019	1 Year
2.	Receiver	R&S	ESCI 7	HKE-010	Dec. 26, 2019	1 Year
3.	RF automatic control unit	Tonscend	JS0806-2	HKE-060	Dec. 26, 2019	1 Year
4.	Spectrum analyzer	R&S	FSP40	HKE-025	Dec. 26, 2019	1 Year
5.	Spectrum analyzer	Agilent	N9020A	HKE-048	Dec. 26, 2019	1 Year
6.	Preamplifier	Schwarzbeck	BBV 9743	HKE-006	Dec. 26, 2019	1 Year
7.	EMI Test Receiver	Rohde & Schwarz	ESCI 7	HKE-010	Dec. 26, 2019	1 Year
8.	Bilog Broadband Antenna	Schwarzbeck	VULB9163	HKE-012	Dec. 26, 2019	1 Year
9.	Loop Antenna	Schwarzbeck	FMZB 1519 B	HKE-014	Dec. 26, 2019	1 Year
10.	Horn Antenna	Schwarzbeck	9120D	HKE-013	Dec. 26, 2019	1 Year
11.	Pre-amplifier	EMCI	EMC051845S E	HKE-015	Dec. 26, 2019	1 Year
12.	Pre-amplifier	Agilent	83051A	HKE-016	Dec. 26, 2019	1 Year
13.	EMI Test Software EZ-EMC	Tonscend	JY3120-B Version	HKE-083	Dec. 26, 2019	N/A
14.	Power Sensor	Agilent	E9300A	HKE-086	Dec. 26, 2019	1 Year
15.	Spectrum analyzer	Agilent	N9020A	HKE-048	Dec. 26, 2019	1 Year
16.	Signal generator	Agilent	N5182A	HKE-029	Dec. 26, 2019	1 Year
17.	Signal Generator	Agilent	83630A	HKE-028	Dec. 26, 2019	1 Year
18.	Shielded room	Shiel Hong	4*3*3	HKE-039	Dec. 26, 2019	1 Year
19.	Hight gain antenna	Schwarzbeck	LB-180400KF	HKE-054	Dec. 26, 2019	1 Year





### 3. CONDUCTED EMISSIONS TEST

#### 3.1 Conducted Power Line Emission Limit

For unintentional device, according to § 15.107(a) Line Conducted Emission Limits is as following

Frequency (MHz)	Maximum RF Line Voltage (dB $\mu$ V)			
	CLASS A		CLASS B	
	Q.P.	Ave.	Q.P.	Ave.
0.15 - 0.50	79	66	66-56*	56-46*
0.50 - 5.00	73	60	56	46
5.00 - 30.0	73	60	60	50

\* Decreasing linearly with the logarithm of the frequency

For intentional device, according to §15.207(a) Line Conducted Emission Limit is same as above table.

#### 3.2 Test Setup

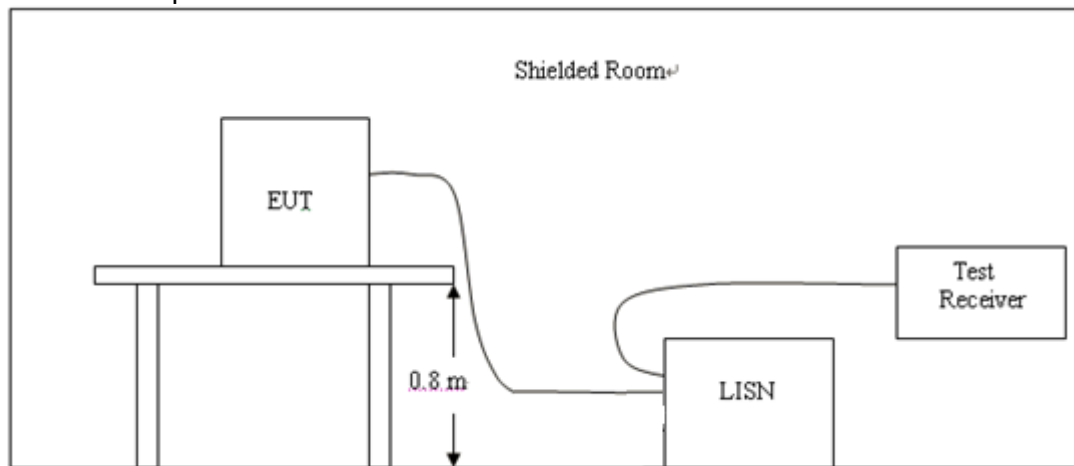

#### 3.3 Test Procedure

- 1, The equipment was set up as per the test configuration to simulate typical actual usage per the user's manual. The EUT is a tabletop system, a wooden table with a height of 0.8 meters is used and is placed on the ground plane as per ANSI C63.10.
- 2, Support equipment, if needed, was placed as per ANSI C63.10.
- 3, All I/O cables were positioned to simulate typical actual usage as per ANSI C63.10.
- 4, If a EUT received DC power from the USB Port of Notebook PC, the PC's adapter received AC120V/60Hz power through a Line Impedance Stabilization Network (LISN) which supplied power source and was grounded to the ground plane.
- 5, All support equipments received AC power from a second LISN, if any.
- 6, The EUT test program was started. Emissions were measured on each current carrying line of the EUT using a spectrum Analyzer / Receiver connected to the LISN powering the EUT. The LISN has two monitoring points: Line 1 (Hot Side) and Line 2 (Neutral Side). Two scans were taken: one with Line 1 connected to Analyzer / Receiver and Line 2 connected to a 50 ohm load; the second scan had Line 1 connected to a 50 ohm load and Line 2 connected to the Analyzer / Receiver.
- 7, Analyzer / Receiver scanned from 150 KHz to 30MHz for emissions in each of the test modes.

#### 3.4 Test Result

PASS

All the test modes completed for test. only the worst result of of AC240V/60Hz (GFSK High Channel ) was reported as below:



Test Specification: Line

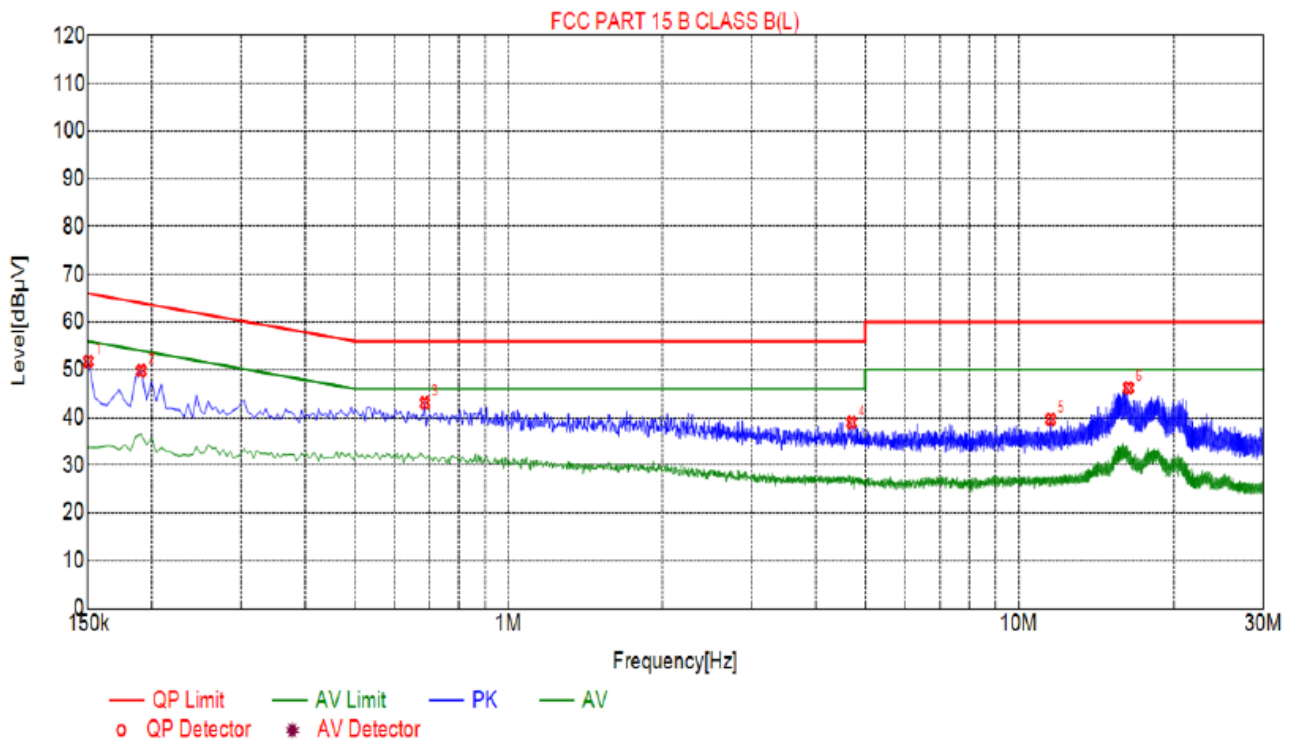

Suspected List								
NO.	Freq. [MHz]	Level [dBµV]	Factor [dB]	Limit [dBµV]	Margin [dB]	Reading [dBµV]	Detector	Type
1	0.1500	51.78	10.03	66.00	14.22	41.75	PK	L
2	0.1905	49.81	10.04	64.01	14.20	39.77	PK	L
3	0.6855	43.06	10.05	56.00	12.94	33.01	PK	L
4	4.7040	38.94	10.26	56.00	17.06	28.68	PK	L
5	11.5575	39.62	10.00	60.00	20.38	29.62	PK	L
6	16.3140	46.21	9.98	60.00	13.79	36.23	PK	L

Remark: Margin = Limit – Level

Correction factor = Cable lose + LISN insertion loss

Level=Test receiver reading + correction factor



Test Specification: Neutral

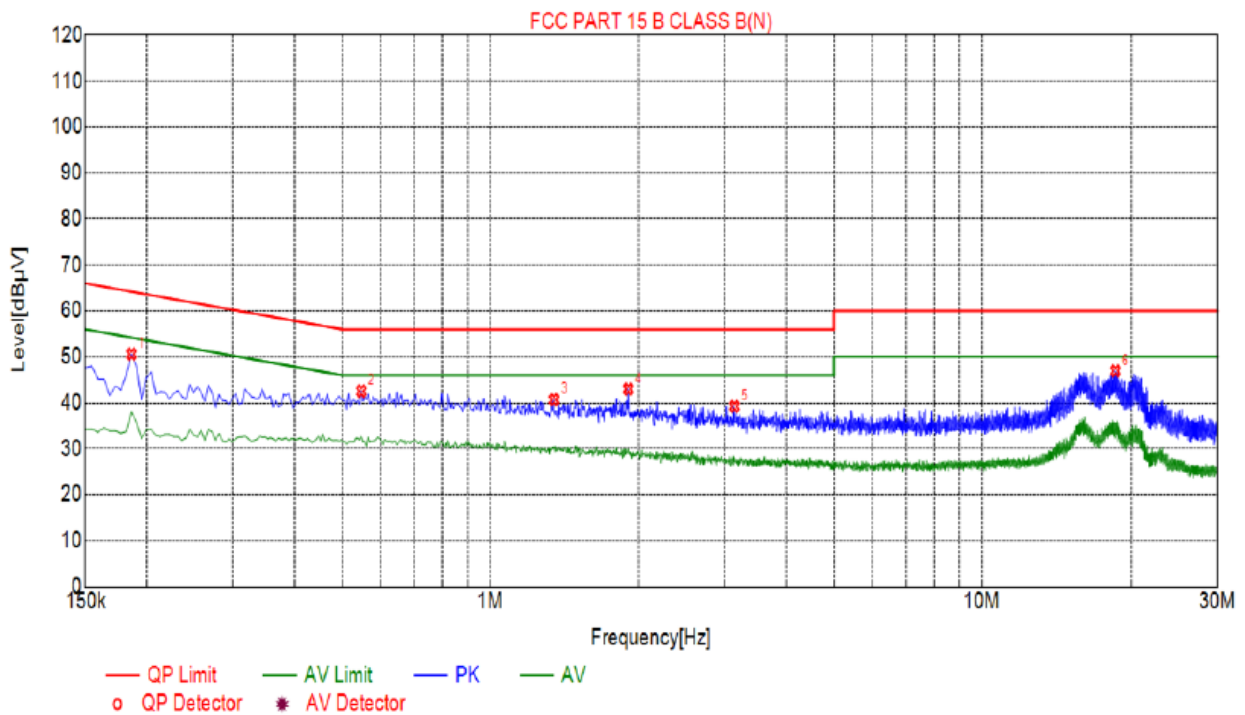

Suspected List								
NO.	Freq. [MHz]	Level [dBµV]	Factor [dB]	Limit [dBµV]	Margin [dB]	Reading [dBµV]	Detector	Type
1	0.1860	50.61	10.05	64.21	13.60	40.56	PK	N
2	0.5460	42.55	10.06	56.00	13.45	32.49	PK	N
3	1.3470	40.69	10.10	56.00	15.31	30.59	PK	N
4	1.9095	42.99	10.14	56.00	13.01	32.85	PK	N
5	3.1380	39.23	10.23	56.00	16.77	29.00	PK	N
6	18.5910	46.96	10.05	60.00	13.04	36.91	PK	N

Remark: Margin = Limit – Level

Correction factor = Cable lose + LISN insertion loss

Level=Test receiver reading + correction factor

## 4 RADIATED EMISSION TEST

### 4.1 Radiation Limit

For unintentional device, according to § 15.109(a), except for Class A digital devices, the field strength of radiated emissions from unintentional radiators at a distance of 3 meters shall not exceed the following values:

Frequency (MHz)	Distance (Meters)	Radiated (dB $\mu$ V/m)	Radiated ( $\mu$ V/m)
0.009-0.490	300	20log 2400/F (kHz)	2400/F (kHz)
0.490-1.705	30	20log 24000/F (kHz)	24000/F (kHz)
1.705-30	30	20log 30	30
30-88	3	40	100
88-216	3	43.5	150
216-960	3	46	200
Above 960	3	54	500

For intentional device, according to § 15.209(a), the general requirement of field strength of radiated emissions from intentional radiators at a distance of 3 meters shall not exceed the above table.

### 4.2 Test Setup

#### (1) Radiated Emission Test-Up Frequency Below 30MHz

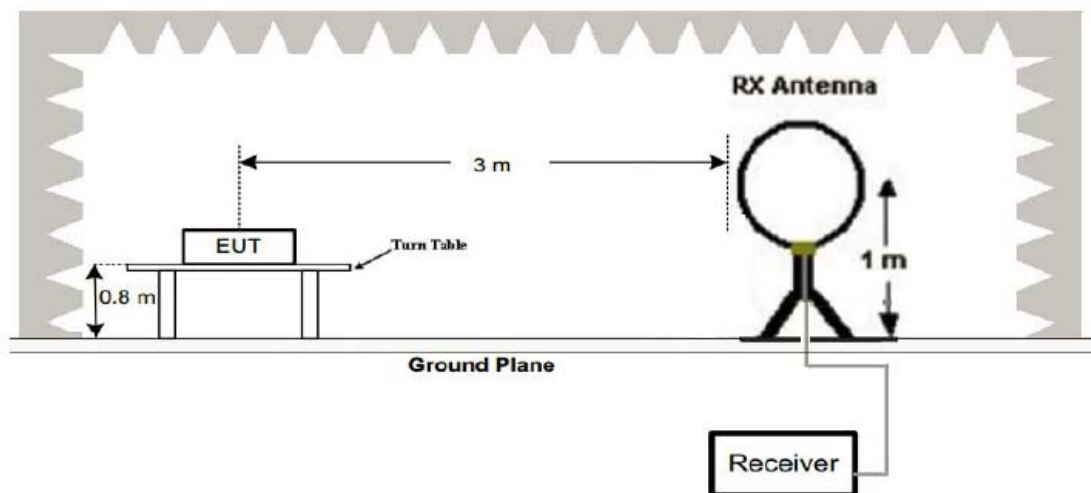

#### (2) Radiated Emission Test-Up Frequency 30MHz~1GHz

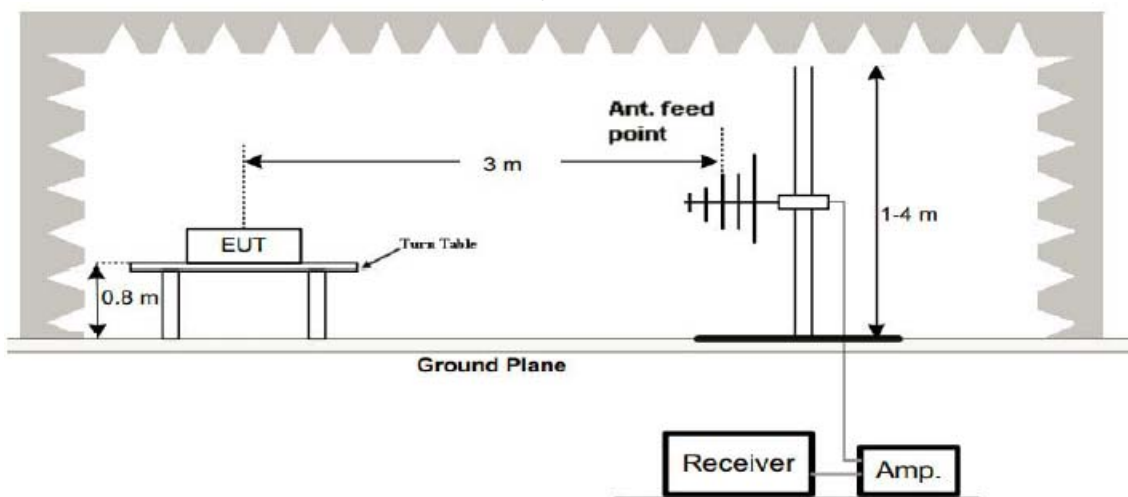

### (3) Radiated Emission Test-Up Frequency Above 1GHz

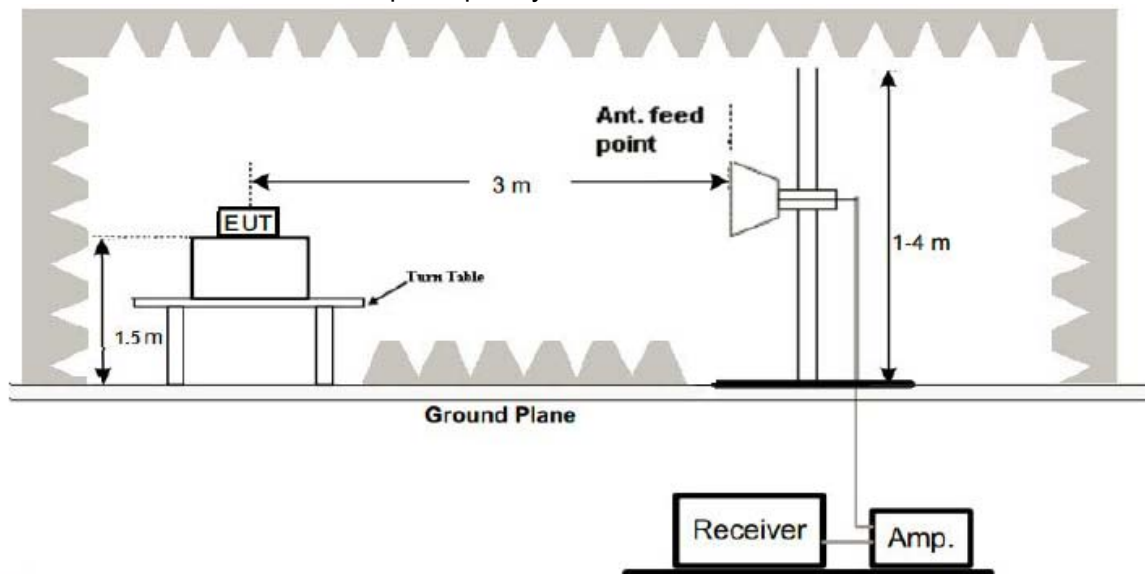

#### 4.3 Test Procedure

1. Below 1GHz measurement the EUT is placed on turntable which is 0.8m above ground plane. And above 1GHz measurement EUT was placed on low permittivity and low tangent turn table which is 1.5m above ground plane.
2. The turntable shall be rotated for 360 degrees to determine the position of maximum emission level.
3. EUT is set 3m away from the receiving antenna, which is varied from 1m to 4m to find out the highest emissions.
4. Maximum procedure was performed on the six highest emissions to ensure EUT compliance.
5. And also, each emission was to be maximized by changing the polarization of receiving antenna both horizontal and vertical.
6. Repeat above procedures until the measurements for all frequencies are complete.
7. The test frequency range from 9KHz to 25GHz per FCC PART 15.33(a).

#### Note:

For battery operated equipment, the equipment tests shall be performed using a new battery.

#### 4.4 Test Result

##### PASS

All the test modes completed for test. The worst case of Radiated Emission is CH 2402; the test data of this mode was reported.



Below 1GHz Test Results:

Antenna polarity: H

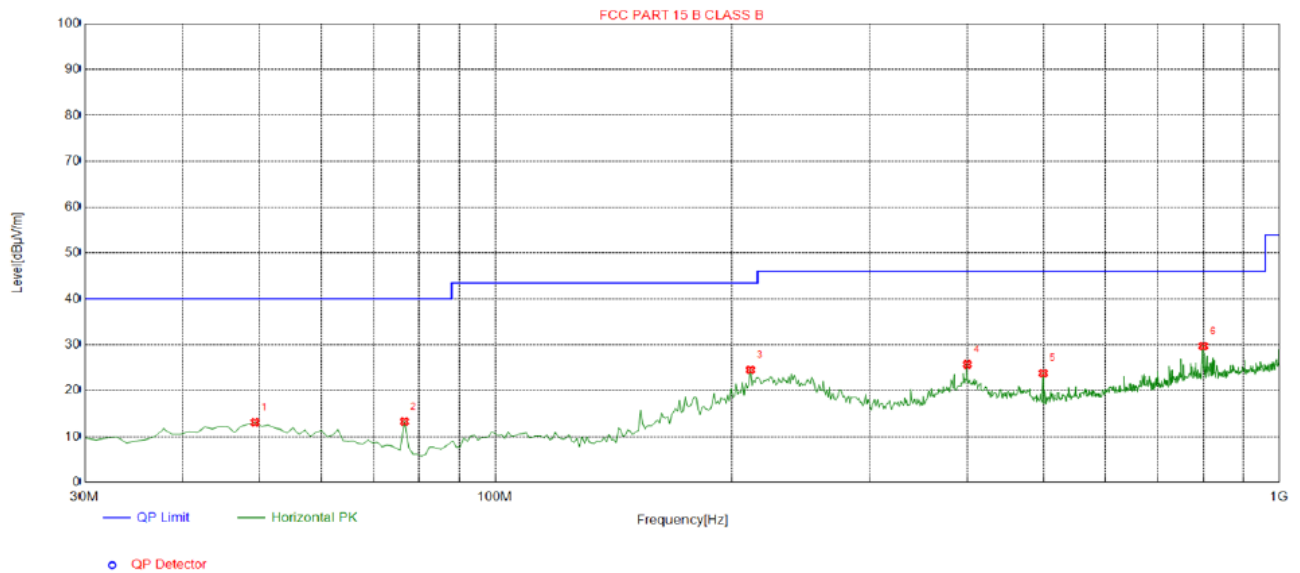

Suspected List									
NO.	Freq. [MHz]	Factor [dB]	Reading [dBµV/m]	Level [dBµV/m]	Limit [dBµV/m]	Margin [dB]	Height [cm]	Angle [°]	Polarity
1	49.4194	-13.65	26.71	13.06	40.00	26.94	100	271	Horizontal
2	76.6066	-18.86	32.10	13.24	40.00	26.76	100	29	Horizontal
3	211.5716	-14.76	39.27	24.51	43.50	18.99	100	274	Horizontal
4	399.9399	-10.41	36.13	25.72	46.00	20.28	100	150	Horizontal
5	499.9500	-8.30	32.10	23.80	46.00	22.20	100	15	Horizontal
6	799.9800	-3.12	32.85	29.73	46.00	16.27	100	50	Horizontal

Remark: Factor = Cable loss + Antenna factor – Preamplifier; Level = Reading + Factor; Margin = Limit – Level



Antenna polarity: V

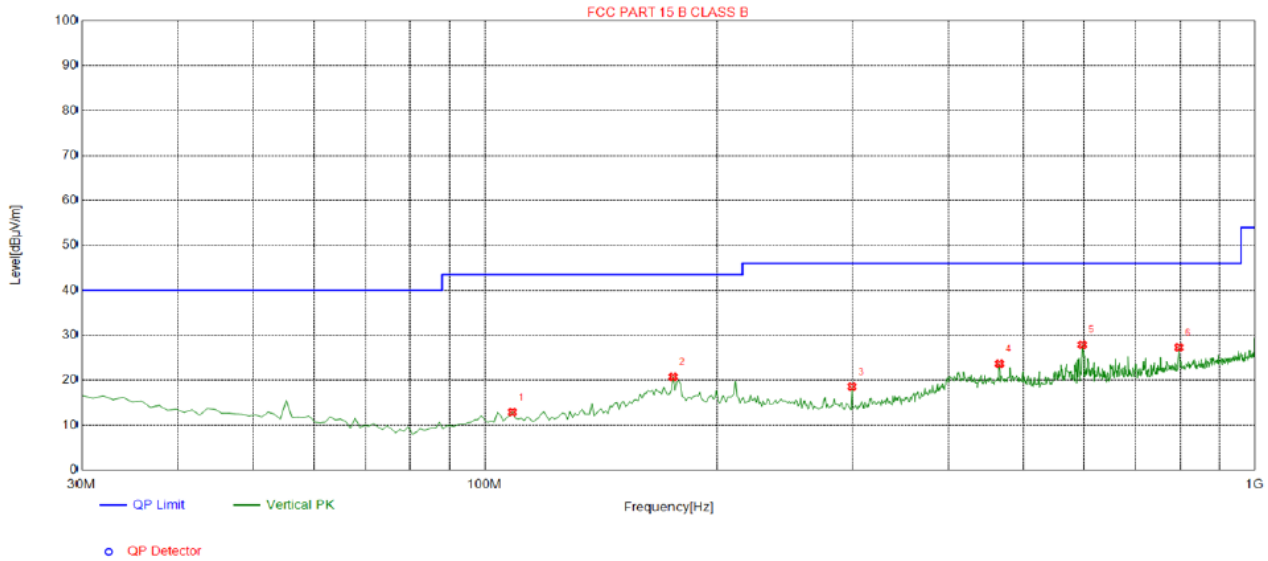

Suspected List									
NO.	Freq. [MHz]	Factor [dB]	Reading [dBµV/m]	Level [dBµV/m]	Limit [dBµV/m]	Margin [dB]	Height [cm]	Angle [°]	Polarity
1	108.6486	-15.43	28.31	12.88	43.50	30.62	100	186	Vertical
2	175.6456	-17.05	37.79	20.74	43.50	22.76	100	326	Vertical
3	299.9299	-12.74	31.29	18.55	46.00	27.45	100	311	Vertical
4	465.9660	-8.47	32.13	23.66	46.00	22.34	100	338	Vertical
5	597.0470	-6.31	34.20	27.89	46.00	18.11	100	326	Vertical
6	797.0671	-3.16	30.44	27.28	46.00	18.72	100	102	Vertical

Remark: Factor = Cable loss + Antenna factor – Preamplifier; Level = Reading + Factor; Margin = Limit – Level  
 Remark:

- (1) Measuring frequencies from 9 KHz to the 1 GHz, Radiated emission test from 9KHz to 30MHz was verified, and no any emission was found except system noise floor.
- (2) \* denotes emission frequency which appearing within the Restricted Bands specified in provision of 15.205, then the general radiated emission limits in 15.209 apply.
- (3) The IF bandwidth of EMI Test Receiver between 30MHz to 1GHz was 120KHz, 1 MHz for measuring above 1 GHz, below 30MHz was 10KHz.

### Harmonics and Spurious Emissions

#### Frequency Range (9K-30MHz)

Frequency (MHz)	Level@3m (dBµV/m)	Limit@3m (dBµV/m)
--	--	--
--	--	--
--	--	--
--	--	--

**Note:** 1. Emission Level=Reading+ Cable loss+ Antenna factor-Amp factor

2. The emission levels are 20 dB below the limit value, which are not reported. It is deemed to comply with the requirement



Above 1 GHz Test Results:  
CH Low (2402MHz)

Horizontal:

Frequency	Meter Reading	Factor	Emission Level	Limits	Margin	Detector Type
(MHz)	(dB $\mu$ V)	(dB)	(dB $\mu$ V/m)	(dB $\mu$ V/m)	(dB)	
2402	108.12	-5.84	102.28	114	-11.72	peak
2402	87.33	-5.84	81.49	94	-12.51	AVG
4804	59.17	-3.64	55.53	74	-18.47	peak
4804	47.88	-3.64	44.24	54	-9.76	AVG
7206	55.62	-0.95	54.67	74	-19.33	peak
7206	44.03	-0.95	43.08	54	-10.92	AVG

Remark: Factor = Antenna Factor + Cable Loss – Pre-amplifier.

Vertical:

Frequency	Meter Reading	Factor	Emission Level	Limits	Margin	Detector Type
(MHz)	(dB $\mu$ V)	(dB)	(dB $\mu$ V/m)	(dB $\mu$ V/m)	(dB)	
2402	111.98	-5.84	106.14	114	-7.86	peak
2402	83.62	-5.84	77.78	94	-16.22	AVG
4804	57.49	-3.64	53.85	74	-20.15	peak
4804	46.25	-3.64	42.61	54	-11.39	AVG
7206	55.30	-0.95	54.35	74	-19.65	peak
7206	42.33	-0.95	41.38	54	-12.62	AVG

Remark: Factor = Antenna Factor + Cable Loss – Pre-amplifier.





## CH Middle (2440MHz)

## Horizontal:

Frequency	Meter Reading	Factor	Emission Level	Limits	Margin	Detector Type
(MHz)	(dB $\mu$ V)	(dB)	(dB $\mu$ V/m)	(dB $\mu$ V/m)	(dB)	
2440	108.67	-5.71	102.96	114	-11.04	peak
2440	80.34	-5.71	74.63	94	-19.37	AVG
4880	56.00	-3.51	52.49	74	-21.51	peak
4880	46.87	-3.51	43.36	54	-10.64	AVG
7320	57.38	-0.82	56.56	74	-17.44	peak
7320	42.96	-0.82	42.14	54	-11.86	AVG

Remark: Factor = Antenna Factor + Cable Loss – Pre-amplifier.

## Vertical:

Frequency	Meter Reading	Factor	Emission Level	Limits	Margin	Detector Type
(MHz)	(dB $\mu$ V)	(dB)	(dB $\mu$ V/m)	(dB $\mu$ V/m)	(dB)	
2440	104.68	-5.71	98.97	114	-15.03	peak
2440	84.32	-5.71	78.61	94	-15.39	AVG
4880	56.98	-3.51	53.47	74	-20.53	peak
4880	47.26	-3.51	43.75	54	-10.25	AVG
7320	55.38	-0.82	54.56	74	-19.44	peak
7320	42.66	-0.82	41.84	54	-12.16	AVG

Remark: Factor = Antenna Factor + Cable Loss – Pre-amplifier.



## CH High (2480MHz)

Horizontal:

Frequency	Meter Reading	Factor	Emission Level	Limits	Margin	Detector Type
(MHz)	(dB $\mu$ V)	(dB)	(dB $\mu$ V/m)	(dB $\mu$ V/m)	(dB)	
2480	105.68	-5.65	100.03	114	-13.97	peak
2480	82.34	-5.65	76.69	94	-17.31	AVG
4960	55.19	-3.43	51.76	74	-22.24	peak
4960	45.38	-3.43	41.95	54	-12.05	AVG
7440	55.84	-0.75	55.09	74	-18.91	peak
7440	41.35	-0.75	40.6	54	-13.4	AVG

Remark: Factor = Antenna Factor + Cable Loss – Pre-amplifier.

Vertical:

Frequency	Meter Reading	Factor	Emission Level	Limits	Margin	Detector Type
(MHz)	(dB $\mu$ V)	(dB)	(dB $\mu$ V/m)	(dB $\mu$ V/m)	(dB)	
2480	105.62	-5.65	99.97	114	-14.03	peak
2480	82.32	-5.65	76.67	94	-17.33	AVG
4960	55.16	-3.43	51.73	74	-22.27	peak
4960	45.87	-3.43	42.44	54	-11.56	AVG
7440	56.09	-0.75	55.34	74	-18.66	peak
7440	39.11	-0.75	38.36	54	-15.64	AVG

Remark: Factor = Antenna Factor + Cable Loss – Pre-amplifier.

Remark :

- (1) Measuring frequencies from 1 GHz to the 25 GHz.
- (2) "F" denotes fundamental frequency; "H" denotes spurious frequency. "E" denotes band edge frequency.
- (3) \* denotes emission frequency which appearing within the Restricted Bands specified in provision of 15.205, then the general radiated emission limits in 15.209 apply.
- (4) The emissions are attenuated more than 20dB below the permissible limits are not record in the report.
- (5) The IF bandwidth of EMI Test Receiver between 30MHz to 1GHz was 120KHz, 1 MHz for measuring above 1 GHz, below 30MHz was 10KHz. The resolution bandwidth of test receiver/spectrum analyzer is 1MHz and video bandwidth is 3MHz for peak measurement with peak detector at frequency above 1GHz. The resolution bandwidth of test receiver/spectrum analyzer is 1MHz and video bandwidth is 10Hz for Average measurement with peak detection at frequency above 1GHz.
- (6) When the test results of Peak Detected below the limits of Average Detected, the Average Detected is not need completed. For example: Top Channel at Fundamental 73.16dBuV/m(PK Value) <93.98(AV Limit), at harmonic 53.20 dBuV/m(PK Value) <54 dBuV/m(AV Limit), the Average Detected not need to completed.
- (7) All modes of operation were investigated and the worst-case emissions are reported.



## 5 BAND EDGE

### 5.1 Limits

FCC PART 15.249(d) Emissions radiated outside of the specified frequency bands, except for harmonics, shall be attenuated by at least 50 dB below the level of the fundamental or to the general radiated emission limits in §15.209, whichever is the lesser attenuation.

### 5.2 Test Procedure

The band edge compliance of RF radiated emission should be measured by following the guidance in ANSI C63.10 with respect to maximizing the emission by rotating the EUT, measuring the emission while the EUT is situated in three orthogonal planes (if appropriate), adjusting the measurement antenna height and polarization etc. Set RBW to 100KHz and VBM to 300KHz to measure the peak field strength and set RBW to 1MHz and VBW to 10Hz to measure the average radiated field strength. The conducted RF band edge was measured by using a spectrum analyzer. Set span wide enough to capture the highest in-band emission and the emission at the band edge. Set RBW to 100 KHz and VBW to 300 KHz, to measure the conducted peak band edge.



## 5.3 Test Result

**PASS**

Radiated Band Edge Test:

Operation Mode: TX CH Low (2402MHz)

Horizontal (Worst case)

Frequency (MHz)	Meter Reading (dB $\mu$ V)	Factor (dB)	Emission Level (dB $\mu$ V/m)	Limits (dB $\mu$ V/m)	Margin (dB)	Detector Type
2310	58.26	-5.81	52.45	74	-21.55	peak
2310	/	-5.81	/	54	/	AVG
2390	52.68	-5.84	46.84	74	-27.16	peak
2390	/	-5.84	/	54	/	AVG
2400	51.88	-5.84	46.04	74	-27.96	peak
2400	/	-5.84	/	54	/	AVG

Remark: Factor = Antenna Factor + Cable Loss – Pre-amplifier.

Vertical:

Frequency (MHz)	Meter Reading (dB $\mu$ V)	Factor (dB)	Emission Level (dB $\mu$ V/m)	Limits (dB $\mu$ V/m)	Margin (dB)	Detector Type
2310	55.32	-5.81	49.51	74	-24.49	peak
2310	/	-5.81	/	54	/	AVG
2390	52.48	-5.84	46.64	74	-27.36	peak
2390	/	-5.84	/	54	/	AVG
2400	55.62	-5.84	49.78	74	-24.22	peak
2400	/	-5.84	/	54	/	AVG

Remark: Factor = Antenna Factor + Cable Loss – Pre-amplifier.



Operation Mode: TX CH High (2480MHz)

Horizontal (Worst case)

Frequency	Reading Result	Factor	Emission Level	Limits	Margin	Detector Type
(MHz)	(dB $\mu$ V)	(dB)	(dB $\mu$ V/m)	(dB $\mu$ V/m)	(dB)	
2483.50	56.18	-5.65	50.53	74	-23.47	peak
2483.50	/	-5.65	/	54	/	AVG
2500.00	53.64	-5.65	47.99	74	-26.01	peak
2500.00	/	-5.65	/	54	/	AVG

Remark: Factor = Antenna Factor + Cable Loss – Pre-amplifier.

Vertical:

Frequency	Reading Result	Factor	Emission Level	Limits	Margin	Detector Type
(MHz)	(dB $\mu$ V)	(dB)	(dB $\mu$ V/m)	(dB $\mu$ V/m)	(dB)	
2483.50	56.87	-5.65	51.22	74	-22.78	peak
2483.50	/	-5.65	/	54	/	AVG
2500.00	52.66	-5.65	47.01	74	-26.99	peak
2500.00	/	-5.65	/	54	/	AVG

Remark: Factor = Antenna Factor + Cable Loss – Pre-amplifier.

Remark: All the other emissions not reported were too low to read and deemed to comply with FCC limit.



## 6 OCCUPIED BANDWIDTH MEASUREMENT

### 6.1 Test Setup

Same as Radiated Emission Measurement

### 6.2 Test Procedure

1. The EUT was placed on a turn table which is 0.8m above ground plane.
2. Set EUT as normal operation.
3. Based on ANSI C63.10 section 6.9.2: RBW= 30KHz. VBW= 100 KHz, Span=1MHz.
4. The useful radiated emission from the EUT was detected by the spectrum analyser with peak detector.

### 6.3 Measurement Equipment Used

Same as Radiated Emission Measurement

### 6.4 Test Result

**PASS**

Frequency	20dB Bandwidth (MHz)	Result
2402 MHz	1.217	<b>PASS</b>
2440 MHz	1.206	<b>PASS</b>
2480 MHz	1.201	<b>PASS</b>

CH: 2402MHz





CH: 2440MHz

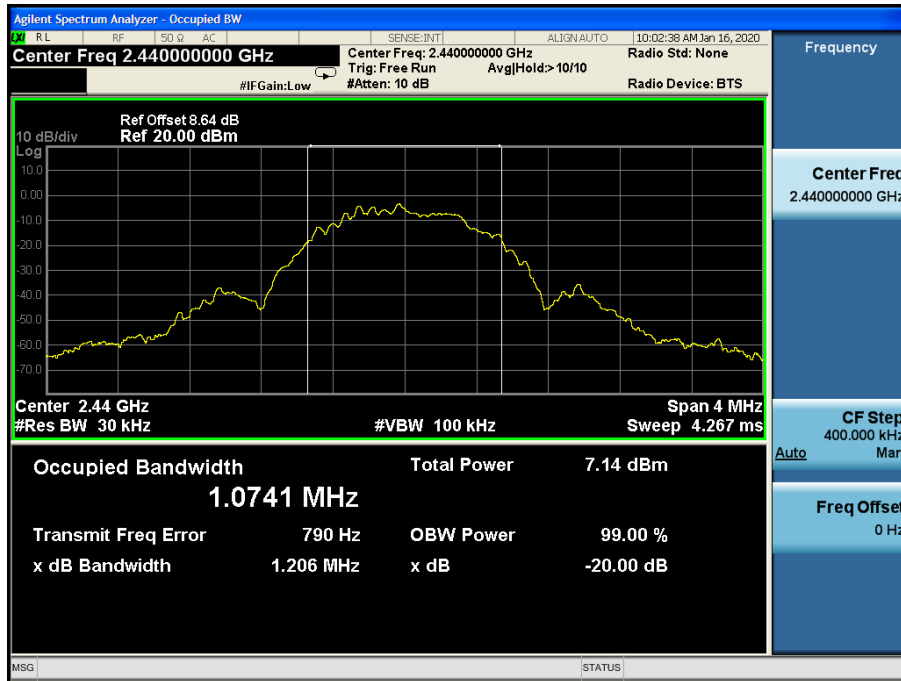

CH: 2480MHz

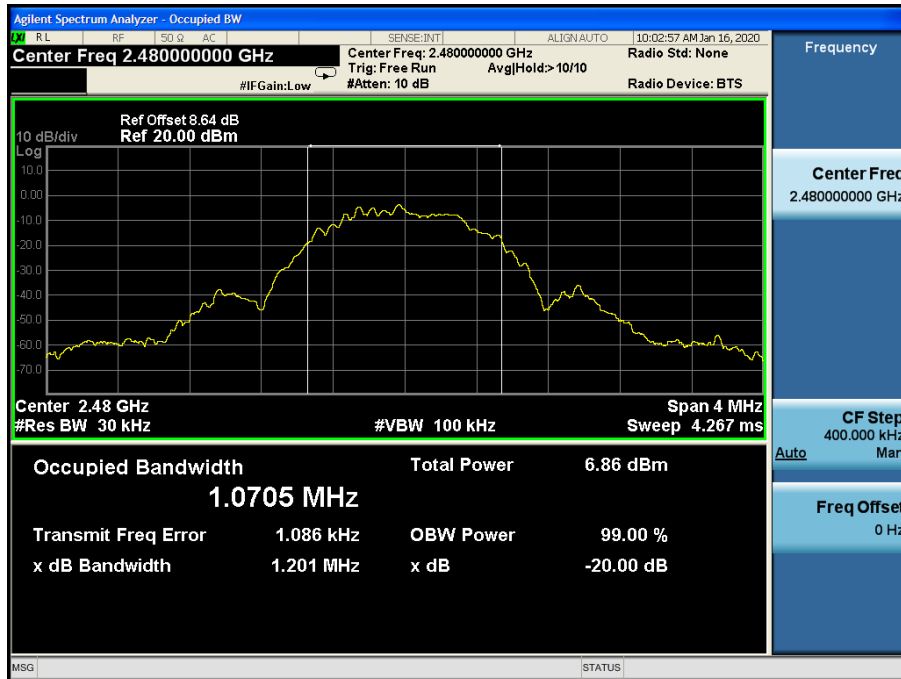

## 7 ANTENNA REQUIREMENT

### Standard Applicable

For intentional device, according to FCC 47 CFR Section 15.203, an intentional radiator shall be designed to ensure that no antenna other than that furnished by the responsible party shall be used with the device.

### Antenna Connected Construction

The antenna used in this product is a PCB Antenna, The directional gains of antenna used for transmitting is 0dBi.

ANTENNA

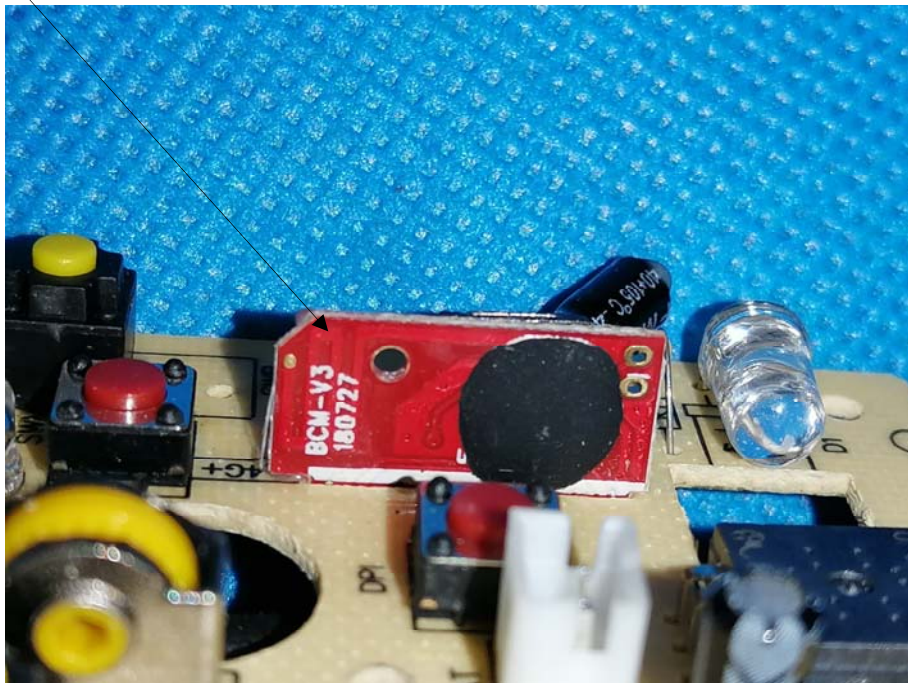



## 8 PHOTOGRAPH OF TEST

### 8.1 Radiated Emission





## 8.2 Conducted Emission





## 9 PHOTOS OF THE EUT

Reference to the reporter : ANNEX A of external photos and ANNEX B of internal photos

-----End of test report-----