

FCC Part 15C Test Report

FCC ID: 2AVLZ-PESDEYE-G

| | |
|-------------------------|--|
| Product Name: | Rechargeable Soundwear Eye Mask |
| Trademark: | N/A |
| Model Name : | PESDEYE-G |
| Prepared For : | Bear Down Brands LLC |
| Address : | 14505 Astronautics Lane Huntington Beach, CA 92647 |
| Prepared By : | Shenzhen BCTC Testing Co., Ltd. |
| Address : | BCTC Building & 1-2F, East of B Building, Pengzhou Industrial, Fuyuan 1st Road, Qiaotou Community, Fuyong Street, Bao'an District, Shenzhen, China |
| Test Date: | Dec. 17, 2019 – Dec. 26, 2019 |
| Date of Report : | Dec. 26, 2019 |
| Report No.: | BCTC1912001526E |

TEST RESULT CERTIFICATION

Applicant's name: Bear Down Brands LLC
Address.....: 14505 Astronautics Lane Huntington Beach, CA 92647
Manufacturer's Name: Dongguan Taishin Electronic CO., Ltd
Address.....: Building E, Dadi Industrial Park, Chukeng, Dongkeng,
Dongguan, China

Product description

Product name.....: Rechargeable Soundwear Eye Mask
Trademark: N/A
Model and/or type reference: PESDEYE-G

Standards: FCC Part15.247
ANSI C63.10:2013

This device described above has been tested by BCTC, and the test results show that the equipment under test (EUT) is in compliance with the FCC requirements. And it is applicable only to the tested sample identified in the report.

This report shall not be reproduced except in full, without the written approval of BCTC, this document may be altered or revised by BCTC, personal only, and shall be noted in the revision of the document.

Prepared by(Engineer): Willem Wang

Willem Wang

Reviewer(Supervisor): Eric Yang

Eric Yang

Approved(Manager): Zero Zhou

Zero Zhou



Table of Contents

| Test Report Declaration | Page |
|---|------|
| 1. TEST SUMMARY | 5 |
| 2. TEST FACILITY | 6 |
| 3. MEASUREMENT UNCERTAINTY | 6 |
| 4. GENERAL INFORMATION | 7 |
| 4.1 GENERAL DESCRIPTION OF EUT | 7 |
| 4.2 Test Setup Configuration | 8 |
| 4.3 Support Equipment | 8 |
| 4.4 Channel List | 9 |
| 4.5 Test Mode | 10 |
| 5. TEST FACILITY AND TEST INSTRUMENT USED | 11 |
| 5.1 Test Facility | 11 |
| 5.2 Test Instrument Used | 11 |
| 6. CONDUCTED EMISSIONS | 13 |
| 6.1 Block Diagram Of Test Setup | 13 |
| 6.2 Limit | 13 |
| 6.3 Test procedure | 13 |
| 6.4 Test Result | 15 |
| 7. RADIATED EMISSIONS | 17 |
| 7.1 Block Diagram Of Test Setup | 17 |
| 7.2 Limit | 18 |
| 7.3 Test procedure | 18 |
| 7.4 Test Result | 20 |
| 7.5 RADIATED BAND EMISSION MEASUREMENT AND RESTRICTED BANDS OF OPERATION | 24 |
| 8. CONDUCTED EMISSION | 27 |
| 8.1 Block Diagram Of Test Setup | 27 |
| 8.2 Limit | 27 |
| 8.3 Test procedure | 27 |
| 8.4 Test Result | 28 |
| 9. 20 DB BANDWIDTH | 37 |
| 9.1 Block Diagram Of Test Setup | 37 |
| 9.2 Limit | 37 |
| 9.3 Test procedure | 37 |
| 9.4 Test Result | 38 |
| 10. MAXIMUM PEAK OUTPUT POWER | 43 |
| 10.1 Block Diagram Of Test Setup | 43 |
| 10.2 Limit | 43 |
| 10.3 Test procedure | 43 |
| 10.4 Test Result | 44 |
| 11. HOPPING CHANNEL SEPARATION | 49 |
| 11.1 Block Diagram Of Test Setup | 49 |

| | | |
|------------|--|-----------|
| 11.2 | Limit | 49 |
| 11.3 | Test procedure | 49 |
| 11.4 | Test Result | 50 |
| 12. | NUMBER OF HOPPING FREQUENCY | 55 |
| 12.1 | Block Diagram Of Test Setup | 55 |
| 12.2 | Limit | 55 |
| 12.3 | Test procedure | 55 |
| 12.4 | Test Result | 56 |
| 13. | DWELL TIME | 58 |
| 13.1 | Block Diagram Of Test Setup | 58 |
| 13.2 | Limit | 58 |
| 13.3 | Test procedure | 58 |
| 13.4 | Test Result | 59 |
| 14. | ANTENNA REQUIREMENT | 65 |
| 15. | EUT PHOTOGRAPHS | 66 |
| 16. | EUT TEST SETUP PHOTOGRAPHS | 68 |

(Note: N/A means not applicable)

1. TEST SUMMARY

Test procedures according to the technical standards:

| FCC Part15 (15.247) , Subpart C | | | |
|--|------------------------------|----------|--------|
| Standard Section | Test Item | Judgment | Remark |
| 15.205(a) 15.209 15.247(d) | Radiated Spurious Emissions | PASS | |
| 15.247(d) | Conducted Spurious emissions | PASS | |
| 15.247(d) 15.205(a) | Band edge | PASS | |
| 15.207 | Conducted Emission | PASS | |
| 15.247(a) | 20dB Bandwidth | PASS | |
| 15.247(b) | Maximum Peak Output Power | PASS | |
| 15.247(a) | Frequency Separation | PASS | |
| 15.247(a) | Number of Hopping Frequency | PASS | |
| 15.247(a) | Dwell time | PASS | |
| 15.203 | Antenna Requirement | PASS | |
| Note: (1) "N/A" denotes test is not applicable in this Test Report | | | |

2. TEST FACILITY

Shenzhen BCTC Testing Co., Ltd.

Add. : BCTC Building & 1-2F, East of B Building, Pengzhou Industrial, Fuyuan 1st Road, Qiaotou Community, Fuyong Street, Bao'an District, Shenzhen, China

Test Firm Registration Number: 712850

IC Registered No.: 23583

3. MEASUREMENT UNCERTAINTY

The reported uncertainty of measurement $y \pm U$, where expanded uncertainty U is based on a standard uncertainty multiplied by a coverage factor of $k=2$, providing a level of confidence of approximately 95 %.

| No. | Item | Uncertainty |
|-----|--|-------------|
| 1 | 3m chamber Radiated spurious emission(30MHz-1GHz) | U=4.3dB |
| 2 | 3m chamber Radiated spurious emission(1GHz-18GHz) | U=4.5dB |
| 3 | 3m chamber Radiated spurious emission(18GHz-40GHz) | U=3.34dB |
| 4 | Conducted Adjacent channel power | U=1.38dB |
| 5 | Conducted output power uncertainty Above 1G | U=1.576dB |
| 6 | Conducted output power uncertainty below 1G | U=1.28dB |
| 7 | humidity uncertainty | U=5.3% |
| 8 | Temperature uncertainty | U=0.59°C |

4. GENERAL INFORMATION

4.1 GENERAL DESCRIPTION OF EUT

| | |
|------------------------|--|
| Equipment | Rechargeable Soundwear Eye Mask |
| Trade Name | N/A |
| Model Name | PESDEYE-G |
| Model Difference | N/A |
| Product Description | The EUT is a Rechargeable Soundwear Eye Mask |
| | Operation Frequency: 2402-2480 MHz |
| | Modulation Type: GFSK, Pi/4DQPSK, 8DPSK |
| | Number Of Channel 79CH |
| | Antenna Designation: Internal PCB antenna |
| | Antenna Gain 0dBi |
| | Based on the application, features, or specification exhibited in User's Manual, the EUT is considered as an ITE/Computing Device. More details of EUT technical specification, please refer to the User's Manual. |
| Channel List | Please refer to the Note 2. |
| Ratings | DC5V from adapter DC 3.7V from Battery |
| Adapter | MODEL: ZL-010501000US01 INPUT: AC100-240V 50/60Hz 03A OUTPUT: DC5.0V 1000mA |
| Connecting I/O Port(s) | Please refer to the User's Manual |

4.2 Test Setup Configuration

See test photographs attached in EUT TEST SETUP Photographs for the actual Conducted Emission Test

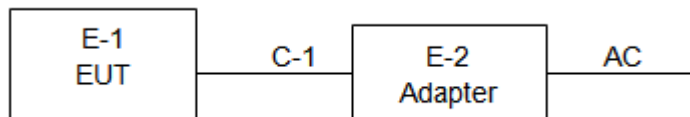

Radiated Spurious Emission

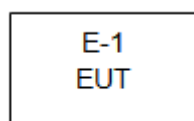

4.3 Support Equipment

| No. | Device Type | Brand | Model | Series No. | Data Cable |
|-----|---------------------------------|-------|----------------------|------------|------------|
| E-1 | Rechargeable Soundwear Eye Mask | N/A | PESDEYE-G | N/A | EUT |
| E-2 | Adapter | N/A | ZL-0105010 00US01 | N/A | Auxiliary |

| Item | Shielded Type | Ferrite Core | Length | Note |
|------|---------------|--------------|--------|---------------------|
| C-1 | NO | NO | 0.3M | DC cable unshielded |

Notes:

- All the equipment/cables were placed in the worst-case configuration to maximize the emission during the test.
- Grounding was established in accordance with the manufacturer's requirements and conditions for the intended use.

4.4 Channel List

| CH | Frequency (MHz) | CH | Frequency (MHz) | CH | Frequency (MHz) | CH | Frequency (MHz) |
|----|-----------------|----|-----------------|----|-----------------|----|-----------------|
| 0 | 2402 | 1 | 2403 | 2 | 2404 | 3 | 2405 |
| 4 | 2406 | 5 | 2407 | 6 | 2408 | 7 | 2409 |
| 8 | 2410 | 9 | 2411 | 10 | 2412 | 11 | 2413 |
| 12 | 2414 | 13 | 2415 | 14 | 2416 | 15 | 2417 |
| 16 | 2418 | 17 | 2419 | 18 | 2420 | 19 | 2421 |
| 20 | 2422 | 21 | 2423 | 22 | 2424 | 23 | 2425 |
| 24 | 2426 | 25 | 2427 | 26 | 2428 | 27 | 2429 |
| 28 | 2430 | 29 | 2431 | 30 | 2432 | 31 | 2433 |
| 32 | 2434 | 33 | 2435 | 34 | 2436 | 35 | 2437 |
| 36 | 2438 | 37 | 2439 | 38 | 2440 | 39 | 2441 |
| 40 | 2442 | 41 | 2443 | 42 | 2444 | 43 | 2445 |
| 44 | 2446 | 45 | 2447 | 46 | 2448 | 47 | 2449 |
| 48 | 2450 | 49 | 2451 | 50 | 2452 | 51 | 2453 |
| 52 | 2454 | 53 | 2455 | 54 | 2456 | 55 | 2457 |
| 56 | 2458 | 57 | 2459 | 58 | 2460 | 59 | 2461 |
| 60 | 2462 | 61 | 2463 | 62 | 2464 | 63 | 2465 |
| 64 | 2466 | 65 | 2467 | 66 | 2468 | 67 | 2469 |
| 68 | 2470 | 69 | 2471 | 70 | 2472 | 71 | 2473 |
| 72 | 2474 | 73 | 2475 | 74 | 2476 | 75 | 2477 |
| 76 | 2478 | 77 | 2479 | 78 | 2480 | 79 | / |

4.5 Test Mode

All test mode(s) and condition(s) mentioned were considered and evaluated respectively by performing full tests, the worst data were recorded and reported.

During testing, Channel and Power Controlling Software provided by the customer was used to control the operating channel as well as the output power level. The RF output power selection is for the setting of RF output power expected by the customer and is going to be fixed on the firmware of the final end product.

The EUT is Continue Transmitting.

The software is installed in operation system, named "BT_Tool", Version 1.0.

| Test Mode | Test mode | Low channel | Middle channel | High channel |
|-----------|---|-------------|----------------|--------------|
| 1 | Transmitting(GFSK) | 2402MHz | 2441MHz | 2480MHz |
| 2 | Transmitting(Pi/4DQPSK) | 2402MHz | 2441MHz | 2480MHz |
| 3 | Transmitting(8DPSK) | 2402MHz | 2441MHz | 2480MHz |
| 4 | Transmitting (Conducted Emission and Radiated emission) | | | |

5. TEST FACILITY AND TEST INSTRUMENT USED

5.1 Test Facility

All measurement facilities used to collect the measurement data are located at BCTC Building & 1-2F, East of B Building, Pengzhou Industrial, Fuyuan 1st Road, Qiaotou Community, Fuyong Street, Bao'an District, Shenzhen, China. The site and apparatus are constructed in conformance with the requirements of ANSI C63.4 and CISPR 16-1-1 other equivalent standards.

5.2 Test Instrument Used

RF conduction and Radiation Test equipment

| Item | Equipment | Manufacturer | Type No. | Serial No. | Last calibration | Calibrated until |
|------|----------------------------------|--------------|---------------|---------------|------------------|------------------|
| 1 | Spectrum Analyzer (9kHz-26.5GHz) | Agilent | E4407B | MY45109572 | Jun. 13, 2019 | Jun. 12, 2020 |
| 2 | Test Receiver (9kHz-7GHz) | R&S | ESR7 | 101154 | Jun. 13, 2019 | Jun. 12, 2020 |
| 3 | Bilog Antenna (30MHz-3GHz) | SCHWARZBECK | VULB9163 | VULB9163-942 | Jun. 22, 2019 | Jun. 21, 2020 |
| 4 | Horn Antenna (1GHz-18GHz) | SCHWARZBECK | BBHA9120D | 1541 | Jun. 22, 2019 | Jun. 21, 2020 |
| 5 | Horn Antenna (18GHz-40GHz) | SCHWARZBECK | BBHA9170 | 822 | Jun. 22, 2019 | Jun. 21, 2020 |
| 6 | Amplifier (9KHz-6GHz) | SCHWARZBECK | BBV9744 | 9744-0037 | Jun. 25, 2019 | Jun. 24, 2020 |
| 7 | Amplifier (0.5GHz-18GHz) | SCHWARZBECK | BBV9718 | 9718-309 | Jun. 25, 2019 | Jun. 24, 2020 |
| 8 | Amplifier (18GHz-40GHz) | MITEQ | TTA1840-35-HG | 2034381 | Jun. 17, 2019 | Jun. 16, 2020 |
| 9 | Loop Antenna (9KHz-30MHz) | SCHWARZBECK | FMZB1519B | 014 | Jul. 02, 2019 | Jul. 01, 2020 |
| 10 | RF cables1 (9kHz-30MHz) | Huber+Suhnar | 9kHz-30MHz | B1702988-0008 | Jun. 25, 2019 | Jun. 24, 2020 |
| 11 | RF cables2 (30MHz-1GHz) | Huber+Suhnar | 30MHz-1GHz | 1486150 | Jun. 25, 2019 | Jun. 24, 2020 |
| 12 | RF cables3 (1GHz-40GHz) | Huber+Suhnar | 1GHz-40GHz | 1607106 | Jun. 25, 2019 | Jun. 24, 2020 |
| 13 | Power Metter | Keysight | E4419B | \ | Jun. 17, 2019 | Jun. 16, 2020 |
| 14 | Power Sensor (AV) | Keysight | E9 300A | \ | Jun. 17, 2019 | Jun. 16, 2020 |
| 15 | Signal Analyzer 20kHz-26.5GHz | KEYSIGHT | N9020A | MY49100060 | Jun. 13, 2019 | Jun. 12, 2020 |
| 16 | Spectrum Analyzer 9kHz-40GHz | Aglient | FSP40 | 100363 | Jun. 13, 2019 | Jun. 12, 2020 |
| 17 | D.C. Power Supply | LongWei | TPR-6405D | \ | \ | \ |
| 18 | Software | Frad | EZ-EMC | FA-03A2 RE | \ | \ |

Conduction Test equipment

| Item | Equipment | Manufacturer | Type No. | Serial No. | Last calibration | Calibrated until |
|------|---------------|-----------------|------------|-------------------|------------------|------------------|
| 1 | Test Receiver | R&S | ESR3 | 102075 | Jun. 13, 2019 | Jun. 12, 2020 |
| 2 | LISN | SCHWARZBEC K | NSLK8127 | 8127739 | Jun. 13, 2019 | Jun. 12, 2020 |
| 3 | LISN | R&S | ENV216 | 101375 | Jun. 13, 2019 | Jun. 12, 2020 |
| 4 | RF cables | Huber+Suhnar | 9kHz-30MHz | B1702988-00 08 | Jun. 25, 2019 | Jun. 24, 2020 |
| 5 | Software | Frad | EZ-EMC | EMC-CON 3A1 | \ | \ |

6. CONDUCTED EMISSIONS

6.1 Block Diagram Of Test Setup

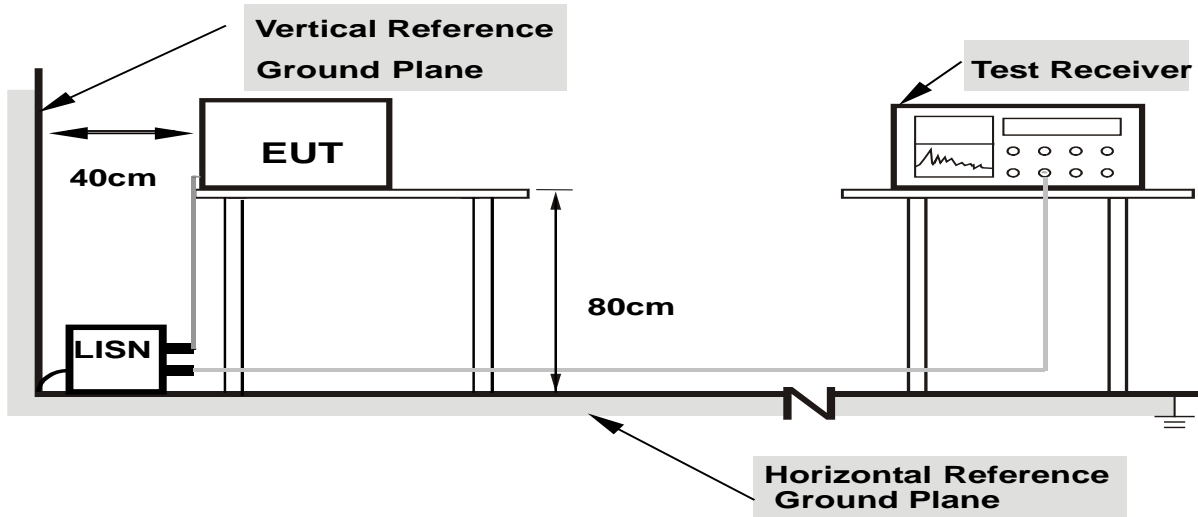

- Note:**
1. Support units were connected to second LISN.
 2. Both of LISNs (AMN) are 80 cm from EUT and at least 80 from other units and other metal planes

6.2 Limit

| FREQUENCY (MHz) | Limit (dBuV) | | Standard |
|-----------------|--------------|-----------|----------|
| | Quasi-peak | Average | |
| 0.15 -0.5 | 66 - 56 * | 56 - 46 * | FCC |
| 0.50 -5.0 | 56.00 | 46.00 | FCC |
| 5.0 -30.0 | 60.00 | 50.00 | FCC |

6.3 Test procedure

| Receiver Parameters | Setting |
|---------------------|----------|
| Attenuation | 10 dB |
| Start Frequency | 0.15 MHz |
| Stop Frequency | 30 MHz |
| IF Bandwidth | 9 kHz |

a. The EUT was placed 0.8 meters from the horizontal ground plane with EUT being connected to the power mains through a line impedance stabilization network (LISN). All other support equipments powered from additional LISN(s). The LISN provide 50 Ohm/ 50uH of coupling impedance for the measuring instrument.

- b. Interconnecting cables that hang closer than 40 cm to the ground plane shall be folded back and forth in the center forming a bundle 30 to 40 cm long.
- c. I/O cables that are not connected to a peripheral shall be bundled in the center. The end of the cable may be terminated, if required, using the correct terminating impedance. The overall length shall not exceed 1 m.
- d. LISN at least 80 cm from nearest part of EUT chassis.
- e. For the actual test configuration, please refer to the related Item –EUT Test Photos.

6.4 Test Result

| | | | |
|----------------|-------------|---------------------|--------|
| Temperature : | 26 °C | Relative Humidity : | 54% |
| Pressure : | 101kPa | Phase : | L |
| Test Voltage : | AC120V 60Hz | Test Mode : | Mode 4 |

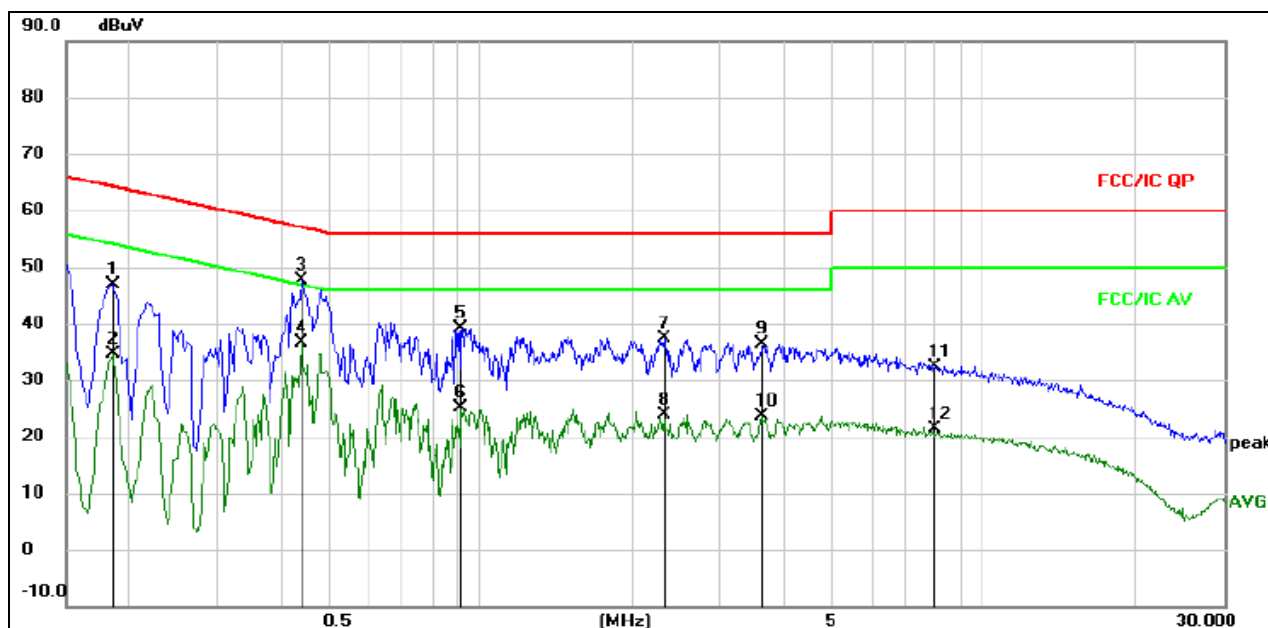

Remark:

1. All readings are Quasi-Peak and Average values.
2. Factor = Insertion Loss + Cable Loss.

| No. | Mk. | Freq. MHz | Reading Level dBuV | Correct Factor | Measure- ment dBuV | Limit dBuV | Over dB | Detector | Comment |
|-----|-----|--------------|--------------------------|-------------------|--------------------------|---------------|------------|----------|---------|
| 1 | | 0.1860 | 37.44 | 9.48 | 46.92 | 64.21 | -17.29 | QP | |
| 2 | | 0.1860 | 25.05 | 9.48 | 34.53 | 54.21 | -19.68 | AVG | |
| 3 | * | 0.4420 | 38.16 | 9.54 | 47.70 | 57.02 | -9.32 | QP | |
| 4 | | 0.4420 | 27.16 | 9.54 | 36.70 | 47.02 | -10.32 | AVG | |
| 5 | | 0.9140 | 29.65 | 9.60 | 39.25 | 56.00 | -16.75 | QP | |
| 6 | | 0.9140 | 15.49 | 9.60 | 25.09 | 46.00 | -20.91 | AVG | |
| 7 | | 2.3179 | 27.80 | 9.61 | 37.41 | 56.00 | -18.59 | QP | |
| 8 | | 2.3179 | 14.17 | 9.61 | 23.78 | 46.00 | -22.22 | AVG | |
| 9 | | 3.6220 | 26.69 | 9.70 | 36.39 | 56.00 | -19.61 | QP | |
| 10 | | 3.6220 | 13.86 | 9.70 | 23.56 | 46.00 | -22.44 | AVG | |
| 11 | | 7.9420 | 22.78 | 9.71 | 32.49 | 60.00 | -27.51 | QP | |
| 12 | | 7.9420 | 11.67 | 9.71 | 21.38 | 50.00 | -28.62 | AVG | |

| | | | |
|----------------|-------------|---------------------|--------|
| Temperature : | 26 °C | Relative Humidity : | 54% |
| Pressure : | 101kPa | Phase : | N |
| Test Voltage : | AC120V 60Hz | Test Mode : | Mode 4 |

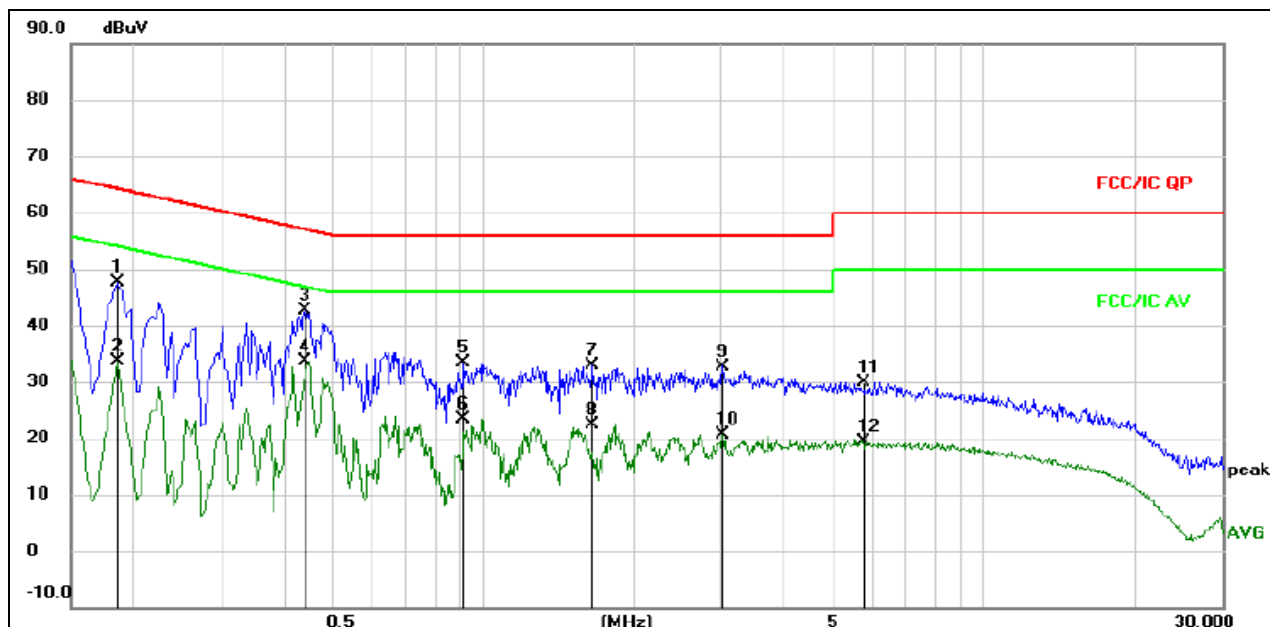

Remark:

- All readings are Quasi-Peak and Average values.
- Factor = Insertion Loss + Cable Loss.

| No. | Mk. | Freq. MHz | Reading Level dBuV | Correct Factor | Measure- ment dBuV | Limit dBuV | Over dB | Detector | Comment |
|-----|-----|--------------|--------------------------|-------------------|--------------------------|---------------|------------|----------|---------|
| 1 | | 0.1860 | 38.10 | 9.48 | 47.58 | 64.21 | -16.63 | QP | |
| 2 | | 0.1860 | 24.20 | 9.48 | 33.68 | 54.21 | -20.53 | AVG | |
| 3 | | 0.4420 | 33.08 | 9.54 | 42.62 | 57.02 | -14.40 | QP | |
| 4 | * | 0.4420 | 24.15 | 9.54 | 33.69 | 47.02 | -13.33 | AVG | |
| 5 | | 0.9180 | 23.67 | 9.59 | 33.26 | 56.00 | -22.74 | QP | |
| 6 | | 0.9180 | 13.78 | 9.59 | 23.37 | 46.00 | -22.63 | AVG | |
| 7 | | 1.6620 | 23.20 | 9.58 | 32.78 | 56.00 | -23.22 | QP | |
| 8 | | 1.6620 | 12.70 | 9.58 | 22.28 | 46.00 | -23.72 | AVG | |
| 9 | | 3.0140 | 23.09 | 9.66 | 32.75 | 56.00 | -23.25 | QP | |
| 10 | | 3.0140 | 11.03 | 9.66 | 20.69 | 46.00 | -25.31 | AVG | |
| 11 | | 5.7180 | 20.15 | 9.77 | 29.92 | 60.00 | -30.08 | QP | |
| 12 | | 5.7180 | 9.62 | 9.77 | 19.39 | 50.00 | -30.61 | AVG | |

7. RADIATED EMISSIONS

7.1 Block Diagram Of Test Setup

(A) Radiated Emission Test-Up Frequency Below 30MHz

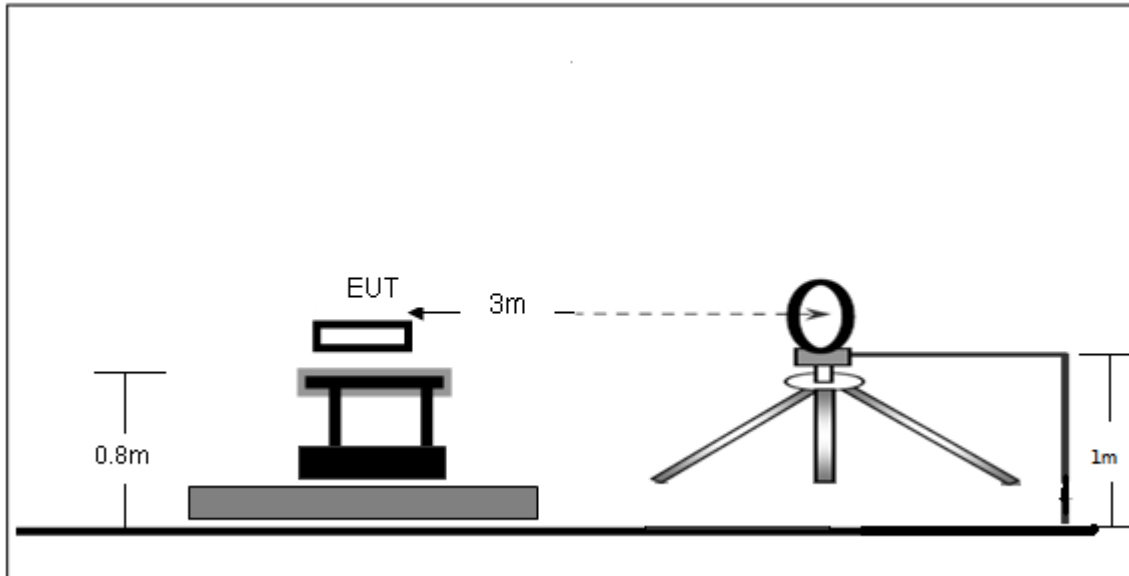

(B) Radiated Emission Test-Up Frequency 30MHz~1GHz

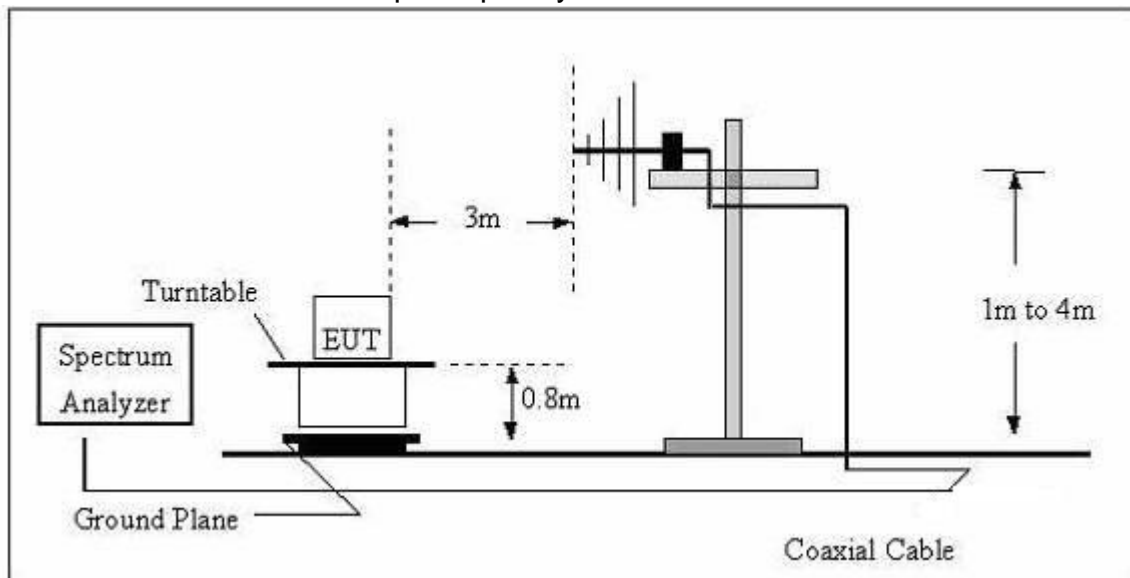

(C) Radiated Emission Test-Up Frequency Above 1GHz

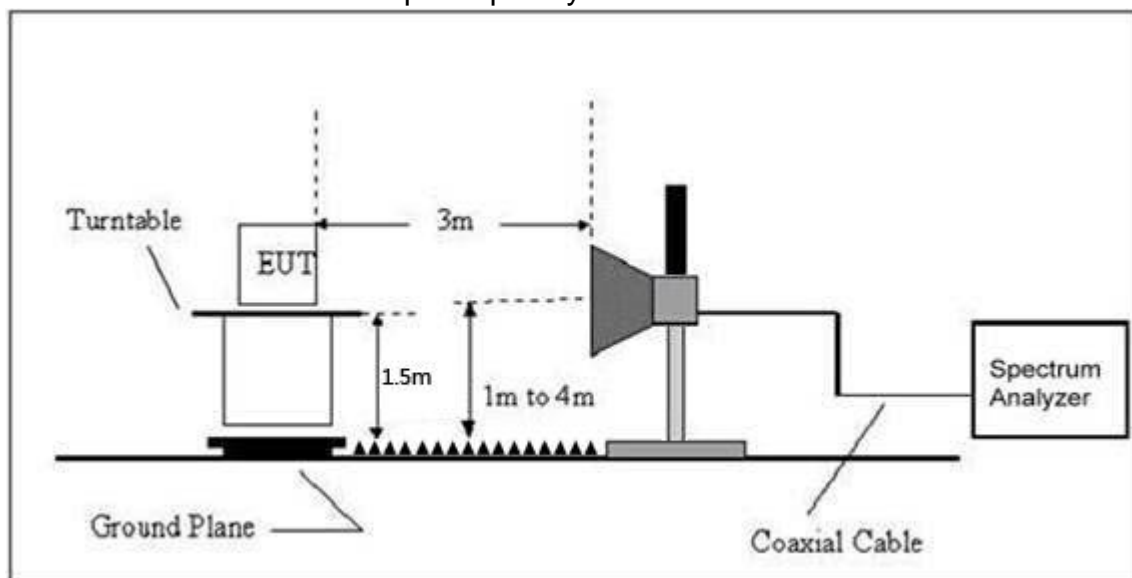

7.2 Limit

20dBc in any 100 kHz bandwidth outside the operating frequency band. In case the emission fall within the restricted band specified on 15.205(a), then the 15.209(a) limit in the table below has to be followed.

| Frequency (MHz) | Field Strength uV/m | Distance (m) | Field Strength Limit at 3m Distance | |
|--------------------|------------------------|-----------------|-------------------------------------|--------------------------------|
| | | | uV/m | dBuV/m |
| 0.009 ~ 0.490 | 2400/F(kHz) | 300 | 10000 * 2400/F(kHz) | $20\log^{(2400/F(kHz))} + 80$ |
| 0.490 ~ 1.705 | 24000/F(kHz) | 30 | 100 * 24000/F(kHz) | $20\log^{(24000/F(kHz))} + 40$ |
| 1.705 ~ 30 | 30 | 30 | 100 * 30 | $20\log^{(30)} + 40$ |
| 30 ~ 88 | 100 | 3 | 100 | $20\log^{(100)}$ |
| 88 ~ 216 | 150 | 3 | 150 | $20\log^{(150)}$ |
| 216 ~ 960 | 200 | 3 | 200 | $20\log^{(200)}$ |
| Above 960 | 500 | 3 | 500 | $20\log^{(500)}$ |

7.3 Test procedure

| Receiver Parameter | Setting |
|--------------------|-------------------|
| Attenuation | Auto |
| 9kHz~150kHz | RBW 200Hz for QP |
| 150kHz~30MHz | RBW 9kHz for QP |
| 30MHz~1000MHz | RBW 120kHz for QP |

| Spectrum Parameter | Setting |
|--------------------|--|
| 1-25GHz | RBW 1 MHz /VBW 1 MHz for Peak, RBW 1 MHz / VBW 10Hz for Average |

Below 1GHz test procedure as below:

- a. The EUT was placed on the top of a rotating table 0.8 meters above the ground at a 3 meter semi-anechoic chamber. The table was rotated 360 degrees to determine the position of the highest radiation.
- b. The EUT was set 3 meters away from the interference-receiving antenna, which was mounted on the top of a variable-height antenna tower.
- c. The antenna height is varied from one meter to four meters above the ground to determine the maximum value of the field strength. Both horizontal and vertical polarizations of the antenna are set to make the measurement.
- d. For each suspected emission, the EUT was arranged to its worst case and then the antenna was tuned to heights from 1 meter to 4 meters (for the test frequency of below 30MHz, the antenna was tuned to heights 1 meter) and the rotatable table was turned from 0 degrees to 360 degrees to find the maximum reading.
- e. The test-receiver system was set to Peak Detect Function and Specified Bandwidth with Maximum Hold Mode.
- f. If the emission level of the EUT in peak mode was 10dB lower than the limit specified, then testing could be stopped and the peak values of the EUT would be reported. Otherwise the emissions that did not have 10dB margin would be re-tested one by one using peak, quasi-peak or average method as specified and then reported in a data sheet.

Above 1GHz test procedure as below:

- g. Different between above is the test site, change from Semi- Anechoic Chamber to fully Anechoic Chamber and change form table 0.8 metre to 1.5 metre(Above 18GHz the distance is 1 meter and table is 1.5 metre).
- h. Test the EUT in the lowest channel ,the middle channel ,the Highest channel.

Note:

Both horizontal and vertical antenna polarities were tested and performed pretest to three orthogonal axis. The worst case emissions were reported.

7.4 Test Result

Between 9KHz – 30MHz

| | | | |
|--------------|---------|--------------------|---------|
| Temperature: | 26°C | Relative Humidity: | 54% |
| Pressure: | 101 kPa | Test Voltage : | DC 3.7V |
| Test Mode : | Mode 4 | Polarization : | -- |

| Freq. | Reading | Limit | Margin | State |
|-------|----------|----------|--------|-------|
| (MHz) | (dBuV/m) | (dBuV/m) | (dB) | P/F |
| -- | -- | -- | -- | PASS |
| -- | -- | -- | -- | PASS |

Note:

The amplitude of spurious emissions which are attenuated by more than 20dB below the permissible value has no need to be reported.

Distance extrapolation factor = $40 \log(\text{specific distance}/\text{test distance})$ (dB);

Limit line = specific limits(dBuv) + distance extrapolation factor.

Test all the modes and only worst case was reported.

Between 30MHz – 1GHz

| | | | |
|--------------|--------|--------------------|------------|
| Temperature: | 26°C | Relative Humidity: | 54% |
| Pressure: | 101kPa | Test Voltage : | DC 3.7V |
| Test Mode : | Mode 4 | Polarization : | Horizontal |

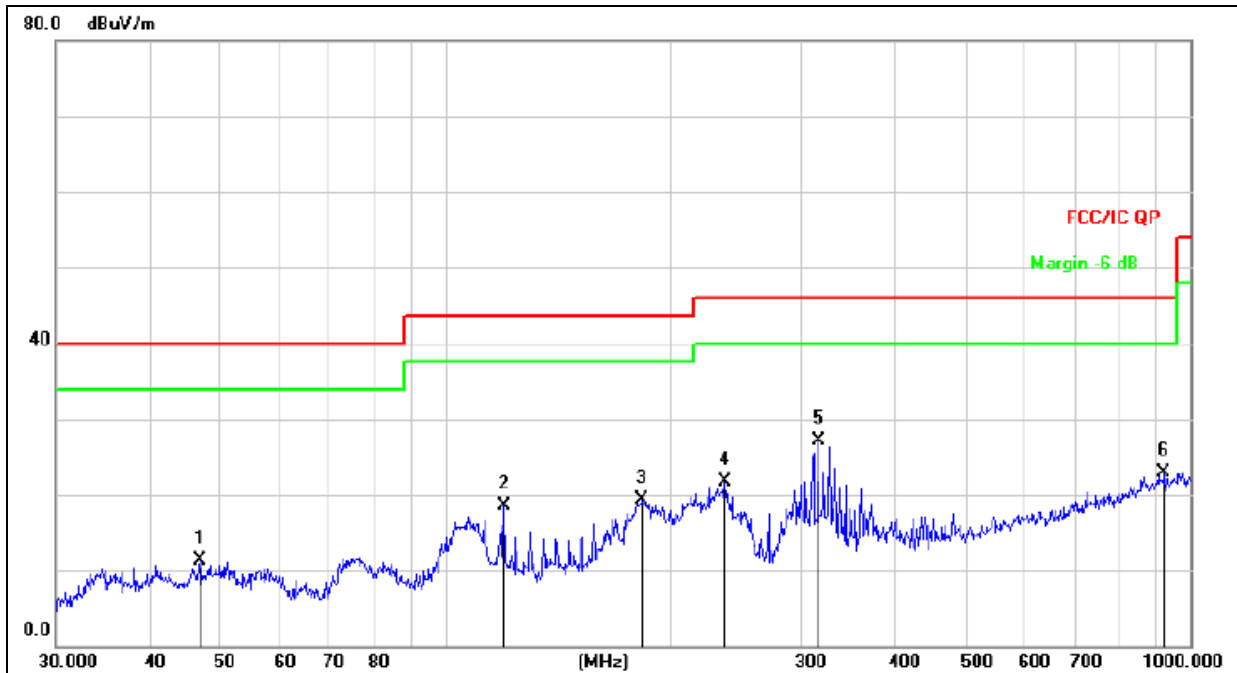

Remark:

Factor = Antenna Factor + Cable Loss – Pre-amplifier.

| No. | Mk. | Freq. MHz | Reading Level dBuV | Correct Factor dB | Measure- ment dBuV/m | Limit dB/m | Over dB | Detector |
|-----|-----|--------------|--------------------------|-------------------------|----------------------------|---------------|------------|----------|
| 1 | | 46.8303 | 26.43 | -15.03 | 11.40 | 40.00 | -28.60 | QP |
| 2 | | 119.8556 | 36.07 | -17.56 | 18.51 | 43.50 | -24.99 | QP |
| 3 | | 183.2005 | 36.68 | -17.38 | 19.30 | 43.50 | -24.20 | QP |
| 4 | | 237.4760 | 37.08 | -15.44 | 21.64 | 46.00 | -24.36 | QP |
| 5 | * | 316.5890 | 40.33 | -13.15 | 27.18 | 46.00 | -18.82 | QP |
| 6 | | 922.5157 | 24.30 | -1.32 | 22.98 | 46.00 | -23.02 | QP |

| | | | |
|--------------|--------|--------------------|----------|
| Temperature: | 26°C | Relative Humidity: | 54% |
| Pressure: | 101kPa | Test Voltage : | DC 3.7V |
| Test Mode : | Mode 4 | Polarization : | Vertical |

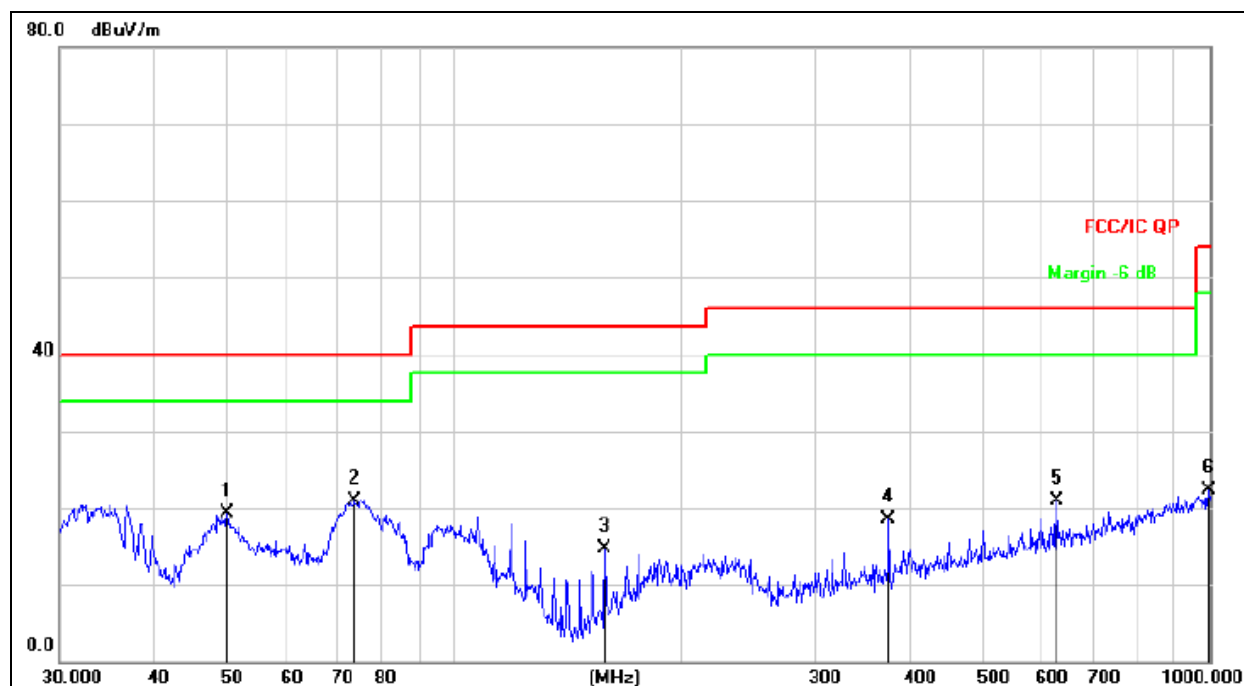

Remark:

Factor = Antenna Factor + Cable Loss – Pre-amplifier.

| No. | Mk. | Freq. MHz | Reading Level dBuV | Correct Factor dB | Measure- ment dBuV/m | Limit dB/m | Over dB | Detector |
|-----|-----|--------------|--------------------------|-------------------------|----------------------------|---------------|------------|----------|
| 1 | | 50.0566 | 34.15 | -14.86 | 19.29 | 40.00 | -20.71 | QP |
| 2 | * | 73.8756 | 39.94 | -19.05 | 20.89 | 40.00 | -19.11 | QP |
| 3 | | 158.1123 | 33.64 | -18.98 | 14.66 | 43.50 | -28.84 | QP |
| 4 | | 375.9385 | 30.08 | -11.64 | 18.44 | 46.00 | -27.56 | QP |
| 5 | | 627.2738 | 27.50 | -6.68 | 20.82 | 46.00 | -25.18 | QP |
| 6 | | 996.4996 | 23.07 | -0.83 | 22.24 | 54.00 | -31.76 | QP |

Remark:

Test all the modes and only worst case was reported. The worst mode is GFSK, Low Channel.

Between 1-25GHz

| Polar (H/V) | Frequency | Meter Reading | Pre-amplifier | Cable Loss | Antenna Factor | Emission Level | Limits | Margin | Detector Type |
|--------------------------|-----------|---------------|---------------|------------|----------------|----------------|----------|--------|---------------|
| | (MHz) | (dBuV) | (dB) | (dB) | (dB) | (dBuV/m) | (dBuV/m) | (dB) | |
| GFSK Low Channel:2402MHz | | | | | | | | | |
| V | 4804.00 | 53.67 | 39.55 | 7.77 | 25.66 | 47.55 | 74.00 | -26.45 | Pk |
| V | 4804.00 | 43.40 | 39.55 | 7.77 | 25.66 | 37.28 | 54.00 | -16.72 | AV |
| V | 7206.00 | 51.82 | 38.33 | 7.3 | 24.55 | 45.34 | 74.00 | -28.66 | Pk |
| V | 7206.00 | 43.77 | 38.33 | 7.3 | 24.55 | 37.29 | 54.00 | -16.71 | AV |
| V | 15453.36 | 50.74 | 35.23 | 6.6 | 26.59 | 48.70 | 74.00 | -25.30 | Pk |
| H | 4804.00 | 50.12 | 39.55 | 7.77 | 25.66 | 44.00 | 74.00 | -30.00 | Pk |
| H | 4804.00 | 43.76 | 39.55 | 7.77 | 25.66 | 37.64 | 54.00 | -16.36 | AV |
| H | 7206.00 | 50.60 | 38.33 | 7.3 | 24.55 | 44.12 | 74.00 | -29.88 | Pk |
| H | 7206.00 | 43.38 | 38.33 | 7.3 | 24.55 | 36.90 | 54.00 | -17.10 | AV |
| H | 15450.09 | 52.20 | 35.45 | 6.6 | 26.59 | 49.94 | 74.00 | -24.06 | Pk |

| Polar (H/V) | Frequency | Meter Reading | Pre-amplifier | Cable Loss | Antenna Factor | Emission Level | Limits | Margin | Detector Type |
|-----------------------------|-----------|---------------|---------------|------------|----------------|----------------|----------|--------|---------------|
| | (MHz) | (dBuV) | (dB) | (dB) | (dB) | (dBuV/m) | (dBuV/m) | (dB) | |
| GFSK Middle Channel:2441MHz | | | | | | | | | |
| V | 4882.00 | 51.10 | 38.89 | 7.57 | 25.45 | 45.23 | 74.00 | -28.77 | Pk |
| V | 4882.00 | 43.31 | 38.89 | 7.57 | 25.45 | 37.44 | 54.00 | -16.56 | AV |
| V | 7323.00 | 53.93 | 38.78 | 7.35 | 24.54 | 47.04 | 74.00 | -26.96 | Pk |
| V | 7323.00 | 43.58 | 38.78 | 7.35 | 24.54 | 36.69 | 54.00 | -17.31 | AV |
| V | 15454.70 | 53.54 | 35.89 | 6.42 | 26.47 | 50.54 | 74.00 | -23.46 | Pk |
| H | 4882.00 | 51.55 | 38.89 | 7.57 | 25.45 | 45.68 | 74.00 | -28.32 | Pk |
| H | 4882.00 | 43.16 | 38.89 | 7.57 | 25.45 | 37.29 | 54.00 | -16.71 | AV |
| H | 7323.00 | 51.24 | 38.78 | 7.35 | 24.54 | 44.35 | 74.00 | -29.65 | Pk |
| H | 7323.00 | 43.38 | 38.78 | 7.35 | 24.54 | 36.49 | 54.00 | -17.51 | AV |
| H | 15453.96 | 50.30 | 36.68 | 6.42 | 26.47 | 46.51 | 74.00 | -27.49 | Pk |

| Polar (H/V) | Frequency | Meter Reading | Pre-amplifier | Cable Loss | Antenna Factor | Emission Level | Limits | Margin | Detector Type |
|---------------------------|-----------|---------------|---------------|------------|----------------|----------------|----------|--------|---------------|
| | (MHz) | (dBuV) | (dB) | (dB) | (dB) | (dBuV/m) | (dBuV/m) | (dB) | |
| GFSK High Channel:2480MHz | | | | | | | | | |
| V | 4960.00 | 51.86 | 38.75 | 7.38 | 25.41 | 45.90 | 74.00 | -28.10 | Pk |
| V | 4960.00 | 43.81 | 38.75 | 7.38 | 25.41 | 37.85 | 54.00 | -16.15 | AV |
| V | 7440.00 | 50.17 | 38.65 | 7.15 | 24.52 | 43.19 | 74.00 | -30.81 | Pk |
| V | 7440.00 | 43.56 | 38.65 | 7.15 | 24.52 | 36.58 | 54.00 | -17.42 | AV |
| V | 15457.71 | 53.31 | 35.58 | 6.25 | 26.45 | 50.43 | 74.00 | -23.57 | Pk |
| H | 4960.00 | 53.61 | 38.75 | 7.38 | 25.41 | 47.65 | 74.00 | -26.35 | Pk |
| H | 4960.00 | 43.41 | 38.75 | 7.38 | 25.41 | 37.45 | 54.00 | -16.55 | AV |
| H | 7440.00 | 52.31 | 38.65 | 7.15 | 24.52 | 45.33 | 74.00 | -28.67 | Pk |
| H | 7440.00 | 43.23 | 38.65 | 7.15 | 24.52 | 36.25 | 54.00 | -17.75 | AV |
| H | 15457.01 | 52.53 | 36.42 | 6.25 | 26.45 | 48.81 | 74.00 | -25.19 | Pk |

Remark:

1. Emission Level = Meter Reading + Antenna Factor + Cable Loss – Pre-amplifier,
Margin= Emission Level - Limit
2. If peak below the average limit, the average emission was no test.
3. The amplitude of spurious emissions which are attenuated by more than 20dB below the permissible value has no need to be reported.
4. All the Modulation are test, the worst mode is GFSK, the data recording in the report.

7.5 RADIATED BAND EMISSION MEASUREMENT AND RESTRICTED BANDS OF OPERATION

Test Requirement:

FCC Part15 C Section 15.209 and 15.205

(a) Except as shown in paragraph (d) of this section, only spurious emissions are permitted in any of the frequency bands listed below:

| MHz | MHz | MHz | GHz |
|-------------------|---------------------|---------------|-------------|
| 0.090-0.110 | 16.42-16.423 | 399.9-410 | 4.5-5.15 |
| 0.495-0.505 | 16.69475-16.69525 | 608-614 | 5.35-5.46 |
| 2.1735-2.1905 | 16.80425-16.80475 | 960-1240 | 7.25-7.75 |
| 4.125-4.128 | 25.5-25.67 | 1300-1427 | 8.025-8.5 |
| 4.17725-4.17775 | 37.5-38.25 | 1435-1626.5 | 9.0-9.2 |
| 4.20725-4.20775 | 73-74.6 | 1645.5-1646.5 | 9.3-9.5 |
| 6.215-6.218 | 74.8-75.2 | 1660-1710 | 10.6-12.7 |
| 6.26775-6.26825 | 108-121.94 | 1718.8-1722.2 | 13.25-13.4 |
| 6.31175-6.31225 | 123-138 | 2200-2300 | 14.47-14.5 |
| 8.291-8.294 | 149.9-150.05 | 2310-2390 | 15.35-16.2 |
| 8.362-8.366 | 156.52475-156.52525 | 2483.5-2500 | 17.7-21.4 |
| 8.37625-8.38675 | 156.7-156.9 | 2690-2900 | 22.01-23.12 |
| 8.41425-8.41475 | 162.0125-167.17 | 3260-3267 | 23.6-24.0 |
| 12.29-12.293 | 167.72-173.2 | 3332-3339 | 31.2-31.8 |
| 12.51975-12.52025 | 240-285 | 3345.8-3358 | 36.43-36.5 |
| 12.57675-12.57725 | 322-335.4 | 3600-4400 | (2) |
| 13.36-13.41 | | | |

LIMITS OF RADIATED EMISSION MEASUREMENT (Above 1000MHz)

| FREQUENCY (MHz) | Limit (dBuV/m) (at 3M) | |
|-----------------|------------------------|---------|
| | PEAK | AVERAGE |
| Above 1000 | 74 | 54 |

Notes:

- (1) The limit for radiated test was performed according to FCC PART 15C.
- (2) The tighter limit applies at the band edges.
- (3) Emission level (dBuV/m)=20log Emission level (uV/m).

| Spectrum Parameter | Setting |
|---------------------------------------|--|
| Attenuation | Auto |
| Start Frequency | 2300MHz |
| Stop Frequency | 2520 |
| RB / VB (emission in restricted band) | 1 MHz / 1 MHz for Peak, 1 MHz / 10Hz for Average |

TEST PROCEDURE

Above 1GHz test procedure as below:

- a. 1. The EUT was placed on the top of a rotating table 1.5 meters above the ground at a 3 meter camber. The table was rotated 360 degrees to determine the position of the highest radiation.
- b. The EUT was set 3 meters away from the interference-receiving antenna, which was mounted on the top of a variable-height antenna tower.
- c. The antenna height is varied from one meter to four meters above the ground to determine the maximum value of the field strength. Both horizontal and vertical polarizations of the antenna are set to make the measurement.

- d. For each suspected emission, the EUT was arranged to its worst case and then the antenna was tuned to heights from 1 meter to 4 meters and the rota table was turned from 0 degrees to 360 degrees to find the maximum reading.
- e. The test-receiver system was set to Peak Detect Function and Specified Bandwidth with Maximum Hold Mode.
- f. If the emission level of the EUT in peak mode was 10dB lower than the limit specified, then testing could be stopped and the peak values of the EUT would be reported. Otherwise the emissions that did not have 10dB margin would be re-tested one by one using peak, quasi-peak or average method as specified and then reported in a data sheet.
- g. Test the EUT in the lowest channel, the Highest channel

Note:

Both horizontal and vertical antenna polarities were tested and performed pretest to three orthogonal axis. The worst case emissions were reported

TEST RESULT

| | Polar (H/V) | Frequency (MHz) | Meter Reading (dBuV) | Pre-amplifier (dB) | Cable Loss (dB) | Antenna Factor (dB/m) | Emission level (dBuV/m) | Limits (dBuV/m) | | Result | |
|---|---|----------------------------|----------------------|--------------------|-----------------|-----------------------|-------------------------|-----------------|-------|--------|------|
| | | | | | | | PK | PK | AV | | |
| GFSK | Low Channel 2402MHz | | | | | | | | | | |
| | H | 2390.00 | 62.12 | 38.06 | 7.42 | 20.15 | 51.63 | 74.00 | 54.00 | PASS | |
| | H | 2400.00 | 51.70 | 38.06 | 7.42 | 20.15 | 41.21 | 74.00 | 54.00 | PASS | |
| | V | 2390.00 | 59.97 | 38.06 | 7.42 | 20.15 | 49.48 | 74.00 | 54.00 | PASS | |
| | V | 2400.00 | 54.42 | 38.06 | 7.42 | 20.15 | 43.93 | 74.00 | 54.00 | PASS | |
| | High Channel 2480MHz | | | | | | | | | | |
| | H | 2483.50 | 62.95 | 38.17 | 7.45 | 20.54 | 52.77 | 74.00 | 54.00 | PASS | |
| | H | 2485.50 | 52.24 | 38.17 | 7.45 | 20.54 | 42.06 | 74.00 | 54.00 | PASS | |
| | V | 2483.50 | 62.22 | 38.17 | 7.45 | 20.54 | 52.04 | 74.00 | 54.00 | PASS | |
| | V | 2485.50 | 54.33 | 38.17 | 7.45 | 20.54 | 44.15 | 74.00 | 54.00 | PASS | |
| | Pi/4DQPSK | Low Channel 2402MHz | | | | | | | | | |
| | | H | 2390.00 | 62.79 | 38.06 | 7.42 | 20.15 | 52.30 | 74.00 | 54.00 | PASS |
| H | | 2400.00 | 53.49 | 38.06 | 7.42 | 20.15 | 43.00 | 74.00 | 54.00 | PASS | |
| V | | 2390.00 | 62.72 | 38.06 | 7.42 | 20.15 | 52.23 | 74.00 | 54.00 | PASS | |
| V | | 2400.00 | 51.13 | 38.06 | 7.42 | 20.15 | 40.64 | 74.00 | 54.00 | PASS | |
| High Channel 2480MHz | | | | | | | | | | | |
| H | | 2483.50 | 60.59 | 38.17 | 7.45 | 20.54 | 50.41 | 74.00 | 54.00 | PASS | |
| H | | 2485.50 | 53.67 | 38.17 | 7.45 | 20.54 | 43.49 | 74.00 | 54.00 | PASS | |
| V | | 2483.50 | 60.55 | 38.17 | 7.45 | 20.54 | 50.37 | 74.00 | 54.00 | PASS | |
| V | | 2485.50 | 55.46 | 38.17 | 7.45 | 20.54 | 45.28 | 74.00 | 54.00 | PASS | |
| 8DPSK | | Low Channel 2402MHz | | | | | | | | | |
| | | H | 2390.00 | 61.82 | 38.06 | 7.42 | 20.15 | 51.33 | 74.00 | 54.00 | PASS |
| | H | 2400.00 | 52.41 | 38.06 | 7.42 | 20.15 | 41.92 | 74.00 | 54.00 | PASS | |
| | V | 2390.00 | 61.15 | 38.06 | 7.42 | 20.15 | 50.66 | 74.00 | 54.00 | PASS | |
| | V | 2400.00 | 54.86 | 38.06 | 7.42 | 20.15 | 44.37 | 74.00 | 54.00 | PASS | |
| | High Channel 2480MHz | | | | | | | | | | |
| | H | 2483.50 | 60.05 | 38.17 | 7.45 | 20.54 | 49.87 | 74.00 | 54.00 | PASS | |
| | H | 2485.50 | 55.03 | 38.17 | 7.45 | 20.54 | 44.85 | 74.00 | 54.00 | PASS | |
| | V | 2483.50 | 60.83 | 38.17 | 7.45 | 20.54 | 50.65 | 74.00 | 54.00 | PASS | |
| | V | 2485.50 | 54.94 | 38.17 | 7.45 | 20.54 | 44.76 | 74.00 | 54.00 | PASS | |
| | Remark: | | | | | | | | | | |
| | 1. Emission Level = Meter Reading + Antenna Factor + Cable Loss – Pre-amplifier, Margin= Emission Level - Limit | | | | | | | | | | |
| 2. If the PK measured levels comply with average limit, then the average level were deemed to comply with average limit. | | | | | | | | | | | |
| 3 In restricted bands of operation, The spurious emissions below the permissible value more than 20dB | | | | | | | | | | | |
| 4. The amplitude of spurious emissions which are attenuated by more than 20dB below the permissible value has no need to be reported. | | | | | | | | | | | |

8. CONDUCTED EMISSION

8.1 Block Diagram Of Test Setup

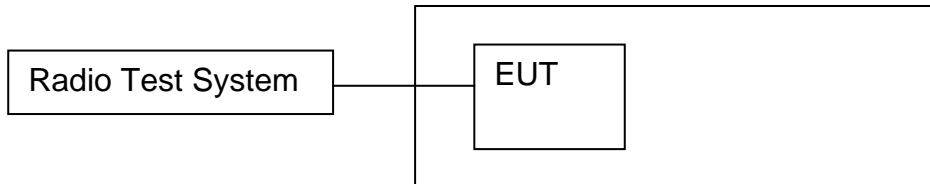

8.2 Limit

Regulation 15.247 (d), In any 100 kHz bandwidth outside the frequency band in which the spread spectrum or digitally modulated intentional radiator is operating, the radio frequency power that is produced by the intentional radiator shall be at least 20 dB below that in the 100 kHz bandwidth within the band that contains the highest level of the desired power, based on either an RF conducted or a radiated measurement, provided the transmitter demonstrates compliance with the peak conducted power limits. If the transmitter complies with the conducted power limits based on the use of RMS averaging over a time interval, as permitted under paragraph (b)(3) of this section, the attenuation required under this paragraph shall be 30 dB instead of 20 dB. Attenuation below the general limits specified in §15.209(a) is not required. In addition, radiated emissions which fall in the restricted bands, as defined in §15.205(a), must also comply with the radiated emission limits specified in §15.209(a) (see §15.205(c)).

8.3 Test procedure

1. Remove the antenna from the EUT and then connect a low RF cable from the antenna port to the spectrum;

2. Set the spectrum analyzer:

Below 30MHz:

RBW = 100kHz, VBW = 300kHz, Sweep = auto

Detector function = peak, Trace = max hold

Above 30MHz:

RBW = 100KHz, VBW = 300KHz, Sweep = auto

Detector function = peak, Trace = max hold

8.4 Test Result

30MHz – 25GHz GFSK Low Channel

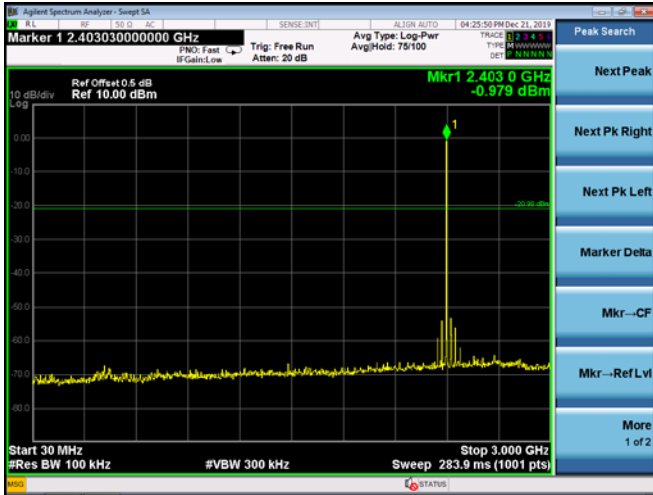

GFSK Middle Channel

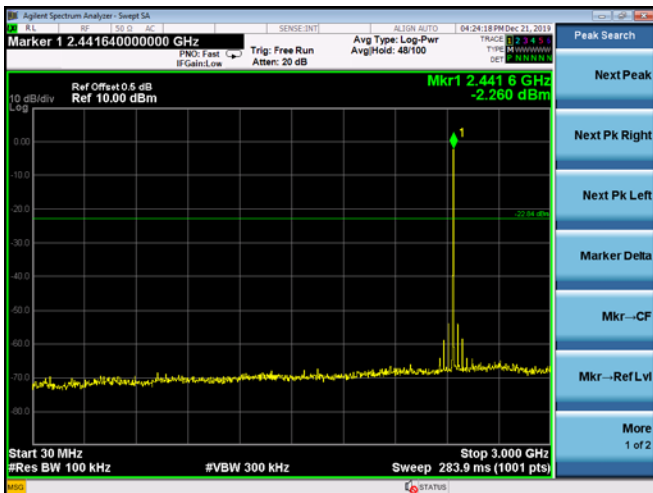

GFSK High Channel

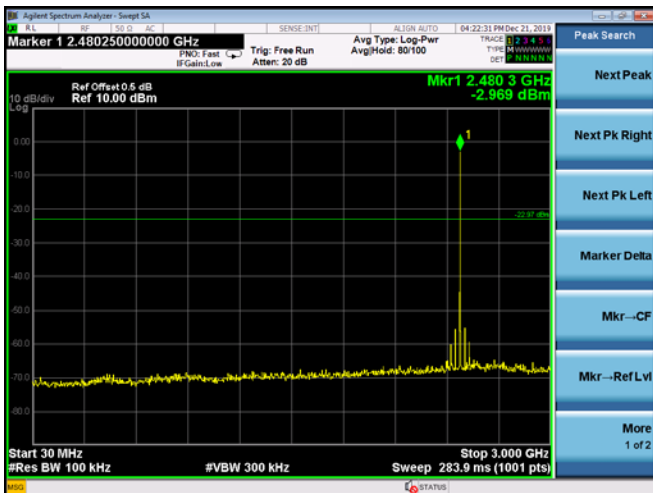

Pi/4 DQPSK Low Channel

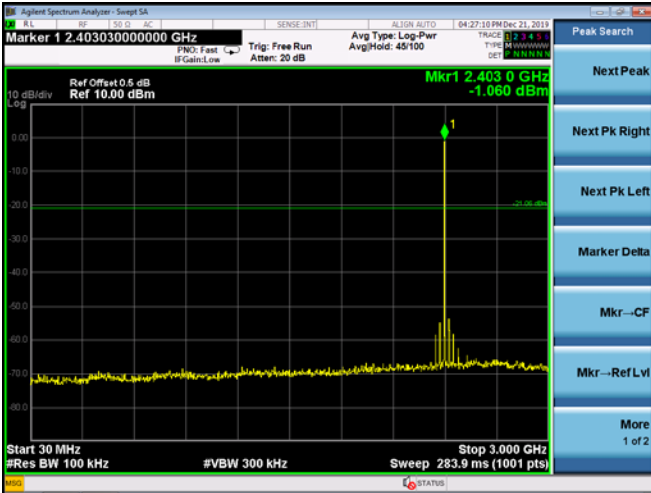

Pi/4 DQPSK Middle Channel

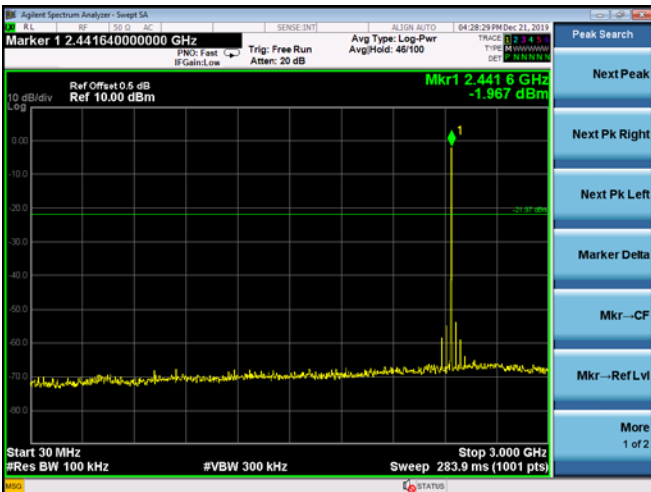

Pi/4 DQPSK High Channel

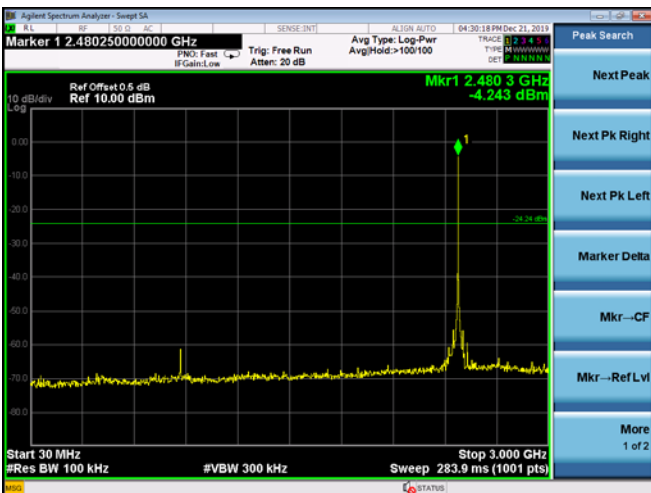

8DPSK Low Channel

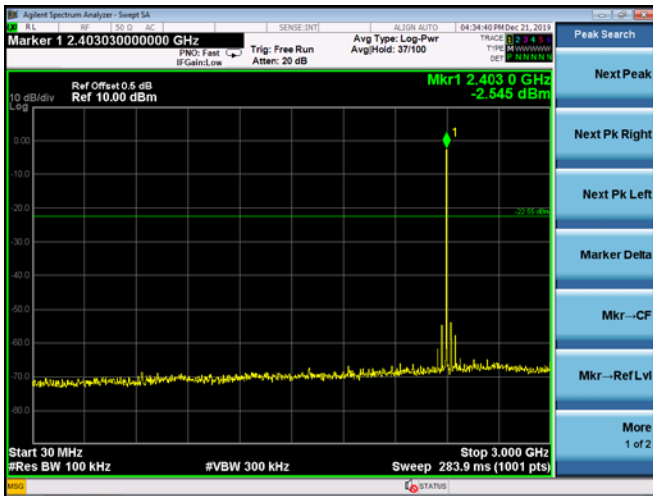

8DPSK Middle Channel

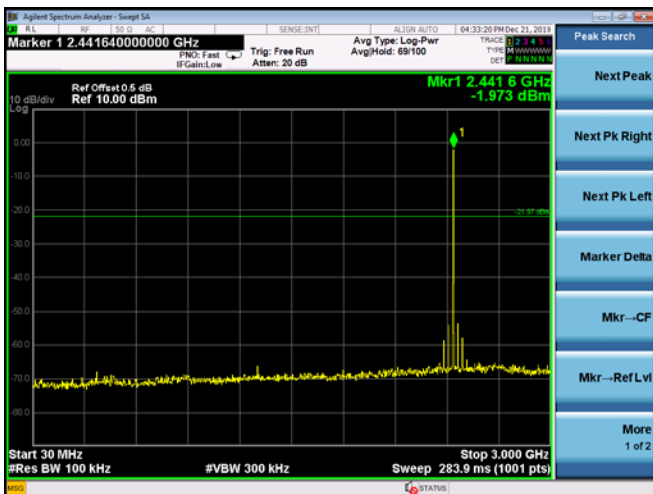

8DPSK High Channel

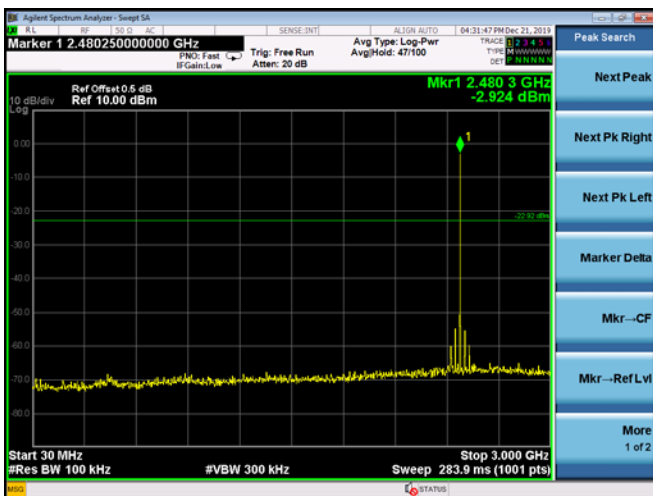

GFSK Transmitting Band edge-left side

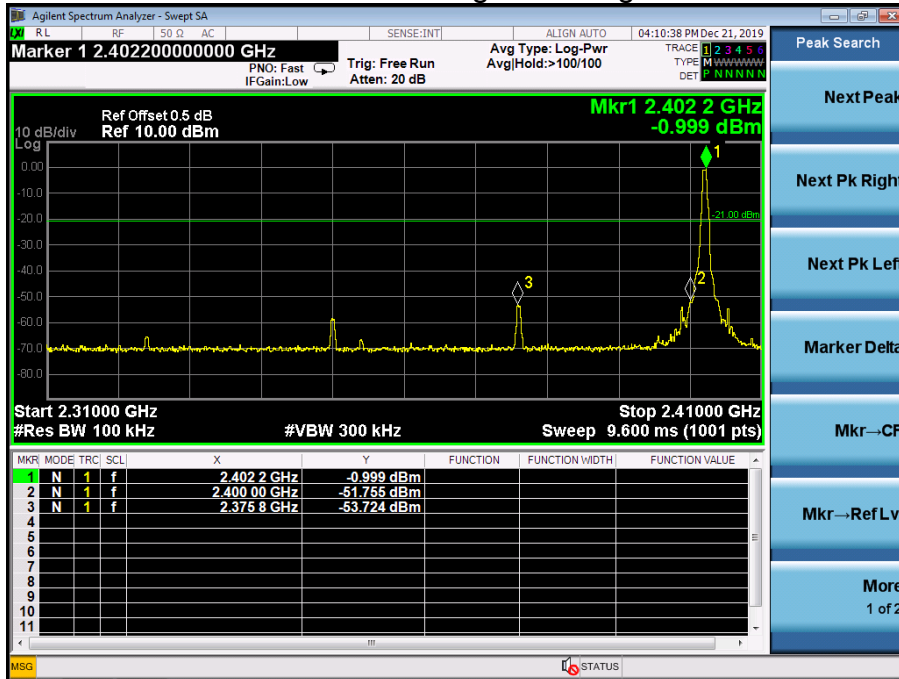

GFSK Hopping Band edge-left side

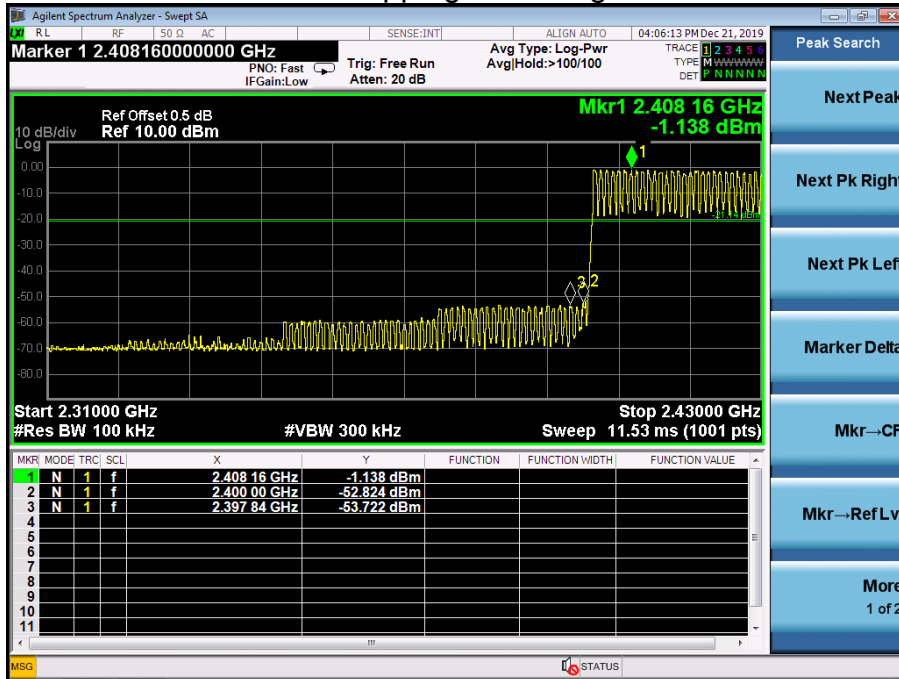

GFSK Transmitting Band edge-right side

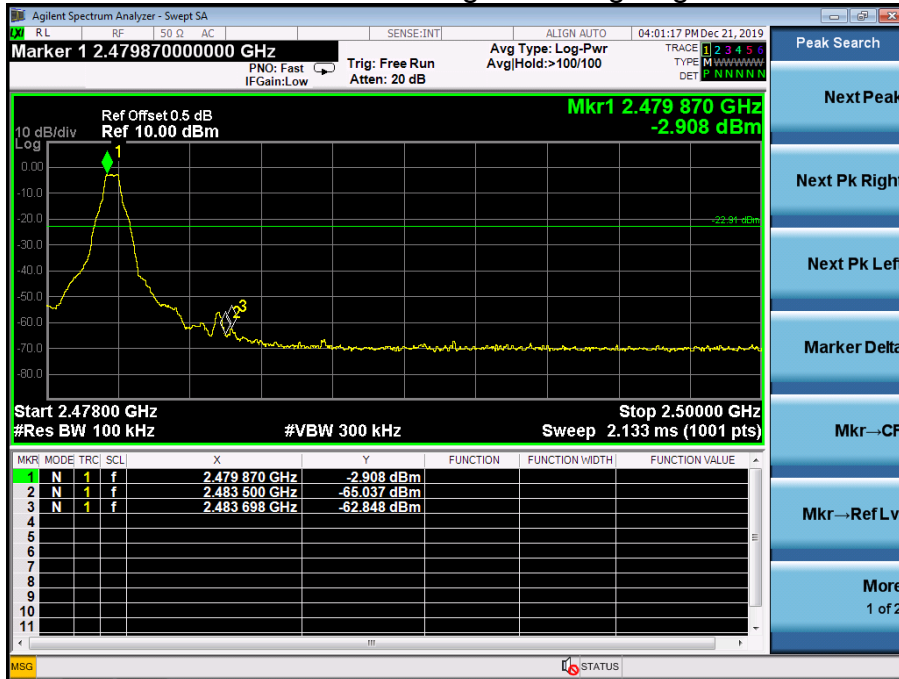

GFSK Hopping Band edge-right side

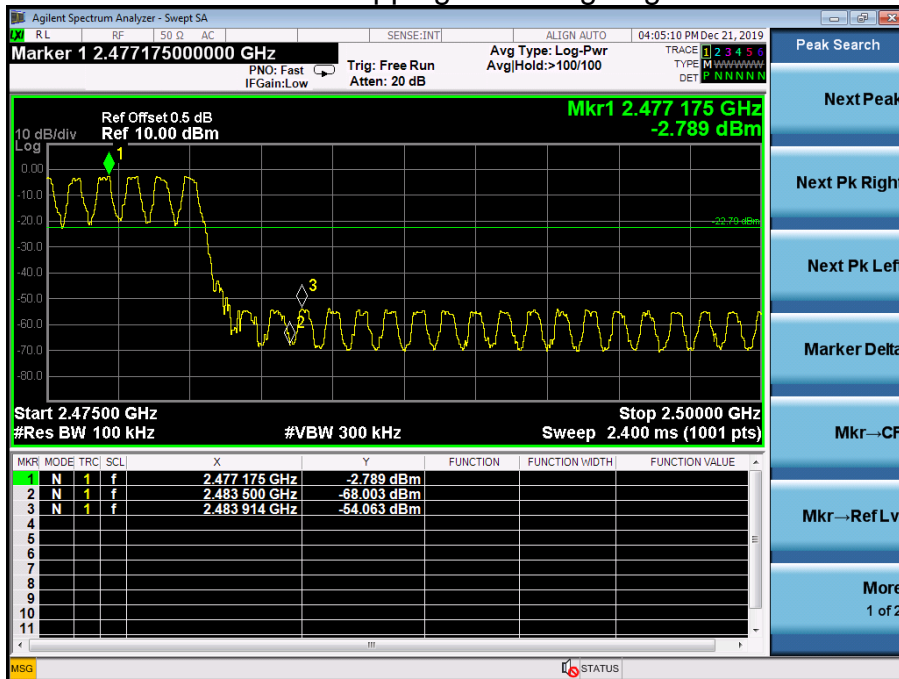

Pi/4 DQPSK Transmitting Band edge-left side

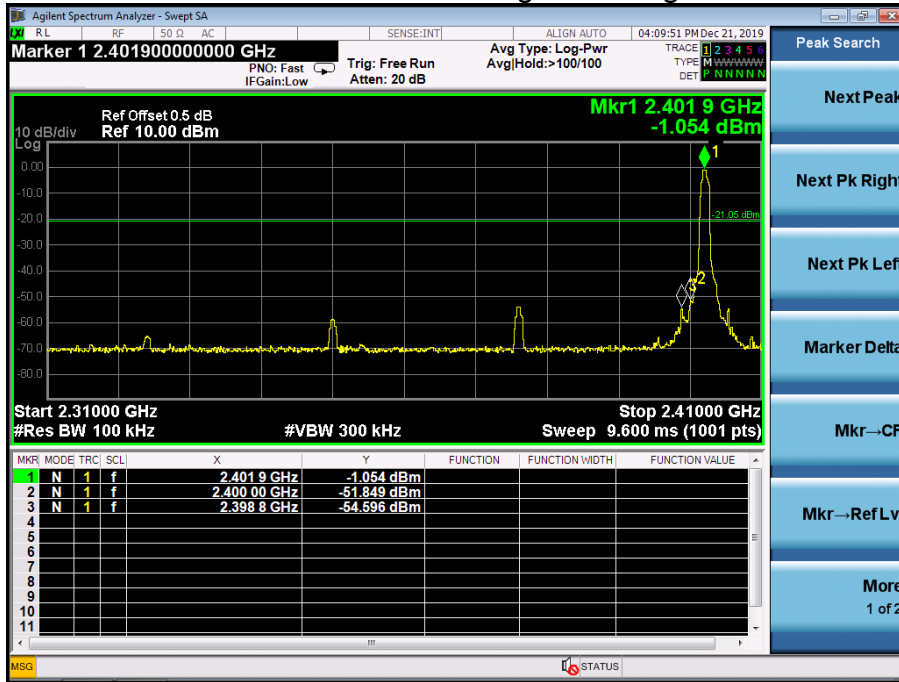

Pi/4 DQPSK Hopping Band edge-left side

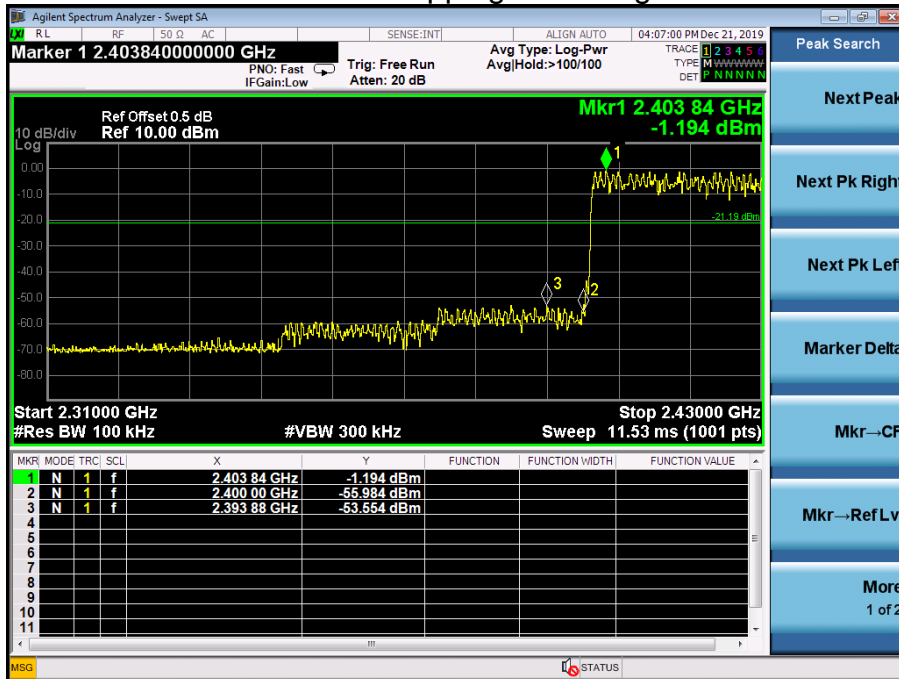

Pi/4 DQPSK Transmitting Band edge-right side

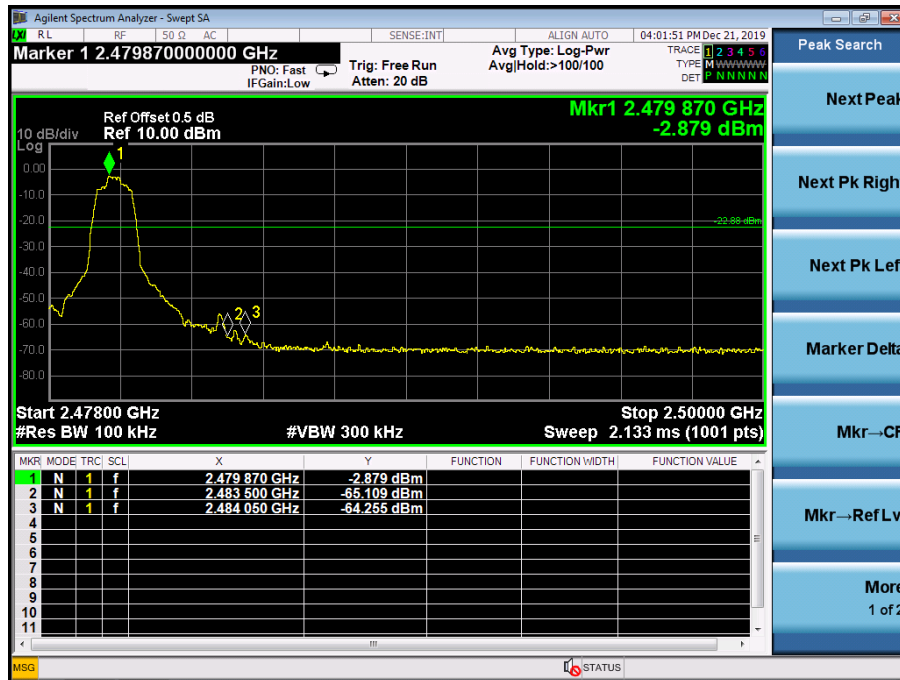

Pi/4 DQPSK Hopping Band edge-right side

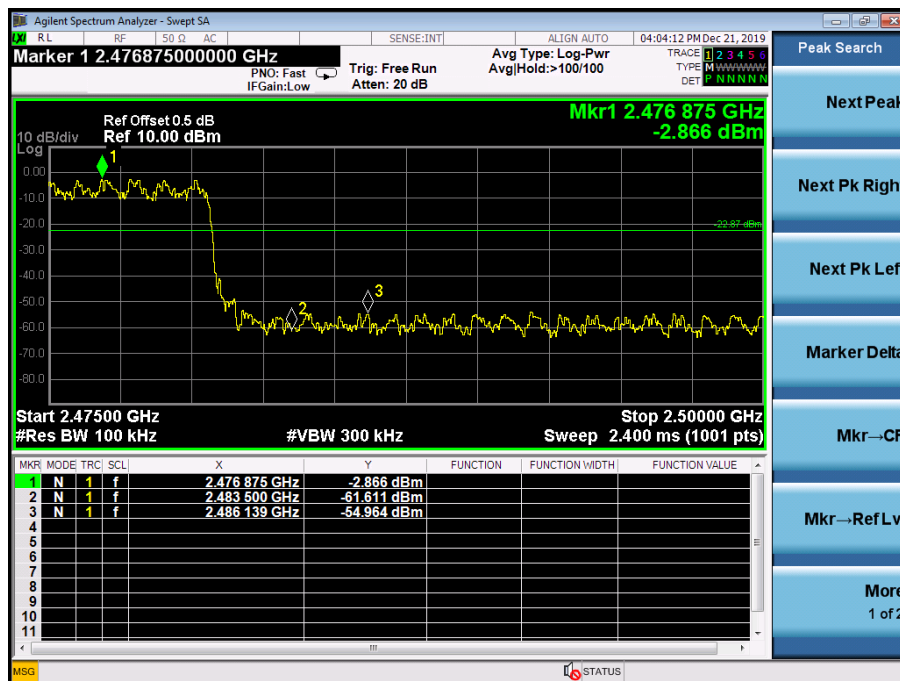

8DPSK Transmitting Band edge-left side

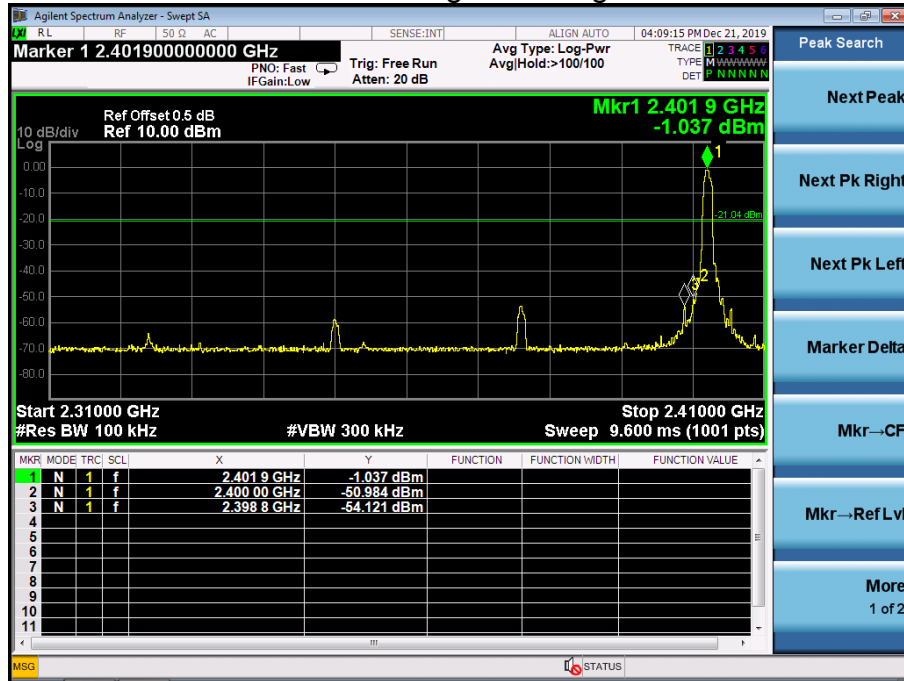

8DPSK Hopping Band edge-left side

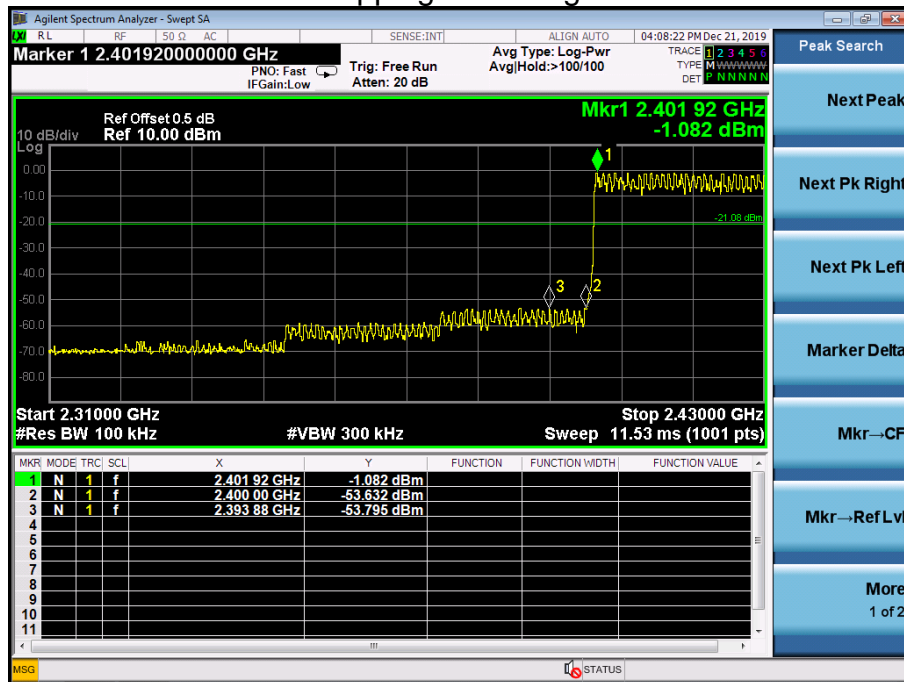

8DPSK Transmitting Band edge-right side

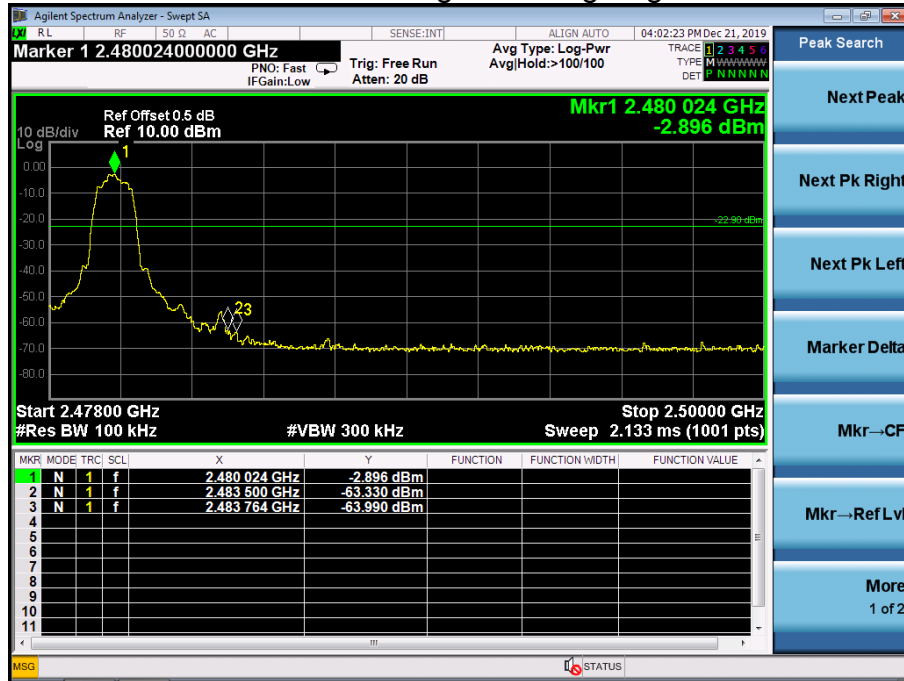

8DPSK Hopping Band edge-right side

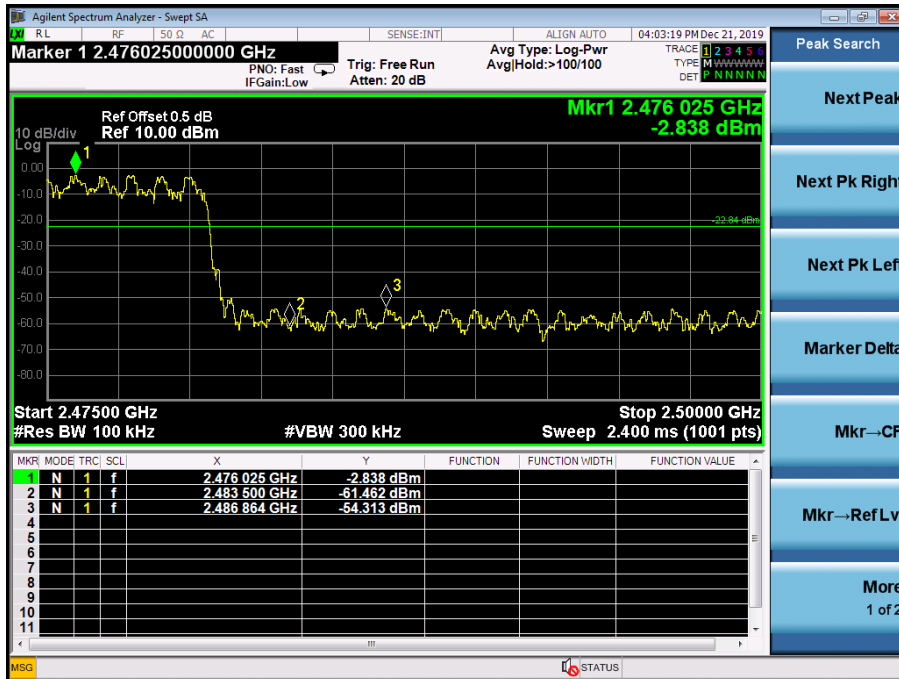

9. 20 DB BANDWIDTH

9.1 Block Diagram Of Test Setup

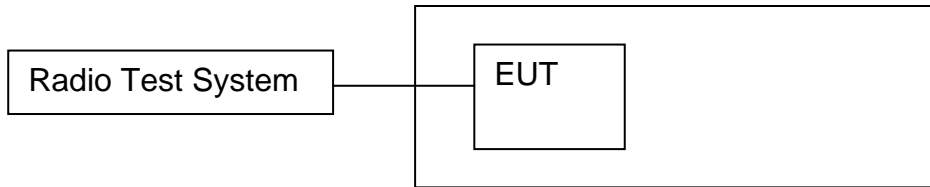

9.2 Limit

N/A

9.3 Test procedure

1. Set RBW = 30 kHz.
2. Set the video bandwidth (VBW) $\geq 3 \times$ RBW.
3. Detector = Peak.
4. Trace mode = max hold.
5. Sweep = auto couple.
6. Allow the trace to stabilize.
7. Measure the maximum width of the emission that is constrained by the frequencies associated with the two outermost amplitude points (upper and lower frequencies) that are attenuated by 20 dB relative to the maximum level measured in the fundamental emission.

9.4 Test Result

| Modulation | Test Channel | Bandwidth(MHz) |
|------------|--------------|----------------|
| GFSK | Low | 0.882 |
| GFSK | Middle | 0.880 |
| GFSK | High | 0.881 |
| Pi/4 DQPSK | Low | 1.265 |
| Pi/4 DQPSK | Middle | 1.265 |
| Pi/4 DQPSK | High | 1.261 |
| 8DPSK | Low | 1.246 |
| 8DPSK | Middle | 1.248 |
| 8DPSK | High | 1.245 |

Test plots
GFSK Low Channel

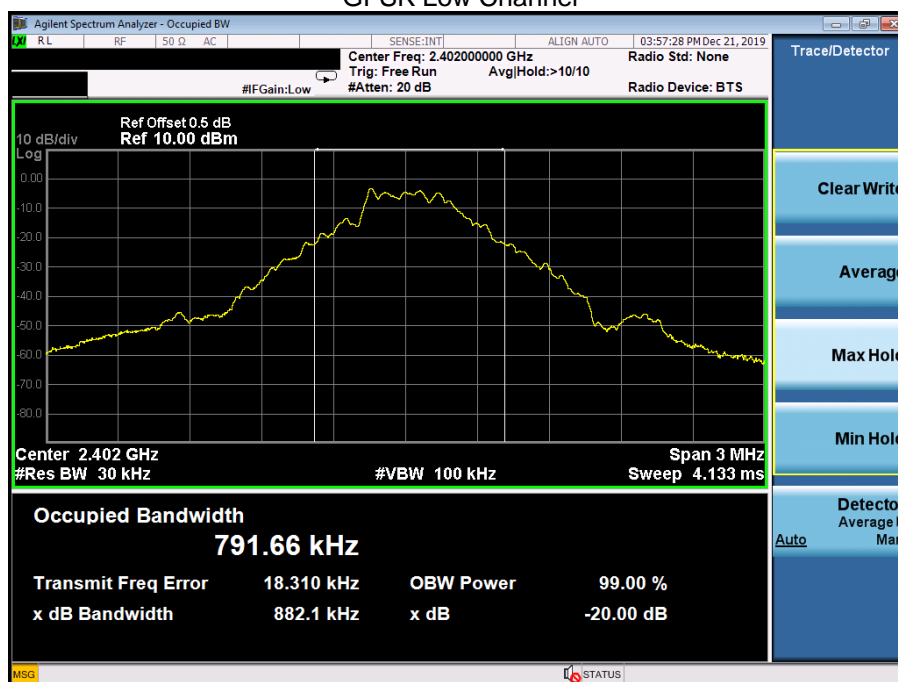

GFSK Middle Channel

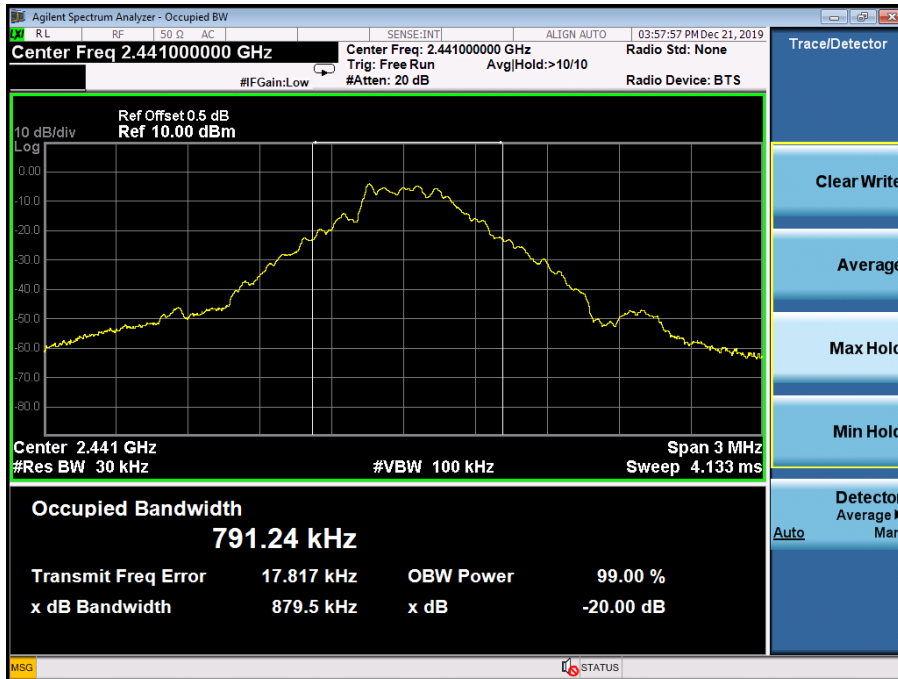

GFSK High Channel

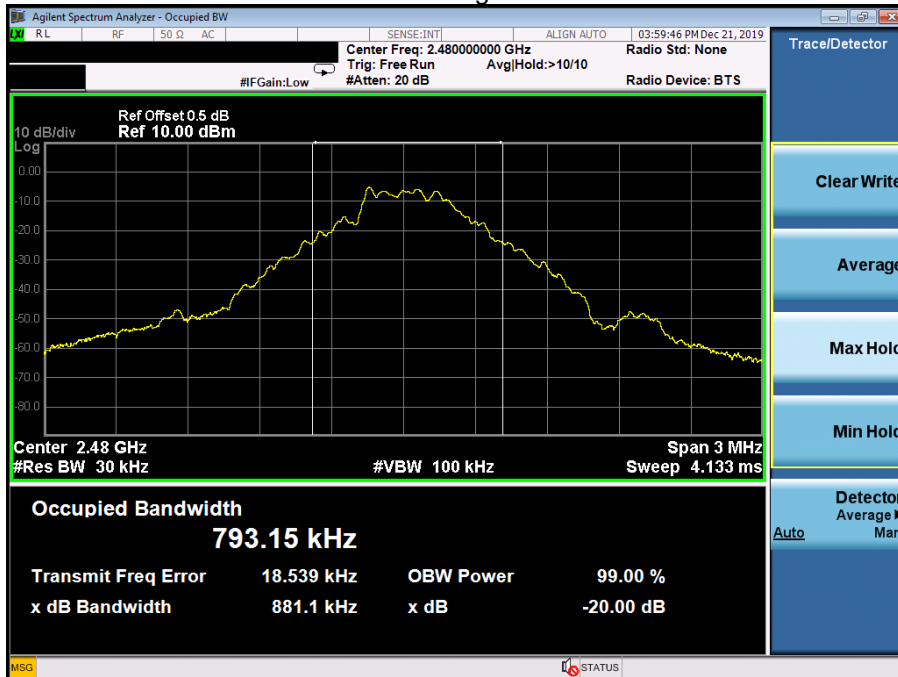

Pi/4 DQPSK Low Channel

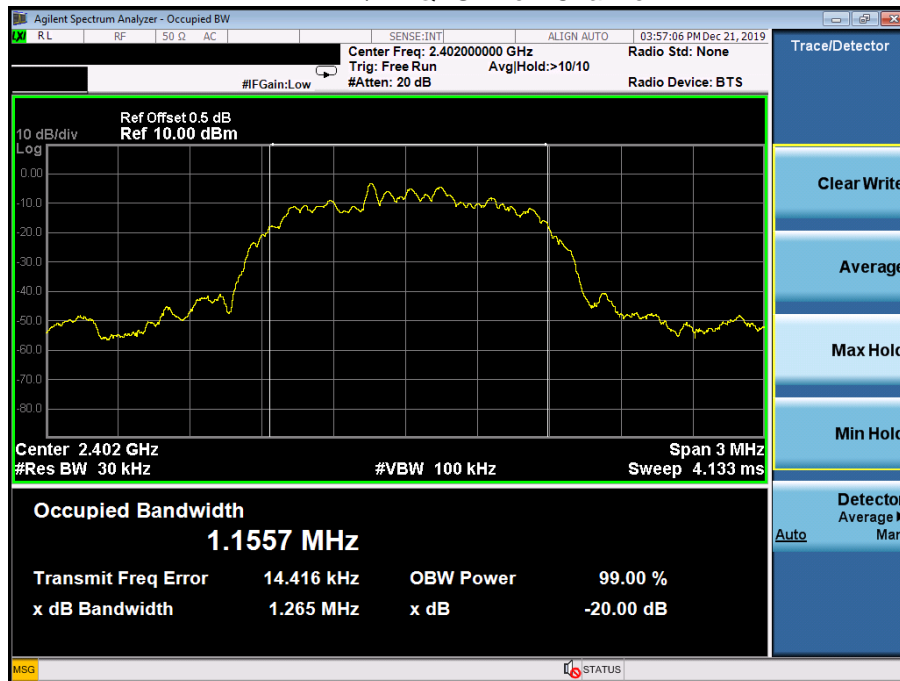

Pi/4 DQPSK Middle Channel

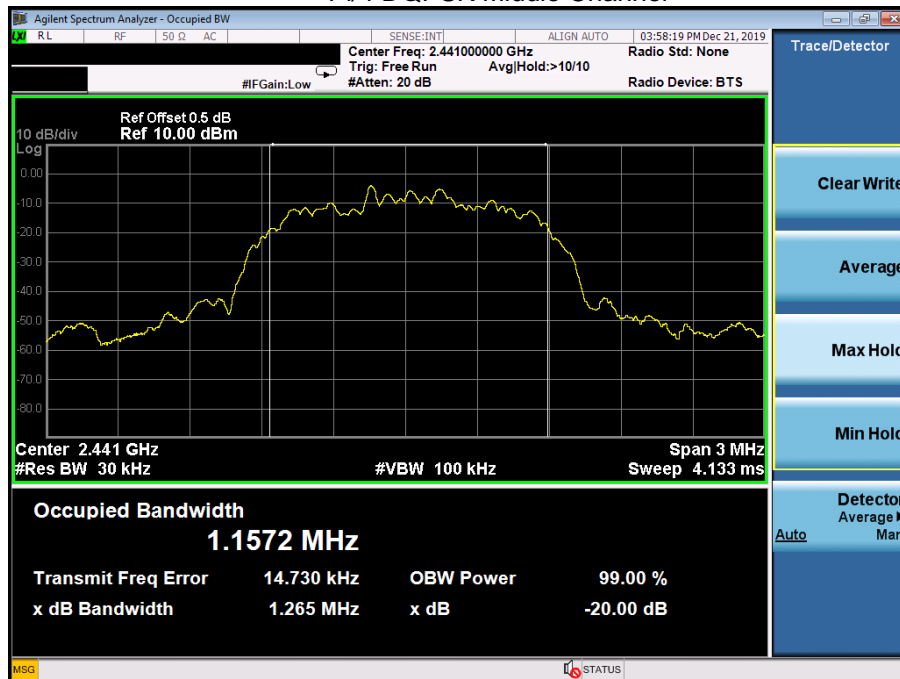

Pi/4 DQPSK High Channel

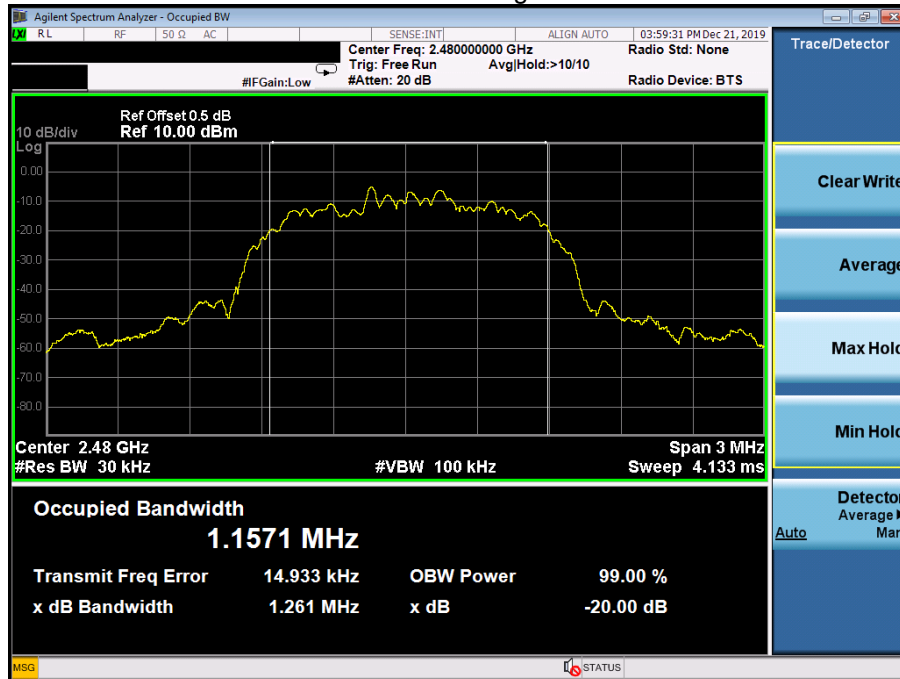

8DPSK Low Channel

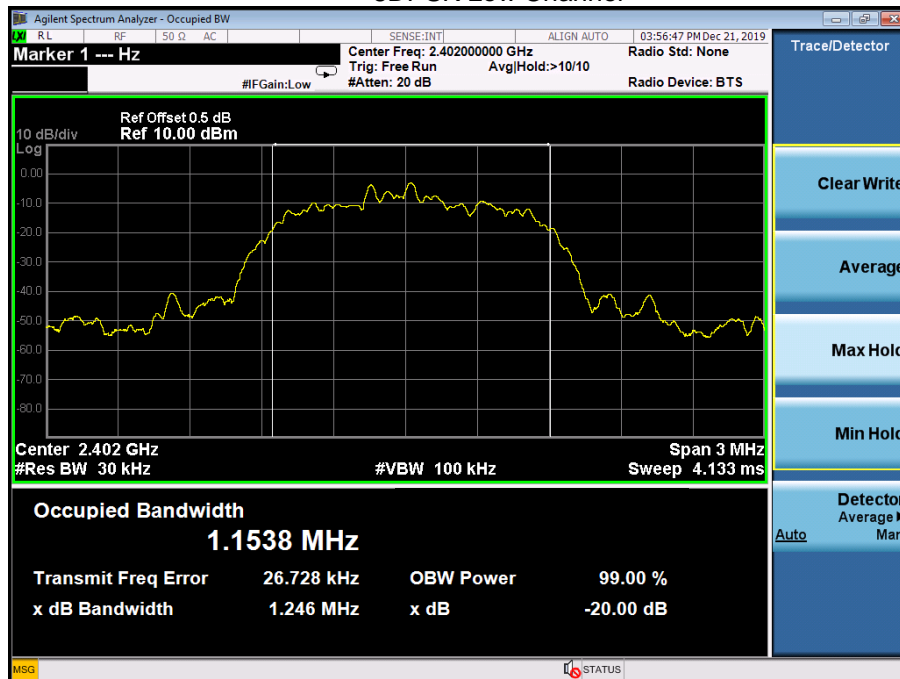

8DPSK Middle Channel

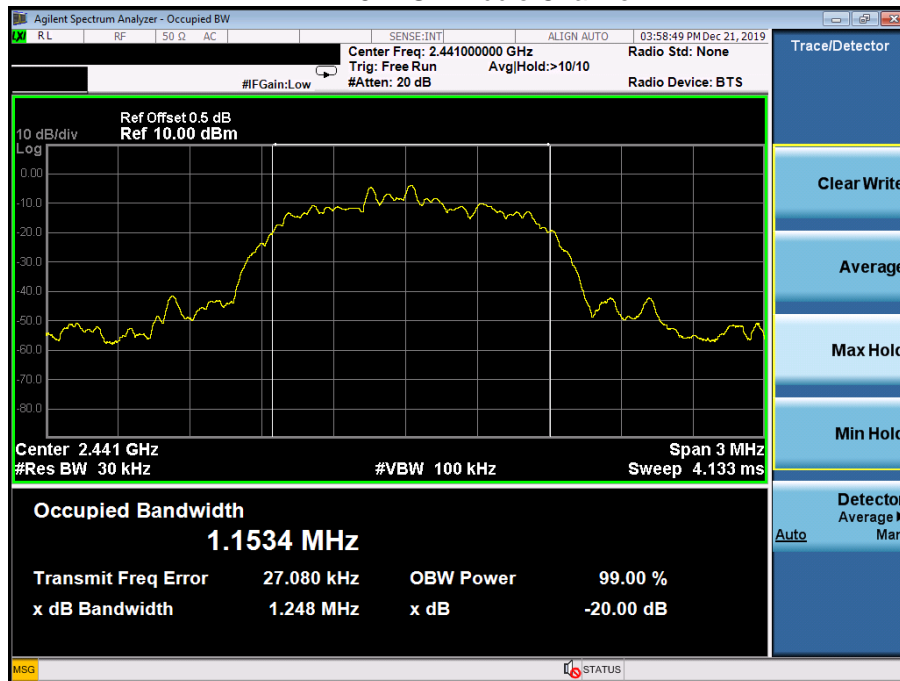

8DPSK High Channel

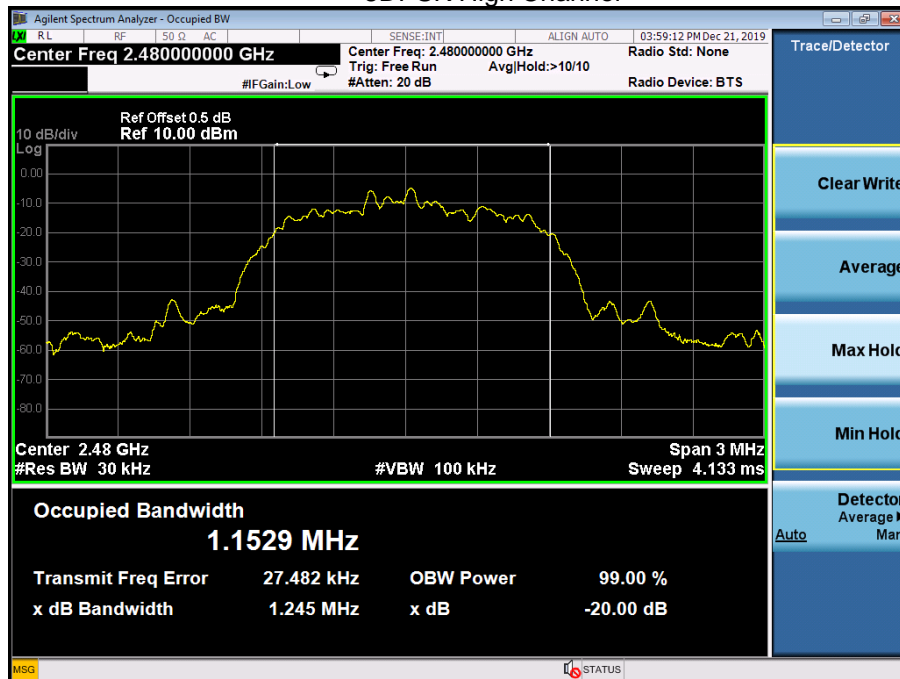

10. MAXIMUM PEAK OUTPUT POWER

10.1 Block Diagram Of Test Setup

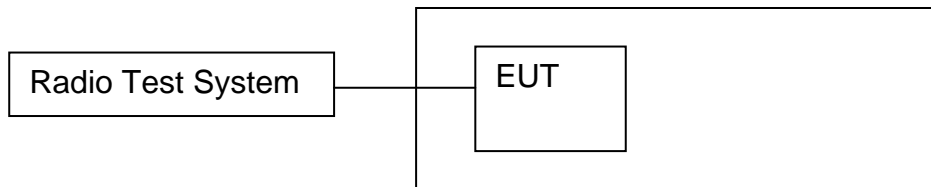

10.2 Limit

For frequency hopping systems operating in the 2400-2483.5 MHz band employing at least 75 non-overlapping hopping channels, and all frequency hopping systems in the 5725-5850 MHz band: 1 watt. For all other frequency hopping systems in the 2400-2483.5 MHz band: 0.125 watts.

10.3 Test procedure

1. Remove the antenna from the EUT and then connect a low RF cable from the antenna port to the spectrum.
2. Set the spectrum analyzer: RBW = 3MHz. VBW = 3MHz. Sweep = auto; Detector Function = Peak.
3. Keep the EUT in transmitting at lowest, medium and highest channel individually. Record the max value.

10.4 Test Result

| Modulation | Test Channel | Output Power (dBm) | Limit (dBm) |
|------------|--------------|--------------------|-------------|
| GFSK | Low | -0.91 | 21 |
| GFSK | Middle | -1.78 | 21 |
| GFSK | High | -2.83 | 21 |
| Pi/4 DQPSK | Low | 1.51 | 21 |
| Pi/4 DQPSK | Middle | 0.63 | 21 |
| Pi/4 DQPSK | High | -0.47 | 21 |
| 8DPSK | Low | 2.15 | 21 |
| 8DPSK | Middle | 1.25 | 21 |
| 8DPSK | High | 0.17 | 21 |

Test plots
GFSK Low Channel

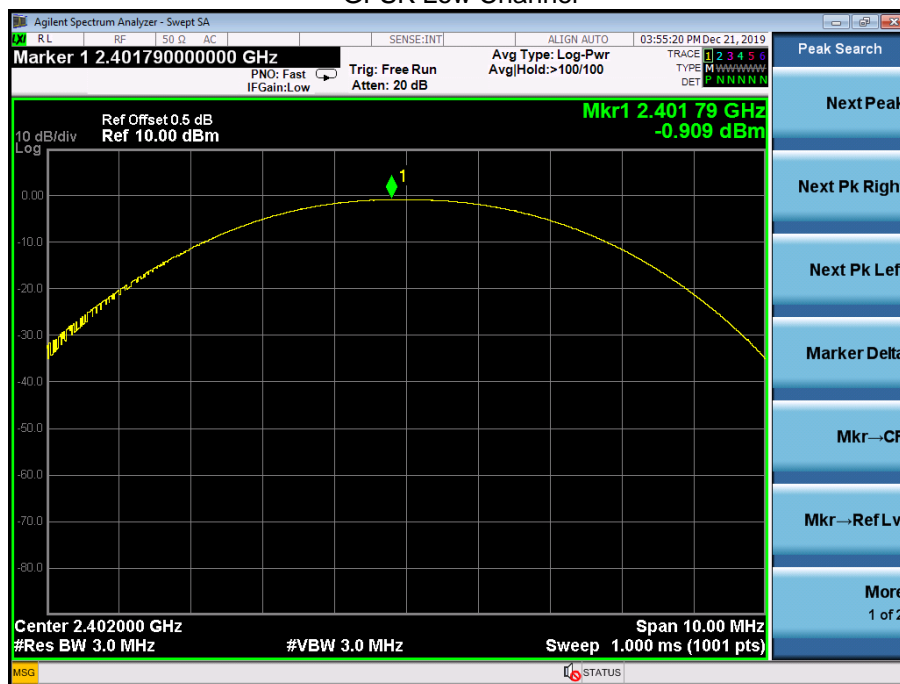

GFSK Middle Channel



GFSK High Channel

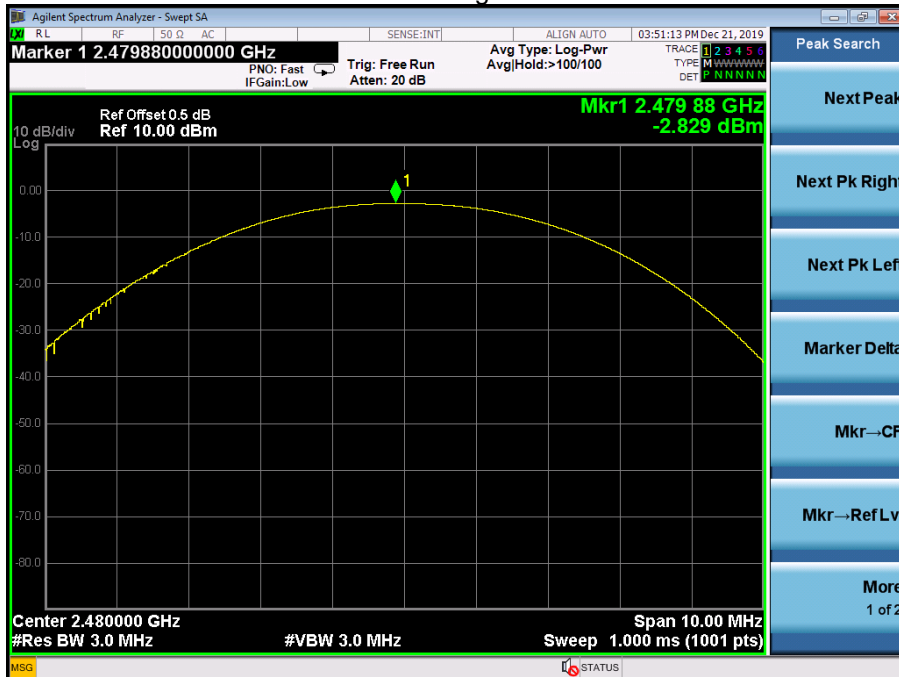

Pi/4 DQPSK Low Channel

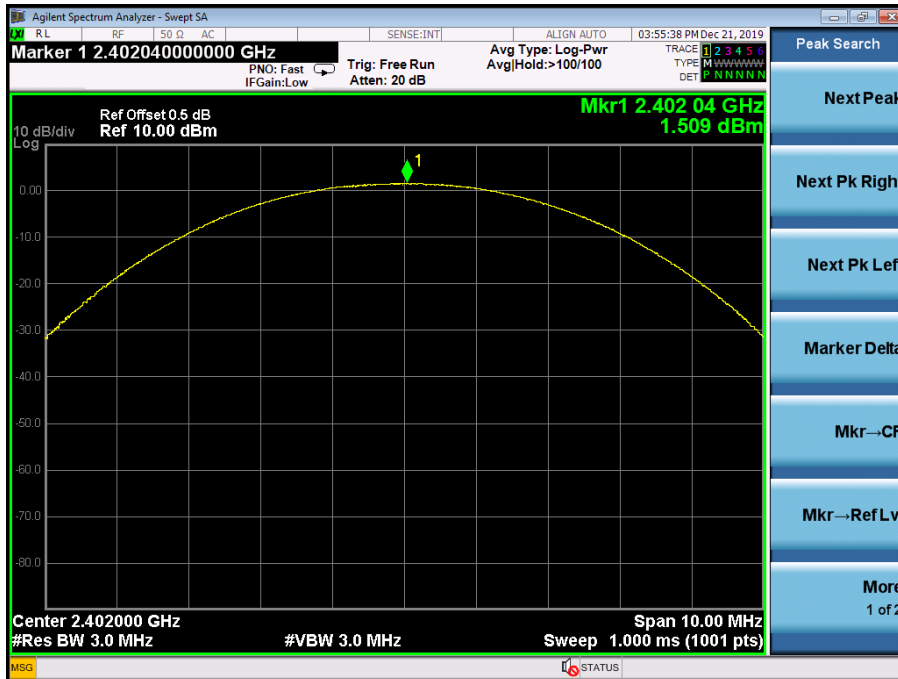

Pi/4 DQPSK Middle Channel

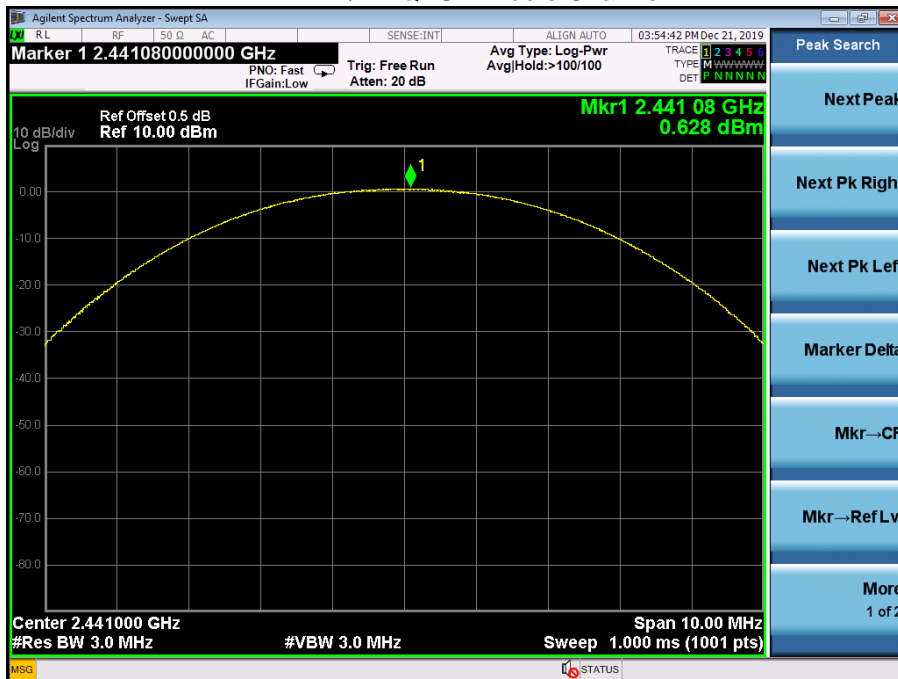

Pi/4 DQPSK High Channel

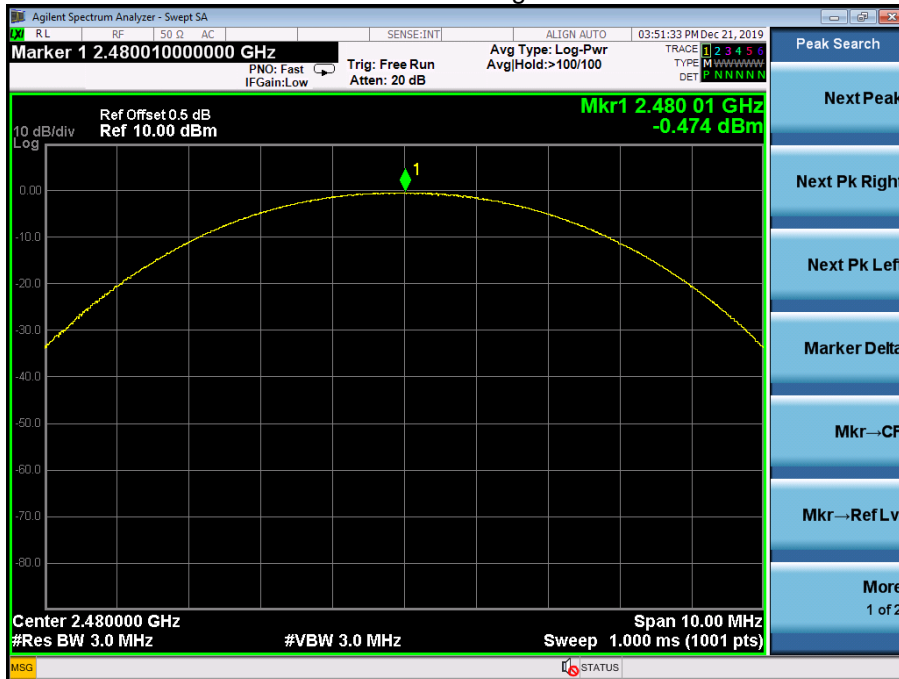

8DPSK Low Channel

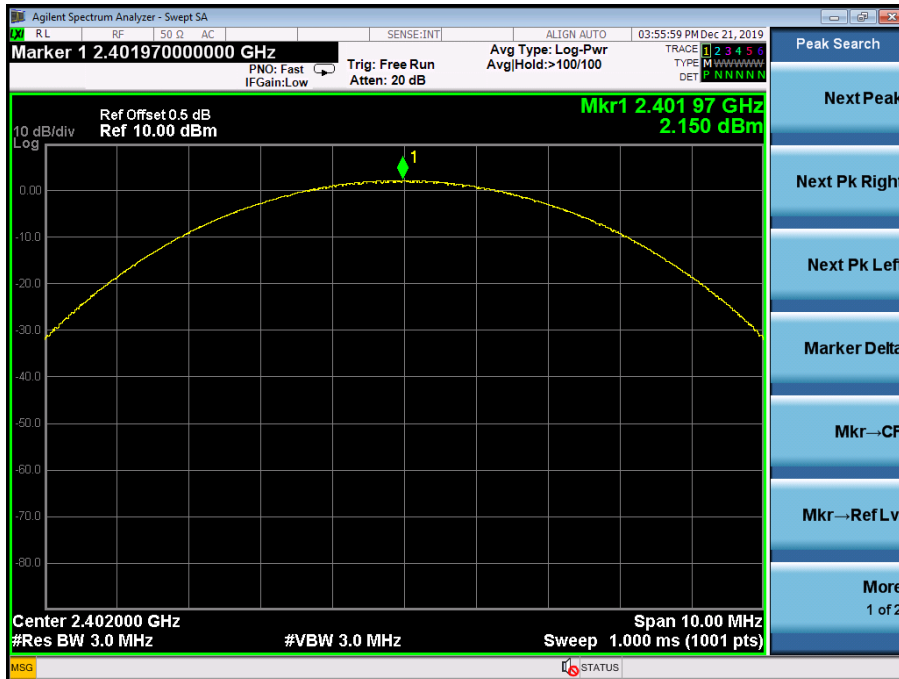

8DPSK Middle Channel

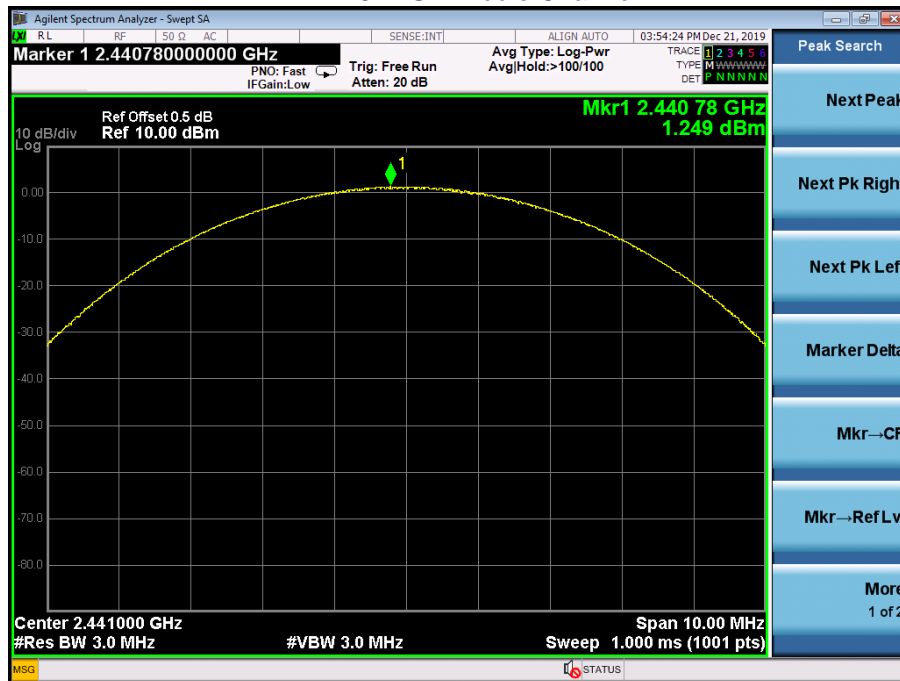

8DPSK High Channel

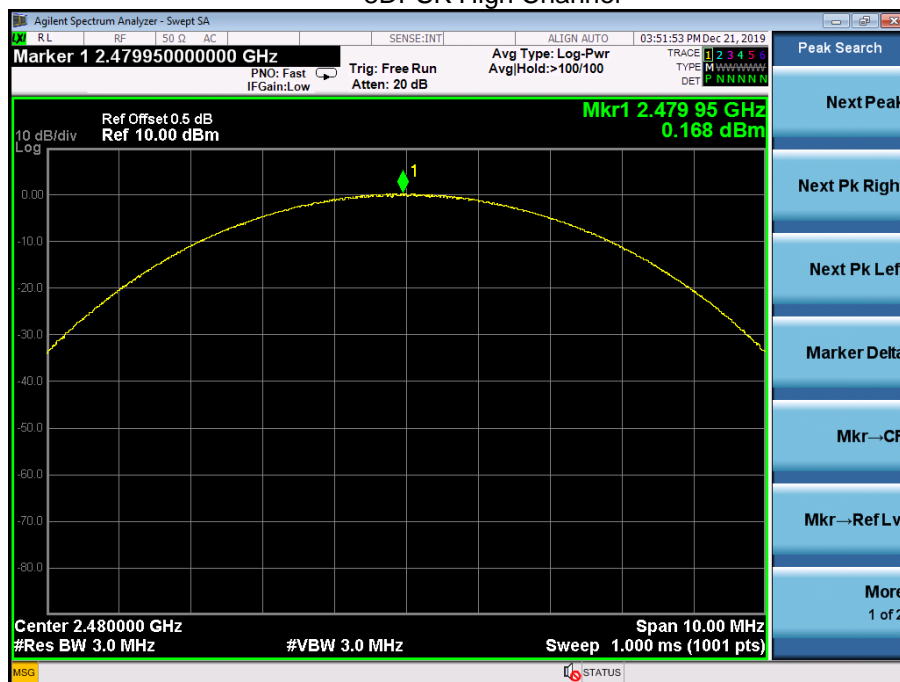

11. HOPPING CHANNEL SEPARATION

11.1 Block Diagram Of Test Setup

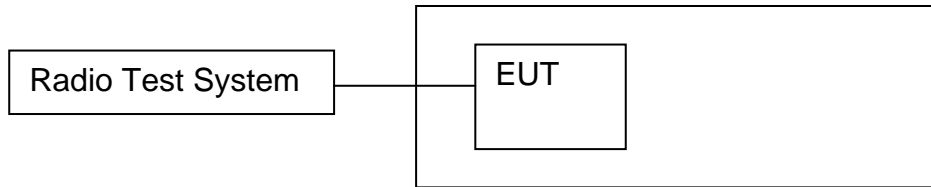

11.2 Limit

Frequency hopping systems shall have hopping channel carrier frequencies separated by a minimum of 25 kHz or the 20 dB bandwidth of the hopping channel, whichever is greater. Alternatively, frequency hopping systems operating in the 2400-2483.5 MHz band may have hopping channel carrier frequencies that are separated by 25 kHz or two-thirds of the 20 dB bandwidth of the hopping channel, whichever is greater, provided the systems operate with an output power no greater than 0.125W.

11.3 Test procedure

1. Remove the antenna from the EUT and then connect a low RF cable from the antenna port to the spectrum.
2. Set the spectrum analyzer: RBW = 30kHz. VBW = 100kHz , Span = 2.0MHz. Sweep = auto; Detector Function = Peak. Trace = Max hold.
3. Allow the trace to stabilize. Use the marker-delta function to determine the separation between the peaks of the adjacent channels. The limit is specified in one of the subparagraphs of this Section Submit this plot.

11.4 Test Result

| Modulation | Test Channel | Separation (MHz) | Limit(MHz) | Result |
|------------|--------------|------------------|------------|--------|
| GFSK | Low | 1.000 | 0.588 | PASS |
| GFSK | Middle | 1.000 | 0.587 | PASS |
| GFSK | High | 1.004 | 0.587 | PASS |
| Pi/4 DQPSK | Low | 1.002 | 0.843 | PASS |
| Pi/4 DQPSK | Middle | 1.002 | 0.843 | PASS |
| Pi/4 DQPSK | High | 1.000 | 0.841 | PASS |
| 8DPSK | Low | 1.002 | 0.831 | PASS |
| 8DPSK | Middle | 1.002 | 0.832 | PASS |
| 8DPSK | High | 1.000 | 0.830 | PASS |

Test plots
GFSK Low Channel



GFSK Middle Channel



GFSK High Channel



Pi/4 DQPSK Low Channel



Pi/4 DQPSK Middle Channel



Pi/4 DQPSK High Channel



8DPSK Low Channel



8DPSK Middle Channel



8DPSK High Channel



12. NUMBER OF HOPPING FREQUENCY

12.1 Block Diagram Of Test Setup

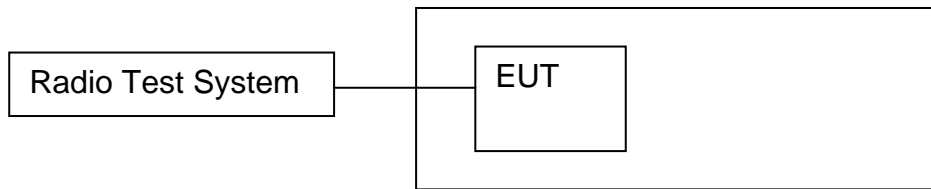

12.2 Limit

Frequency hopping systems in the 2400-2483.5 MHz band shall use at least 15 channels.

12.3 Test procedure

1. Remove the antenna from the EUT and then connect a low RF cable from the antenna port to the spectrum.
2. Set the spectrum analyzer: RBW = 100kHz. VBW = 300kHz. Sweep = auto; Detector Function = Peak. Trace = Max hold.
3. Allow the trace to stabilize. It may prove necessary to break the span up to sections. in order to clearly show all of the hopping frequencies. The limit is specified in one of the subparagraphs of this Section.
4. Set the spectrum analyzer: Start Frequency = 2.4GHz, Stop Frequency = 2.4835GHz. Sweep=auto;

12.4 Test Result

Test Plots: 79 Channels in total GFSK

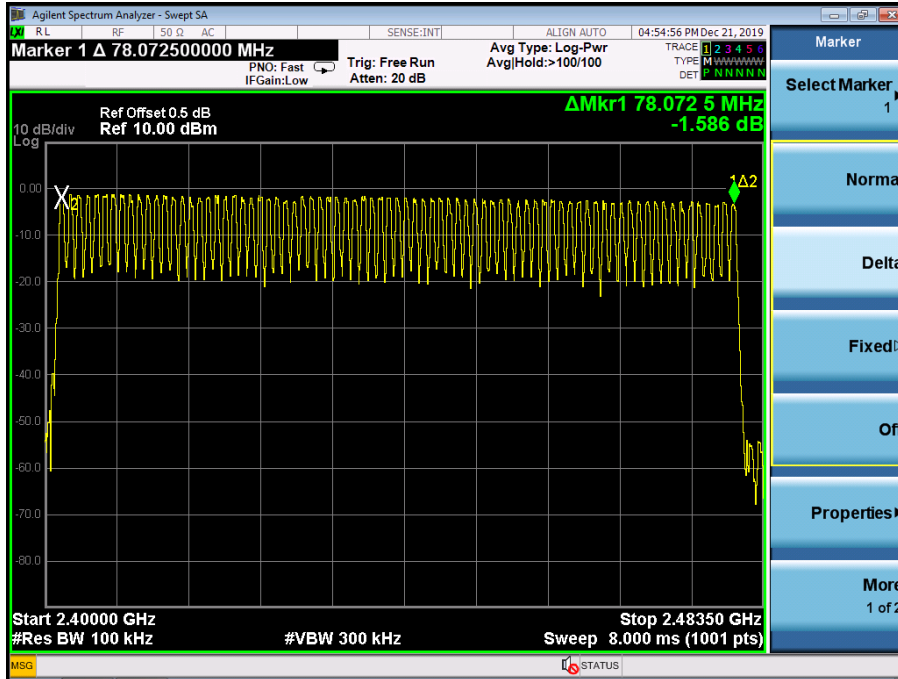

Pi/4 DQPSK

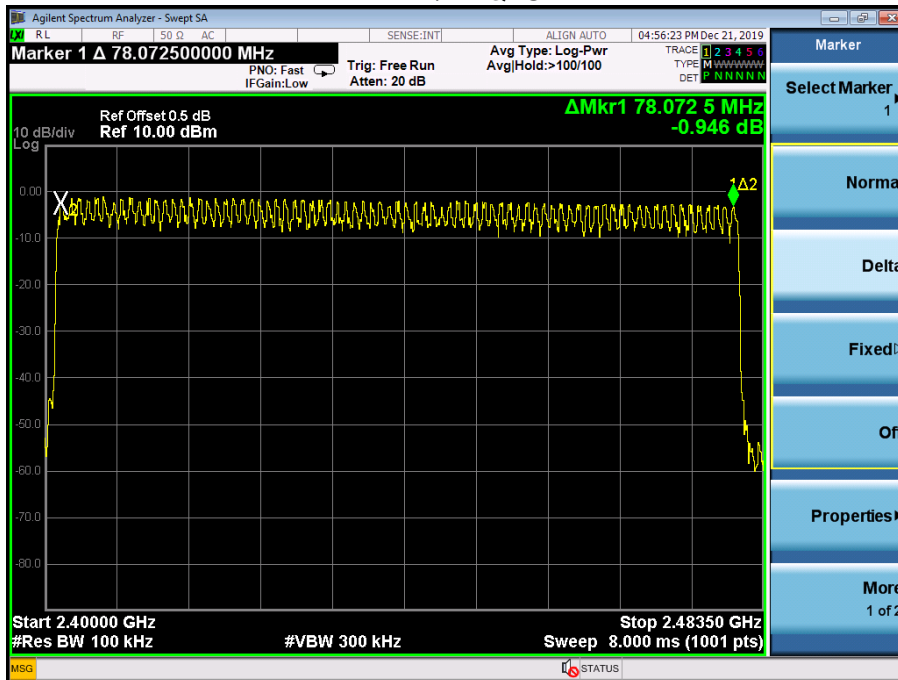

8DPSK

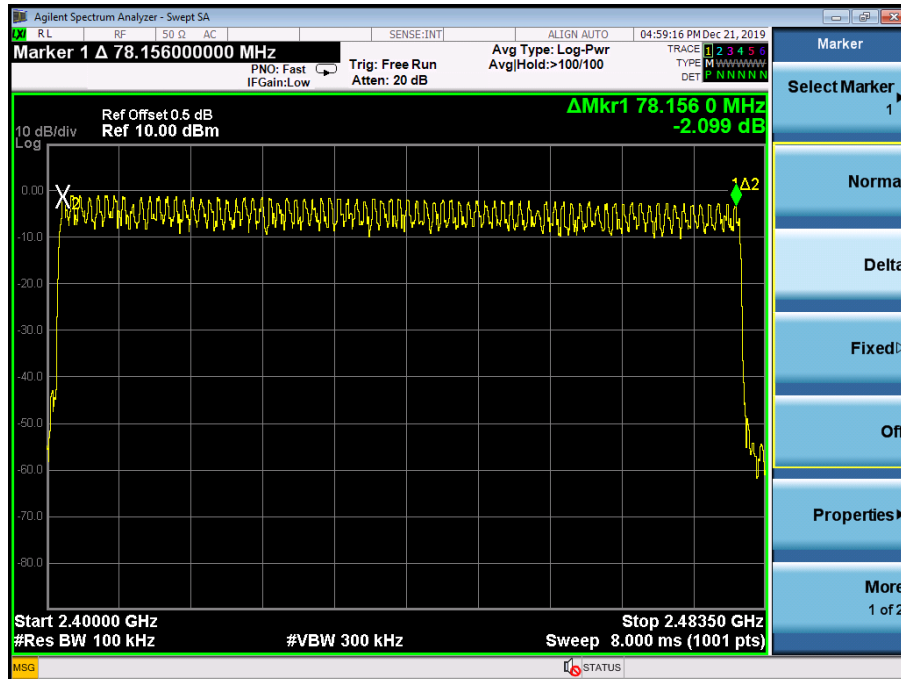

13. DWELL TIME

13.1 Block Diagram Of Test Setup

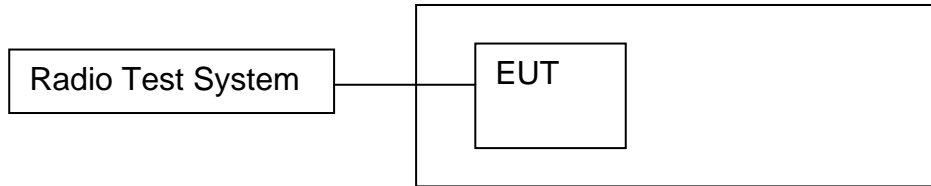

13.2 Limit

Frequency hopping systems in the 2400-2483.5 MHz band shall use at least 15 channels. The average time of occupancy on any channel shall not be greater than 0.4 seconds within a period of 0.4 seconds multiplied by the number of hopping channels employed. Frequency hopping systems may avoid or suppress transmissions on a particular hopping frequency provided that a minimum of 15 channels are used.

13.3 Test procedure

1. Remove the antenna from the EUT and then connect a low RF cable from the antenna port to the spectrum.
2. Set spectrum analyzer span = 0. Centred on a hopping channel;
3. Set RBW = 1MHz and VBW = 3MHz. Sweep = as necessary to capture the entire dwell time per hopping channel. Set the EUT for DH5, DH3 and DH1 packet transmitting.
4. Use the marker-delta function to determine the dwell time. If this value varies with different modes of operation (e.g., data rate, modulation format, etc.), repeat this test for each variation. The limit is specified in one of the subparagraphs of this Section. Submit this plot(s).

13.4 Test Result

DH5 Packet permit maximum 1600 / 79 / 6 hops per second in each channel (5 time slots RX, 1 time slot TX).

DH3 Packet permit maximum 1600 / 79 / 4 hops per second in each channel (3 time slots RX, 1 time slot TX).

DH1 Packet permit maximum 1600 / 79 / 2 hops per second in each channel (1 time slot RX, 1 time slot TX). So, the Dwell Time can be calculated as follows:

DH5: $1600/79/6 \times 0.4 \times 79 \times (\text{MkrDelta}) / 1000$

DH3: $1600/79/4 \times 0.4 \times 79 \times (\text{MkrDelta}) / 1000$

DH1: $1600/79/2 \times 0.4 \times 79 \times (\text{MkrDelta}) / 1000$

Remark: Mkr Delta is once pulse time.

| Modulation | Channel Data | Packet | pulse time(ms) | Dwell Time(s) | Limits(s) |
|------------|--------------|--------|----------------|---------------|-----------|
| GFSK | Middle | DH1 | 0.406 | 0.130 | 0.4 |
| | | DH3 | 1.668 | 0.267 | 0.4 |
| | | DH5 | 2.930 | 0.313 | 0.4 |
| Pi/4DQPSK | Middle | 2DH1 | 0.416 | 0.133 | 0.4 |
| | | 2DH3 | 1.680 | 0.269 | 0.4 |
| | | 2DH5 | 2.930 | 0.313 | 0.4 |
| 8DPSK | Middle | 3DH1 | 0.417 | 0.133 | 0.4 |
| | | 3DH3 | 1.674 | 0.268 | 0.4 |
| | | 3DH5 | 2.940 | 0.314 | 0.4 |

Test Plots
GFSK DH1 Middle Channel

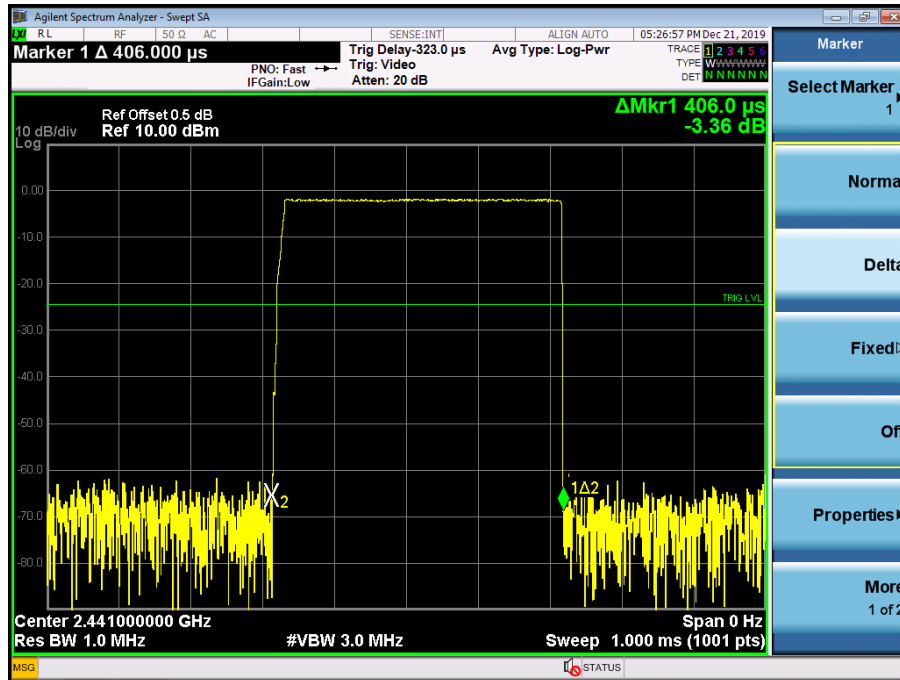

GFSK DH3 Middle Channel

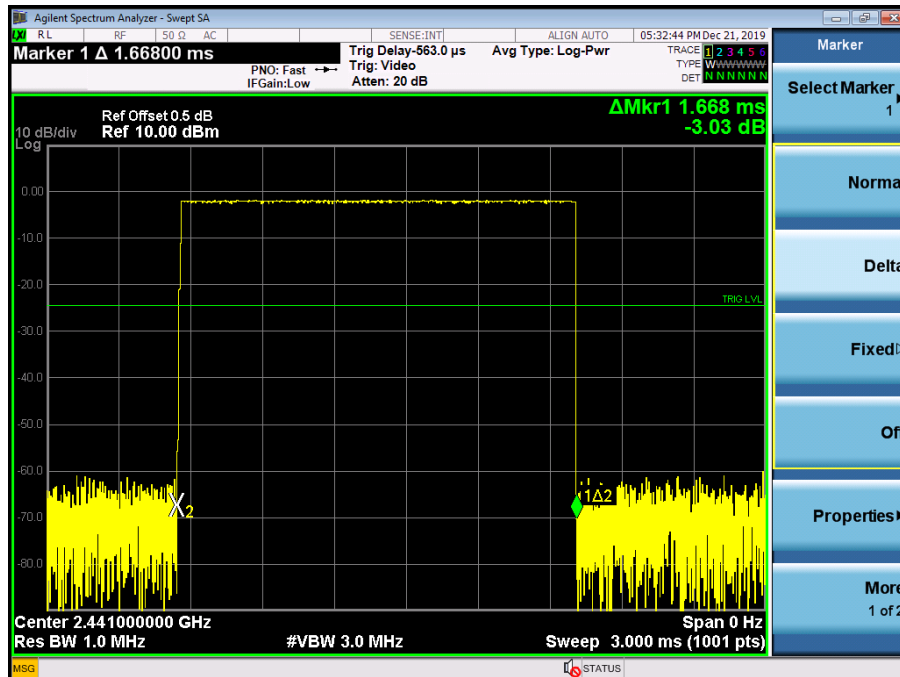

GFSK DH5 High Middle Channel

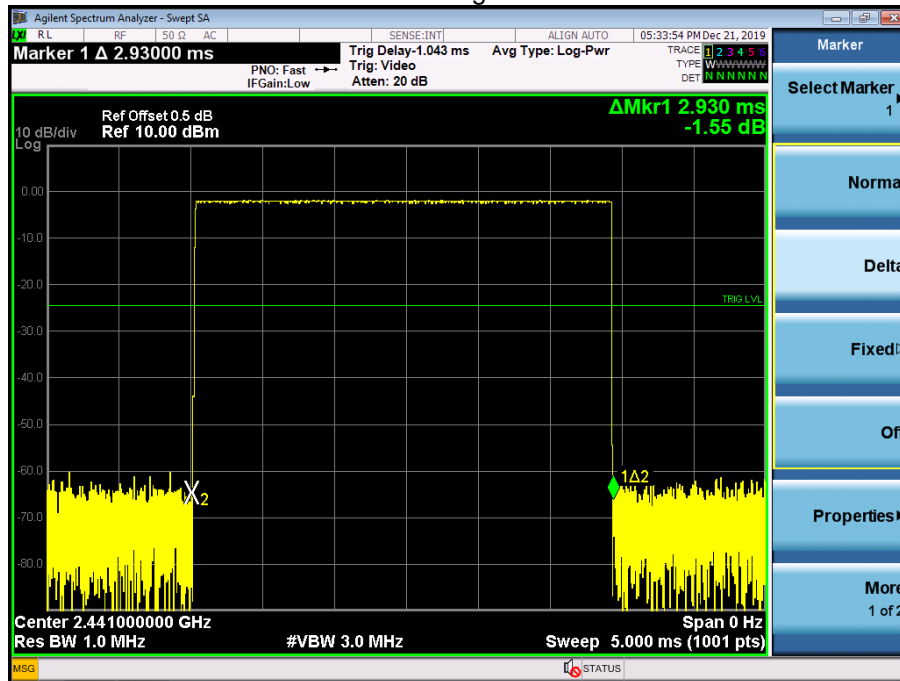

Pi/4DQPSK DH1 Middle Channel

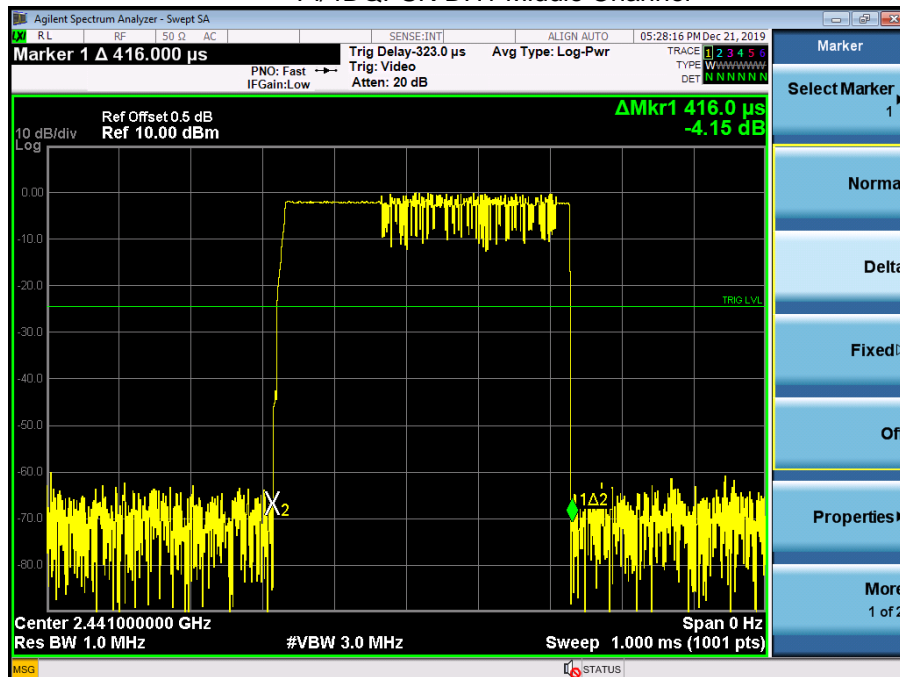

Pi/4DQPSK DH3 Middle Channel

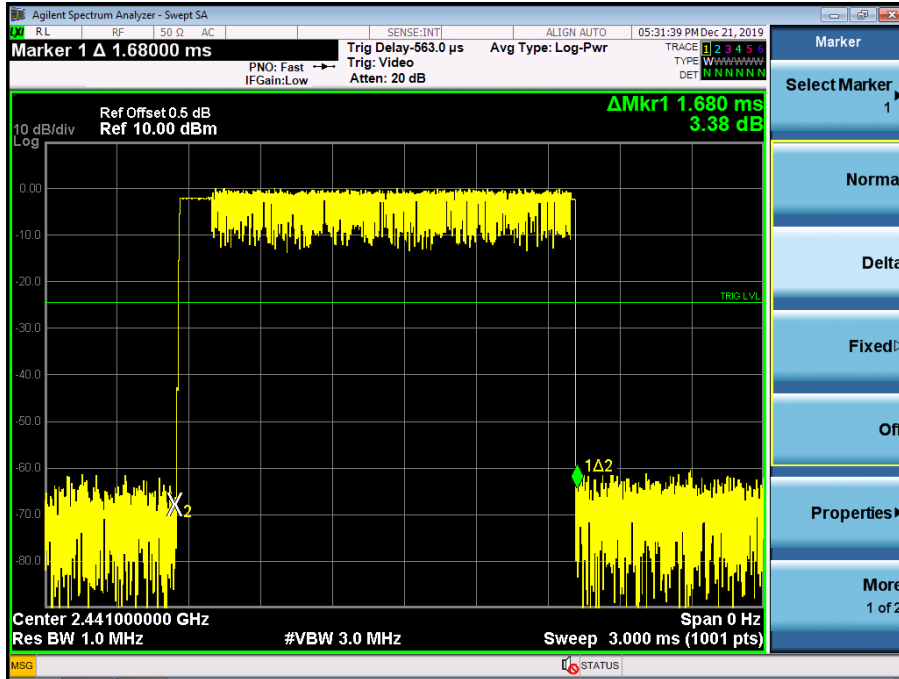

Pi/4DQPSK DH5 Middle Channel

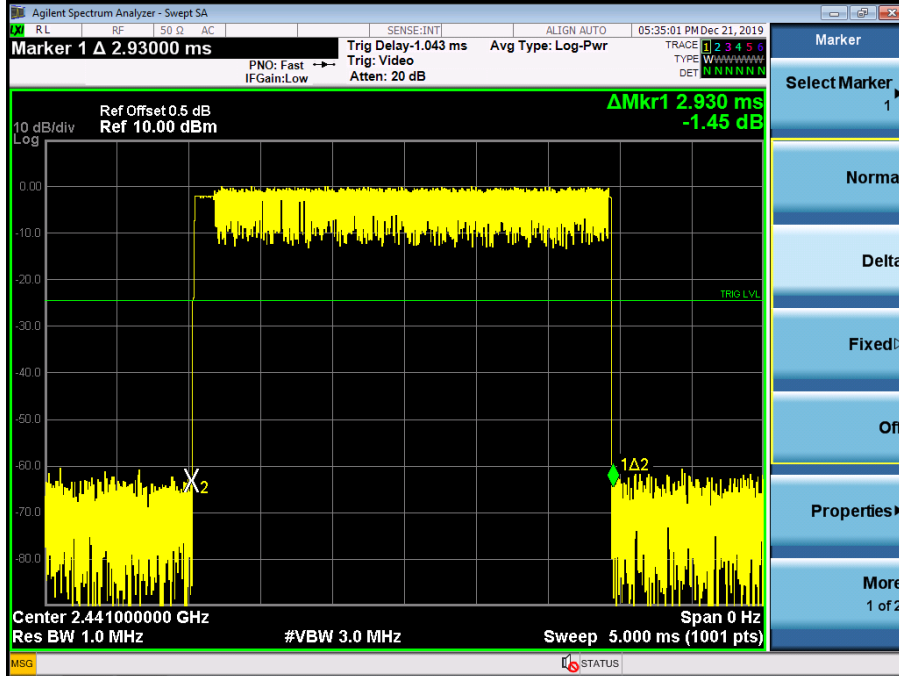

8DPSK DH1 Middle Channel

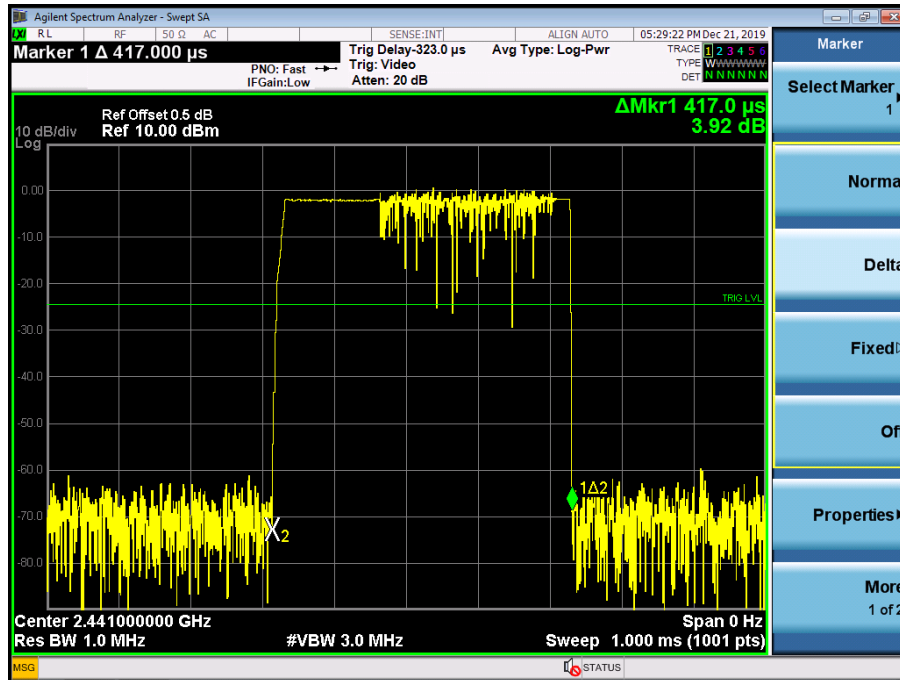

8DPSK DH3 Middle Channel



8DPSK DH5 Middle Channel

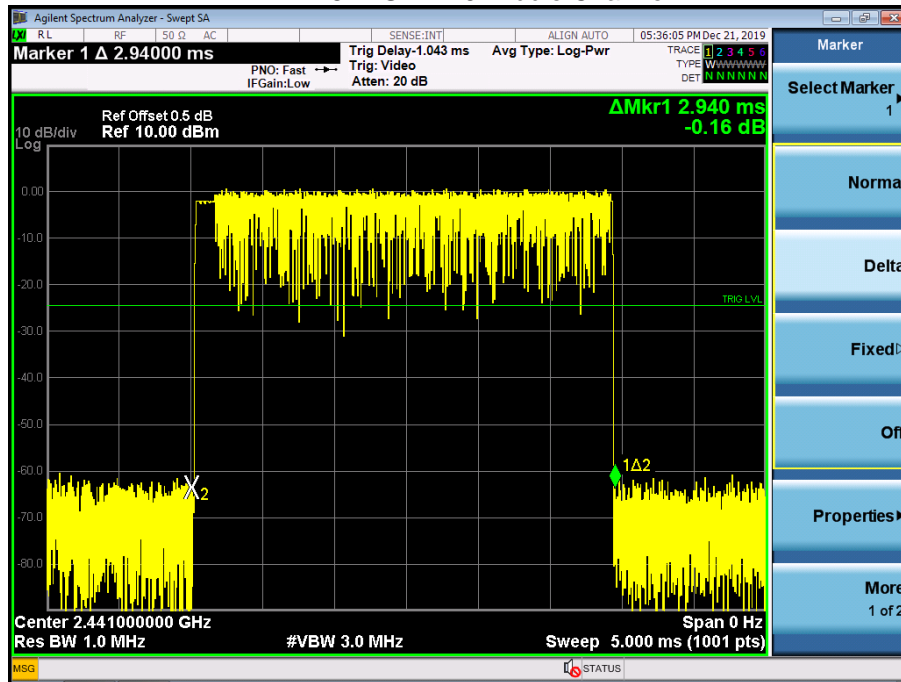

14. ANTENNA REQUIREMENT

An intentional radiator shall be designed to ensure that no antenna other than that furnished by the responsible party shall be used with the device. The use of a permanently attached antenna or of an antenna that uses a unique coupling to the intentional radiator shall be considered sufficient to comply with the provisions of this section. The manufacturer may design the unit so that a broken antenna can be replaced by the user, but the use of a standard antenna jack or electrical connector is prohibited. This requirement does not apply to carrier current devices or to devices operated under the provisions of §15.211, §15.213, §15.217, §15.219, or §15.221. Further, this requirement does not apply to intentional radiators that must be professionally installed, such as perimeter protection systems and some field disturbance sensors, or to other intentional radiators which, in accordance with §15.31(d), must be measured at the installation site. However, the installer shall be responsible for ensuring that the proper antenna is employed so that the limits in this part are not exceeded.

For intentional device, according to FCC 47 CFR Section 15.203, an intentional radiator shall be designed to ensure that no antenna other than that furnished by the responsible party shall be used with the device.

The EUT antenna is Internal PCB antenna, antenna Gain 0dBi. It comply with the standard requirement.

15. EUT PHOTOGRAPHS

EUT Photo 1



EUT Photo 2

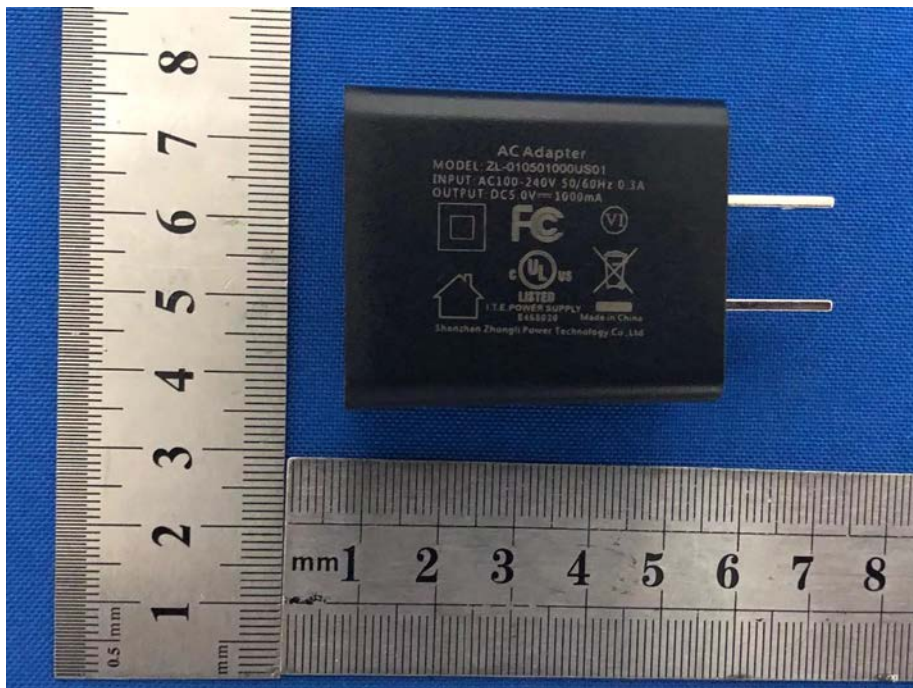

EUT Photo 3



EUT Photo 4



16. EUT TEST SETUP PHOTOGRAPHS

Conducted Measurement Photos



Radiated Measurement Photos



***** END OF REPORT *****