

无线收音麦克风

产品使用说明书

三合一多功能接收端



MADE IN CHINA

产品介绍

感谢您选择我们的产品。本产品为智能无线麦克风，可提供专业级别的录音输出。即插即用，无需APP。多种用途：可实现网络直播、视频Vlog拍摄、节目访谈、采访录音、视频教学等场合的使用。

无线收音麦克风由两部分构成，麦克风发射端，三合一多功能接收端。（如下图所示）

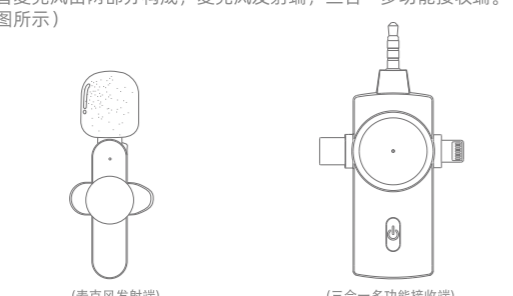

产品结构图

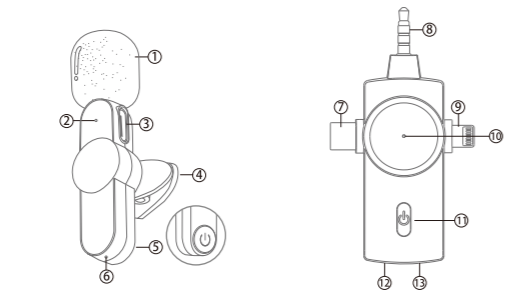

- ① 防风棉
- ② 麦克风指示灯
- ③ 麦克风Type-C充电接口
- ④ 麦克风夹
- ⑤ 麦克风开关键
- ⑥ 麦克风复位键
- ⑦ 接收端Type-C接口
- ⑧ 接收端3.5mm接口
- ⑨ 接收端Lightning接口
- ⑩ 接收端指示灯
- ⑪ 接收端开关键
- ⑫ 接收端Type-C充电接口
- ⑬ 接收端3.5mm监听音频转接口

*上图的编号⑬的作用将在后面作出特别的说明。

Lightning/Type-C接收端使用方法

第一步：首先把Lightning接收端或者Type-C接收端插入手机的Lightning接口或者Type-C接口，接收端绿灯快闪。

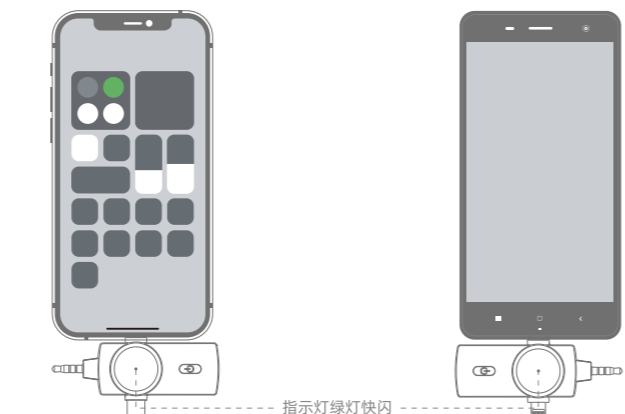

第二步：单击麦克风的开机键，指示灯亮绿灯，即开机成功。

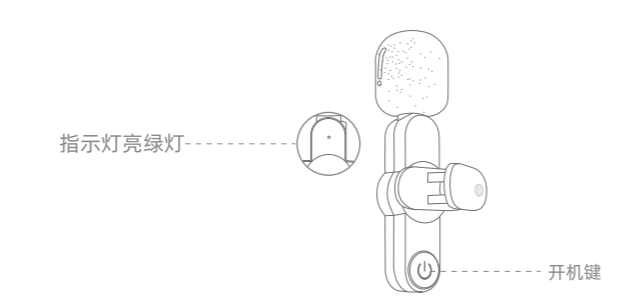

第三步：接收端绿灯常亮，手机打开相机、直播视频等APP即可使用麦克风收音。

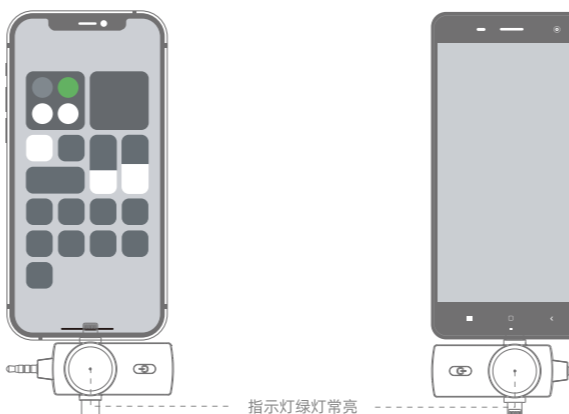

特别说明：
第⑬的使用方法如下：如果直播时，手机电量不足的情况下，外接电源直接通过接收端Type-C接口给予手机充电。

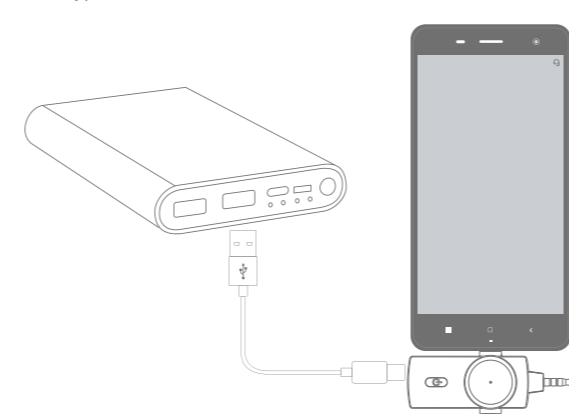

3.5mm接收端使用方法

第一步：首先把3.5mm接收端插入3.5mm接口设备，指示灯绿灯常亮。

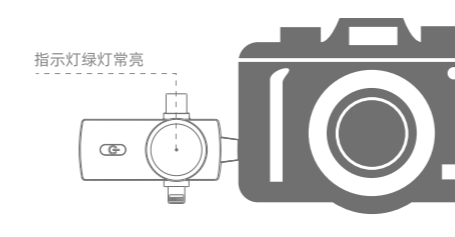

第二步：单击麦克风和接收端的开机键，指示灯亮绿灯，即开机成功。

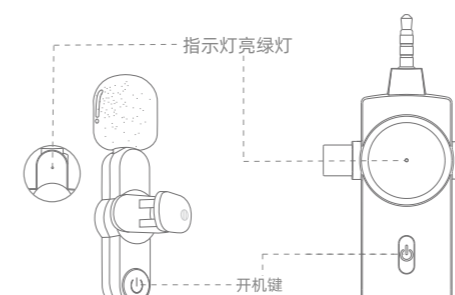

第三步：打开设备，即可使用麦克风收音。

UI功能

麦克风发射端

功能/状态	操作	灯效
开机	按键单击	绿灯亮
关机	按键长按3-4s/ 无线连接超过10分钟自动关机	绿灯灭
充电	Type-c线充电	红灯常亮，充满红灯灭
搜索配对	/	绿灯慢闪
配对成功	/	绿灯常亮
低电量报警	电量低于20%	蓝灯慢闪
复位	长按3秒	/
暂停	按键单击	蓝灯常亮
清除配对	快速按下 复位键清除配对	绿灯快闪

Lightning接收端

功能/状态	操作	灯效/提示音
开机	插入设备上电	绿灯闪
关机	拔掉设备断电	灯灭
搜索配对	/	绿灯慢闪
配对成功	/	绿灯亮
清除配对	开机后10秒内快速 按电源键三下	绿灯快闪
监听音量加减 循环控制	双击电源开关键	一声“嗒”：最小音量 两声“嗒”：中等音量 三声“嗒”：最大音量

Type-c接收端

功能/状态	操作	灯效/提示音
开机	插入设备上电	绿灯闪
关机	拔掉设备断电	灯灭
搜索配对	/	绿灯慢闪
配对成功	/	绿灯亮
清除配对	开机后10秒内快速 按电源键三下	绿灯快闪
监听音量加减 循环控制	双击电源开关键	一声“嗒”：最小音量 两声“嗒”：中等音量 三声“嗒”：最大音量

3.5mm接收端

功能/状态	操作	灯效/提示音
开机	单击一下电源开关键	绿灯闪
关机	长按电源开关键3秒	灯灭
搜索配对	/	绿灯慢闪
配对成功	/	绿灯亮
低电状态	电池处于低电状态	红灯闪
清除配对	开机后10秒内快速 按电源键三下	绿灯快闪
监听音量加减 循环控制	双击电源开关键	一声“嗒”：最小音量 两声“嗒”：中等音量 三声“嗒”：最大音量

备注：接收器拔出设备后，方可收听视频或录音效果

包装清单

- 1) 麦克风发射端
- 2) 三合一多功能接收端
- 3) Type-C充电线
- 4) 用户说明书
- 5) 收纳袋
- 6) 3.5mm监听单边有线耳机

****部分安卓手机因系统原因会出现不兼容问题，详情请咨询经销商****

合格 检验员 本产品经验已合格 保修卡

产品编号：_____

检验员：_____

检验日期：_____

Wireless Microphone

User Manual

3-in-1 multi-function receiver



MADE IN CHINA

Introduction

Thanks for choosing our product. This product is a smart wireless microphone that provides professional-grade recording output. Plug and play, no app required. It can be used in different scenes such as Live streaming, Video Recording, Interviewing, Online Teaching and others.

The wireless Microphone consists of two parts, one is Microphone transmitter, the other one is 3-in-1 multi-function receiver (see as below picture)

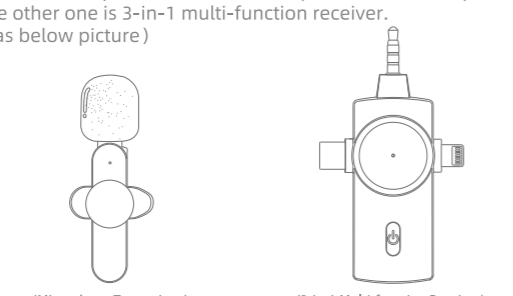

ID Diagram

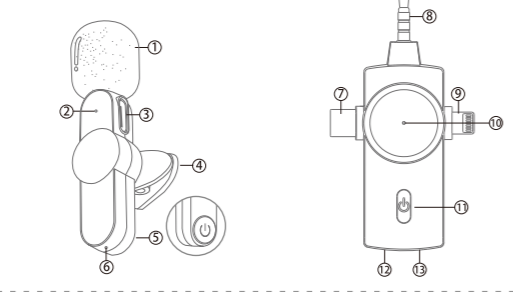

- ① Windproof sponge
- ② Indicator light of microphone
- ③ Type-c charging port of microphone
- ④ Microphone clip
- ⑤ Power button of microphone
- ⑥ Reset key of microphone
- ⑦ Type-C receiver
- ⑧ 3.5 mm receiver
- ⑨ Lightning receiver
- ⑩ Indicator light of receiver
- ⑪ Power button of receiver
- ⑫ Type-C charging port of receiver
- ⑬ 3.5mm audio transfer interface

*The function of above ⑬ will be specifically explained later.

How to use Lightning/Type-C receiver

First: Plug the Lightning or Type-C receiver into the Lightning or Type-C port of mobile phone, the green light of receiver flashes quickly.

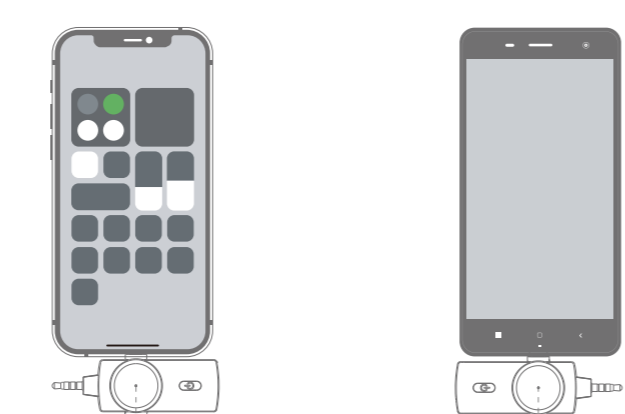

Second: Single press the power button of mic, it is turned on successfully when green light is on.

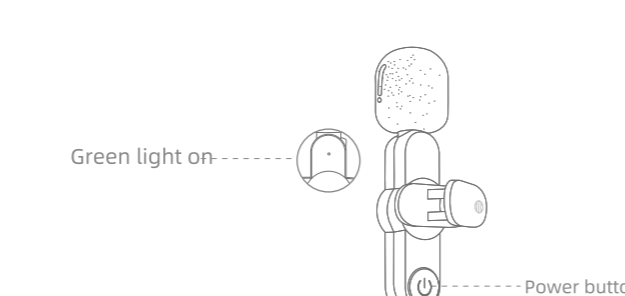

Last: Green light of receiver keeps always on, and then the microphone works when opening phone camera to make a video recording or opening live streaming Apps to make a Live show.

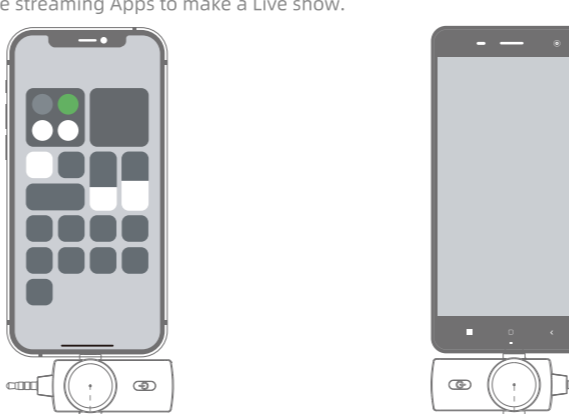

Special Notes:
The for number ⑬: If the mobile phone is in low battery during live streaming, the external power supply directly charges the mobile phone through the Type-C port of the receiver.

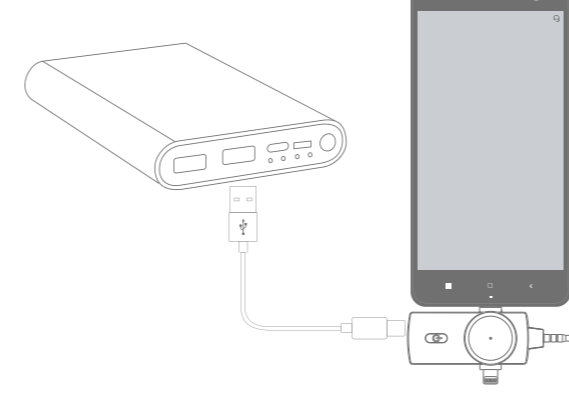

How to use 3.5mm receiver

Step 1: Plug the 3.5mm receiver into the 3.5mm port device, and the green light is always on.

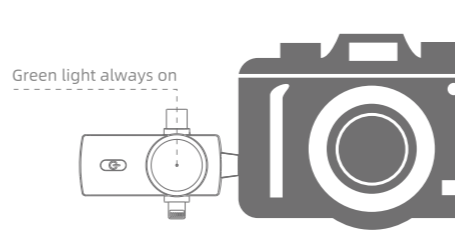

Step 2: Press the power button of mic and receiver, it is turned on successfully when green light is on.

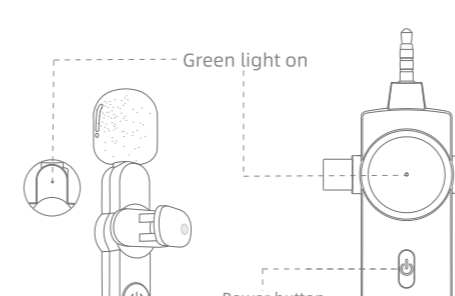

Step 3: Turn on the device, the microphone will work directly.

About UI

Microphone Transmitter

Functions	Operations	Light
Power on	Single press the power button	Green light on
Power off	Press the power button for 3-4s / auto power off with no connection for more than 10min	Green light off
Charging	Type-C cable charging	Red light on when charging, and light off once fully-charged
Search for pairing	/	Green light flashes slowly
Paired	/	Green light always on
Low battery alarm	Battery < 20%	Blue light flashes slowly
Reset	Press reset key for 3s	/
Stop	Single press	Blue light always on
Clear pairing	press reset key quickly twice	Green light flashes quickly

Lightning Receiver

Functions	Operations	Light/Prompt tone
Power on	Plug into the device	Green light flashes
Power off	Plug off the device	Light off
Searching for pairing	/	Green light flashes slowly
Paired	/	Green light on
Clear pairing	Triple press the power button quickly within 10s after power on	Green light flashes quickly
Monitor volume up and down, loop control	Double press the power button	One "beep": minimum volume Two "beep": medium volume Three "beep": maximum volume

Type-C Receiver

Functions	Operations	Light/Prompt tone
Power on	Plug into the device	Green light flashes
Power off	Plug off the device	Light off
Searching for pairing	/	Green light flashes slowly
Paired	/	Green light on
Clear pairing	Triple press the power button quickly within 10s after power on	Green light flashes quickly
Monitor volume up and down, loop control	Double press the power button	One "beep": minimum volume Two "beep": medium volume Three "beep": maximum volume

3.5mm Receiver

Functions	Operations	Light/Prompt tone
Power on	Single touch power button	Green light flashes
Power off	Press power button for 3s	Light off
Searching for pairing	/	Green light flashes slowly
Paired	/	Green light on
Low battery	The battery is in low power	Red light flashes
Clear pairing	Triple press the power button quickly within 10s after power on	Green light flashes quickly
Monitor volume up and down, loop control	Double press the power button	One "beep": minimum volume Two "beep": medium volume Three "beep": maximum volume

Note: You can listen to the video or recording only after the receiver is unplugged from the device.

Packing list

- 1) Microphone transmitter
- 2) 3-in-1 multi-function receiver
- 3) Type-C charging cable
- 4) User manual
- 5) Storage bag
- 6) 3.5 mm single wired earphone

****Some Android phones may have incompatibility issues due to operation system, please consult your dealer for details****

(中英文) AP031说明书
材质：105g双铜+哑胶
尺寸：155*100mm
印刷：正反印（风琴折）

FCC Requirement

Any changes or modifications not expressly approved by the party responsible for compliance could void the user's authority to operate the equipment.

This device complies with Part 15 of the FCC Rules. Operation is subject to the following two conditions:

- (1) this device may not cause harmful interference, and
- (2) this device must accept any interference received, including interference that may cause undesired operation.

Note: This equipment has been tested and found to comply with the limits for a Class B digital device, pursuant to Part 15 of the FCC Rules. These limits are designed to provide reasonable protection against harmful interference in a residential installation. This equipment generates, uses, and can radiate radio frequency energy, and if not installed and used in accordance with the instructions, may cause harmful interference to radio communications. However, there is no guarantee that interference will not occur in a particular installation. If this equipment does cause harmful interference to radio or television reception, which can be determined by turning the equipment off and on, the user is encouraged to try to correct the interference by one or more of the following measures:

- Reorient or relocate the receiving antenna.
- Increase the separation between the equipment and receiver.
- Connect the equipment into an outlet on a circuit different from that to which the receiver is connected.
- Consult the dealer or an experienced radio/TV technician for help.