

We connect · We Protect

We offer suitable solutions to meet customer's specific requirements

Application Note no.004

Chip Antenna Series

Bluetooth \ WLAN Chip Antenna

ACA-5036-A2-CC-S

Prepared	Checked	Approved
Leeting & YM	D.F	Jimmy



INPAQ Technology Co., LTD

<http://www.inpaq.com.tw>

TEL :+886-37-585-555

FAX : +886-37-585-511

Innovation · Nature ·

People · Advance · Quality

Application Note

Bluetooth \ WLAN Chip Antenna – ACA-5036-A2-CC-S

Revision History: 2010-05-25 Rev.A2

Previous Version :

Page	Subjects (major changes since last revision)	Version
All	Make up all document	A0
17~22	Adding recommended layout B and related electrical characteristic	A1
1	Adding dimension raw data	A2

ACA-5036-A2-CC-S Application Note

Catalog

Applications	1
Features	1
Electrical Characteristic	1
Antenna Dimension	1
Recommended PCB Layout	2
Layout Description	4
Performance on Middle of Long Side	5
Typical VSWR.....	5
Free Space Efficiency and Peak Gain.....	5
Typical Free Space 3D Radiation Pattern	6
Typical Free Space 2D Radiation Pattern	7
The Efficiency and Bandwidth for Different Location Layout A	8
Peak Gain and Efficiency on Long Side	9
Peak Gain and Efficiency on Short Side	9
3D Gain Pattern on Long Side	10
3D Gain Pattern on Short Side	11
2D Gain Pattern on Long Side	12
2D Gain Pattern on Short Side	13
Efficiency and Band Width V.S Different Depths of Clearance Area.....	14
Near Metal Effect.....	15

Ground Size V.S Efficiency	16
The Efficiency and Bandwidth for Different Location Layout B	17
Peak Gain and Efficiency on Long Side	18
Peak Gain and Efficiency on Short Side	18
3D Gain Pattern on Long Side	19
3D Gain Pattern on Short Side	20
2D Gain Pattern on Long Side	21
2D Gain Pattern on Short Side	22
Mobile Phone Applications	23
PND Applications	24
Notebook Applications	26
Contact Information	27

Applications

This antenna is designed for Bluetooth\WLAN application and it's suitable for cellular phones, PDA, notebook, navigator, and all devices which have Bluetooth\WLAN function.

Features

- Omni-directional radiation
- High Efficiency
- Low profile and compact size(5.2 x 3.7 x 0.7mm)
- Low cost
- Lead free soldering compatible
- RoHS compliant
- Tape and reel packing

Electrical Characteristics

ITEM		SPECIFICATION
Frequency Band		2.40GHz~2.50GHz
VSWR		Less than 2.5
Polarization		Linear
*Peak Gain	Layout A	-2.6 dBi Typ.
	Layout B	-2.5 dBi Typ.
*Efficiency	Layout A	80% Typ.
	Layout B	74% Typ.
Impedance		50Ω Typ.

* Test condition: Test board size 80*40 mm

Matching circuit: Pi matching circuit will be required

Antenna Dimension

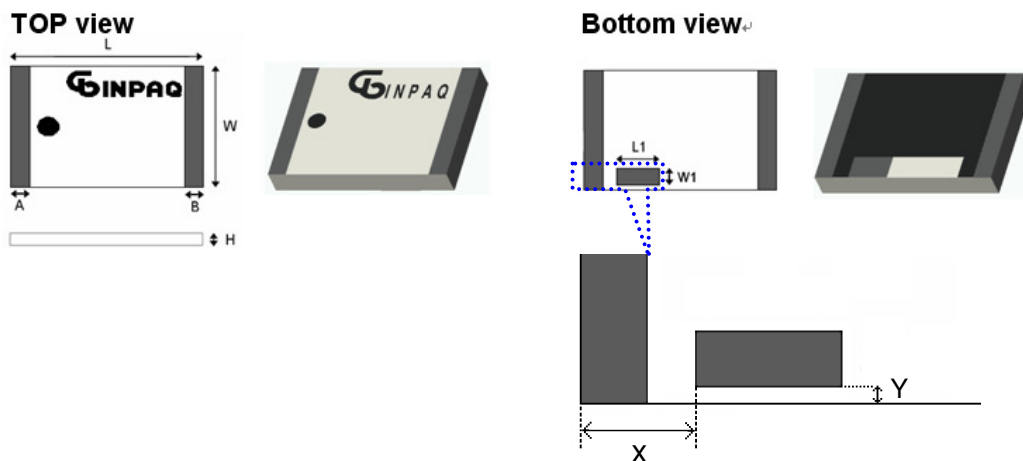

Chip Antenna	L	W	A	B	L1	W1	H	X	Y
ACA5036	5.2±0.3	3.7±0.3	0.45±0.25	0.45±0.25	1.1±0.20	0.55±0.20	0.70±0.15	0.85±0.25	0.12±0.06

Recommended PCB layout (unit:mm)

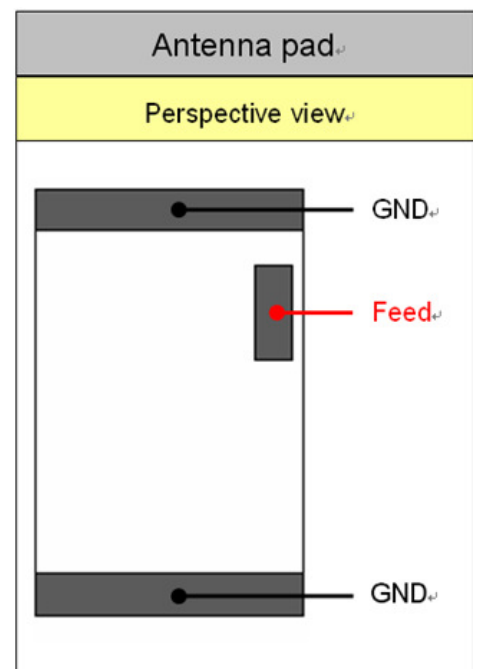
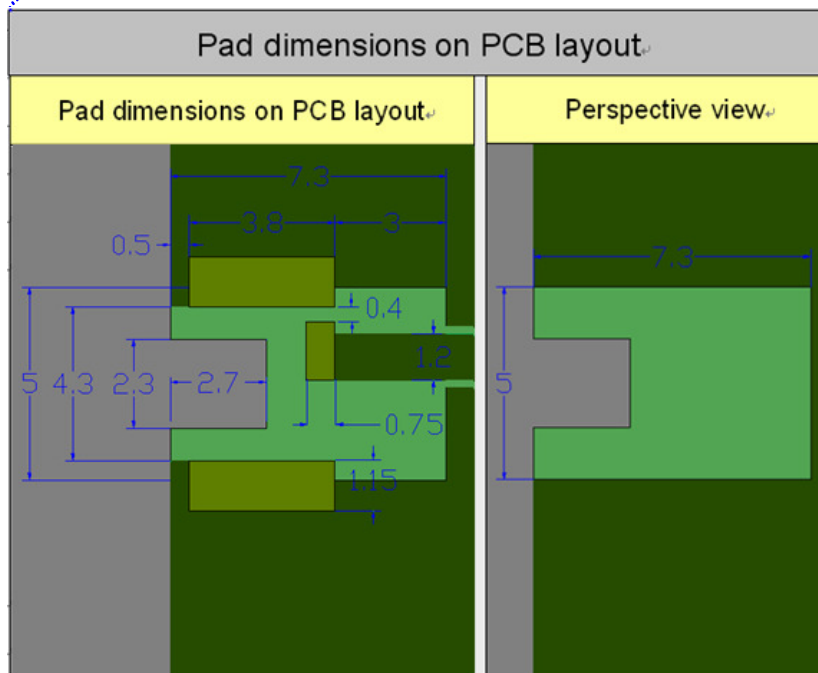
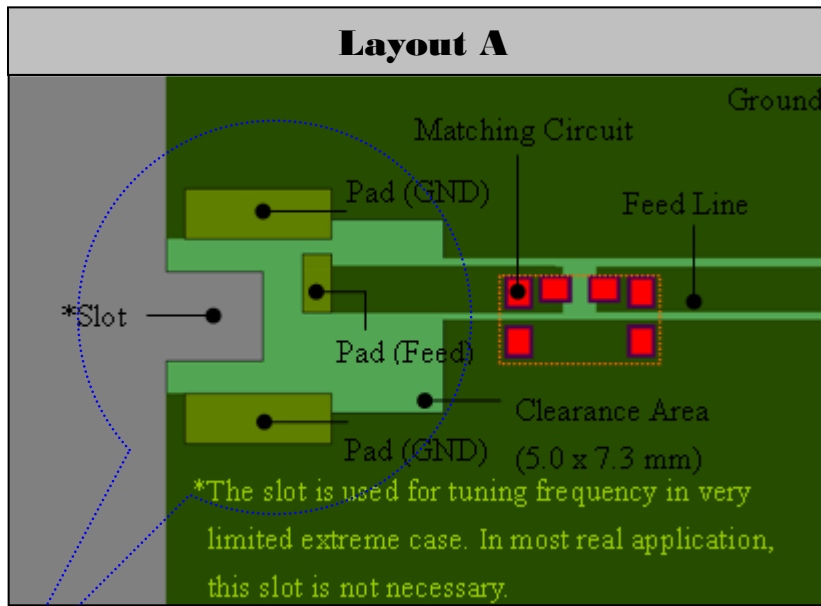

PCB pad dimensions

Terminal name	Terminal Dimensions
Pad (Feed)	1.2 X 0.75
Pad (GND)	3.8 X 1.15
Pad (GND)	3.8 X 1.15

Antenna pad dimensions

Terminal name	Terminal Dimensions
Feed	1.1 X 0.55
GND	3.7 X 0.45
GND	3.7 X 0.45

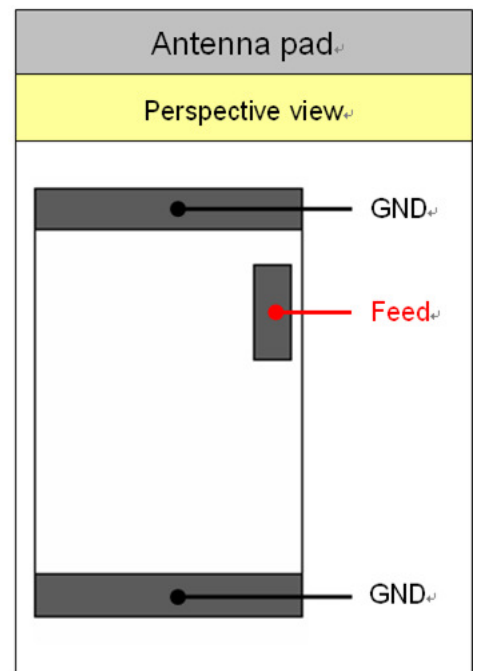
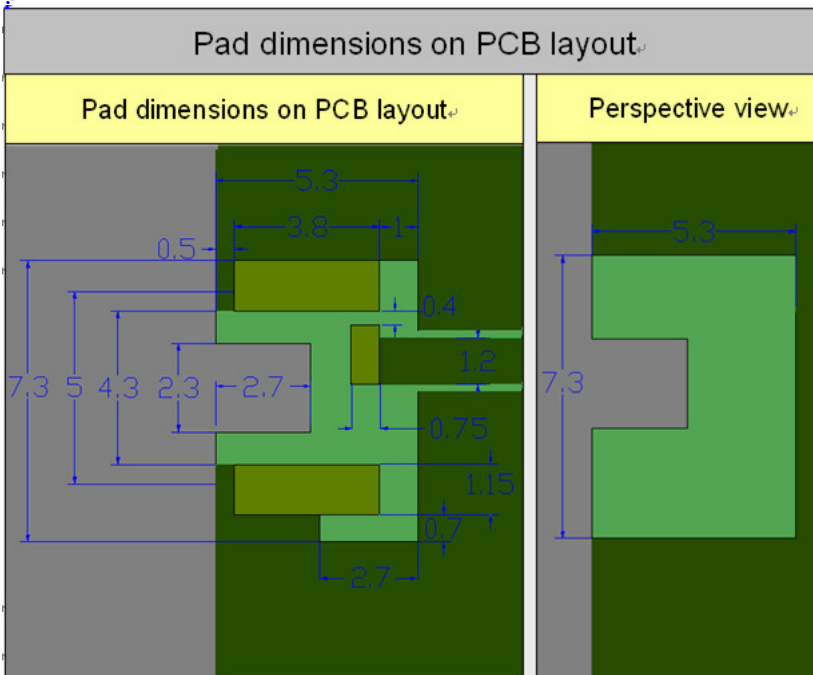
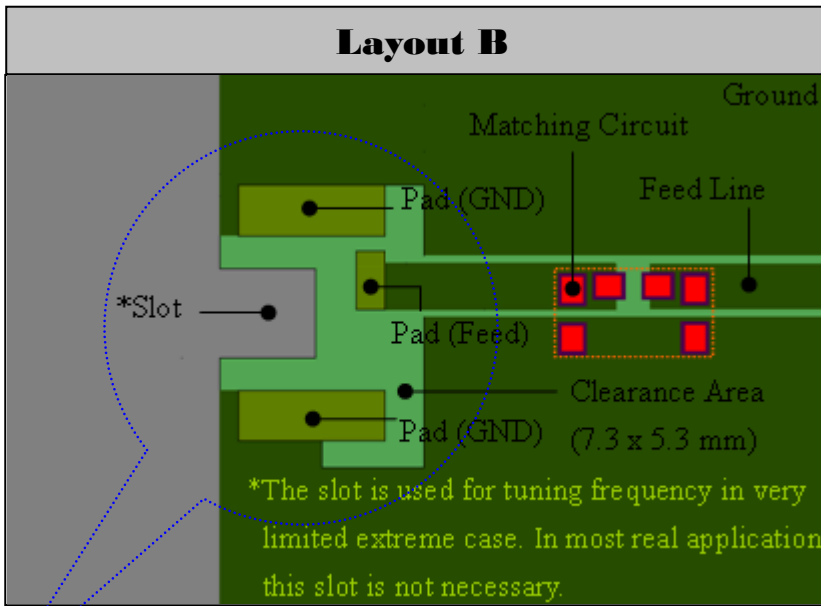

PCB pad

Terminal name	Terminal Dimensions
Pad (Feed)	1.2 X 0.75
Pad (GND)	3.8 X 1.15
Pad (GND)	3.8 X 1.15

Antenna pad dimensions

Terminal name	Terminal Dimensions
Feed	1.1 X 0.55
GND	3.7 X 0.45
GND	3.7 X 0.45

Layout Description

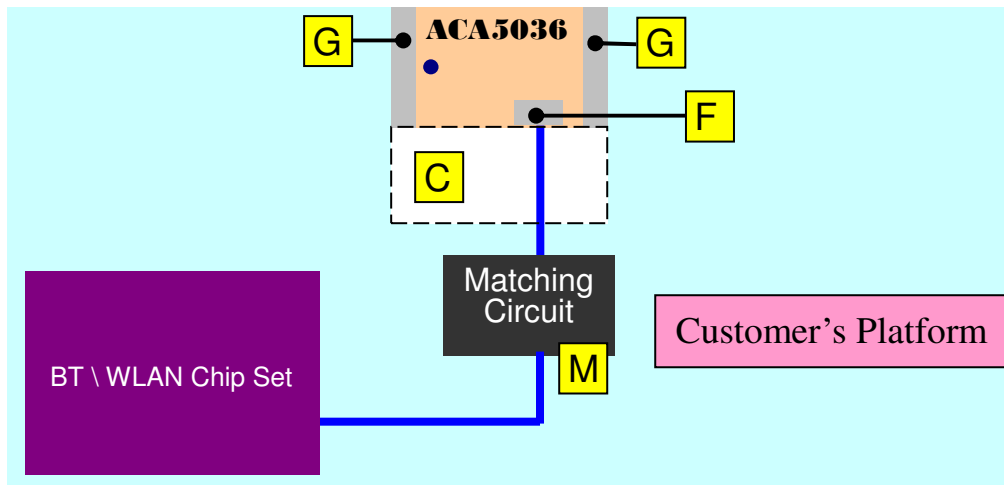

F. Feeding Pad

The signal from system must feed into the feeding pad.

G. Ground Pad

This pad must connect to ground plane of PCB.

C. Clearance Area

To achieve antenna performance, the clearance area is necessary and all metallization should be removed from all PCB layers.

M. Matching Circuit

Please keep the pads for PI-matching circuit to reduce return loss and shift the band to meet Bluetooth application.

Performance on Middle of Long Side

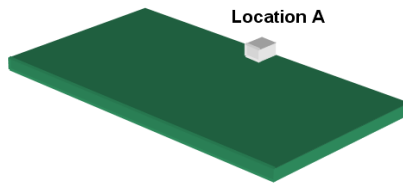

Typical VSWR

Layout A

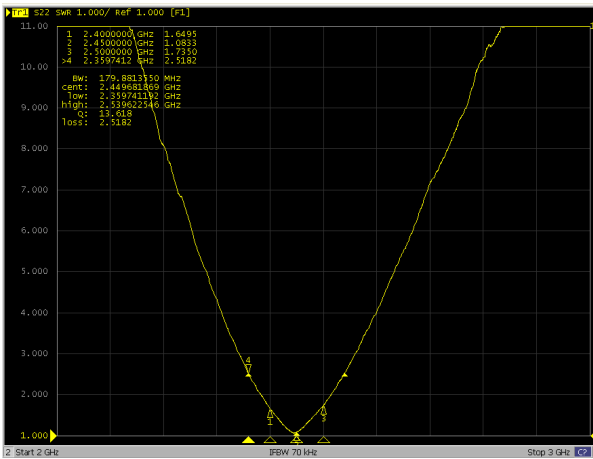

Layout B

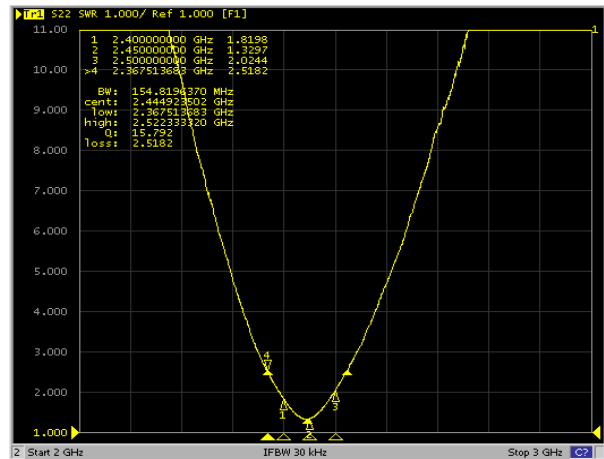

Frequency	Layout A VSWR	Layout B VSWR
2400 MHz	1.65	1.82
2450 MHz	1.08	1.33
2500 MHz	1.74	2.02

Typical Free Space Peak Gain and Efficiency

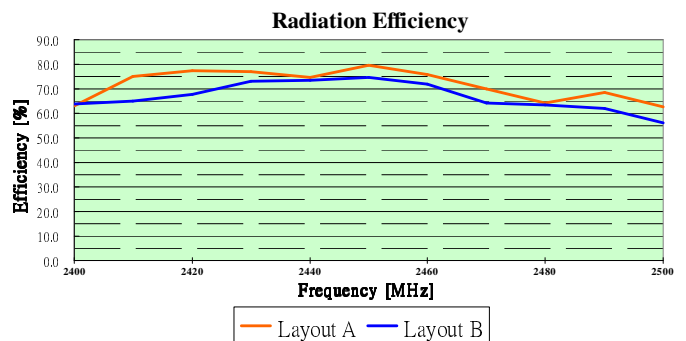
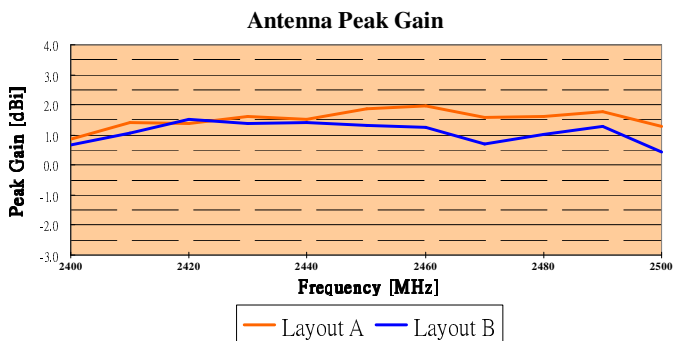

Frequency	Layout A Peak Gain	Layout B Peak Gain	Layout A Efficiency	Layout B Efficiency
2400 MHz	-2.6 dBi	-2.5 dBi	63.02%	63.80%
2450 MHz	-2.6 dBi	-2.5dBi	79.60%	74.61%
2500 MHz	-2.6dBi	-2.5dBi	62.65%	56.31%

Typical Free Space Radiation Pattern

3D Radiation Pattern

Layout A 2450 MHz

Layout B 2450 MHz

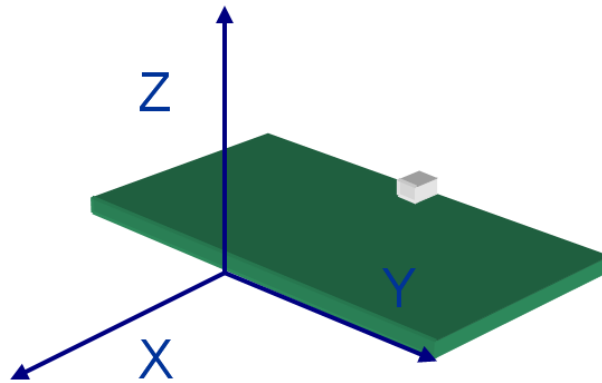
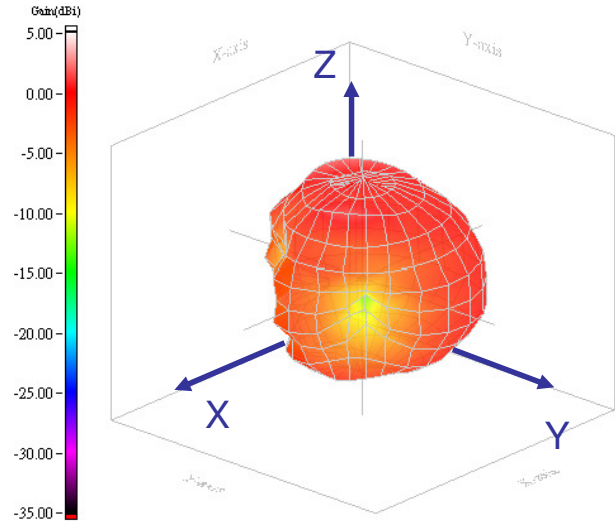
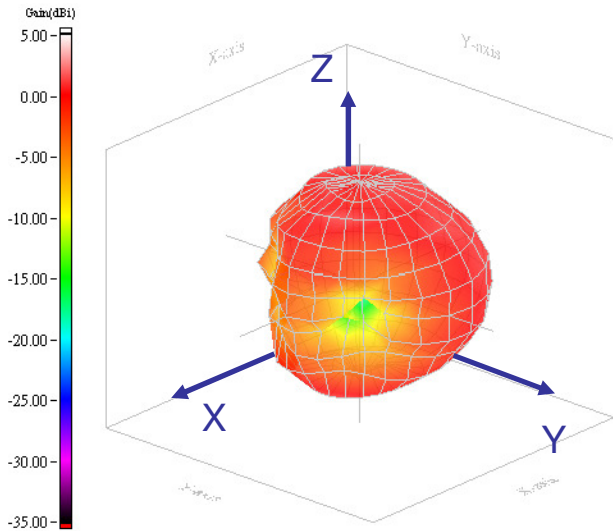

Typical Free Space Radiation Pattern

2D Radiation Pattern

X-Y Plane 2450 MHz

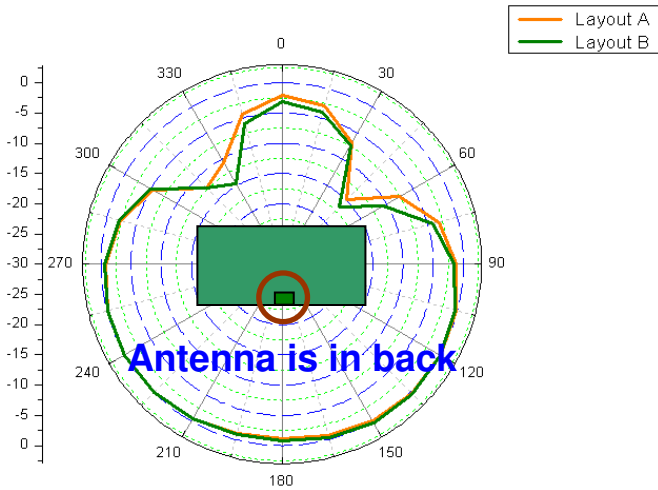

X-Z Plane 2450 MHz

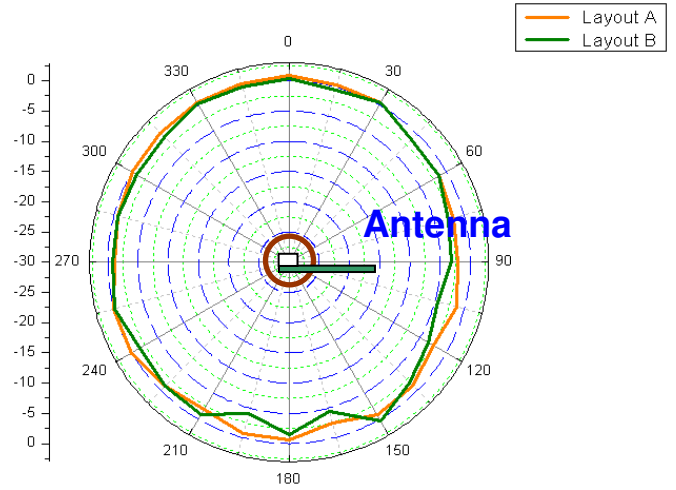

Y-Z Plane 2450 MHz

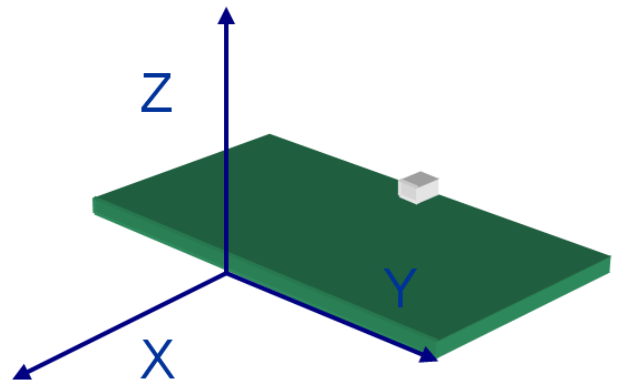
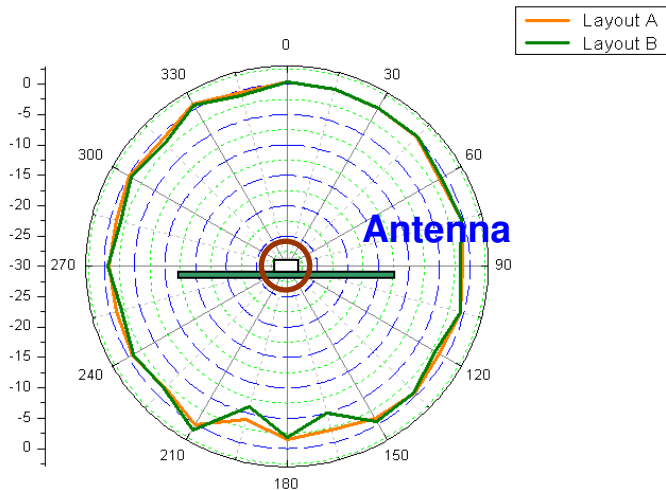

The Efficiency and Bandwidth for Different Location

Layout A

* All electrical characteristic depend on INPAQ 80 x 40mm evaluation board with matching circuit.

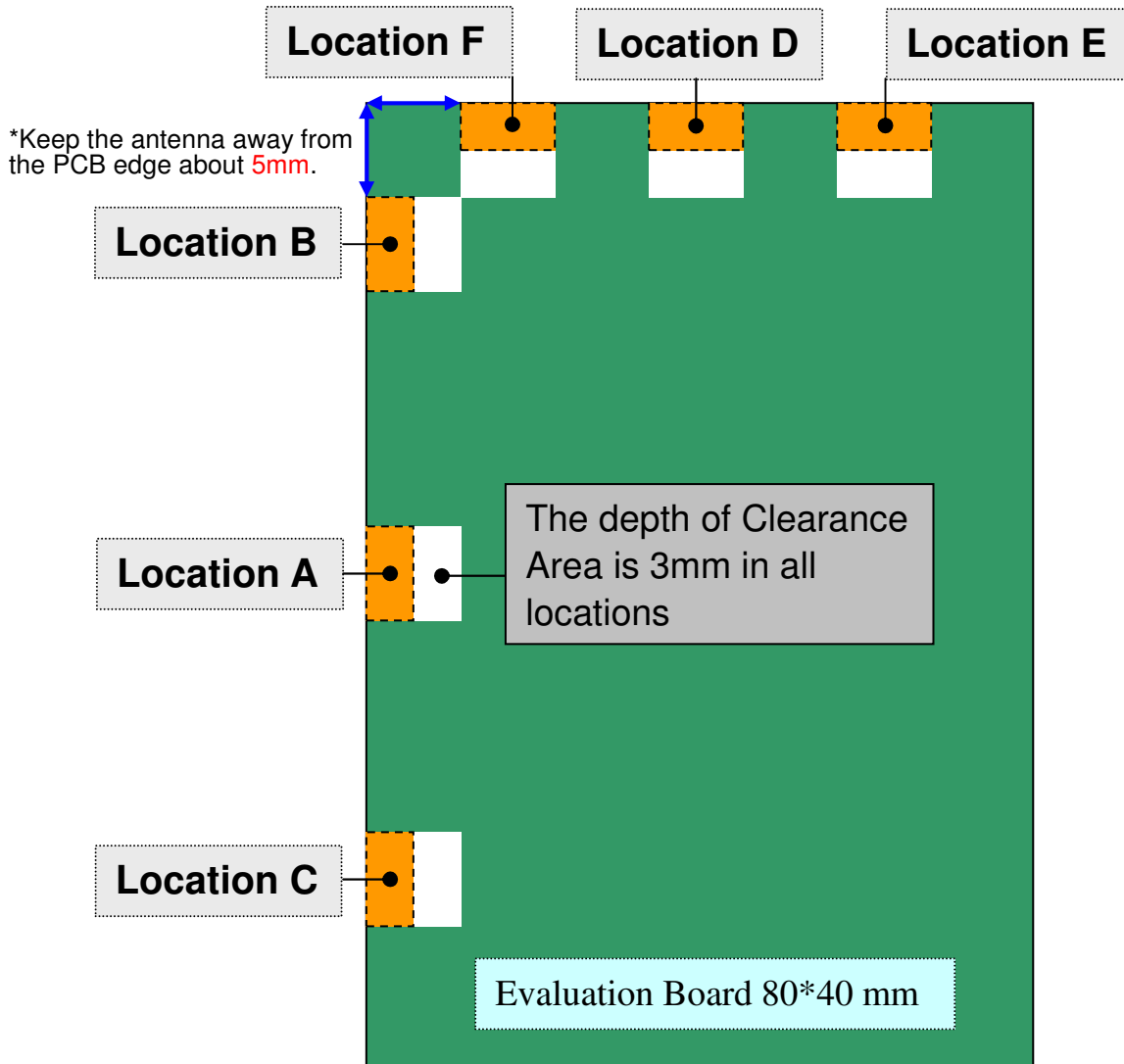

Locations Test Item			Long side			Short side		
			A	B	C	D	E	F
Bandwidth [MHz] VSWR<2.5			180	73	67	151	96	85
Gain	Linear [dBi]	Peak	-2.6	3.00	2.98	-2.5	0.55	0.28
		Avg.	-2.7	-2.19	-2.22	-2.6	-1.86	-2.13
Efficiency	Linear [%]		79.55	60.44	59.94	71.39	65.23	61.29

Peak Gain and Efficiency on Long Side

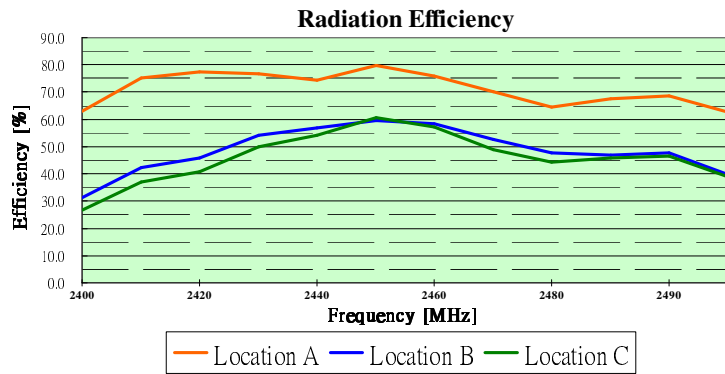
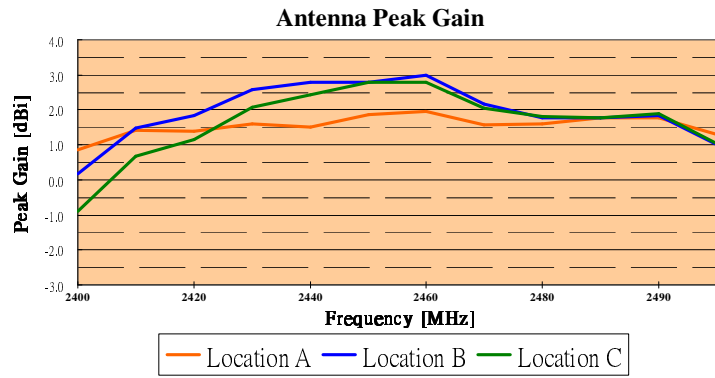
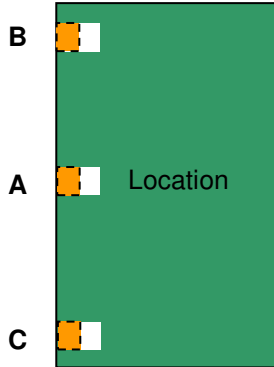

Peak Gain and Efficiency on Short Side

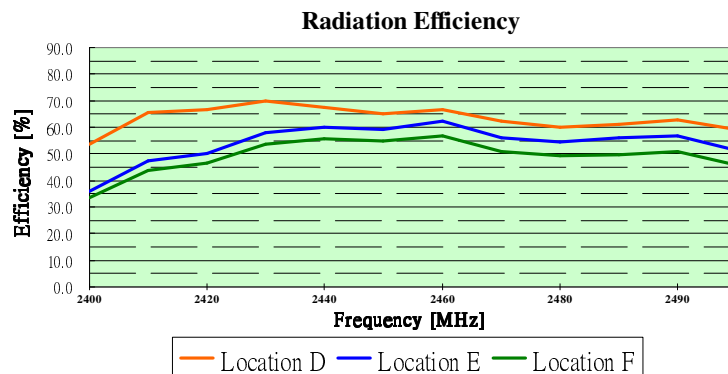
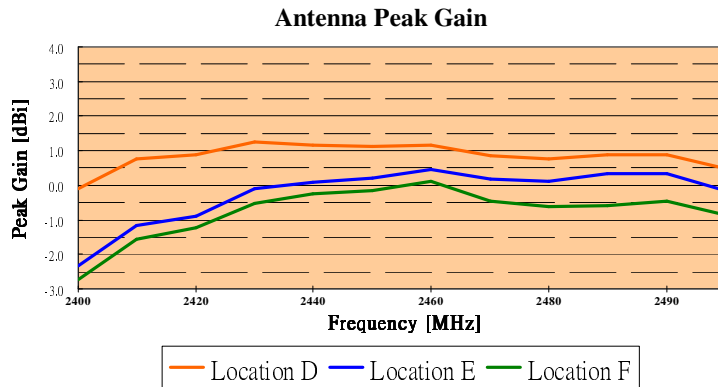

3D Gain Pattern on Long Side

Location A 2450 MHz

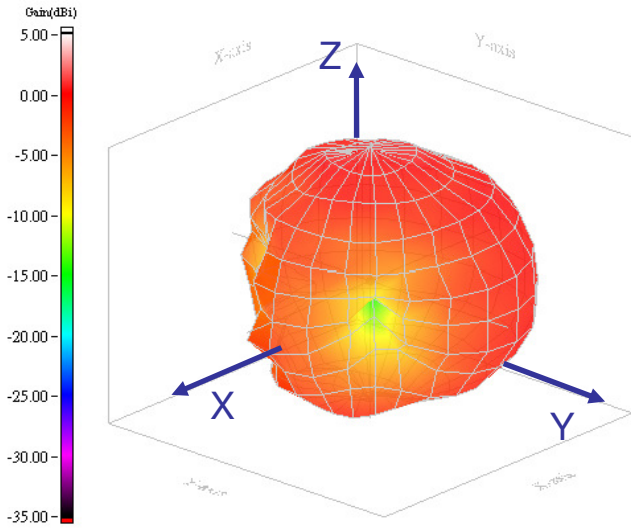

Location B 2450 MHz

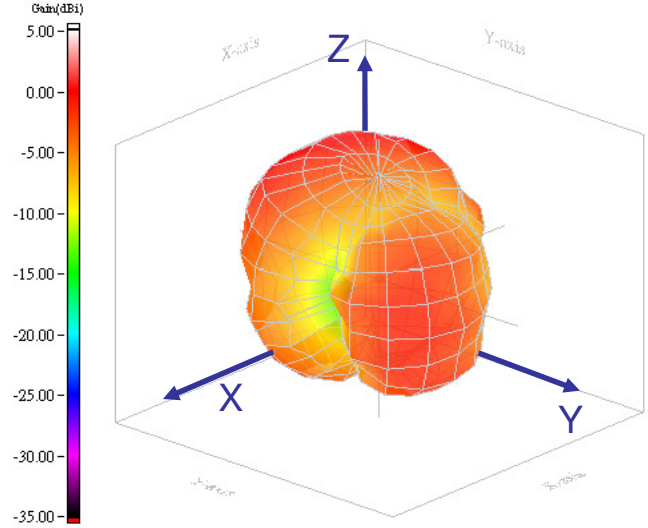

Location C 2450 MHz

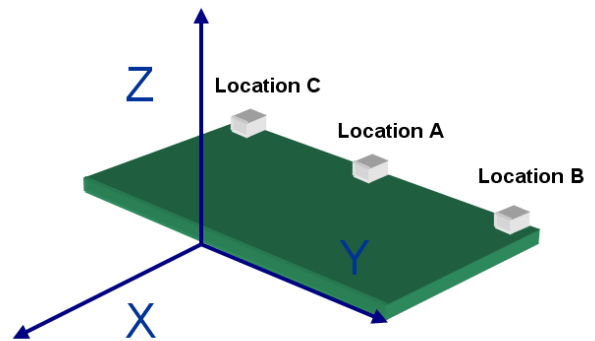
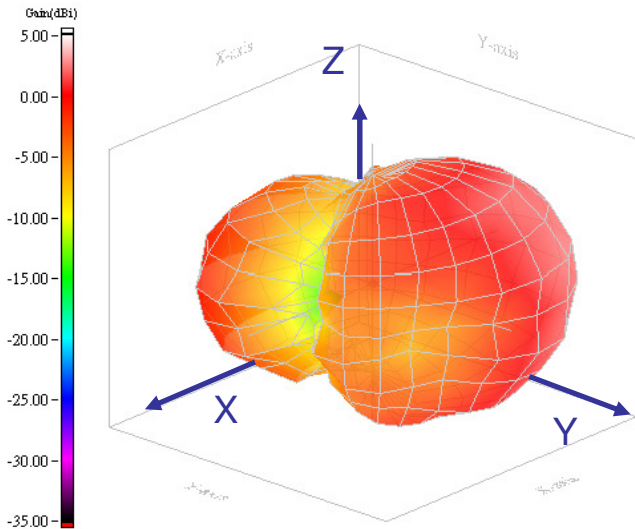

3D Gain Pattern on Short Side

Location D 2450 MHz

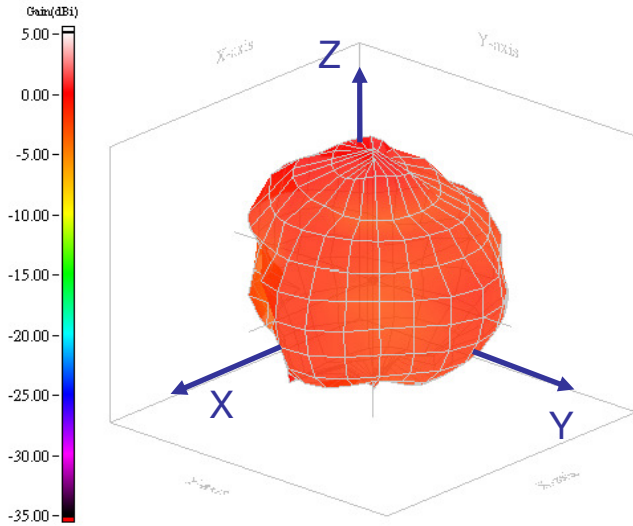

Location E 2450 MHz

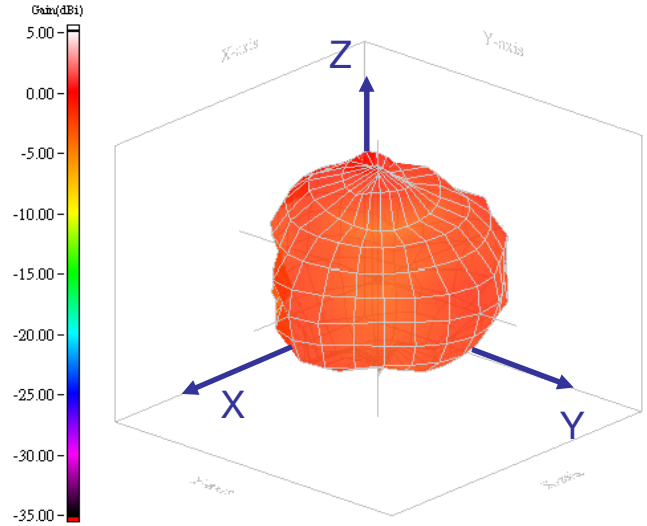

Location F 2450 MHz

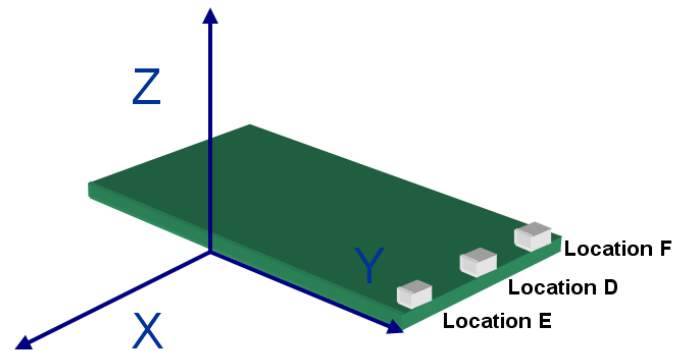
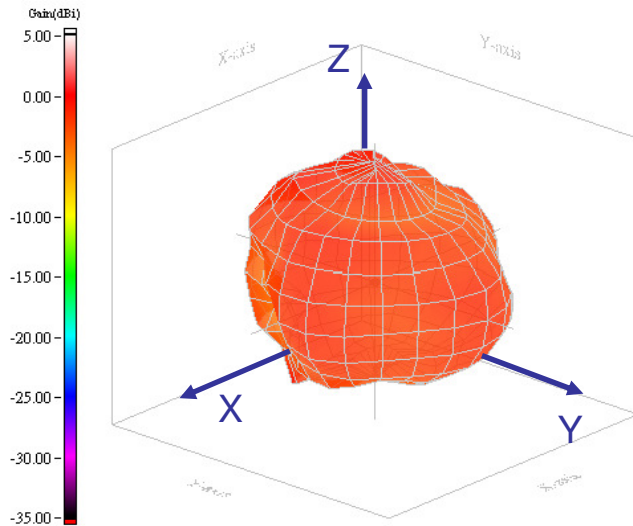

2D Gain Pattern on Long Side

X-Y plane 2450 MHz

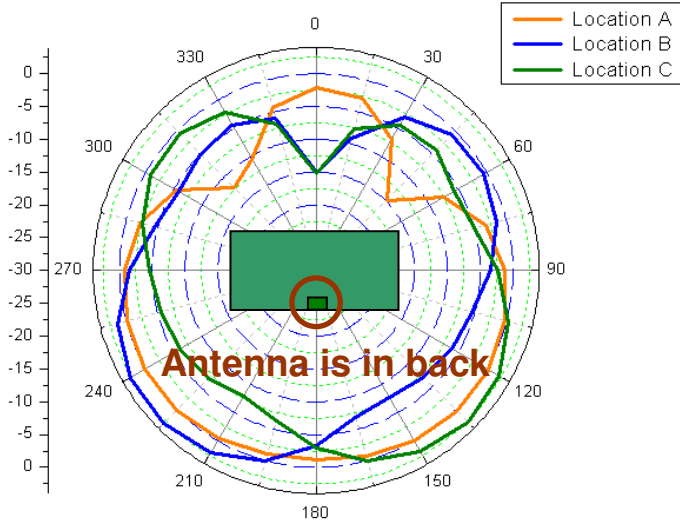

X-Z plane 2450 MHz

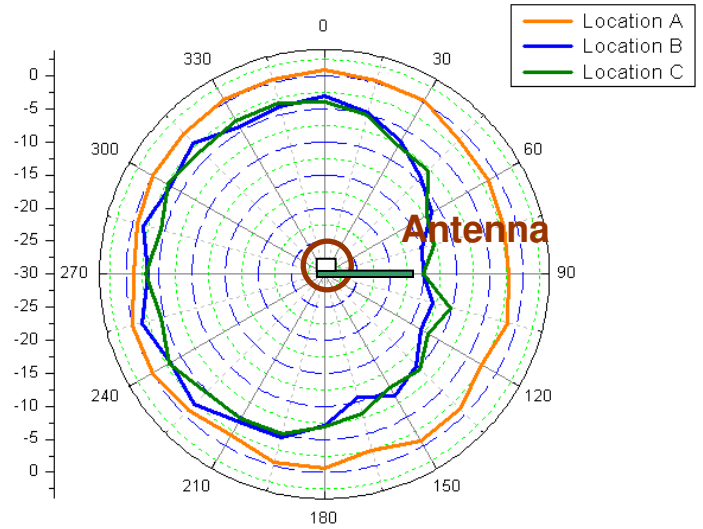

Y-Z plane 2450 MHz

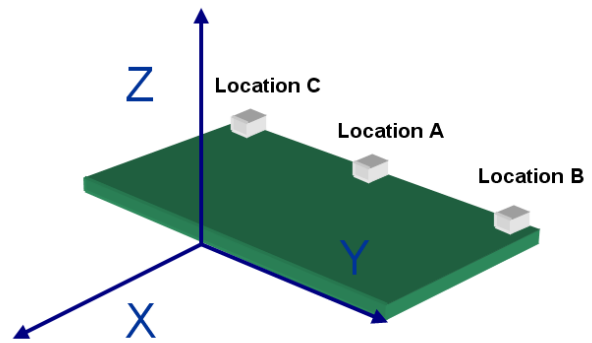
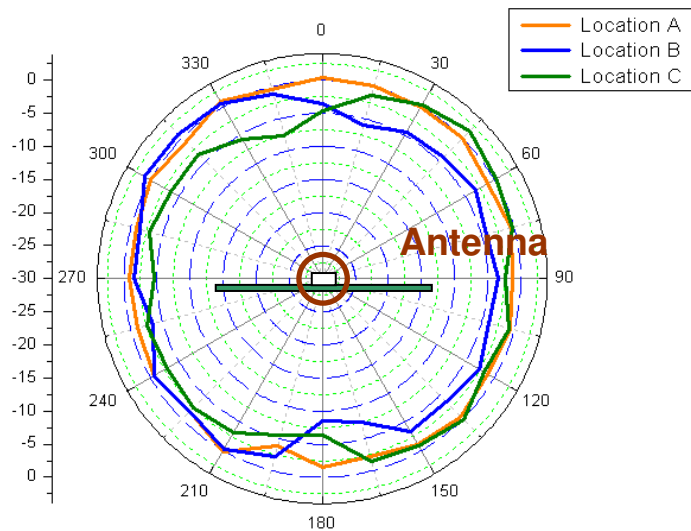

2D Gain Pattern on Short Side

X-Y plane 2450 MHz

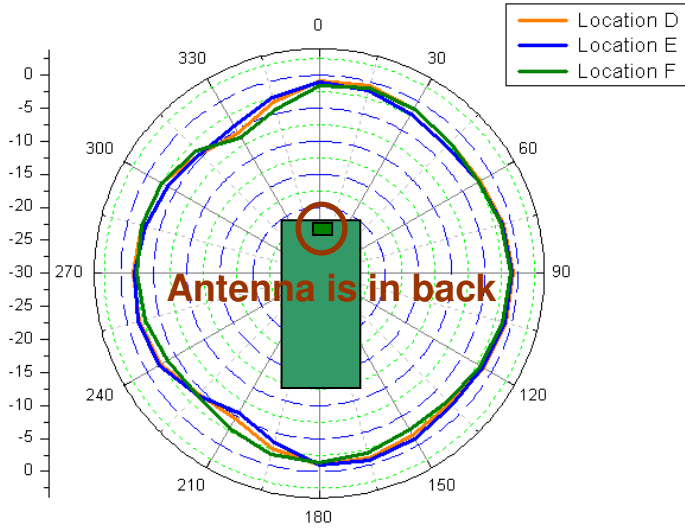

X-Z plane 2450 MHz

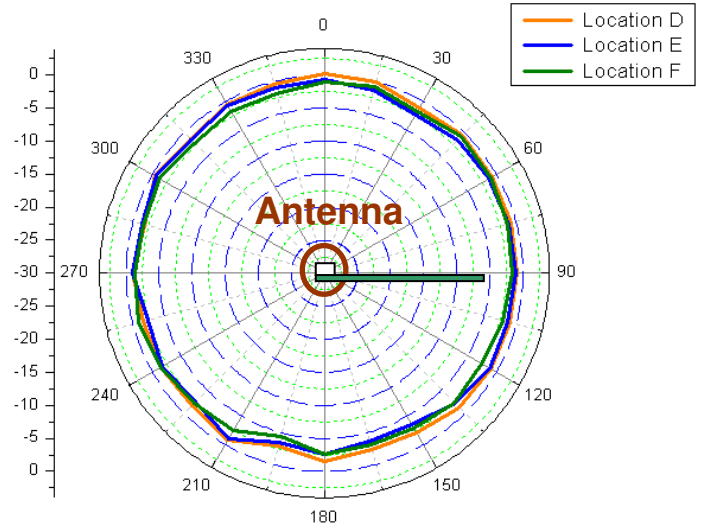

Y-Z plane 2450 MHz

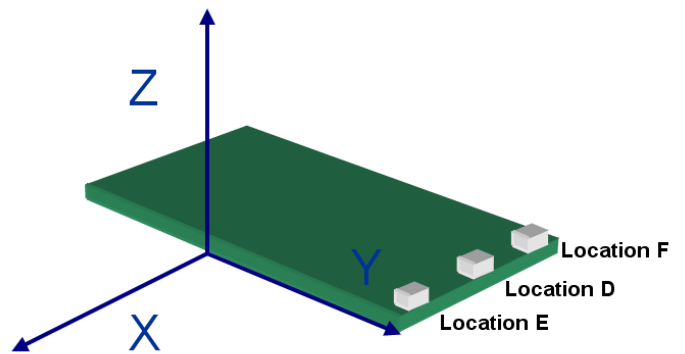
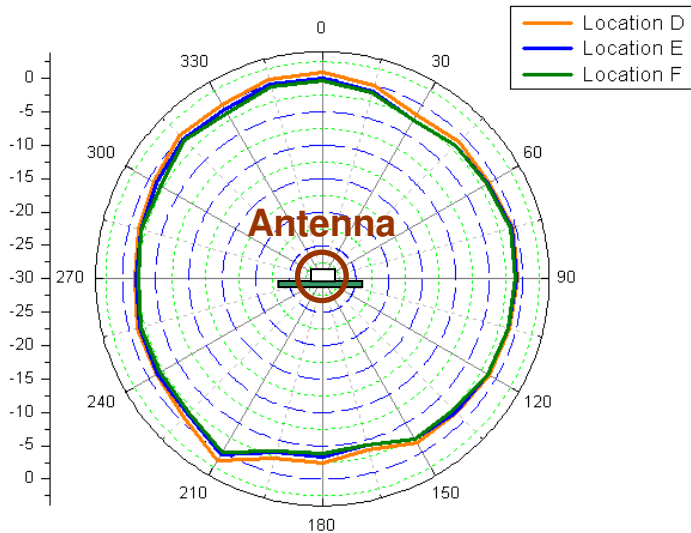

Efficiency and Band Width V.S Different Depths of Clearance Area

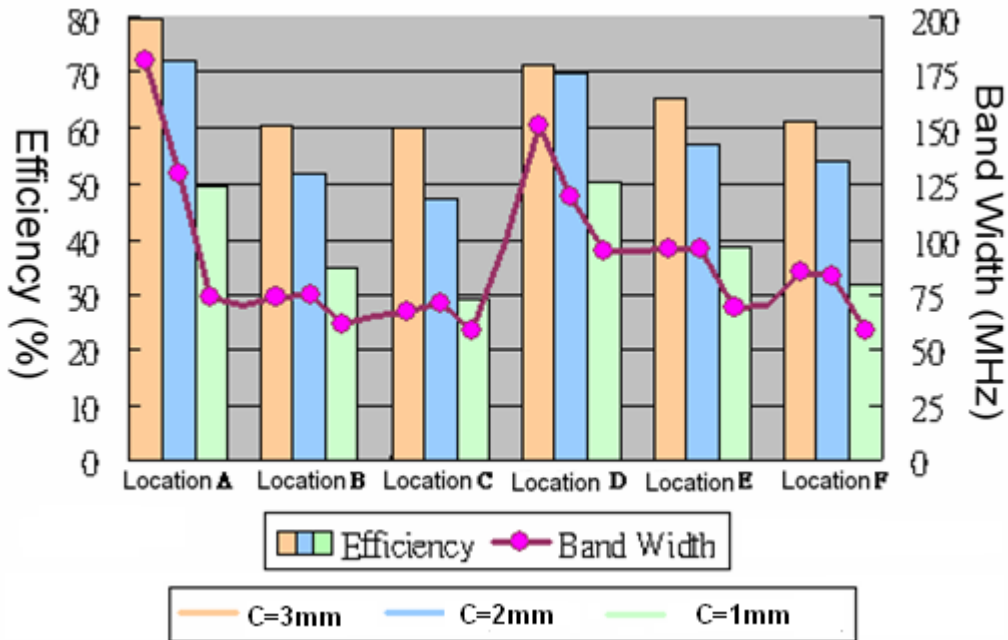
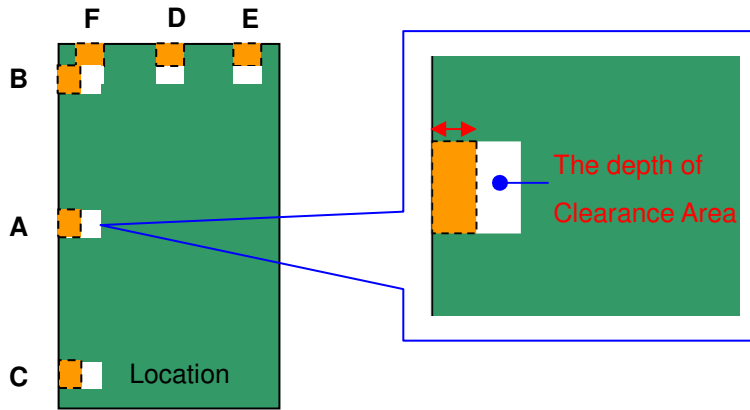

***C=Clearance Area**

***Clearance Area → All metallization should be removed from all PCB layers**

Near Metal Effect

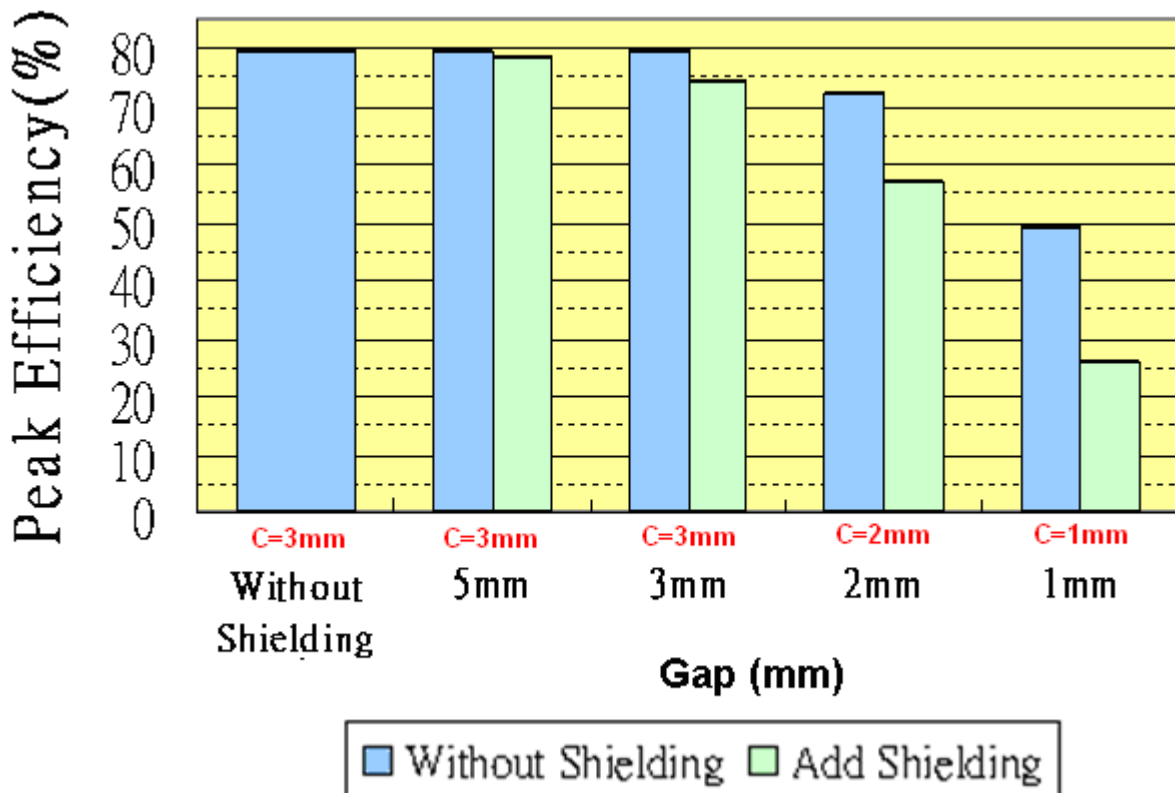
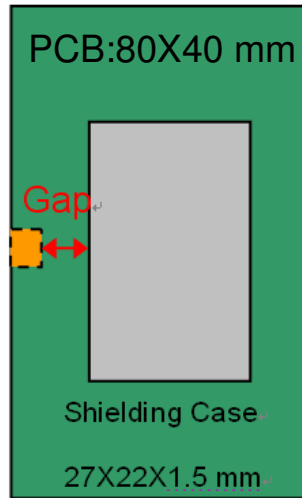

*C=Clearance Area

Ground Size V.S Efficiency

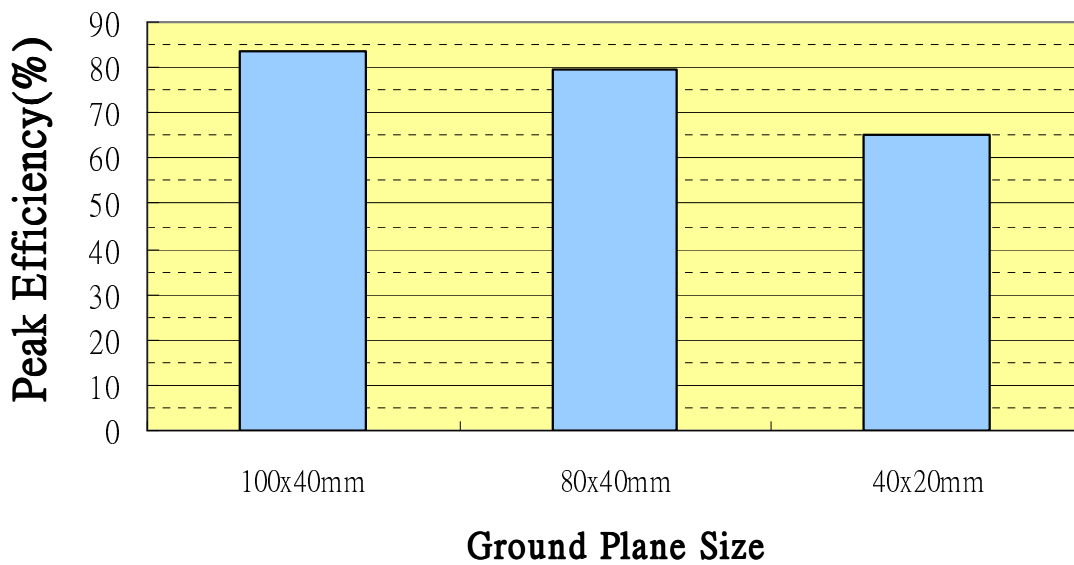
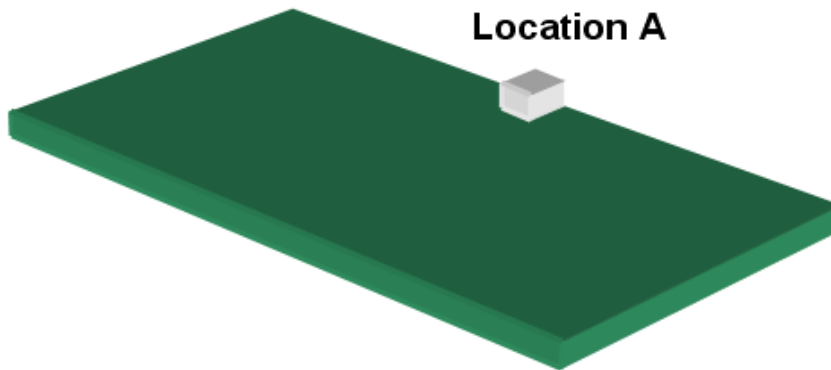

***The depth of Clearance Area is 3mm**

The Efficiency and Bandwidth for Different Location

Layout B

* All electrical characteristic depend on INPAQ 80 x 40mm evaluation board with matching circuit.

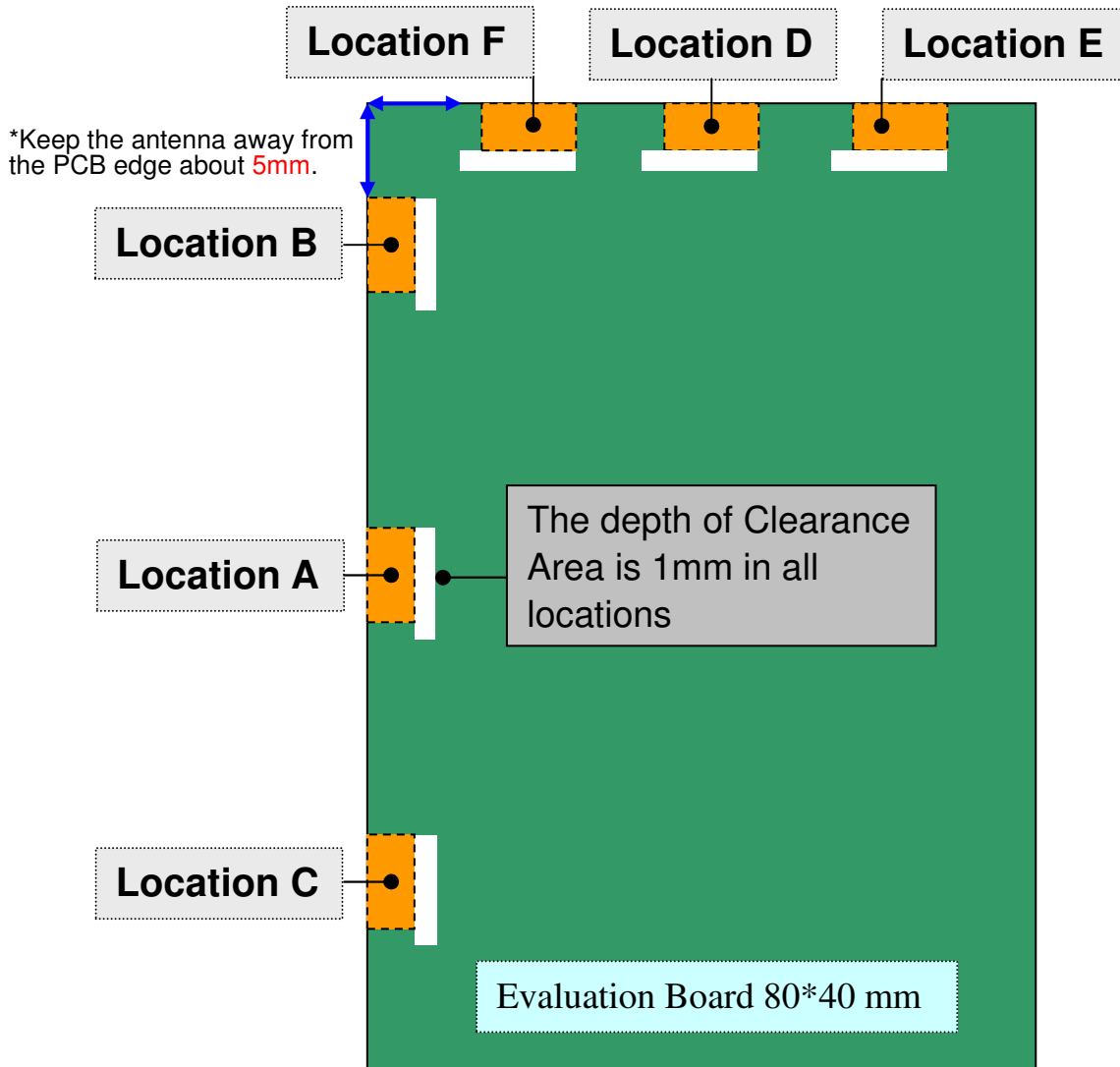

Locations Test Item			Long side			Short side		
			A	B	C	D	E	F
Bandwidth [MHz] VSWR<2.5			154	90	88	152	107	100
Gain	Linear [dBi]	Peak	1.4	2.10	1.93	1.21	-0.35	0.08
		Avg.	-1.08	-3.60	-3.70	-1.63	-2.80	-2.84
Efficiency	Linear [%]		74.61	49.72	47.87	67.57	53.52	53.07

Peak Gain and Efficiency on Long Side

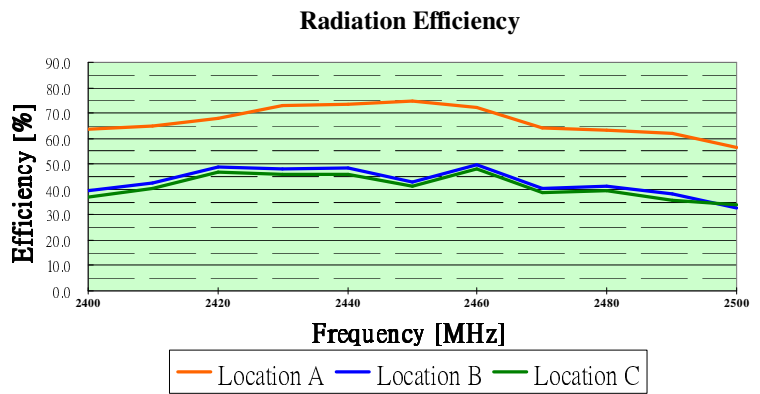
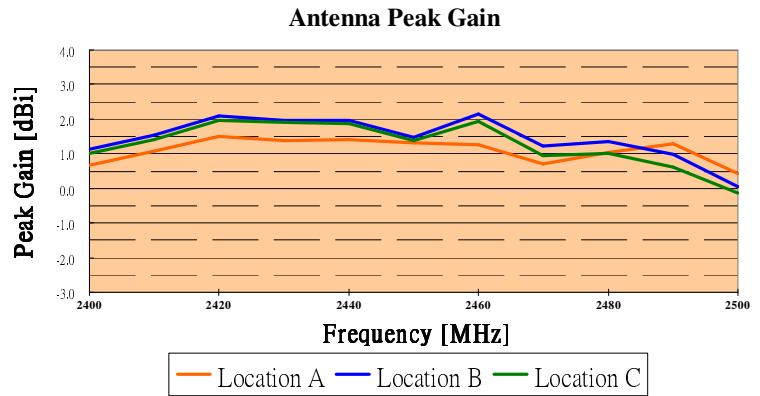
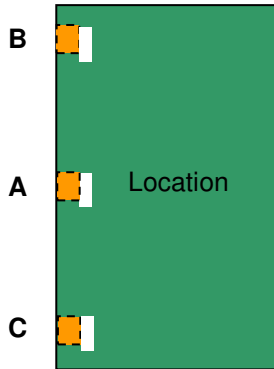

Peak Gain and Efficiency on Short Side

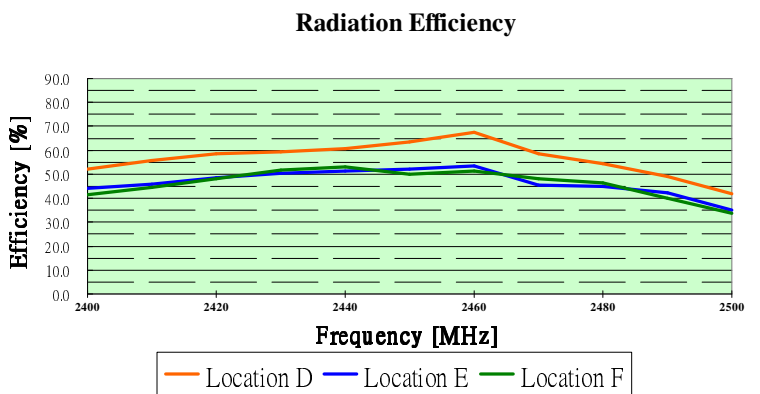
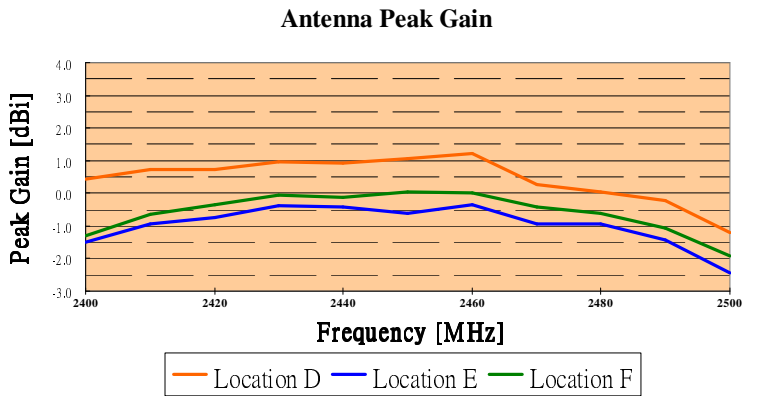

3D Gain Pattern on Long Side

Location A 2450 MHz

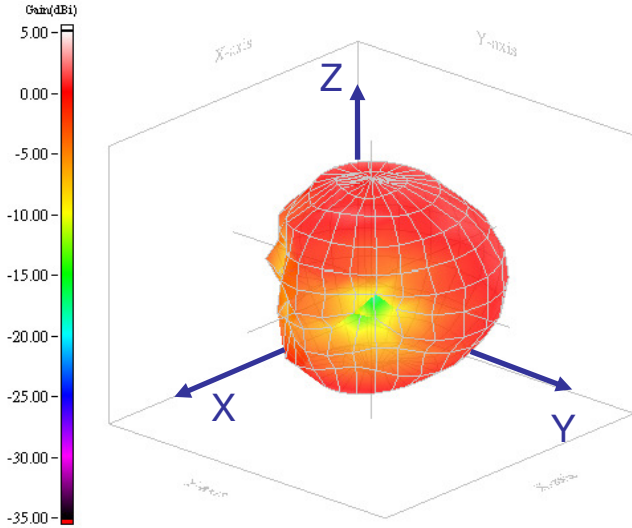

Location B 2450 MHz

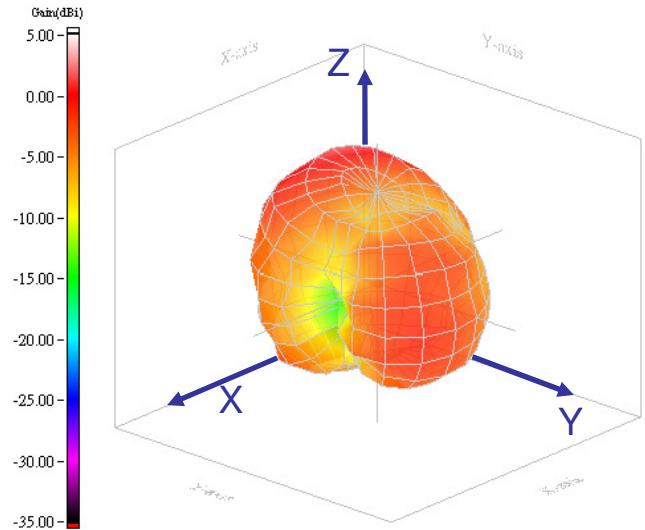

Location C 2450 MHz

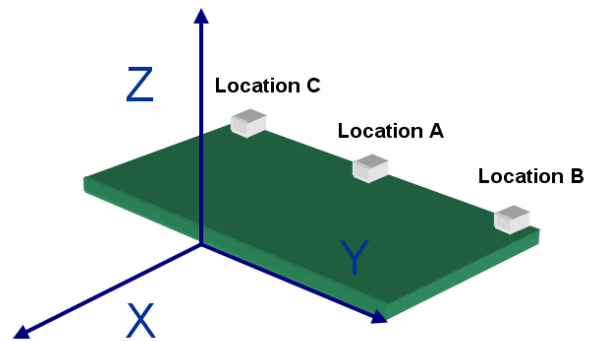
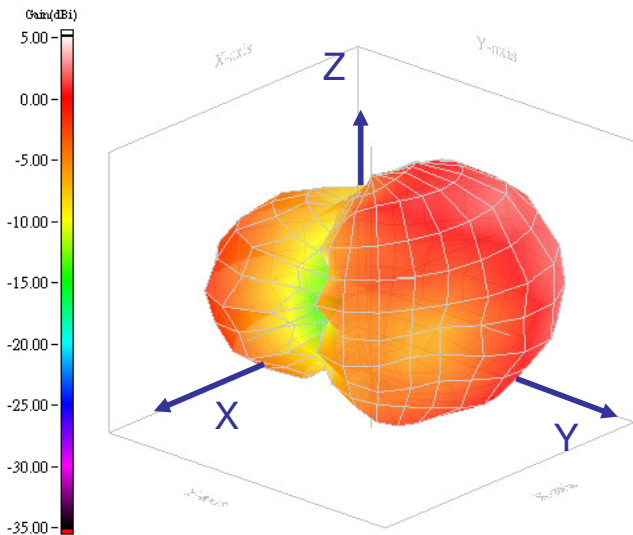

3D Gain Pattern on Short Side

Location D 2450 MHz

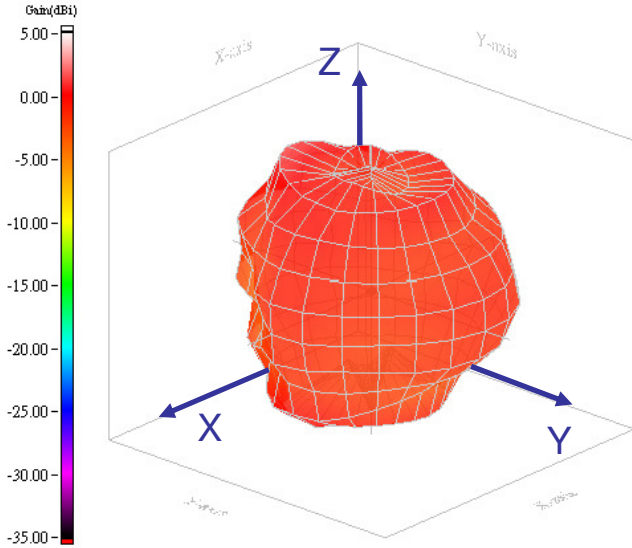

Location E 2450 MHz

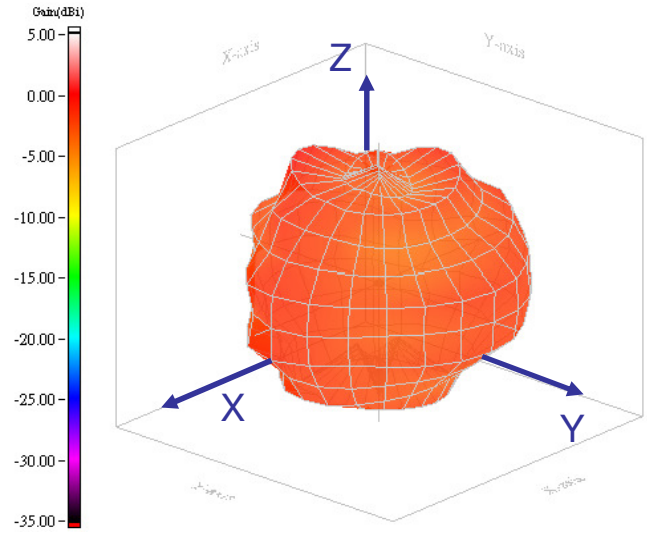

Location F 2450 MHz

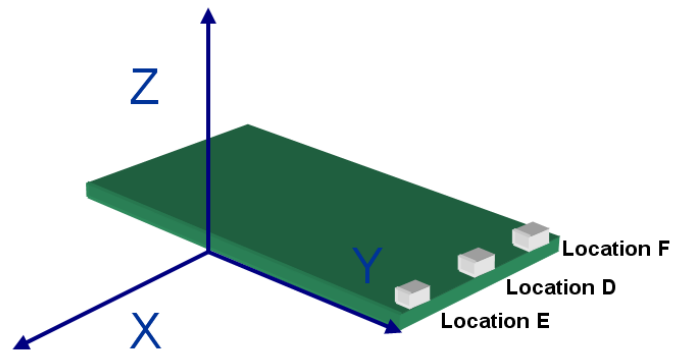
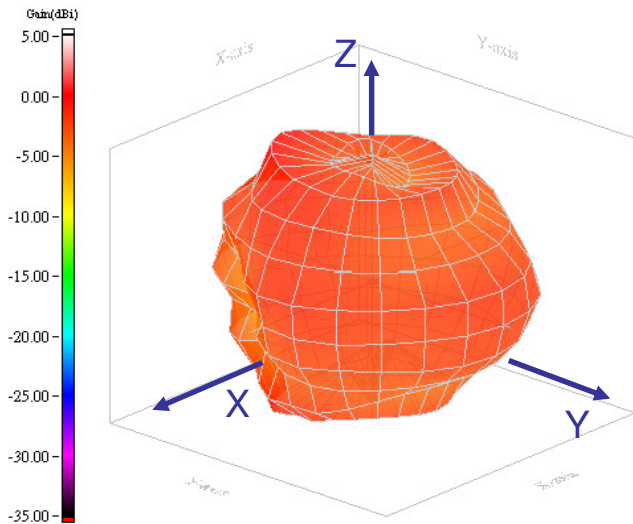

2D Gain Pattern on Long Side

X-Y plane 2450 MHz

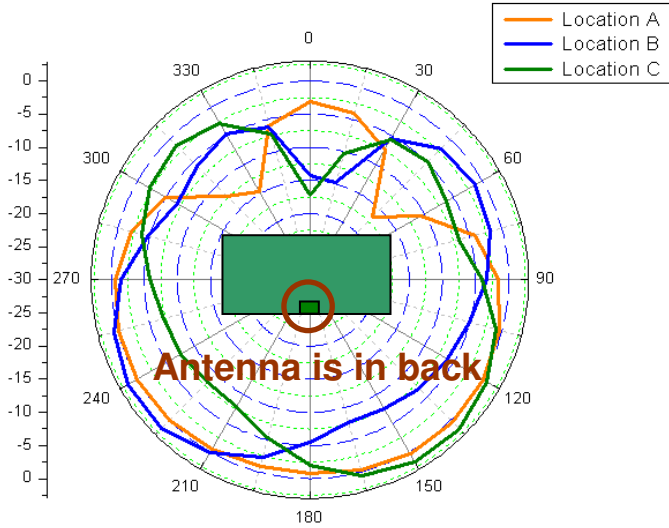

X-Z plane 2450 MHz

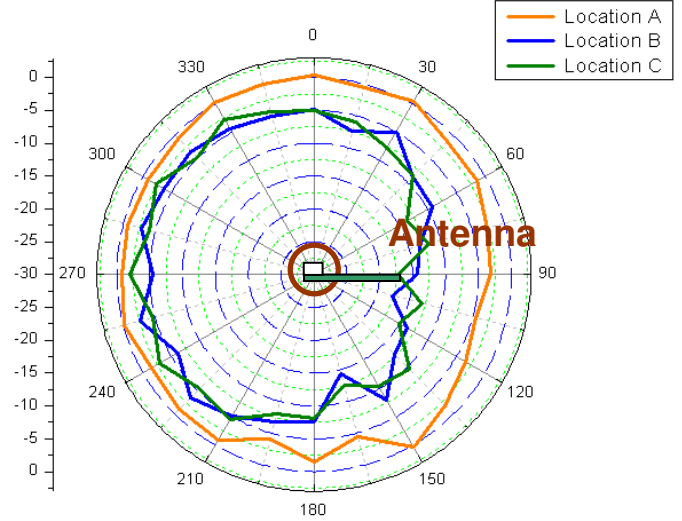

Y-Z plane 2450 MHz

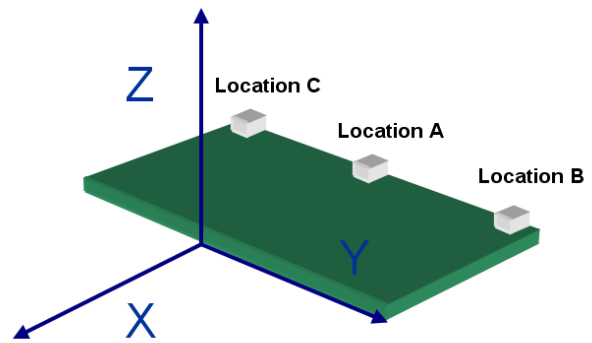
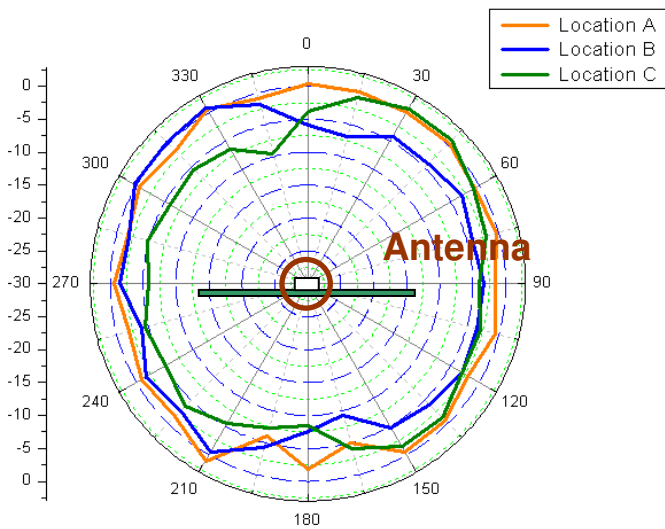

2D Gain Pattern on Short Side

X-Y plane 2450 MHz

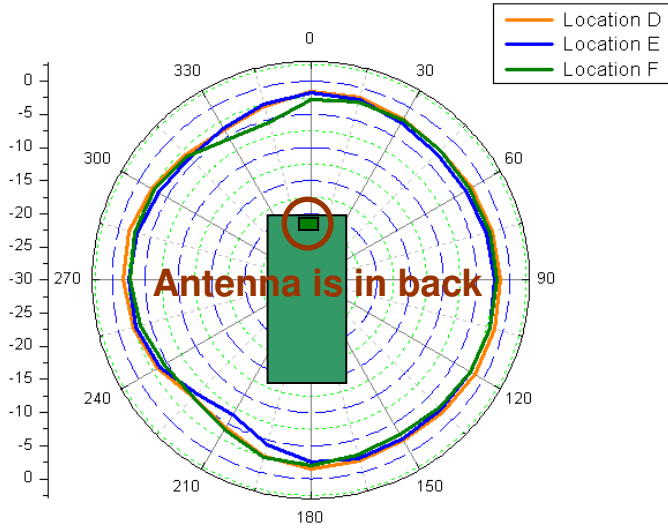

X-Z plane 2450 MHz

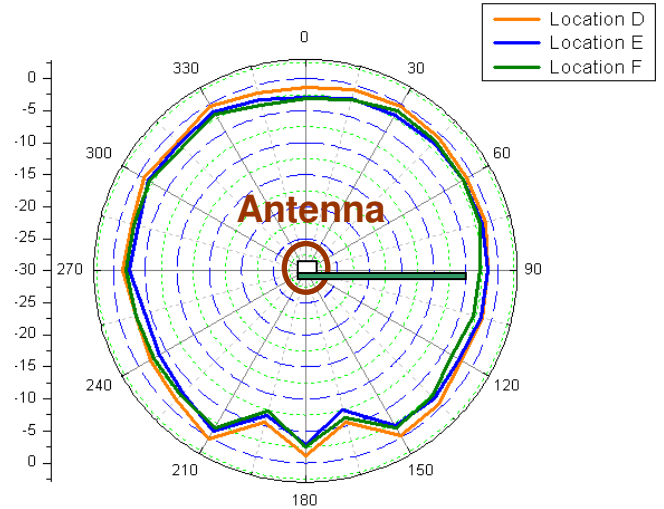

Y-Z plane 2450 MHz

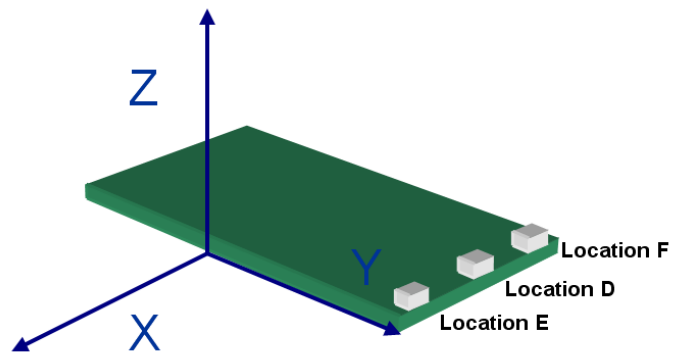
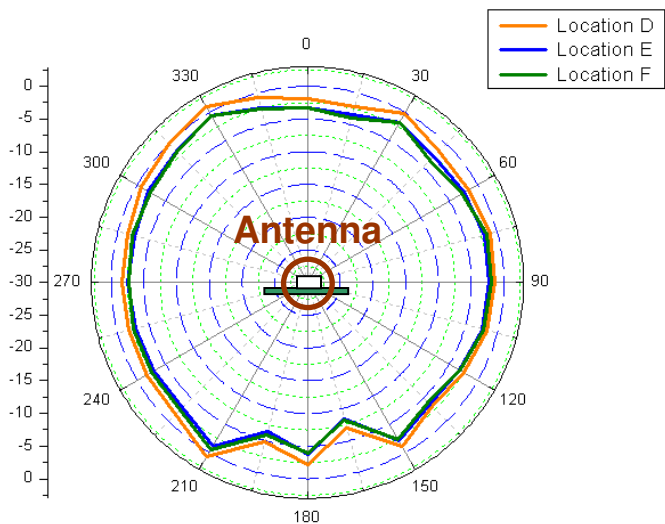

Mobile Phone Applications

- For the mobile phone applications, because most of the key components are arranged along the long side of the PCB, there is no space to place our antenna. So we move the antenna to top edge of PCB as showed as follow picture. And the impedance of PCB in top edge is smaller than in long side edge, we get narrower bandwidth and lower performance than in long side of PCB. But we still get a workable performance by arranging antenna and components in a reasonable position.

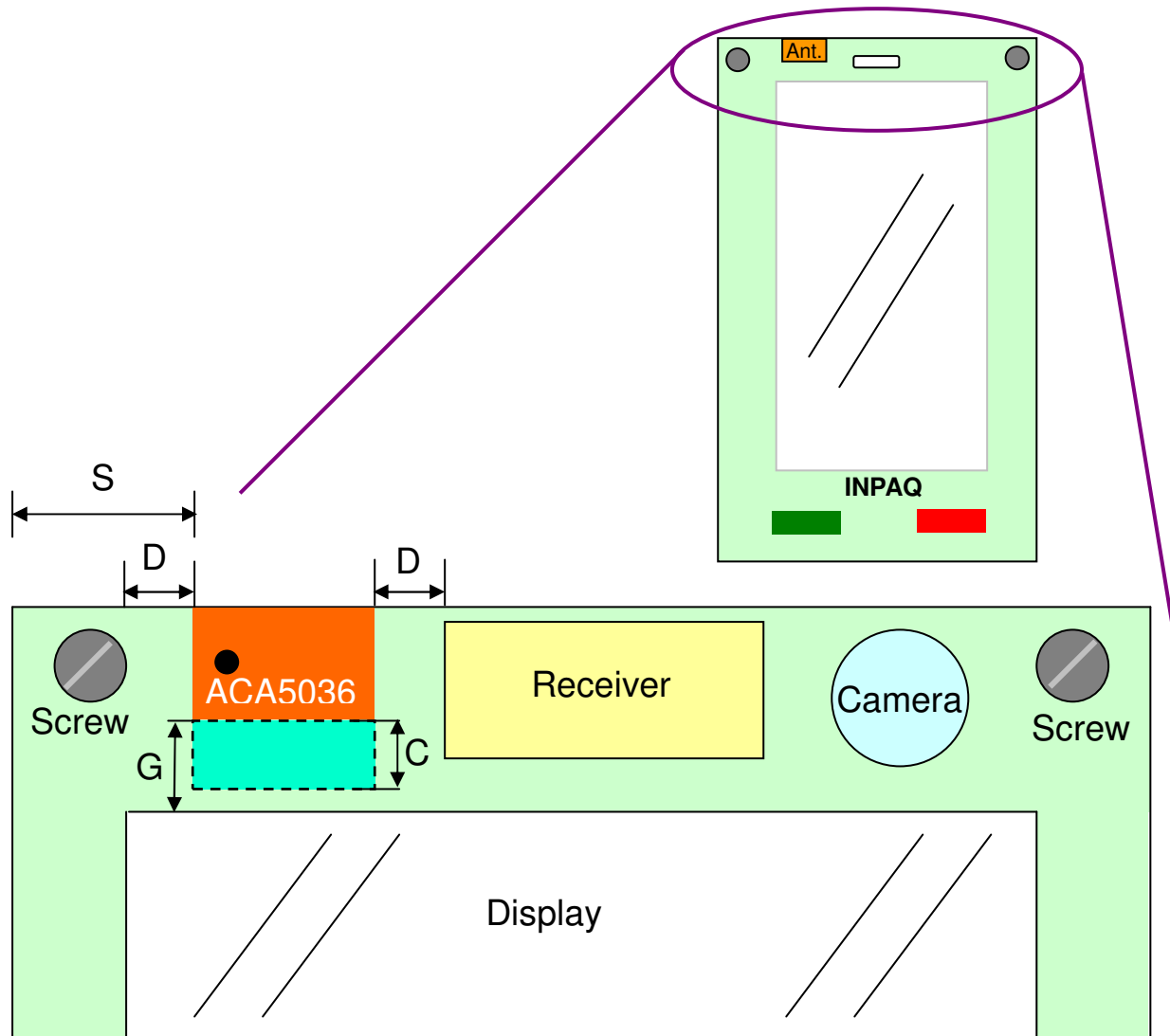

Symbol	Suggested Distance	Remark
S	$\geq 5\text{mm}$	The distance between PCB edge and antenna edge
D	$\geq 3\text{mm}$	The distance between antenna and receiver(or shielding case)edge
C	$\geq 3\text{mm}$	The width of clearance area needs 3mm from antenna edge.
G	$\geq 3\text{mm}$	The edge of display must keep away 3mm from antenna edge.

PND Applications

- For the PND applications, Bluetooth antenna usually place at the long side of PCB. To make the device thinner, it usually cut a part of PCB to put the battery in it and result in a shorter PCB than mobile phone application. In order to increase the performance of Bluetooth antenna, we suggest to keep some part of PCB to make it look as L-shape as figure E. However, the distance between panel and PCB will affect the antenna performance, we suggest keep the panel away from antenna edge at least 3mm in distance as Figure F.

Front Side

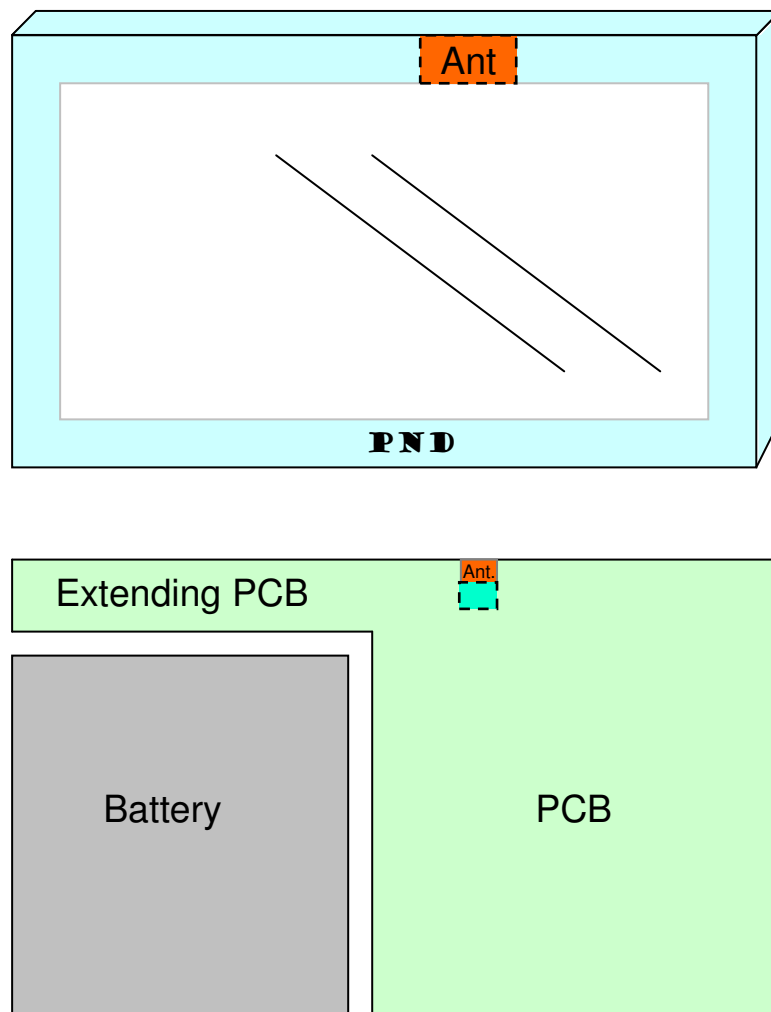

Figure E. Make the extending PCB to get the better performance

Back Side

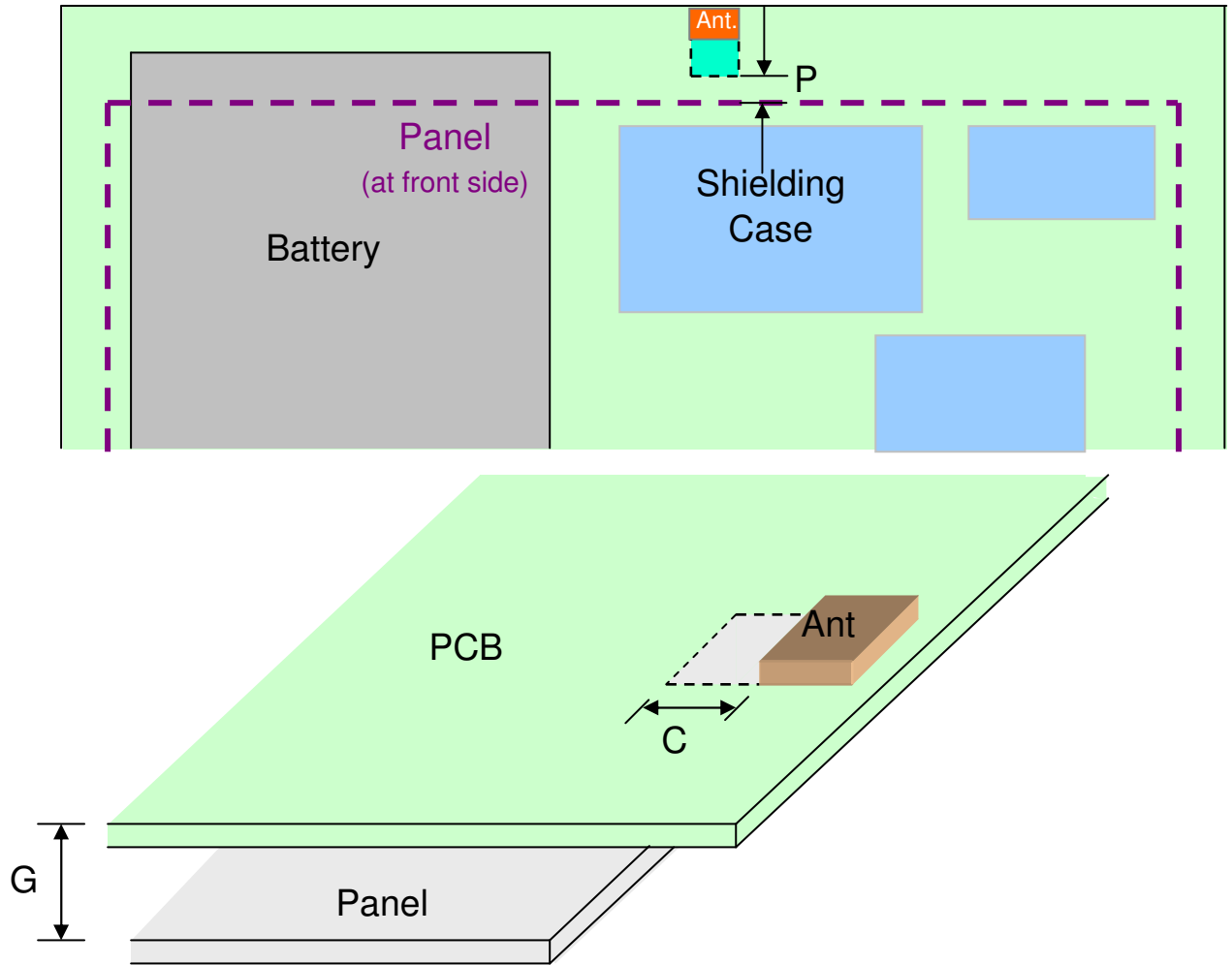
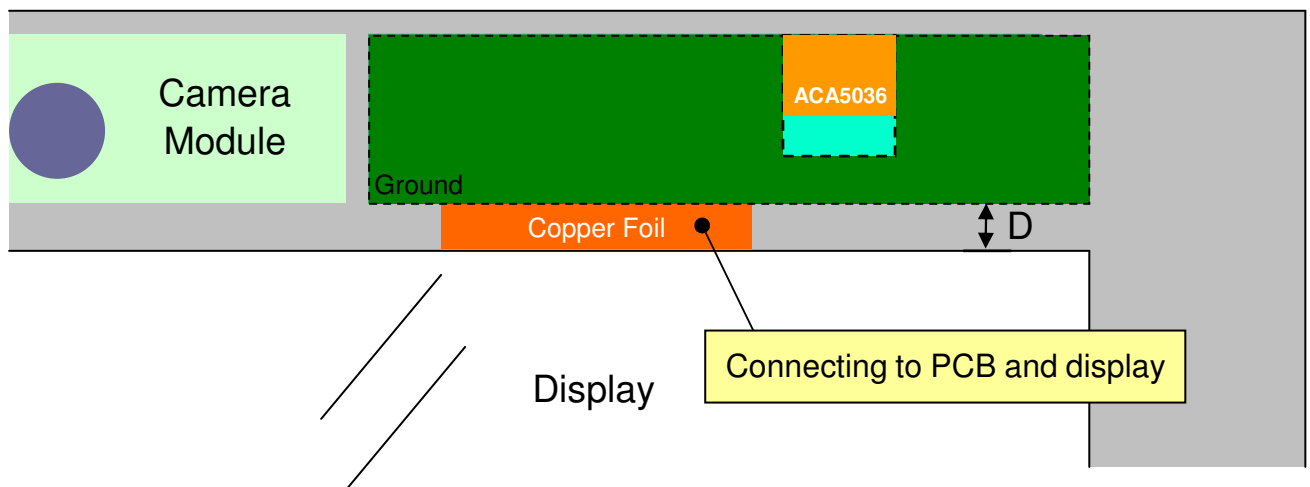
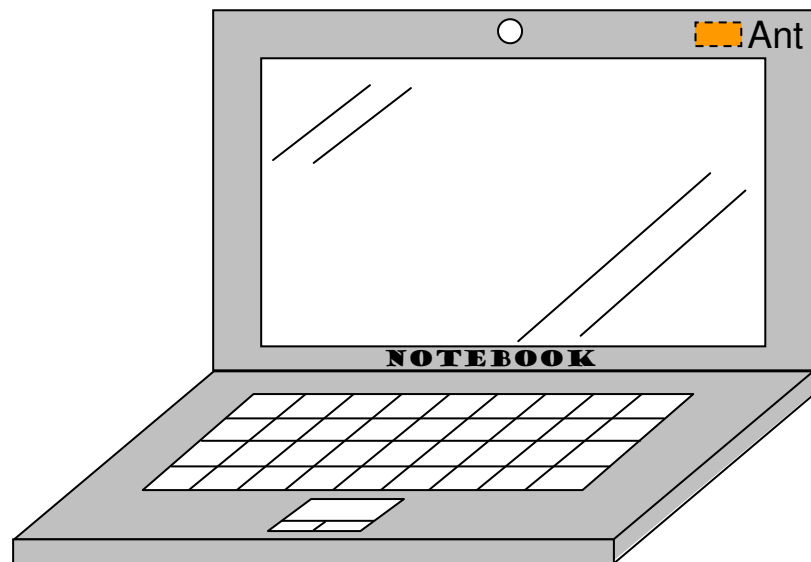

Figure F. Keep the panel away from the PCB more than 3mm.

Symbol	Suggested Distance	Remark
P	$\geq 1\text{mm}$	The edge of display must keep away 3mm from antenna edge.
C	$\geq 3\text{mm}$	The width of clearance area needs 3mm from antenna edge.
G	$\geq 3\text{mm}$	The distance between antenna and panel metal

Notebook Applications

- For the notebook applications, the space is too small to place a larger PCB. As we know, the smaller PCB we have, the worst antenna performance we get. But according to characteristic of this antenna, because the radiation efficiency depends on the size of the metal layer, so we can extend metal layer from PCB to panel by using copper foil. And if the radiation plane can be extended to metal of panel, the PCB size becomes a minor factor of antenna performance; it means we can use smaller PCB to get the similar performance. By the way, the cable which connects from PCB to main board must fix along the edge of display, and shorter cable will get the better performance due to its cable loss.



Symbol	Suggested Distance	Remark
D	$\geq 3\text{mm}$	The distance between antenna and the edge of panel.

Contact Information

INPAQ Technology Co, LTD

Taiwan Chunan

ADD: No.11, Ke-Yi St., Chunan, Miaoli 35059, Taiwan (R.O.C.)

TEL : +886-37-585-555

FAX : +886-37-585-511

E-Mail : info@inpaq.com.tw

Web site : <http://www.inpaq.com.tw>

USA Office

ADD: 21 Echo Brook Road, Rochester, NH 03839, U.S.A.

TEL:+1-603-332-6222

FAX:+1-603-509-2900

Korea Office

ADD: 221 Raemian Seocho Univill, 1445-4, Secho-Dong, Secho_gu, Seoul, Korea
130-070

TEL:+82-2-584-8959

FAX:+82-2-584-8951

