



承认书

SPECIFICATION FOR APPROVAL

客户名称

Customer:

Siretta Limited

产品名称

Product Name:

2.4/5G 4.0dBi Max. External Antenna

规格描述

Description:

2.4/5GHz Dipole to SMA Plug Black

客户料号

CUSTP/N:

硕天料号

SOANT.P/N:

STDPA301200SBL801

发出日期

Approval Date:

2018 / 01 / 15

TECHNICAL DATE

1. Electrical Properties : (电气特性)

- 1.1 Frequency Range (频率范围)2.4~2.5GHz&5.15~5.85 GHz
- 1.2 Impedance (输入阻抗)50Ω
- 1.3 VSWR (电压驻波比)2.0 Max (≤2.0)
- 1.4 Gain(peak) (最大增益)4.0 dBi
- 1.5 Polarization (极化方式)Linear; Vertical

2. Physical Properties : (物理特性)

- 2.1 Cable (线缆) RG-187 Cable
- 2.2 Connector (连接器) SMA PLUG
- 2.3 Antenna Body (天线杆套)ABS+PC
- 2.4 Antenna Base (天线上固定座)PC
- 2.5 Antenna Base (天线下固定座)PBT
- 2.6 Operating Temp (工作温度)-40℃ ~ +65℃
- 2.7 Storage Temp (存储温度)-40℃ ~ +75℃
- 2.8 Color (颜色)Black

Cable SPEC

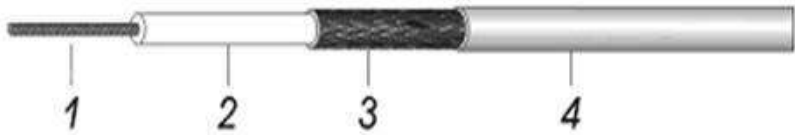
RG、		RG-178 /50Ω		
结构图 Structure drawing				
结构特性 Structure characteristics				
结构 Structure	项目 Item	标准值 Standard value		
①内导体 Inner conductor	材料 Material	镀银铜线 Silverplated copper wire		
	(绞合)标称外径(mm) (Intertwist)NOM.O.D.(mm)	0.306±0.02		
②绝缘层 Insulation	材料 Material	聚四氟乙烯 PTFE		
	标称外径(mm) NOM.O.D.(mm)	0.86±0.05		
③外导体 Outer conductor	材料 Material	镀银铜线 Silverplated copper wire		
	标称外径(mm) NOM.O.D.(mm)	1.3±0.05		
	覆盖率(%) Coverage ratio(%)	≥90		
④外导体 Outer conductor	材料 Material	聚全氟乙丙烯 FEP		
	颜色 Color	透明 Clarity		
	标称外径(mm) NOM.O.D.(mm)	1.78±0.05		
电性能特性 Electrical characteristics				
项目 Item	标准 Standard value	项目 Item	频率 Frequency	标准值 Standard value 单位 Unit:dB/m
电容(pF/m) Capacitance(pF/m)	96	衰减 Attenuation	0.1GHz	≤0.52
速率(%) Velocity(%)	70		0.4GHz	≤1.2
阻抗(Ω) Impedance(Ω)	50±2		1GHz	≤1.7
驻波比 Standing wave ratio	≤1.3@0~6GHz		2GHz	≤2.42
最大工作电压(V) Max.operating voltage(V)	1000		3GHz	≤3.08
最大工作频率(GHz) Max.operating frequency(GHz)	6		4GHz	≤3.63
			5GHz	≤4.15
			6GHz	≤4.8
可靠性 Dependability				
项目 Item	单位 Unit	标准值 Standard value		
最小弯曲半径(一次)Min.bending radius static	mm	10		
最小弯曲半径(重复)Min.bending radius repeated	mm	—		
工作温度范围 Operating temperature	℃	FEP -55~+200		

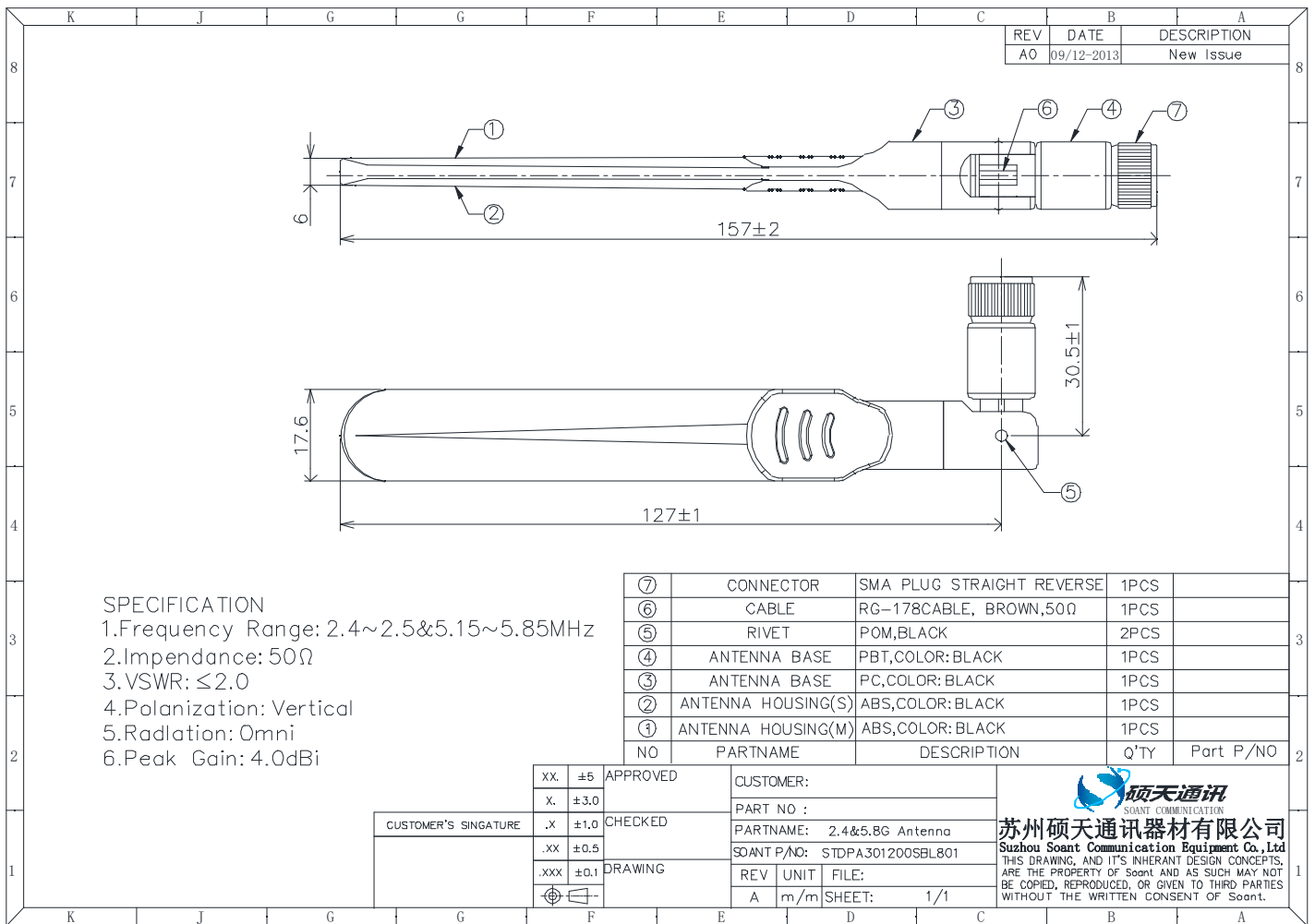
工程图

测试报告

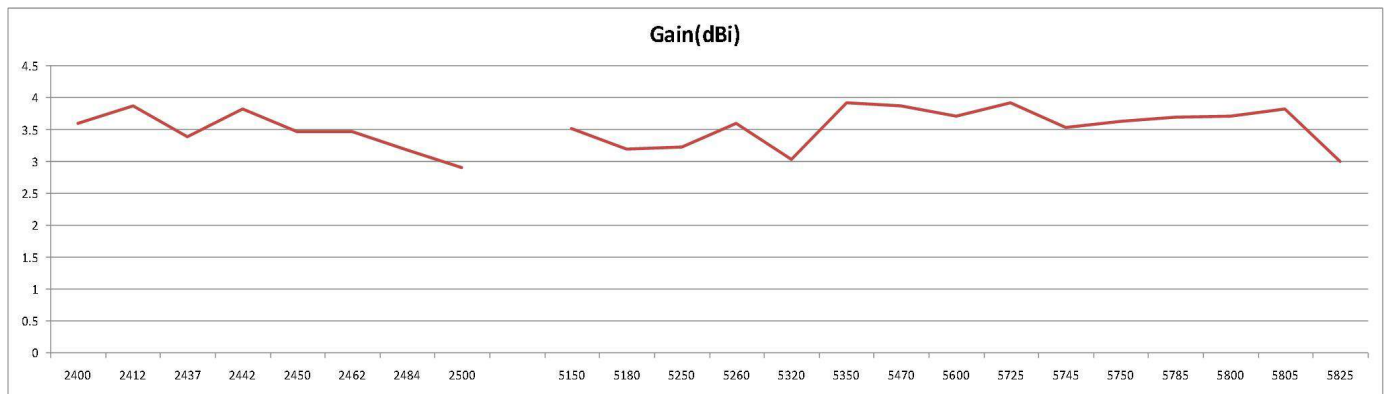
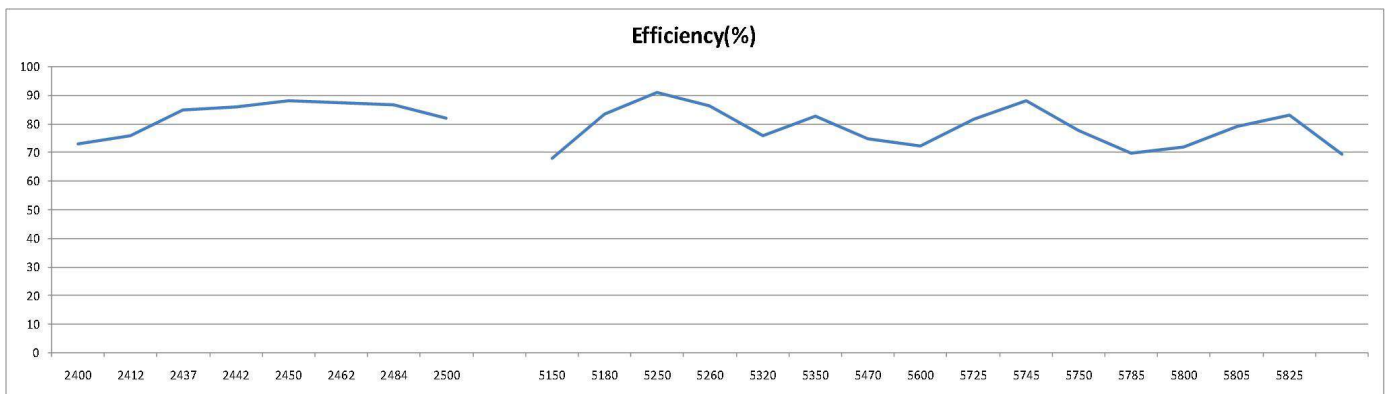
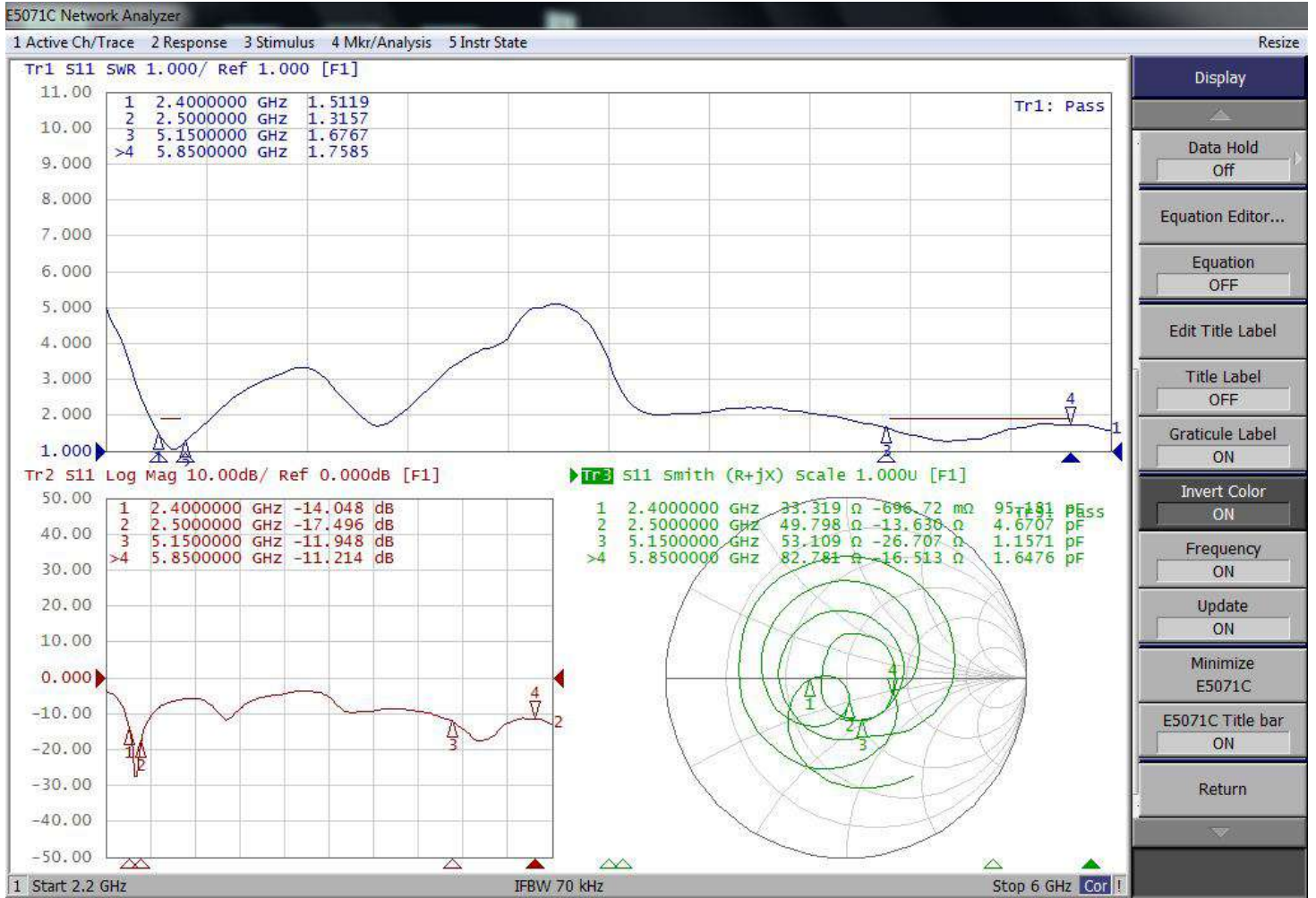

Frequency = 2400 MHz

dBm	XY-Plane	XZ-Plane	YZ-Plane
H-Pol. (Peak.)	2.296006	1.761174	1.261882
V-Pol. (Peak.)	0.962428	-6.490586	0.962428
H+V. (Peak.)	4.125035	2.051732	4.125035
H-Pol. (Avg.)	-0.165797	-2.848378	-3.425074
V-Pol. (Avg.)	-2.199446	-11.884441	-4.591384
H+V. (Avg.)	1.945642	-2.337427	-0.958894
Angle	XY-Plane	XZ-Plane	YZ-Plane
H-Pol. (Peak.)	210	240	90
V-Pol. (Peak.)	90	90	90
H+V. (Peak.)	90	270	90

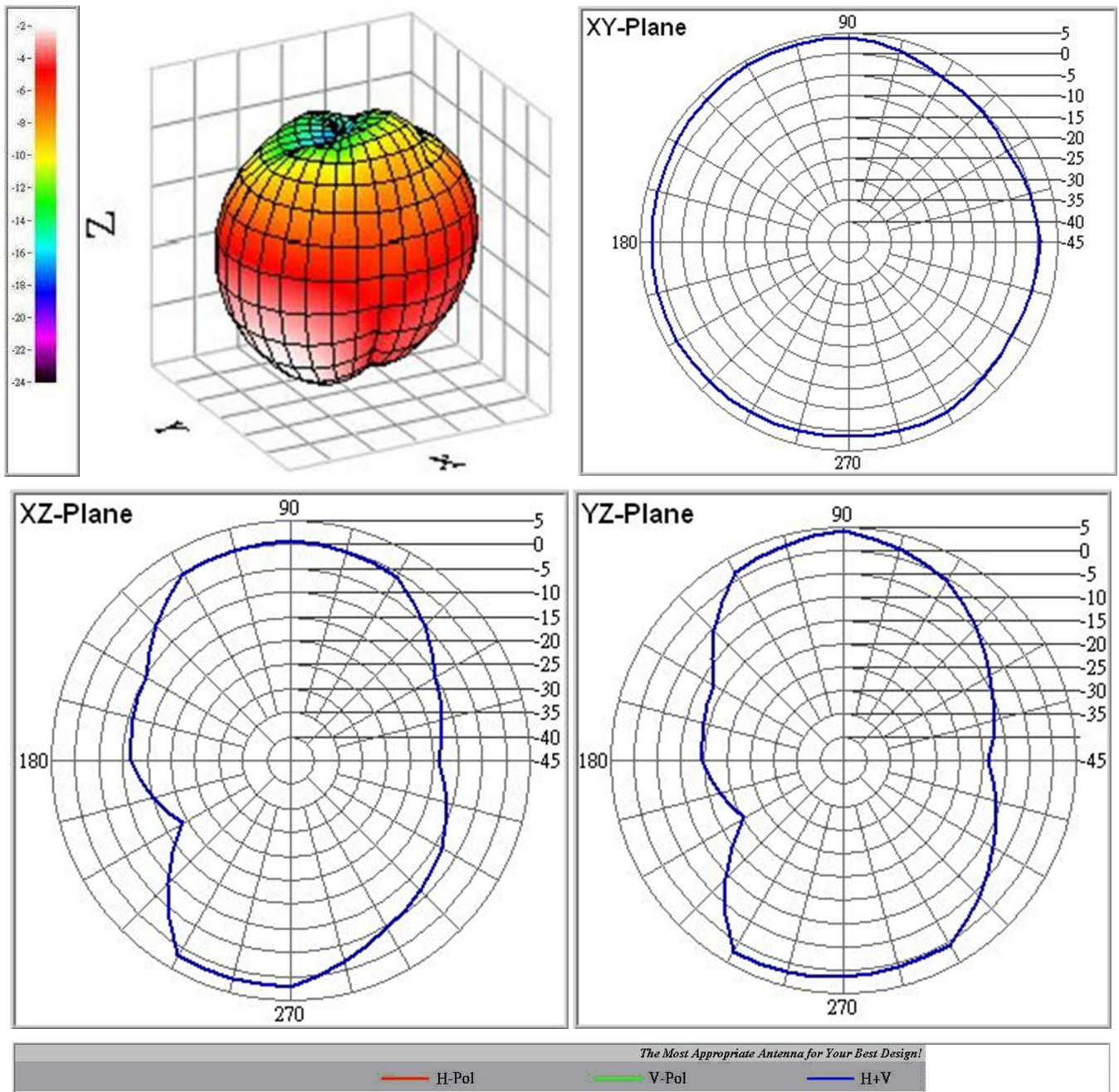

Frequency = 2450 MHz

dBm	XY-Plane	XZ-Plane	YZ-Plane
H-Pol. (Peak.)	3.741152	2.13612	1.624976
V-Pol. (Peak.)	1.834526	-9.176842	1.834526
H+V. (Peak.)	4.741314	2.429035	4.741314
H-Pol. (Avg.)	0.485179	-2.969876	-3.077092
V-Pol. (Avg.)	-2.721829	-13.991935	-4.828045
H+V. (Avg.)	2.181507	-2.63954	-0.854618
Angle	XY-Plane	XZ-Plane	YZ-Plane
H-Pol. (Peak.)	210	270	90
V-Pol. (Peak.)	90	90	90
H+V. (Peak.)	90	270	90

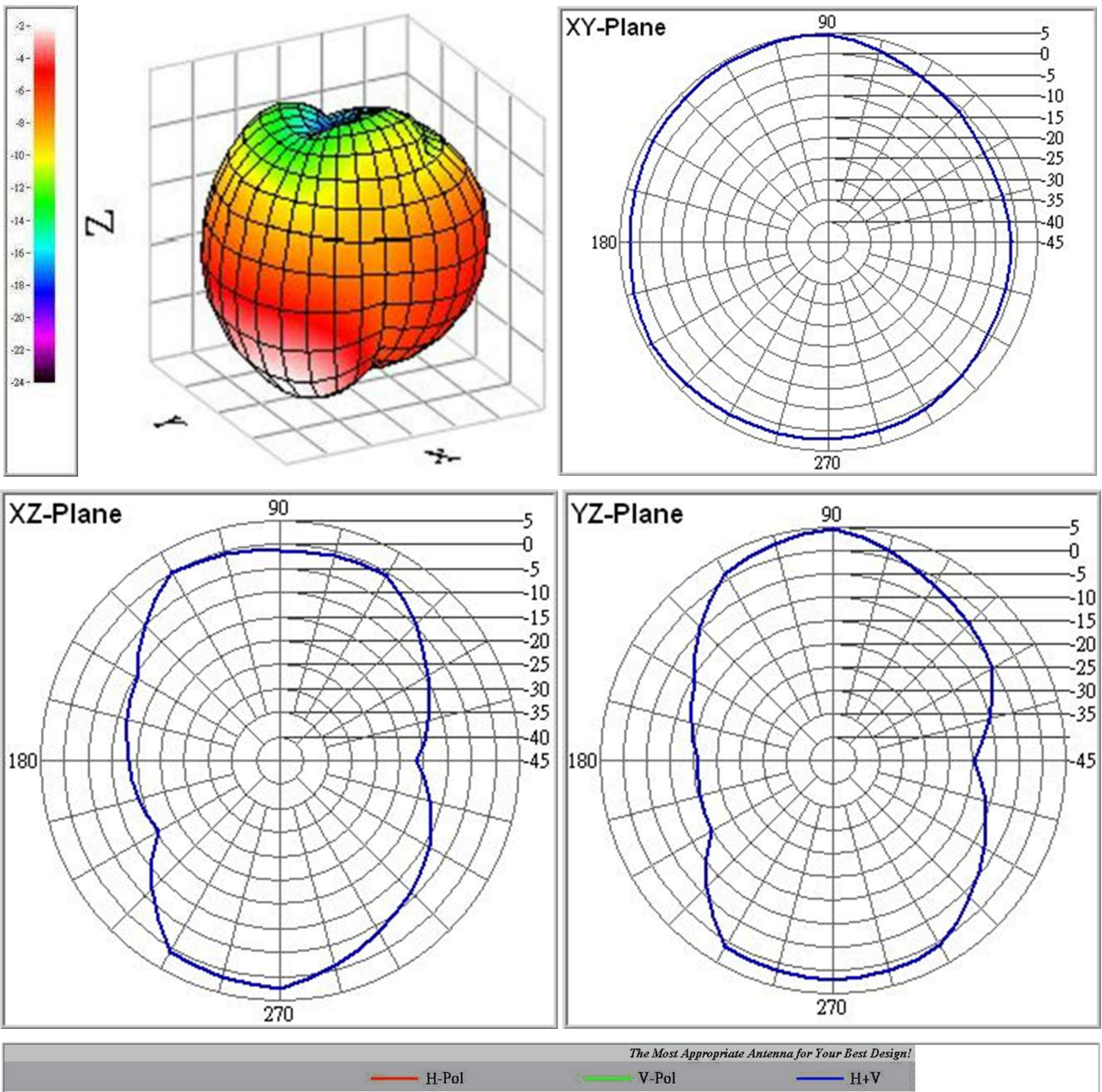

Frequency = 2500 MHz

dBm	XY-Plane	XZ-Plane	YZ-Plane
H-Pol. (Peak.)	3.082123	1.071906	1.276167
V-Pol. (Peak.)	1.110518	-11.691541	1.110518
H+V. (Peak.)	4.204432	1.295877	4.204432
H-Pol. (Avg.)	-0.021553	-3.691696	-3.372855
V-Pol. (Avg.)	-3.706997	-15.49871	-5.498438
H+V. (Avg.)	1.525764	-3.414276	-1.296583
Angle	XY-Plane	XZ-Plane	YZ-Plane
H-Pol. (Peak.)	210	270	90
V-Pol. (Peak.)	90	270	90
H+V. (Peak.)	90	270	90

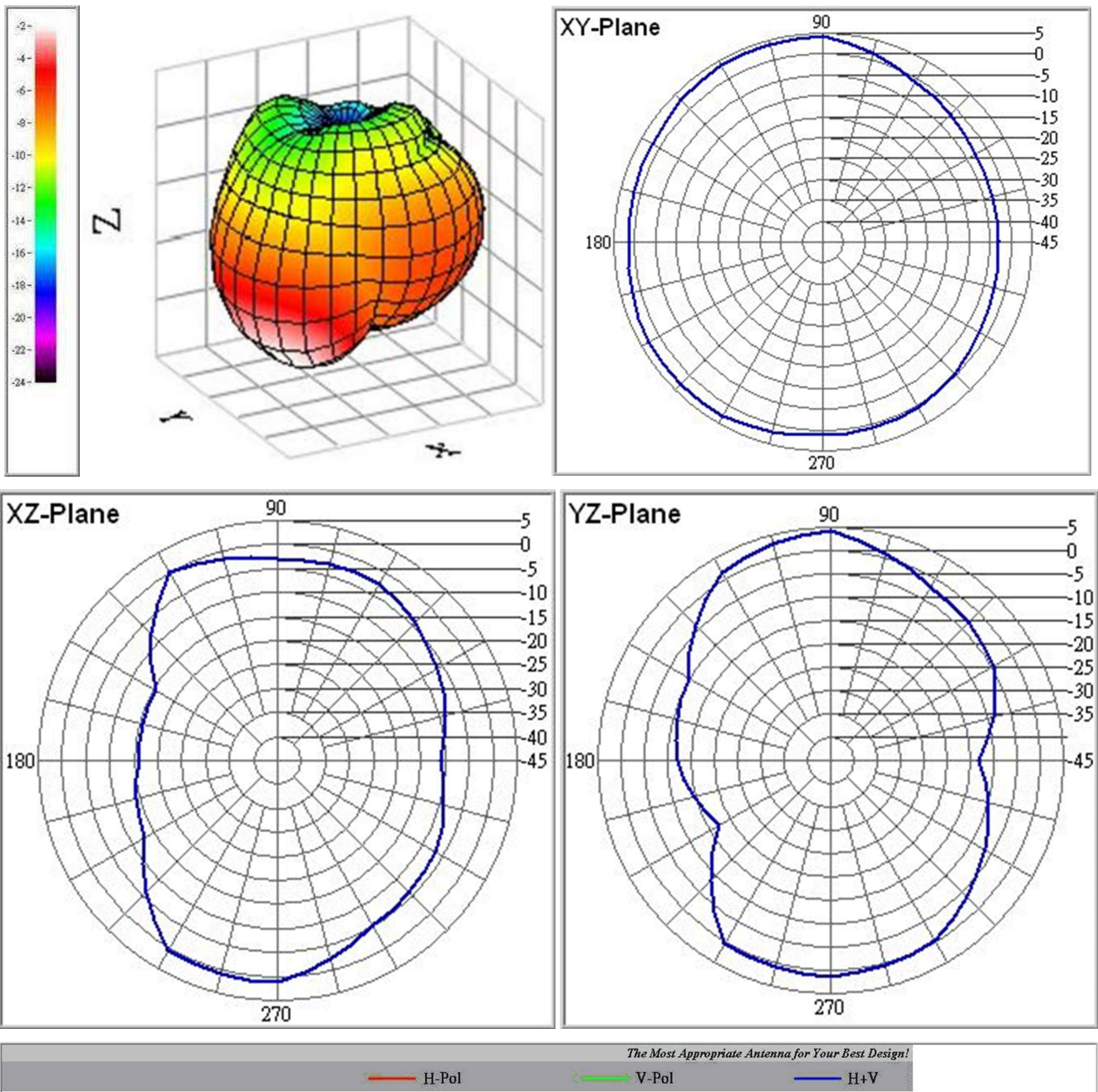

Frequency = 5150 MHz

dBm	XY-Plane	XZ-Plane	YZ-Plane
H-Pol. (Peak.)	2.220263	-0.290437	2.220263
V-Pol. (Peak.)	-4.481174	-4.481174	-1.132965
H+V. (Peak.)	2.258463	0.911037	2.258463
H-Pol. (Avg.)	-1.720219	-4.385929	-2.84705
V-Pol. (Avg.)	-7.934686	-7.811424	-7.611585
H+V. (Avg.)	-0.789206	-2.759053	-1.595993
Angle	XY-Plane	XZ-Plane	YZ-Plane
H-Pol. (Peak.)	270	30	270
V-Pol. (Peak.)	180	270	210
H+V. (Peak.)	270	30	270

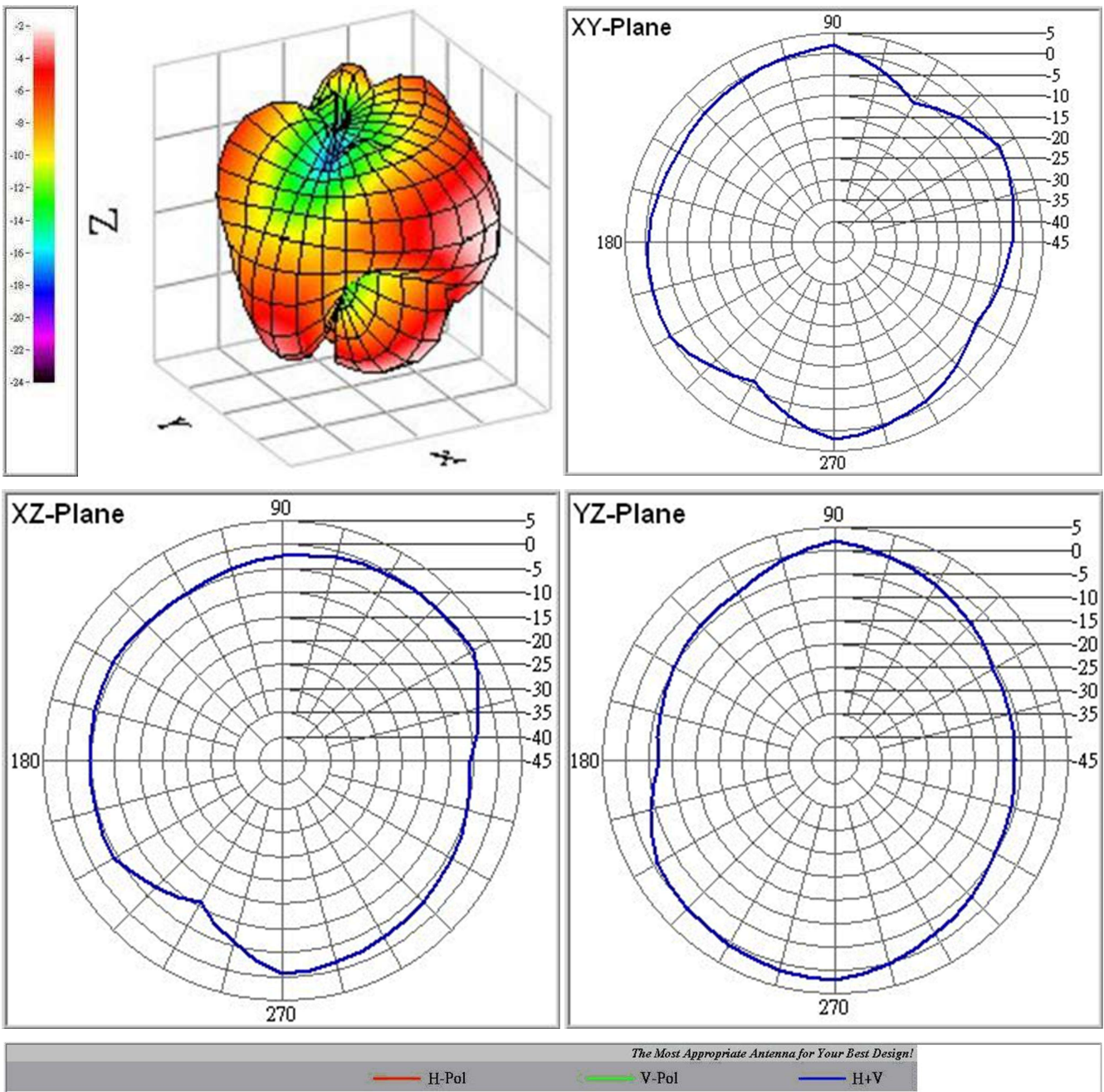
The Most Appropriate Antenna for Your Best Design!

H-Pol V-Pol H+V

Frequency = 5550 MHz

dBm	XY-Plane	XZ-Plane	YZ-Plane
H-Pol. (Peak.)	2.301025	-0.138756	1.460018
V-Pol. (Peak.)	-4.50109	-2.132682	-0.29056
H+V. (Peak.)	2.556831	0.670118	2.275328
H-Pol. (Avg.)	-0.894828	-4.237625	-3.733099
V-Pol. (Avg.)	-7.474582	-9.187944	-4.411267
H+V. (Avg.)	-0.031947	-3.032326	-1.048659
Angle	XY-Plane	XZ-Plane	YZ-Plane
H-Pol. (Peak.)	30	90	90
V-Pol. (Peak.)	300	210	210
H+V. (Peak.)	30	90	90

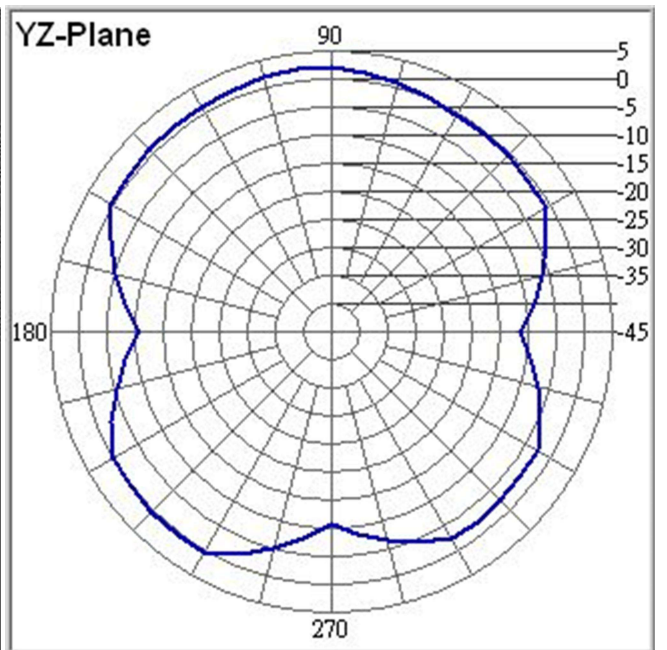
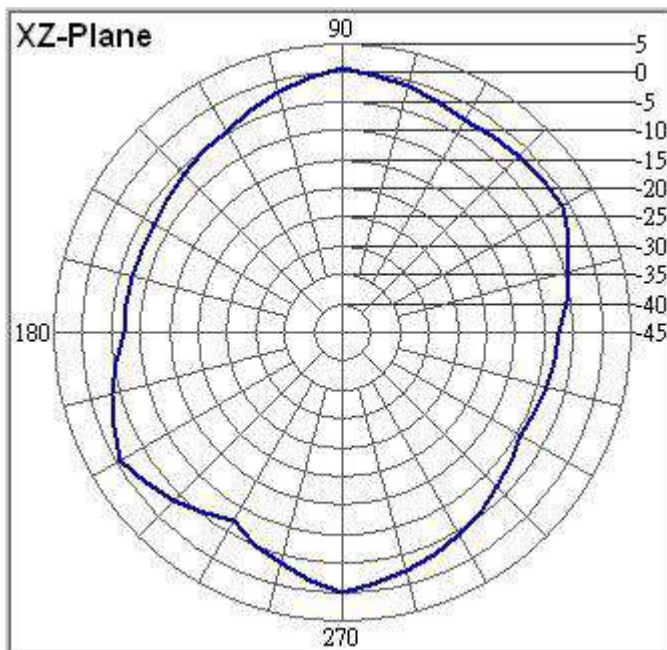
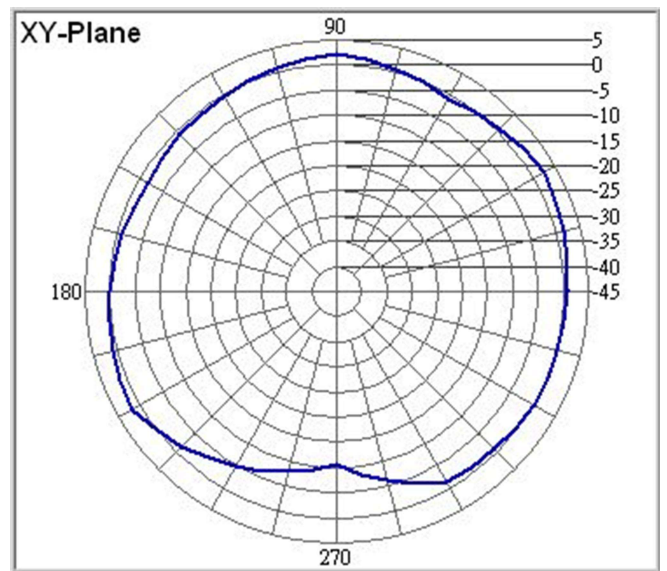
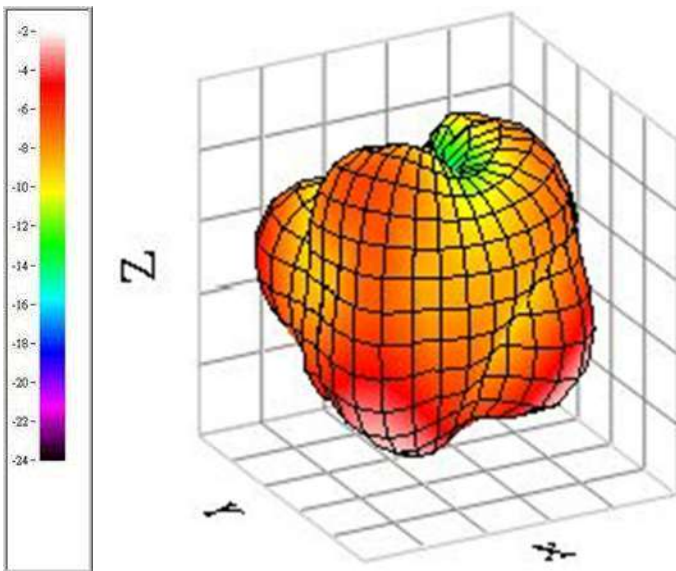

The Most Appropriate Antenna for Your Best Design!

— H-Pol — V-Pol — H+V

Frequency = 5850 MHz

dBm	XY-Plane	XZ-Plane	YZ-Plane
H-Pol. (Peak.)	2.203566	1.759623	2.576109
V-Pol. (Peak.)	-3.62567	-2.765532	-0.929579
H+V. (Peak.)	3.211619	2.400898	3.573761
H-Pol. (Avg.)	-0.63166	-3.766019	-3.049738
V-Pol. (Avg.)	-6.736037	-9.081011	-5.16618
H+V. (Avg.)	0.320813	-2.646327	-0.96999
Angle	XY-Plane	XZ-Plane	YZ-Plane
H-Pol. (Peak.)	330	270	240
V-Pol. (Peak.)	330	210	210
H+V. (Peak.)	330	270	240

