

SECURITY CAMERA

Indoor/Outdoor

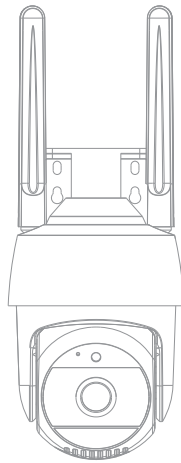

Quick Installation Guide

Thank you for choosing our security camera. Please read the quick installation guide carefully before using and keep it in good conditions.

Contents

I. Product Packing List	1
II. Appearance Brief	2
III. Product Instructions	3
1.APP Download and Installation.....	3
2. Accounts Registration.....	4
3. QR Code Net-paring (Recommendation)	5
IV. Operation Guide	8
1. Interface Introduction	8
2.1 Detection Alarm Messages	9
2.2 Video Cloud Storage.....	9
2.3 Features.....	10
3. Basic Settings.....	11
3.1-1 Basic Function Settings	11
3.1-2 Basic Function Settings	12
3.2 Detection Alarm Settings	13
3.3 Storage Settings	14
3.4 Offline Notification	15
3.5 Share Device	15
V. Help Center&More Service.....	16
VI. Installation Instructions	17
VII. Troubleshooting	18
VIII. Legal Declaration	21

I. Product Packing List

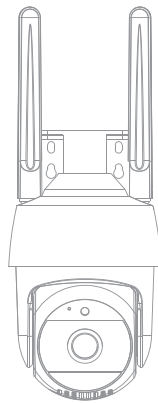

1 Camera

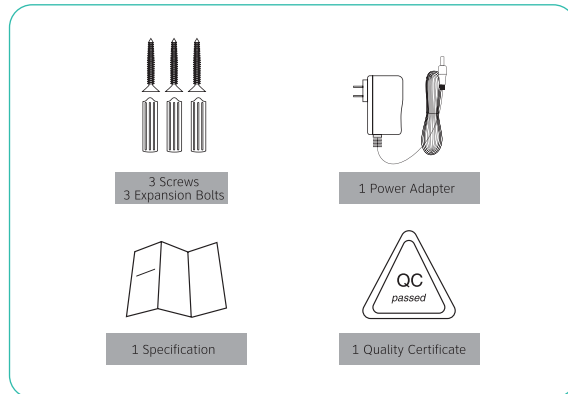

II. Appearance Brief

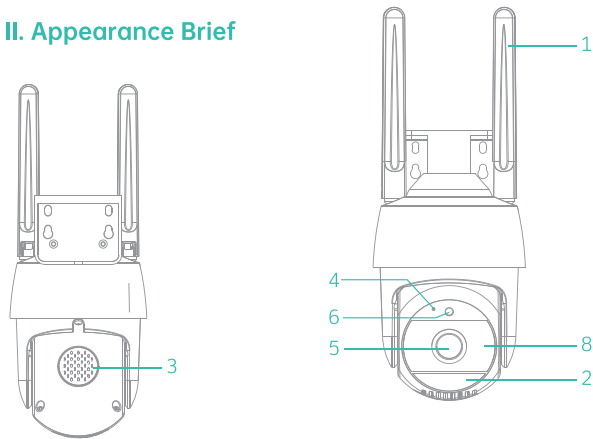

- 1 Wifi Antenna
- 2 Floodlight LEDs
- 3 Speaker
- 4 Microphone
- 5 Camera Lens
- 6 Indicator
- 7 TF card slot & Reset Button
- 8 Infrared LEDs

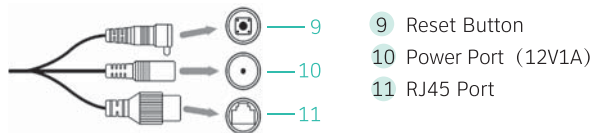
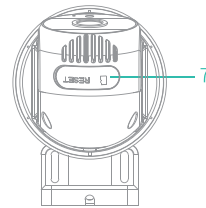

The model shown above is a schematic diagram. This diagram is used only as the specification description, not for a specific product.

III. Product Instructions

1. APP Download and Installation

- 1). For Android devices, search in Google Play and download "Tuya smart"; For iOS devices, download "Tuya smart" in APP store.



- 2). Scan the "Tuya smart" APP QR code below, download and install it according to the APP hints to complete the download.



Android & iOS

Notes: To ensure that the full functionality of the "Tuya smart" APP works properly, allow the "Tuya smart" APP to gain access to your mobile devices.

2. Accounts Registration

Open the Tuya smart APP, click “Agree” of privacy policy and then register an account with a mailbox or mobile number, after registering successfully, log in the Tuya smart APP.

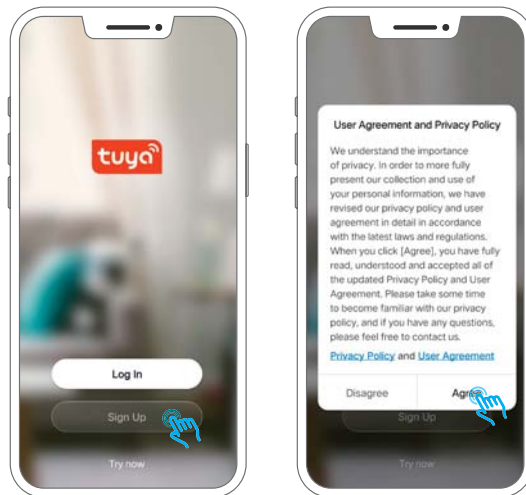

Notes:

- 1) Please tick “Agree” the “User Agreement and Privacy Policy”;
- 2) If the verification code is sent out over time due to network problems, please try again later;
- 3) If register with mailbox, please check the verification code in spam mailbox if you didn't receive.

3. QR Code Net-paring (Recommendation)

Step 1: Powered on the camera. After powered, the camera will emit a beep. If not, please press and hold the reset button for 3 seconds to reset the device.

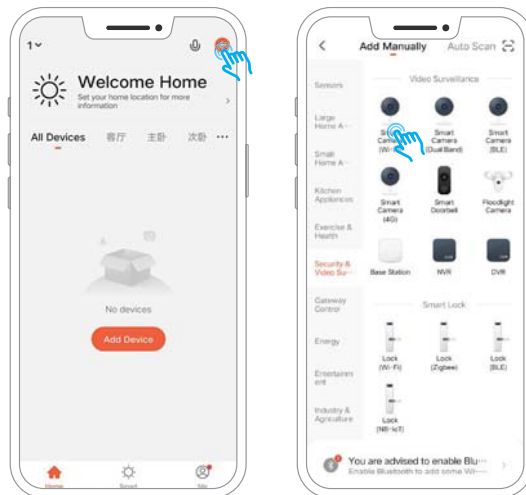

Notes:

- 1) The passwords do not support special characters such as @,#,%,&
- 2) Place the camera next to the router before configuring

Step 2: Connect the mobile phone to 2.4G WIFI and open the APP "Tuya Smart", then follow the steps as follow.

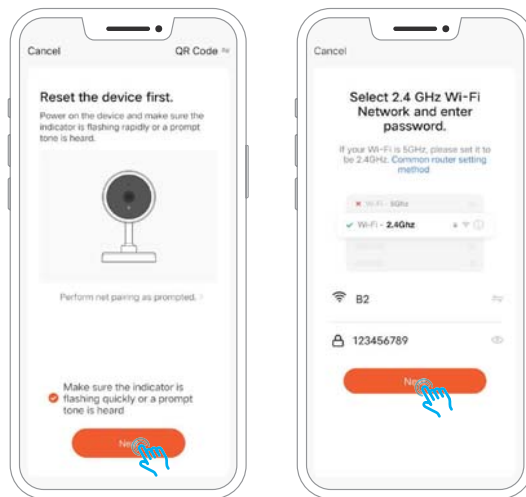

- 3) QR Code Net-paring and Smart Configuration only support 2.4Ghz wifi
- 4) Make sure the network of your mobile devices are under the same network router of the camera

Step 3: Please place the camera and QR code of the mobile phone at a distance of 5.9-7.8 inch . Within this range, the mobile phone can be moved slightly left and right, up and down to ensure that the camera can scan the QR code on the phone. Heard the beep, click "I Heard the Prompt".

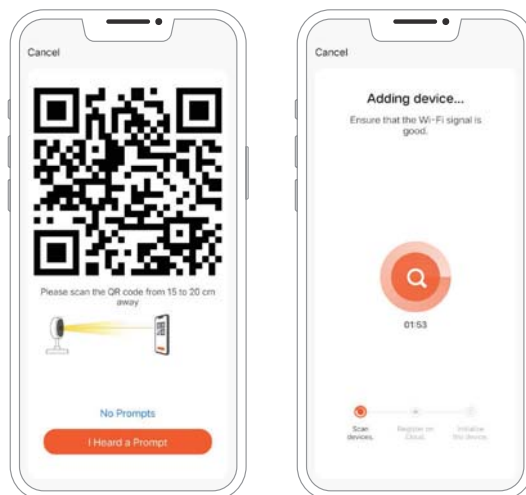

IV. Operation Guide

1. Interface Introduction

When accessing to the current interface, you can slide or zoom the video interface, switch to play sound, capture High-Definition (HD) pictures, view the real-time video with full screen, snapshot real-time pictures and launch an intercom, save pictures and record video to local album, select the HD mode of the camera.

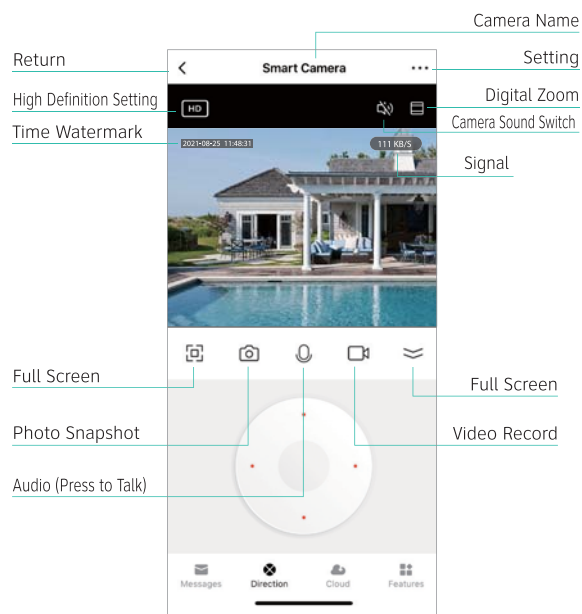

2.1 Detection Alarm Messages

You can click "All" and then choose the exact date to check the alarm message.

2.2 Video Cloud Storage

Support record the latest 30 days' event recordings. 1 month free trial. 4 plans can be chosen as your needs.

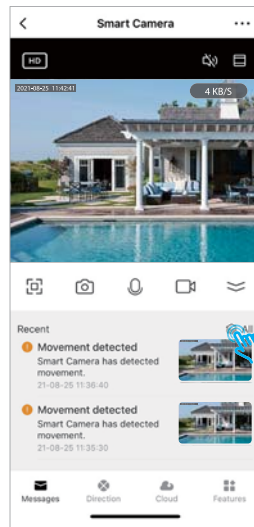

(2.1)

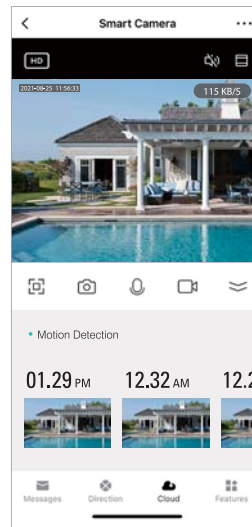

(2.2)

2.3 Features

Playback: Entering the playback interface, you can capture pictures, watch and record video during the time you need.

Gallery: You can find the photos and videos which you have taken here. And you also can select the pictures or video to delete which you don't need.

Theme Color: There has light mode and dark mode, you can choose the color you like.

Private Mode: Open this mode, the camera will be in sleep mode which means that the camera will not record, click "Turn on the camera", then it will records again.

Night Mode: It has 3 mode: smart, Infrared and color light mode. Choose the best way you need;

Motion Tracking: Turn on motion tracking, the camera will follow the movement of the object when it detects the object is moving.

Motion Detection: Turn on motion detection, if the camera detects object movement, and the app will send a notification;

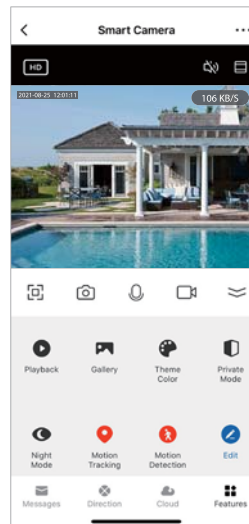

(2.3)

3. Basic Settings

3.1-1 Basic Function Settings

Private Mode: Open this mode, the camera will be in sleep mode which means that the camera will not record, click "Turn on the camera", then it will records again.

Basic Function Setting: Flip Screen, Time Watermark and Talk Mode

Flip Screen: Turn on " Flip Screen", then you can see the picture of live video is 180 degree rotation.

Time Watermark: Turn on "Time Watermark", the time will be displayed in the upper right corner of the live video.

Talk Mode: One-way talk and two-way talk

One-way Talk: Only one-way communication is available. After you send a voice message, the other party can receive it and then reply you with a voice message.

Two-way Talk: You and the other party can talk and listen to each other simultaneously.

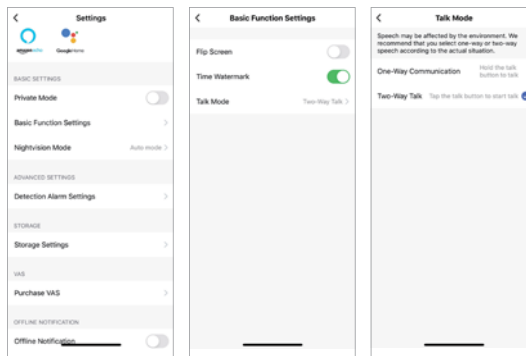

3.1-2 Basic Function Settings

Nightvision Mode: Auto Mode,IR Mode and Color Mode

Auto Mode(Recommended): During the day, the video is in color. In the dark, the camera automatically switches to black and white color.

IR Mode: During the day, the video is in color. But in the dark, the color of the video is pitch black.

Color Mode: Whether it is day or night, the color of the video is black and white.

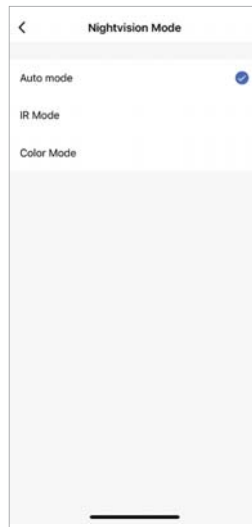

3.2 Detection Alarm Settings

Before using movement detection alert, please plug a TF card into the camera or have successfully purchased cloud storage service.

Motion Detection Alarm: Turn on motion detection, if the camera detects object movement, then the app will send a notification;

Alarm Sensitivity Level: Motion detection has low, medium and high level ;

Activity Area/Surveillance Area Setting: You can set the area and size where you want to monitor;

Motion Tracking: The camera will follow the movement of the object when it detects the object is moving.

Alarm Timer Settings: Customize the set time to turn motion detection on or off.

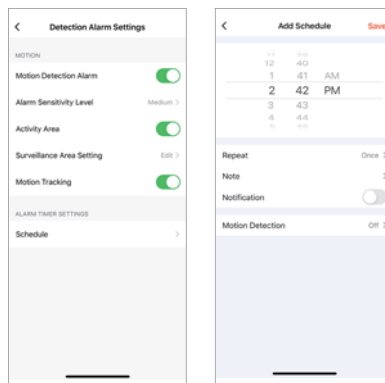

3.3 Storage Settings

The camera has microSD card slots and local backup, supports a TF card up to 128GB. You can choose recording mode and set the schedule to open or close the switch.

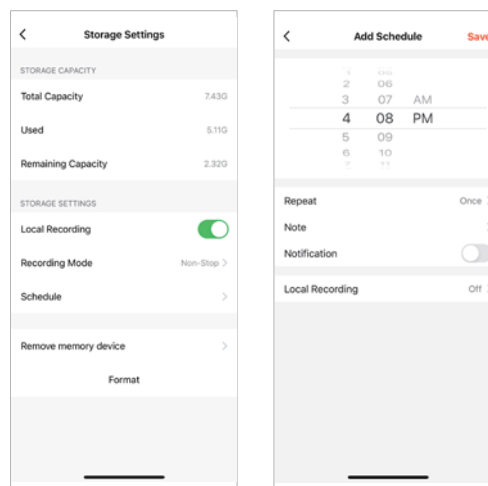

Notes:

1. If the video saved by SD card, please turn on the Local Recording in the storage settings.
2. The SD card must be formatted on the computer before inserting the SD card.
3. Unplug the power cable before inserting the SD card, otherwise it will burn the SD card.
4. One memory card can only correspond to one camera. If you want to use it in other cameras, please format it firstly.

3.4 Offline Notification

To avoid constant reminders, a notification will be sent if the device stayed offline over 30 minutes.

3.5 Share Device

Note: (Before sharing)

1. The shared person should download Tuya smart APP firstly;
2. The shared account should choose the country on the APP as same as the master account when register the APP.

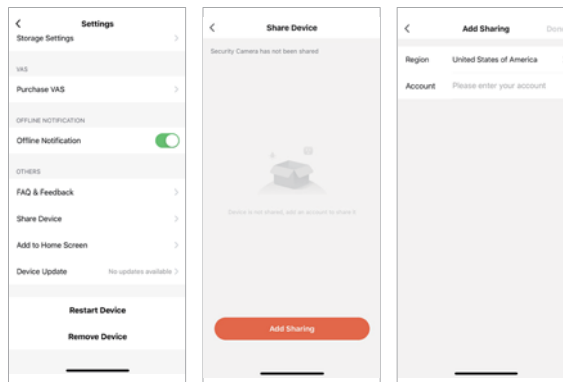

V. Help Center&More Service

In the help center, you can find the solution of the problem. Click all, you can find more solution of the issue. If all the above solutions can't solve your problem, you also can submit the question by clicking the "Unresolved? Send Feedback". Then you will get the answer in 24 hours. But we recommend you to contact the seller directly better.

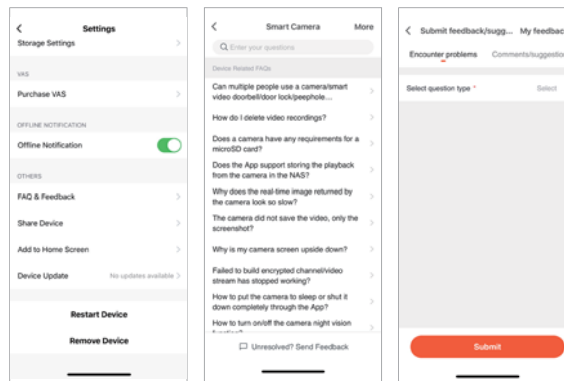

VI. Installation Instructions

Use the 2 large screws included in the box to fix the bracket to the position where you need to install it.

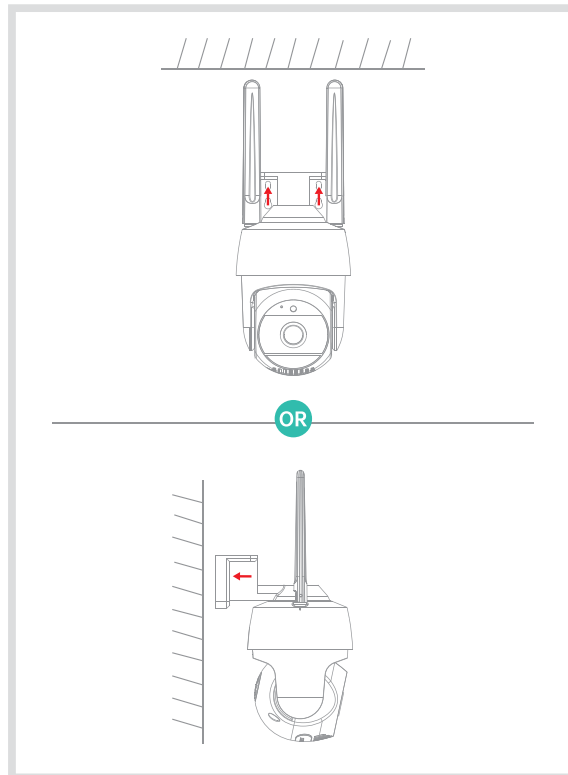

VII. Troubleshooting

1. APP can't be registered successfully

- Please check if the network of the mobile phone is normal;
- Please tick the software service agreement and privacy policy;
- Please check if the verification code is in the spam mail;
- Please use WIFI to register if mobile network cannot be registered. If the mobile network and WIFI prompts cannot obtain the server address, please check if other software can be used normally;
- During installation, please allow the app to obtain your location and all permissions, the system will automatically arrange the best server;
- If above solutions still can't be effective, we recommend you to uninstall and install the app again, the current location and all permissions are allowed during the installation)

2. Unable to connect to the network

2.1 Unable to connect to WiFi:

- Please enable the DHCP of the router;
- Please make sure the camera is not in the blacklist in MAC settings of the router;
- Turn off the 5GHz wifi in the router (Note: Please contact the router manufacturer if you can't turn off the 5Ghz wifi);
- After connecting to the 2.4GHz wifi, please check your mobile phone if can access the Internet;
- Make sure the network of your mobile devices are under the same network router of the camera;
- After the network is normal, reset the camera and reconnect.

2.2 Unable to connect to wired:

- Please enable the DHCP of the router;
- Please make sure the camera is not in the blacklist in

- MAC settings of the router;
- Connect the network cable to your computer firstly, then check the computer and obtain the IP address. If the IP address of the computer is setted by manual, please go to the router and enable the DHCP server to obtain the IP address;
 - After enable the DHCP server, check if the computer can access the Internet normally. (Note: If the computer displays the DHCP mode, then it can get the IP address and access the Internet normally);
 - Connect the network cable to the device and reset the new connection.
- 2.3 Wifi password reason
- Check the WiFi password connected of the camera is same as the WiFi password of the connected router.
 - Check if the entered WiFi password has space or special characters(@,#,%,&).
- 2.4 Disconnected 5Ghz WIFI, unable to connect to wifi
- Turn off the 5Ghz network and keep the 2.4Ghz network. Disconnect the router and then restart the camera;
 - WiFi name naming cannot have "5Ghz" words.
3. Camera match the wififi successfully, but can't hear the voice of camera
- Reset the camera, then power off and reconnect the camera (Only reset can remove local data);
 - Put the phone as close as possible to the camera and router when it is connecting;
 - Please turn off the 5GHz wifi.
4. No pop-up message for motion detection alarm
- Open permission setting in the system settings of mobile device to allow APP to receive message push notification;
 - Some Android phones can not receive the alarm push information;
 - Please turn on the motion detection in APP(Please refer to the page 13)
 - SMS and email reminders are not supported at this time.

5. Motion detection messages prompt frequently

- If motion detection sensitivity is too high, light changes also can cause alarm;
- Reduce sensitivity of alarms (recommended low level).

6. After inserting SD, it displays damaged

- Before inserting the SD card, Disconnect the power. Connect the power to start after plugging in the card;
- The SD card must be formatted on the computer before using the SD card;
- When choosing SD, please choose genuine.

7. No playback record after insert the SD card

Please refer to the page 14

8. Watch videos with the same camera on different devices

- The master account can share the video to other account without limit quantity, but the shared accounts only have the rights to watch, snapshot and record video;
- The App name and password of the main account also could be logged in on other devices to view the video and use any function.

9. The scenarios for the reset key

- Reset wifi information.
- Wifi exception before connecting to the camera
- wifi password error
- wifi drop
- replace new wifi

VIII. Legal Declaration

Disclaimer

The products (including hardware, software, firmware, etc.) described in this manual (including its hardware, software, firmware, etc.) should be provided in accordance with the "status quo". As for the possibility of defects, errors, or failures, We do not provide any form of express or implied warranty, including but not limited to the merchantability or the assurance that the person is applicable to a particular purpose.

if it involves Internet services when using the product described in this manual, you may be affected by the instability of various links, and may be caused by computer viruses, hacker attacks, system instability, and other incompatible factors that cause the software to fail to achieve the desired results, and may lead to you because of incorrect operation or other reasons. For personal information or data leakage or loss, you should strengthen your personal information and take all the relevant risks yourself.

When using this product, please strictly follow the applicable law. You agree that this product shall be used only for civil use and shall not be used to infringe upon the rights of third parties, to use in medical / safety device or other applications which may cause life danger or injury to life, or weapons of mass destruction, chemical or biological weapons, nuclear explosions or any unsafe nuclear energy use or dangerous or unhuman use. Any loss or liability arising from the above use will be at your own expense.

If the above content conflicts with the applicable law, the law shall prevail.

SECURITY CAMERA

Indoor/Outdoor



Warning:

This device complies with Part 15 of the FCC Rules. Operation is subject to the following two conditions: (1) this device may not cause harmful interference, and (2) this device must accept any interference received, including interference that may cause undesired operation.

changes or modifications not expressly approved by the party responsible for compliance could void the user's authority to operate the equipment.

NOTE: This equipment has been tested and found to comply with the limits for a Class B digital device, pursuant to Part 15 of the FCC Rules. These limits are designed to provide reasonable protection against harmful interference in a residential installation. This equipment generates, uses and can radiate radio frequency energy and, if not installed and used in accordance with the instructions, may cause harmful interference to radio communications. However, there is no guarantee that interference will not occur in a particular installation. If this equipment does cause harmful interference to radio or television reception, which can be determined by turning the equipment off and on, the user is encouraged to try to correct the interference by one or more of the following measures:

- Reorient or relocate the receiving antenna.
- Increase the separation between the equipment and receiver.
- Connect the equipment into an outlet on a circuit different from that to which the receiver is connected.
- Consult the dealer or an experienced radio/TV technician for help.

NOTE: This device and its antenna(s) must not be co-located or operation in conjunction with any other antenna or transmitter

RF Exposure Statement

To maintain compliance with FCC's RF Exposure guidelines, This equipment should be installed and operated with minimum distance of 20cm the radiator your body. This device and its antenna(s) must not be co-located or operation in conjunction with any other antenna or transmitter