

802.11n-HT40 Out-of-Band Emissions - Ant 1 / Ant 0 + 1

Channel 03 (2422MHz)

100kHz PSD reference Level

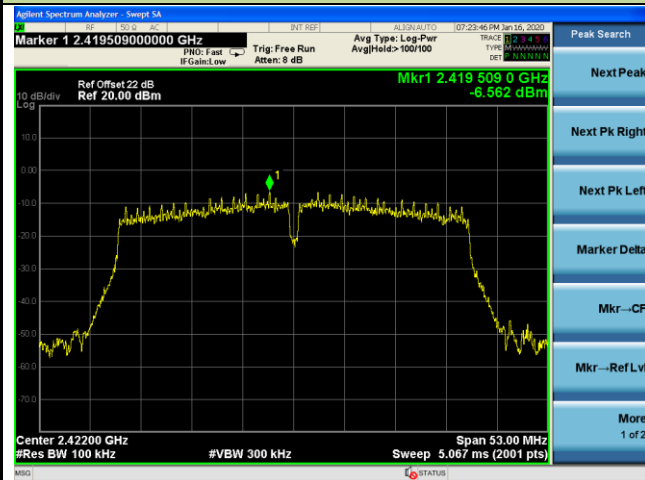

Low Band Edge

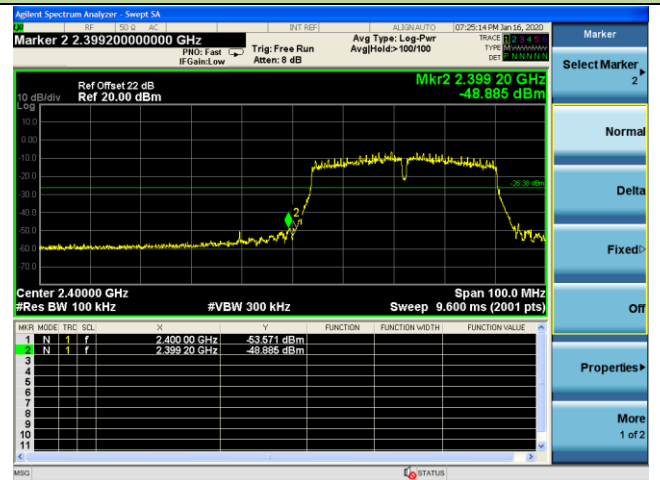

Spurious Emission

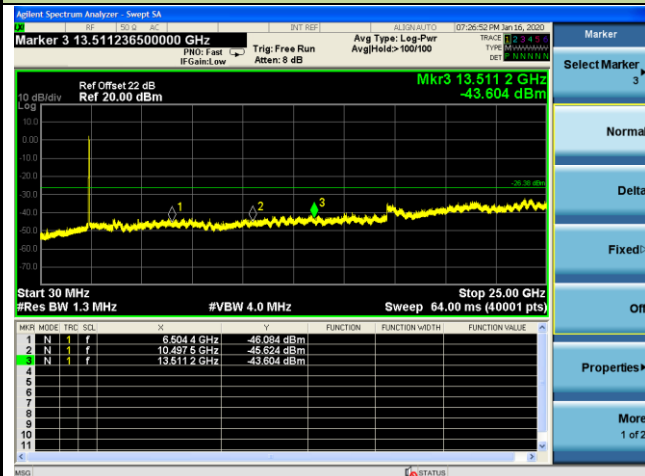

802.11n-HT40 Out-of-Band Emissions - Ant 1 / Ant 0 + 1

Channel 06 (2437MHz)

100kHz PSD reference Level



Spurious Emission



802.11n-HT40 Out-of-Band Emissions - Ant 1 / Ant 0 + 1

Channel 09 (2452MHz)

100kHz PSD reference Level



High Band Edge

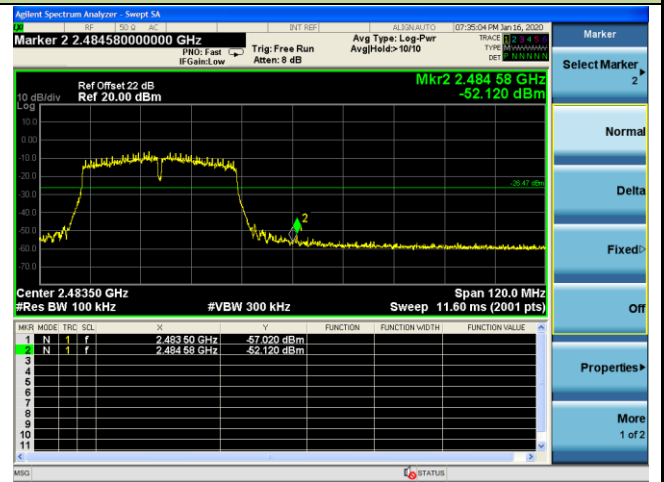

Spurious Emission

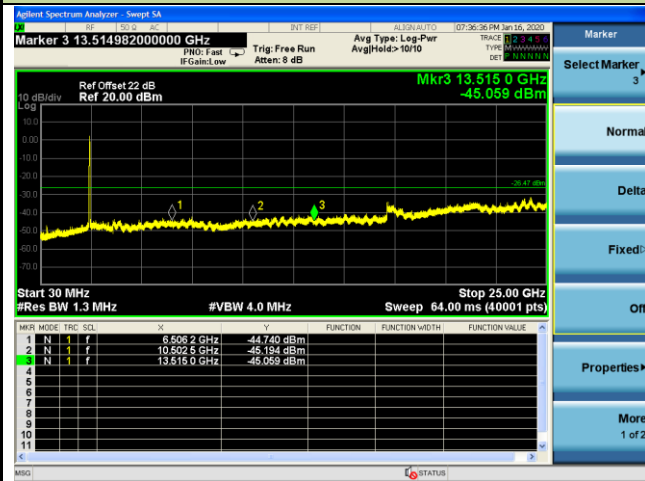

7.6. Radiated Spurious Emission Measurement

7.6.1. Test Limit

All out of band emissions appearing in a restricted band as specified in Section 15.205 of the Title 47CFR must not exceed the limits shown in Table per Section 15.209.

FCC Part 15 Subpart C Paragraph 15.209		
Frequency [MHz]	Field Strength [uV/m]	Measured Distance [Meters]
0.009 - 0.490	2400/F (kHz)	300
0.490 - 1.705	24000/F (kHz)	30
1.705 - 30	30	30
30 - 88	100	3
88 - 216	150	3
216 - 960	200	3
Above 960	500	3

7.6.2. Test Procedure Used

ANSI C63.10 Section 6.3 (General Requirements)

ANSI C63.10 Section 6.4 (Standard test method below 30MHz)

ANSI C63.10 Section 6.5 (Standard test method above 30MHz to 1GHz)

ANSI C63.10 Section 6.6 (Standard test method above 1GHz)

7.6.3. Test Setting

Table 1 - RBW as a function of frequency

Frequency	RBW
9 ~ 150 kHz	200 ~ 300 Hz
0.15 ~ 30 MHz	9 ~ 10 kHz
30 ~ 1000 MHz	100 ~ 120 kHz
> 1000MHz	1MHz

Quasi-Peak Measurements below 1GHz

1. Analyzer center frequency was set to the frequency of the radiated spurious emission of interest
2. Span was set greater than 1MHz
3. RBW = as specified in Table 1
4. Detector = CISPR quasi-peak
5. Sweep time = auto couple
6. Trace was allowed to stabilize

Peak Measurements above 1GHz

1. Analyzer center frequency was set to the frequency of the radiated spurious emission of interest
2. RBW = 1MHz
3. VBW = 3MHz
4. Detector = peak
5. Sweep time = auto couple
6. Trace mode = max hold
7. Trace was allowed to stabilize

Average Measurements above 1GHz (Method VB)

1. Analyzer center frequency was set to the frequency of the radiated spurious emission of interest
2. RBW = 1MHz
3. VBW; If the EUT is configured to transmit with duty cycle $\geq 98\%$, set VBW = 10 Hz.
If the EUT duty cycle is $< 98\%$, set VBW $\geq 1/T$. T is the minimum transmission duration.
4. Detector = Peak
5. Sweep time = auto
6. Trace mode = max hold
7. Trace was allowed to stabilize

7.6.4. Test Setup

Below 1GHz Test Setup:

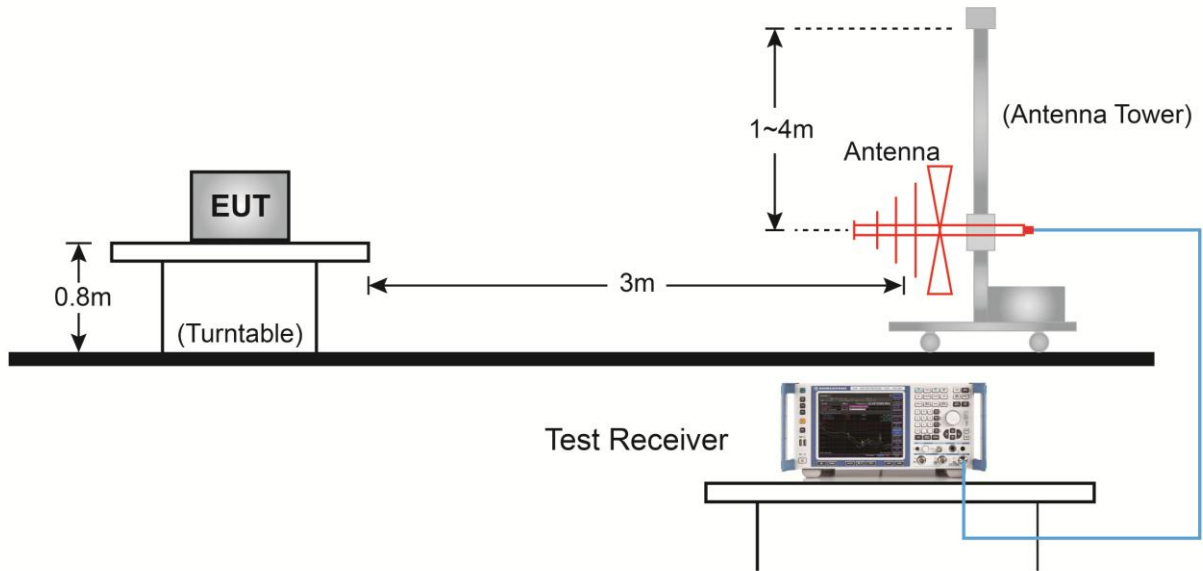

Above 1GHz Test Setup:

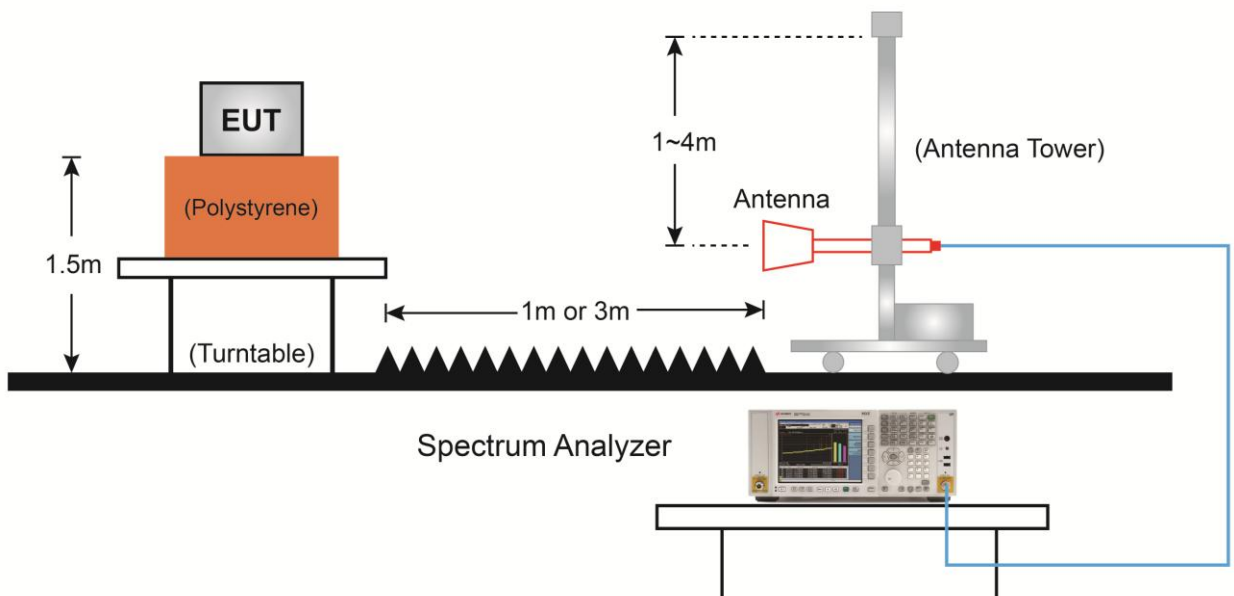

7.6.5. Test Result

Product	RANGEXTD USB Repeater	Temperature	25°C
Test Engineer	David Lv	Relative Humidity	52%
Test Site	AC1	Test Date	2020/01/14
Test Mode	802.11b - Ant 0 + 1	Test Channel	01
Note	1. Average measurement was not performed if peak level lower than average limit. 2. Other frequency was 20dB below limit line within 1-18GHz, there is not show in the report.		

Mark	Frequency (MHz)	Reading Level (dBμV)	Factor (dB)	Measure Level (dBμV/m)	Limit (dBμV/m)	Margin (dB)	Detector	Polarization
	4825.0	38.6	6.1	44.7	74.0	-29.3	Peak	Horizontal
*	6431.5	33.0	9.2	42.2	74.0	-31.8	Peak	Horizontal
	7596.0	34.3	11.8	46.1	74.0	-27.9	Peak	Horizontal
*	9959.0	31.8	16.8	48.6	74.0	-25.4	Peak	Horizontal
	4825.0	46.7	6.1	52.8	74.0	-21.2	Peak	Vertical
*	6576.0	34.1	9.7	43.8	74.0	-30.2	Peak	Vertical
	7596.0	35.8	11.8	47.6	74.0	-26.4	Peak	Vertical
*	10392.5	32.6	17.6	50.2	74.0	-23.8	Peak	Vertical

Note 1: "*" is not in restricted band, its limit is 20dBc of the fundamental emission level (91.5dBμV/m) or 15.209 which is higher.

Note 2: Measure Level (dBμV/m) = Reading Level (dBμV) + Factor (dB)

Factor (dB) = Cable Loss (dB) + Antenna Factor (dB/m) - Pre_Amplifier Gain (dB)

Product	RANGEXTD USB Repeater	Temperature	25°C
Test Engineer	David Lv	Relative Humidity	52%
Test Site	AC1	Test Date	2020/01/14
Test Mode	802.11b - Ant 0 + 1	Test Channel	06
Note	1. Average measurement was not performed if peak level lower than average limit. 2. Other frequency was 20dB below limit line within 1-18GHz, there is not show in the report.		

Mark	Frequency (MHz)	Reading Level (dBμV)	Factor (dB)	Measure Level (dBμV/m)	Limit (dBμV/m)	Margin (dB)	Detector	Polarization
	4876.0	38.3	5.9	44.2	74.0	-29.8	Peak	Horizontal
*	6057.5	33.9	7.8	41.7	74.0	-32.3	Peak	Horizontal
	7494.0	34.8	11.8	46.6	74.0	-27.4	Peak	Horizontal
*	9959.0	32.3	16.8	49.1	74.0	-24.9	Peak	Horizontal
	4876.0	43.7	5.9	49.6	74.0	-24.4	Peak	Vertical
*	5989.5	34.2	7.8	42.0	74.0	-32.0	Peak	Vertical
	7604.5	34.2	11.8	46.0	74.0	-28.0	Peak	Vertical
*	9840.0	32.5	16.9	49.4	74.0	-24.6	Peak	Vertical

Note 1: "*" is not in restricted band, its limit is 20dBc of the fundamental emission level (91.0dBμV/m) or 15.209 which is higher.

Note 2: Measure Level (dBμV/m) = Reading Level (dBμV) + Factor (dB)

Factor (dB) = Cable Loss (dB) + Antenna Factor (dB/m) - Pre_Amplifier Gain (dB)

Product	RANGEXTD USB Repeater	Temperature	25°C
Test Engineer	David Lv	Relative Humidity	52%
Test Site	AC1	Test Date	2020/01/14
Test Mode	802.11b - Ant 0 + 1	Test Channel	11
Note	1. Average measurement was not performed if peak level lower than average limit. 2. Other frequency was 20dB below limit line within 1-18GHz, there is not show in the report.		

Mark	Frequency (MHz)	Reading Level (dBμV)	Factor (dB)	Measure Level (dBμV/m)	Limit (dBμV/m)	Margin (dB)	Detector	Polarization
	4927.0	38.8	6.1	44.9	74.0	-29.1	Peak	Horizontal
*	6550.5	33.8	9.5	43.3	74.0	-30.7	Peak	Horizontal
	7375.0	34.2	11.9	46.1	74.0	-27.9	Peak	Horizontal
*	9950.5	32.4	16.9	49.3	74.0	-24.7	Peak	Horizontal
	4927.0	43.1	6.1	49.2	74.0	-24.8	Peak	Vertical
*	6533.5	33.4	9.5	42.9	74.0	-31.1	Peak	Vertical
	7596.0	35.0	11.8	46.8	74.0	-27.2	Peak	Vertical
*	10384.0	32.4	17.6	50.0	74.0	-24.0	Peak	Vertical

Note 1: "*" is not in restricted band, its limit is 20dBc of the fundamental emission level (89.6dBμV/m) or 15.209 which is higher.

Note 2: Measure Level (dBμV/m) = Reading Level (dBμV) + Factor (dB)

Factor (dB) = Cable Loss (dB) + Antenna Factor (dB/m) - Pre_Amplifier Gain (dB)

Product	RANGEXTD USB Repeater	Temperature	25°C
Test Engineer	David Lv	Relative Humidity	52%
Test Site	AC1	Test Date	2020/01/14
Test Mode	802.11g - Ant 0 + 1	Test Channel	01
Note	1. Average measurement was not performed if peak level lower than average limit. 2. Other frequency was 20dB below limit line within 1-18GHz, there is not show in the report.		

Mark	Frequency (MHz)	Reading Level (dBμV)	Factor (dB)	Measure Level (dBμV/m)	Limit (dBμV/m)	Margin (dB)	Detector	Polarization
	4825.0	39.2	6.1	45.3	74.0	-28.7	Peak	Horizontal
*	6516.5	33.2	9.6	42.8	78.7	-35.9	Peak	Horizontal
	7596.0	34.3	11.8	46.1	74.0	-27.9	Peak	Horizontal
*	9899.5	32.5	16.9	49.4	78.7	-29.3	Peak	Horizontal
	4825.0	50.0	6.1	56.1	74.0	-17.9	Peak	Vertical
	4825.3	35.9	6.1	42.0	54.0	-12.0	Average	Vertical
*	6533.5	33.6	9.5	43.1	78.7	-35.6	Peak	Vertical
	7494.0	34.6	11.8	46.4	74.0	-27.6	Peak	Vertical
*	10154.5	33.4	16.8	50.2	78.7	-28.5	Peak	Vertical

Note 1: "*" is not in restricted band, its limit is 20dBc of the fundamental emission level (98.7dBμV/m) or 15.209 which is higher.

Note 2: Measure Level (dBμV/m) = Reading Level (dBμV) + Factor (dB)

Factor (dB) = Cable Loss (dB) + Antenna Factor (dB/m) - Pre_Amplifier Gain (dB)

Product	RANGEXTD USB Repeater	Temperature	25°C
Test Engineer	David Lv	Relative Humidity	52%
Test Site	AC1	Test Date	2020/01/14
Test Mode	802.11g - Ant 0 + 1	Test Channel	06
Note	1. Average measurement was not performed if peak level lower than average limit. 2. Other frequency was 20dB below limit line within 1-18GHz, there is not show in the report.		

Mark	Frequency (MHz)	Reading Level (dBμV)	Factor (dB)	Measure Level (dBμV/m)	Limit (dBμV/m)	Margin (dB)	Detector	Polarization
	4876.0	41.0	5.9	46.9	74.0	-27.1	Peak	Horizontal
*	6516.5	34.0	9.6	43.6	77.9	-34.3	Peak	Horizontal
	9151.5	33.4	15.2	48.6	74.0	-25.4	Peak	Horizontal
*	10222.5	33.0	17.1	50.1	77.9	-27.8	Peak	Horizontal
	4876.0	47.2	5.9	53.1	74.0	-20.9	Peak	Vertical
*	6737.5	33.5	9.8	43.3	77.9	-34.6	Peak	Vertical
	8242.0	33.4	12.2	45.6	74.0	-28.4	Peak	Vertical
*	9925.0	32.1	16.8	48.9	77.9	-29.0	Peak	Vertical

Note 1: "*" is not in restricted band, its limit is 20dBc of the fundamental emission level (97.9dBμV/m) or 15.209 which is higher.

Note 2: Measure Level (dBμV/m) = Reading Level (dBμV) + Factor (dB)

Factor (dB) = Cable Loss (dB) + Antenna Factor (dB/m) - Pre_Amplifier Gain (dB)

Product	RANGEXTD USB Repeater	Temperature	25°C
Test Engineer	David Lv	Relative Humidity	52%
Test Site	AC1	Test Date	2020/01/14
Test Mode	802.11g - Ant 0 + 1	Test Channel	11
Note	1. Average measurement was not performed if peak level lower than average limit. 2. Other frequency was 20dB below limit line within 1-18GHz, there is not show in the report.		

Mark	Frequency (MHz)	Reading Level (dBμV)	Factor (dB)	Measure Level (dBμV/m)	Limit (dBμV/m)	Margin (dB)	Detector	Polarization
	4927.0	39.9	6.1	46.0	74.0	-28.0	Peak	Horizontal
*	6491.0	33.2	9.4	42.6	76.6	-34.0	Peak	Horizontal
	7596.0	34.2	11.8	46.0	74.0	-28.0	Peak	Horizontal
*	9950.5	32.3	16.9	49.2	76.6	-27.4	Peak	Horizontal
	4927.0	46.9	6.1	53.0	74.0	-21.0	Peak	Vertical
*	6440.0	33.4	9.2	42.6	76.6	-34.0	Peak	Vertical
	7706.5	34.5	11.6	46.1	74.0	-27.9	Peak	Vertical
*	9908.0	32.2	16.9	49.1	76.6	-27.5	Peak	Vertical

Note 1: "*" is not in restricted band, its limit is 20dBc of the fundamental emission level (96.6dBμV/m) or 15.209 which is higher.

Note 2: Measure Level (dBμV/m) = Reading Level (dBμV) + Factor (dB)

Factor (dB) = Cable Loss (dB) + Antenna Factor (dB/m) - Pre_Amplifier Gain (dB)

Product	RANGEXTD USB Repeater	Temperature	25°C
Test Engineer	David Lv	Relative Humidity	52%
Test Site	AC1	Test Date	2020/01/14
Test Mode	802.11n-HT20 - Ant 0 + 1	Test Channel	01
Note	1. Average measurement was not performed if peak level lower than average limit. 2. Other frequency was 20dB below limit line within 1-18GHz, there is not show in the report.		

Mark	Frequency (MHz)	Reading Level (dBμV)	Factor (dB)	Measure Level (dBμV/m)	Limit (dBμV/m)	Margin (dB)	Detector	Polarization
	4816.5	37.7	5.9	43.6	74.0	-30.4	Peak	Horizontal
*	6074.5	34.0	8.0	42.0	77.8	-35.8	Peak	Horizontal
	7596.0	33.9	11.8	45.7	74.0	-28.3	Peak	Horizontal
*	9942.0	32.7	16.9	49.6	77.8	-28.2	Peak	Horizontal
	4825.0	49.7	6.1	55.8	74.0	-18.2	Peak	Vertical
	4827.1	36.5	6.0	42.5	54.0	-11.5	Average	Vertical
*	5972.5	34.2	7.7	41.9	77.8	-35.9	Peak	Vertical
	7596.0	34.1	11.8	45.9	74.0	-28.1	Peak	Vertical
*	10375.5	33.7	17.5	51.2	77.8	-26.6	Peak	Vertical

Note 1: "*" is not in restricted band, its limit is 20dBc of the fundamental emission level (97.8dBμV/m) or 15.209 which is higher.

Note 2: Measure Level (dBμV/m) = Reading Level (dBμV) + Factor (dB)

Factor (dB) = Cable Loss (dB) + Antenna Factor (dB/m) - Pre_Amplifier Gain (dB)

Product	RANGEXTD USB Repeater	Temperature	25°C
Test Engineer	David Lv	Relative Humidity	52%
Test Site	AC1	Test Date	2020/01/14
Test Mode	802.11n-HT20 - Ant 0 + 1	Test Channel	06
Note	1. Average measurement was not performed if peak level lower than average limit. 2. Other frequency was 20dB below limit line within 1-18GHz, there is not show in the report.		

Mark	Frequency (MHz)	Reading Level (dBμV)	Factor (dB)	Measure Level (dBμV/m)	Limit (dBμV/m)	Margin (dB)	Detector	Polarization
	4867.5	38.2	5.9	44.1	74.0	-29.9	Peak	Horizontal
*	6516.5	33.9	9.6	43.5	77.5	-34.0	Peak	Horizontal
	7596.0	34.5	11.8	46.3	74.0	-27.7	Peak	Horizontal
*	9959.0	32.8	16.8	49.6	77.5	-27.9	Peak	Horizontal
	4872.1	34.8	5.9	40.7	54.0	-13.3	Average	Vertical
	4876.0	48.9	5.9	54.8	74.0	-19.2	Peak	Vertical
*	5904.5	34.8	7.8	42.6	77.5	-34.9	Peak	Vertical
	7587.5	33.4	11.7	45.1	74.0	-28.9	Peak	Vertical
*	9967.5	33.2	16.7	49.9	77.5	-27.6	Peak	Vertical

Note 1: "*" is not in restricted band, its limit is 20dBc of the fundamental emission level (97.5dBμV/m) or 15.209 which is higher.

Note 2: Measure Level (dBμV/m) = Reading Level (dBμV) + Factor (dB)

Factor (dB) = Cable Loss (dB) + Antenna Factor (dB/m) - Pre_Amplifier Gain (dB)

Product	RANGEXTD USB Repeater	Temperature	25°C
Test Engineer	David Lv	Relative Humidity	52%
Test Site	AC1	Test Date	2020/01/14
Test Mode	802.11n-HT20 - Ant 0 + 1	Test Channel	11
Note	1. Average measurement was not performed if peak level lower than average limit. 2. Other frequency was 20dB below limit line within 1-18GHz, there is not show in the report.		

Mark	Frequency (MHz)	Reading Level (dBμV)	Factor (dB)	Measure Level (dBμV/m)	Limit (dBμV/m)	Margin (dB)	Detector	Polarization
	4918.5	39.5	6.1	45.6	74.0	-28.4	Peak	Horizontal
*	6193.5	33.2	8.2	41.4	75.8	-34.4	Peak	Horizontal
	7494.0	33.4	11.8	45.2	74.0	-28.8	Peak	Horizontal
*	9840.0	32.4	16.9	49.3	75.8	-26.5	Peak	Horizontal
	4927.0	45.9	6.1	52.0	74.0	-22.0	Peak	Vertical
*	6287.0	33.7	8.4	42.1	75.8	-33.7	Peak	Vertical
	7562.0	33.8	11.7	45.5	74.0	-28.5	Peak	Vertical
*	9891.0	31.7	16.9	48.6	75.8	-27.2	Peak	Vertical

Note 1: "*" is not in restricted band, its limit is 20dBc of the fundamental emission level (95.8dBμV/m) or 15.209 which is higher.

Note 2: Measure Level (dBμV/m) = Reading Level (dBμV) + Factor (dB)

Factor (dB) = Cable Loss (dB) + Antenna Factor (dB/m) - Pre_Amplifier Gain (dB)

Product	RANGEXTD USB Repeater	Temperature	25°C
Test Engineer	David Lv	Relative Humidity	52%
Test Site	AC1	Test Date	2020/01/14
Test Mode	802.11n-HT40 - Ant 0 + 1	Test Channel	03
Note	1. Average measurement was not performed if peak level lower than average limit. 2. Other frequency was 20dB below limit line within 1-18GHz, there is not show in the report.		

Mark	Frequency (MHz)	Reading Level (dBμV)	Factor (dB)	Measure Level (dBμV/m)	Limit (dBμV/m)	Margin (dB)	Detector	Polarization
	4842.0	35.7	5.9	41.6	74.0	-32.4	Peak	Horizontal
*	6559.0	33.8	9.6	43.4	74.0	-30.6	Peak	Horizontal
	8165.5	33.4	12.4	45.8	74.0	-28.2	Peak	Horizontal
*	10137.5	33.0	16.8	49.8	74.0	-24.2	Peak	Horizontal
	4842.0	43.4	5.9	49.3	74.0	-24.7	Peak	Vertical
*	5904.5	34.1	7.8	41.9	74.0	-32.1	Peak	Vertical
	7587.5	33.8	11.7	45.5	74.0	-28.5	Peak	Vertical
*	9882.5	32.6	16.8	49.4	74.0	-24.6	Peak	Vertical

Note 1: "*" is not in restricted band, its limit is 20dBc of the fundamental emission level (93.0dBμV/m) or 15.209 which is higher.

Note 2: Measure Level (dBμV/m) = Reading Level (dBμV) + Factor (dB)

Factor (dB) = Cable Loss (dB) + Antenna Factor (dB/m) - Pre_Amplifier Gain (dB)

Product	RANGEXTD USB Repeater	Temperature	25°C
Test Engineer	David Lv	Relative Humidity	52%
Test Site	AC1	Test Date	2020/01/14
Test Mode	802.11n-HT40 - Ant 0 + 1	Test Channel	06
Note	1. Average measurement was not performed if peak level lower than average limit. 2. Other frequency was 20dB below limit line within 1-18GHz, there is not show in the report.		

Mark	Frequency (MHz)	Reading Level (dBμV)	Factor (dB)	Measure Level (dBμV/m)	Limit (dBμV/m)	Margin (dB)	Detector	Polarization
	4876.0	34.8	5.9	40.7	74.0	-33.3	Peak	Horizontal
*	6117.0	33.6	8.0	41.6	74.0	-32.4	Peak	Horizontal
	7596.0	35.0	11.8	46.8	74.0	-27.2	Peak	Horizontal
*	10205.5	33.1	17.1	50.2	74.0	-23.8	Peak	Horizontal
	4876.0	43.7	5.9	49.6	74.0	-24.4	Peak	Vertical
*	6508.0	33.8	9.7	43.5	74.0	-30.5	Peak	Vertical
	8174.0	33.8	12.4	46.2	74.0	-27.8	Peak	Vertical
*	9908.0	34.1	16.9	51.0	74.0	-23.0	Peak	Vertical

Note 1: "*" is not in restricted band, its limit is 20dBc of the fundamental emission level (92.5dBμV/m) or 15.209 which is higher.

Note 2: Measure Level (dBμV/m) = Reading Level (dBμV) + Factor (dB)

Factor (dB) = Cable Loss (dB) + Antenna Factor (dB/m) - Pre_Amplifier Gain (dB)

Product	RANGEXTD USB Repeater	Temperature	25°C
Test Engineer	David Lv	Relative Humidity	52%
Test Site	AC1	Test Date	2020/01/14
Test Mode	802.11n-HT40 - Ant 0 + 1	Test Channel	09
Note	1. Average measurement was not performed if peak level lower than average limit. 2. Other frequency was 20dB below limit line within 1-18GHz, there is not show in the report.		

Mark	Frequency (MHz)	Reading Level (dBμV)	Factor (dB)	Measure Level (dBμV/m)	Limit (dBμV/m)	Margin (dB)	Detector	Polarization
	4910.0	35.7	6.2	41.9	74.0	-32.1	Peak	Horizontal
*	6516.5	33.8	9.6	43.4	74.0	-30.6	Peak	Horizontal
	8191.0	34.0	12.4	46.4	74.0	-27.6	Peak	Horizontal
*	10154.5	33.0	16.8	49.8	74.0	-24.2	Peak	Horizontal
	4901.5	43.4	6.1	49.5	74.0	-24.5	Peak	Vertical
*	6516.5	33.8	9.6	43.4	74.0	-30.6	Peak	Vertical
	8191.0	34.0	12.4	46.4	74.0	-27.6	Peak	Vertical
*	9993.0	33.5	16.7	50.2	74.0	-23.8	Peak	Vertical

Note 1: "*" is not in restricted band, its limit is 20dBc of the fundamental emission level (93.4dBμV/m) or 15.209 which is higher.

Note 2: Measure Level (dBμV/m) = Reading Level (dBμV) + Factor (dB)

Factor (dB) = Cable Loss (dB) + Antenna Factor (dB/m) - Pre_Amplifier Gain (dB)

The Worst Case of Radiated Emission below 1GHz:

Site: AC1	Time: 2020/01/13 - 14:31
Limit: FCC_Part15.209_RE(3m)	Engineer: Dillon Diao
Probe: AC1_VULB 9168 _20-2000MHz	Polarity: Horizontal
EUT: RANGEXTD USB Repeater	Power: AC 120V/60Hz
Worst Case Mode: There is the worst case within frequency range 30MHz~1GHz.	

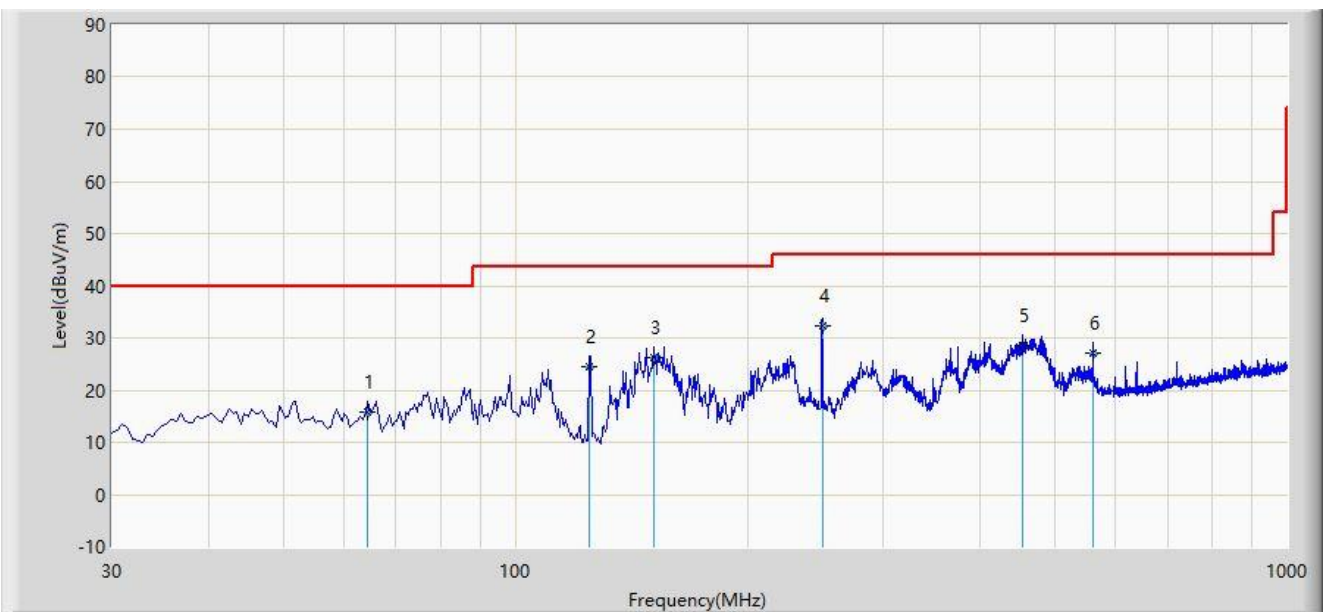

No	Flag	Mark	Frequency (MHz)	Measure Level (dBuV/m)	Reading Level (dBuV)	Margin (dB)	Limit (dBuV/m)	Factor (dB)	Type
1			64.435	15.810	3.229	-24.190	40.000	12.581	QP
2			124.575	24.504	11.028	-18.996	43.500	13.476	QP
3			151.250	26.250	11.005	-17.250	43.500	15.245	QP
4		*	250.050	32.450	19.481	-13.550	46.000	12.969	QP
5			454.860	28.537	10.633	-17.463	46.000	17.904	QP
6			560.105	27.227	7.503	-18.773	46.000	19.724	QP

Note 1: Measure Level (dB μ V/m) = Reading Level (dB μ V) + Factor (dB)

Factor (dB) = Cable Loss (dB) + Antenna Factor (dB/m)

Note 2: The test trace is same as the ambient noise and the amplitude of the emissions are attenuated more than 20dB below the permissible (the test frequency range: 9kHz ~ 30MHz, 18GHz ~ 25GHz), therefore no data appear in the report.

Site: AC1	Time: 2020/01/13 - 14:45
Limit: FCC_Part15.209_RE(3m)	Engineer: Dillon Diao
Probe: AC1_VULB 9168 _20-2000MHz	Polarity: Vertical
EUT: RANGEXTD USB Repeater	Power: AC 120V/60Hz
Worst Case Mode: There is the worst case within frequency range 30MHz~1GHz.	

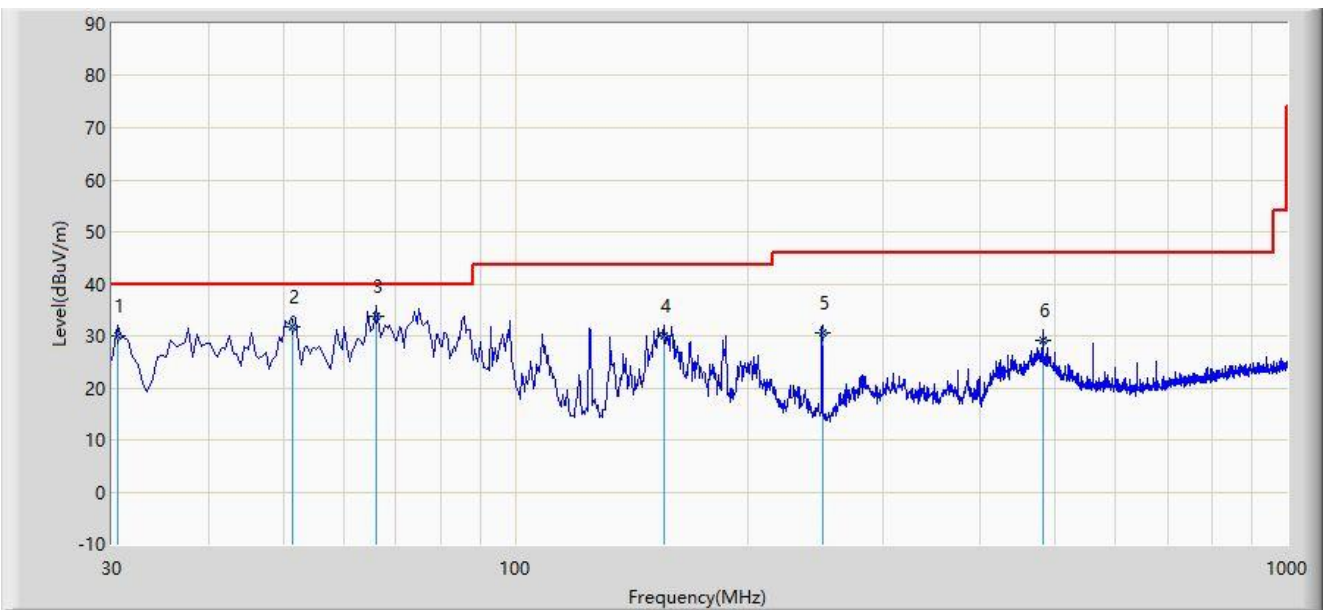

No	Flag	Mark	Frequency (MHz)	Measure Level (dBuV/m)	Reading Level (dBuV)	Margin (dB)	Limit (dBuV/m)	Factor (dB)	Type
1			30.485	30.125	16.439	-9.875	40.000	13.685	QP
2			51.340	31.683	17.642	-8.317	40.000	14.041	QP
3		*	65.890	33.792	21.478	-6.208	40.000	12.313	QP
4			155.615	30.026	14.776	-13.474	43.500	15.250	QP
5			250.024	30.630	17.661	-15.370	46.000	12.969	QP
6			483.475	29.251	10.988	-16.749	46.000	18.263	QP

Note 1: Measure Level (dBuV/m) = Reading Level (dBuV) + Factor (dB)

Factor (dB) = Cable Loss (dB) + Antenna Factor (dB/m)

Note 2: The test trace is same as the ambient noise and the amplitude of the emissions are attenuated more than 20dB below the permissible (the test frequency range: 9kHz ~ 30MHz, 18GHz ~ 25GHz), therefore no data appear in the report.

7.7. Radiated Restricted Band Edge Measurement

7.7.1. Test Limit

For 15.205 requirement:

Radiated emissions which fall in the restricted bands, as defined in Section 15.205(a) of FCC part 15, must also comply with the radiated emission limits specified in Section 15.209(a).

Frequency (MHz)	Frequency (MHz)	Frequency (MHz)	Frequency (GHz)
0.090 - 0.110	16.42 - 16.423	399.9 - 410	4.5 - 5.15
¹ 0.495 - 0.505	16.69475 - 16.69525	608 - 614	5.35 - 5.46
2.1735 - 2.1905	16.80425 - 16.80475	960 - 1240	7.25 - 7.75
4.125 - 4.128	25.5 - 25.67	1300 - 1427	8.025 - 8.5
4.17725 - 4.17775	37.5 - 38.25	1435 - 1626.5	9.0 - 9.2
4.20725 - 4.20775	73 - 74.6	1645.5 - 1646.5	9.3 - 9.5
6.215 - 6.218	74.8 - 75.2	1660 - 1710	10.6 - 12.7
6.26775 - 6.26825	108 - 121.94	1718.8 - 1722.2	13.25 - 13.4
6.31175 - 6.31225	123 - 138	2200 - 2300	14.47 - 14.5
8.291 - 8.294	149.9 - 150.05	2310 - 2390	15.35 - 16.2
8.362 - 8.366	156.52475 - 156.52525	2483.5 - 2500	17.7 - 21.4
8.37625 - 8.38675	156.7 - 156.9	2690 - 2900	22.01 - 23.12
8.41425 - 8.41475	162.0125 - 167.17	3260 - 3267	23.6 - 24.0
12.29 - 12.293	167.72 - 173.2	3332 - 3339	31.2 - 31.8
12.51975 - 12.52025	240 - 285	3345.8 - 3358	36.43 - 36.5
12.57675 - 12.57725	322 - 335.4	3600 - 4400	(²)
13.36 - 13.41	--	--	--

All out of band emissions appearing in a restricted band as specified in Section 15.205 of the Title 47CFR must not exceed the limits shown in Table per Section 15.209.

FCC Part 15 Subpart C Paragraph 15.209 Limits		
Frequency [MHz]	Field Strength [uV/m]	Measured Distance [Meters]
0.009 - 0.490	2400/F (kHz)	300
0.490 - 1.705	24000/F (kHz)	30
1.705 - 30	30	30
30 - 88	100	3
88 - 216	150	3
216 - 960	200	3
Above 960	500	3

7.7.2. Test Procedure Used

ANSI C63.10 Section 6.3 (General Requirements)

ANSI C63.10 Section 6.6 (Standard test method above 1GHz)

7.7.3. Test Setting

Peak Field Strength Measurements

1. Analyzer center frequency was set to the frequency of the radiated spurious emission of interest
2. RBW = 1MHz
3. VBW = 3MHz
4. Detector = peak
5. Sweep time = auto couple
6. Trace mode = max hold
7. Trace was allowed to stabilize

Average Measurements above 1GHz (Method VB)

1. Analyzer center frequency was set to the frequency of the radiated spurious emission of interest
2. RBW = 1MHz
3. VBW; If the EUT is configured to transmit with duty cycle $\geq 98\%$, set VBW = 10 Hz.

If the EUT duty cycle is $< 98\%$, set $VBW \geq 1/T$. T is the minimum transmission duration.

4. Detector = Peak
5. Sweep time = auto
6. Trace mode = max hold
7. Trace was allowed to stabilize

7.7.4. Test Setup

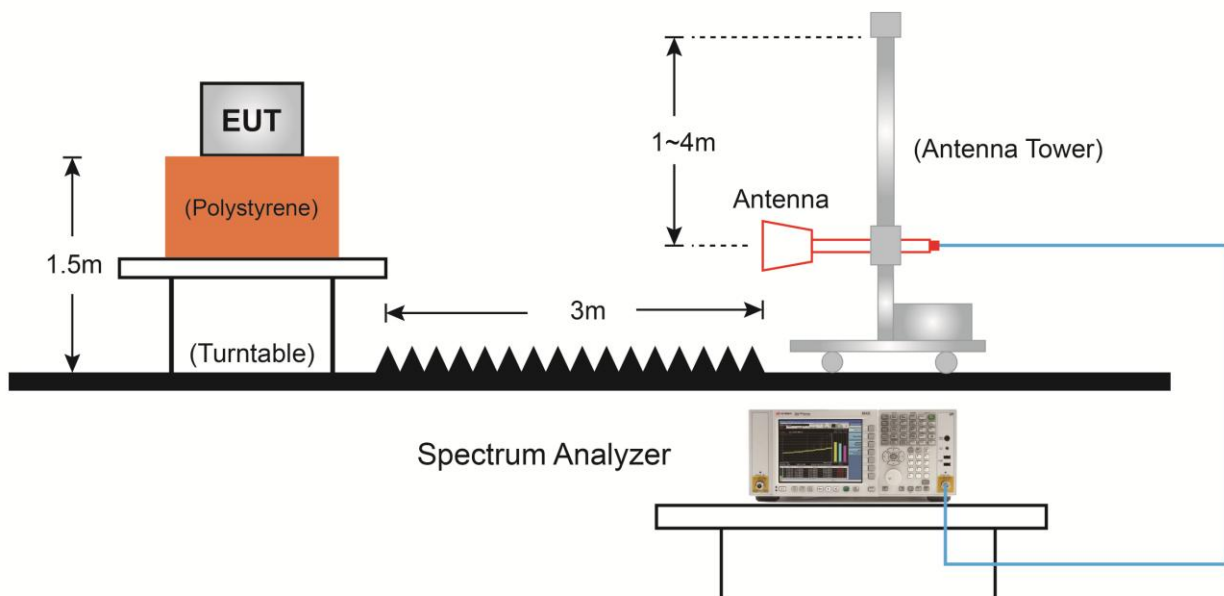

7.7.5. Test Result

Site: AC1	Time: 2020/01/17 - 09:56
Limit: FCC_Part15.209_RE(3m)	Engineer: Larry Yan
Probe: AC1_BBHA9120D_1-18GHz	Polarity: Horizontal
EUT: RANGEXTD USB Repeater	Power: AC 120V/60Hz
Test Mode: Transmit by 802.11b at channel 2412MHz	

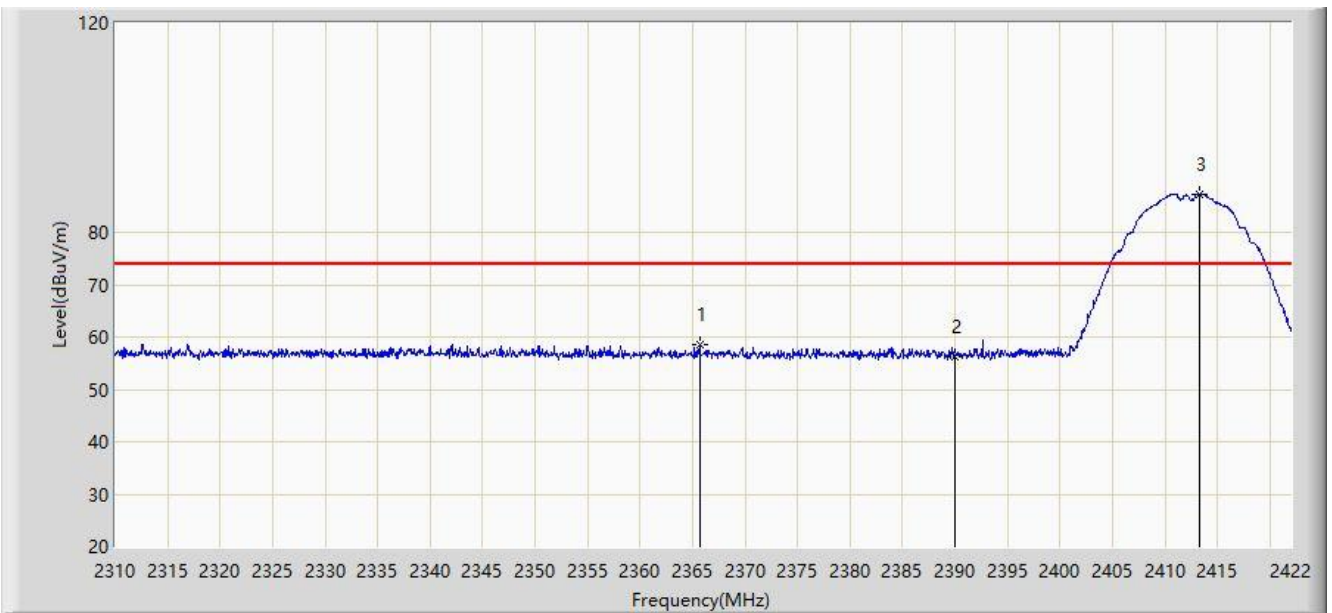

No	Flag	Mark	Frequency (MHz)	Measure Level (dBuV/m)	Reading Level (dBuV)	Margin (dB)	Limit (dBuV/m)	Factor (dB)	Type
1			2365.664	58.408	26.301	-15.592	74.000	32.107	PK
2			2390.000	56.323	24.251	-17.677	74.000	32.072	PK
3		*	2413.320	87.369	55.282	N/A	N/A	32.087	PK

Note: Measure Level (dB μ V/m) = Reading Level (dB μ V) + Factor (dB)

Factor (dB) = Cable Loss (dB) + Antenna Factor (dB/m)

Site: AC1	Time: 2020/01/17 - 10:04
Limit: FCC_Part15.209_RE(3m)	Engineer: Larry Yan
Probe: AC1_BBHA9120D_1-18GHz	Polarity: Horizontal
EUT: RANGEXTD USB Repeater	Power: AC 120V/60Hz
Test Mode: Transmit by 802.11b at channel 2412MHz	

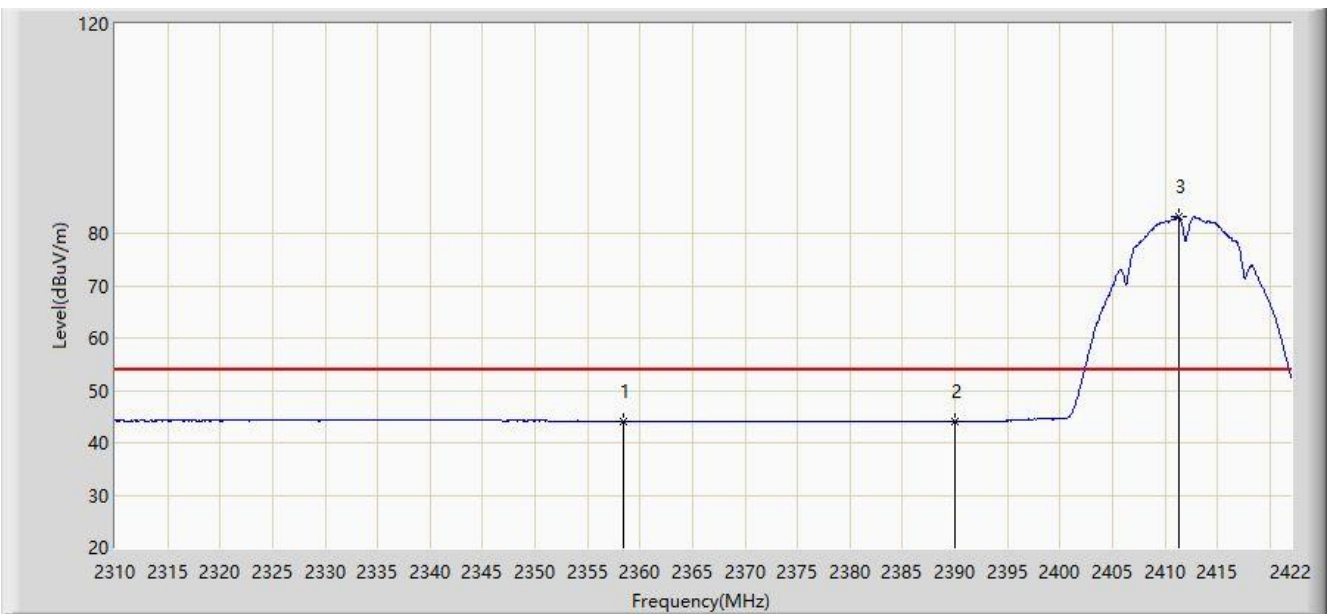

No	Flag	Mark	Frequency (MHz)	Measure Level (dBuV/m)	Reading Level (dBuV)	Margin (dB)	Limit (dBuV/m)	Factor (dB)	Type
1			2358.440	44.167	12.044	-9.833	54.000	32.123	AV
2			2390.000	44.088	12.016	-9.912	54.000	32.072	AV
3		*	2411.304	83.322	51.240	N/A	N/A	32.082	AV

Note: Measure Level (dB μ V/m) = Reading Level (dB μ V) + Factor (dB)

Factor (dB) = Cable Loss (dB) + Antenna Factor (dB/m)

Site: AC1	Time: 2020/01/17 - 10:06
Limit: FCC_Part15.209_RE(3m)	Engineer: Larry Yan
Probe: AC1_BBHA9120D_1-18GHz	Polarity: Vertical
EUT: RANGEXTD USB Repeater	Power: AC 120V/60Hz
Test Mode: Transmit by 802.11b at channel 2412MHz	

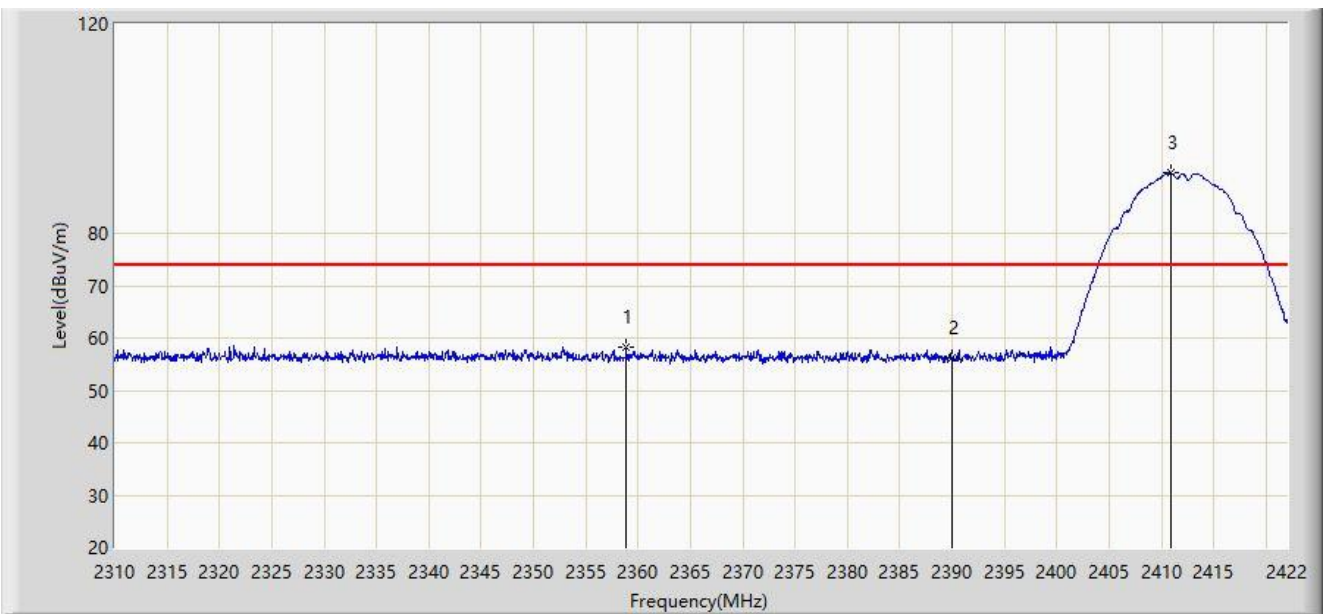

No	Flag	Mark	Frequency (MHz)	Measure Level (dBuV/m)	Reading Level (dBuV)	Margin (dB)	Limit (dBuV/m)	Factor (dB)	Type
1			2358.832	58.324	26.201	-15.676	74.000	32.123	PK
2			2390.000	56.114	24.042	-17.886	74.000	32.072	PK
3		*	2410.912	91.503	59.422	N/A	N/A	32.081	PK

Note: Measure Level (dB μ V/m) = Reading Level (dB μ V) + Factor (dB)

Factor (dB) = Cable Loss (dB) + Antenna Factor (dB/m)

Site: AC1	Time: 2020/01/17 - 10:08
Limit: FCC_Part15.209_RE(3m)	Engineer: Larry Yan
Probe: AC1_BBHA9120D_1-18GHz	Polarity: Vertical
EUT: RANGEXTD USB Repeater	Power: AC 120V/60Hz
Test Mode: Transmit by 802.11b at channel 2412MHz	

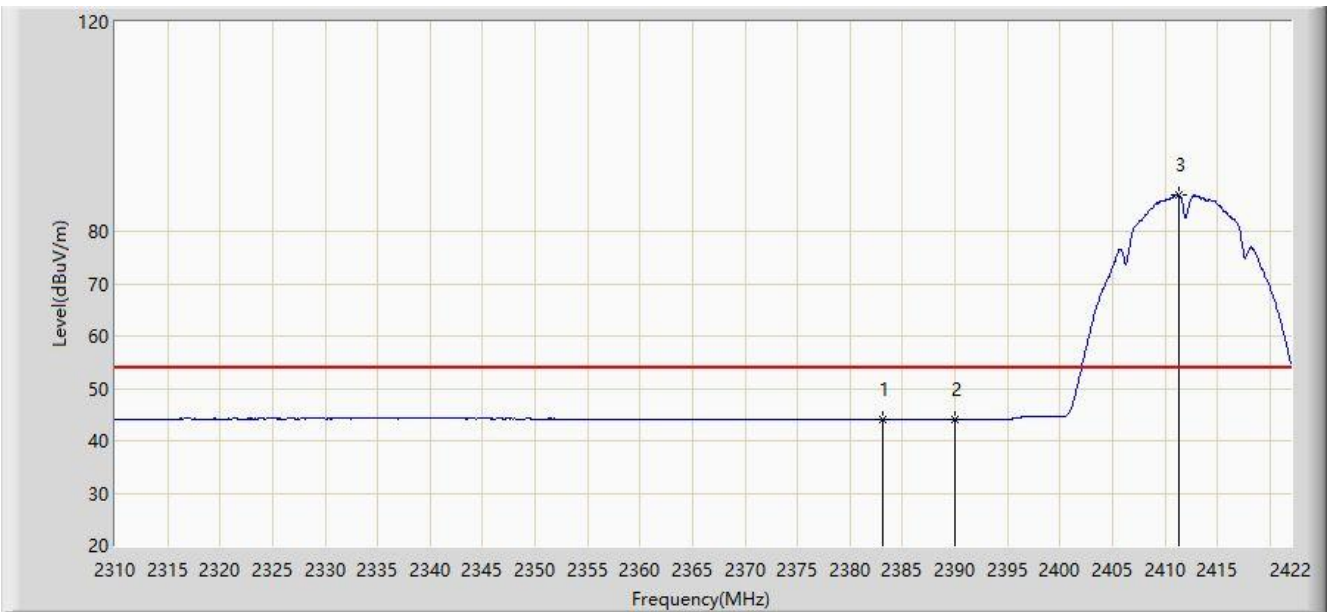

No	Flag	Mark	Frequency (MHz)	Measure Level (dBuV/m)	Reading Level (dBuV)	Margin (dB)	Limit (dBuV/m)	Factor (dB)	Type
1			2383.136	44.108	12.034	-9.892	54.000	32.074	AV
2			2390.000	44.080	12.008	-9.920	54.000	32.072	AV
3		*	2411.304	86.879	54.797	N/A	N/A	32.082	AV

Note: Measure Level (dB μ V/m) = Reading Level (dB μ V) + Factor (dB)

Factor (dB) = Cable Loss (dB) + Antenna Factor (dB/m)

Site: AC1	Time: 2020/01/17 - 10:11
Limit: FCC_Part15.209_RE(3m)	Engineer: Larry Yan
Probe: AC1_BBHA9120D_1-18GHz	Polarity: Horizontal
EUT: RANGEXTD USB Repeater	Power: AC 120V/60Hz
Test Mode: Transmit by 802.11b at channel 2462MHz	

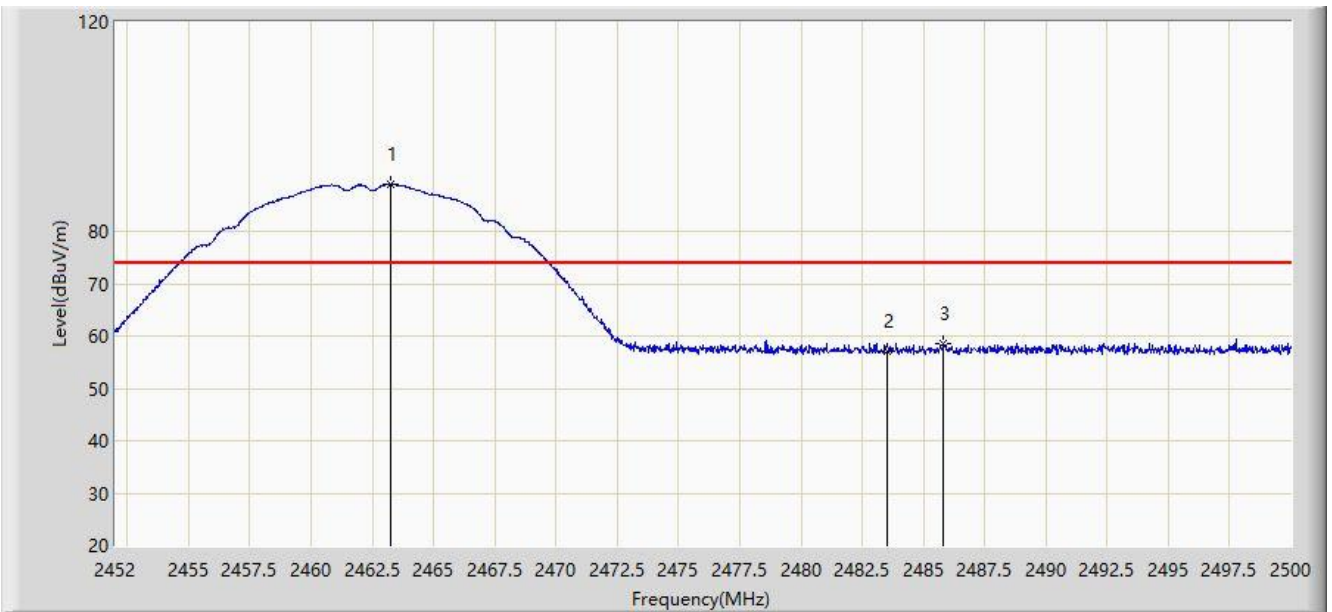

No	Flag	Mark	Frequency (MHz)	Measure Level (dBuV/m)	Reading Level (dBuV)	Margin (dB)	Limit (dBuV/m)	Factor (dB)	Type
1		*	2463.275	88.978	56.900	N/A	N/A	32.078	PK
2			2483.500	56.967	24.930	-17.033	74.000	32.037	PK
3			2485.800	58.682	26.649	-15.318	74.000	32.032	PK

Note: Measure Level (dB μ V/m) = Reading Level (dB μ V) + Factor (dB)

Factor (dB) = Cable Loss (dB) + Antenna Factor (dB/m)

Site: AC1	Time: 2020/01/17 - 10:18
Limit: FCC_Part15.209_RE(3m)	Engineer: Larry Yan
Probe: AC1_BBHA9120D_1-18GHz_Gain	Polarity: Horizontal
EUT: RANGEXTD USB Repeater	Power: AC 120V/60Hz
Test Mode: Transmit by 802.11b at channel 2462MHz	

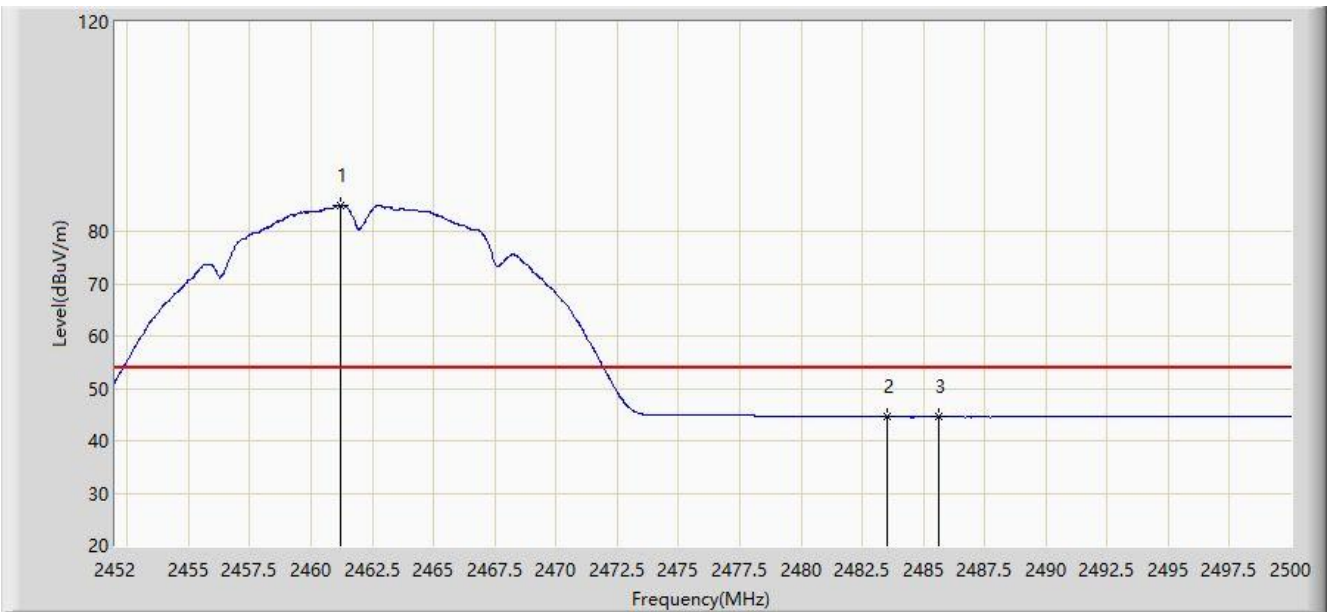

No	Flag	Mark	Frequency (MHz)	Measure Level (dBuV/m)	Reading Level (dBuV)	Margin (dB)	Limit (dBuV/m)	Factor (dB)	Type
1		*	2461.200	85.068	69.898	N/A	N/A	15.171	AV
2			2483.500	44.503	29.200	-9.497	54.000	15.302	AV
3			2485.625	44.531	29.219	-9.469	54.000	15.312	AV

Note: Measure Level (dBμV/m) = Reading Level (dBμV) + Factor (dB)

Factor (dB) = Cable Loss (dB) + Antenna Factor (dB/m)

Site: AC1	Time: 2020/01/17 - 10:20
Limit: FCC_Part15.209_RE(3m)	Engineer: Larry Yan
Probe: AC1_BBHA9120D_1-18GHz	Polarity: Vertical
EUT: RANGEXTD USB Repeater	Power: AC 120V/60Hz
Test Mode: Transmit by 802.11b at channel 2462MHz	

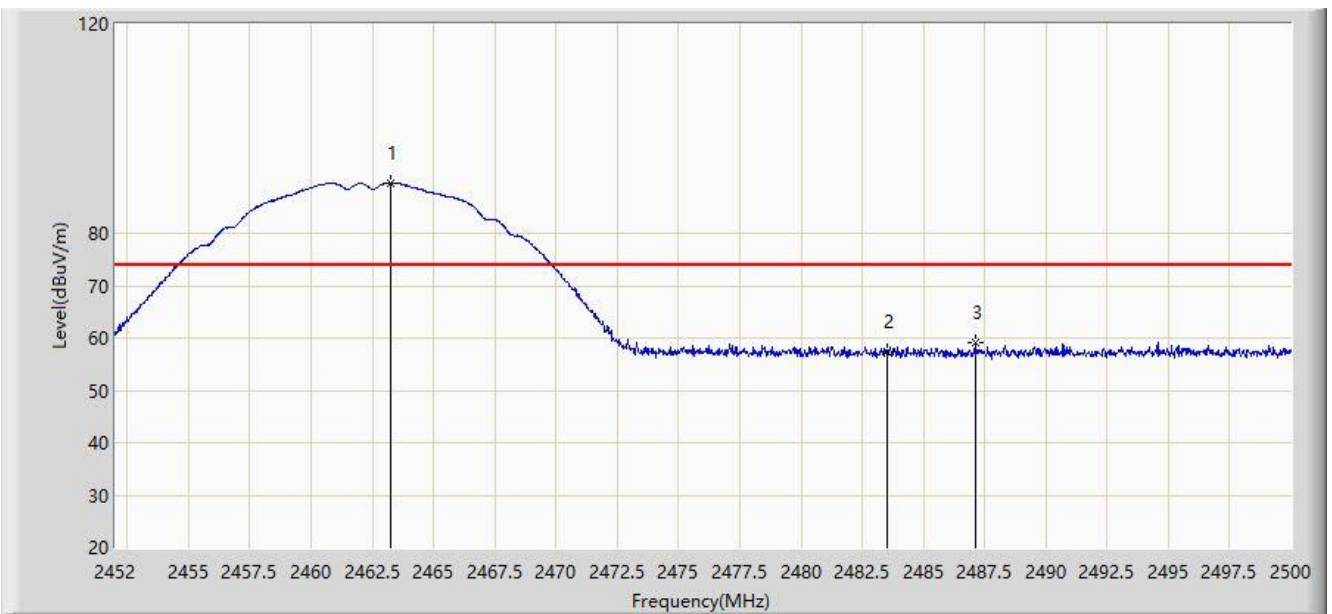

No	Flag	Mark	Frequency (MHz)	Measure Level (dBuV/m)	Reading Level (dBuV)	Margin (dB)	Limit (dBuV/m)	Factor (dB)	Type
1		*	2463.275	89.636	57.558	N/A	N/A	32.078	PK
2			2483.500	57.441	25.404	-16.559	74.000	32.037	PK
3			2487.125	59.022	26.992	-14.978	74.000	32.031	PK

Note: Measure Level (dB μ V/m) = Reading Level (dB μ V) + Factor (dB)

Factor (dB) = Cable Loss (dB) + Antenna Factor (dB/m)

Site: AC1	Time: 2020/01/17 - 10:25
Limit: FCC_Part15.209_RE(3m)	Engineer: Larry Yan
Probe: AC1_BBHA9120D_1-18GHz	Polarity: Vertical
EUT: RANGEXTD USB Repeater	Power: AC 120V/60Hz
Test Mode: Transmit by 802.11b at channel 2462MHz	



No	Flag	Mark	Frequency (MHz)	Measure Level (dBuV/m)	Reading Level (dBuV)	Margin (dB)	Limit (dBuV/m)	Factor (dB)	Type
1		*	2461.250	85.683	53.603	N/A	N/A	32.081	AV
2			2483.500	44.492	12.455	-9.508	54.000	32.037	AV
3			2492.800	44.560	12.541	-9.440	54.000	32.020	AV

Note: Measure Level (dBμV/m) = Reading Level (dBμV) + Factor (dB)

Factor (dB) = Cable Loss (dB) + Antenna Factor (dB/m)

Site: AC1	Time: 2020/01/17 - 10:29
Limit: FCC_Part15.209_RE(3m)	Engineer: Larry Yan
Probe: AC1_BBHA9120D_1-18GHz	Polarity: Horizontal
EUT: RANGEXTD USB Repeater	Power: AC 120V/60Hz
Test Mode: Transmit by 802.11g at channel 2412MHz	

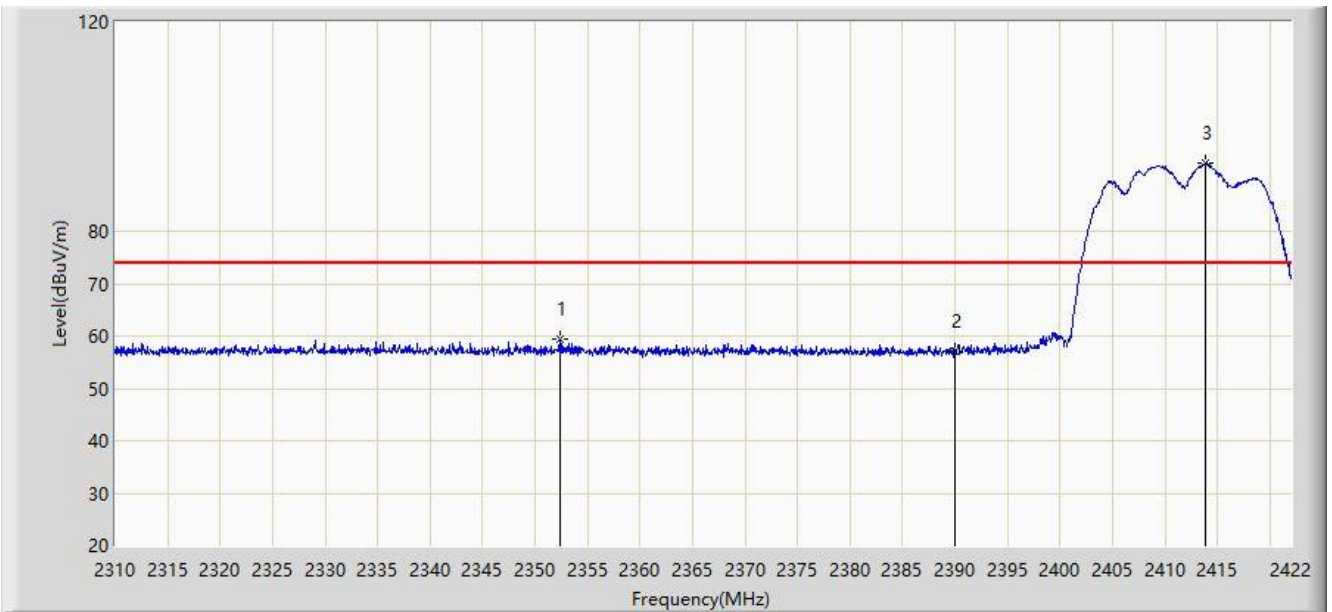

No	Flag	Mark	Frequency (MHz)	Measure Level (dBuV/m)	Reading Level (dBuV)	Margin (dB)	Limit (dBuV/m)	Factor (dB)	Type
1			2352.336	59.366	27.238	-14.634	74.000	32.128	PK
2			2390.000	56.999	24.927	-17.001	74.000	32.072	PK
3		*	2413.880	92.980	60.892	N/A	N/A	32.088	PK

Note: Measure Level (dBμV/m) = Reading Level (dBμV) + Factor (dB)

Factor (dB) = Cable Loss (dB) + Antenna Factor (dB/m)

Site: AC1	Time: 2020/01/17 - 10:36
Limit: FCC_Part15.209_RE(3m)	Engineer: Larry Yan
Probe: AC1_BBHA9120D_1-18GHz	Polarity: Horizontal
EUT: RANGEXTD USB Repeater	Power: AC 120V/60Hz
Test Mode: Transmit by 802.11g at channel 2412MHz	

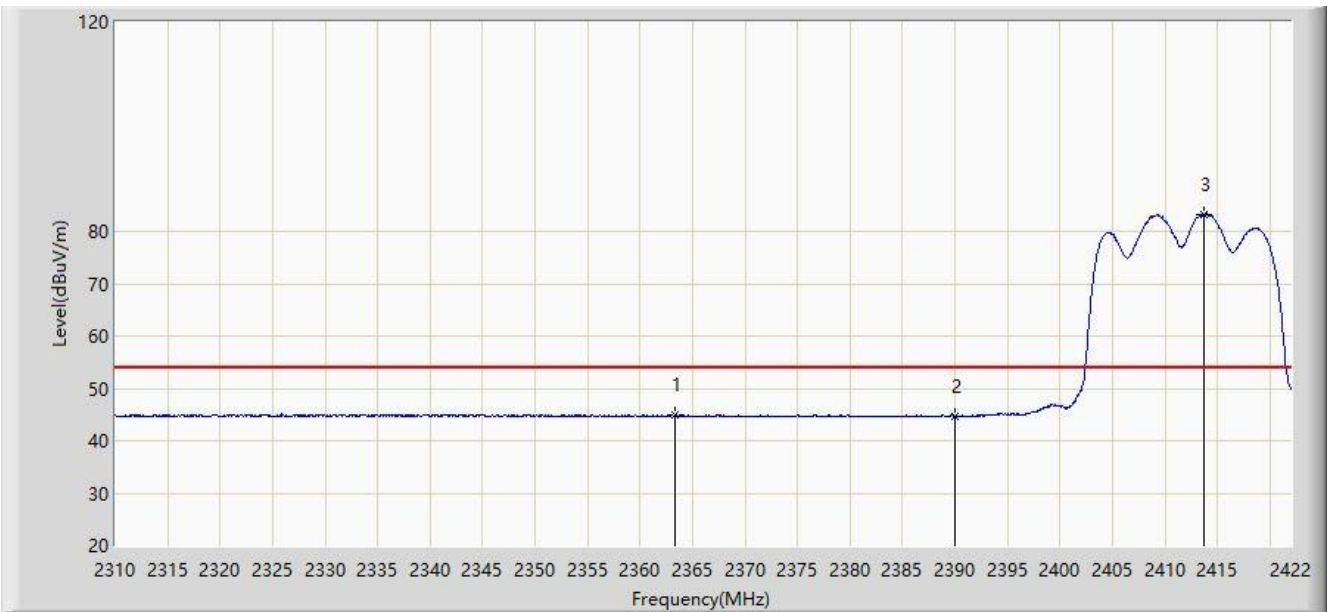

No	Flag	Mark	Frequency (MHz)	Measure Level (dBuV/m)	Reading Level (dBuV)	Margin (dB)	Limit (dBuV/m)	Factor (dB)	Type
1			2363.368	44.945	12.832	-9.055	54.000	32.113	AV
2			2390.000	44.701	12.629	-9.299	54.000	32.072	AV
3		*	2413.768	83.298	51.210	N/A	N/A	32.089	AV

Note: Measure Level (dB μ V/m) = Reading Level (dB μ V) + Factor (dB)

Factor (dB) = Cable Loss (dB) + Antenna Factor (dB/m)

Site: AC1	Time: 2020/01/17 - 10:37
Limit: FCC_Part15.209_RE(3m)	Engineer: Larry Yan
Probe: AC1_BBHA9120D_1-18GHz	Polarity: Vertical
EUT: RANGEXTD USB Repeater	Power: AC 120V/60Hz
Test Mode: Transmit by 802.11g at channel 2412MHz	

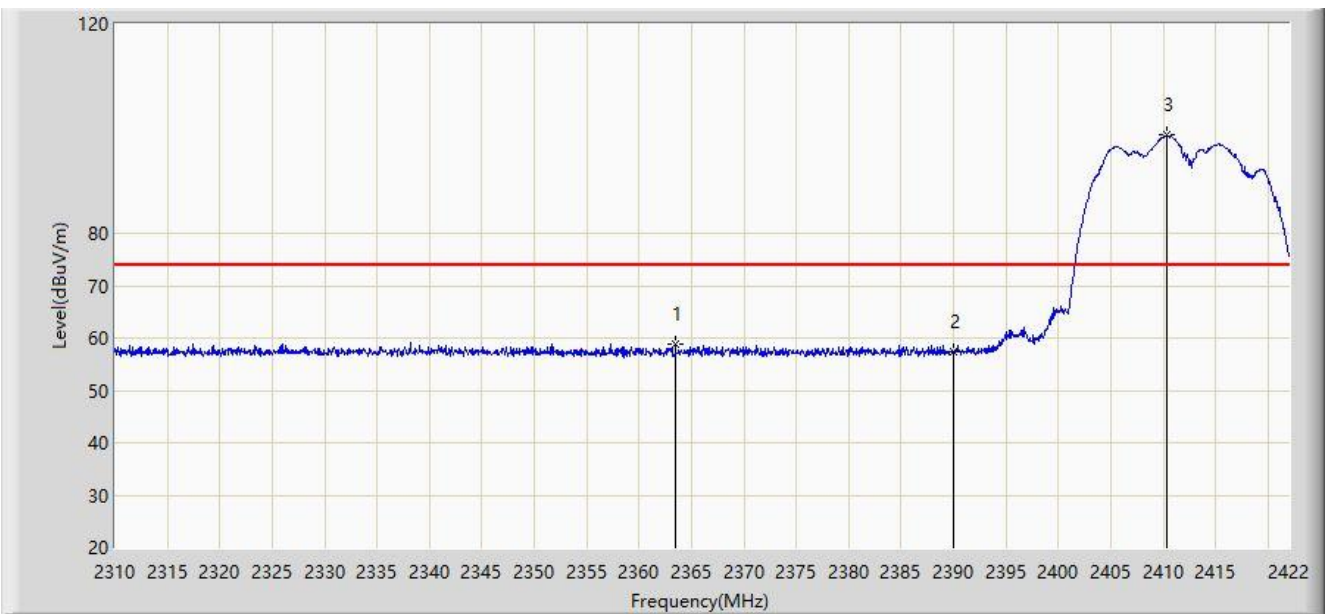

No	Flag	Mark	Frequency (MHz)	Measure Level (dBuV/m)	Reading Level (dBuV)	Margin (dB)	Limit (dBuV/m)	Factor (dB)	Type
1			2363.480	58.947	26.834	-15.053	74.000	32.113	PK
2			2390.000	57.265	25.193	-16.735	74.000	32.072	PK
3		*	2410.408	98.735	66.655	N/A	N/A	32.080	PK

Note: Measure Level (dB μ V/m) = Reading Level (dB μ V) + Factor (dB)

Factor (dB) = Cable Loss (dB) + Antenna Factor (dB/m)

Site: AC1	Time: 2020/01/17 - 10:41
Limit: FCC_Part15.209_RE(3m)	Engineer: Larry Yan
Probe: AC1_BBHA9120D_1-18GHz	Polarity: Vertical
EUT: RANGEXTD USB Repeater	Power: AC 120V/60Hz
Test Mode: Transmit by 802.11g at channel 2412MHz	

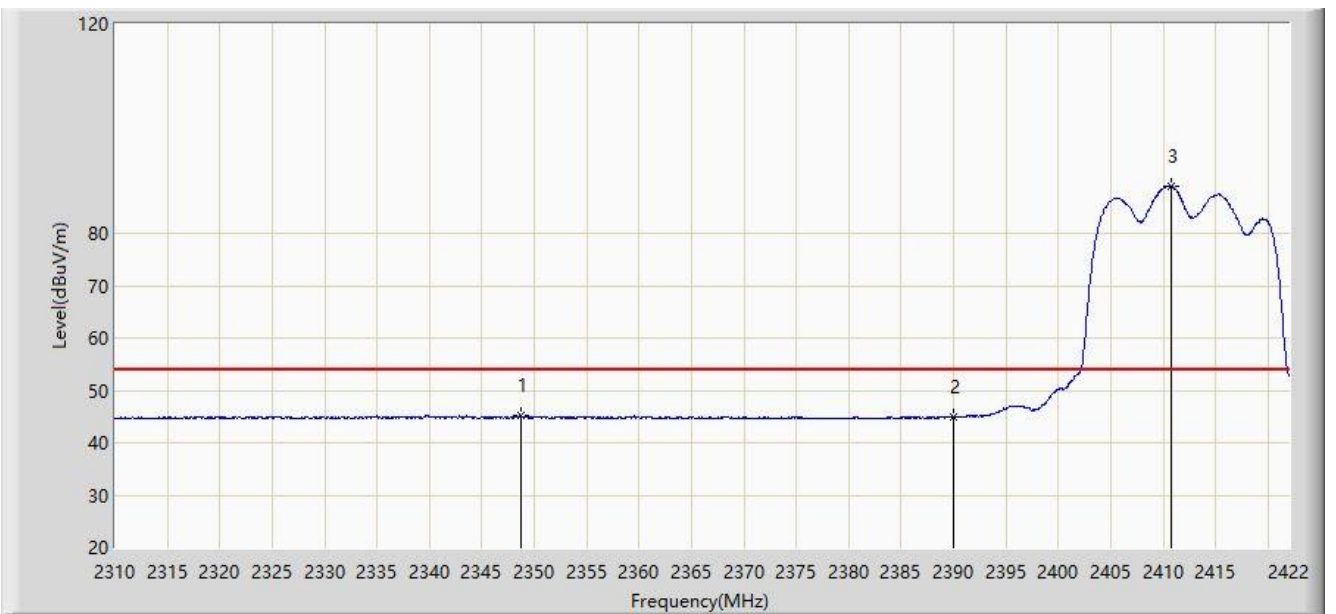

No	Flag	Mark	Frequency (MHz)	Measure Level (dBuV/m)	Reading Level (dBuV)	Margin (dB)	Limit (dBuV/m)	Factor (dB)	Type
1			2348.696	45.129	12.998	-8.871	54.000	32.131	AV
2			2390.000	45.024	12.952	-8.976	54.000	32.072	AV
3		*	2410.744	89.091	57.010	N/A	N/A	32.080	AV

Note: Measure Level (dB μ V/m) = Reading Level (dB μ V) + Factor (dB)

Factor (dB) = Cable Loss (dB) + Antenna Factor (dB/m)

Site: AC1	Time: 2020/01/17 - 10:42
Limit: FCC_Part15.209_RE(3m)	Engineer: Larry Yan
Probe: AC1_BBHA9120D_1-18GHz	Polarity: Horizontal
EUT: RANGEXTD USB Repeater	Power: AC 120V/60Hz
Test Mode: Transmit by 802.11g at channel 2462MHz	

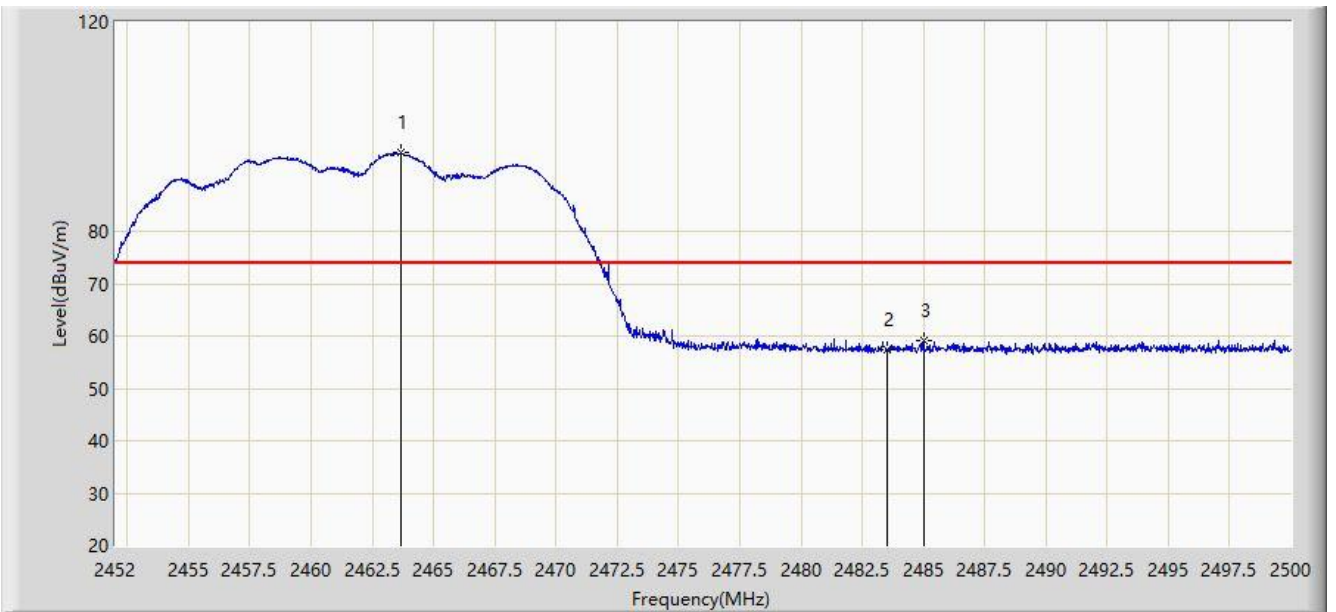

No	Flag	Mark	Frequency (MHz)	Measure Level (dBuV/m)	Reading Level (dBuV)	Margin (dB)	Limit (dBuV/m)	Factor (dB)	Type
1		*	2463.664	95.018	62.941	N/A	N/A	32.077	PK
2			2483.500	57.327	25.290	-16.673	74.000	32.037	PK
3			2485.000	59.118	27.084	-14.882	74.000	32.035	PK

Note: Measure Level (dB μ V/m) = Reading Level (dB μ V) + Factor (dB)

Factor (dB) = Cable Loss (dB) + Antenna Factor (dB/m)

Site: AC1	Time: 2020/01/17 - 10:46
Limit: FCC_Part15.209_RE(3m)	Engineer: Larry Yan
Probe: AC1_BBHA9120D_1-18GHz	Polarity: Horizontal
EUT: RANGEXTD USB Repeater	Power: AC 120V/60Hz
Test Mode: Transmit by 802.11g at channel 2462MHz	

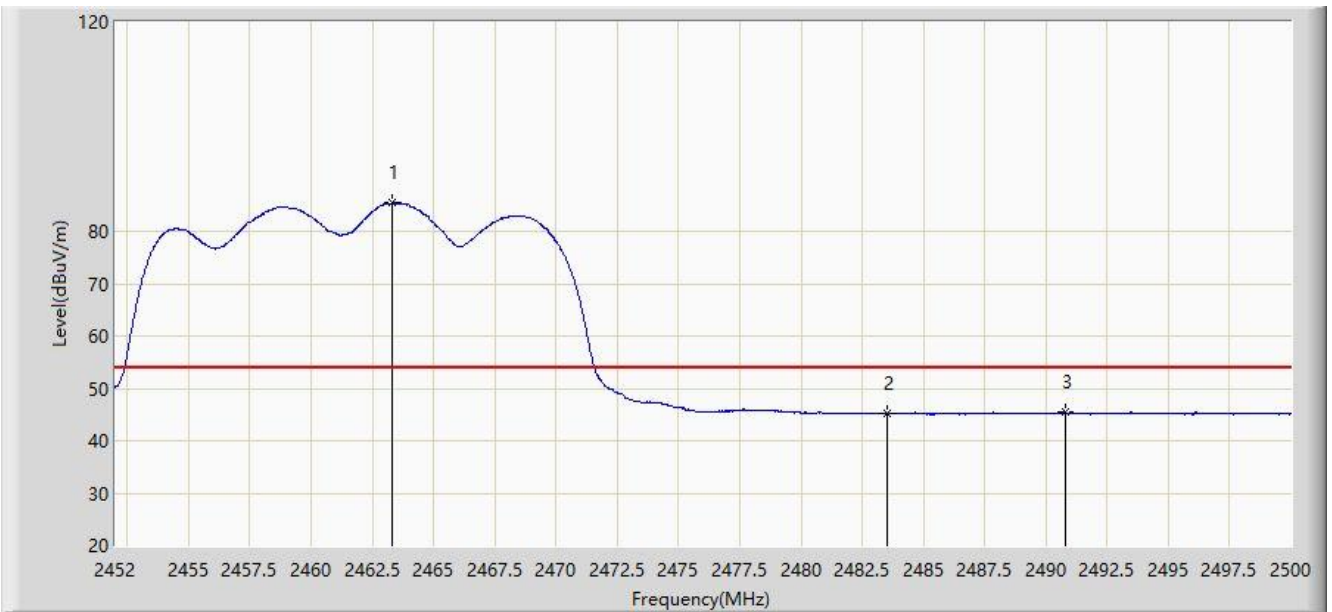

No	Flag	Mark	Frequency (MHz)	Measure Level (dBuV/m)	Reading Level (dBuV)	Margin (dB)	Limit (dBuV/m)	Factor (dB)	Type
1		*	2463.328	85.521	53.443	N/A	N/A	32.078	AV
2			2483.500	45.356	13.319	-8.644	54.000	32.037	AV
3			2490.784	45.437	13.414	-8.563	54.000	32.023	AV

Note: Measure Level (dB μ V/m) = Reading Level (dB μ V) + Factor (dB)

Factor (dB) = Cable Loss (dB) + Antenna Factor (dB/m)

Site: AC1	Time: 2020/01/17 - 10:48
Limit: FCC_Part15.209_RE(3m)	Engineer: Larry Yan
Probe: AC1_BBHA9120D_1-18GHz	Polarity: Vertical
EUT: RANGEXTD USB Repeater	Power: AC 120V/60Hz
Test Mode: Transmit by 802.11g at channel 2462MHz	

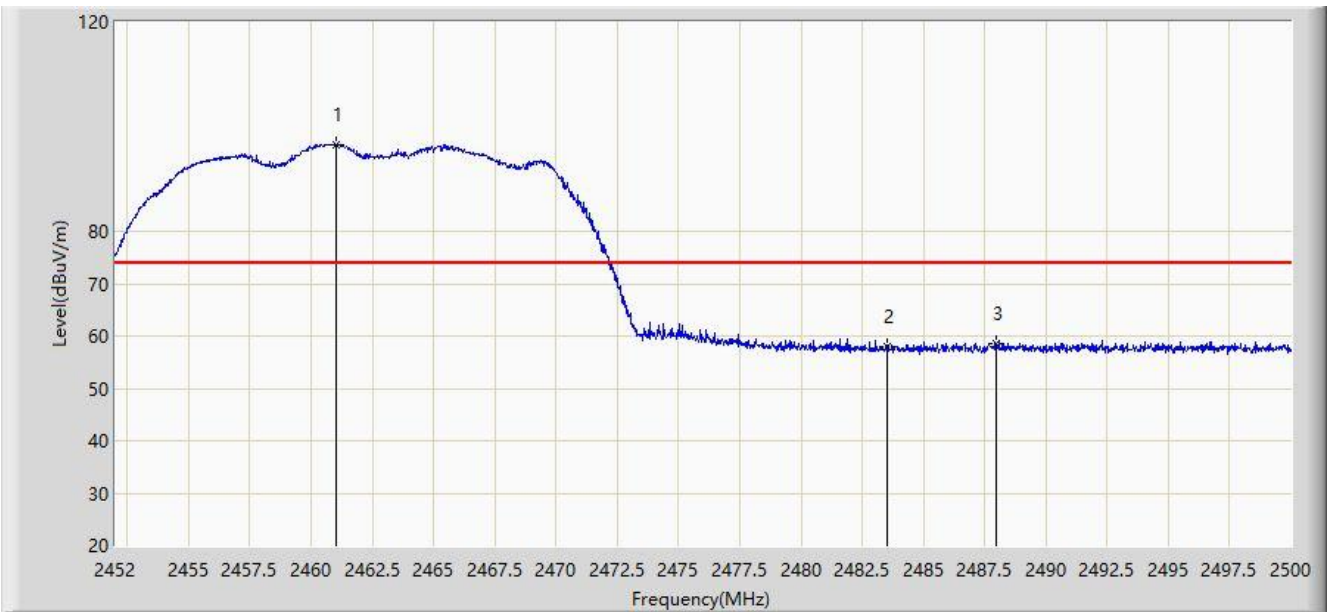

No	Flag	Mark	Frequency (MHz)	Measure Level (dBuV/m)	Reading Level (dBuV)	Margin (dB)	Limit (dBuV/m)	Factor (dB)	Type
1		*	2461.024	96.638	64.558	N/A	N/A	32.080	PK
2			2483.500	58.044	26.007	-15.956	74.000	32.037	PK
3			2487.976	58.679	26.650	-15.321	74.000	32.028	PK

Note: Measure Level (dB μ V/m) = Reading Level (dB μ V) + Factor (dB)

Factor (dB) = Cable Loss (dB) + Antenna Factor (dB/m)

Site: AC1	Time: 2020/01/17 - 10:52
Limit: FCC_Part15.209_RE(3m)	Engineer: Larry Yan
Probe: AC1_BBHA9120D_1-18GHz	Polarity: Vertical
EUT: RANGEXTD USB Repeater	Power: AC 120V/60Hz
Test Mode: Transmit by 802.11g at channel 2462MHz	

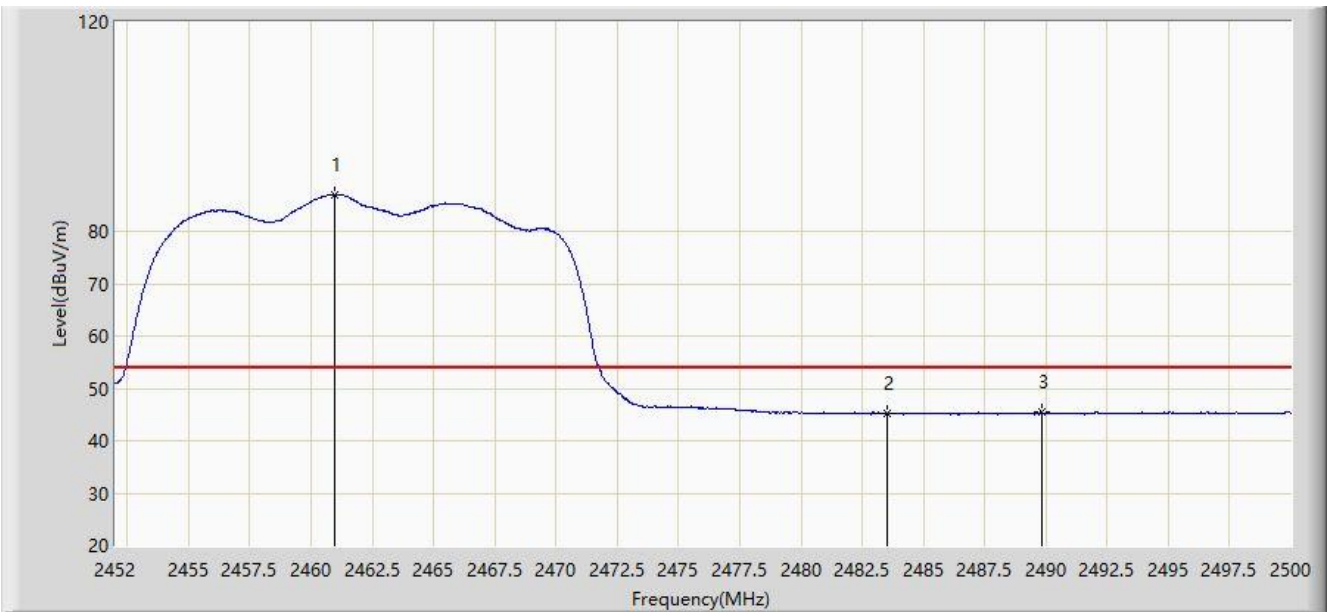

No	Flag	Mark	Frequency (MHz)	Measure Level (dBuV/m)	Reading Level (dBuV)	Margin (dB)	Limit (dBuV/m)	Factor (dB)	Type
1		*	2460.976	87.085	55.005	N/A	N/A	32.080	AV
2			2483.500	45.177	13.140	-8.823	54.000	32.037	AV
3			2489.824	45.387	13.362	-8.613	54.000	32.025	AV

Note: Measure Level (dB μ V/m) = Reading Level (dB μ V) + Factor (dB)

Factor (dB) = Cable Loss (dB) + Antenna Factor (dB/m)

Site: AC1	Time: 2020/01/17 - 10:56
Limit: FCC_Part15.209_RE(3m)	Engineer: Larry Yan
Probe: AC1_BBHA9120D_1-18GHz	Polarity: Horizontal
EUT: RANGEXTD USB Repeater	Power: AC 120V/60Hz
Test Mode: Transmit by 802.11n-HT20 at channel 2412MHz	

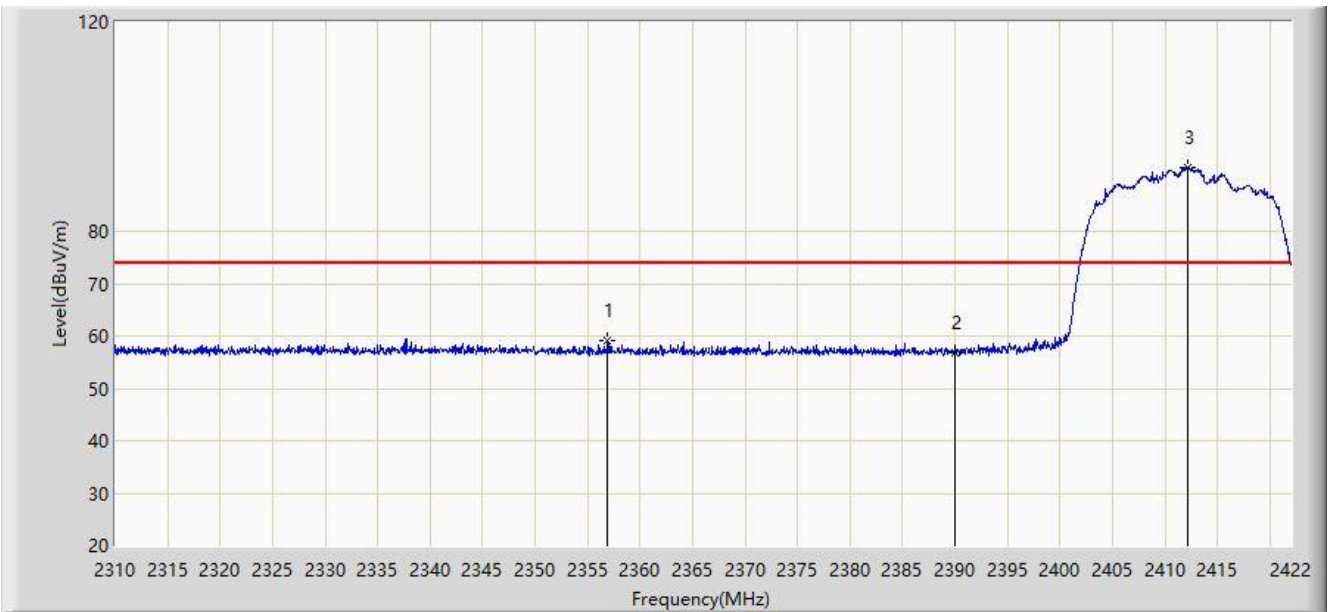

No	Flag	Mark	Frequency (MHz)	Measure Level (dBuV/m)	Reading Level (dBuV)	Margin (dB)	Limit (dBuV/m)	Factor (dB)	Type
1			2356.928	59.021	26.896	-14.979	74.000	32.125	PK
2			2390.000	56.923	24.851	-17.077	74.000	32.072	PK
3		*	2412.200	92.239	60.155	N/A	N/A	32.084	PK

Note: Measure Level (dB μ V/m) = Reading Level (dB μ V) + Factor (dB)

Factor (dB) = Cable Loss (dB) + Antenna Factor (dB/m)

Site: AC1	Time: 2020/01/17 - 11:02
Limit: FCC_Part15.209_RE(3m)	Engineer: Larry Yan
Probe: AC1_BBHA9120D_1-18GHz	Polarity: Horizontal
EUT: RANGEXTD USB Repeater	Power: AC 120V/60Hz
Test Mode: Transmit by 802.11n-HT20 at channel 2412MHz	

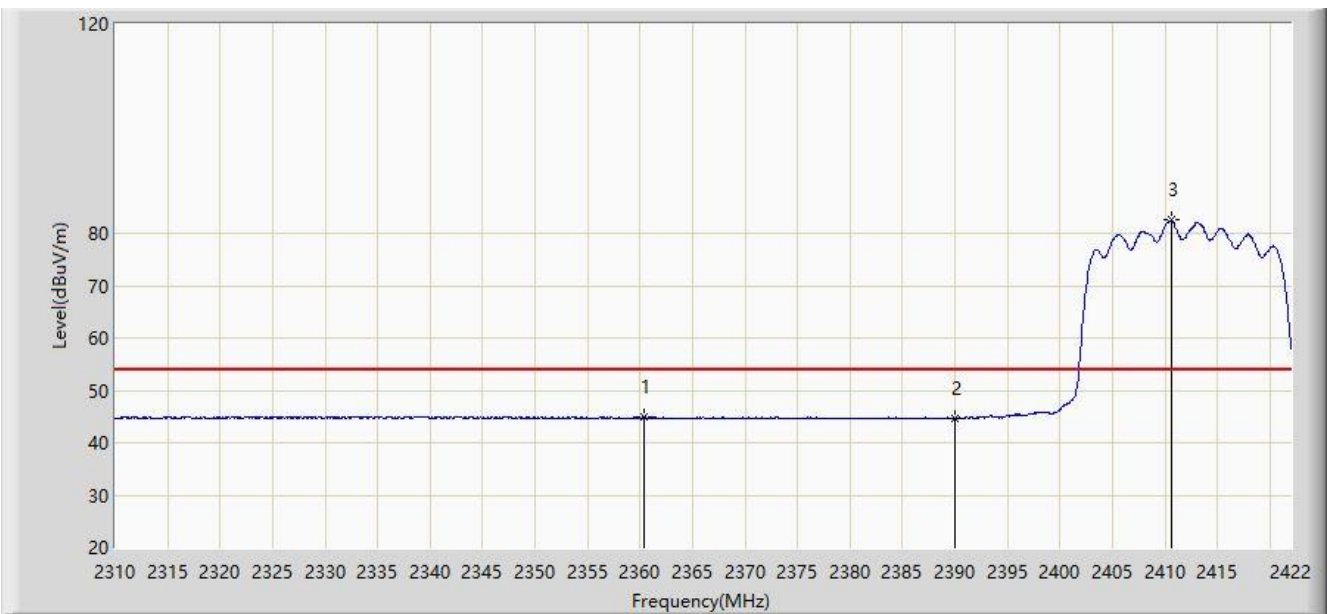

No	Flag	Mark	Frequency (MHz)	Measure Level (dBuV/m)	Reading Level (dBuV)	Margin (dB)	Limit (dBuV/m)	Factor (dB)	Type
1			2360.456	45.040	12.919	-8.960	54.000	32.121	AV
2			2390.000	44.745	12.673	-9.255	54.000	32.072	AV
3		*	2410.576	82.508	50.427	N/A	N/A	32.081	AV

Note: Measure Level (dB μ V/m) = Reading Level (dB μ V) + Factor (dB)

Factor (dB) = Cable Loss (dB) + Antenna Factor (dB/m)

Site: AC1	Time: 2020/01/17 - 11:03
Limit: FCC_Part15.209_RE(3m)	Engineer: Larry Yan
Probe: AC1_BBHA9120D_1-18GHz	Polarity: Vertical
EUT: RANGEXTD USB Repeater	Power: AC 120V/60Hz
Test Mode: Transmit by 802.11n-HT20 at channel 2412MHz	

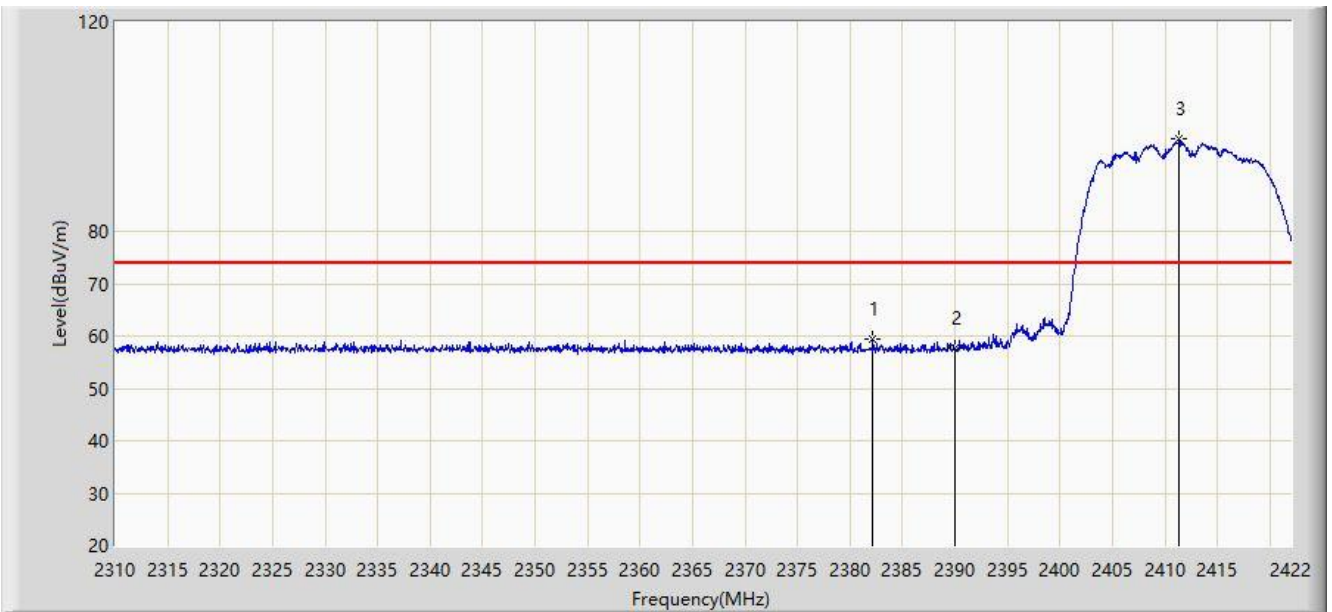

No	Flag	Mark	Frequency (MHz)	Measure Level (dBuV/m)	Reading Level (dBuV)	Margin (dB)	Limit (dBuV/m)	Factor (dB)	Type
1			2382.184	59.489	27.414	-14.511	74.000	32.074	PK
2			2390.000	57.543	25.471	-16.457	74.000	32.072	PK
3		*	2411.360	97.787	65.705	N/A	N/A	32.082	PK

Note: Measure Level (dB μ V/m) = Reading Level (dB μ V) + Factor (dB)

Factor (dB) = Cable Loss (dB) + Antenna Factor (dB/m)

Site: AC1	Time: 2020/01/17 - 11:10
Limit: FCC_Part15.209_RE(3m)	Engineer: Larry Yan
Probe: AC1_BBHA9120D_1-18GHz	Polarity: Vertical
EUT: RANGEXTD USB Repeater	Power: AC 120V/60Hz
Test Mode: Transmit by 802.11n-HT20 at channel 2412MHz	

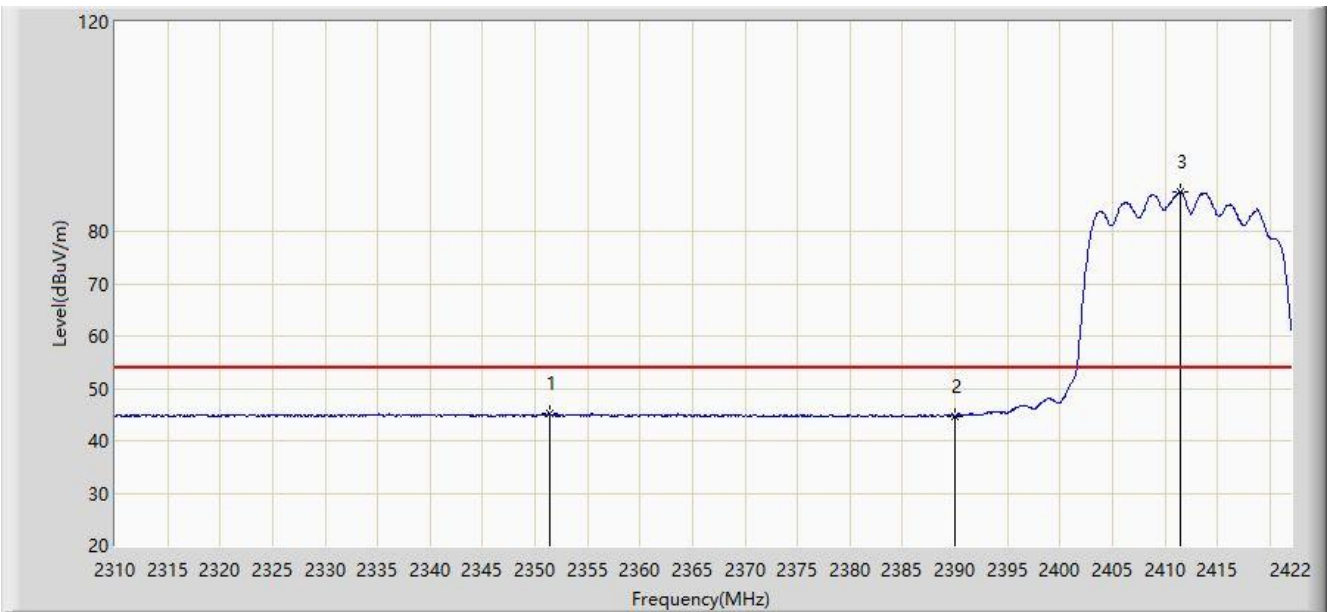

No	Flag	Mark	Frequency (MHz)	Measure Level (dBuV/m)	Reading Level (dBuV)	Margin (dB)	Limit (dBuV/m)	Factor (dB)	Type
1			2351.384	45.208	13.079	-8.792	54.000	32.129	AV
2			2390.000	44.726	12.654	-9.274	54.000	32.072	AV
3		*	2411.472	87.520	55.438	N/A	N/A	32.082	AV

Note: Measure Level (dB μ V/m) = Reading Level (dB μ V) + Factor (dB)

Factor (dB) = Cable Loss (dB) + Antenna Factor (dB/m)

Site: AC1	Time: 2020/01/17 - 11:11
Limit: FCC_Part15.209_RE(3m)	Engineer: Larry Yan
Probe: AC1_BBHA9120D_1-18GHz	Polarity: Horizontal
EUT: RANGEXTD USB Repeater	Power: AC 120V/60Hz
Test Mode: Transmit by 802.11n-HT20 at channel 2462MHz	

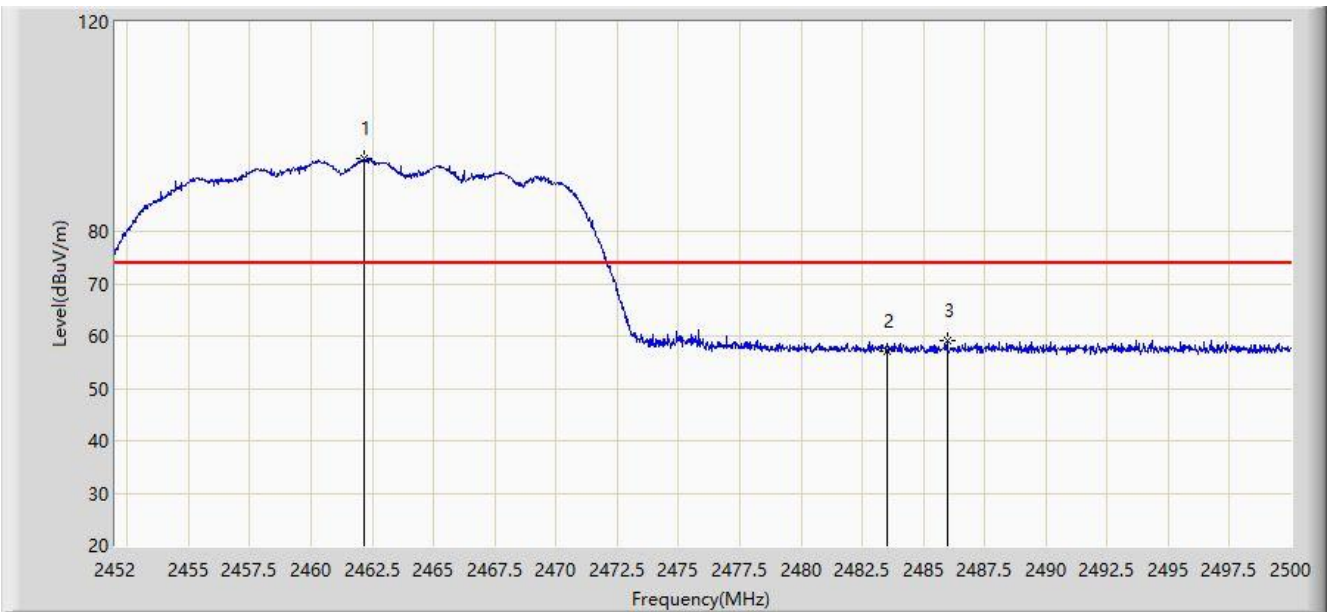

No	Flag	Mark	Frequency (MHz)	Measure Level (dBuV/m)	Reading Level (dBuV)	Margin (dB)	Limit (dBuV/m)	Factor (dB)	Type
1		*	2462.152	93.852	61.772	N/A	N/A	32.081	PK
2			2483.500	57.052	25.015	-16.948	74.000	32.037	PK
3			2485.960	59.123	27.091	-14.877	74.000	32.032	PK

Note: Measure Level (dB μ V/m) = Reading Level (dB μ V) + Factor (dB)

Factor (dB) = Cable Loss (dB) + Antenna Factor (dB/m)

Site: AC1	Time: 2020/01/17 - 11:13
Limit: FCC_Part15.209_RE(3m)	Engineer: Larry Yan
Probe: AC1_BBHA9120D_1-18GHz	Polarity: Horizontal
EUT: RANGEXTD USB Repeater	Power: AC 120V/60Hz
Test Mode: Transmit by 802.11n-HT20 at channel 2462MHz	

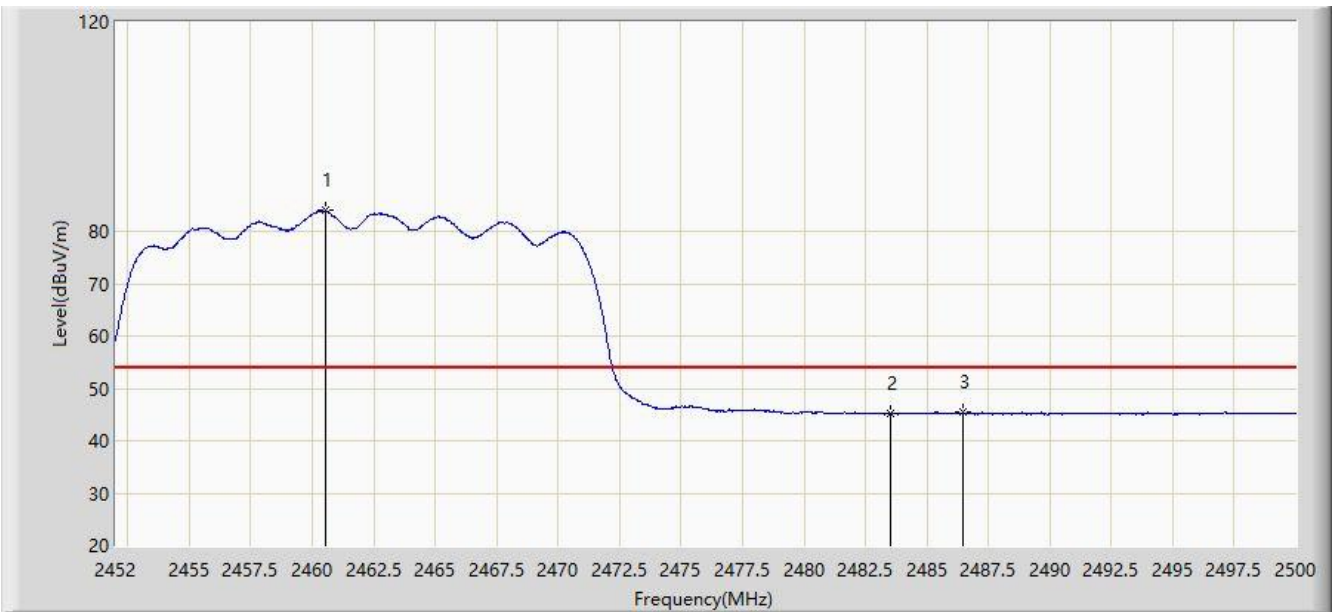

No	Flag	Mark	Frequency (MHz)	Measure Level (dBuV/m)	Reading Level (dBuV)	Margin (dB)	Limit (dBuV/m)	Factor (dB)	Type
1		*	2460.520	84.007	51.927	N/A	N/A	32.080	AV
2			2483.500	45.139	13.102	-8.861	54.000	32.037	AV
3			2486.464	45.406	13.375	-8.594	54.000	32.031	AV

Note: Measure Level (dB μ V/m) = Reading Level (dB μ V) + Factor (dB)

Factor (dB) = Cable Loss (dB) + Antenna Factor (dB/m)

Site: AC1	Time: 2020/01/17 - 11:14
Limit: FCC_Part15.209_RE(3m)	Engineer: Larry Yan
Probe: AC1_BBHA9120D_1-18GHz	Polarity: Vertical
EUT: RANGEXTD USB Repeater	Power: AC 120V/60Hz
Test Mode: Transmit by 802.11n-HT20 at channel 2462MHz	

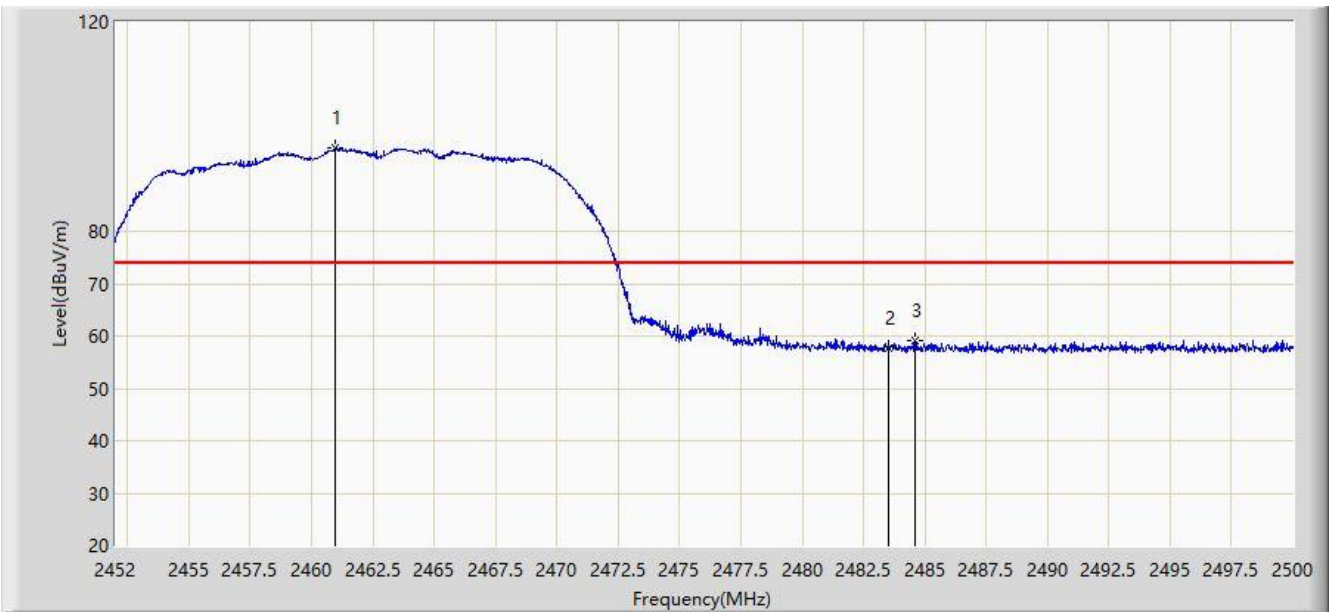

No	Flag	Mark	Frequency (MHz)	Measure Level (dBuV/m)	Reading Level (dBuV)	Margin (dB)	Limit (dBuV/m)	Factor (dB)	Type
1		*	2460.976	95.844	63.764	N/A	N/A	32.080	PK
2			2483.500	57.708	25.671	-16.292	74.000	32.037	PK
3			2484.616	59.206	27.171	-14.794	74.000	32.035	PK

Note: Measure Level (dB μ V/m) = Reading Level (dB μ V) + Factor (dB)

Factor (dB) = Cable Loss (dB) + Antenna Factor (dB/m)

Site: AC1	Time: 2020/01/17 - 11:17
Limit: FCC_Part15.209_RE(3m)	Engineer: Larry Yan
Probe: AC1_BBHA9120D_1-18GHz	Polarity: Vertical
EUT: RANGEXTD USB Repeater	Power: AC 120V/60Hz
Test Mode: Transmit by 802.11n-HT20 at channel 2462MHz	

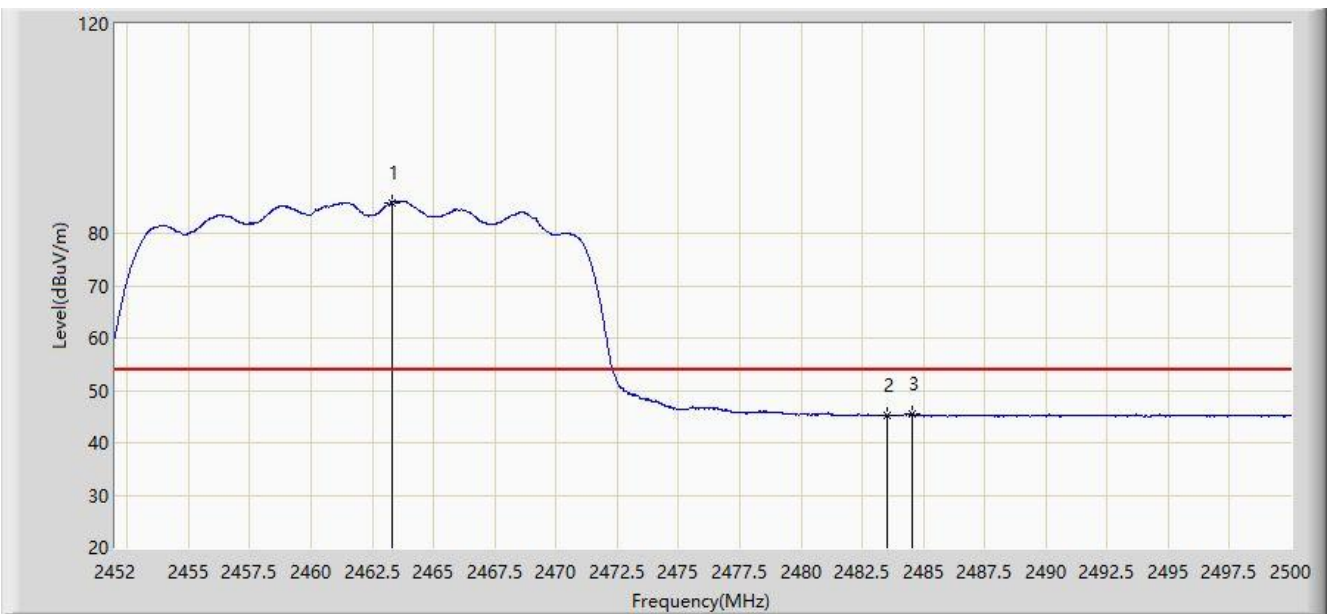

No	Flag	Mark	Frequency (MHz)	Measure Level (dBuV/m)	Reading Level (dBuV)	Margin (dB)	Limit (dBuV/m)	Factor (dB)	Type
1		*	2463.308	85.915	53.837	N/A	N/A	32.078	AV
2			2483.500	45.330	13.293	-8.670	54.000	32.037	AV
3			2484.544	45.554	13.519	-8.446	54.000	32.035	AV

Note: Measure Level (dB μ V/m) = Reading Level (dB μ V) + Factor (dB)

Factor (dB) = Cable Loss (dB) + Antenna Factor (dB/m)

Site: AC1	Time: 2020/01/17 - 11:20
Limit: FCC_Part15.209_RE(3m)	Engineer: Larry Yan
Probe: AC1_BBHA9120D_1-18GHz	Polarity: Horizontal
EUT: RANGEXTD USB Repeater	Power: AC 120V/60Hz
Test Mode: Transmit by 802.11n-HT40 at channel 2422MHz	

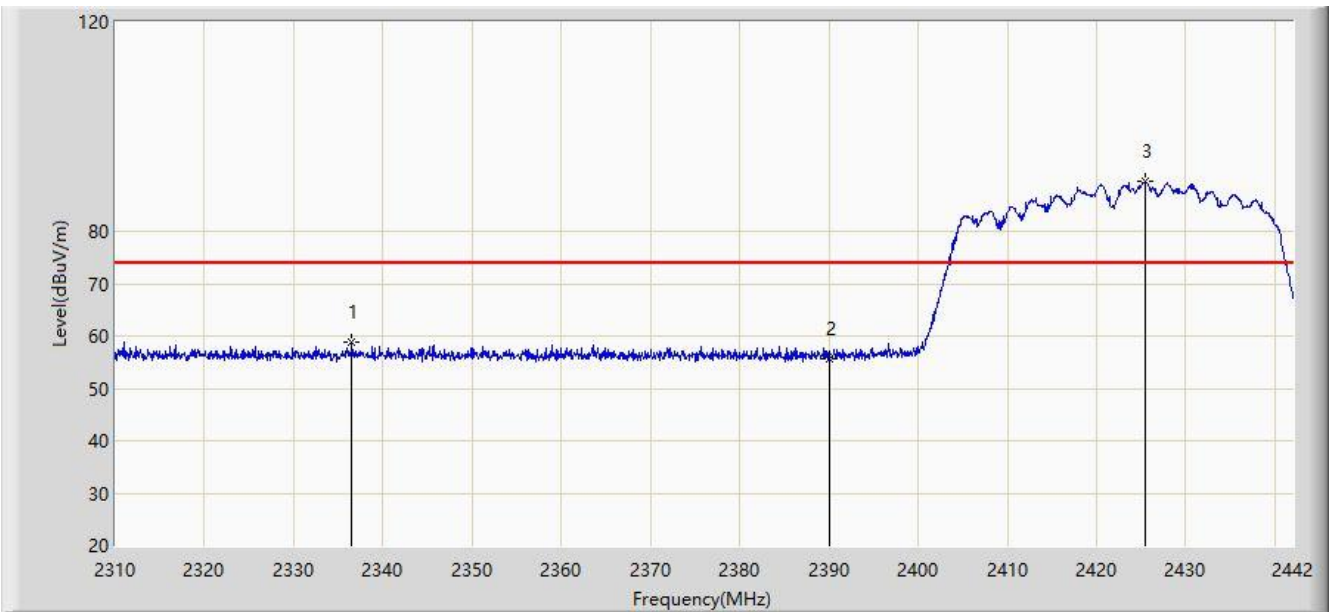

No	Flag	Mark	Frequency (MHz)	Measure Level (dBuV/m)	Reading Level (dBuV)	Margin (dB)	Limit (dBuV/m)	Factor (dB)	Type
1			2336.532	58.905	26.752	-15.095	74.000	32.152	PK
2			2390.000	55.787	23.715	-18.213	74.000	32.072	PK
3		*	2425.500	89.469	57.350	N/A	N/A	32.119	PK

Note: Measure Level (dB μ V/m) = Reading Level (dB μ V) + Factor (dB)

Factor (dB) = Cable Loss (dB) + Antenna Factor (dB/m)

Site: AC1	Time: 2020/01/17 - 11:26
Limit: FCC_Part15.209_RE(3m)	Engineer: Larry Yan
Probe: AC1_BBHA9120D_1-18GHz	Polarity: Horizontal
EUT: RANGEXTD USB Repeater	Power: AC 120V/60Hz
Test Mode: Transmit by 802.11n-HT40 at channel 2422MHz	

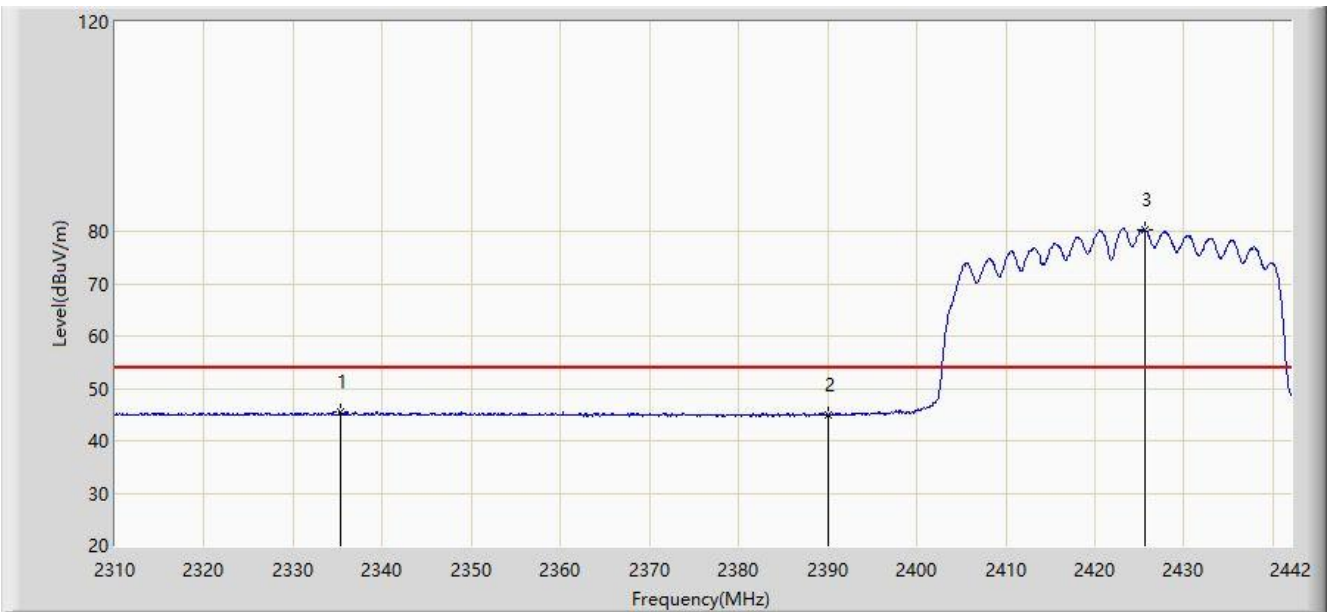

No	Flag	Mark	Frequency (MHz)	Measure Level (dBuV/m)	Reading Level (dBuV)	Margin (dB)	Limit (dBuV/m)	Factor (dB)	Type
1			2335.278	45.624	13.468	-8.376	54.000	32.156	AV
2			2390.000	44.996	12.924	-9.004	54.000	32.072	AV
3		*	2425.566	80.336	48.217	N/A	N/A	32.119	AV

Note: Measure Level (dB μ V/m) = Reading Level (dB μ V) + Factor (dB)

Factor (dB) = Cable Loss (dB) + Antenna Factor (dB/m)

Site: AC1	Time: 2020/01/17 - 11:27
Limit: FCC_Part15.209_RE(3m)	Engineer: Larry Yan
Probe: AC1_BBHA9120D_1-18GHz	Polarity: Vertical
EUT: RANGEXTD USB Repeater	Power: AC 120V/60Hz
Test Mode: Transmit by 802.11n-HT40 at channel 2422MHz	

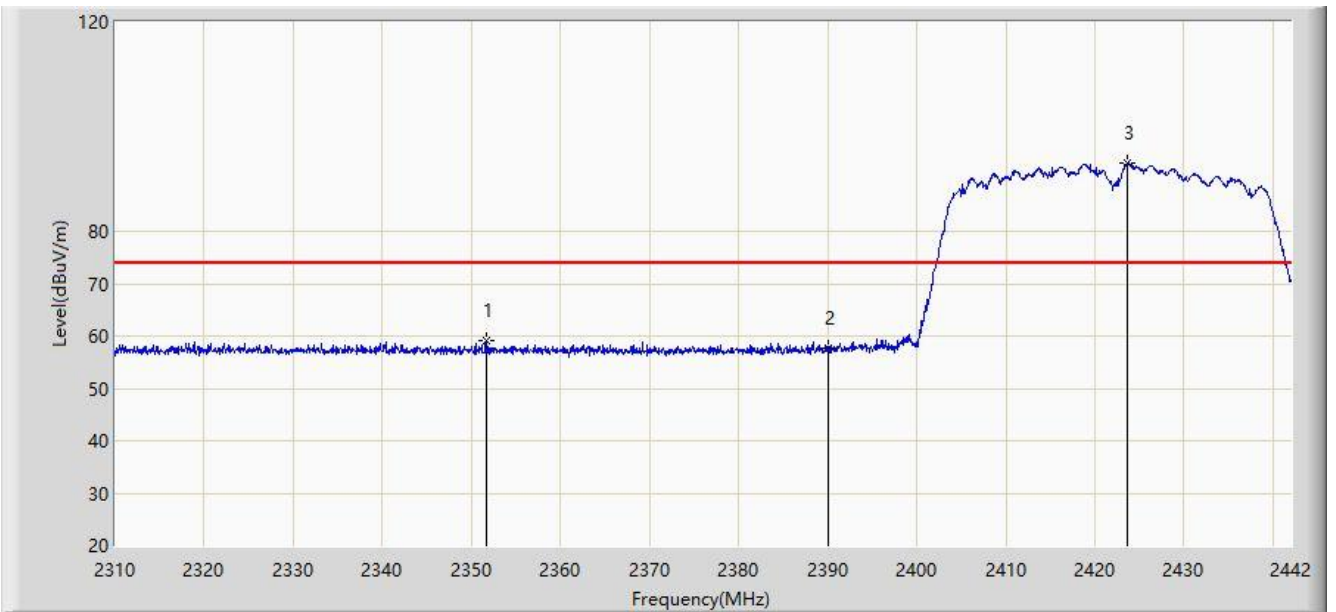

No	Flag	Mark	Frequency (MHz)	Measure Level (dBuV/m)	Reading Level (dBuV)	Margin (dB)	Limit (dBuV/m)	Factor (dB)	Type
1			2351.646	58.991	26.862	-15.009	74.000	32.129	PK
2			2390.000	57.713	25.641	-16.287	74.000	32.072	PK
3		*	2423.718	92.983	60.869	N/A	N/A	32.114	PK

Note: Measure Level (dB μ V/m) = Reading Level (dB μ V) + Factor (dB)

Factor (dB) = Cable Loss (dB) + Antenna Factor (dB/m)

Site: AC1	Time: 2020/01/17 - 11:31
Limit: FCC_Part15.209_RE(3m)	Engineer: Larry Yan
Probe: AC1_BBHA9120D_1-18GHz	Polarity: Vertical
EUT: RANGEXTD USB Repeater	Power: AC 120V/60Hz
Test Mode: Transmit by 802.11n-HT40 at channel 2422MHz	

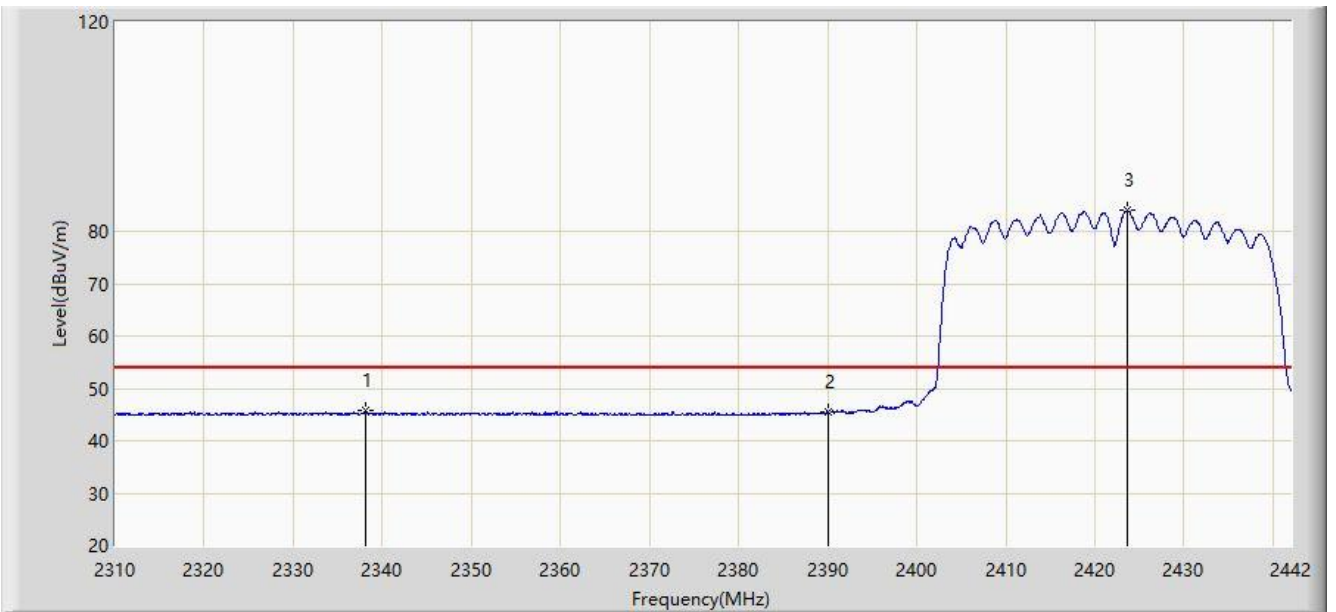

No	Flag	Mark	Frequency (MHz)	Measure Level (dBuV/m)	Reading Level (dBuV)	Margin (dB)	Limit (dBuV/m)	Factor (dB)	Type
1			2338.116	45.677	13.528	-8.323	54.000	32.149	AV
2			2390.000	45.557	13.485	-8.443	54.000	32.072	AV
3		*	2423.652	83.959	51.845	N/A	N/A	32.114	AV

Note: Measure Level (dB μ V/m) = Reading Level (dB μ V) + Factor (dB)

Factor (dB) = Cable Loss (dB) + Antenna Factor (dB/m)

Site: AC1	Time: 2020/01/17 - 11:31
Limit: FCC_Part15.209_RE(3m)	Engineer: Larry Yan
Probe: AC1_BBHA9120D_1-18GHz	Polarity: Horizontal
EUT: RANGEXTD USB Repeater	Power: AC 120V/60Hz
Test Mode: Transmit by 802.11n-HT40 at channel 2452MHz	

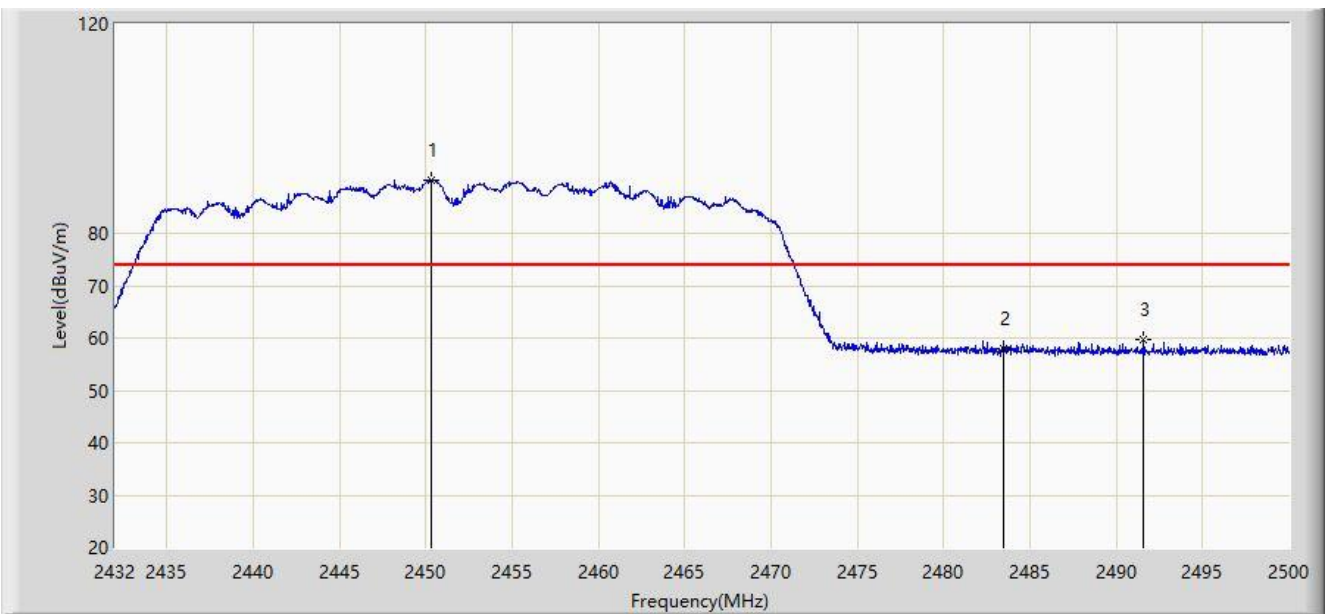

No	Flag	Mark	Frequency (MHz)	Measure Level (dBuV/m)	Reading Level (dBuV)	Margin (dB)	Limit (dBuV/m)	Factor (dB)	Type
1		*	2450.326	90.223	58.147	N/A	N/A	32.075	PK
2			2483.500	58.089	26.052	-15.911	74.000	32.037	PK
3			2491.602	59.707	27.685	-14.293	74.000	32.021	PK

Note: Measure Level (dB μ V/m) = Reading Level (dB μ V) + Factor (dB)

Factor (dB) = Cable Loss (dB) + Antenna Factor (dB/m)

Site: AC1	Time: 2020/01/17 - 11:37
Limit: FCC_Part15.209_RE(3m)	Engineer: Larry Yan
Probe: AC1_BBHA9120D_1-18GHz	Polarity: Horizontal
EUT: RANGEXTD USB Repeater	Power: AC 120V/60Hz
Test Mode: Transmit by 802.11n-HT40 at channel 2452MHz	

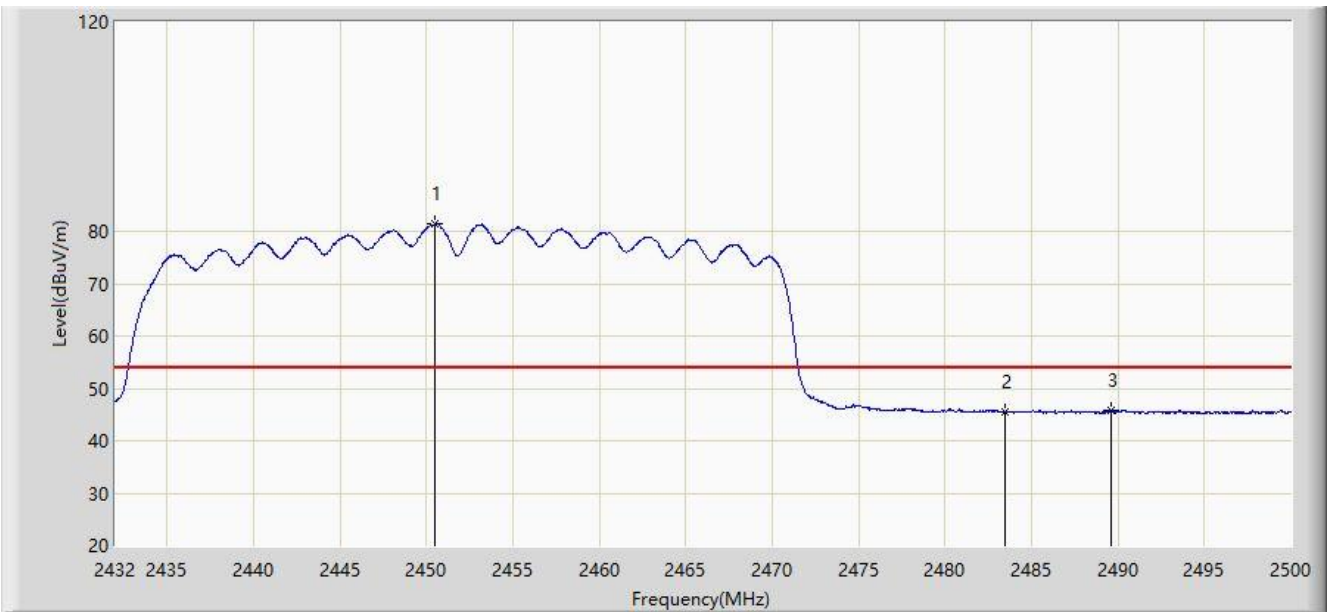

No	Flag	Mark	Frequency (MHz)	Measure Level (dBuV/m)	Reading Level (dBuV)	Margin (dB)	Limit (dBuV/m)	Factor (dB)	Type
1		*	2450.530	81.356	49.280	N/A	N/A	32.076	AV
2			2483.500	45.543	13.506	-8.457	54.000	32.037	AV
3			2489.596	45.762	13.737	-8.238	54.000	32.025	AV

Note: Measure Level (dBμV/m) = Reading Level (dBμV) + Factor (dB)

Factor (dB) = Cable Loss (dB) + Antenna Factor (dB/m)

Site: AC1	Time: 2020/01/17 - 11:38
Limit: FCC_Part15.209_RE(3m)	Engineer: Larry Yan
Probe: AC1_BBHA9120D_1-18GHz	Polarity: Vertical
EUT: RANGEXTD USB Repeater	Power: AC 120V/60Hz
Test Mode: Transmit by 802.11n-HT40 at channel 2452MHz	

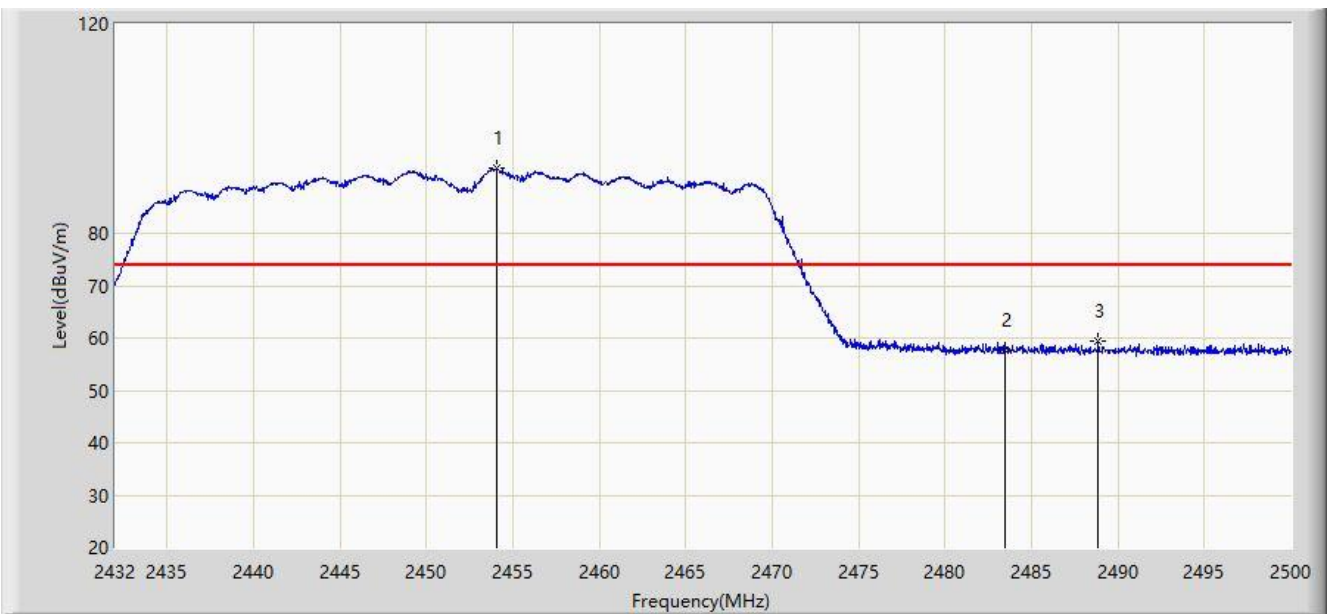

No	Flag	Mark	Frequency (MHz)	Measure Level (dBuV/m)	Reading Level (dBuV)	Margin (dB)	Limit (dBuV/m)	Factor (dB)	Type
1		*	2454.066	92.367	60.290	N/A	N/A	32.077	PK
2			2483.500	57.621	25.584	-16.379	74.000	32.037	PK
3			2488.848	59.530	27.503	-14.470	74.000	32.027	PK

Note: Measure Level (dBμV/m) = Reading Level (dBμV) + Factor (dB)

Factor (dB) = Cable Loss (dB) + Antenna Factor (dB/m)

Site: AC1	Time: 2020/01/17 - 11:40
Limit: FCC_Part15.209_RE(3m)	Engineer: Larry Yan
Probe: AC1_BBHA9120D_1-18GHz	Polarity: Vertical
EUT: RANGEXTD USB Repeater	Power: AC 120V/60Hz
Test Mode: Transmit by 802.11n-HT40 at channel 2452MHz	

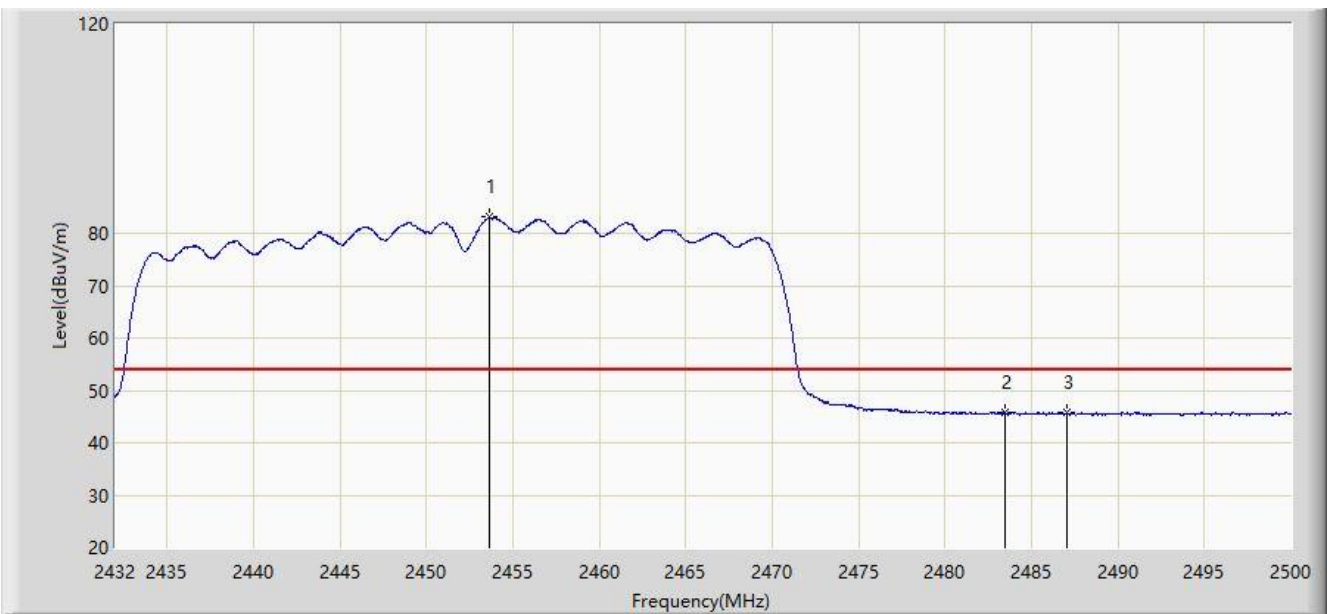

No	Flag	Mark	Frequency (MHz)	Measure Level (dBuV/m)	Reading Level (dBuV)	Margin (dB)	Limit (dBuV/m)	Factor (dB)	Type
1		*	2453.624	83.156	51.079	N/A	N/A	32.077	AV
2			2483.500	45.657	13.620	-8.343	54.000	32.037	AV
3			2487.012	45.774	13.744	-8.226	54.000	32.031	AV

Note: Measure Level (dB μ V/m) = Reading Level (dB μ V) + Factor (dB)

Factor (dB) = Cable Loss (dB) + Antenna Factor (dB/m)

7.8. AC Conducted Emissions Measurement

7.8.1. Test Limit

FCC Part 15 Subpart C Paragraph 15.207 Limits		
Frequency (MHz)	QP (dBuV)	AV (dBuV)
0.15 - 0.50	66 - 56	56 - 46
0.50 - 5.0	56	46
5.0 - 30	60	50

Note 1: The lower limit shall apply at the transition frequencies.

Note 2: The limit decreases linearly with the logarithm of the frequency in the range 0.15MHz to 0.5MHz.

7.8.2. Test Setup

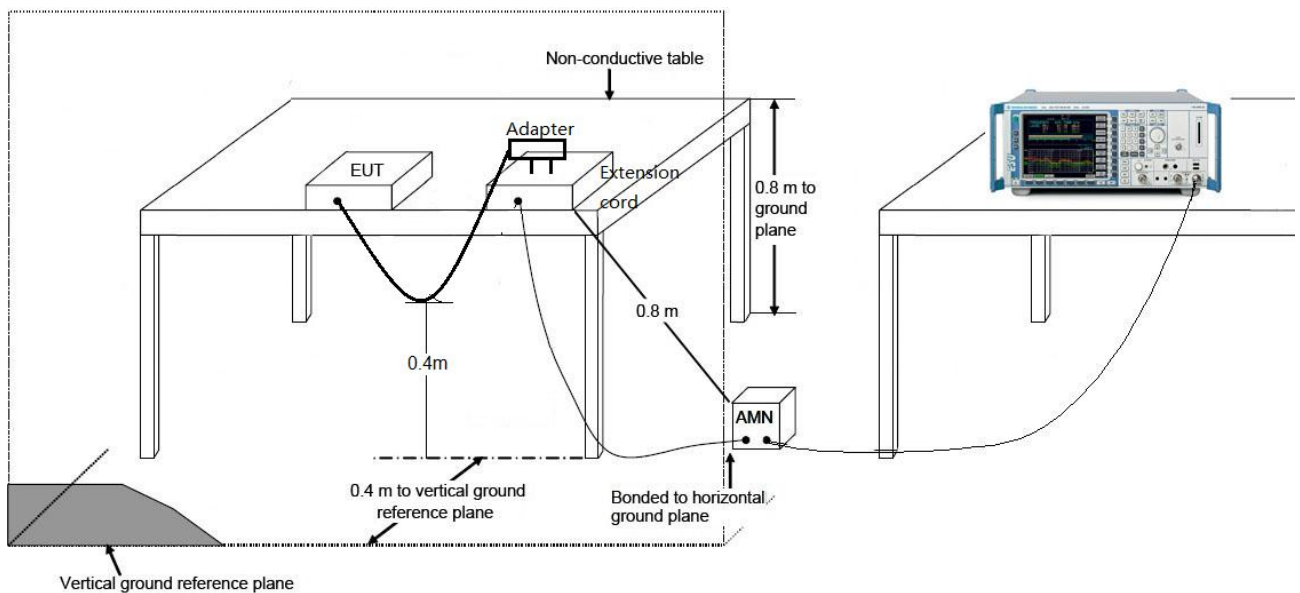

7.8.3. Test Result

Site: SR2	Time: 2020/01/20 - 08:55
Limit: FCC_Part15.207_CE_AC Power	Engineer: Liz Yuan
Probe: ENV216_101683_Filter On	Polarity: Line
EUT: RANGEXTD USB Repeater	Power: AC 120V/60Hz
Test Mode 1	

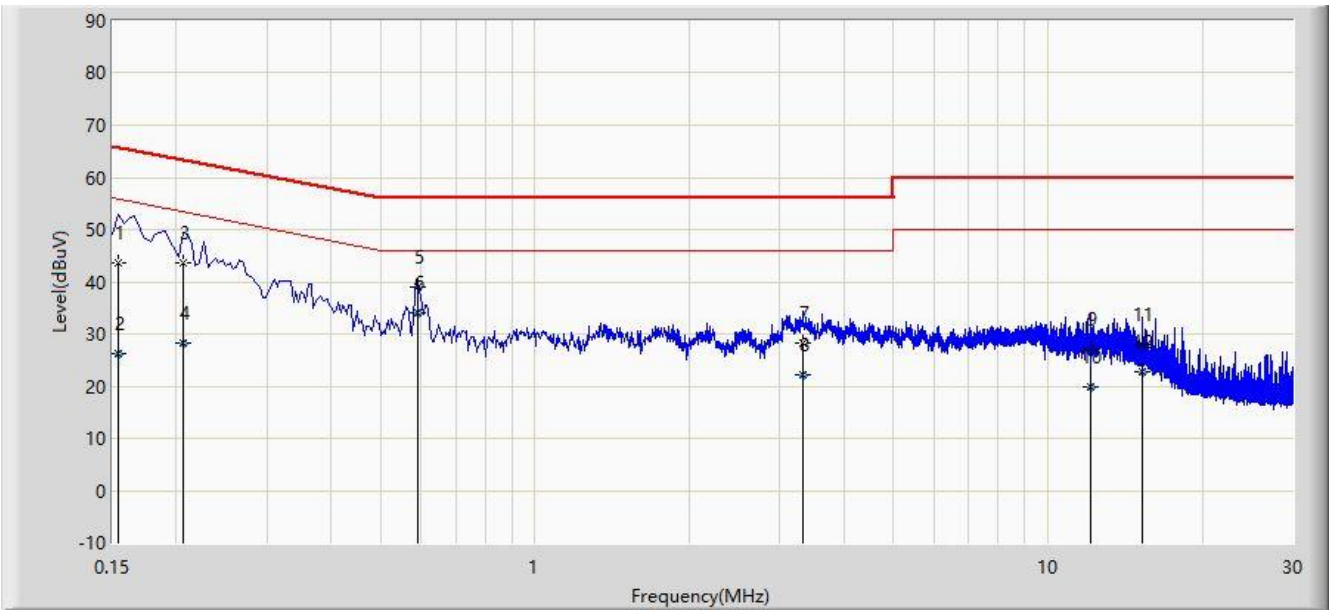

No	Flag	Mark	Frequency (MHz)	Measure Level (dBuV)	Reading Level (dBuV)	Margin (dB)	Limit (dBuV)	Factor (dB)	Type
1			0.154	43.581	31.703	-22.200	65.781	11.878	QP
2			0.154	26.275	14.398	-29.506	55.781	11.878	AV
3			0.206	43.720	33.924	-19.645	63.365	9.796	QP
4			0.206	28.346	18.550	-25.019	53.365	9.796	AV
5			0.590	38.978	29.028	-17.022	56.000	9.951	QP
6		*	0.590	34.127	24.177	-11.873	46.000	9.951	AV
7			3.322	28.286	18.590	-27.714	56.000	9.696	QP
8			3.322	22.259	12.563	-23.741	46.000	9.696	AV
9			12.134	27.115	17.272	-32.885	60.000	9.843	QP
10			12.134	19.950	10.107	-30.050	50.000	9.843	AV
11			15.250	27.898	17.998	-32.102	60.000	9.900	QP
12			15.250	22.839	12.940	-27.161	50.000	9.900	AV

Note: Measure Level (dBμV) = Reading Level (dBμV) + Factor (dB)

Factor (dB) = Cable Loss (dB) + LISN Factor (dB).

Site: SR2	Time: 2020/01/20 - 09:04
Limit: FCC_Part15.207_CE_AC Power	Engineer: Liz Yuan
Probe: ENV216_101683_Filter On	Polarity: Neutral
EUT: RANGEXTD USB Repeater	Power: AC 120V/60Hz
Test Mode 1	

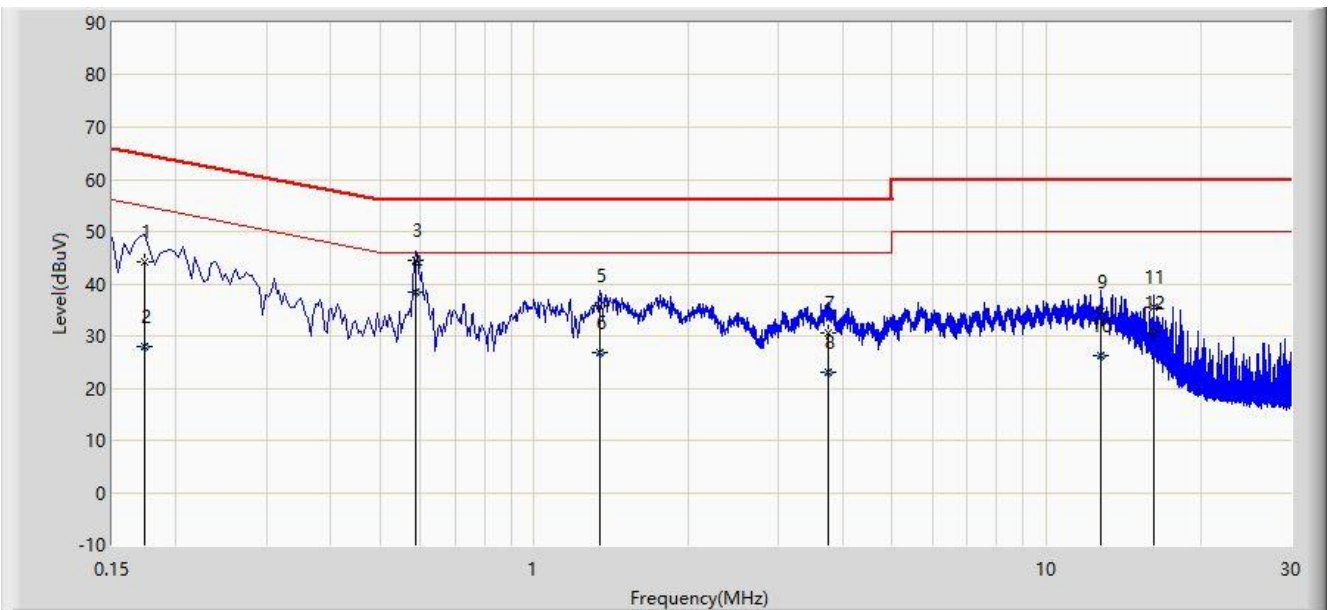

No	Flag	Mark	Frequency (MHz)	Measure Level (dBuV)	Reading Level (dBuV)	Margin (dB)	Limit (dBuV)	Factor (dB)	Type
1			0.174	44.156	34.032	-20.611	64.767	10.125	QP
2			0.174	27.840	17.715	-26.927	54.767	10.125	AV
3			0.586	44.573	34.622	-11.427	56.000	9.951	QP
4		*	0.586	38.512	28.561	-7.488	46.000	9.951	AV
5			1.346	35.909	26.187	-20.091	56.000	9.722	QP
6			1.346	26.900	17.177	-19.100	46.000	9.722	AV
7			3.750	30.571	20.879	-25.429	56.000	9.692	QP
8			3.750	23.041	13.349	-22.959	46.000	9.692	AV
9			12.746	34.562	24.675	-25.438	60.000	9.887	QP
10			12.746	26.317	16.430	-23.683	50.000	9.887	AV
11			16.226	35.520	25.564	-24.480	60.000	9.956	QP
12			16.226	30.684	20.728	-19.316	50.000	9.956	AV

Note: Measure Level (dBμV) = Reading Level (dBμV) + Factor (dB)

Factor (dB) = Cable Loss (dB) + LISN Factor (dB).

8. CONCLUSION

The data collected relate only the item(s) tested and show that the device is compliance with Part 15C of the FCC Rules.

_____ The End _____

Appendix A - Test Setup Photograph

Refer to "2001RSU021-UT" file.

Appendix B - EUT Photograph

Refer to "2001RSU021-UE" file.