

Airtouch (Shanghai) Intelligent Technology Co., Ltd

TEST REPORT

SCOPE OF WORK

EMC TESTING-ATS58-2020

REPORT NUMBER

200624005GZU-001

ISSUE DATE

20-July-2020

[REVISED DATE]

[-----]

PAGES

26

DOCUMENT CONTROL NUMBER

FCC Part 15.249-d

© 2017 INTERTEK



TEST REPORT

Applicant Name & Address : Airtouch (Shanghai) Intelligent Technology Co., Ltd
Room 902, Building 2, No. 88 Shengrong Road, Pudong New Area,
Shanghai,China

Manufacturing Site : Airtouch (Shanghai) Intelligent Technology Co., Ltd
Room 902, Building 2, No. 88 Shengrong Road, Pudong New Area,
Shanghai,China

Intertek Report No: 200624005GZU-001
FCC ID: 2AVK2-ATS58-2020

Test standards

47 CFR PART 15 Subpart C: 2018 section 15.249

Sample Description

Product : 5.8GHz Radar Sensor
Model No. : ATS58-2020
Electrical Rating : 5V, 38mA, 0.5mW
Serial No. : Not Labeled
Date Received : 24 June 2020
Date Test : 1 July 2020-16 July 2020
Conducted

Prepared and Checked By

Approved By:



Oscar Gao
Project Engineer



Helen Ma
Team Leader

This report is for the exclusive use of Intertek's Client and is provided pursuant to the agreement between Intertek and its Client. Intertek's responsibility and liability are limited to the terms and conditions of the agreement. Intertek assumes no liability to any party, other than to the Client in accordance with the agreement, for any loss, expense or damage occasioned by the use of this report. Only the Client is authorized to permit copying or distribution of this report and then only in its entirety. Any use of the Intertek name or one of its marks for the sale or advertisement of the tested material, product or service must first be approved in writing by Intertek. The observations and test results in this report are relevant only to the sample tested. This report by itself does not imply that the material, product, or service is or has ever been under an Intertek certification program.

TEST REPORT

CONTENT

TESTREPORT..... 1

CONTENT..... 3

1.0 TEST RESULT SUMMARY..... 4

2.0 GENERAL DESCRIPTION 5

 2.1 PRODUCT DESCRIPTION.....5

 2.2 RELATED SUBMITTAL(S) GRANTS5

 2.3 TEST METHODOLOGY5

 2.4 TEST FACILITY6

3.0 SYSTEM TEST CONFIGURATION 6

 3.1 JUSTIFICATION6

 3.2 EUT EXERCISING SOFTWARE7

 3.3 SPECIAL ACCESSORIES7

 3.4 MEASUREMENT UNCERTAINTY7

 3.5 EQUIPMENT MODIFICATION8

 3.6 SUPPORT EQUIPMENT LIST AND DESCRIPTION.....8

4.0 MEASUREMENT RESULTS 9

 4.1 ANTENNA REQUIREMENT9

 4.2 OCCUPIED BANDWIDTH10

 4.3 RADIATED EMISSION.....12

 4.4 BAND EDGES REQUIREMENT20

 4.5 CONDUCTED EMISSIONS AT MAINS TERMINALS23

5.0 TEST EQUIPMENT LIST..... 26

TEST REPORT

1.0 TEST RESULT SUMMARY

Test Item	Test Requirement	Test Method	Result
Antenna Requirement	FCC PART 15 C Section 15.203	FCC PART 15 C Section 15.203	PASS
Occupied Bandwidth	FCC PART 15 C section 15.215(c)	ANSI C63.10: Clause 6.9	PASS
Radiated Emission	FCC PART 15 C section 15.249 (a), (d)	ANSI C63.10: Clause 6.4, 6.5 & 6.6	PASS
Band Edges Measurement	FCC PART 15 C section 15.249 (d)	ANSI C63.10: Clause 6.10	PASS
Conducted Emissions at Mains Terminals	FCC PART 15 C section 15.207	ANSI C63.10: Clause 6.2	PASS

Remark:

N/A: not applicable. Refer to the relative section for the details.

EUT: In this whole report EUT means Equipment Under Test.

Tx: In this whole report Tx (or tx) means Transmitter.

Rx: In this whole report Rx (or rx) means Receiver.

RF: In this whole report RF means Radio Frequency.

ANSI C63.10: the detail version is ANSI C63.10:2013 in the whole report.

TEST REPORT

2.0 General Description

2.1 Product Description

Operating Frequency:	5860MHz
Type of Modulation:	N/A
Number of Channels:	1 Channel
Channel Separation:	N/A
Antenna Type:	Integral
Antenna Gain:	2.3 dBi
Speciality:	5.8GHz wireless module
Function:	5.8GHz wireless module for motion sensor
Power Supply:	DC 5.0V
Power cord:	N/A

EUT channels and frequencies list:

Channel	Frequency (MHz)
1	5860

Test frequency is 5860MHz.

2.2 Related Submittal(s) Grants

This is an application for certification of:
DXX - Part 15 Low Power Communication Device Transmitter

Remaining portions are subject to the following procedures:

N/A

2.3 Test Methodology

Both AC mains line-conducted and radiated emission measurements were performed according to the procedures in ANSI C63.10. Radiated emission measurement was performed in semi-anechoic chamber and conducted emission measurement was performed in shield room. For radiated emission measurement, preliminary scans and final tests were performed in the semi-anechoic chamber to determine the worst case modes. All radiated tests were performed at an antenna to EUT distance of 3 meters, unless stated otherwise.

TEST REPORT

2.4 Test Facility

All tests were performed at:

Intertek Testing Services Shenzhen Ltd. Guangzhou Branch
Room102/104, No 203, KeZhu Road, Science City, GETDD Guangzhou, China

Except Conducted Emissions was performed at:

Room 02, & 101/E201/E301/E401/E501/E601/E701/E801 of Room 01 1-8/F., No. 7-2. Caipin Road, Science City, GETDD, Guangzhou, Guangdong, China

A2LA Certificate Number 0078.10

Intertek Testing Services Shenzhen Ltd. Guangzhou Branch is accredited by A2LA and Listed in FCC website. FCC accredited test labs may perform both Certification testing under Parts 15 and 18 and Declaration of Conformity testing.

3.0 System Test Configuration

3.1 Justification

For emissions testing, the equipment under test (EUT) setup to transmit continuously to simplify the measurement methodology. Care was taken to ensure proper power supply voltages during testing. During testing, AC power line was manipulated to produce worst case emissions. It was powered by a DC power supply.

The signal is maximized through rotation and placement in the three orthogonal axes. The antenna height and polarization are varied during the search for maximum signal level. The antenna height is varied from 1 to 4 meters. Radiated emissions are taken at three meters unless the signal level is too low for measurement at that distance. If necessary, a pre-amplifier is used and/or the test is conducted at a closer distance.

All readings are extrapolated back to the equivalent three meter reading using inverse scaling with distance. The spurious emissions more than 20 dB below the permissible value are not reported.

For an intentional radiator, the spectrum shall be investigated from the lowest radio frequency signal generated in the device, without going below 9 kHz, up to at least the frequency shown in the following table:

Frequency range of radiated emission measurements

Lowest frequency generated in the device	Upper frequency range of measurement
9 kHz to below 10 GHz	10th harmonic of highest fundamental frequency or to 40 GHz, whichever is lower
At or above 10 GHz to below 30 GHz	5th harmonic of highest fundamental frequency or to 100 GHz, whichever is lower
At or above 30 GHz	5th harmonic of highest fundamental frequency or to 200 GHz, whichever is lower, unless otherwise specified

TEST REPORT

Number of fundamental frequencies to be tested in EUT transmit band

Frequency range in which device operates	Number of frequencies	Location in frequency range of operation
1 MHz or less	1	Middle
1 MHz to 10 MHz	2	1 near top and 1 near bottom
More than 10 MHz	3	1 near top, 1 near middle and 1 near bottom

3.2 EUT Exercising Software

N/A

3.3 Special Accessories

No special accessories used.

3.4 Measurement Uncertainty

No.	Item	Measurement Uncertainty
1	20 dB Bandwidth	2.3%
	6dB Bandwidth	
	99% Bandwidth	
2	Carrier Frequencies Separated	2.3%
3	Dwell Time	1.2%
4	Maximum Peak Conducted Output Power	1.5dB
5	Peak Power Spectral Density	1.5dB
6	Out of Band Conducted Emissions	1.5dB
7	Band edges measurement	1.5dB
8	Radiated Emissions	4.7 dB (25 MHz-1 GHz)
		4.8 dB (1 GHz-18 GHz)
		5.21dB (18GZH-26GHz)
9	Conducted Emissions at Mains Terminals	2.58dB
10	Temperature	0.5 °C
11	Humidity	0.4 %
12	Time	1.2%

The measurement uncertainty describes the overall uncertainty of the given measured value during the operation of the EUT.

TEST REPORT

Measurement uncertainty is calculated in accordance with ETSI TR 100 028-2001.
The measurement uncertainty is given with a confidence of 95%, k=2.

When determining of the test conclusion, the Measurement Uncertainty of test has been considered.

Uncertainty and Compliance – Unless the standard specifically states that measured values are to be extended by the measurement uncertainty in determining compliance, all compliance determinations are based on the actual measured value

3.5 Equipment Modification

Any modifications installed previous to testing by Airtouch (Shanghai) Intelligent Technology Co., Ltd will be incorporated in each production model sold / leased in the United States.

No modifications were installed by Intertek Testing Services Shenzhen Ltd. Guangzhou Branch.

3.6 Support Equipment List and Description

This product was tested with corresponding support equipment as below:

Support Equipment

Description	Manufacturer	Model No.	SN/Version	Supplied by
DC Power Supply	N/A	IT6721	SA040-22	Intertek

TEST REPORT

4.0 Measurement Results

4.1 Antenna Requirement

Standard requirement:

15.203 requirement:

For intentional device. According to 15.203 an intentional radiator shall be designed to Ensure that no antenna other than that furnished by the responsible party shall be used with the device.

EUT Antenna

The antenna is an integral antenna and no consideration of replacement. The best case gain of the antenna is 2.3 dBi.

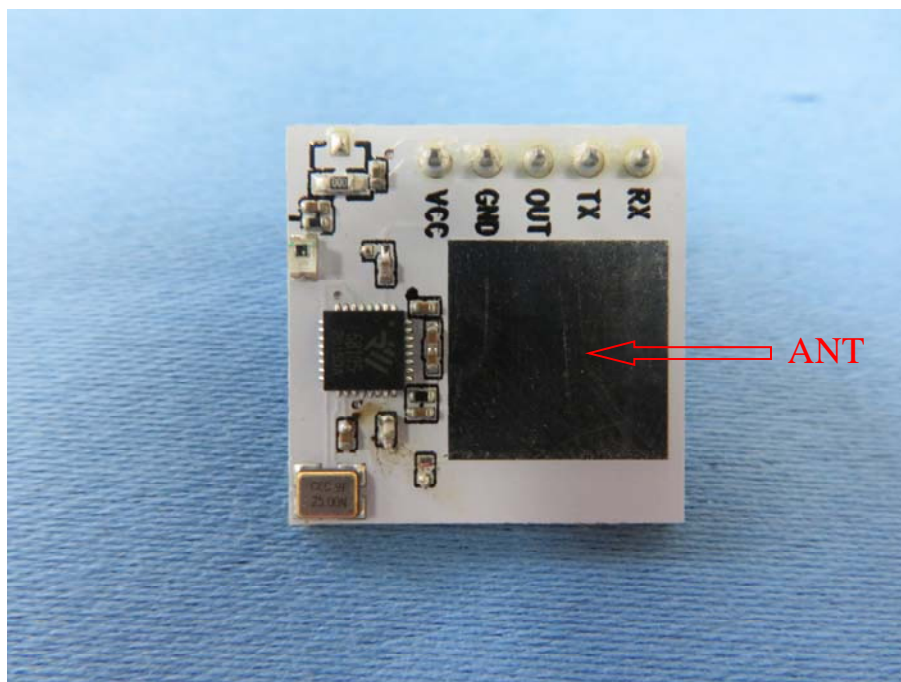

TEST REPORT

4.2 Occupied Bandwidth

- Test Requirement: FCC PART 15 C section 15.215(c)
(c) Intentional radiators operating under the alternative provisions to the general emission limits, as contained in §§ 15.217 through 15.257 and in subpart E of this part, must be designed to ensure that the 20dB bandwidth of the emission, or whatever bandwidth may otherwise be specified in the specific rule section under which the equipment operates, is contained within the frequency band designated in the rule section under which the equipment is operated.
- Test Method: ANSI C63.10: Clause 6.9
- Test Status: Pre-Scan has been conducted to determine the worst-case mode from all possible combinations between available modulations, data rates and antenna ports (if EUT with antenna diversity architecture). The highest, middle and the lowest channels were selected for the final test as listed below.
- Test Configuration:

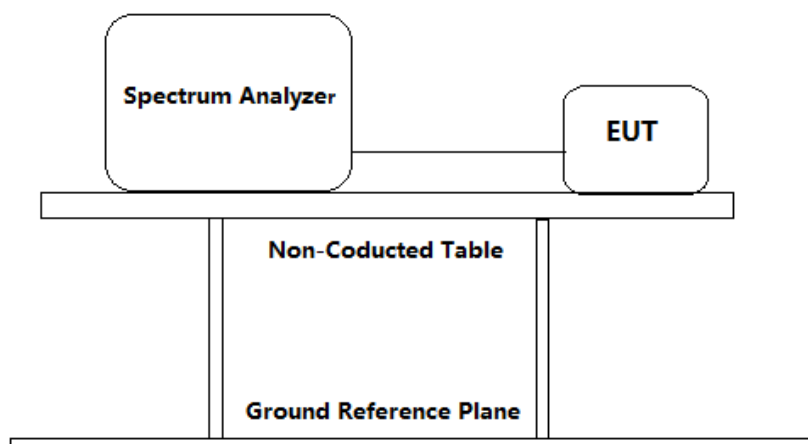

- Test Procedure:
- The transmitter was operated at its maximum carrier power measured under normal test conditions.
- The instrument center frequency was set to the nominal EUT channel center frequency. The frequency span for the spectrum analyzer was between 1.5 times and 5.0 times the OBW(20 dB Bandwidth).
 - The nominal IF filter bandwidth (3 dB RBW) was in the range of 1% to 5% of the OBW, and VBW was approximately three times the RBW.
 - Set the reference level of the instrument as required, keeping the signal from exceeding the maximum input mixer level for linear operation. In general, the peak of the spectral envelope was more than $[10 \log (OBW/RBW)]$ below the reference level.
 - Step a) through step c) might require iteration to adjust within the specified range.
 - The dynamic range of the instrument at the selected RBW was more than 10 dB below

TEST REPORT

the target “-20 dB down” requirement; that is, if the requirement calls for measuring the -20 dB OBW, the instrument noise floor at the selected RBW was at least 30 dB below the reference value.

- f) Peak detection and max hold mode (until the trace stabilizes) was used.
- g) Used the 20dB bandwidth function of the instrument and reported the measured bandwidth.
- h) The occupied bandwidth was reported by providing plot(s) of the measuring instrument display; the plot axes and the scale units per division was clearly labeled. Tabular data was reported in addition to the plot(s).

Used Test Equipment List

Spectrum Analyzer. Refer to Clause 5 Test Equipment List for details.

20 dB bandwidth:

Channel No.	Frequency (MHz)	Measured 20dB bandwidth (kHz)	Limit (kHz)	Result
1	5860	25.18	/	Pass

Result plot as follows:

5.860GHz:

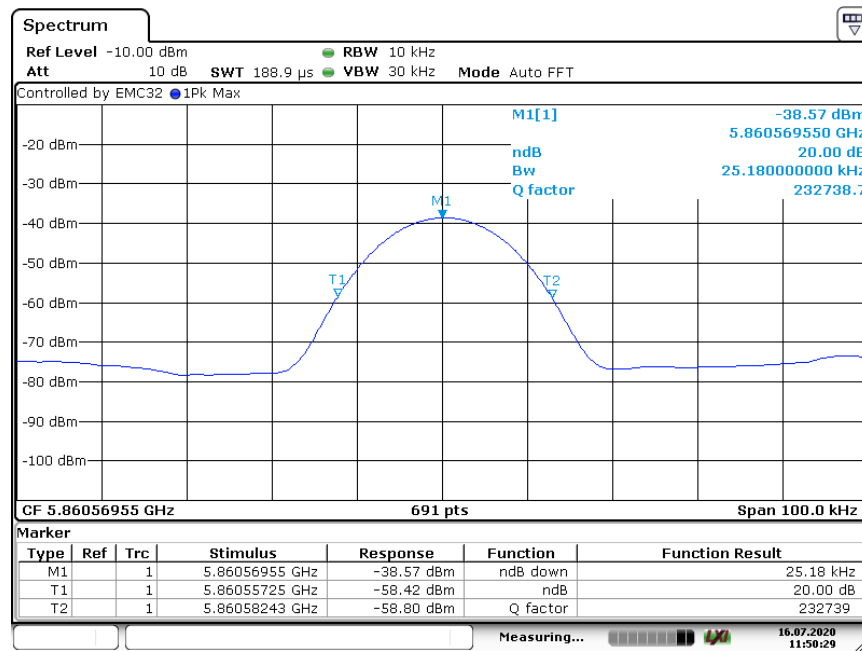

Date: 16.JUL.2020 11:50:29

TEST REPORT

4.3 Radiated Emission

Test Requirement:

FCC PART 15 C section 15.249 (a), (d)

(a) Except as provided in paragraph (b) of this section, the field strength of emissions from intentional radiators operated within these frequency bands shall comply with the following:

Fundamental Frequency (MHz)	Field Strength of Fundamental (dBµV/m @ 3m)	Field Strength of Harmonics (dBµV/m @ 3m)
902 to 928	94.0	54.0
2400 to 2483.5	94.0	54.0
5725 to 5875	94.0	54.0

Note: The limits shown in the above table are based on measurements using an average detector, except for the fundamental emission in the frequency band 902-928 MHz, which is based on measurements using a CISPR quasi-peak detector.

(d) Emissions radiated outside of the specified frequency bands, except for harmonics, shall be attenuated by at least 50 dB below the level of the fundamental or to the general radiated emission limits in § 15.209, whichever is the lesser attenuation.

Test Method:

ANSI C63.10: Clause 6.4, 6.5 and 6.6

Test Status:

Pre-Scan has been conducted to determine the worst-case mode from all possible combinations between available modulations, data rates and antenna ports (if EUT with antenna diversity architecture). The lowest, middle and the lowest channels were selected for the final test as listed below.

Test site:

Measurement Distance: 3m (Semi-Anechoic Chamber)

Limit:

The field strength of radiated emission outside of the specified frequency bands, except for harmonics at a distance of 3 meters shall not exceed the following values:

Frequency (MHz)	Field Strength (dBµV/m @ 3m)
30-88	40.0
88-216	43.5
216-960	46.0
Above 960	54.0

Detector:

RBW for Peak and Quasi-Peak value:

200 Hz for 9 kHz to 150 kHz

9 kHz for 150 kHz to 30 MHz

120 kHz for 30 MHz to 1GHz

TEST REPORT

RBW = 1 MHz for $f \geq 1$ GHz

VBW \geq RBW

Sweep = auto

Detector function = peak for $f \geq 1$ GHz, QP for $f < 1$ GHz

Trace = max hold

Field Strength
Calculation:

The field strength is calculated by adding the reading on the Spectrum Analyzer to the factors associated with preamplifiers (if any), antennas, cables, pulse desensitization and average factors (when specified limit is in average and measurements are made with peak detectors). A sample calculation is included below:

$$FS = RA + AF + CF - AG + PD + AV$$

$$FS = RA + \text{Correct Factor} + AV$$

$$FS = \text{Field Strength in dB}\mu\text{V/m}$$

RA = Receiver Amplitude (including preamplifier) in dB μ V

AF = Antenna Factor in dB

CF = Cable Attenuation Factor in dB

AG = Amplifier Gain in dB

PD = Pulse Desensitization in dB

AV = Average Factor in -dB

$$\text{Correct Factor} = AF + CF - AG + PD$$

Where:

In the radiated emission table which follows, the reading shown on the data table may reflect the preamplifier gain. An example of the calculations, where the reading does not reflect the preamplifier gain, follows:

$$FS = RA + AF + CF - AG + PD + AV$$

Assume a receiver reading of 62.0 dB μ V is obtained. The antenna factor of 7.4 dB and cable factor of 1.6 dB is added. The amplifier gain of 29 dB is subtracted. The pulse desensitization factor of the spectrum analyzer was 0 dB, and the resultant average factor was -10 dB. The net field strength for comparison to the appropriate emission limit is 32 dB μ V/m.

$$RA = 62.0 \text{ dB}\mu\text{V}$$

$$AF = 7.4 \text{ dB}$$

$$CF = 1.6 \text{ dB}$$

$$AG = 29.0 \text{ dB}$$

$$PD = 0 \text{ dB}$$

$$AV = -10 \text{ dB}$$

$$\text{Correct Factor} = 7.4 + 1.6 - 29.0 + 0 = -20 \text{ dB}$$

$$FS = 62 + (-20) + (-10) = 32 \text{ dB}\mu\text{V/m}$$

TEST REPORT

Section 15.205 Restricted bands of operation.

MHz	MHz	MHz	GHz
0.090 - 0.110	16.42 - 16.423	399.9 - 410	4.5 - 5.15
10.495 - 0.505	16.69475 - 16.69525	608 - 614	5.35 - 5.46
2.1735 - 2.1905	16.80425 - 16.80475	960 - 1240	7.25 - 7.75
4.125 - 4.128	25.5 - 25.67	1300 - 1427	8.025 - 8.5
4.17725 - 4.17775	37.5 - 38.25	1435 - 1626.5	9.0 - 9.2
4.20725 - 4.20775	73 - 74.6	1645.5 - 1646.5	9.3 - 9.5
6.215 - 6.218	74.8 - 75.2	1660 - 1710	10.6 - 12.7
6.26775 - 6.26825	108 - 121.94	1718.8 - 1722.2	13.25 - 13.4
6.31175 - 6.31225	123 - 138	2200 - 2300	14.47 - 14.5
8.291 - 8.294	149.9 - 150.05	2310 - 2390	15.35 - 16.2
8.362 - 8.366	156.52475 -	2483.5 - 2500	17.7 - 21.4
8.37625 - 8.38675	156.52525	2655 - 2900	22.01 - 23.12
8.41425 - 8.41475	156.7 - 156.9	3260 - 3267	23.6 - 24.0
12.29 - 12.293	162.0125 - 167.17	3332 - 3339	31.2 - 31.8
12.51975 - 12.52025	167.72 - 173.2	3345.8 - 3358	36.43 - 36.5
12.57675 - 12.57725	240 - 285	3600 - 4400	
13.36 - 13.41	322 - 335.4		

Test Configuration:

1) 9 kHz to 30 MHz emissions:

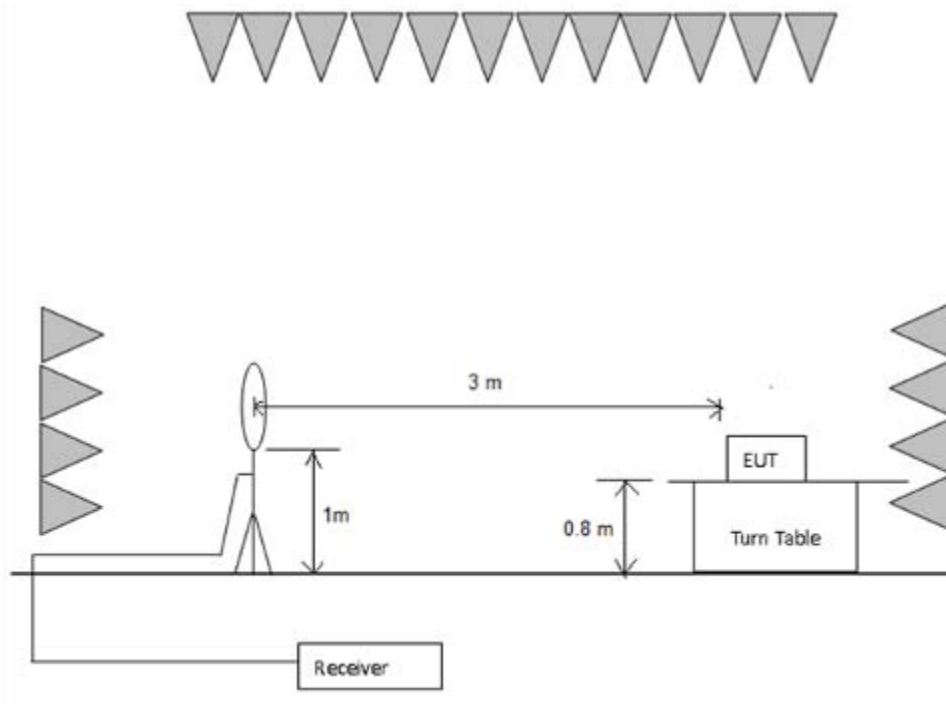

TEST REPORT

2) 30 MHz to 1 GHz emissions:

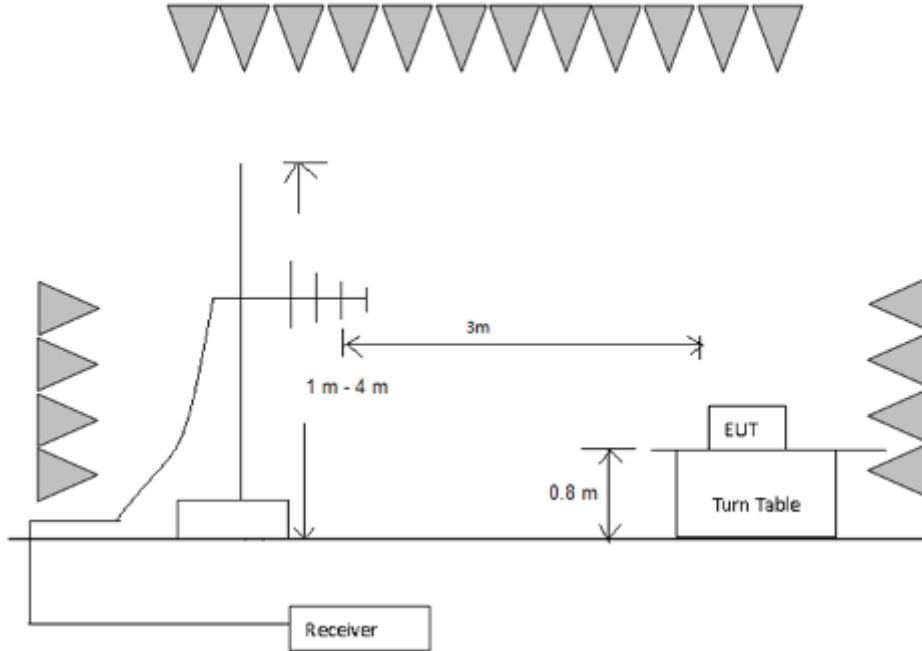

3) 1 GHz to 40 GHz emissions:

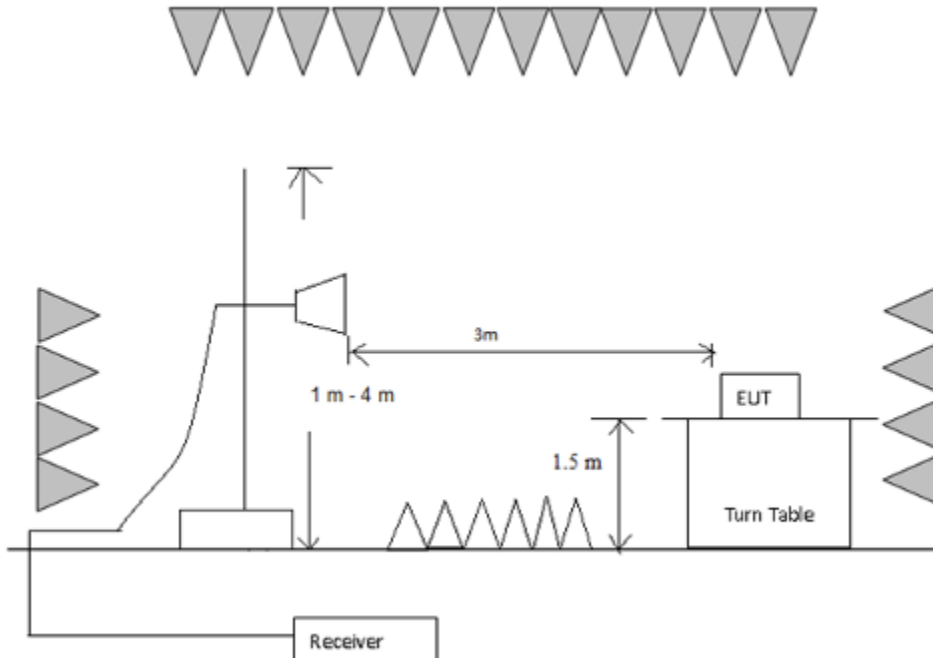

TEST REPORT

Test Procedure:

1) 9 kHz to 30 MHz emissions:

For testing performed with the loop antenna. The centre of the loop was positioned 1 m above the ground and positioned with its plane vertical at the special distance from the EUT. During testing the loop was rotated about its vertical axis for maximum response at each azimuth and also investigated with the loop positioned in the horizontal plane.

2) 30 MHz to 1 GHz emissions:

For testing performed with the bi-log type antenna. The measurement is performed with the EUT rotated 360°, the antenna height scanned between 1m and 4m, and the antenna rotated to repeat the measurement for both the horizontal and vertical antenna polarizations.

3) 1 GHz to 40 GHz emissions:

Test site with RF absorbing material covering the ground plane that met the site validation criterion called out in CISPR 16-1-4:2010 was used to perform radiated emission test above 1 GHz.

For testing performed with the horn antenna. The measurement is performed with the EUT rotated 360°, the antenna height scanned between 1m and 4m, and the antenna rotated to repeat the measurement for both the horizontal and vertical antenna polarizations.

4) The receiver was scanned from 9 kHz to 40 GHz. When an emission was found, the table was rotated to produce the maximum signal strength. An initial pre-scan was performed for in peak detection mode using the receiver. The EUT was measured for both the Horizontal and Vertical polarities and performed a pre-test three orthogonal planes. For intentional radiators, measurements of the variation of the input power or the radiated signal level of the fundamental frequency component of the emission, as appropriate, shall be performed with the supply voltage varied between 85% and 115% of the nominal rated supply voltage. The worst case emissions were reported.

Used Test Equipment List:

3m Semi-Anechoic Chamber, EMI Test Receiver (9 kHz~7 GHz), Signal and Spectrum Analyzer (10 Hz~40 GHz), Loop antenna (9 kHz-30 MHz). TRILOG Super Broadband test Antenna(30 MHz-3 GHz) (RX), Bouble-Ridged Waveguide Horn Antenna (800 MHz-18 GHz)(RX), High Frequency Antenna & preamplifier(18 GHz~26.5 GHz) (RX) and High Frequency Antenna & preamplifier(26 GHz~40 GHz) (RX). Refer to Clause 5 Test Equipment List for details.

9 kHz~30 MHz Field Strength of Unwanted Emissions. Quasi-Peak Measurement

The measurements with active loop antenna were greater than 20dB below the limit, so the test data were not recorded in the test report.

TEST REPORT

Radiated Emissions (Below 1GHz)

Operation Frequency: 5860MHz
Horizontal

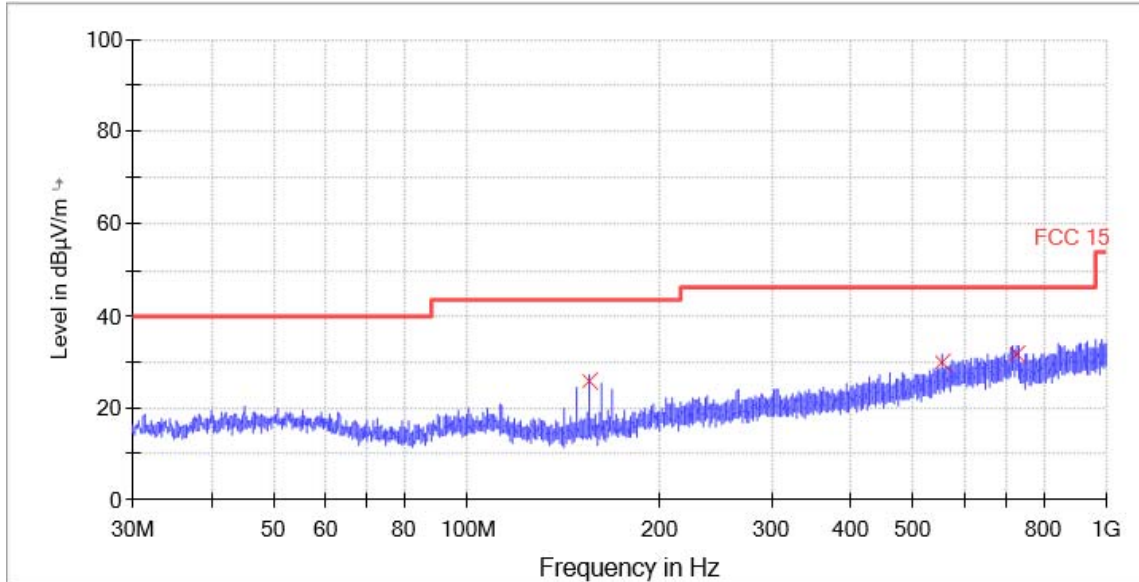

QP

Frequency (MHz)	Quasi Peak (dBµV/m)	Bandwidth (kHz)	Pol	Corr. (dB)	Margin - QPK (dB)	Limit - QPK (dBµV/m)
155.640000	25.8	120.000	H	10.2	17.7	43.5
553.800000	29.8	120.000	H	20.9	16.2	46.0
725.240000	31.9	120.000	H	23.3	14.1	46.0

1. Corr. (dB) = Antenna Factor (dB) + Cable Loss (dB)
2. Quasi Peak (dBµV/m) = Corr. (dB) + Read Level (dBµV)
3. Margin (dB) = Limit QPK (dBµV/m) – Quasi Peak (dBµV/m)

TEST REPORT

Operation Frequency: 5860MHz
Vertical

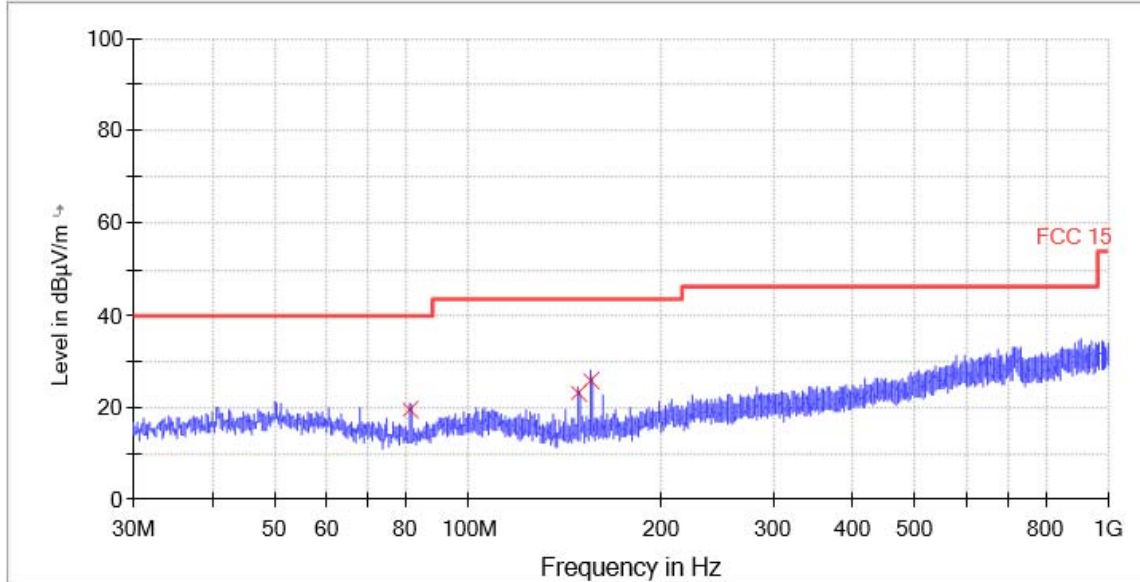

QP

Frequency (MHz)	Quasi Peak (dBµV/m)	Bandwidth (kHz)	Pol	Corr. (dB)	Margin - QPK (dB)	Limit - QPK (dBµV/m)
81.360000	19.6	120.000	V	10.0	20.4	40.0
149.120000	23.0	120.000	V	9.9	20.5	43.5
155.920000	26.0	120.000	V	10.2	17.5	43.5

1. Corr. (dB) = Antenna Factor (dB) + Cable Loss (dB)
2. Quasi Peak (dBµV/m) = Corr. (dB) + Read Level (dBµV)
3. Margin (dB) = Limit QPK (dBµV/m) – Quasi Peak (dBµV/m)

TEST REPORT

Radiated Emissions (Above 1GHz)

PK Measurement:

Frequency (MHz)	PK Reading Level (dBµV)	Correction factors (dB/m)	PK Emission Level (dBµV/m)	PK Limit (dBµV/m)	Antenna polarization
5860.47	87.9	0.5	88.4	114	Horizontal
11721.15	46.1	6.5	52.6	74	Horizontal
5860.49	77.6	0.5	78.1	114	Vertical
11721.68	46.0	6.5	52.5	74	Vertical

AV Measurement:

Frequency (MHz)	AV Reading Level (dBµV)	Correction factors (dB/m)	AV Emission Level (dBµV/m)	AV Limit (dBµV/m)	Antenna polarization
5860.47	/	0.5	/	94	Horizontal
11721.15	/	6.5	/	54	Horizontal
5860.49	/	0.5	/	94	Vertical
11721.68	/	6.5	/	54	Vertical

The field strength is calculated by adding the Antenna Factor, Cable Factor & Preamplifier. The basic equation with a sample calculation is as follows:

Final Test Level = Receiver Reading + Correction Factor

Correction Factor = Antenna Factor + Cable Loss – Preamplifier Factor.

- Notes:
1. AT frequencies equal to or less than 1000MHz, quasi-peak detector was used, above 1000MHz, Peak detector was used.
 2. All measurements were made at 3 meter.
 3. Horn antenna is used for the emission over 1000MHz.
 4. When Peak emission level was below AV limit, the AV emission level did not be recorded.
 5. Above 18GHz, not any emission have been detected.

TEST REPORT

4.4 Band Edges Requirement

Test Requirement: FCC PART 15 C section 15.249 (d)
(d) Emissions radiated outside of the specified frequency bands, except for harmonics, shall be attenuated by at least 50 dB below the level of the fundamental or to the general radiated emission limits in § 15.209, whichever is the lesser attenuation.

Frequency Band: 2400 MHz to 2483.5 MHz
Test Method: ANSI C63.10: Clause 6.10
Test Status: Pre-Scan has been conducted to determine the worst-case mode from all possible combinations between available modulations, data rates and antenna ports (if EUT with antenna diversity architecture). The lowest, middle and the highest channels were selected for the final test as listed below.

Test Configuration:

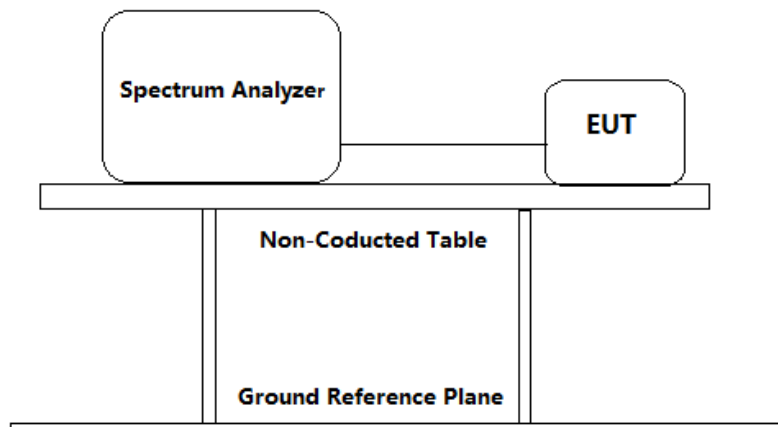

Used Test Equipment List:

3m Semi-Anechoic Chamber, EMI Test Receiver (9 kHz~7 GHz), Signal and Spectrum Analyzer (10 Hz~40 GHz), Loop antenna (9 kHz-30 MHz). TRILOG Super Broadband test Antenna(30 MHz-3 GHz) (RX), Double-Ridged Waveguide Horn Antenna (800 MHz-18 GHz)(RX) and High Frequency Antenna & preamplifier(18 GHz~26.5 GHz) (RX). Refer to Clause 5 Test Equipment List for details.

TEST REPORT

Test result with plots as follows:

Operation Frequency: 5860MHz
Horizontal

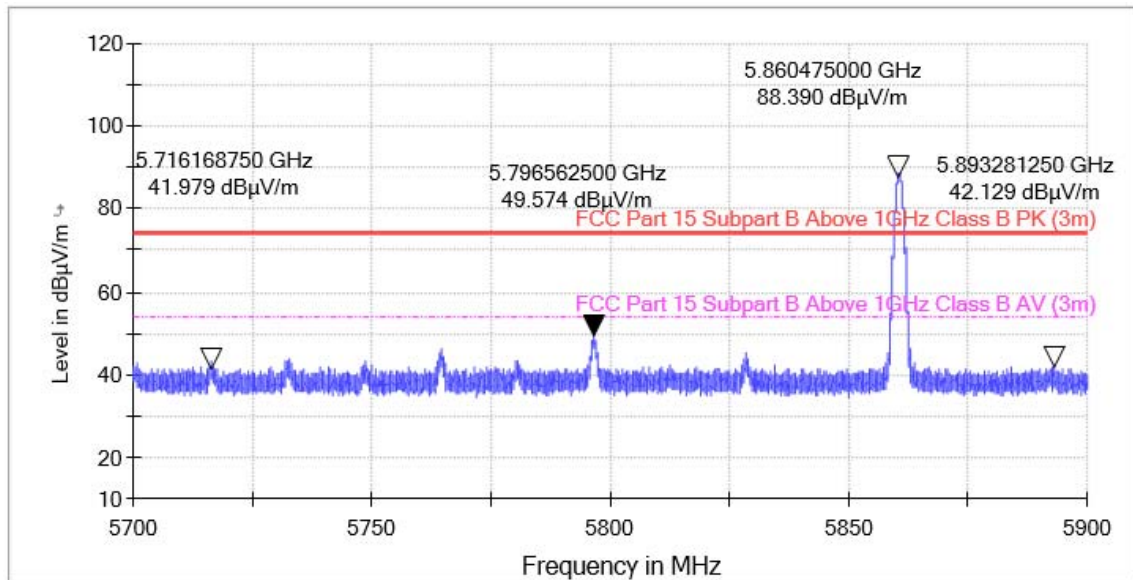

Frequency (MHz)	PK Reading Level (dBµV)	Correction factors (dB/m)	PK Emission Level (dBµV/m)	AV Limit (dBµV/m)
5716.17	41.7	0.3	42.0	54.0
5893.28	41.6	0.5	42.1	54.0

Remark:

Final Test Level = Receiver Reading + Correction Factor

Correction Factor = Antenna Factor + Cable Loss – Preamplifier Factor.

When Peak emission level was below AV limit, the AV emission level did not be recorded.

TEST REPORT

Operation Frequency: 5860MHz
Vertical

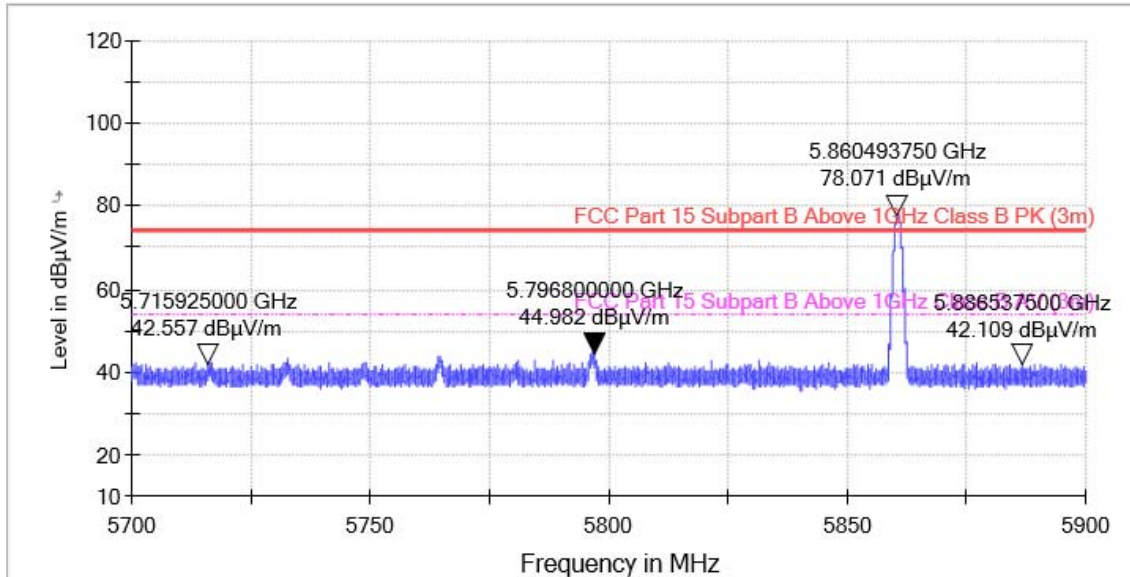

Frequency (MHz)	PK Reading Level (dBµV)	Correction factors (dB/m)	PK Emission Level (dBµV/m)	AV Limit (dBµV/m)
5715.92	42.3	0.3	42.6	54.0
5886.53	41.6	0.5	42.1	54.0

Remark:

Final Test Level = Receiver Reading + Correction Factor

Correction Factor = Antenna Factor + Cable Loss – Preamplifier Factor.

When Peak emission level was below AV limit, the AV emission level did not be recorded.

TEST REPORT

4.5 Conducted Emissions at Mains Terminals

Test Configuration:

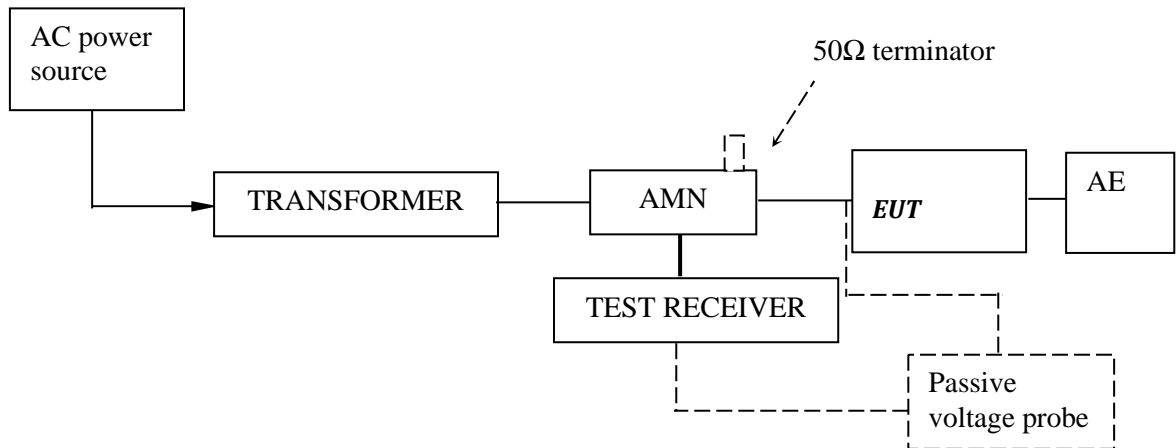

Test Setup and Procedure:

Test was performed according to ANSI C63.10 Clause 6.2. The EUT was set to achieve the maximum emission level. The mains terminal disturbance voltage was measured with the EUT in a shielded room. The EUT was connected to AC power source through an Artificial Mains Network which provides a 50Ω linear impedance. Artificial hand is used if appropriate (for handheld apparatus). The load/control terminal disturbance voltage was measured with passive voltage probe if appropriate.

The table-top EUT was placed on a 0.8m high non-metallic table above earthed ground plane (Ground Reference Plane). And for floor standing EUT, was placed on a 0.1m high non-metallic supported on GRP. The EUT keeps a distance of at least 0.8m from any other of the metallic surface. The Artificial Mains Network is situated at a distance of 0.8m from the EUT.

During the test, mains lead of EUT excess 0.8m was folded back and forth parallel to the lead so as to form a horizontal bundle with a length between 0.3m and 0.4m

The bandwidth of test receiver was set at 9 kHz. The frequency range from 150 kHz to 30MHz was checked.

TEST REPORT

Test Data and Curve

At main terminal: Pass

Tested Wire: Live

Operation Mode: transmitting on 5860MHz

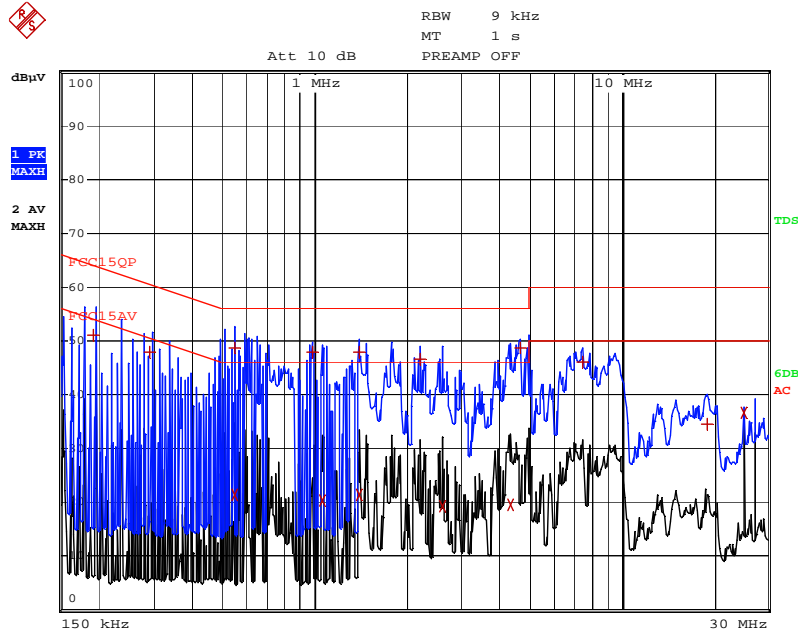

EDIT PEAK LIST (Final Measurement Results)				
TRACE		FREQUENCY	LEVEL dBµV	DELTA LIMIT dB
Trace1:	FCC15QP			
Trace2:	FCC15AV			
Trace3:	---			
1	Quasi Peak	194 kHz	51.08 L1	-12.78
1	Quasi Peak	294 kHz	47.96 L1	-12.45
1	Quasi Peak	550 kHz	48.68 L1	-7.31
2	Average	550 kHz	21.50 L1	-24.49
1	Quasi Peak	982 kHz	47.87 L1	-8.12
2	Average	1.062 MHz	20.26 L1	-25.73
1	Quasi Peak	1.394 MHz	47.80 L1	-8.19
2	Average	1.394 MHz	21.50 L1	-24.49
1	Quasi Peak	2.198 MHz	46.69 L1	-9.30
2	Average	2.63 MHz	19.32 L1	-26.67
2	Average	4.378 MHz	19.44 L1	-26.55
1	Quasi Peak	4.67 MHz	48.62 L1	-7.38
1	Quasi Peak	7.458 MHz	45.93 L1	-14.06
1	Quasi Peak	18.994 MHz	34.51 L1	-25.48
2	Average	25.002 MHz	36.68 L1	-13.31

Remark:

1. Corr. (dB) = LISN Factor (dB) + Cable Loss (dB)
2. Level (dBµV) = Corr. (dB) + Read Level (dBµV)
3. Delta Limit (dB) = Level (dBµV)-Limit (dBµV)

TEST REPORT

Tested Wire: Neutral

Operation Mode: transmitting on 5860MHz

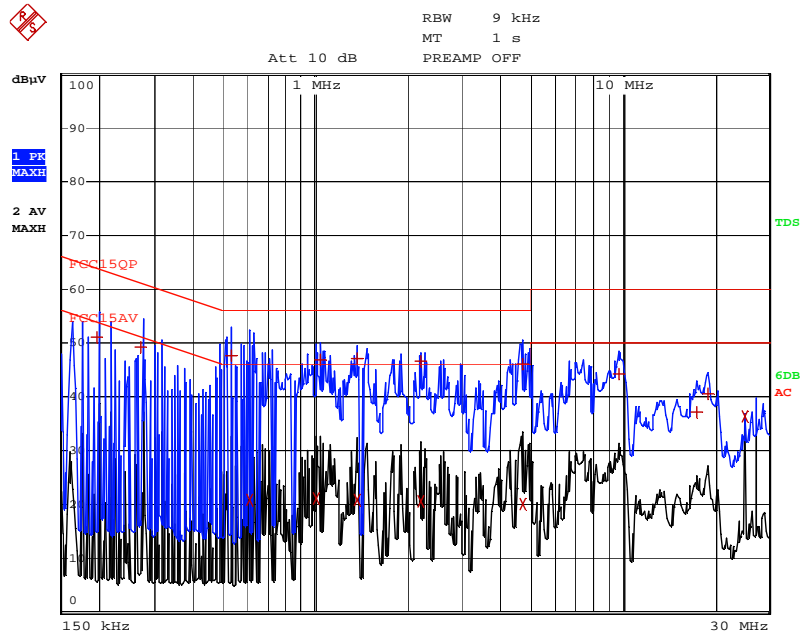

EDIT PEAK LIST (Final Measurement Results)				
TRACE	FREQUENCY	LEVEL dBµV		DELTA LIMIT dB
Trace1:	FCC15QP			
Trace2:	FCC15AV			
Trace3:	---			
1 Quasi Peak	198 kHz	51.00 L1		-12.68
1 Quasi Peak	274 kHz	49.09 L1		-11.90
1 Quasi Peak	530 kHz	47.58 L1		-8.41
2 Average	610 kHz	20.91 L1		-25.08
2 Average	1.002 MHz	21.17 L1		-24.82
1 Quasi Peak	1.042 MHz	46.96 L1		-9.03
1 Quasi Peak	1.374 MHz	47.04 L1		-8.96
2 Average	1.374 MHz	20.84 L1		-25.15
1 Quasi Peak	2.198 MHz	46.55 L1		-9.44
2 Average	2.198 MHz	20.51 L1		-25.48
1 Quasi Peak	4.75 MHz	46.16 L1		-9.83
2 Average	4.75 MHz	19.97 L1		-26.02
1 Quasi Peak	9.794 MHz	44.30 L1		-15.69
1 Quasi Peak	17.546 MHz	37.03 L1		-22.96
1 Quasi Peak	18.998 MHz	40.48 L1		-19.51
2 Average	25.002 MHz	36.46 L1		-13.53

Remark:

1. Corr. (dB) = LISN Factor (dB) + Cable Loss (dB)
2. Level (dBµV) = Corr. (dB) + Read Level (dBµV)
3. Delta Limit (dB) = Level (dBµV)-Limit (dBµV)

TEST REPORT

5.0 Test Equipment List

Radiated Emission/Radio

Equipment No.	Equipment	Model	Manufacturer	Cal. Due date (YYYY-MM-DD)	Calibration Interval
EM030-04	3m Semi-Anechoic Chamber	9×6×6 m ³	ETS·LINDGREN	4/10/2021	1Y
EM031-02	EMI Test Receiver (9 kHz~7 GHz)	R&S ESR7	R&S	10/22/2020	1Y
EM031-03	Signal and Spectrum Analyzer (10 Hz~40 GHz)	R&S FSV40	R&S	9/8/2020	1Y
EM011-04	Loop antenna (9 kHz-30 MHz)	HFH2-Z2	R&S	6/18/2021	1Y
EM061-03	TRILOG Super Broadband test Antenna (30 MHz-1.5 GHz) (TX)	VULB 9161	SCHWARZBECK	6/18/2021	1Y
EM033-01	TRILOG Super Broadband test Antenna(30 MHz-3 GHz) (RX)	VULB 9163	SCHWARZBECK	9/19/2020	1Y
EM033-02	Bouble-Ridged Waveguide Horn Antenna (800 MHz-18 GHz)(RX)	R&S HF907	R&S	6/18/2021	1Y
EM033-03	High Frequency Antenna & preamplifier(18 GHz~26.5 GHz) (RX)	R&S SCU-26	R&S	4/24/2021	1Y
EM033-04	High Frequency Antenna & preamplifier (26 GHz-40 GHz)	R&S SCU-40	R&S	4/24/2021	1Y
EM031-02-01	Coaxial cable(9 kHz-1 GHz)	N/A	R&S	4/12/2021	1Y
EM033-02-02	Coaxial cable(1 GHz-18 GHz)	N/A	R&S	4/12/2021	1Y
EM033-04-02	Coaxial cable(18 GHz~40 GHz)	N/A	R&S	4/24/2021	1Y
EM031-01	Signal Generator (9 kHz~6 GHz)	SMB100A	R&S	7/22/2021	1Y
EM040-01	Band Reject/Notch Filter	WRHFV	Wainwright	N/A	1Y
EM040-02	Band Reject/Notch Filter	WRCGV	Wainwright	N/A	1Y
EM040-03	Band Reject/Notch Filter	WRCGV	Wainwright	N/A	1Y
EM022-03	2.45 GHz Filter	BRM50702	Micro-Tronics	5/10/2021	1Y
SA016-16	Programmable Temperature & Humidity Test Chamber	MHU-800LJ	TERCHY	10/13/2020	1Y
SA016-22	Climatic Test Chamber	C7-1500	Vötsch	11/10/2020	1Y
SA012-74	Digital Multimeter	FLUKE175	FLUKE	10/13/2020	1Y
EM010-01	Regulated DC Power supply	PAB-3003A	GUANHUA	N/A	1Y
SA040-22	Regulated DC Power supply	IT6721	ITECH	9/8/2020	1Y
EM084-06	Audio Analyzer	8903B	HP	4/15/2021	1Y
EM045-01-01	EMC32 software (RE/RS)	V10.01.00	R&S	N/A	N/A
EM045-01-09	EMC32 software (328/893)	V9.26.01	R&S	N/A	N/A

Conducted emission at the mains terminals

Equipment No.	Equipment	Model	Manufacturer	Cal. Due date (YYYY-MM-DD)	Calibration Interval
EM080-05	EMI receiver	ESCI	R&S	7/19/2021	1Y
EM006-05	LISN	ENV216	R&S	6/7/2021	1Y
EM006-06	LISN	ENV216	R&S	9/8/2020	1Y
EM006-06-01	Coaxial cable	/	R&S	4/12/2021	1Y
EM004-04	EMC shield Room	8m×3m×3m	Zhongyu	1/5/2021	1Y

*****End of the test report*****