



AT58L4LDB-2020
5.8GHz
Radar Sensor Module

Version: 1.1

Content

Abstract.....	3
Module illustration.....	3
Input output interface.....	4
Module dimension and connector location.....	5
Electric characteristics.....	5
Operation mode, sensing time and sensing distance adjustments.....	6
PD detection.....	6
Module power-up sequence.....	6
Sensing distance.....	7
Attention.....	7
Revision History.....	8

Abstract

AT58L4LDB-2020 is a radar sensor module in 5.8GHz with configurable power consumption. In normal mode the power consumption is about 13mA while 30uA in lower power mode. The module dimension is 20mm*20mm. The module adopts Airtouch's AT58LP1T1RDB IC which highly integrates the microwave ckt, IF amplifier and signal process unit, with embedded patch antenna which minimizes the overall module dimension with optimized performance and regulatory compliance. These features facilitates the applications in portable lighting and camera wake-up fields for non-fixed frequency solutions upgrades and for cost-down option in conventional 5.8GHz microwave solutions upgrades.

Module illustration

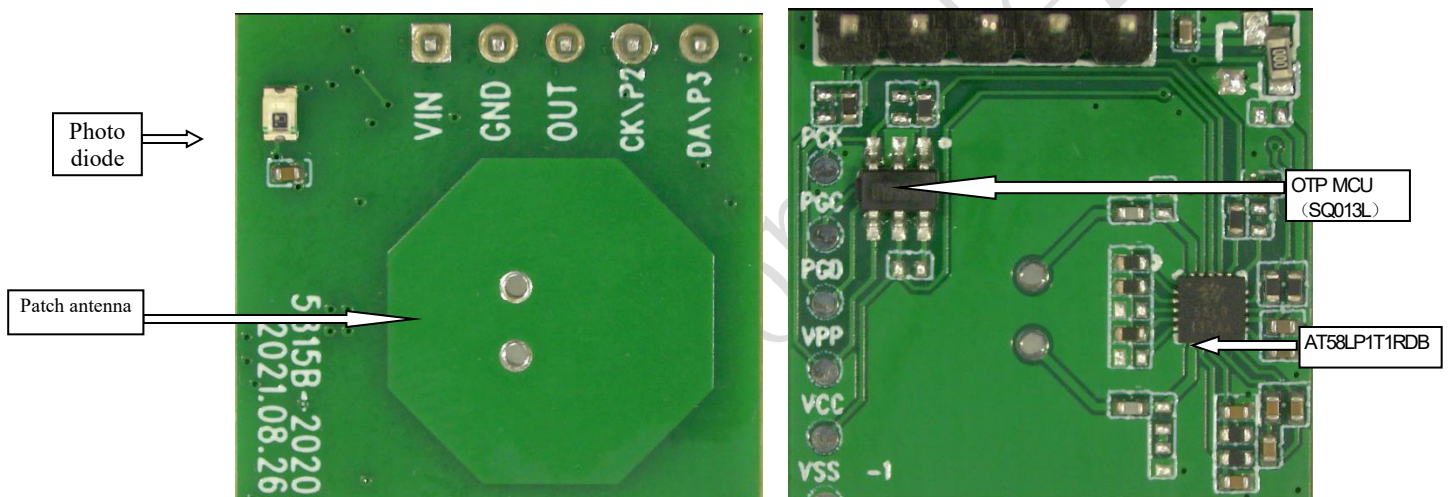

Plot. 1 AT58L4LDB-2020 module

Input output interface

The module reserves a 5-pin 2.54mm pin-pitch connector: VCC、GND、OUT、SCL and SDA. The sensing distance and delay time are adjustable by either on-board resistors setting on the module or registers configuration by external MCU. Below table is the 5-pin definition:

Pin	Function	Remark
VIN	Power supply	When LDO DNE, external DC power supply ranges from 2.7~4.8V. If LDO is pop'ed, the DC supply is LDO dependent.
GND	GND	
OUT	O/P signal	Output level (0V/3.3V) or IF signal
SCL	I/O	Connect to OTP or AT58L4LDB-2020's SCL
SDA	I/O	Connect to OTP or AT58L4LDB-2020's SDA

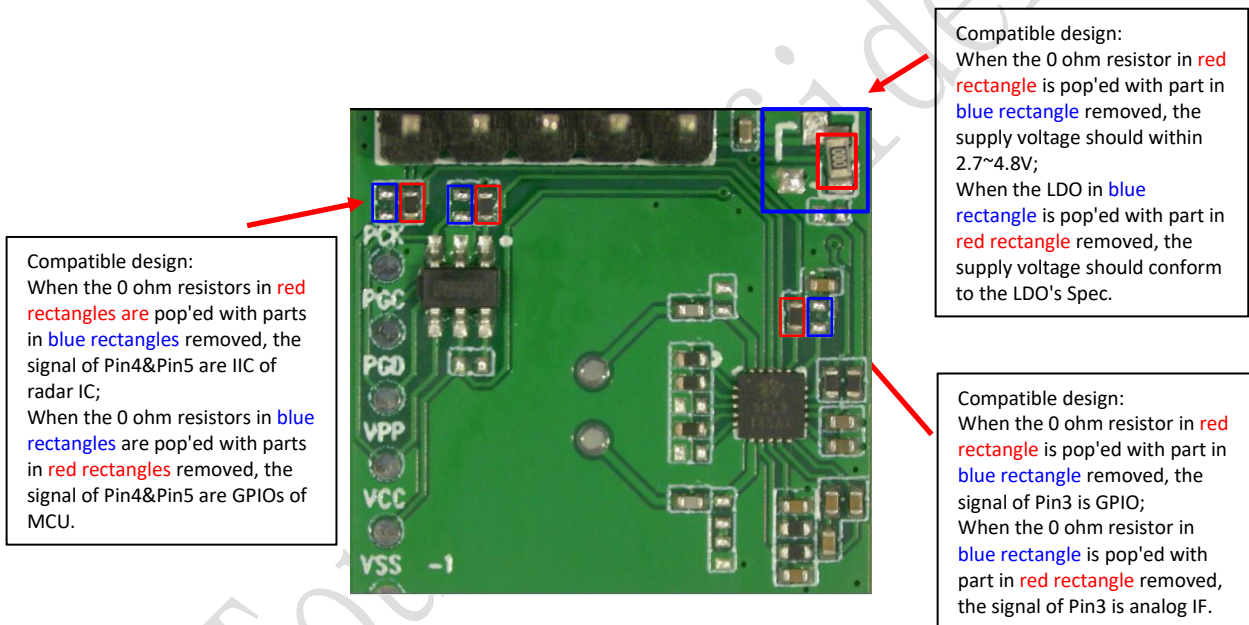

Plot. AT58L4LDB-2020 Module design detail

Module dimension and connector location

Plot. 3 illustrates the module dimension and connector location , pin pitch is 2.0mm. The module dimension is 20mm*20mm and PCB thickness is 1.6mm. By default the connector is NC.

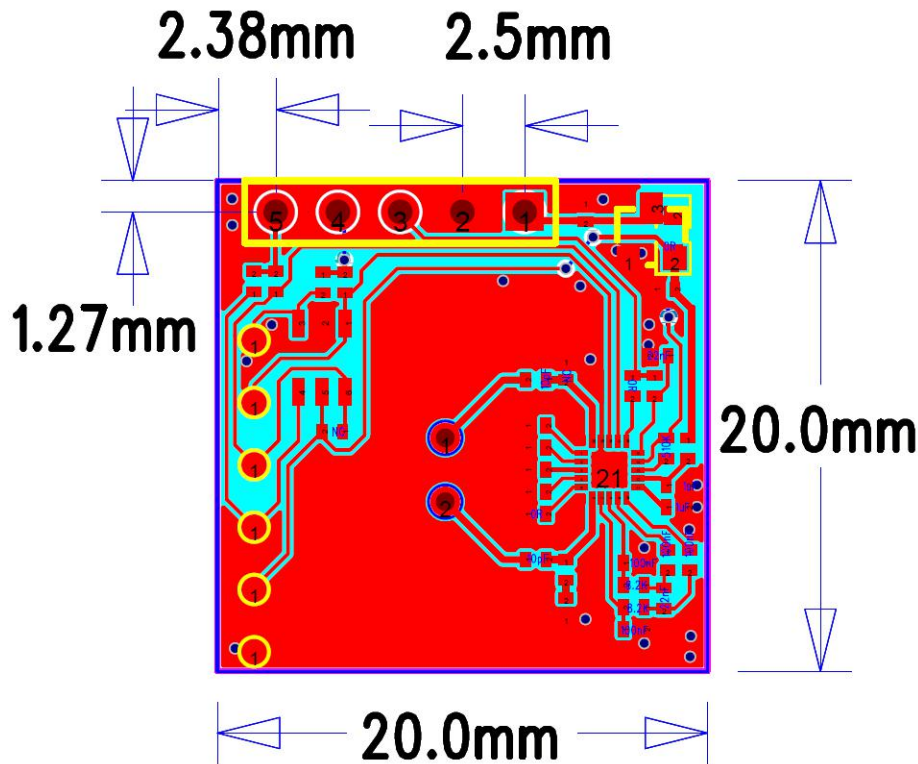

Plot. 3 AT58L4LDB-202 module dimension and connector location

Electric parameters

Parameter	Min.	Typ.	Max.	Unit	Remark
Tx frequency	5725		5875	MHz	
Tx power		0.2	0.5	mW	
Supply voltage	2.7	3.3	4.8	V	LDO DNE(default)
O/P high level		3.3		V	
O/P low level		0		V	
Current consumption		13		mA	Normal mode
		100		uA	Low power mode
Sensing distance		4	5	M	Hang-up in 3 meters
Delay time		2		S	Adjustable
PD threshold		10		Lux	Adjustable
Operation temp.	-20		85	°C	

Operation mode, sensing time and sensing distance adjustments

AT58L4LDB-2020 reserves on-board resistors setting for operation mode selection. In Plot. 4, when the resistor in red rectangle is 0R, the module is in normal operation mode (about 13mA); when the resistor is NC, the module is in low power mode (100uA).

In Plot. 4, the resistor in blue rectangle is for the sensing delay time setting for light-on. When the resistor is NC, the delay time is 30s; when the resistor is 0R, the delay time is 1.5 s; when the resistor is 2.4M Ohm, the delay time is 63 s. The sensing time is delayed accordingly during an existing sensing which outputs high.

In Plot. 4, the 3 resistors in yellow rectangle (th0, th1 and th2) offers 8-shift sensing distances. The resistor NC is logic 1, resistor 0R is logic 0. The truth table of the 3 resistors is in Plot. 5. The smaller value of threshold results in longer sensing distance.

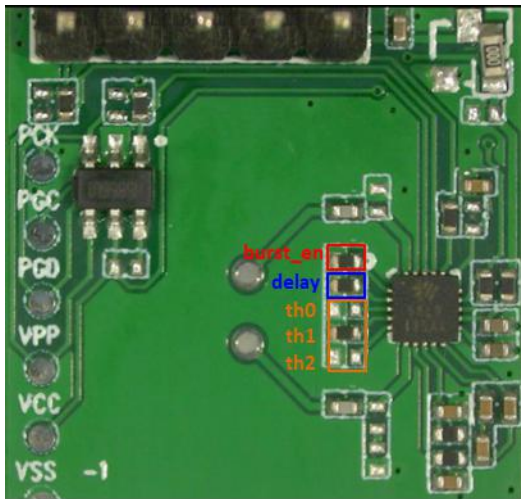

Plot. 4 on-board resistors setting illustration

th0	th1	th2	閾值
0	0	0	36
1	0	0	27
0	1	0	21
1	1	0	16
0	0	1	12
1	0	1	9
0	1	1	7
1	1	1	6

Plot. 5 Truth table for sensing distance adjustment

PD detection

The PD detection is on by default. In Plot. 6, the location of PD is shown. The PD threshold can be adjusted by either register configuration or resistor value adjustment in PD ckt. When the environment is bright that the sensing is above threshold, the module won't sense anything.

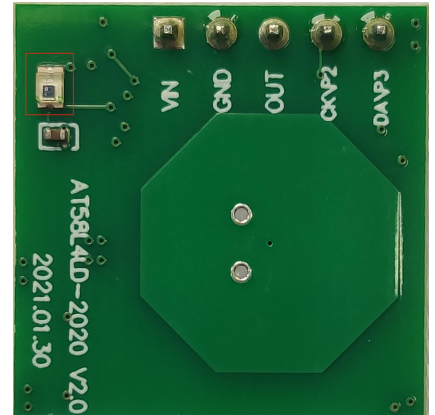

Plot. 6 PD location

Module power-up sequence

The module has a BIST. When powered up, GPIO output high for 3 seconds then switched to low for 1.5 seconds, then it enters normal sensing mode. Plot. 7 shows the power sequence:

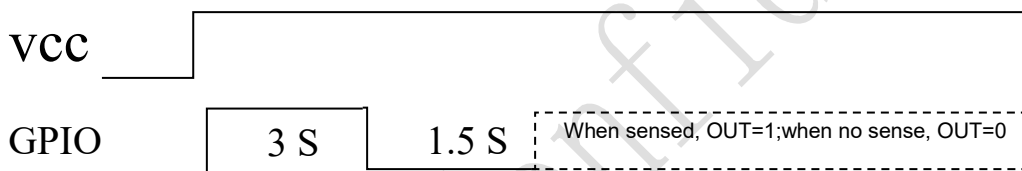

Plot. 7 power-up sequence

Sensing distance

The module's detection sensitivity can be adjusted by resistors. The maximum distance is 10 m. Below plot illustrates a typical detection range. If the threshold is set high, the detection range will be larger. In Plot. 9, dark zone means high sensitive areas that can fully detect movements. Light zone basically can detect movements but not always guaranteed.

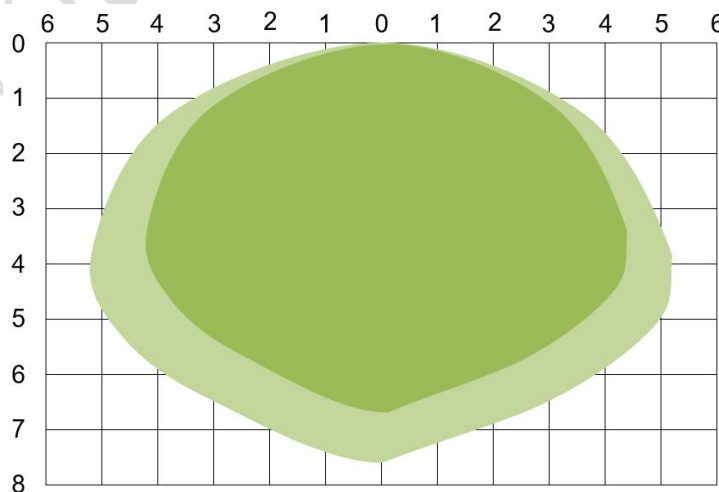

Plot. 9 detection range (Unit: m)

- Metal should be avoided on top of the antenna under installation which would result in signal shielding. Plastic or glass is acceptable while distancing on top of the antenna should be maintained.
- Large metallic instruments or infrastructures should be avoided right to the radar antenna.
- Parallel arrangement should be maintained under multiple radar modules installment. 1m distance should be kept between modules.
- The module is not suggested in applications near power switches under low-power mode.

Revision History

Revision	Release Date	Description
1.0	2021/09/23	Initial version
1.1	2022/08/16	Time delay and threshold table revised

FCC statements:

This device complies with part 15 of the FCC rules. Operation is subject to the following two conditions: (1) this device may not cause harmful interference, and (2) this device must accept any interference received, including interference that may cause undesired operation.

NOTE: The manufacturer is not responsible for any radio or TV interference caused by unauthorized modifications or changes to this equipment. Such modifications or changes could void the user's authority to operate the equipment.

Fe

deral Communication Commission (FCC) Radiation Exposure Statement

When using the product, maintain a distance of 20cm from the body to ensure compliance with RF exposure requirements.

FCC ID:2AVK2-AT5815B