

# Test Report

FCC ID: 2AVJX-F1

Date of issue: Dec. 11, 2020

Report number: MTi20102017-3E1

---

Sample description: Wireless charger Desk lamp

---

Model(s): F1

---

Applicant: Shenzhen Flyshine Technology Co., Ltd

---

Address: 3/F, Building C6, Hengfeng Industrial City, Hezhou, Bao'an District, Shenzhen

---

Date of test: Oct. 23, 2020 – Dec. 10, 2020

---

**Shenzhen Microtest Co., Ltd.**  
<http://www.mtitest.com>

This test report is valid for the tested samples only. It cannot be reproduced except in full without prior written consent of Shenzhen Microtest Co., Ltd.

Tel:(86-755)88850135

Fax: (86-755) 88850136

Web: <http://www.mtitest.com>

E-mail: [mti@51mti.com](mailto:mti@51mti.com)

Address: 101, No. 7, Zone 2, Xinxing Industrial Park, Fuhai Avenue, Xinhe Community, Fuhai Street, Bao'an District, Shenzhen, Guangdong, China.

## Table of Contents

<b>1</b>	<b>GENERAL INFORMATION .....</b>	<b>4</b>
1.1	FEATURE OF EQUIPMENT UNDER TEST (EUT).....	4
1.2	TEST MODE .....	4
1.3	EUT TEST SETUP.....	5
1.4	ANCILLARY EQUIPMENT .....	5
<b>2</b>	<b>SUMMARY OF TEST RESULT .....</b>	<b>6</b>
2.1	OPERATION CHANNEL LIST .....	6
2.2	TEST CHANNEL .....	6
<b>3</b>	<b>TEST FACILITIES AND ACCREDITATIONS .....</b>	<b>7</b>
3.1	TEST LABORATORY .....	7
3.2	ENVIRONMENTAL CONDITIONS .....	7
3.3	MEASUREMENT UNCERTAINTY.....	7
3.4	TEST SOFTWARE .....	7
<b>4</b>	<b>LIST OF TEST EQUIPMENT .....</b>	<b>8</b>
<b>5</b>	<b>TEST RESULTS.....</b>	<b>9</b>
5.1	ANTENNA REQUIREMENT .....	9
5.1.1	<i>Standard requirement</i> .....	9
5.1.2	<i>EUT Antenna</i> .....	9
5.2	CONDUCTED EMISSION .....	10
5.2.1	<i>Limits</i> .....	10
5.2.2	<i>Test Procedures</i> .....	10
5.2.3	<i>Test Setup</i> .....	10
5.2.4	<i>Test Result</i> .....	10
5.3	RADIATED EMISSION.....	15
5.3.1	<i>Limits</i> .....	15
5.3.2	<i>Test Procedures</i> .....	16
5.3.3	<i>Test Setup</i> .....	17
5.3.4	<i>Test Result</i> .....	17
5.4	OCCUPIED BANDWIDTH.....	21
5.4.1	<i>Test method</i> .....	21
5.4.2	<i>Test result</i> .....	21
	<b>PHOTOGRAPHS OF THE TEST SETUP .....</b>	<b>22</b>
	<b>PHOTOGRAPHS OF THE EUT.....</b>	<b>24</b>

## Test Result Certification

Applicant's name: Shenzhen Flyshine Technology Co., Ltd

Address: 3/F, Building C6, Hengfeng Industrial City, Hezhou, Bao'an District, Shenzhen

Manufacture's name: Shenzhen Flyshine Technology Co., Ltd

Address: 3/F, Building C6, Hengfeng Industrial City, Hezhou, Bao'an District, Shenzhen

Product name: Wireless charger Desk lamp

Trademark: N/A

Model name: F1

Standards: FCC Part 15C

Test procedure: ANSI C63.10-2013

This device described above has been tested by Shenzhen Microtest Co., Ltd. and the test results show that the equipment under test (EUT) is in compliance with the FCC requirements. And it is applicable only to the tested sample identified in the report.

Tested by:

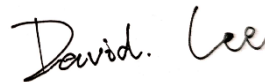

David Lee

Dec. 10, 2020

Reviewed by:

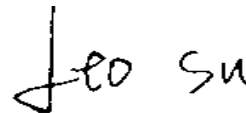

Leo Su

Dec. 11, 2020

Approved by:



Tom Xue

Dec. 11, 2020

## 1 GENERAL INFORMATION

### 1.1 Feature of equipment under test (EUT)

Product name:	Wireless charger Desk lamp
Model name:	F1
Model difference:	N/A
Operation frequency:	115–205 kHz
Modulation type:	Load modulation
Antenna type:	Coil Antenna
Power supply:	DC 12V from adapter AC 120V/60Hz
Battery:	N/A
Adapter information:	MODEL: KDP-AE120150U INPUT: 100-240V-50/60Hz 0.8A OUTPUT: DC 12V 1.5A
EUT serial number:	MTi20102017-3-S0001

### 1.2 Test mode

To investigate the maximum EMI emission characteristics generates from EUT, the test system was pre-scanning tested base on the consideration of following EUT operation mode or test configuration mode which possible have effect on EMI emission level. Each of these EUT operation mode(s) or test configuration mode(s) mentioned above was evaluated respectively.

Test mode	Description
Mode 1	Wireless charging

Note:

1: The test modes were carried out for all operation modes. The final test mode of the EUT was the worst test mode for EMI, and its test data was showed.

2: EUT is tested under full load.

### 1.3 EUT test setup

See photographs of the test setup in the report for the actual setup and connections between EUT and support equipment.

### 1.4 Ancillary equipment

Equipment	Model	S/N	Manufacturer
/	/	/	/

## 2 Summary of Test Result

Item	FCC Part No.	Description of Test	Result
1	FCC PART 15.203	Antenna requirement	Pass
2	FCC PART 15.207	Conducted emission	Pass
3	FCC PART 15.209	Radiated emission	Pass
4	FCC Part 15.215	20dB bandwidth	Pass

### 2.1 Operation channel list

Channel	Frequency (kHz)
Low	115
Middle	130
High	205

### 2.2 Test channel

Channel	Frequency (kHz)
Middle	130

### 3 Test Facilities and Accreditations

#### 3.1 Test laboratory

Test Laboratory	Shenzhen Microtest Co., Ltd
Location	101, No. 7, Zone 2, Xinxing Industrial Park, Fuhai Avenue, Xinghe Community, Fuhai Street, Bao' an District, Shenzhen, Guangdong, China.
FCC Registration No.:	448573

#### 3.2 Environmental conditions

Temperature:	15°C~35°C
Humidity	20%~75%
Atmospheric pressure	98kPa~101kPa

#### 3.3 Measurement uncertainty

Measurement Uncertainty for a Level of Confidence of 95 %,  $U=2xUc(y)$

RF frequency	$1 \times 10^{-7}$
RF power, conducted	$\pm 1$ dB
Conducted emission(150kHz~30MHz)	$\pm 2.5$ dB
Radiated emission(30MHz~1GHz)	$\pm 4.2$ dB
Radiated emission (above 1GHz)	$\pm 4.3$ dB
Temperature	$\pm 1$ degree
Humidity	$\pm 5$ %

#### 3.4 Test software

Software Name	Manufacturer	Model	Version
RF Test System	Shenzhen JS tonscond co., ltd	JS1120-3	2.5.77.0418

#### 4 List of test equipment

Equipment No.	Equipment Name	Manufacturer	Model	Serial No.	Calibration date	Due date
MTI-E043	EMI Test Receiver	Rohde&schwarz	ESC17	101166	2020/06/04	2021/06/03
MTI-E044	TRILOG Broadband Antenna	schwarzbeck	VULB 9163	9163-1338	2020/06/05	2021/06/04
MTI-E047	Amplifier	Hewlett-Packard	8447F	3113A06150	2020/06/04	2021/06/03
MTI-E089	ESG Vector Signal Generator	Agilent	N5182A	MY49060455	2020/06/03	2021/06/02
MTI-E058	ESG Series Analog Signal Generator	Agilent	E4421B	GB40051240	2020/07/03	2021/07/04
MTI-E062	PXA Signal Analyzer	Agilent	N9030A	MY51350296	2020/06/04	2021/06/03
MTI-E066	MXA Signal Analyzer	Agilent	N9020A	MY50143483	2020/06/04	2021/06/03
MTI-E078	Synthesized Sweeper	Agilent	83752A	3610A01957	2020/06/04	2021/06/03
MTI-E079	DC Power Supply	Agilent	E3632A	MY40027695	2020/06/04	2021/06/03
MTI-E021	EMI Test Receiver	Rohde&schwarz	ESCS30	100210	2020/06/04	2021/06/03
MTI-E022	Pulse Limiter	Schwarzbeck	VSTD 9561-F	00679	2020/06/03	2021/06/02
MTI-E023	Artificial mains network	Schwarzbeck	NSLK 8127	NSLK 8127 #841	2020/06/04	2021/06/03
MTI-E046	Active Loop Antenna	Schwarzbeck	FMZB 1519 B	00044	2020/06/05	2021/06/04
MTI-E048	Amplifier	Agilent	8449B	3008A02400	2020/07/03	2021/07/04
MTI-E072	Thermometer Clock Humidity Monitor	-	HTC-1	/	2020/06/07	2021/06/06
MTI-E090	Test Loop Antenna	DATETEK	LA-001	771409634	2020/06/05	2021/06/04

Note: the calibration interval of the above test instruments is 12 months and the calibrations are traceable to international system unit (SI).



## **5 Test Results**

### **5.1 Antenna requirement**

#### **5.1.1 Standard requirement**

15.203 requirement: For intentional device, according to 15.203: an intentional radiator shall be designed to ensure that no antenna other than that furnished by the responsible party shall be used with the device

#### **5.1.2 EUT Antenna**

The EUT antenna is Coil Antenna. It comply with the standard requirement. In case of replacement of broken antenna the same antenna type must be used.

## 5.2 Conducted emission

### 5.2.1 Limits

For the following equipment, when designed to be connected to the public utility (AC) power line the radio frequency voltage that is conducted back onto the AC power line on any frequency or frequencies shall not exceed the limits in the following tables. Compliance with the provisions of this paragraph shall be based on the measurement of the radio frequency voltage between each power line and ground at the power terminal using a 50  $\mu$ H/50 ohms line impedance stabilization network (LISN).

Frequency (MHz)	Conducted limit (dB $\mu$ V)	
	Quasi-peak	Average
0.15 -0.5	66 - 56 *	56 - 46 *
0.5 -5	56	46
5 -30	60	50

Note:

the limit of " \* " marked band means the limitation decreases linearly with the logarithm of the frequency in the range.

### 5.2.2 Test Procedures

The EUT was placed 0.8 meters from the horizontal ground plane with EUT being connected to the power mains through a line impedance stabilization network (LISN). All other support equipment powered from additional LISN(s). The LISN provide 50 Ohm/ 50uH of coupling impedance for the measuring instrument.

Interconnecting cables that hang closer than 40 cm to the ground plane shall be folded back and forth in the center forming a bundle 30 to 40 cm long.

I/O cables that are not connected to a peripheral shall be bundled in the center. The end of the cable may be terminated, if required, using the correct terminating impedance. The overall length shall not exceed 1 m.

LISN is at least 80 cm from nearest part of EUT chassis.

For the actual test configuration, please refer to the related Item – photographs of the test setup.

### 5.2.3 Test Setup

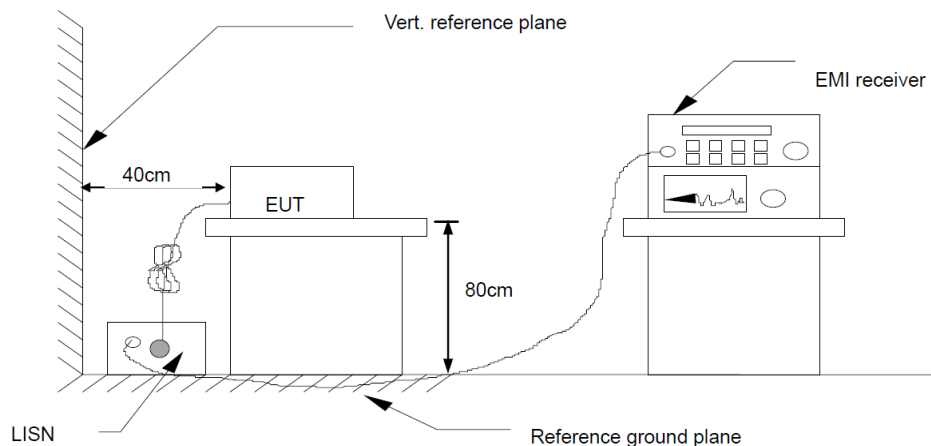

### 5.2.4 Test Result



EUT:	Wireless charger Desk lamp	Model Name:	F1
Pressure:	101kPa	Phase:	L
Test voltage:	DC 12V from adapter AC 120V/60Hz	Test mode:	Mode 1

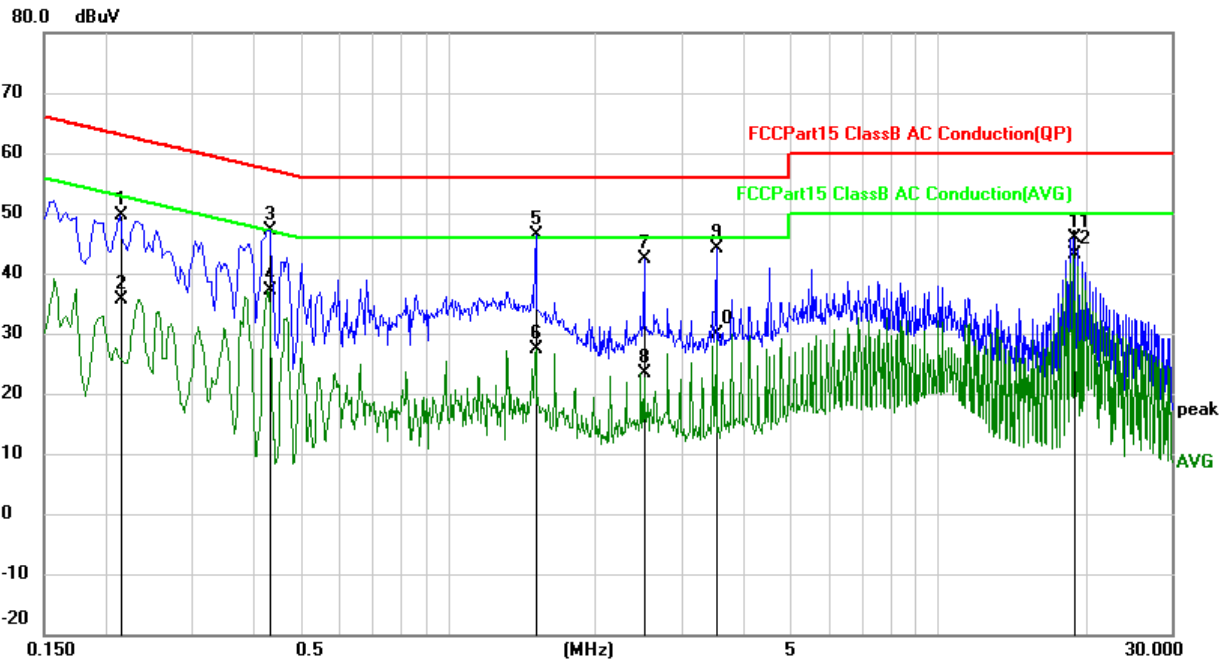

No.	Mk.	Freq.	Reading Level	Correct Factor	Measurement	Limit	Over	Detector
		MHz	dBuV	dB	dBuV	dBuV	dB	
1		0.2140	39.98	9.74	49.72	63.05	-13.33	QP
2		0.2140	25.89	9.74	35.63	53.05	-17.42	AVG
3		0.4340	37.23	9.88	47.11	57.18	-10.07	QP
4		0.4340	27.35	9.88	37.23	47.18	-9.95	AVG
5		1.5140	36.36	10.01	46.37	56.00	-9.63	QP
6		1.5140	17.28	10.01	27.29	46.00	-18.71	AVG
7		2.5220	32.20	10.06	42.26	56.00	-13.74	QP
8		2.5220	13.23	10.06	23.29	46.00	-22.71	AVG
9		3.5300	33.92	10.11	44.03	56.00	-11.97	QP
10		3.5300	19.84	10.11	29.95	46.00	-16.05	AVG
11		19.0100	35.49	10.41	45.90	60.00	-14.10	QP
12	*	19.0100	32.77	10.41	43.18	50.00	-6.82	AVG



EUT:	Wireless charger Desk lamp	Model Name:	F1
Pressure:	101kPa	Phase:	N
Test voltage:	DC 12V from adapter AC 120V/60Hz	Test mode:	Mode 1

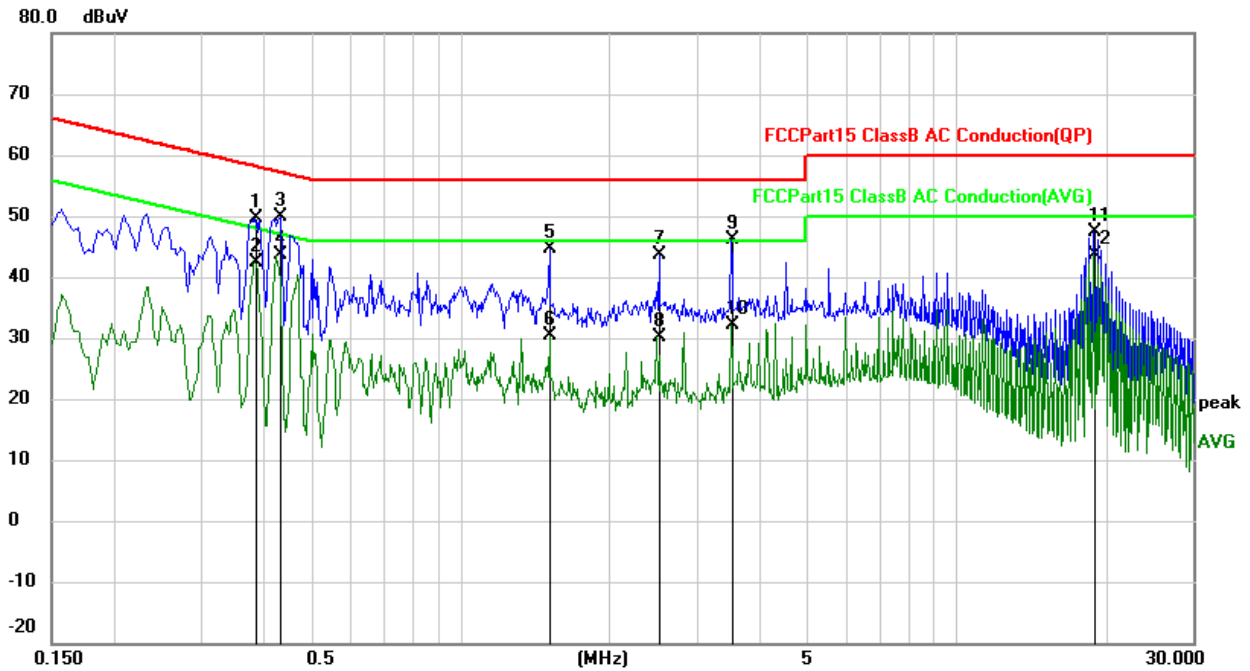

No.	Mk.	Freq. MHz	Reading Level dBuV	Correct Factor dB	Measure- ment dBuV	Limit dBuV	Over dB	Detector
1		0.3860	39.87	9.84	49.71	58.15	-8.44	QP
2		0.3860	32.65	9.84	42.49	48.15	-5.66	AVG
3		0.4340	39.94	9.88	49.82	57.18	-7.36	QP
4	*	0.4340	33.83	9.88	43.71	47.18	-3.47	AVG
5		1.5140	34.51	10.01	44.52	56.00	-11.48	QP
6		1.5140	20.48	10.01	30.49	46.00	-15.51	AVG
7		2.5180	33.68	10.06	43.74	56.00	-12.26	QP
8		2.5180	20.08	10.06	30.14	46.00	-15.86	AVG
9		3.5260	36.02	10.11	46.13	56.00	-9.87	QP
10		3.5260	22.13	10.11	32.24	46.00	-13.76	AVG
11		18.9260	36.98	10.42	47.40	60.00	-12.60	QP
12		18.9260	33.23	10.42	43.65	50.00	-6.35	AVG



EUT:	Wireless charger Desk lamp	Model Name:	F1
Pressure:	101kPa	Phase:	L
Test voltage:	DC 12V from adapter AC 240V/60Hz	Test mode:	Mode 1

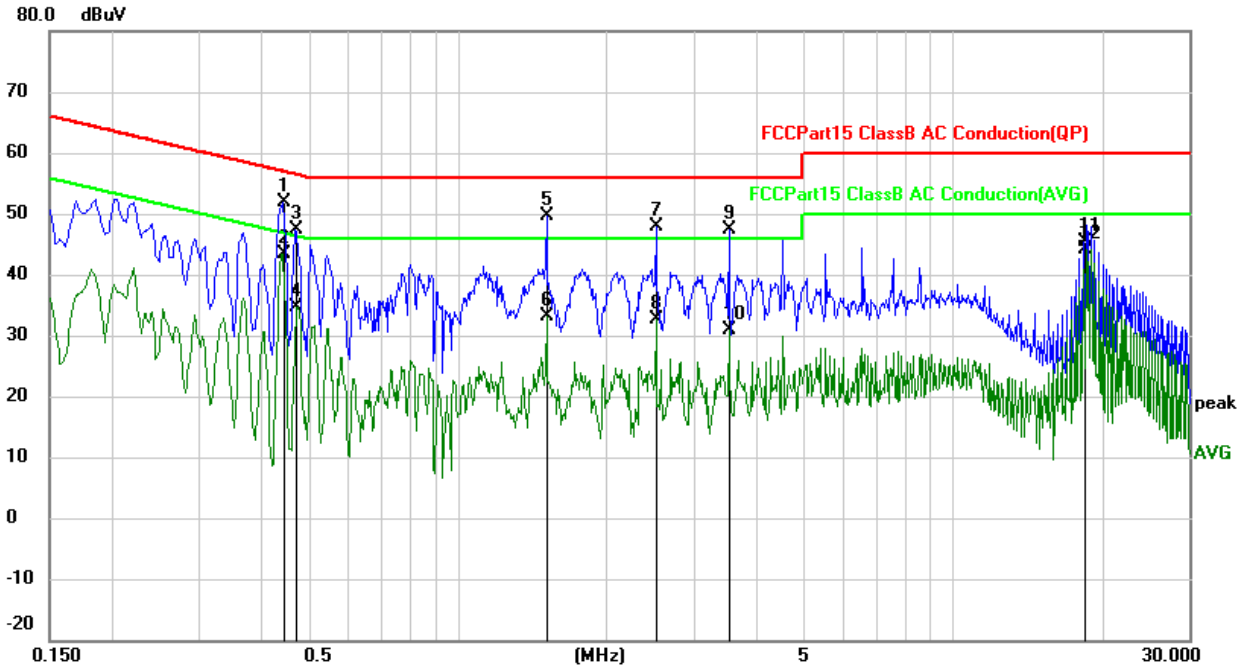

No.	Mk.	Freq. MHz	Reading Level dBuV	Correct Factor dB	Measure- ment dBuV	Limit dBuV	Over dB	Detector
1		0.4460	42.02	9.89	51.91	56.95	-5.04	QP
2	*	0.4460	33.61	9.89	43.50	46.95	-3.45	AVG
3		0.4700	37.58	9.91	47.49	56.51	-9.02	QP
4		0.4700	24.82	9.91	34.73	46.51	-11.78	AVG
5		1.5140	39.57	10.01	49.58	56.00	-6.42	QP
6		1.5140	23.01	10.01	33.02	46.00	-12.98	AVG
7		2.5220	37.74	10.06	47.80	56.00	-8.20	QP
8		2.5220	22.68	10.06	32.74	46.00	-13.26	AVG
9		3.5300	37.31	10.11	47.42	56.00	-8.58	QP
10		3.5300	20.72	10.11	30.83	46.00	-15.17	AVG
11		18.3700	34.94	10.41	45.35	60.00	-14.65	QP
12		18.3700	33.64	10.41	44.05	50.00	-5.95	AVG



EUT:	Wireless charger Desk lamp	Model Name:	F1
Pressure:	101kPa	Phase:	N
Test voltage:	DC 12V from adapter AC 240V/60Hz	Test mode:	Mode 1

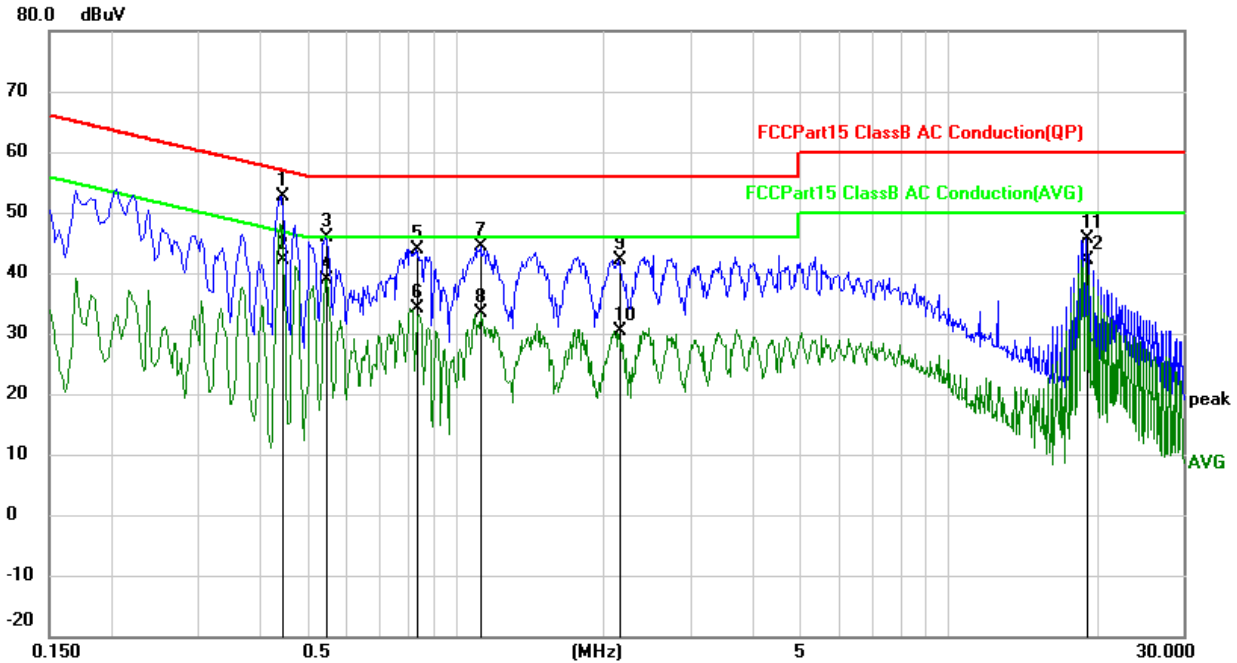

No.	Mk.	Freq.	Reading Level	Correct Factor	Measurement	Limit	Over	Detector
		MHz	dBuV	dB	dBuV	dBuV	dB	
1	*	0.4460	42.86	9.89	52.75	56.95	-4.20	QP
2		0.4460	32.21	9.89	42.10	46.95	-4.85	AVG
3		0.5460	36.02	9.94	45.96	56.00	-10.04	QP
4		0.5460	28.94	9.94	38.88	46.00	-7.12	AVG
5		0.8340	33.97	9.97	43.94	56.00	-12.06	QP
6		0.8340	24.20	9.97	34.17	46.00	-11.83	AVG
7		1.1260	34.37	9.99	44.36	56.00	-11.64	QP
8		1.1260	23.37	9.99	33.36	46.00	-12.64	AVG
9		2.1460	32.04	10.05	42.09	56.00	-13.91	QP
10		2.1460	20.26	10.05	30.31	46.00	-15.69	AVG
11		19.0660	35.30	10.41	45.71	60.00	-14.29	QP
12		19.0660	31.77	10.41	42.18	50.00	-7.82	AVG

### 5.3 Radiated emission

#### 5.3.1 Limits

In case the emission fall within the restricted band specified on 15.205(a), then the 15.209(a) limit in the table below has to be followed.

Frequencies (MHz)	Field Strength (microrvolts/meter)	Measurement Distance (meters)
0.009~0.490	2400/F(KHz)	300
0.490~1.705	24000/F(KHz)	30
1.705~30.0	30	30
30~88	100	3
88~216	150	3
216~960	200	3
Above 960	500	3

#### LIMITS OF RADIATED EMISSION MEASUREMENT (Above 1000MHz)

FREQUENCY (MHz)	Class B (dBuV/m) (at 3M)	
	PEAK	AVERAGE
Above 1000	74	54

Notes:

The limit for radiated test was performed according to FCC PART 15C.

The tighter limit applies at the band edges.

Emission level (dBuV/m)=20log Emission level (uV/m).

#### FREQUENCY RANGE OF RADIATED MEASUREMENT (For unintentional radiators)

Highest frequency generated or Upper frequency of measurement used in the device or on which the device operates or tunes (MHz)	Range (MHz)
Below 1.705	30
1.705 – 108	1000
108 – 500	2000
500 – 1000	5000
Above 1000	5 <sup>th</sup> harmonic of the highest frequency or 40 GHz, whichever is lower

Spectrum Parameter	Setting
Attenuation	Auto
Start Frequency	1000 MHz
Stop Frequency	10th carrier harmonic
RB / VB (emission in restricted band)	1 MHz / 1 MHz for Peak, 1 MHz / 10Hz for Average

Receiver Parameter	Setting
Attenuation	Auto
Start ~ Stop Frequency	9kHz~150kHz / RB 200Hz for QP
Start ~ Stop Frequency	150kHz~30MHz / RB 9kHz for QP





Start ~ Stop Frequency	30MHz~1000MHz / RB 120kHz for QP
------------------------	----------------------------------

### 5.3.2 Test Procedures

- a. The measuring distance of at 3 m shall be used for measurements at frequency up to 25GHz. For frequencies above 1GHz, any suitable measuring distance may be used.
- b. The EUT was placed on the top of a rotating table 0.8 meters above the ground at a 3 meter semi-chamber test. The table was rotated 360 degrees to determine the position of the highest radiation.
- c. The height of the equipment or of the substitution antenna shall be 0.8m; above 1GHz, the height was 1.5m, the height of the test antenna shall vary between 1 m to 4 m. Both horizontal and vertical polarizations of the antenna are set to make the measurement.
- d. The initial step in collecting conducted emission data is a spectrum analyzer peak detector mode pre-scanning the measurement frequency range. Significant peaks are then marked and then Quasi Peak detector mode re-measured.
- e. If the Peak Mode measured value compliance with and lower than Quasi Peak Mode Limit, the EUT shall be deemed to meet QP Limits and then no additional QP Mode measurement performed.
- f. For the actual test configuration, please refer to the related Item –EUT Test Photos.
- g. For the radiated emission test above 1GHz:  
Place the measurement antenna away from each area of the EUT determined to be a source of emissions at the specified measurement distance, while keeping the measurement antenna aimed at the source of emissions at each frequency of significant emissions, with polarization oriented for maximum response.
- h. The measurement antenna may have to be higher or lower than the EUT, depending on the radiation pattern of the emission and staying aimed at the emission source for receiving the maximum signal. The final measurement antenna elevation shall be that which maximizes the emissions. The measurement antenna elevation for maximum emissions shall be restricted to a range of heights of from 1 m to 4 m above the ground or reference ground plane.

Note: Both horizontal and vertical antenna polarities were tested and performed pretest to three orthogonal axis. The worst case emissions were reported.



### 5.3.3 Test Setup

#### Radiated Emission Test-Up Frequency Below 30MHz

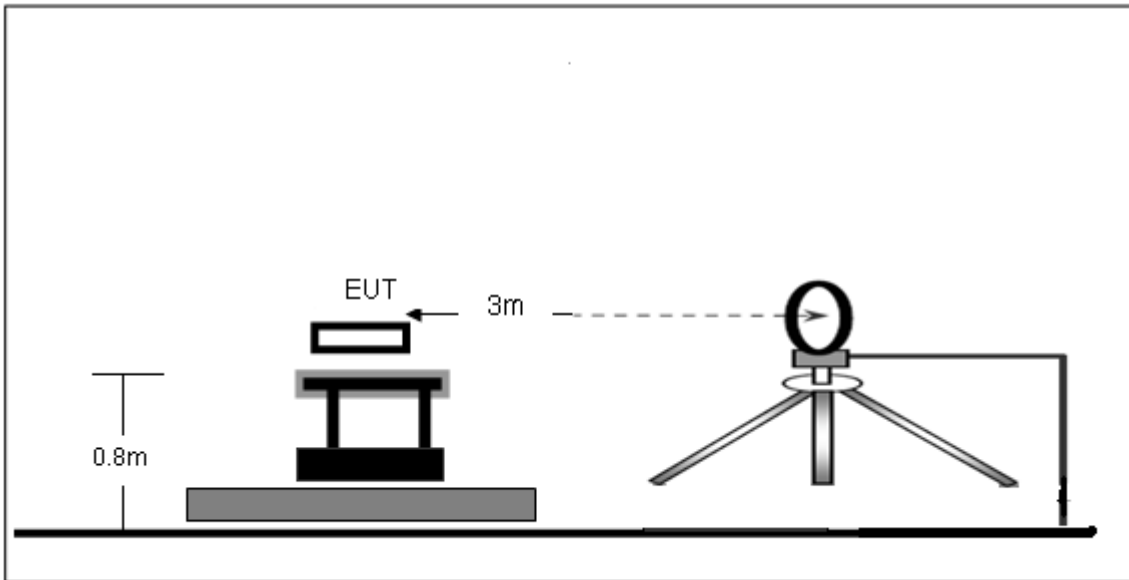

#### Radiated Emission Test-Up Frequency 30MHz~1GHz

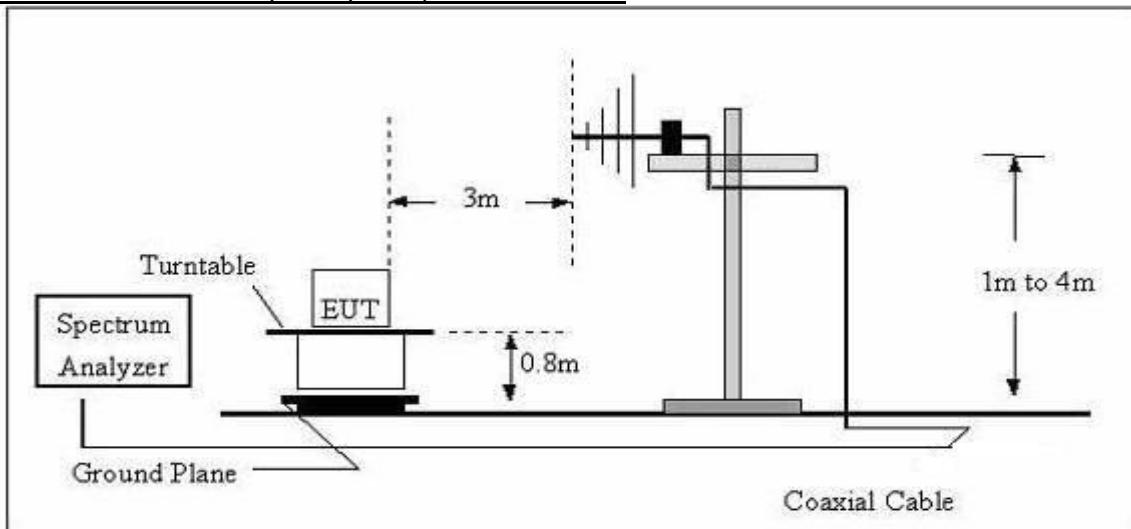

### 5.3.4 Test Result



Frequency range (9kHz – 30MHz)

EUT:	Wireless charger Desk lamp	Model Name:	F1
Pressure:	101kPa	Test mode:	Mode 1
Test voltage:	DC 12V from adapter AC 120V/60Hz		

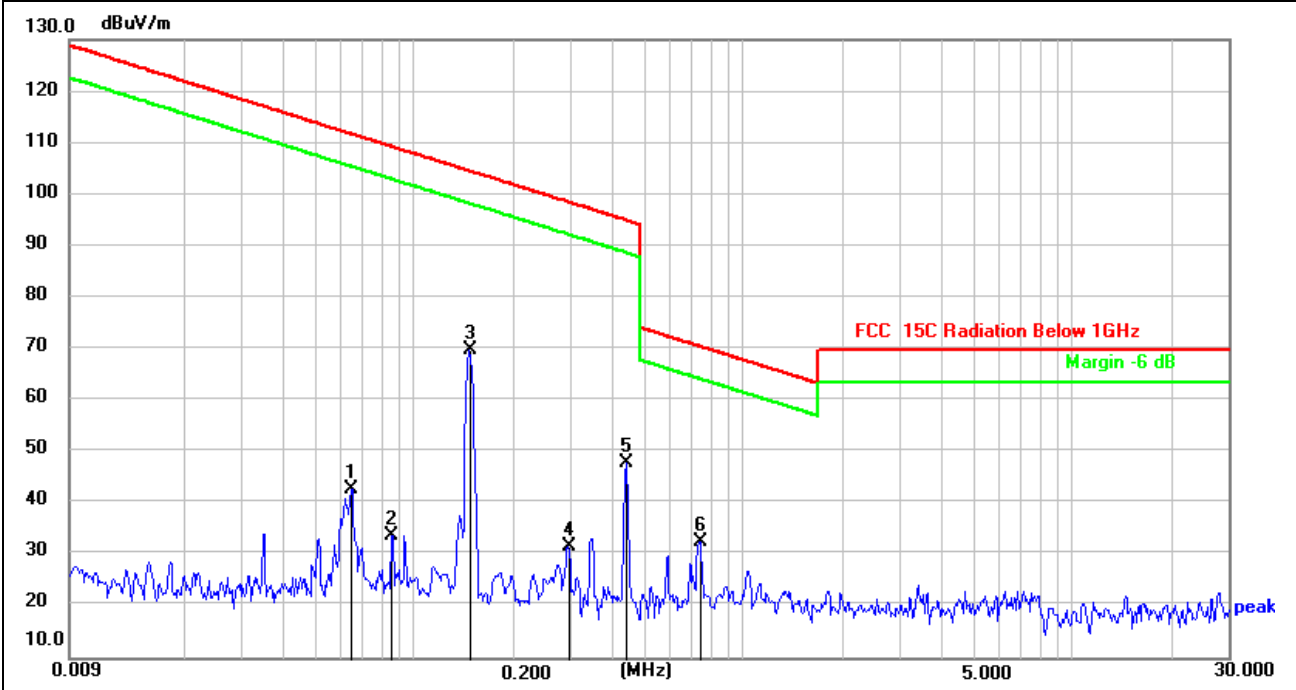

No.	Frequency (MHz)	Reading (dBuV)	Factor (dB/m)	Level (dBuV/m)	Limit (dBuV/m)	Margin (dB)	Detector
1	0.0646	22.41	20.54	42.95	111.40	-68.45	peak
2	0.0858	13.14	20.67	33.81	108.93	-75.12	peak
3 *	0.1478	49.80	20.11	69.91	104.21	-34.30	peak
4	0.2945	11.67	20.21	31.88	98.22	-66.34	peak
5	0.4418	27.66	20.31	47.97	94.70	-46.73	peak
6	0.7365	12.13	20.45	32.58	70.27	-37.69	peak

**Frequency range (30MHz – 1GHz)**

EUT:	Wireless charger Desk lamp	Model Name:	F1
Pressure:	101kPa	Polarization:	Vertical
Test voltage:	DC 12V from adapter AC 120V/60Hz	Test mode:	Mode 1

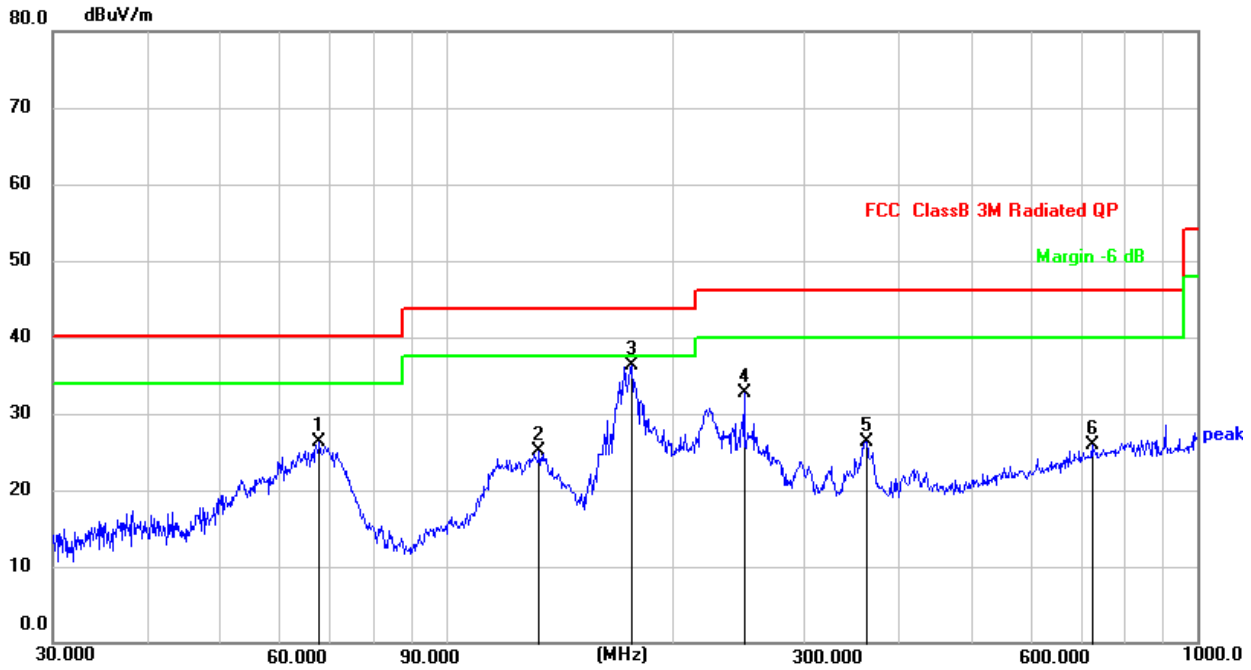

No.	Frequency (MHz)	Reading (dBuV)	Factor (dB/m)	Level (dBuV/m)	Limit (dBuV/m)	Margin (dB)	Detector
1	67.9128	43.31	-17.04	26.27	40.00	-13.73	QP
2	133.1510	42.16	-17.14	25.02	43.50	-18.48	QP
3 *	176.8875	51.99	-15.74	36.25	43.50	-7.25	QP
4	249.4250	44.88	-12.08	32.80	46.00	-13.20	QP
5	362.9843	35.91	-9.51	26.40	46.00	-19.60	QP
6	724.2607	28.82	-2.95	25.87	46.00	-20.13	QP



EUT:	Wireless charger Desk lamp	Model Name:	F1
Pressure:	101kPa	Polarization:	Horizontal
Test voltage:	DC 12V from adapter AC 120V/60Hz	Test mode:	Mode 1

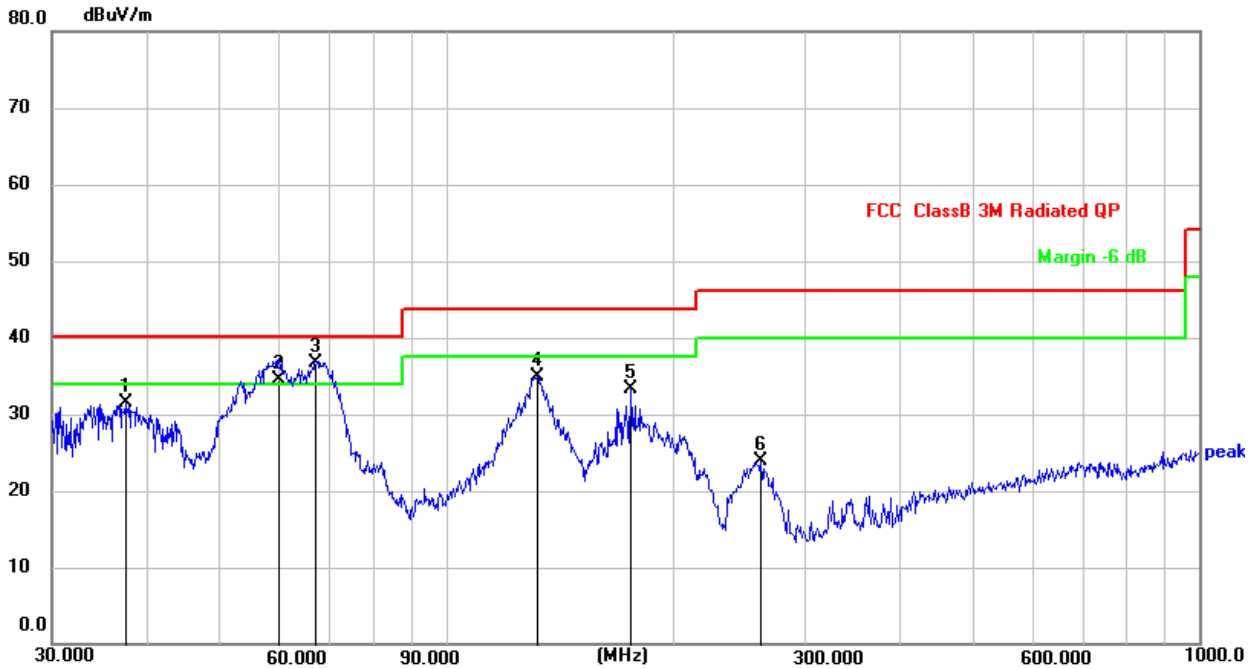

No.	Frequency (MHz)	Reading (dBuV)	Factor (dB/m)	Level (dBuV/m)	Limit (dBuV/m)	Margin (dB)	Detector
1	37.5478	46.09	-14.65	31.44	40.00	-8.56	QP
2 !	60.0690	49.26	-14.66	34.60	40.00	-5.40	QP
3 *	67.2021	53.52	-16.82	36.70	40.00	-3.30	QP
4	132.2204	51.97	-17.10	34.87	43.50	-8.63	QP
5	176.2684	49.04	-15.77	33.27	43.50	-10.23	QP
6	261.9750	35.61	-11.68	23.93	46.00	-22.07	QP



## Photographs of the Test Setup

Radiated emission

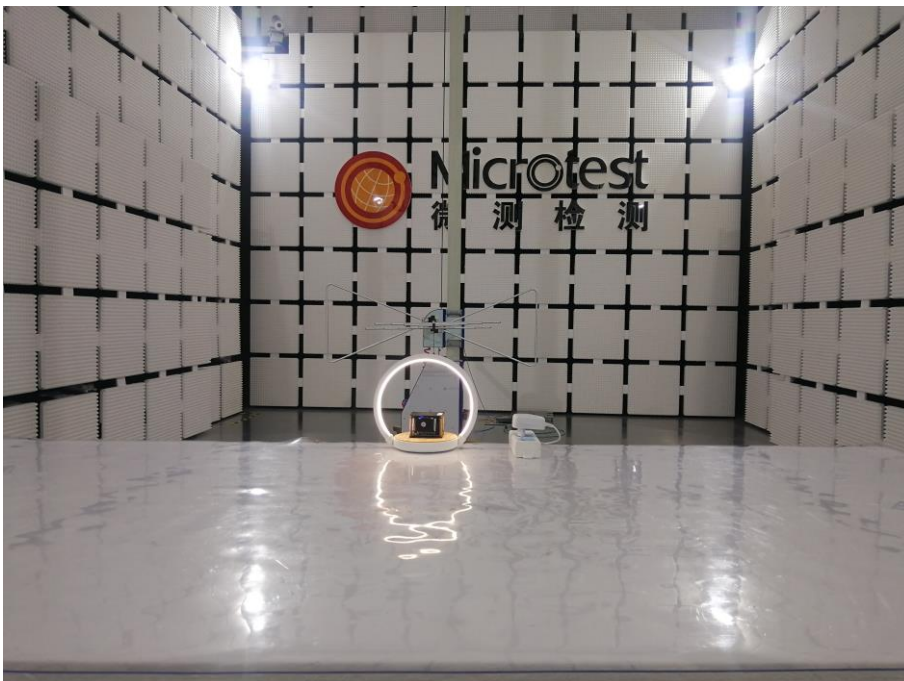



Conducted emission

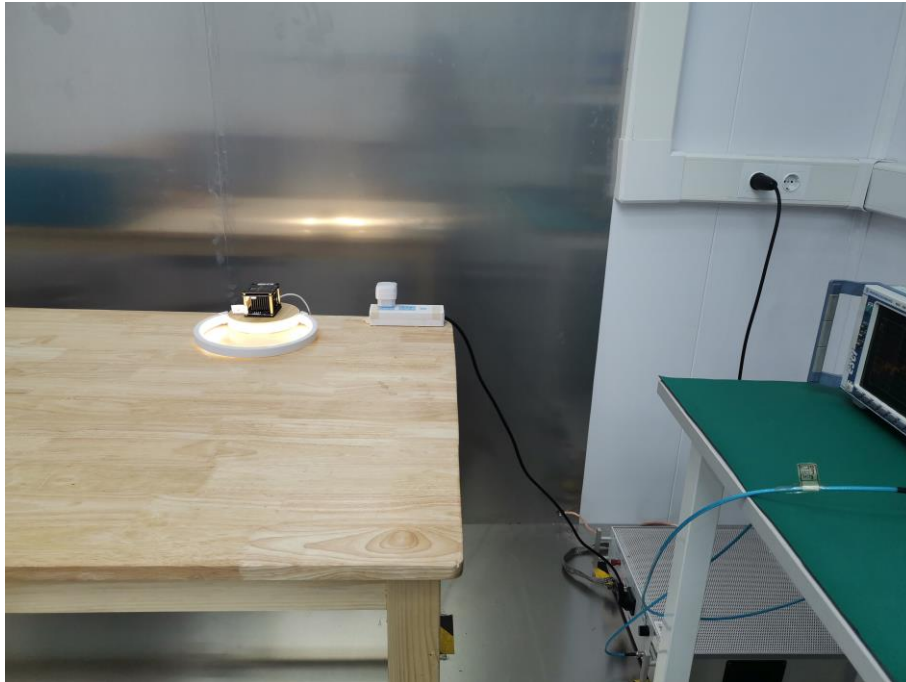

## **Photographs of the EUT**

See the APPENDIX 1: EUT PHOTOS in the report No.: MTi20102017-3E1-1.

**----END OF REPORT----**