



FCC TEST REPORT

FCC ID: 2AVJD-K520

Report Number..... : ZHT-231222033E

Date of Test..... Dec. 22, 2023 to Jan. 03, 2024

Date of issue : Jan. 03, 2024

Test Result : PASS

Testing Laboratory..... : Guangdong Zhonghan Testing Technology Co., Ltd.

Address : Room 104, Building 1, Yibaolai Industrial Park, Qiaotou Community, Fuhai Street, Bao'an District, Shenzhen, Guangdong, China

Applicant's name : Shenzhen Ruianyuan Electronic Technology Co.,Ltd

Address : Floor 4, Building 5, Tumao Industrial Park, Hebei Industrial Zone, Longhua District, Shenzhen

Manufacturer's name : Shenzhen Ruianyuan Electronic Technology Co.,Ltd

Address : Floor 4, Building 5, Tumao Industrial Park, Hebei Industrial Zone, Longhua District, Shenzhen

Test specification:

Standard..... : FCC CFR Title 47 Part 15 Subpart C Section 15.247

Test procedure..... : KDB558074 D01 15.247 Meas Guidance v05r02
ANSI C63.10:2013

Non-standard test method : N/A

This device described above has been tested by ZHT, and the test results show that the equipment under test (EUT) is in compliance with the FCC requirements. And it is applicable only to the tested sample identified in the report.

This report shall not be reproduced except in full, without the written approval of ZHT, this document may be altered or revised by ZHT, personal only, and shall be noted in the revision of the document.

Product name..... : Wireless bluetooth headset

Trademark : /

Model/Type reference : K520

Model difference : /

Ratings..... : DC 3.7 V by battery or DC 5 V by adapter



Testing procedure and testing location:

Testing Laboratory: Guangdong Zhonghan Testing Technology Co., Ltd.

Address: Room 104, Building 1, Yibaolai Industrial Park, Qiaotou Community, Fuhai Street, Bao'an District, Shenzhen, Guangdong, China

Tested by (name + signature): Kevin Yang

Reviewer (name + signature): Baret Wu

Approved (name + signature): Levi Lee



Table of Contents

	Page
1. VERSION.....	5
2.1 TEST FACILITY	7
2.2 MEASUREMENT UNCERTAINTY	7
3. GENERAL INFORMATION.....	8
3.1 GENERAL DESCRIPTION OF EUT	8
3.2 Test Setup Configuration	10
3.3 Support Equipment	10
3.4 Test Mode	10
3.5 EQUIPMENTS LIST FOR ALL TEST ITEMS	11
4. EMC EMISSION TEST	13
4.1 Conducted emissions	13
4.1.1 POWER LINE CONDUCTED EMISSION Limits	13
4.1.2 TEST PROCEDURE	13
4.1.3 DEVIATION FROM TEST STANDARD	13
4.1.4 TEST SETUP	14
4.1.5 EUT OPERATING CONDITIONS	14
4.1.6 Test Result	14
4.2 Radiated emissions	15
4.2.1 Radiated Emission Limits	15
4.2.2 TEST PROCEDURE	15
4.2.3 DEVIATION FROM TEST STANDARD	16
4.2.4 TEST SETUP	16
4.2.5 EUT OPERATING CONDITIONS	17
4.2.6 TEST RESULTS	18
5.1 Test Requirement:	23
5.2 TEST PROCEDURE	23
5.3 DEVIATION FROM TEST STANDARD	24
5.4 TEST SETUP	24
5.5 EUT OPERATING CONDITIONS	24
5.6 TEST RESULT	25
6. CONDUCTED BAND EDGE AND SPURIOUS EMISSION.....	27
6.1 Limit	27
6.2 Test Setup	27
6.3 Test procedure	27
6.4 DEVIATION FROM STANDARD	27
6.5 Test Result	27
7. 20DB&99% BANDWIDTH.....	28
7.1 Test Setup	28
7.2 Limit	28
7.3 Test procedure	28
7.4 DEVIATION FROM STANDARD	28
7.5 Test Result	28
8. MAXIMUM PEAK OUTPUT POWER.....	29
8.1 Block Diagram Of Test Setup	29
8.2 Limit	29
8.3 Test procedure	29
8.4 DEVIATION FROM STANDARD	29
8.5 Test Result	29
9. HOPPING CHANNEL SEPARATION.....	30
9.1 Test Setup	30
9.2 Test procedure	30
9.3 DEVIATION FROM STANDARD	30
10.1 Test Setup	31
10.2 Test procedure	31



ZHONGHAN

10.3 DEVIATION FROM STANDARD	31
11.1 Test Setup.....	32
11.2 Test procedure.....	32
11.3 DEVIATION FROM STANDARD	32
11.4 Test Result.....	32
12. ANTENNA REQUIREMENT	33
13. APPENDIX BT	34
13.1 Dwell Time	34
13.2 Maximum Peak Conducted Output Power	44
13.3 -20dB Bandwidth.....	50
13.4 Occupied Channel Bandwidth	56
13.5 Carrier Frequencies Separation.....	62
13.6 Number of Hopping Channel	68
13.7 Band Edge	70
13.8 Band Edge(Hopping)	76
13.9 Conducted RF Spurious Emission.....	84
15. EUT CONSTRUCTIONAL DETAILS	95



1. VERSION

Report No.	Version	Description	Approved
ZHT-231222033E	Rev.01	Initial issue of report	Jan. 03, 2024



ZHONGHAN

2. TEST SUMMARY

Test procedures according to the technical standards:

FCC Part15 (15.247) , Subpart C			
Standard Section	Test Item	Result	Remark
FCC part 15.203/15.247 (b)(4)	Antenna Requirement	PASS	
15.207	AC Power Line Conducted Emission	N/A	
15.247 (b)(1)	Conducted Peak Output Power	PASS	
15.247 (a)(1)	20dB Occupied Bandwidth 99% OCB	PASS	
15.247 (a)(1)	Carrier Frequencies Separation	PASS	
15.247 (a)(1)(iii)	Hopping Channel Number	PASS	
15.247 (a)(1)(iii)	Dwell Time	PASS	
15.205/15.209	Radiated Emission and Restricted Band	PASS	
15.247(d)	Conducted Unwanted emissions and Band Edge	PASS	

NOTE:

(1) "N/A" denotes test is not applicable in this Test Report



2.1 TEST FACILITY

Guangdong Zhonghan Testing Technology Co., Ltd.
Add. : Room 104, Building 1, Yibaolai Industrial Park, Qiaotou Community, Fuhai Street, Bao'an District, Shenzhen, Guangdong, China

FCC Registration Number:255941
Designation Number: CN0325
IC Registered No.: 29832
CAB identifier: CN0143

2.2 MEASUREMENT UNCERTAINTY

The reported uncertainty of measurement $y \pm U$, where expanded uncertainty U is based on a standard uncertainty multiplied by a coverage factor of $k=2$, providing a level of confidence of approximately 95 %.

No.	Item	Uncertainty
1	Conducted Emission Test	$\pm 1.38\text{dB}$
2	RF power conducted	$\pm 0.16\text{dB}$
3	Spurious emissions conducted	$\pm 0.21\text{dB}$
4	All emissions radiated(9k-30MHz)	$\pm 4.68\text{dB}$
5	All emissions radiated(<1G)	$\pm 4.68\text{dB}$
6	All emissions radiated(>1G)	$\pm 4.89\text{dB}$
7	Temperature	$\pm 0.5^\circ\text{C}$
8	Humidity	$\pm 2\%$
9	Occupied Bandwidth	$\pm 4.96\text{dB}$



3. GENERAL INFORMATION

3.1 GENERAL DESCRIPTION OF EUT

Product Name:	Wireless bluetooth headset
Test Model No.:	K520
Hardware Version:	V1.0
Software Version:	V1.0
Sample(s) Status:	Engineer sample
Channel numbers:	79
Channel separation:	2402MHz-2480MHz
Modulation technology:	GFSK, $\pi/4$ DQPSK, 8DPSK
Antenna Type:	Ceramic antenna
Antenna gain:	2.78dBi
Ratings:	DC 3.7 V by battery or DC 5 V by adapter

Note: Schematic diagram and layout of right and left ears are same, we chose the right ear to test .
The detailed information can be referred to the photos and techs which were stated and guaranteed by the applicant.



Operation Frequency each of channel							
Channel	Frequency	Channel	Frequency	Channel	Frequency	Channel	Frequency
1	2402MHz	21	2422MHz	41	2442MHz	61	2462MHz
2	2403MHz	22	2423MHz	42	2443MHz	62	2463MHz
3	2404MHz	23	2424MHz	43	2444MHz	63	2464MHz
4	2405MHz	24	2425MHz	44	2445MHz	64	2465MHz
5	2406MHz	25	2426MHz	45	2446MHz	65	2466MHz
6	2407MHz	26	2427MHz	46	2447MHz	66	2467MHz
7	2408MHz	27	2428MHz	47	2448MHz	67	2468MHz
8	2409MHz	28	2429MHz	48	2449MHz	68	2469MHz
9	2410MHz	29	2430MHz	49	2450MHz	69	2470MHz
10	2411MHz	30	2431MHz	50	2451MHz	70	2471MHz
11	2412MHz	31	2432MHz	51	2452MHz	71	2472MHz
12	2413MHz	32	2433MHz	52	2453MHz	72	2473MHz
13	2414MHz	33	2434MHz	53	2454MHz	73	2474MHz
14	2415MHz	34	2435MHz	54	2455MHz	74	2475MHz
15	2416MHz	35	2436MHz	55	2456MHz	75	2476MHz
16	2417MHz	36	2437MHz	56	2457MHz	76	2477MHz
17	2418MHz	37	2438MHz	57	2458MHz	77	2478MHz
18	2419MHz	38	2439MHz	58	2459MHz	78	2479MHz
19	2420MHz	39	2440MHz	59	2460MHz	79	2480MHz
20	2421MHz	40	2441MHz	60	2461MHz		

Note:

In section 15.31(m), regards to the operating frequency range over 10 MHz, the Lowest frequency, the middle frequency, and the highest frequency of channel were selected to perform the test, and the selected channel see below:

Test channel	Frequency
The lowest channel	2402MHz
The middle channel	2441MHz
The Highest channel	2480MHz



3.2 Test Setup Configuration
Radiated Emission

EUT

3.3 Support Equipment

The EUT has been tested as an independent unit together with other necessary accessories or support units. The following support units or accessories were used to form a representative test configuration during the tests.

Item	Equipment	Mfr/Brand	Model/Type No.	Series No.	Note

Item	Shielded Type	Ferrite Core	Length	Note

Note:

- (1) The support equipment was authorized by Declaration of Confirmation.
- (2) For detachable type I/O cable should be specified the length in cm in 『Length』 column.

3.4 Test Mode

Transmitting mode	Keep the EUT in continuously transmitting mode.
Remark: During the test, the test voltage was tuned from 85% to 115% of the nominal rated supply voltage, and found that the worst case was under the nominal rated supply condition. So the report just shows that condition's data.	



3.5 EQUIPMENTS LIST FOR ALL TEST ITEMS

Radiation Test equipment

Item	Equipment	Manufacturer	Model	Last Cal.	Next Cal.
1	Receiver	R&S	ESCI	Mar 12, 2023	Mar 11, 2024
2	Loop antenna	EMCI	LAP600	Mar 12, 2023	Mar 11, 2024
3	Amplifier	Schwarzbeck	BBV 9743 B	Mar 12, 2023	Mar 11, 2024
4	Amplifier	Schwarzbeck	BBV 9718 B	Mar 12, 2023	Mar 11, 2024
5	Bilog Antenna	Schwarzbeck	VULB9162	Mar 17, 2023	Mar 16, 2024
6	Horn Antenna	Schwarzbeck	BBHA9120D	Mar 17, 2023	Mar 16, 2024
7	Horn Antenna	A.H.SYSTEMS	SAS574	Mar 12, 2023	Mar 11, 2024
8	Amplifier	AEROFLEX	100KHz-40GHz	Mar 12, 2023	Mar 11, 2024
9	Spectrum Analyzer	R&S	FSV40	Mar 12, 2023	Mar 11, 2024
11	966 Anechoic Chamber	EMToni	9m6m6m	Nov. 25, 2021	Nov. 24, 2024
12	Spectrum Analyzer	KEYSIGHT	N9020A	Mar 12, 2023	Mar 11, 2024
13	WIDBAND RADIO COMMUNICATION TESTER	R&S	CMW500	Mar 12, 2023	Mar 11, 2024
14	Single Generator	Agilent	N5182A	Mar 12, 2023	Mar 11, 2024
15	Power Sensor	MWRFTest	MW100-RFCB	Mar 12, 2023	Mar 11, 2024
16	Audio analyzer	R&S	UPL	Mar 12, 2023	Mar 11, 2024
17	Single Generator	R&S	SMB100A	Mar 12, 2023	Mar 11, 2024
18	Power Amplifier Shielding Room	EMToni	2m3m3m	Nov. 25, 2021	Nov. 24, 2024



Conduction Test equipment

Equipment	Manufacturer	Model	Last Cal.	Next Cal.
Receiver	R&S	ESCI	Mar 12, 2023	Mar 11, 2024
LISN	R&S	ENV216	Mar 12, 2023	Mar 11, 2024
ISN CAT 6	Schwarzbeck	NTFM 8158	Mar 12, 2023	Mar 11, 2024
ISN CAT 5	Schwarzbeck	CAT5 8158	Mar 12, 2023	Mar 11, 2024
Capacitive Voltage Probe	Schwarzbeck	CVP 9222 C	Mar 12, 2023	Mar 11, 2024
Current Transformer Clamp	Schwarzbeck	SW 9605	Mar 12, 2023	Mar 11, 2024
CE Shielding Room	EMToni	9m4m3m	Nov. 25, 2021	Nov. 24, 2024



4. EMC EMISSION TEST

4.1 Conducted emissions

Test Requirement:	FCC Part15 C Section 15.207
Test Method:	ANSI C63.10:2013
Test Frequency Range:	150KHz to 30MHz
Receiver setup:	RBW=9KHz, VBW=30KHz, Sweep time=auto

4.1.1 POWER LINE CONDUCTED EMISSION Limits

FREQUENCY (MHz)	Limit (dBuV)		Standard
	Quasi-peak	Average	
0.15 -0.5	66 - 56 *	56 - 46 *	FCC
0.50 -5.0	56.00	46.00	FCC
5.0 -30.0	60.00	50.00	FCC

Note:

(1) *Decreases with the logarithm of the frequency.

4.1.2 TEST PROCEDURE

- a. The EUT was placed 0.8 meters from the horizontal ground plane with EUT being connected to the power mains through a line impedance stabilization network (LISN). All other support equipments powered from additional LISN(s). The LISN provide 50 Ohm/ 50uH of coupling impedance for the measuring instrument.
- b. Interconnecting cables that hang closer than 40 cm to the ground plane shall be folded back and forth in the center forming a bundle 30 to 40 cm long.
- c. I/O cables that are not connected to a peripheral shall be bundled in the center. The end of the cable may be terminated, if required, using the correct terminating impedance. The overall length shall not exceed 1 m.
- d. LISN at least 80 cm from nearest part of EUT chassis.
- e. For the actual test configuration, please refer to the related Item –EUT Test Photos.

4.1.3 DEVIATION FROM TEST STANDARD

No deviation



4.1.4 TEST SETUP

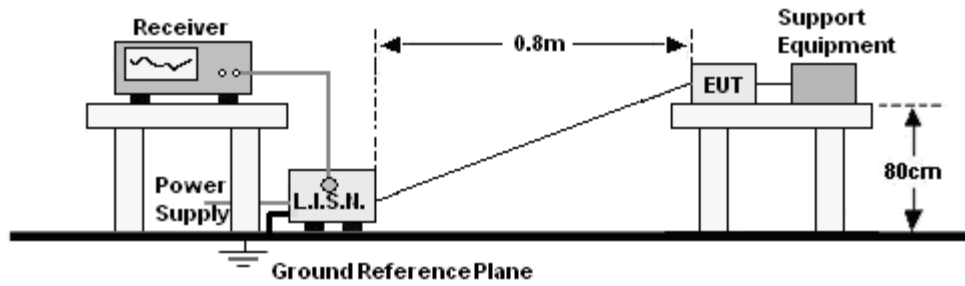

4.1.5 EUT OPERATING CONDITIONS

The EUT was configured for testing in a typical fashion (as a customer would normally use it). The EUT has been programmed to continuously transmit during test. This operating condition was tested and used to collect the included data.

4.1.6 Test Result N/A

The EUT is powered by rechargeable battery(DC 3.7V) and the Bluetooth does not work when charging , the test item is not applicable.



ZHONGHAN

4.2 Radiated emissions

Test Requirement:	FCC Part15 C Section 15.209				
Test Method:	ANSI C63.10:2013				
Test Frequency Range:	9kHz to 25GHz				
Test site:	Measurement Distance: 3m				
Receiver setup:	Frequency	Detector	RBW	VBW	Value
	9KHz-150KHz	Quasi-peak	200Hz	600Hz	Quasi-peak
	150KHz-30MHz	Quasi-peak	9KHz	30KHz	Quasi-peak
	30MHz-1GHz	Quasi-peak	100KHz	300KHz	Quasi-peak
	Above 1GHz	Peak	1MHz	3MHz	Peak
Peak		1MHz	10Hz	Average	

4.2.1 Radiated Emission Limits

Frequencies (MHz)	Field Strength (micровolts/meter)	Measurement Distance (meters)
0.009~0.490	2400/F(KHz)	300
0.490~1.705	24000/F(KHz)	30
1.705~30.0	30	30
30~88	100	3
88~216	150	3
216~960	200	3
Above 960	500	3

LIMITS OF RADIATED EMISSION MEASUREMENT

FREQUENCY (MHz)	Limit (dBuV/m) (at 3M)	
	PEAK	AVERAGE
Above 1000	74	54

Notes:

- (1) The limit for radiated test was performed according to FCC PART 15C.
- (2) The tighter limit applies at the band edges.
- (3) Emission level (dBuV/m)=20log Emission level (uV/m).

4.2.2 TEST PROCEDURE

Below 1GHz test procedure as below:

- a. The EUT was placed on the top of a rotating table 0.8 meters above the ground at a 3 meter semi-anechoic chamber. The table was rotated 360 degrees to determine the position of the highest radiation.
- b. The EUT was set 3 meters away from the interference-receiving antenna, which was mounted on the top of a variable-height antenna tower.
- c. The antenna height is varied from one meter to four meters above the ground to determine the maximum value of the field strength. Both horizontal and vertical polarizations of the antenna are set to make the measurement.

- d. For each suspected emission, the EUT was arranged to its worst case and then the antenna was tuned to heights from 1 meter to 4 meters (for the test frequency of below 30MHz, the antenna was tuned to heights 1 meter) and the rotatable table was turned from 0 degrees to 360 degrees to find the maximum reading.
- e. The test-receiver system was set to Peak Detect Function and Specified Bandwidth with Maximum Hold Mode.
- f. If the emission level of the EUT in peak mode was 10dB lower than the limit specified, then testing could be stopped and the peak values of the EUT would be reported. Otherwise the emissions that did not have 10dB margin would be re-tested one by one using peak, quasi-peak or average method as specified and then reported in a data sheet.

Above 1GHz test procedure as below:

- g. Different between above is the test site, change from Semi- Anechoic Chamber to fully Anechoic Chamber and change form table 0.8 metre to 1.5 metre(Above 18GHz the distance is 1 meter and table is 1.5 metre).
- h. Test the EUT in the lowest channel ,the middle channel ,the Highest channel
Note:
Both horizontal and vertical antenna polarities were tested and performed pretest to three orthogonal axis. The worst case emissions were reported

4.2.3 DEVIATION FROM TEST STANDARD

No deviation

4.2.4 TEST SETUP

(A) Radiated Emission Test-Up Frequency Below 30MHz

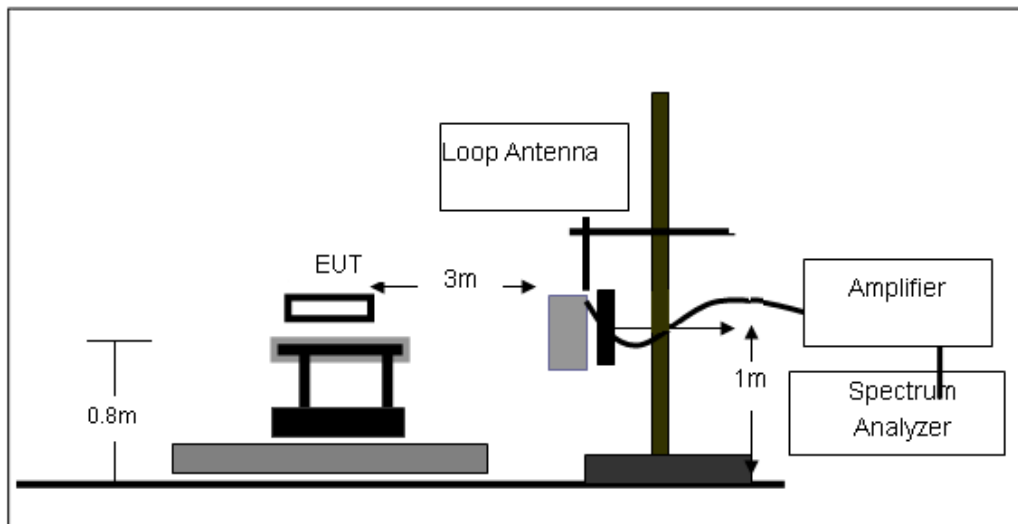

(B) Radiated Emission Test-Up Frequency 30MHz~1GHz

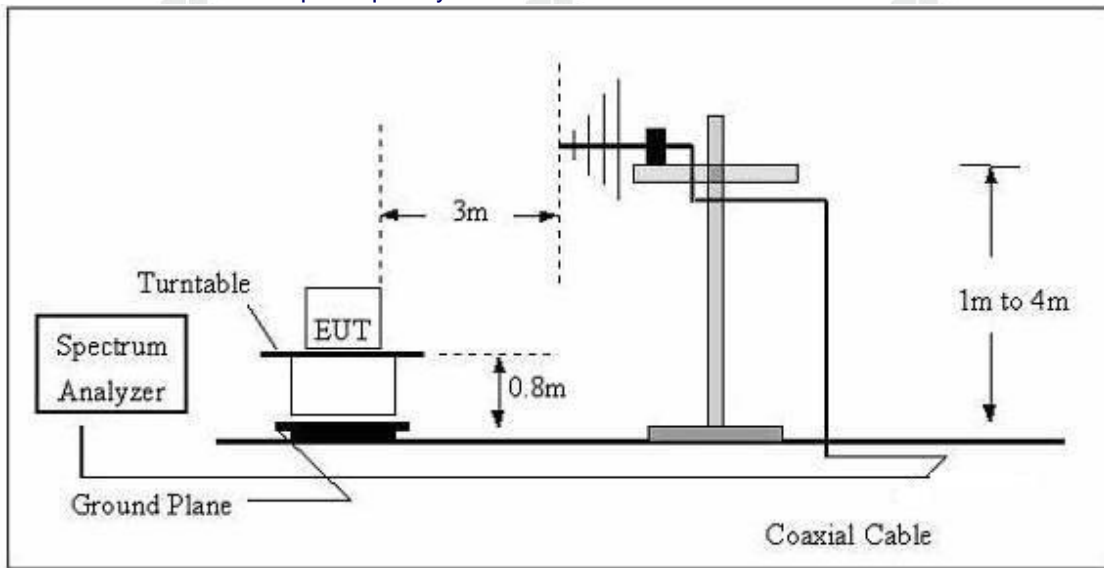

(C) Radiated Emission Test-Up Frequency Above 1GHz

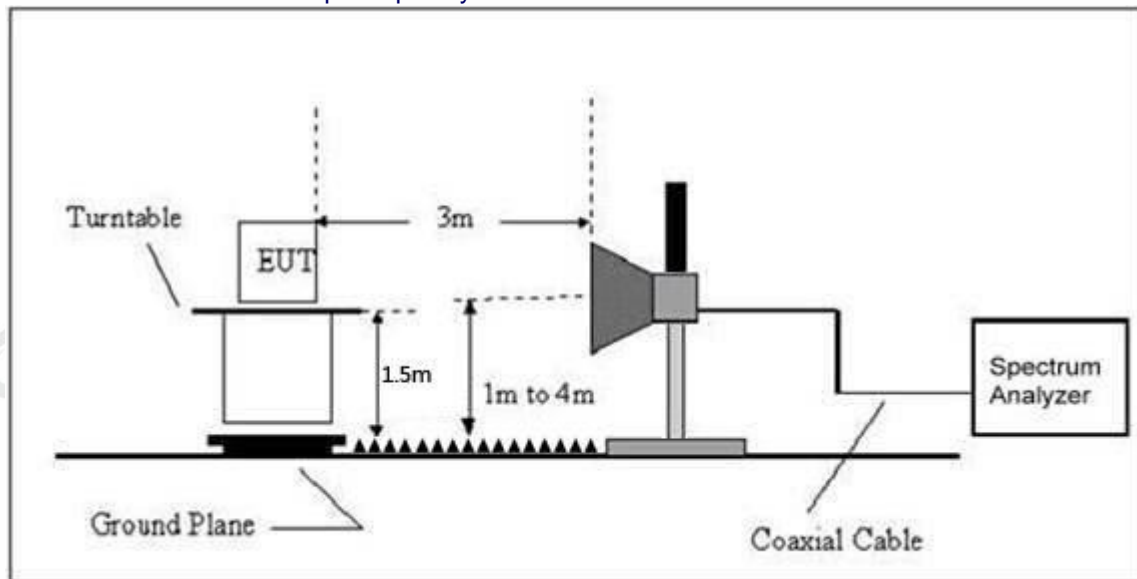

4.2.5 EUT OPERATING CONDITIONS

The EUT tested system was configured as the statements of 2.4 Unless otherwise a special operating condition is specified in the follows during the testing.



4.2.6 TEST RESULTS

Between 9KHz – 30MHz

The emission from 9 kHz to 30MHz was pre-tested and found the result was 20dB lower than the limit, and according to 15.31(o), the test result no need to reported.

Between 30MHz – 1GHz

Temperature:	25.6 °C	Relative Humidity:	47%
Pressure:	101 kPa	Polarization:	Horizontal
Test Voltage:	DC 3.7 V		

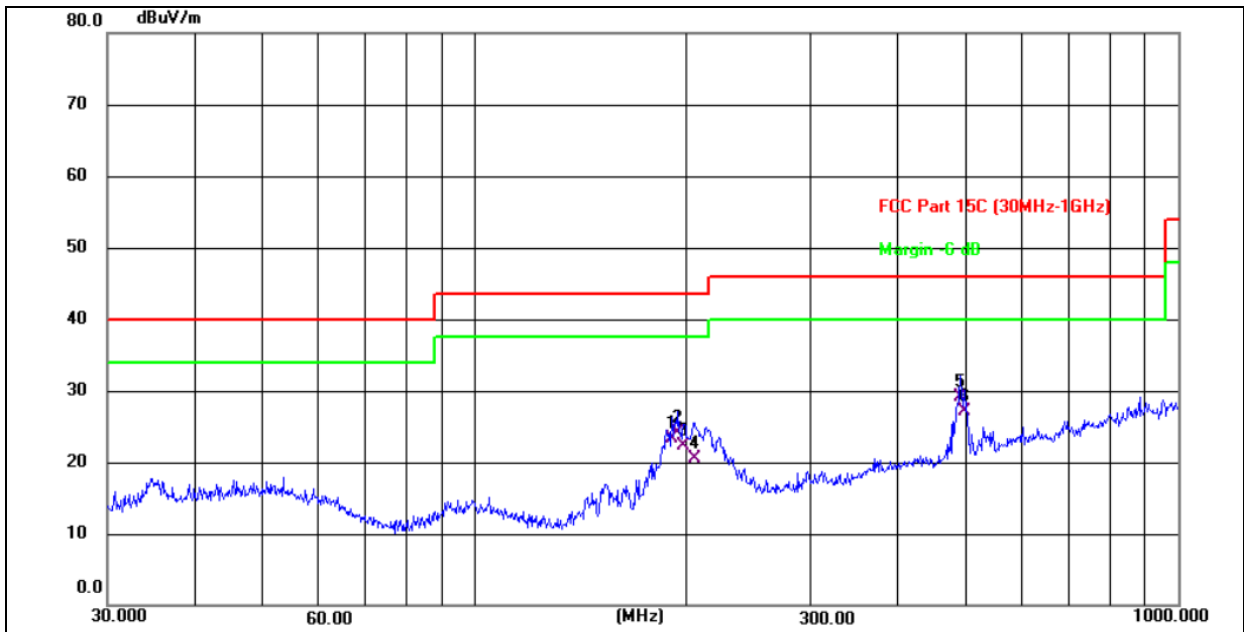

No.	Frequency (MHz)	Reading (dBuV)	Factor (dB/m)	Level (dBuV/m)	Limit (dBuV/m)	Margin (dB)	Detector
1	190.4050	34.80	-11.58	23.22	43.50	-20.28	QP
2	194.4534	35.35	-11.29	24.06	43.50	-19.44	QP
3	197.8928	33.33	-11.04	22.29	43.50	-21.21	QP
4	204.9551	31.22	-10.70	20.52	43.50	-22.98	QP
5 *	489.0268	33.30	-4.27	29.03	46.00	-16.97	QP
6	495.9344	31.35	-4.16	27.19	46.00	-18.81	QP



ZHONGHAN

Temperature:	25.6°C	Relative Humidity:	47%
Pressure:	101 kPa	Polarization:	Vertical
Test Voltage:	DC 3.7 V		

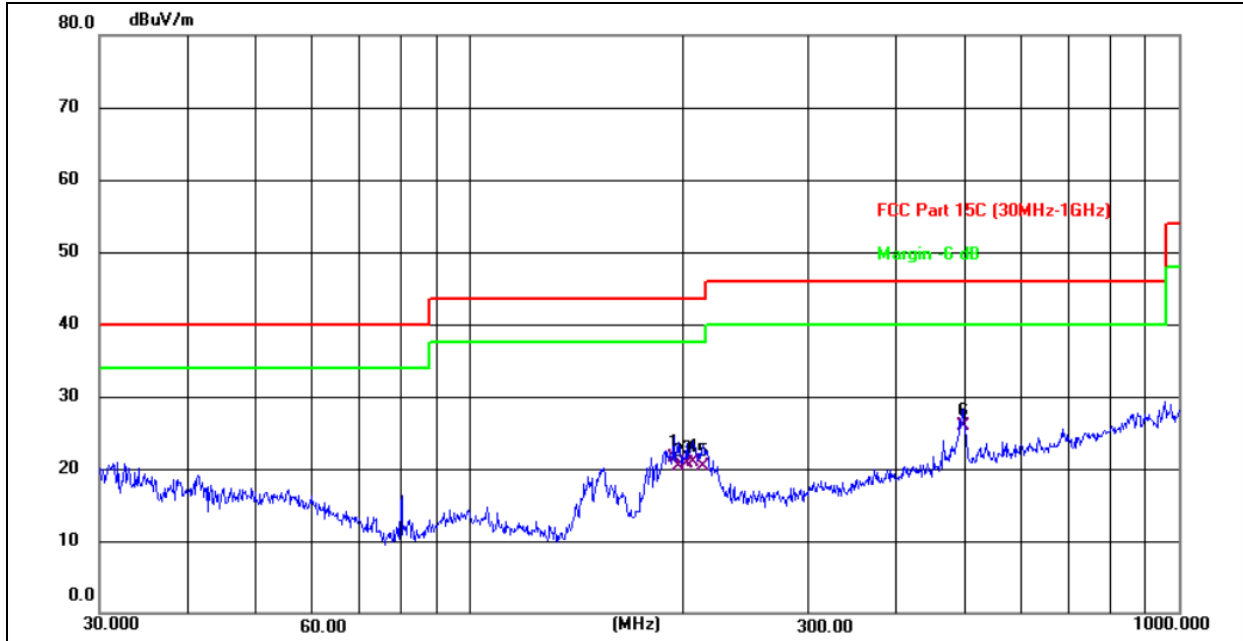

No.	Frequency (MHz)	Reading (dBuV)	Factor (dB/m)	Level (dBuV/m)	Limit (dBuV/m)	Margin (dB)	Detector
1	193.7727	32.79	-11.34	21.45	43.50	-22.05	QP
2	197.2001	31.45	-11.09	20.36	43.50	-23.14	QP
3	202.1004	31.46	-10.81	20.65	43.50	-22.85	QP
4	206.3975	31.51	-10.65	20.86	43.50	-22.64	QP
5	213.0151	30.77	-10.41	20.36	43.50	-23.14	QP
6 *	495.9344	30.12	-4.16	25.96	46.00	-20.04	QP



1GHz~25GHz

GFSK

Polar (H/V)	Frequency	Meter Reading	Pre-amplifier	Cable Loss	Antenna Factor	Emission Level	Limits	Margin	Detector Type
	(MHz)	(dBuV)	(dB)	(dB)	(dB)	(dBuV/m)	(dBuV/m)	(dB)	
Low Channel:2402MHz									
V	4804	58.51	30.55	5.77	24.66	58.39	74	-15.61	Pk
V	4804	41	30.55	5.77	24.66	40.88	54	-13.12	AV
V	7206	55.15	30.33	6.32	24.55	55.69	74	-18.31	Pk
V	7206	44.19	30.33	6.32	24.55	44.73	54	-9.27	AV
H	4804	56.72	30.55	5.77	24.66	56.6	74	-17.4	Pk
H	4804	41.77	30.55	5.77	24.66	41.65	54	-12.35	AV
H	7206	57.62	30.33	6.32	24.55	58.16	74	-15.84	Pk
H	7206	42.91	30.33	6.32	24.55	43.45	54	-10.55	AV
Middle Channel:2441MHz									
V	4882	56.66	30.55	5.77	24.66	56.54	74	-17.46	Pk
V	4882	41.83	30.55	5.77	24.66	41.71	54	-12.29	AV
V	7323	58.1	30.33	6.32	24.55	58.64	74	-15.36	Pk
V	7323	41.72	30.33	6.32	24.55	42.26	54	-11.74	AV
H	4882	57.94	30.55	5.77	24.66	57.82	74	-16.18	Pk
H	4882	41.87	30.55	5.77	24.66	41.75	54	-12.25	AV
H	7323	58.84	30.33	6.32	24.55	59.38	74	-14.62	Pk
H	7323	41.57	30.33	6.32	24.55	42.11	54	-11.89	AV
High Channel:2480MHz									
V	4960	57.74	30.55	5.77	24.66	57.62	74	-16.38	Pk
V	4960	41.98	30.55	5.77	24.66	41.86	54	-12.14	AV
V	7440	56.44	30.33	6.32	24.55	56.98	74	-17.02	Pk
V	7440	42.84	30.33	6.32	24.55	43.38	54	-10.62	AV
H	4960	58.38	30.55	5.77	24.66	58.26	74	-15.74	Pk
H	4960	43.52	30.55	5.77	24.66	43.4	54	-10.6	AV
H	7440	55.94	30.33	6.32	24.55	56.48	74	-17.52	Pk
H	7440	41.26	30.33	6.32	24.55	41.8	54	-12.2	AV



$\pi/4$ DQPSK

Polar (H/V)	Frequency	Meter Reading	Pre-amplifier	Cable Loss	Antenna Factor	Emission Level	Limits	Margin	Detector Type
	(MHz)	(dBuV)	(dB)	(dB)	(dB)	(dBuV/m)	(dBuV/m)	(dB)	
Low Channel:2402MHz									
V	4804	56.67	30.55	5.77	24.66	56.55	74	-17.45	Pk
V	4804	43.59	30.55	5.77	24.66	43.47	54	-10.53	AV
V	7206	59.16	30.33	6.32	24.55	59.7	74	-14.3	Pk
V	7206	41.21	30.33	6.32	24.55	41.75	54	-12.25	AV
H	4804	56.15	30.55	5.77	24.66	56.03	74	-17.97	Pk
H	4804	42.57	30.55	5.77	24.66	42.45	54	-11.55	AV
H	7206	56.34	30.33	6.32	24.55	56.88	74	-17.12	Pk
H	7206	44.83	30.33	6.32	24.55	45.37	54	-8.63	AV
Middle Channel:2441MHz									
V	4882	59.51	30.55	5.77	24.66	59.39	74	-14.61	Pk
V	4882	41.07	30.55	5.77	24.66	40.95	54	-13.05	AV
V	7323	59.64	30.33	6.32	24.55	60.18	74	-13.82	Pk
V	7323	43.15	30.33	6.32	24.55	43.69	54	-10.31	AV
H	4882	56.28	30.55	5.77	24.66	56.16	74	-17.84	Pk
H	4882	41.3	30.55	5.77	24.66	41.18	54	-12.82	AV
H	7323	56.64	30.33	6.32	24.55	57.18	74	-16.82	Pk
H	7323	41.66	30.33	6.32	24.55	42.2	54	-11.8	AV
High Channel:2480MHz									
V	4960	59.82	30.55	5.77	24.66	59.7	74	-14.3	Pk
V	4960	41.28	30.55	5.77	24.66	41.16	54	-12.84	AV
V	7440	55.36	30.33	6.32	24.55	55.9	74	-18.1	Pk
V	7440	44.91	30.33	6.32	24.55	45.45	54	-8.55	AV
H	4960	55.85	30.55	5.77	24.66	55.73	74	-18.27	Pk
H	4960	44.88	30.55	5.77	24.66	44.76	54	-9.24	AV
H	7440	57.57	30.33	6.32	24.55	58.11	74	-15.89	Pk
H	7440	42.95	30.33	6.32	24.55	43.49	54	-10.51	AV



8DPSK

Polar (H/V)	Frequency	Meter Reading	Pre-amplifier	Cable Loss	Antenna Factor	Emission Level	Limits	Margin	Detector Type
	(MHz)	(dBuV)	(dB)	(dB)	(dB)	(dBuV/m)	(dBuV/m)	(dB)	
Low Channel:2402MHz									
V	4804	56.76	30.55	5.77	24.66	56.64	74	-17.36	Pk
V	4804	42.15	30.55	5.77	24.66	42.03	54	-11.97	AV
V	7206	57.22	30.33	6.32	24.55	57.76	74	-16.24	Pk
V	7206	43.27	30.33	6.32	24.55	43.81	54	-10.19	AV
H	4804	56.43	30.55	5.77	24.66	56.31	74	-17.69	Pk
H	4804	41.15	30.55	5.77	24.66	41.03	54	-12.97	AV
H	7206	57.36	30.33	6.32	24.55	57.9	74	-16.1	Pk
H	7206	41.14	30.33	6.32	24.55	41.68	54	-12.32	AV
Middle Channel:2441MHz									
V	4882	55.01	30.55	5.77	24.66	54.89	74	-19.11	Pk
V	4882	41.77	30.55	5.77	24.66	41.65	54	-12.35	AV
V	7323	57.64	30.33	6.32	24.55	58.18	74	-15.82	Pk
V	7323	41.48	30.33	6.32	24.55	42.02	54	-11.98	AV
H	4882	56.01	30.55	5.77	24.66	55.89	74	-18.11	Pk
H	4882	41.07	30.55	5.77	24.66	40.95	54	-13.05	AV
H	7323	57.09	30.33	6.32	24.55	57.63	74	-16.37	Pk
H	7323	41.04	30.33	6.32	24.55	41.58	54	-12.42	AV
High Channel:2480MHz									
V	4960	56.8	30.55	5.77	24.66	56.68	74	-17.32	Pk
V	4960	41.56	30.55	5.77	24.66	41.44	54	-12.56	AV
V	7440	56	30.33	6.32	24.55	56.54	74	-17.46	Pk
V	7440	42.54	30.33	6.32	24.55	43.08	54	-10.92	AV
H	4960	57.13	30.55	5.77	24.66	57.01	74	-16.99	Pk
H	4960	43.11	30.55	5.77	24.66	42.99	54	-11.01	AV
H	7440	59.76	30.33	6.32	24.55	60.3	74	-13.7	Pk
H	7440	41.16	30.33	6.32	24.55	41.7	54	-12.3	AV

Remark:

1. Emission Level = Meter Reading + Antenna Factor + Cable Loss – Pre-amplifier, Margin= Emission Level - Limit
2. If peak below the average limit, the average emission was no test.
3. The amplitude of spurious emissions which are attenuated by more than 20dB below the permissible value has no need to be reported.

Remark:

1. Emission Level = Meter Reading + Antenna Factor + Cable Loss – Pre-amplifier, Margin= Emission Level - Limit
2. If peak below the average limit, the average emission was no test.
3. The amplitude of spurious emissions which are attenuated by more than 20dB below the permissible value has no need to be reported.



ZHONGHAN

5. RADIATED BAND EMISSION MEASUREMENT

5.1 Test Requirement:

Test Requirement:	FCC Part15 C Section 15.209 and 15.205				
Test Method:	ANSI C63.10: 2013				
Test Frequency Range:	All of the restrict bands were tested, only the worst band's (2310MHz to 2500MHz) data was showed.				
Test site:	Measurement Distance: 3m				
Receiver setup:	Frequency	Detector	RBW	VBW	Value
	Above 1GHz	Peak	1MHz	3MHz	Peak
		Average	1MHz	3MHz	Average

LIMITS OF RADIATED EMISSION MEASUREMENT (Above 1000MHz)

FREQUENCY (MHz)	Limit (dBuV/m) (at 3M)	
	PEAK	AVERAGE
Above 1000	74	54

Notes:

- (1) The limit for radiated test was performed according to FCC PART 15C.
- (2) The tighter limit applies at the band edges.
- (3) Emission level (dBuV/m)=20log Emission level (uV/m).

Spectrum Parameter	Setting
Attenuation	Auto
Start Frequency	2300MHz
Stop Frequency	2520
RB / VB (emission in restricted band)	1 MHz / 1 MHz for Peak, 1 MHz / 10Hz for Average

5.2 TEST PROCEDURE

Above 1GHz test procedure as below:

- a. 1. The EUT was placed on the top of a rotating table 1.5 meters above the ground at a 3 meter camber. The table was rotated 360 degrees to determine the position of the highest radiation.
- b. The EUT was set 3 meters away from the interference-receiving antenna, which was mounted on the top of a variable-height antenna tower.
- c. The antenna height is varied from one meter to four meters above the ground to determine the maximum value of the field strength. Both horizontal and vertical polarizations of the antenna are set to make the measurement.
- d. For each suspected emission, the EUT was arranged to its worst case and then the antenna was tuned to heights from 1 meter to 4 meters and the rota table was turned from 0 degrees to 360 degrees to find the maximum reading.
- e. The test-receiver system was set to Peak Detect Function and Specified Bandwidth with Maximum Hold Mode.
- f. If the emission level of the EUT in peak mode was 10dB lower than the limit specified, then testing could be stopped and the peak values of the EUT would be reported. Otherwise the emissions that did not have 10dB margin would be re-tested one by one using peak, quasi-peak or average method as specified and then reported in a data sheet.
- g. Test the EUT in the lowest channel,the Highest channel

Note:

Both horizontal and vertical antenna polarities were tested and performed pretest to three orthogonal axis. The worst case emissions were reported

5.3 DEVIATION FROM TEST STANDARD

No deviation

5.4 TEST SETUP

Radiated Emission Test-Up Frequency Above 1GHz

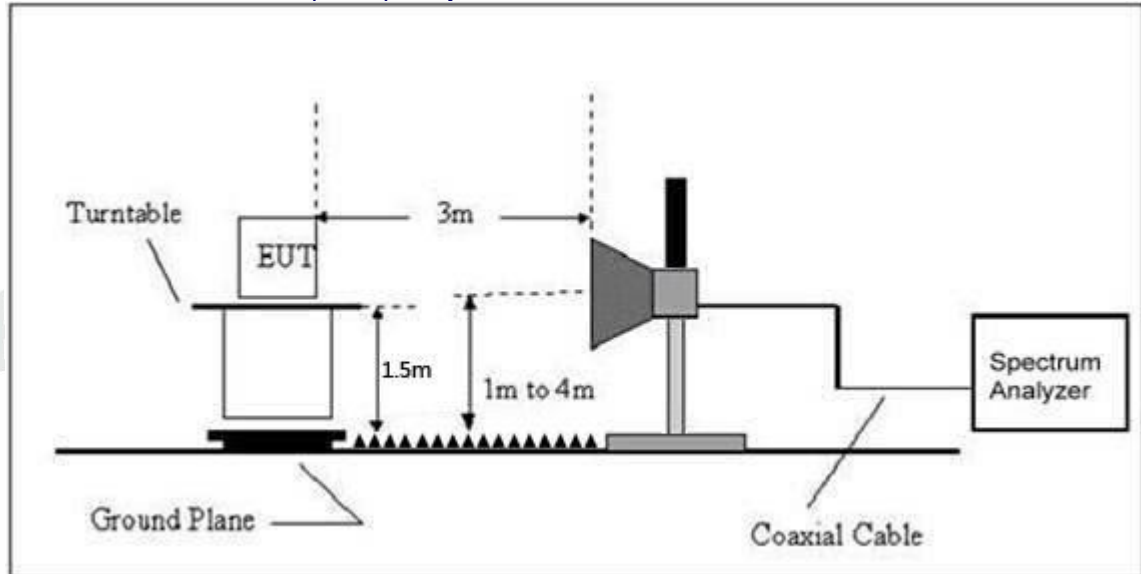

5.5 EUT OPERATING CONDITIONS

The EUT tested system was configured as the statements of 2.3 Unless otherwise a special operating condition is specified in the follows during the testing.



5.6 TEST RESULT

	Polar (H/V)	Frequency (MHz)	Meter Reading (dBuV)	Pre-amplifier (dB)	Cable Loss (dB)	Antenna Factor (dB/m)	Emission level (dBuV/m)	Limit (dBuV/m)	Margin (dB)	Detector Type	Result
GFSK	Low Channel: 2402MHz										
	H	2390.00	62.94	30.22	4.85	23.98	61.55	74.00	-12.45	PK	PASS
	H	2390.00	46.96	30.22	4.85	23.98	45.57	54.00	-8.43	AV	PASS
	H	2400.00	61.17	30.22	4.85	23.98	59.78	74.00	-14.22	PK	PASS
	H	2400.00	48.10	30.22	4.85	23.98	46.71	54.00	-7.29	AV	PASS
	V	2390.00	62.81	30.22	4.85	23.98	61.42	74.00	-12.58	PK	PASS
	V	2390.00	48.03	30.22	4.85	23.98	46.64	54.00	-7.36	AV	PASS
	V	2400.00	60.77	30.22	4.85	23.98	59.38	74.00	-14.62	PK	PASS
	V	2400.00	47.43	30.22	4.85	23.98	46.04	54.00	-7.96	AV	PASS
	High Channel: 2480MHz										
	H	2483.50	61.37	30.22	4.85	23.98	59.98	74.00	-14.02	PK	PASS
	H	2483.50	49.00	30.22	4.85	23.98	47.61	54.00	-6.39	AV	PASS
	H	2500.00	59.30	30.22	4.85	23.98	57.91	74.00	-16.09	PK	PASS
	H	2500.00	46.44	30.22	4.85	23.98	45.05	54.00	-8.95	AV	PASS
	V	2483.50	62.82	30.22	4.85	23.98	61.43	74.00	-12.57	PK	PASS
	V	2483.50	48.66	30.22	4.85	23.98	47.27	54.00	-6.73	AV	PASS
V	2500.00	59.82	30.22	4.85	23.98	58.43	74.00	-15.57	PK	PASS	
V	2500.00	46.93	30.22	4.85	23.98	45.54	54.00	-8.46	AV	PASS	
π/4DQPSK	Low Channel: 2402MHz										
	H	2390.00	62.23	30.22	4.85	23.98	60.84	74.00	-13.16	PK	PASS
	H	2390.00	46.80	30.22	4.85	23.98	45.41	54.00	-8.59	AV	PASS
	H	2400.00	61.42	30.22	4.85	23.98	60.03	74.00	-13.97	PK	PASS
	H	2400.00	46.55	30.22	4.85	23.98	45.16	54.00	-8.84	AV	PASS
	V	2390.00	62.37	30.22	4.85	23.98	60.98	74.00	-13.02	PK	PASS
	V	2390.00	48.84	30.22	4.85	23.98	47.45	54.00	-6.55	AV	PASS
	V	2400.00	61.55	30.22	4.85	23.98	60.16	74.00	-13.84	PK	PASS
	V	2400.00	46.48	30.22	4.85	23.98	45.09	54.00	-8.91	AV	PASS
	High Channel: 2480MHz										
	H	2483.50	60.90	30.22	4.85	23.98	59.51	74.00	-14.49	PK	PASS
	H	2483.50	47.63	30.22	4.85	23.98	46.24	54.00	-7.76	AV	PASS
	H	2500.00	61.77	30.22	4.85	23.98	60.38	74.00	-13.62	PK	PASS
	H	2500.00	48.30	30.22	4.85	23.98	46.91	54.00	-7.09	AV	PASS
	V	2483.50	59.15	30.22	4.85	23.98	57.76	74.00	-16.24	PK	PASS
	V	2483.50	46.69	30.22	4.85	23.98	45.30	54.00	-8.70	AV	PASS
V	2500.00	60.80	30.22	4.85	23.98	59.41	74.00	-14.59	PK	PASS	
V	2500.00	47.51	30.22	4.85	23.98	46.12	54.00	-7.88	AV	PASS	
8DPSK	Low Channel: 2402MHz										
	H	2390.00	61.07	30.22	4.85	23.98	59.68	74.00	-14.32	PK	PASS
	H	2390.00	48.88	30.22	4.85	23.98	47.49	54.00	-6.51	AV	PASS
	H	2400.00	60.85	30.22	4.85	23.98	59.46	74.00	-14.54	PK	PASS
	H	2400.00	47.85	30.22	4.85	23.98	46.46	54.00	-7.54	AV	PASS
	V	2390.00	62.52	30.22	4.85	23.98	61.13	74.00	-12.87	PK	PASS
	V	2390.00	47.56	30.22	4.85	23.98	46.17	54.00	-7.83	AV	PASS
	V	2400.00	62.81	30.22	4.85	23.98	61.42	74.00	-12.58	PK	PASS
	V	2400.00	46.27	30.22	4.85	23.98	44.88	54.00	-9.12	AV	PASS
	High Channel: 2480MHz										
H	2483.50	62.10	30.22	4.85	23.98	60.71	74.00	-13.29	PK	PASS	
H	2483.50	46.40	30.22	4.85	23.98	45.01	54.00	-8.99	AV	PASS	



ZHONGHAN

H	2500.00	59.04	30.22	4.85	23.98	57.65	74.00	-16.35	PK	PASS
H	2500.00	46.26	30.22	4.85	23.98	44.87	54.00	-9.13	AV	PASS
V	2483.50	62.46	30.22	4.85	23.98	61.07	74.00	-12.93	PK	PASS
V	2483.50	48.37	30.22	4.85	23.98	46.98	54.00	-7.02	AV	PASS
V	2500.00	62.61	30.22	4.85	23.98	61.22	74.00	-12.78	PK	PASS
V	2500.00	47.96	30.22	4.85	23.98	46.57	54.00	-7.43	AV	PASS



6. CONDUCTED BAND EDGE AND SPURIOUS EMISSION

Test Requirement:	FCC Part15 C Section 15.247 (d)
Test Method:	KDB558074 D0115.247 Meas Guidancev05r02

6.1 Limit

Regulation 15.247 (d), In any 100 kHz bandwidth outside the frequency band in which the spread spectrum or digitally modulated intentional radiator is operating, the radio frequency power that is produced by the intentional radiator shall be at least 20 dB below that in the 100 kHz bandwidth within the band that contains the highest level of the desired power, based on either an RF conducted or a radiated measurement, provided the transmitter demonstrates compliance with the peak conducted power limits. If the transmitter complies with the conducted power limits based on the use of RMS averaging over a time interval, as permitted under paragraph (b)(3) of this section, the attenuation required under this paragraph shall be 30 dB instead of 20 dB. Attenuation below the general limits specified in §15.209(a) is not required. In addition, radiated emissions which fall in the restricted bands, as defined in §15.205(a), must also comply with the radiated emission limits specified in §15.209(a) (see §15.205(c)).

6.2 Test Setup



6.3 Test procedure

Using the following spectrum analyzer setting:

- A) Set the RBW = 100KHz.
- B) Set the VBW = 300KHz.
- C) Sweep time = auto couple.
- D) Detector function = peak.
- E) Trace mode = max hold.
- F) Allow trace to fully stabilize.

6.4 DEVIATION FROM STANDARD

No deviation.

6.5 Test Result

Please refer to the Appendix BT



7. 20DB&99% BANDWIDTH

Test Requirement:	FCC Part15 C Section 15.247 (a)(1)
Test Method:	ANSI C63.10:2013

7.1 Test Setup



7.2 Limit
N/A

7.3 Test procedure

1. Set RBW = 30 kHz.
2. Set the video bandwidth (VBW) $\geq 3 \times$ RBW.
3. Detector = Peak.
4. Trace mode = max hold.
5. Sweep = auto couple.
6. Allow the trace to stabilize.
7. Measure the maximum width of the emission that is constrained by the frequencies associated with the two outermost amplitude points (upper and lower frequencies) that are attenuated by 6 dB relative to the maximum level measured in the fundamental emission.

7.4 DEVIATION FROM STANDARD

No deviation.

7.5 Test Result

Please refer to the Appendix BT



8. Maximum Peak Output Power

Test Requirement:	FCC Part15 C Section 15.247 (b)(1)
Test Method:	ANSI C63.10:2013

8.1 Block Diagram Of Test Setup



8.2 Limit

For frequency hopping systems operating in the 2400-2483.5 MHz band employing at least 75 non-overlapping hopping channels, and all frequency hopping systems in the 5725-5850 MHz band: 1 watt. For all other frequency hopping systems in the 2400-2483.5 MHz band: 0.125 watts.

For FHSs operating in the band 2400-2483.5 MHz, the maximum peak conducted output power shall not exceed 1.0 W if the hopset uses 75 or more hopping channels; the maximum peak conducted output power shall not exceed 0.125 W if the hopset uses less than 75 hopping channels. The e.i.r.p. shall not exceed 4 W.

8.3 Test procedure

The EUT was directly connected to the Power meter

8.4 DEVIATION FROM STANDARD

No deviation.

8.5 Test Result

Please refer to the Appendix BT



9. HOPPING CHANNEL SEPARATION

Test Requirement:	FCC Part15 C Section 15.247 (a)(1)
Test Method:	ANSI C63.10:2013
Receiver setup:	RBW=30KHz, VBW=100KHz, detector=Peak
Limit:	GFSK: 20dB bandwidth $\pi/4$ -DQPSK & 8DSK: 0.025MHz or 2/3 of the 20dB bandwidth (whichever is greater)

9.1 Test Setup



9.2 Test procedure

1. Remove the antenna from the EUT and then connect a low RF cable from the antenna port to the spectrum.
2. Set the spectrum analyzer: RBW = 30kHz. VBW = 100kHz , Span = 2.0MHz. Sweep = auto; Detector Function = Peak. Trace = Max hold.
3. Allow the trace to stabilize. Use the marker-delta function to determine the separation between the peaks of the adjacent channels. The limit is specified in one of the subparagraphs of this Section Submit this plot.

9.3 DEVIATION FROM STANDARD

No deviation.

9.4 Test Result

Please refer to the Appendix BT



ZHONGHAN

10.Number of Hopping Frequency

Test Requirement:	FCC Part15 C Section 15.247 (a)(1)(iii)
Test Method:	ANSI C63.10:2013
Receiver setup:	RBW=100kHz, VBW=300kHz, Frequency range=2400MHz-2483.5MHz, Detector=Peak
Limit:	15 channels

10.1 Test Setup



10.2 Test procedure

1. Remove the antenna from the EUT and then connect a low RF cable from the antenna port to the spectrum.
2. Set the spectrum analyzer: RBW = 100kHz. VBW = 300kHz. Sweep = auto; Detector Function = Peak. Trace = Max hold.
3. Allow the trace to stabilize. It may prove necessary to break the span up to sections. in order to clearly show all of the hopping frequencies. The limit is specified in one of the subparagraphs of this Section.
4. Set the spectrum analyzer: Start Frequency = 2.4GHz, Stop Frequency = 2.4835GHz. Sweep=auto;

10.3 DEVIATION FROM STANDARD

No deviation.

10.4 Test Result

Please refer to the Appendix BT



11. DWELL TIME

Test Requirement:	FCC Part15 C Section 15.247 (a)(1)(iii)
Test Method:	ANSI C63.10:2013
Receiver setup:	RBW=1MHz, VBW=3MHz, Span=0Hz, Detector=Peak
Limit:	0.4 Second

11.1 Test Setup



11.2 Test procedure

1. Remove the antenna from the EUT and then connect a low RF cable from the antenna port to the spectrum.
2. Set spectrum analyzer span = 0Hz;
3. Set RBW = 1MHz and VBW = 3MHz. Sweep = as necessary to capture the entire dwell time per hopping channel. Set the EUT for DH5, DH3 and DH1 packet transmitting.
4. Use the marker-delta function to determine the dwell time. If this value varies with different modes of operation (e.g.. data rate. modulation format. etc.). repeat this test for each variation. The limit is specified in one of the subparagraphs of this Section. Submit this plot(s).

11.3 DEVIATION FROM STANDARD

No deviation.

11.4 Test Result

Please refer to the Appendix BT



12. Antenna Requirement

Standard requirement:	FCC Part15 C Section 15.203 /247(b)(4)
<p>15.203 requirement: An intentional radiator shall be designed to ensure that no antenna other than that furnished by the responsible party shall be used with the device. The use of a permanently attached antenna or of an antenna that uses a unique coupling to the intentional radiator, the manufacturer may design the unit so that a broken antenna can be replaced by the user, but the use of a standard antenna jack or electrical connector is prohibited.</p> <p>15.247(b) (4) requirement: (4) The conducted output power limit specified in paragraph (b) of this section is based on the use of antennas with directional gains that do not exceed 6 dBi. Except as shown in paragraph (c) of this section, if transmitting antennas of directional gain greater than 6 dBi are used, the conducted output power from the intentional radiator shall be reduced below the stated values in paragraphs (b)(1), (b)(2), and (b)(3) of this section, as appropriate, by the amount in dB that the directional gain of the antenna exceeds 6 dBi.</p>	
EUT Antenna:	
The antenna is Ceramic antenna, the best case gain of the antennas is 2.78dBi, reference to the appendix II for details	



13. Appendix BT

13.1 Dwell Time

Mode	Frequency (MHz)	Pulse Time (ms)	Total Dwell Time (ms)	Burst Count	Period Time (ms)	Limit (ms)	Verdict
1-DH1	2441	0.382	121.094	317	31600	400	Pass
1-DH3	2441	1.638	258.804	158	31600	400	Pass
1-DH5	2441	2.886	317.46	110	31600	400	Pass
2-DH1	2441	0.392	125.048	319	31600	400	Pass
2-DH3	2441	1.644	266.328	162	31600	400	Pass
2-DH5	2441	2.892	344.148	119	31600	400	Pass
3-DH1	2441	0.393	124.581	317	31600	400	Pass
3-DH3	2441	1.637	258.646	158	31600	400	Pass
3-DH5	2441	2.892	286.308	99	31600	400	Pass

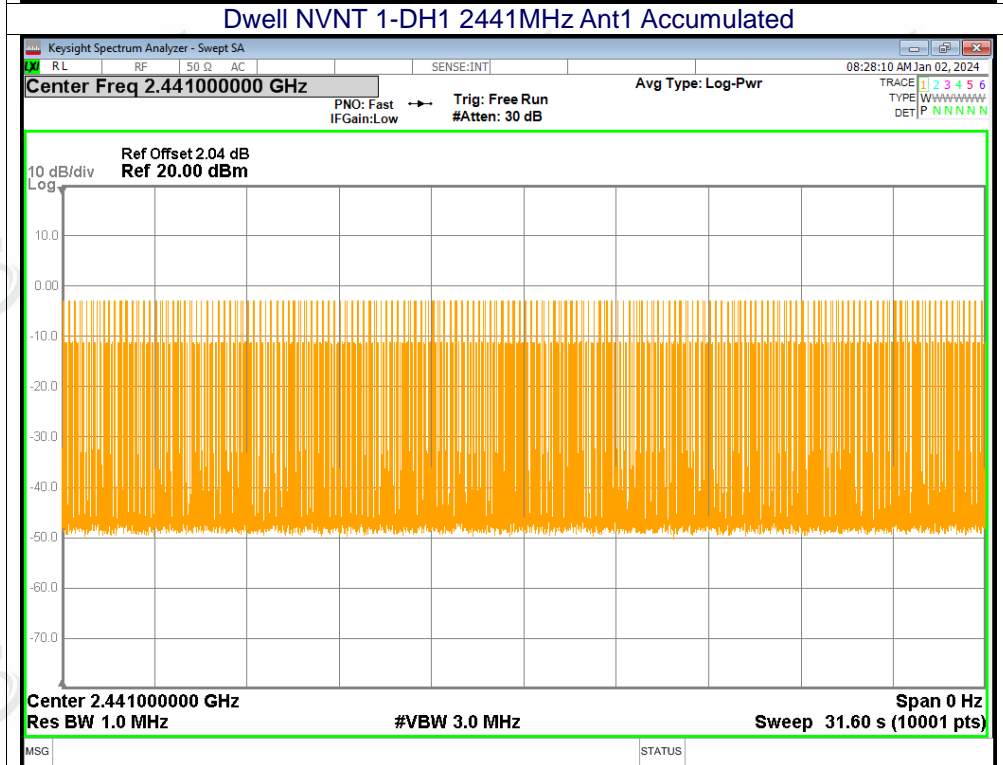
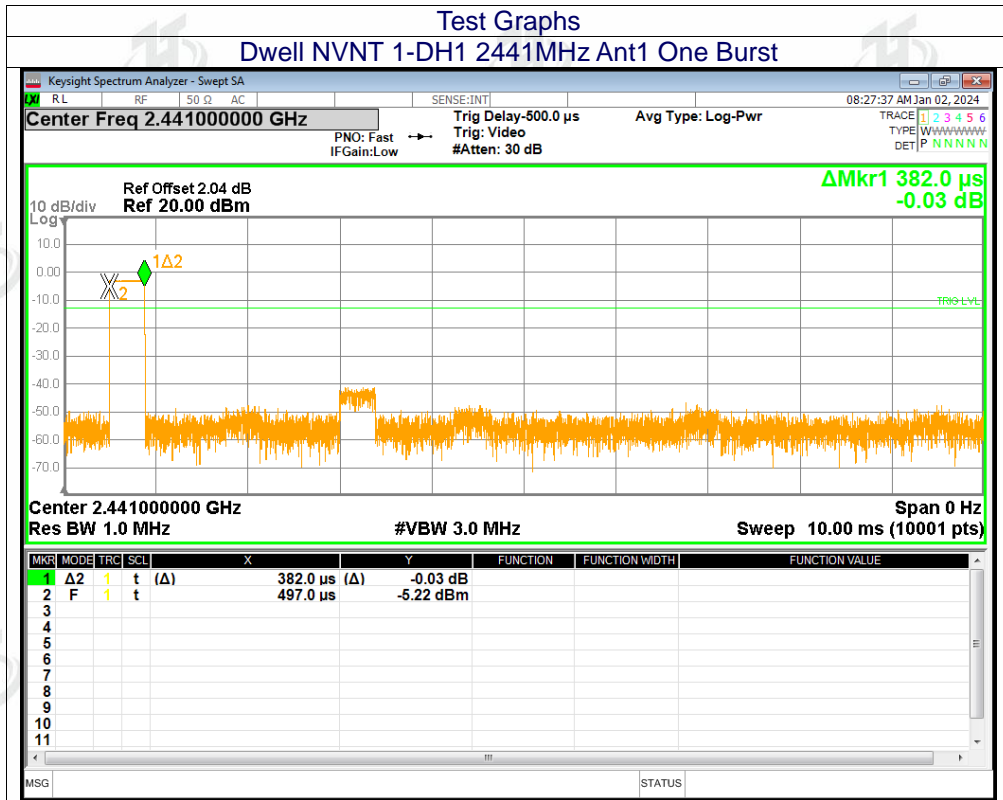

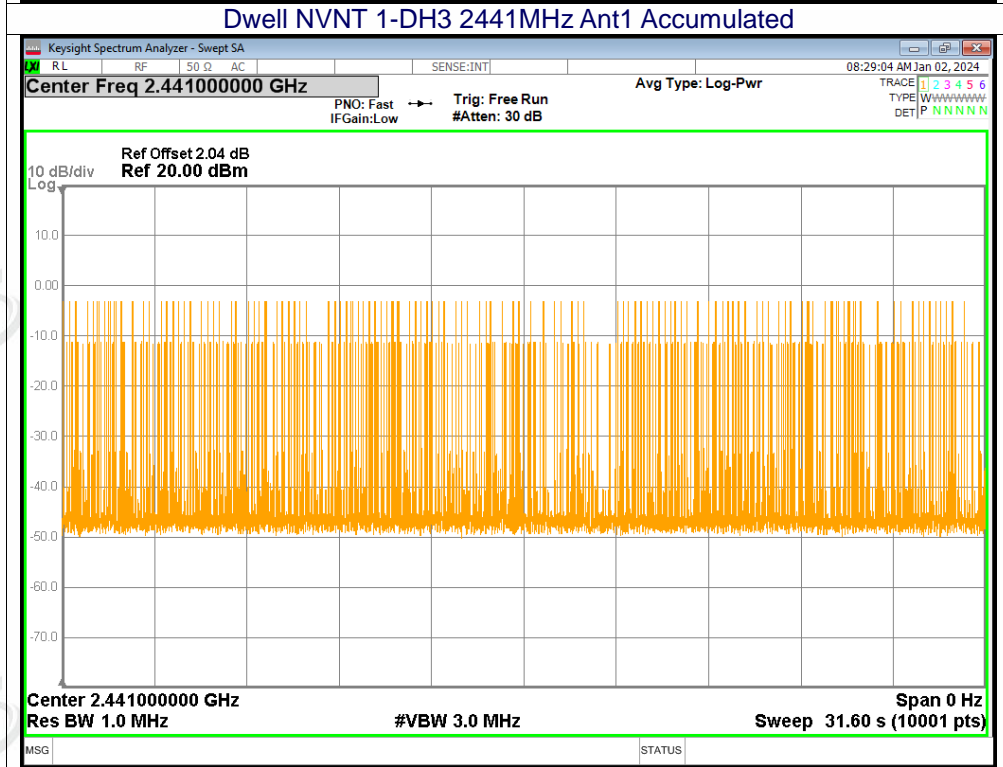
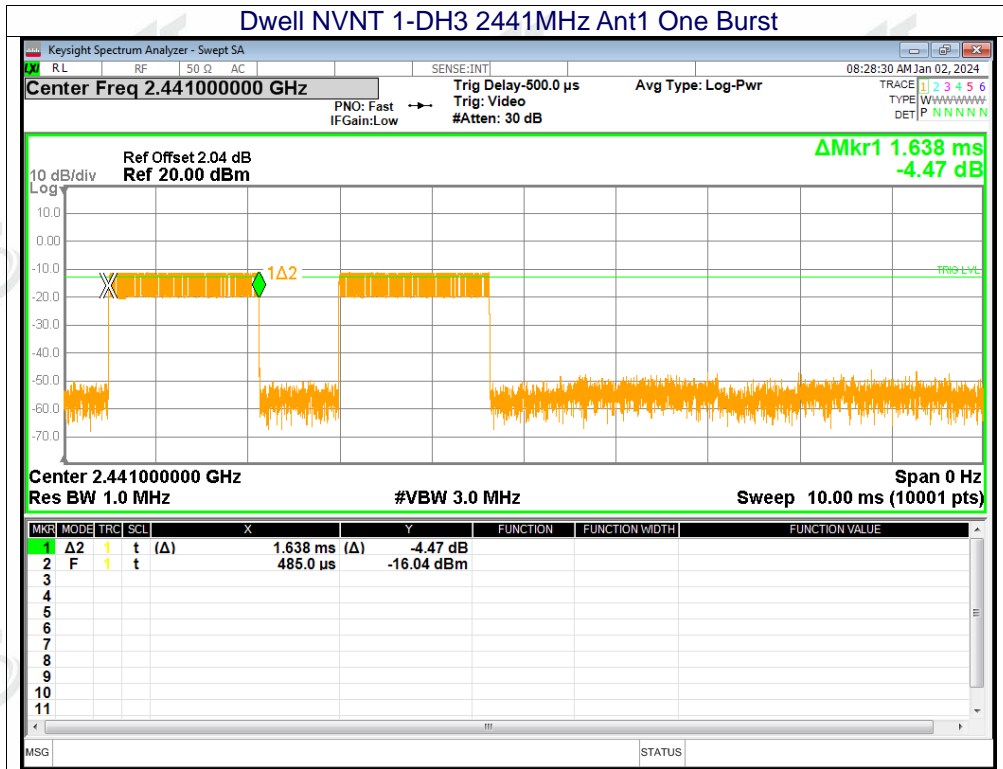

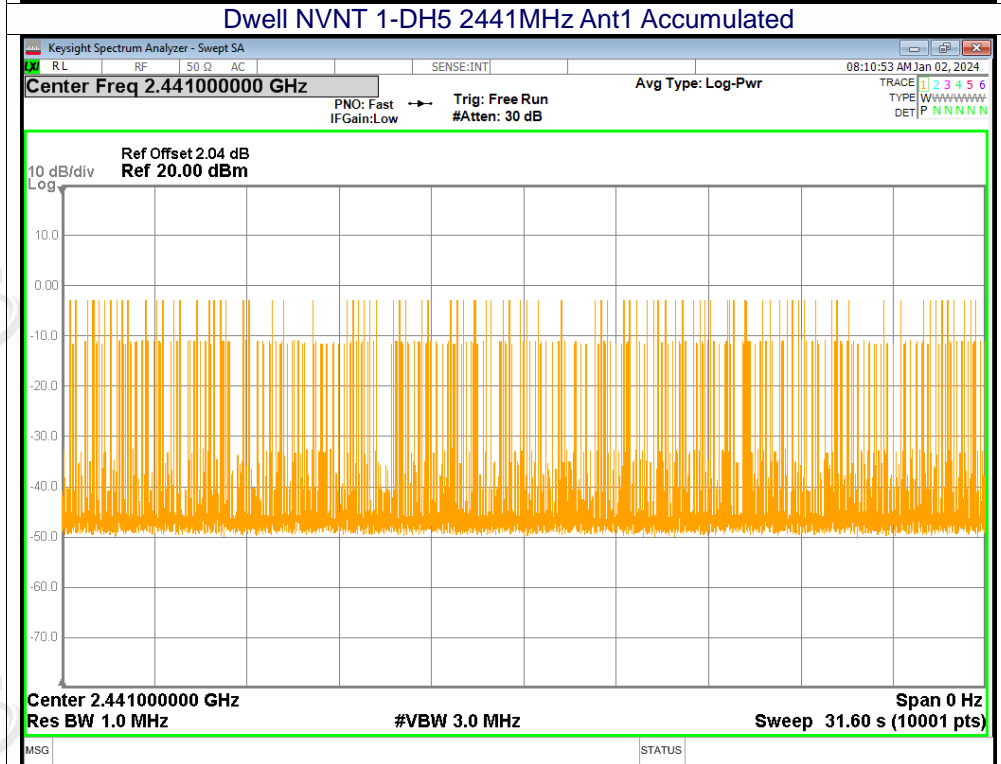
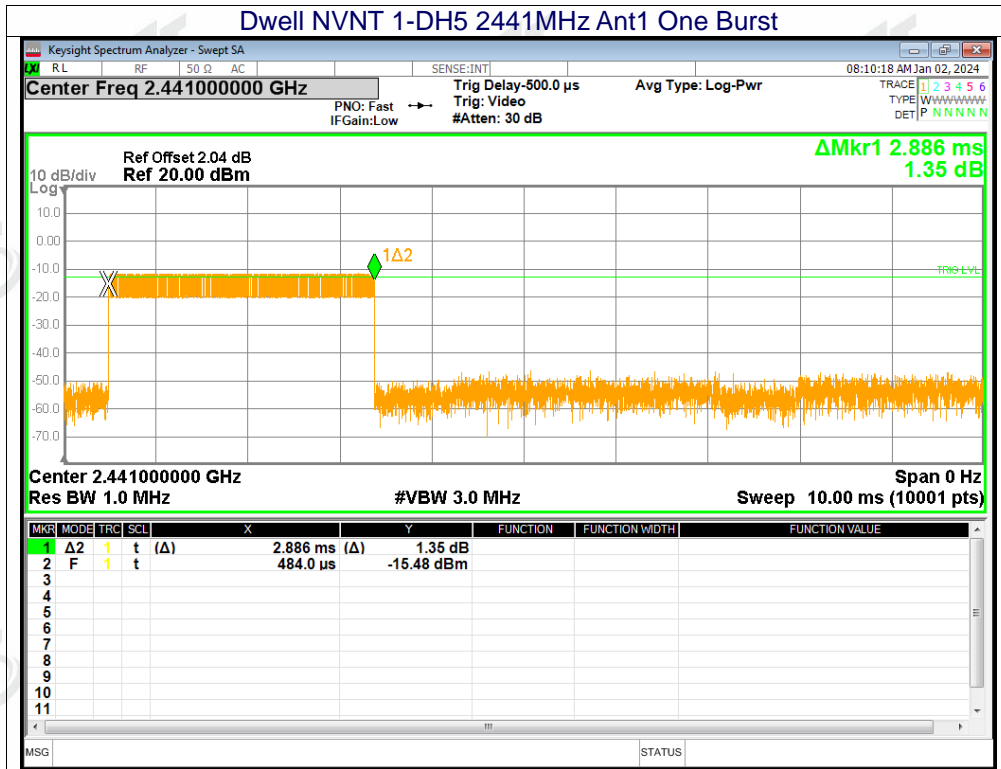

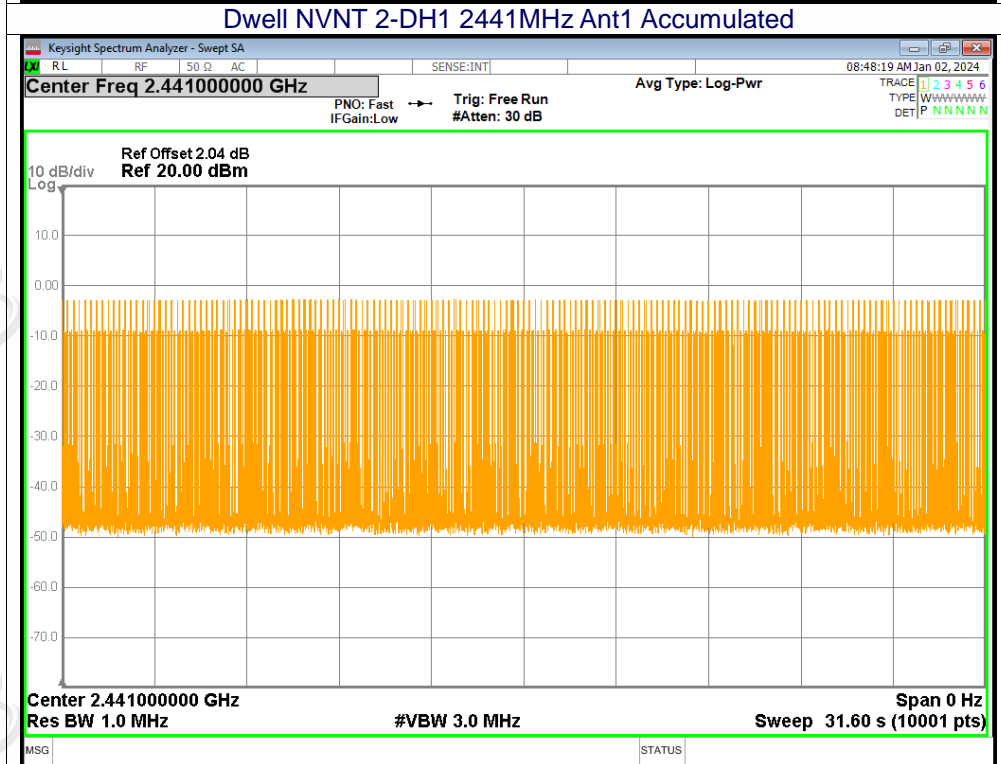
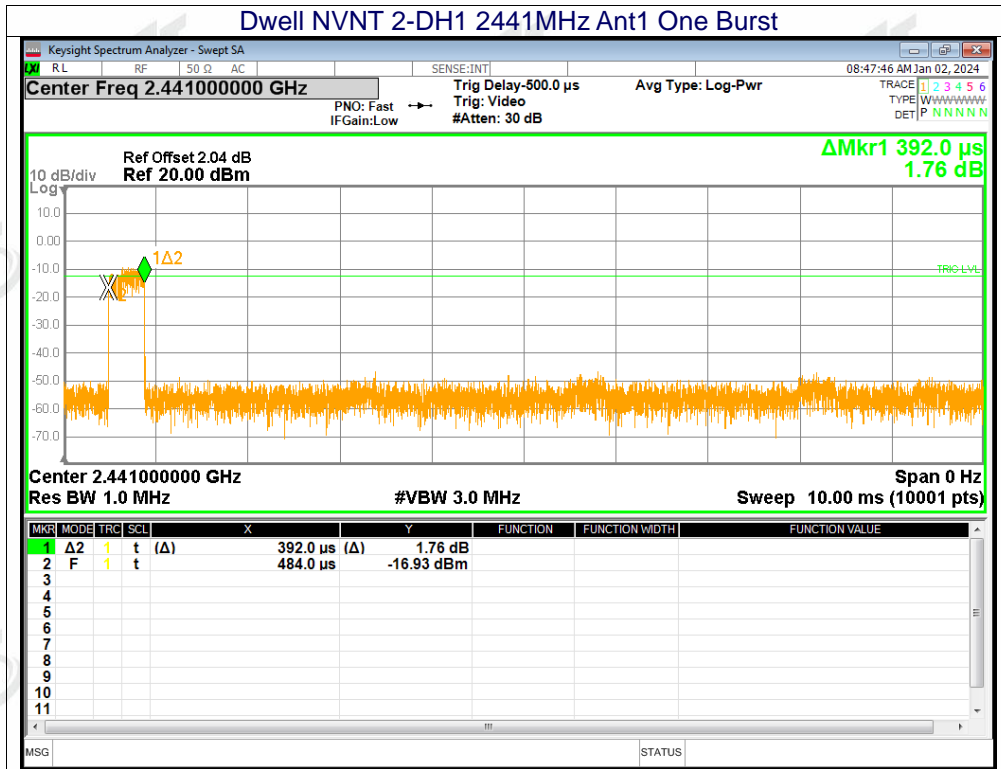

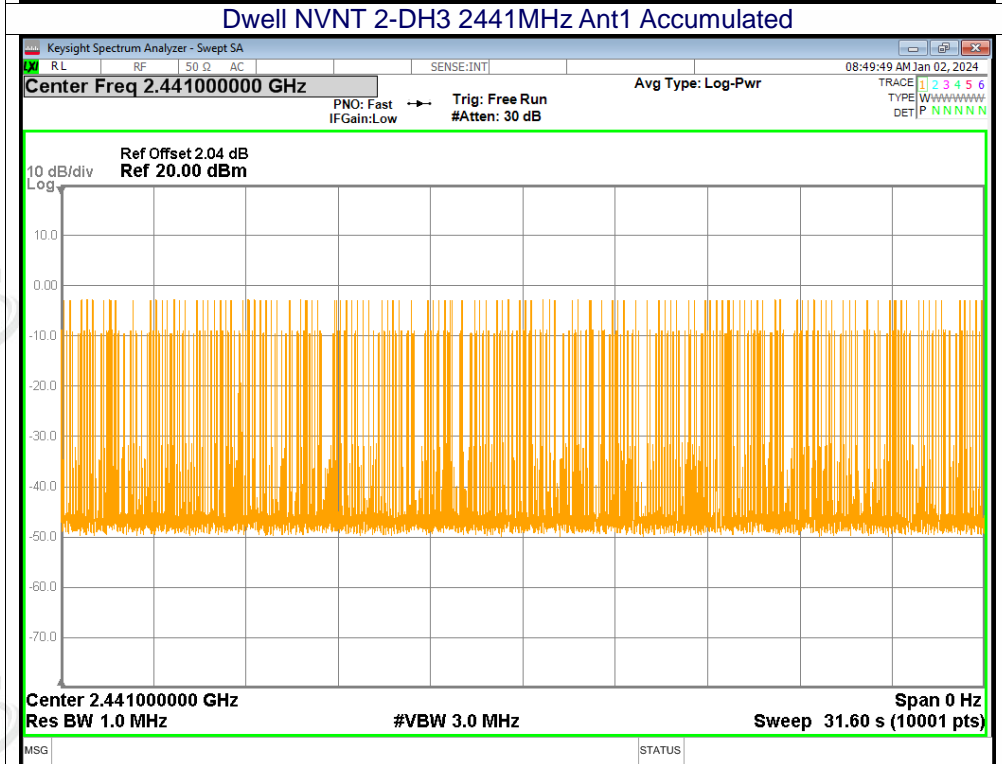
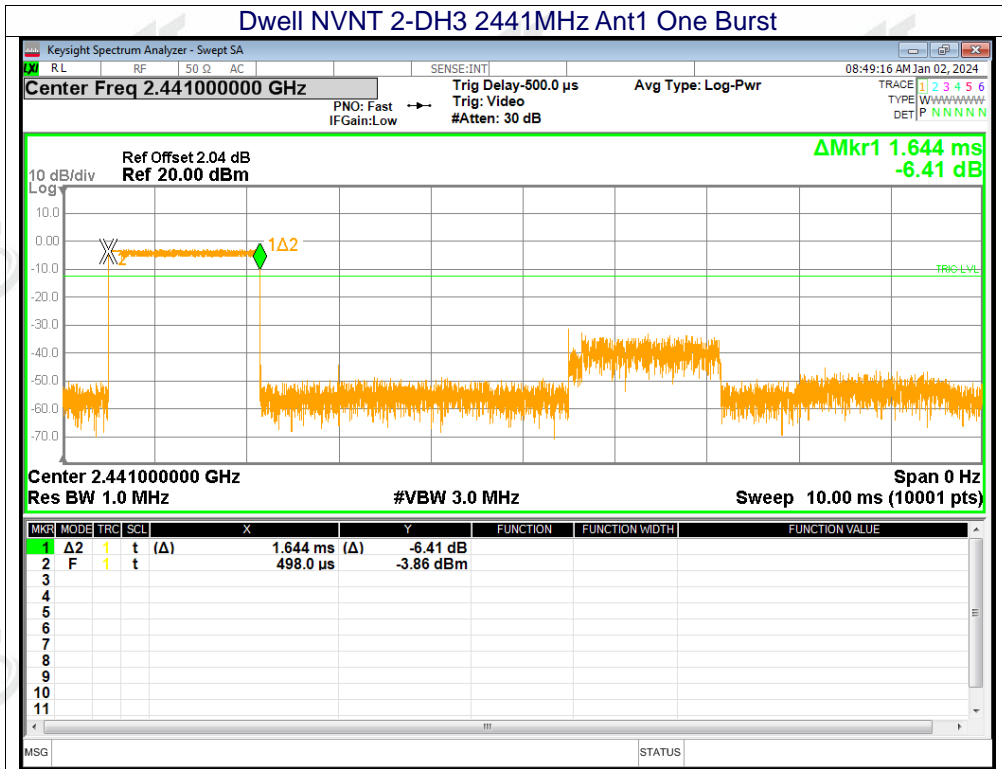

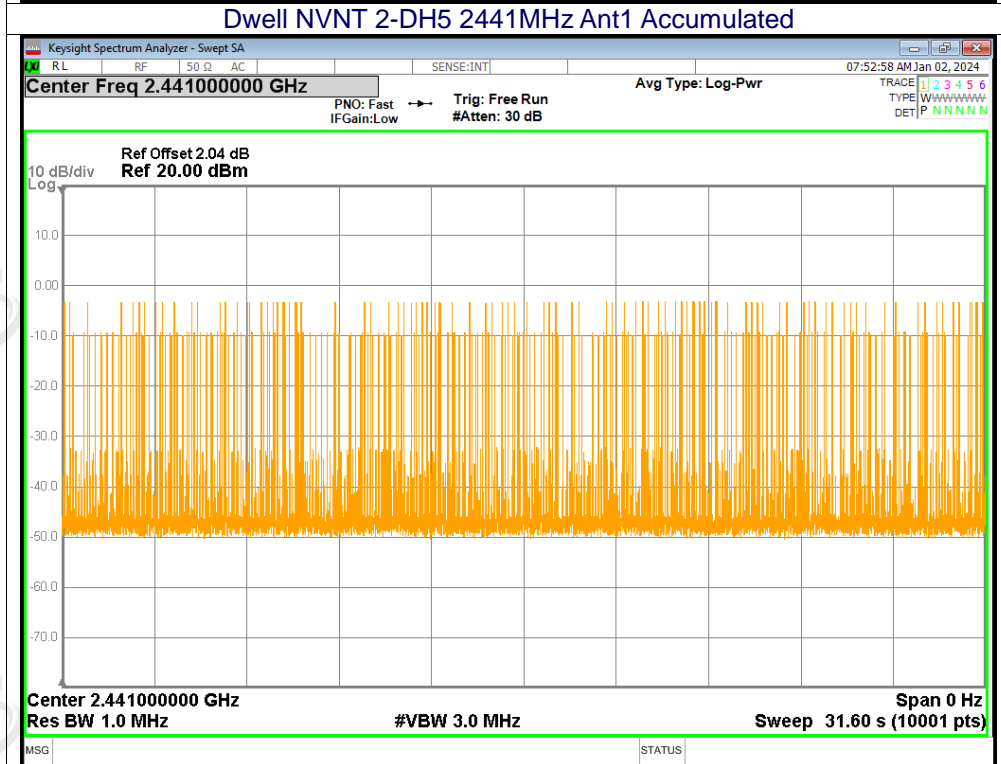
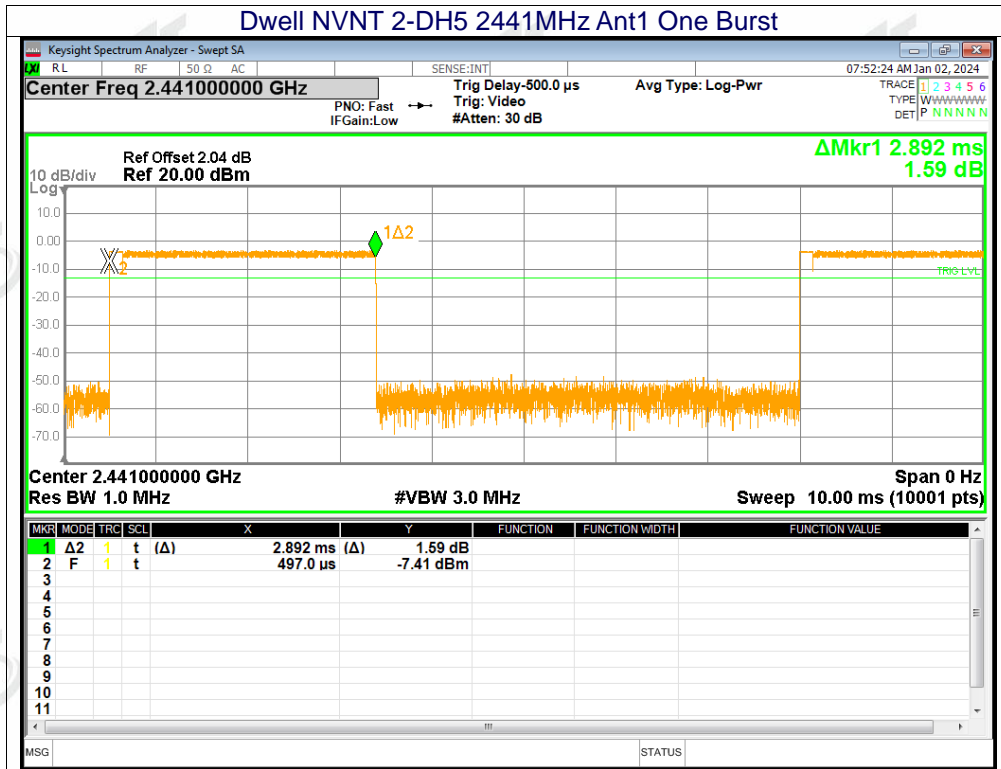

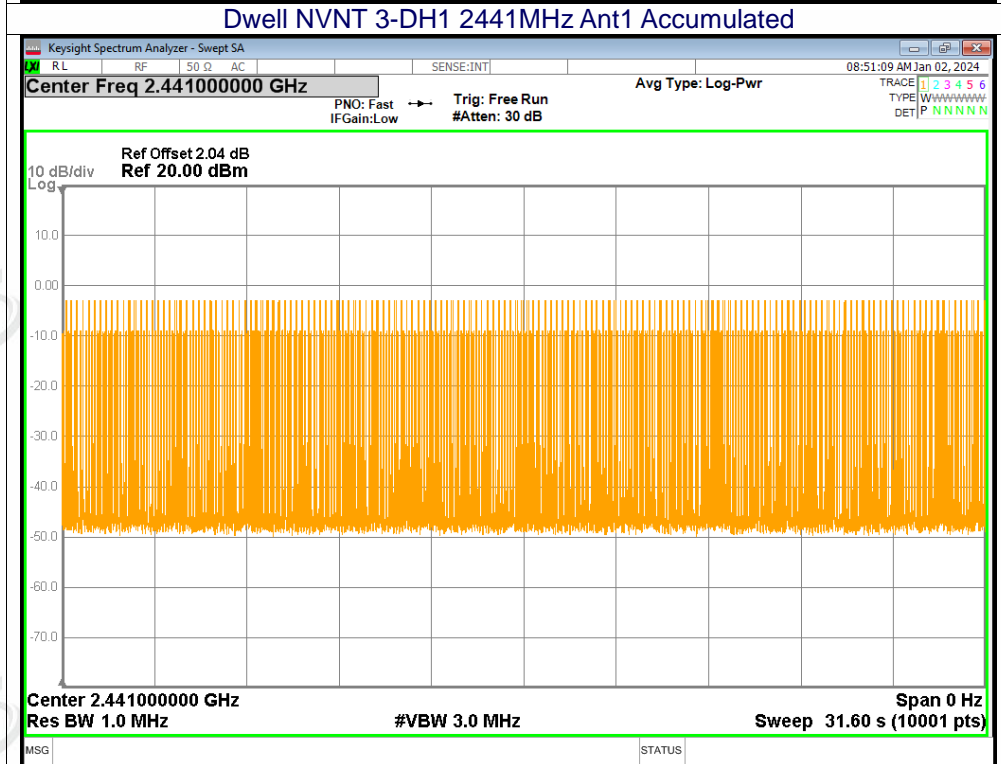
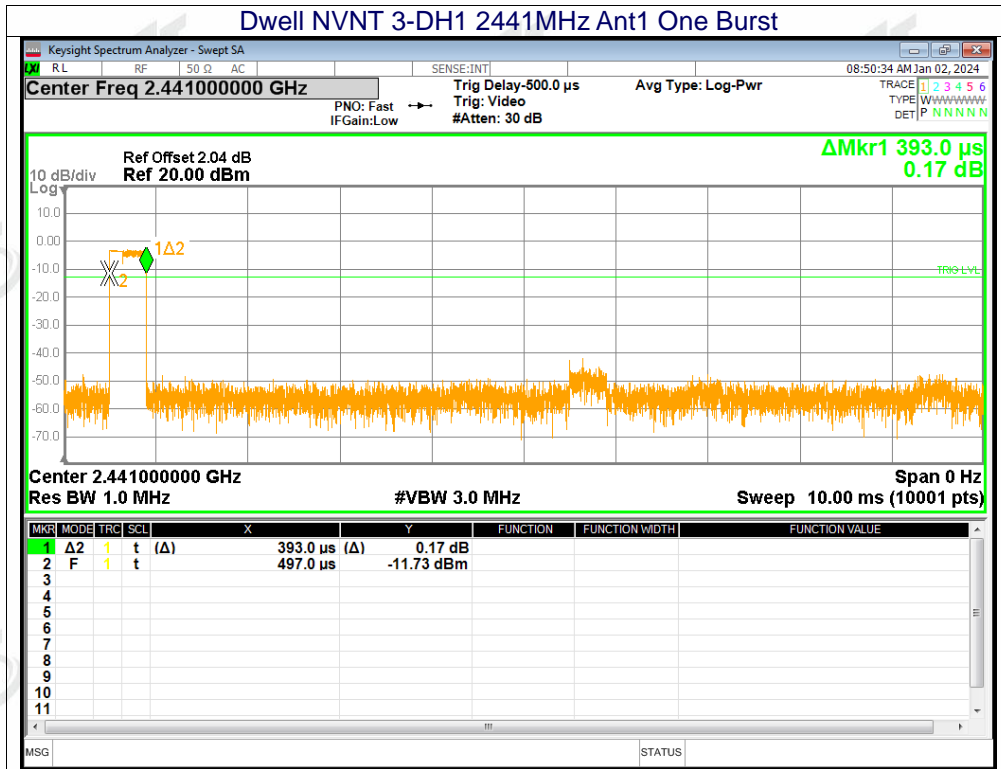

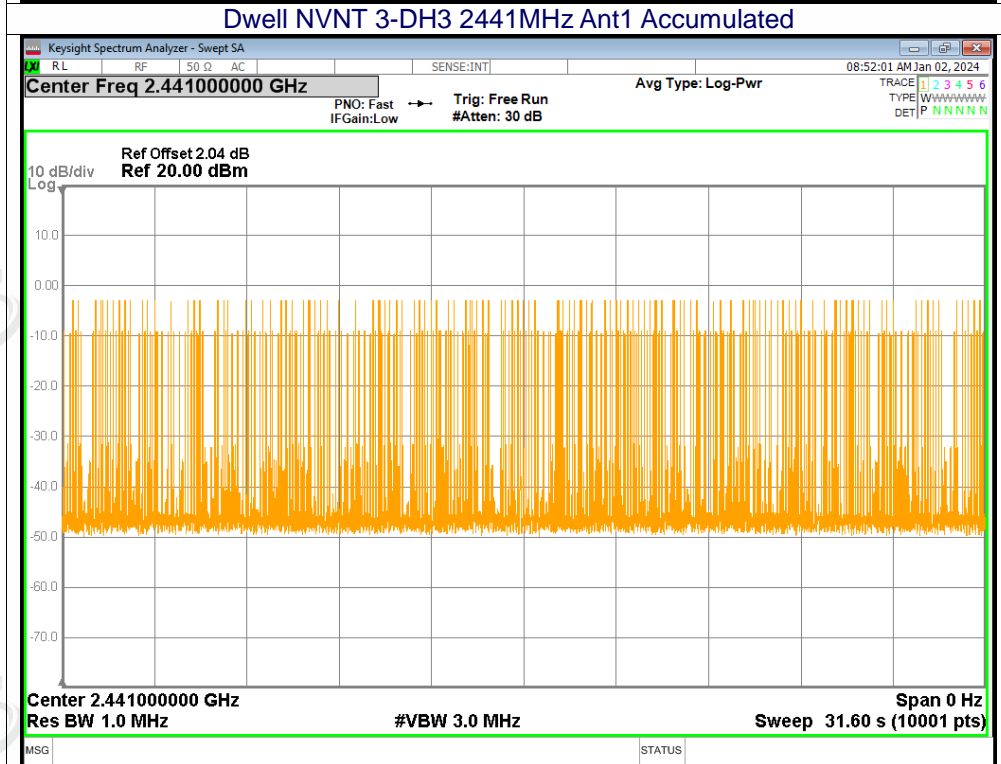
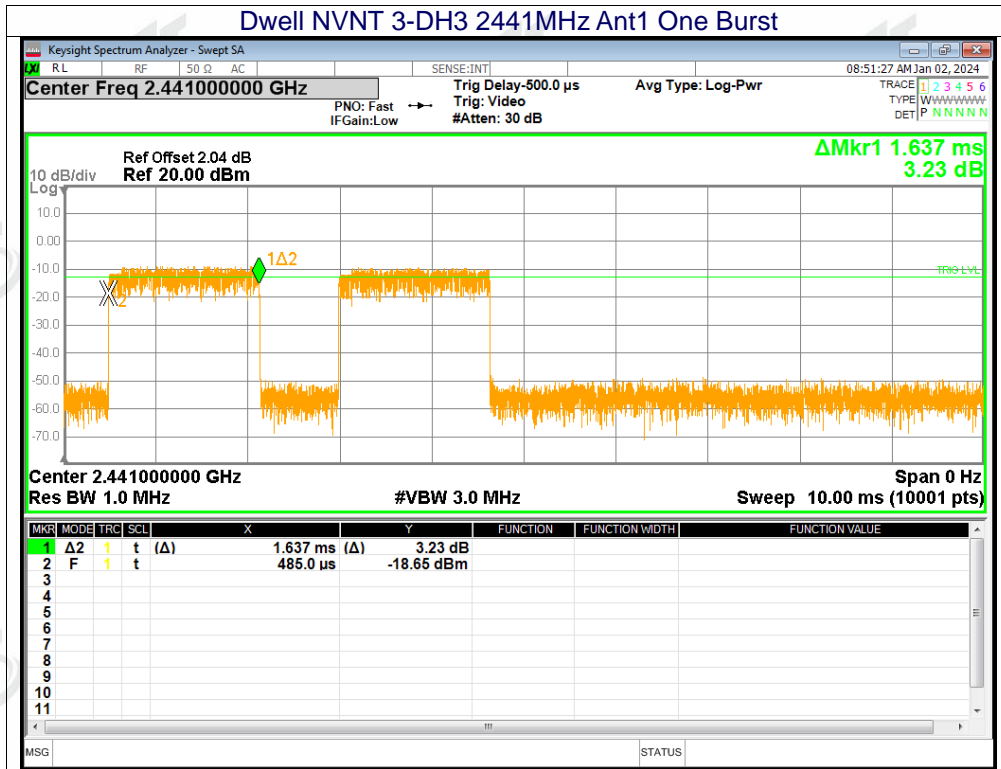

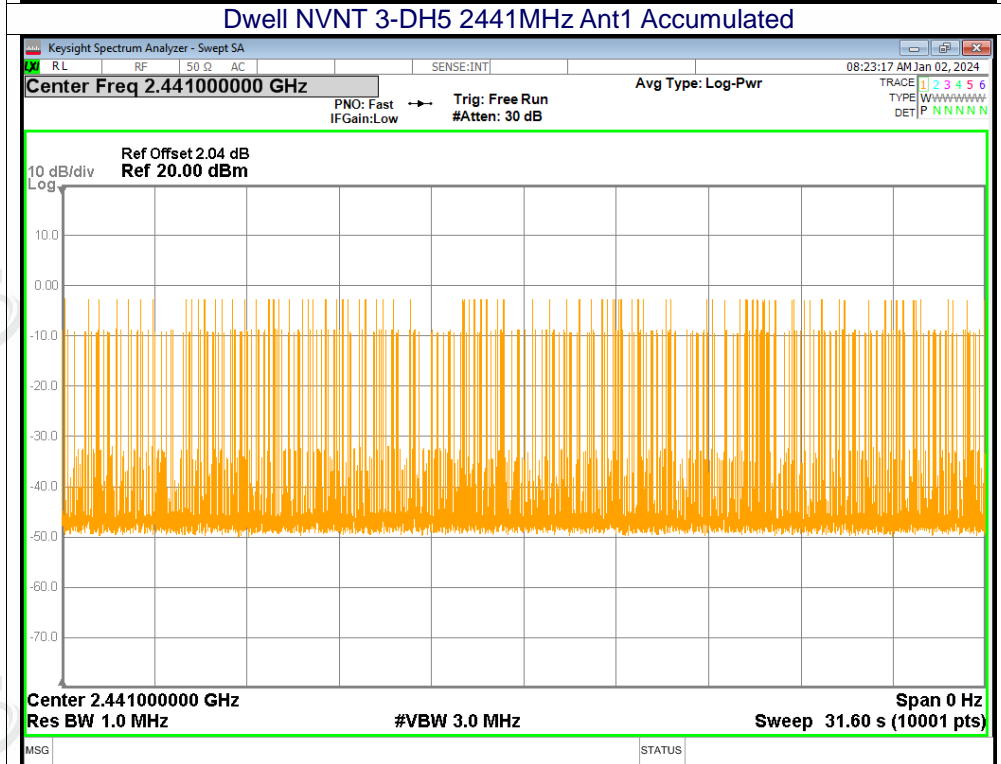
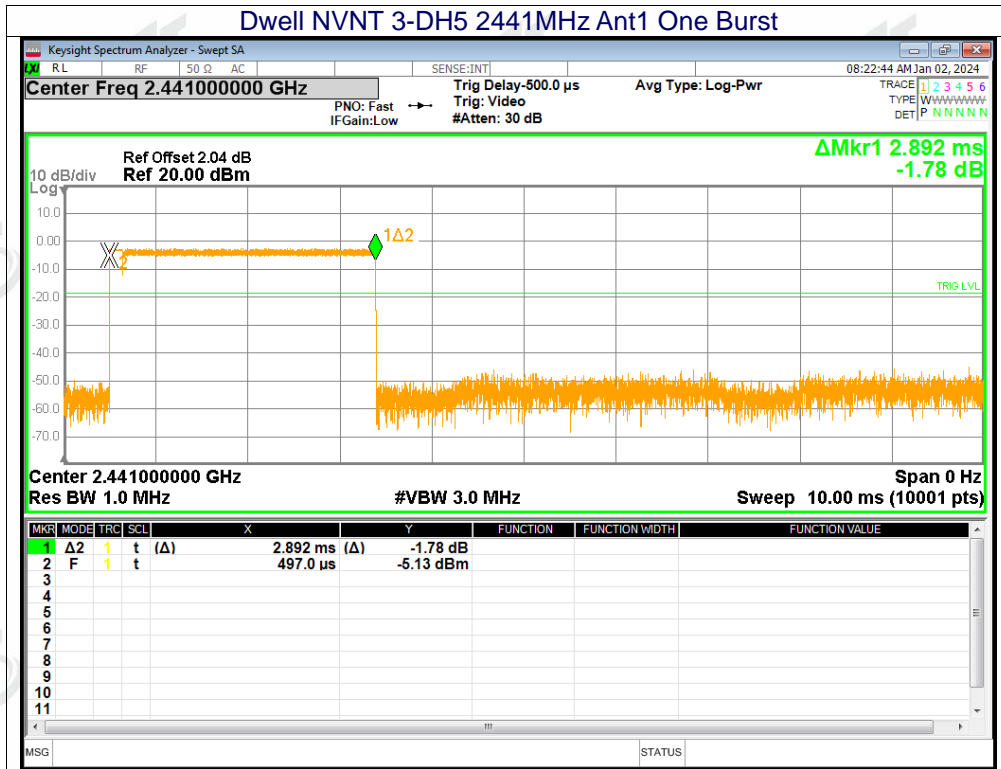



13.2 Maximum Peak Conducted Output Power

Mode	Frequency (MHz)	Conducted Power (dBm)	Limit (dBm)	Verdict
1-DH5	2402	-3.27	21	Pass
1-DH5	2441	-2.89	21	Pass
1-DH5	2480	-3.06	21	Pass
2-DH5	2402	-3.18	21	Pass
2-DH5	2441	-2.87	21	Pass
2-DH5	2480	-2.39	21	Pass
3-DH5	2402	-2.58	21	Pass
3-DH5	2441	-2.15	21	Pass
3-DH5	2480	-3.2	21	Pass

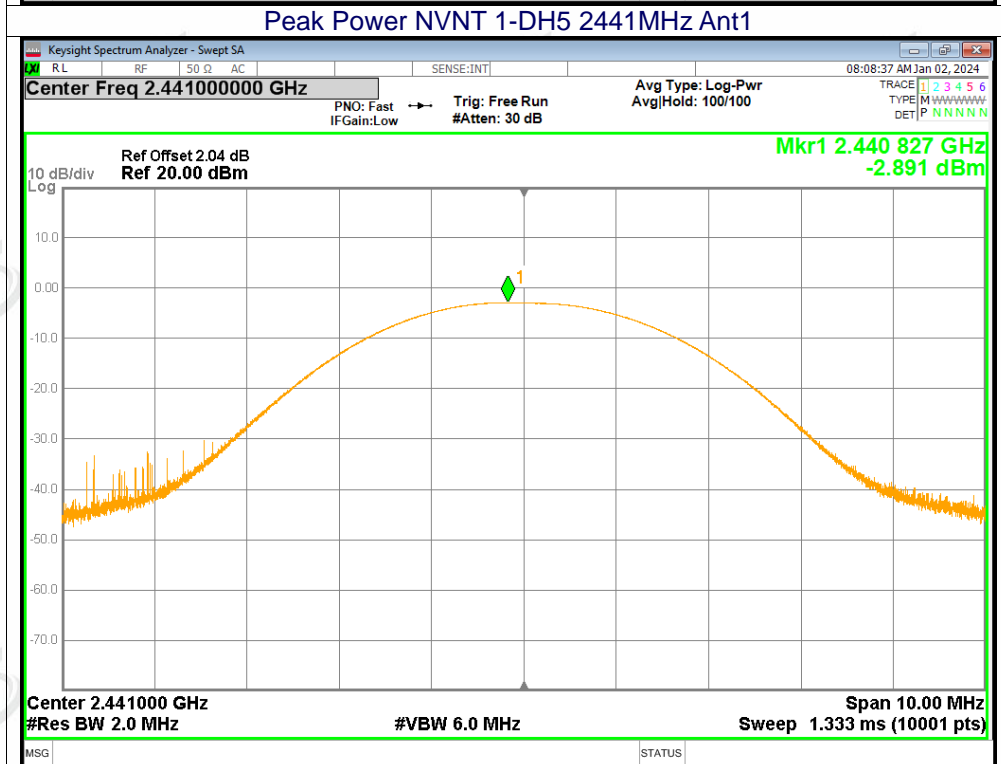
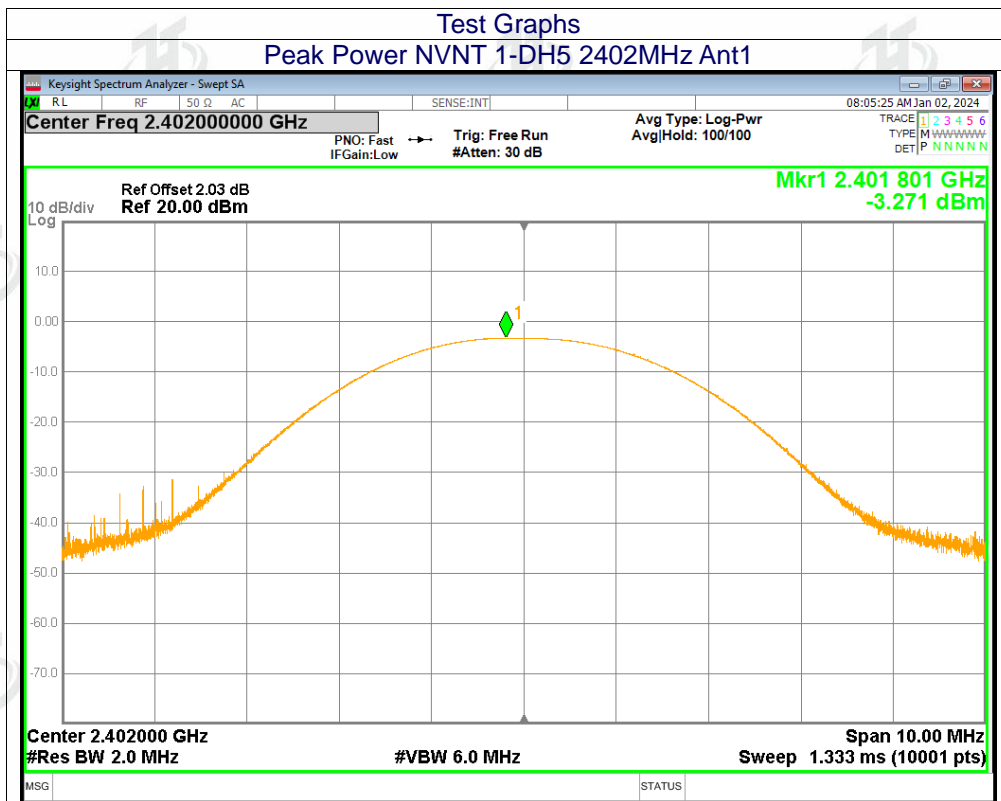

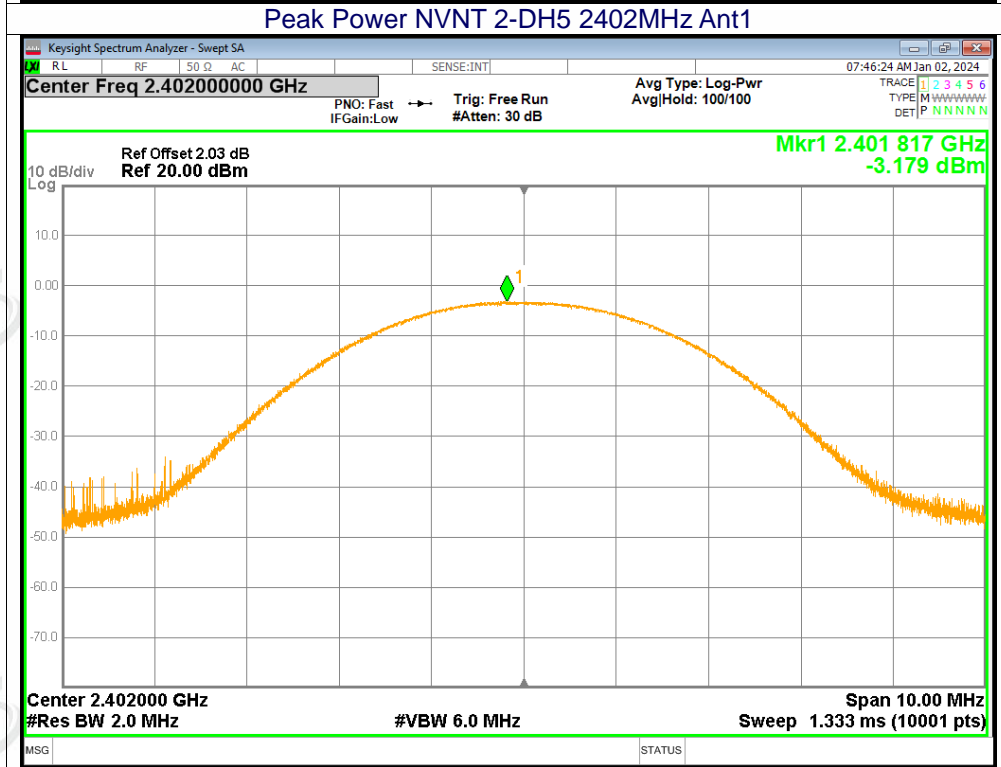
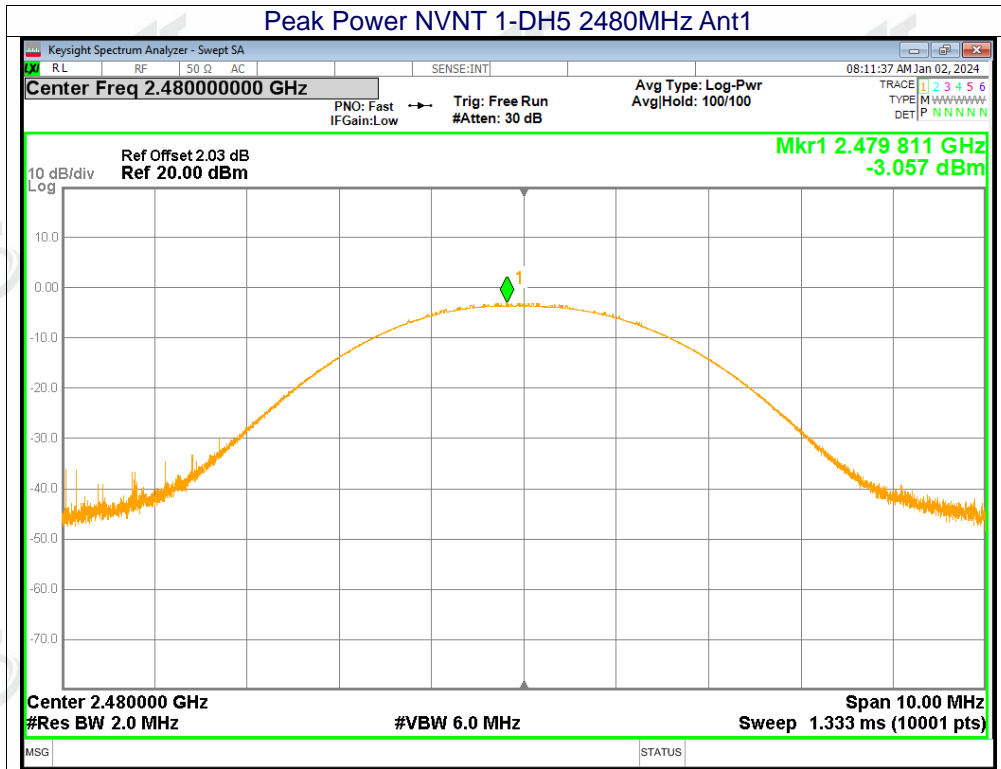

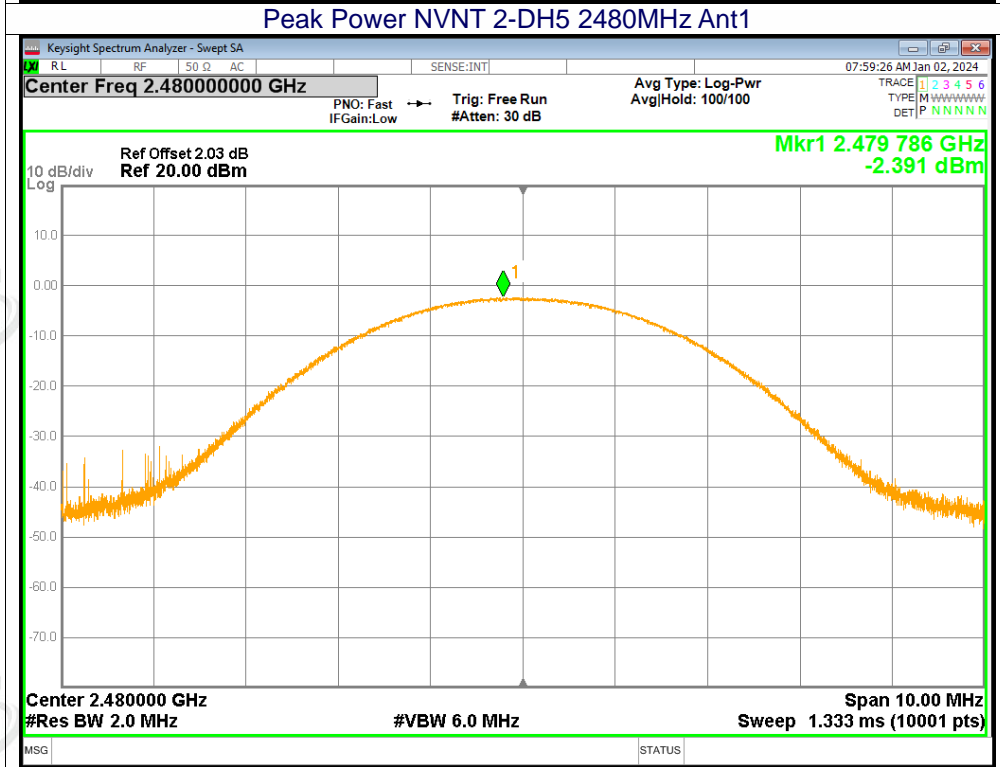
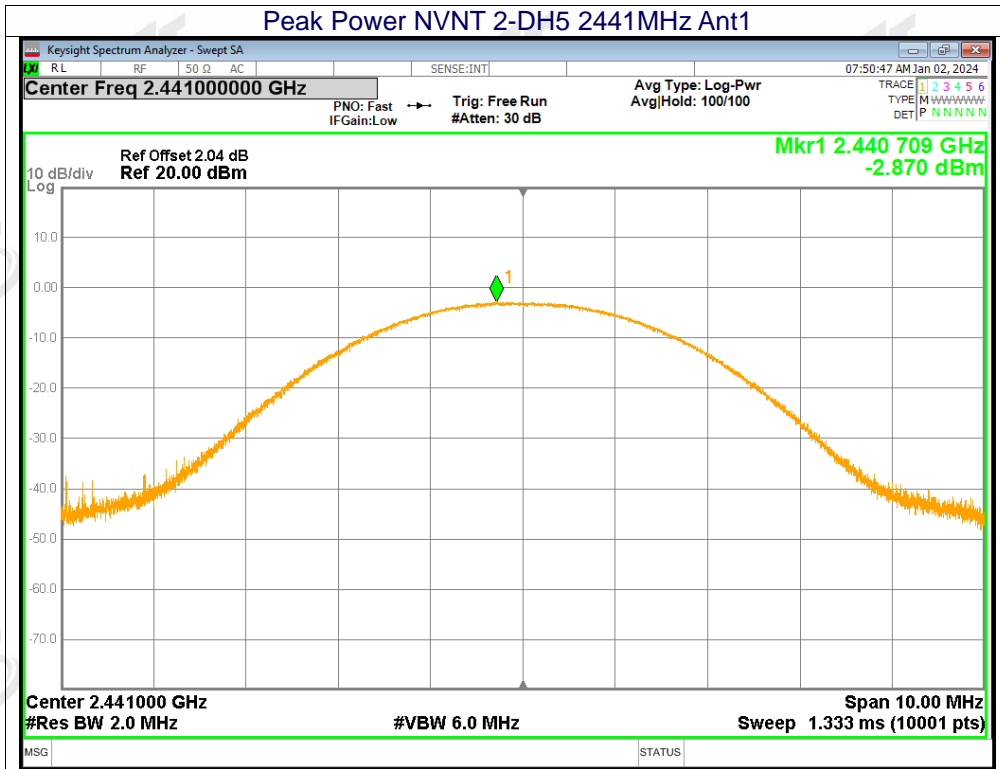

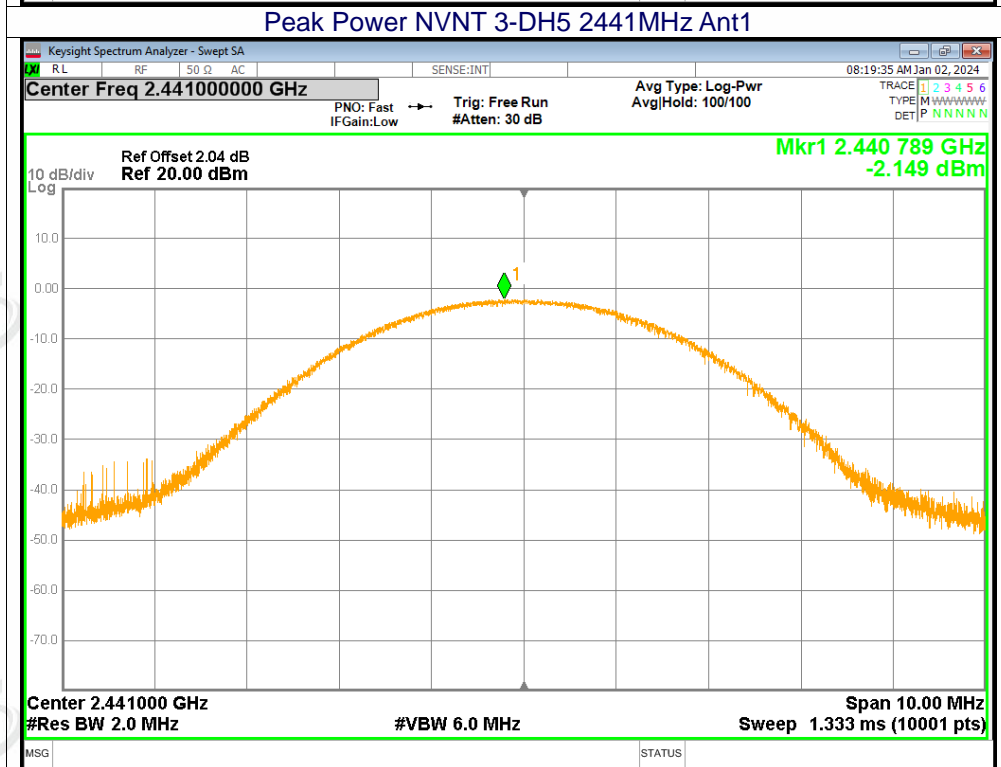
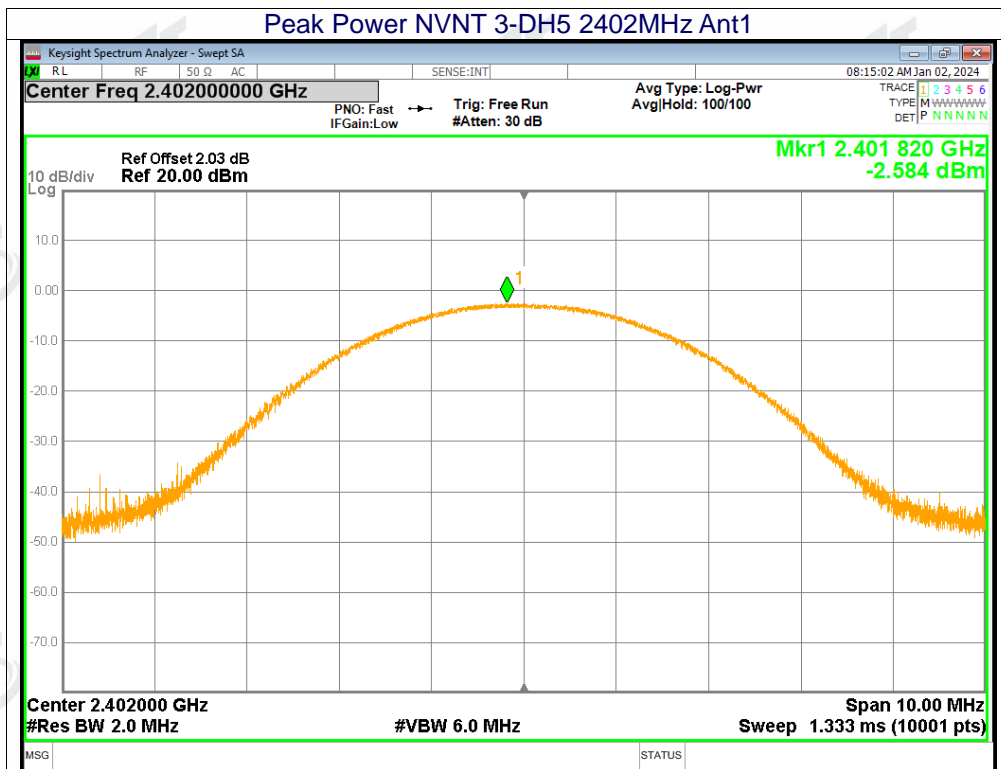

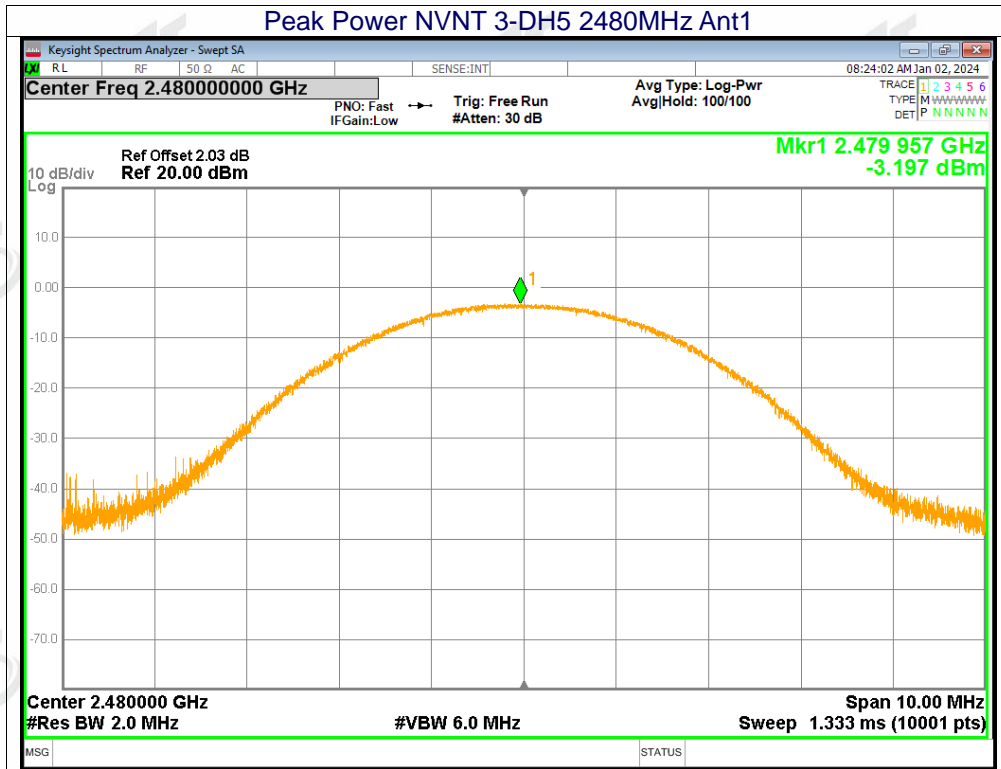



13.3 -20dB Bandwidth

Mode	Frequency (MHz)	-20 dB Bandwidth (MHz)
1-DH5	2402	0.947
1-DH5	2441	0.938
1-DH5	2480	0.944
2-DH5	2402	1.273
2-DH5	2441	1.343
2-DH5	2480	1.265
3-DH5	2402	1.303
3-DH5	2441	1.275
3-DH5	2480	1.274

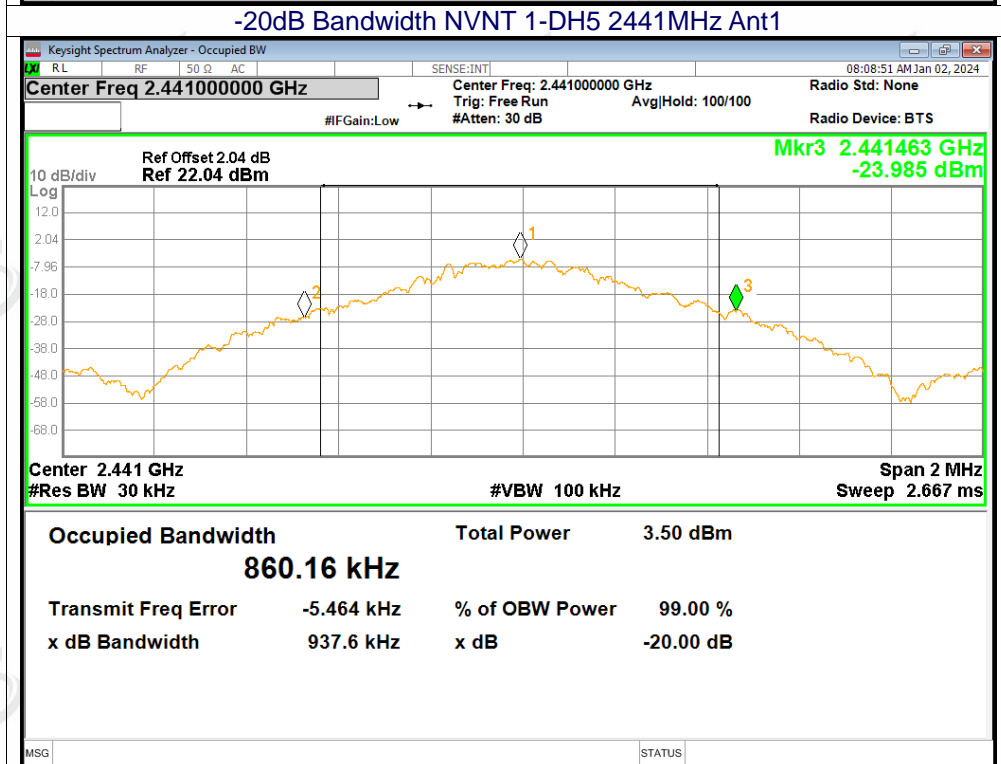
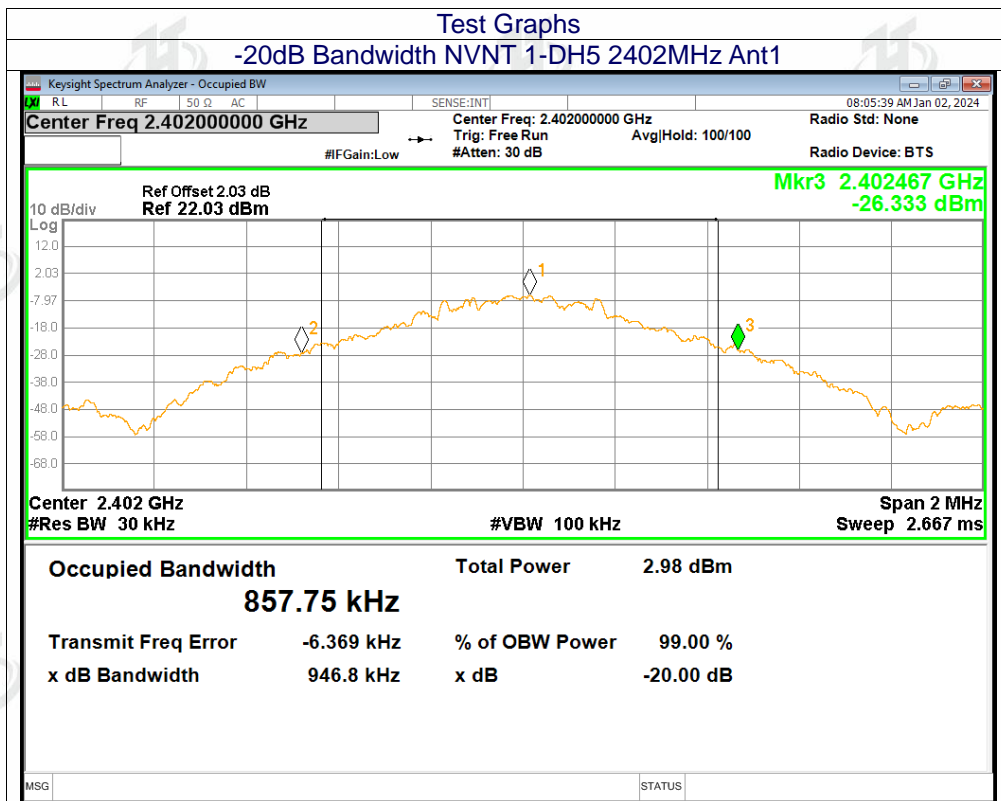

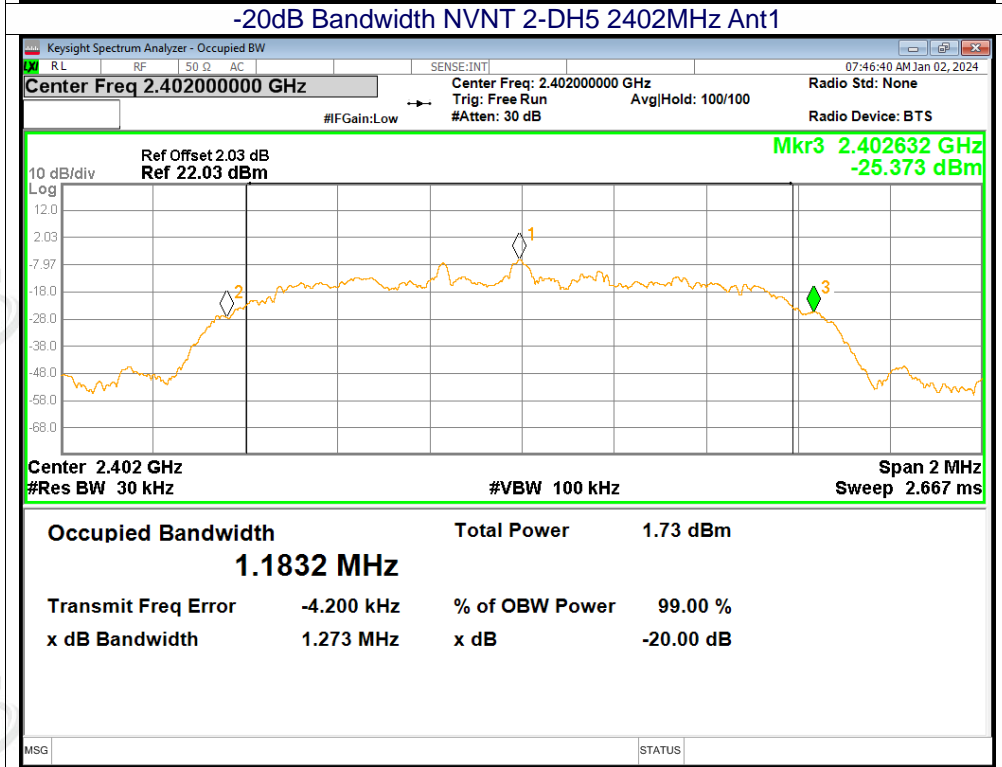
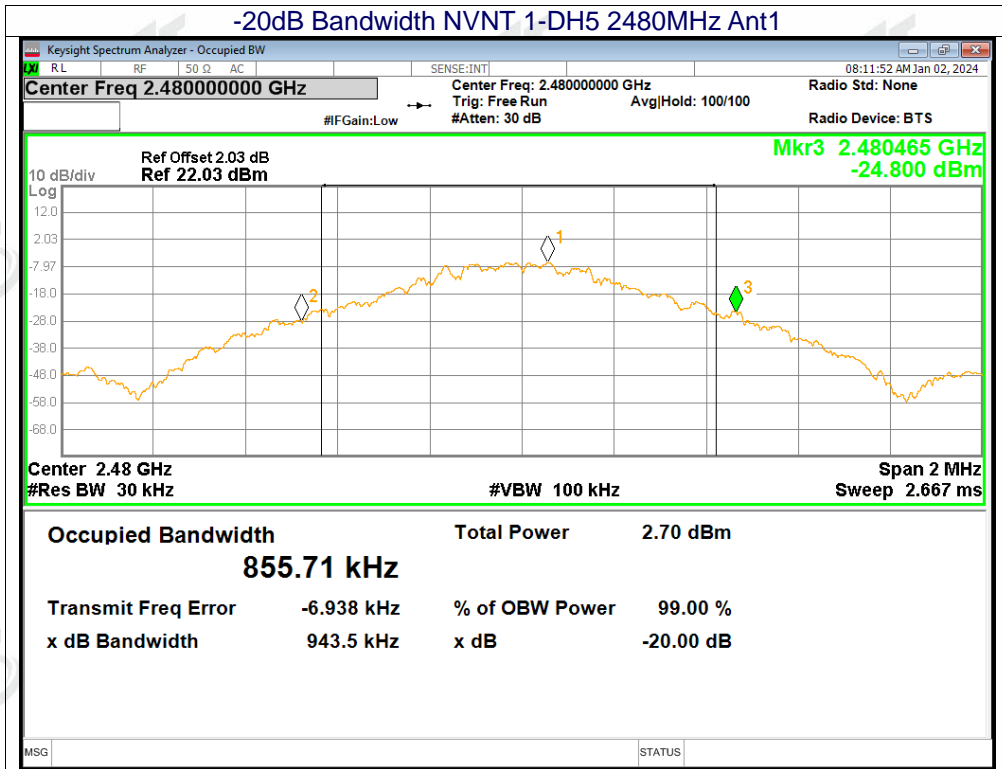

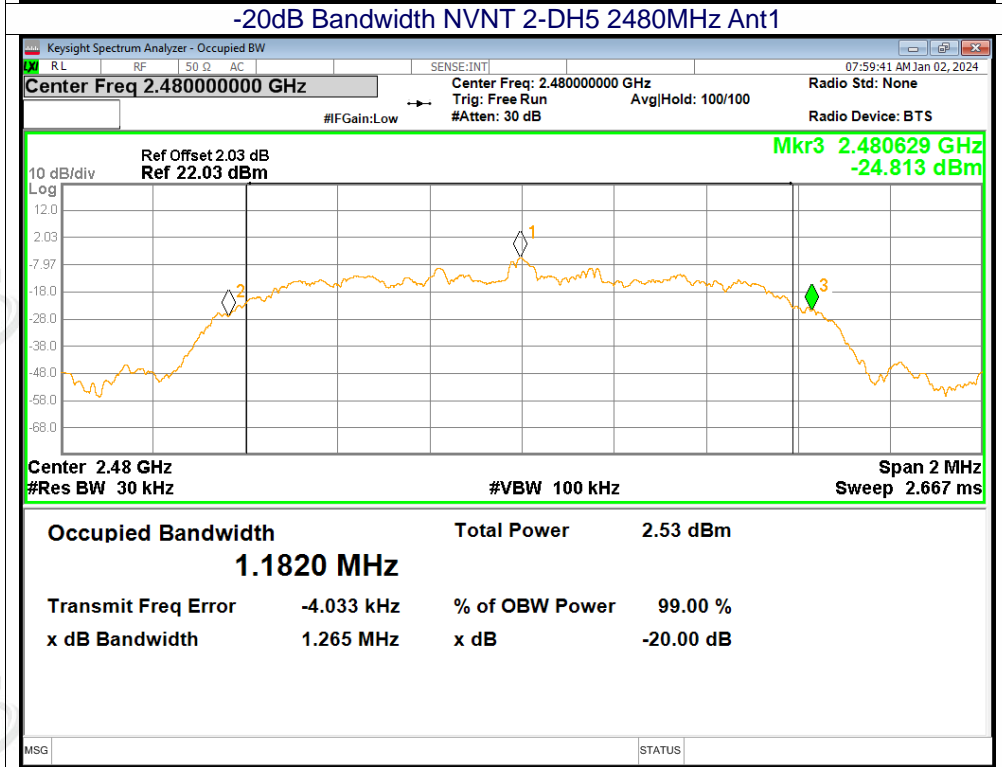
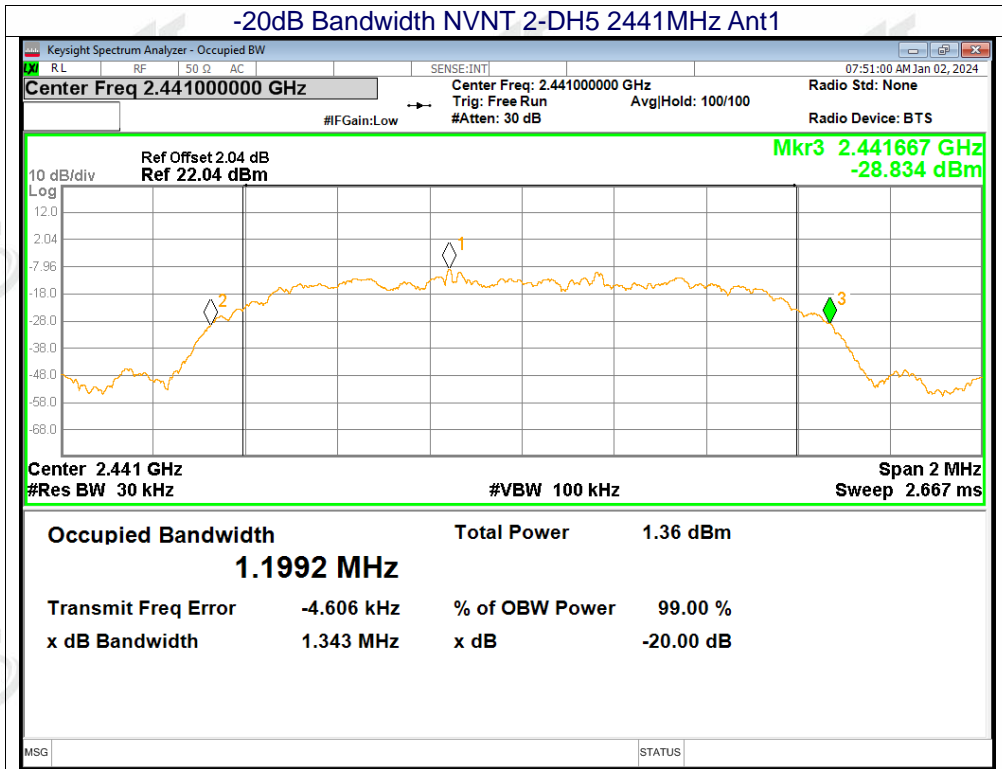

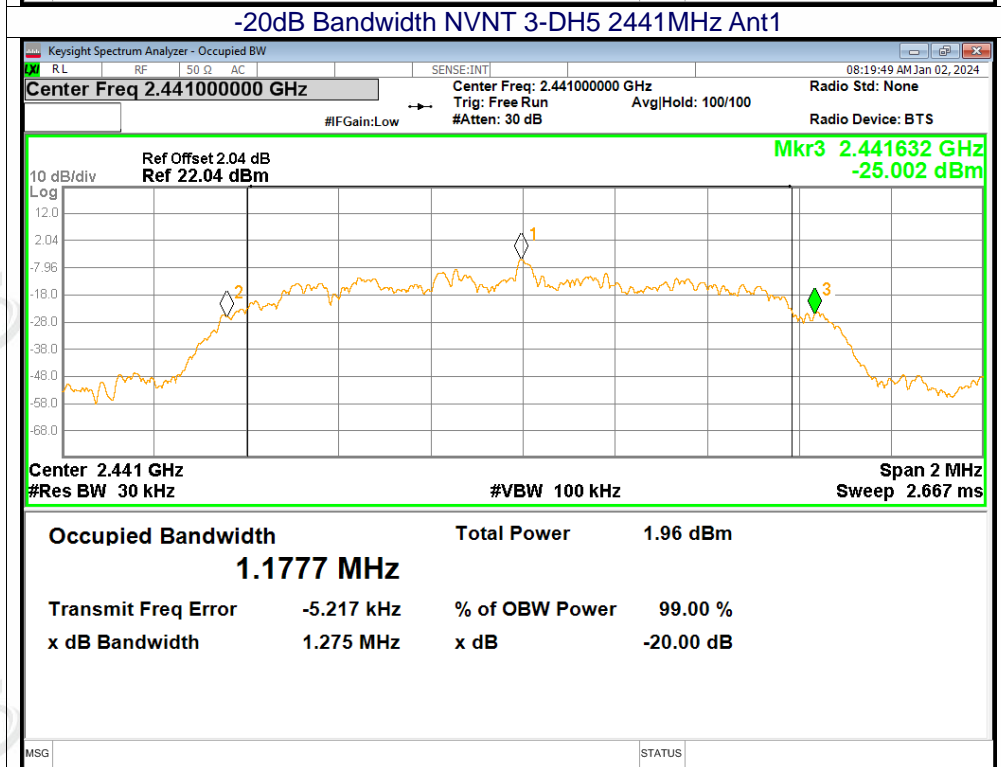
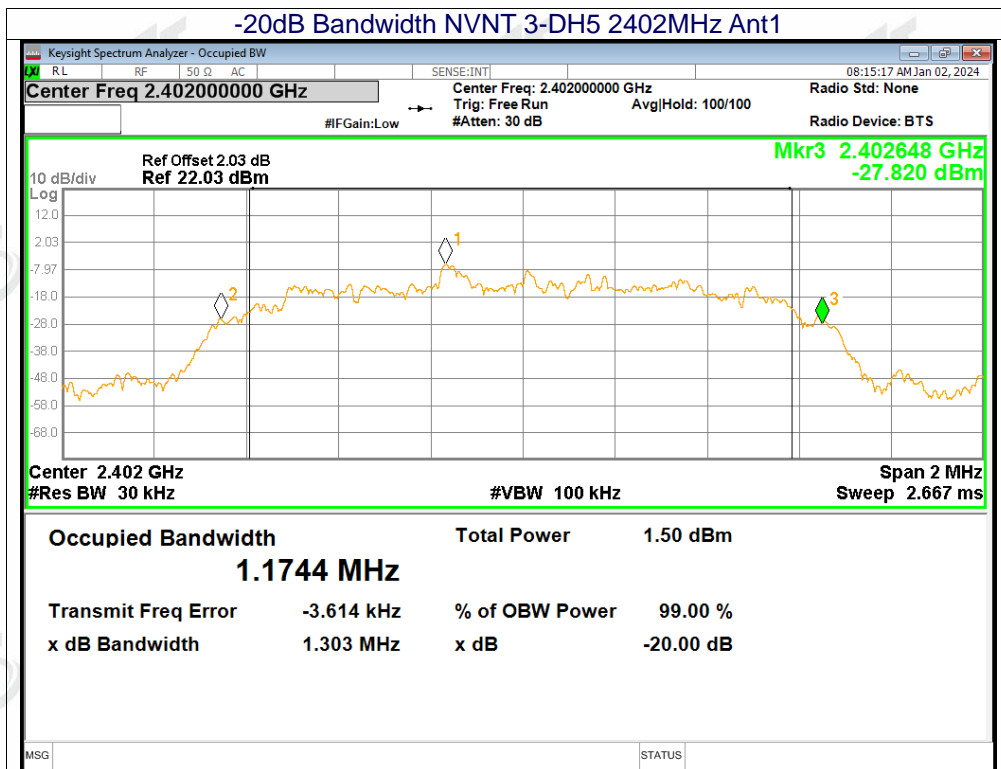

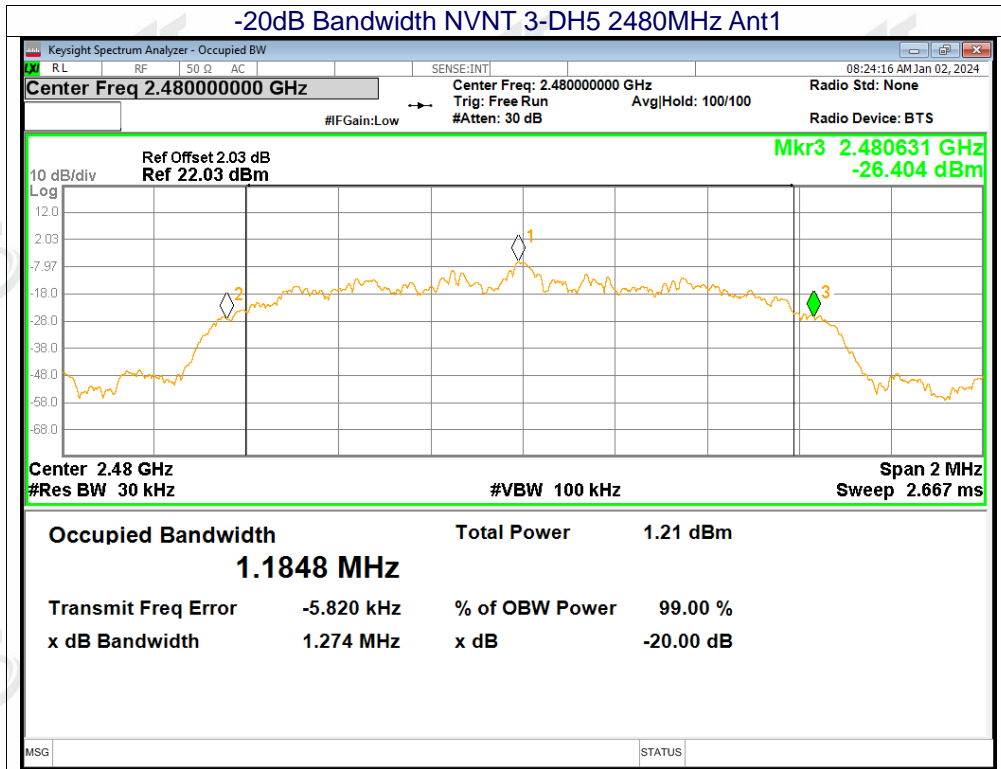



13.4 Occupied Channel Bandwidth

Mode	Frequency (MHz)	Antenna	99% OBW (MHz)
1-DH5	2402	Ant1	0.858
1-DH5	2441	Ant1	0.863
1-DH5	2480	Ant1	0.853
2-DH5	2402	Ant1	1.184
2-DH5	2441	Ant1	1.185
2-DH5	2480	Ant1	1.191
3-DH5	2402	Ant1	1.186
3-DH5	2441	Ant1	1.191
3-DH5	2480	Ant1	1.158

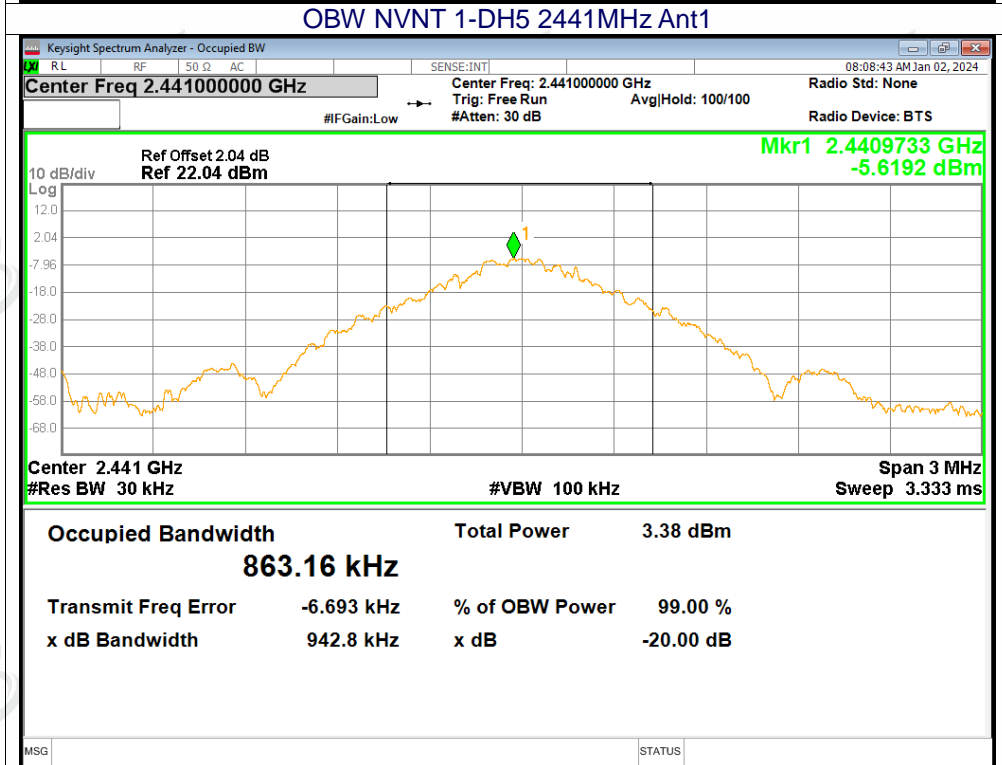
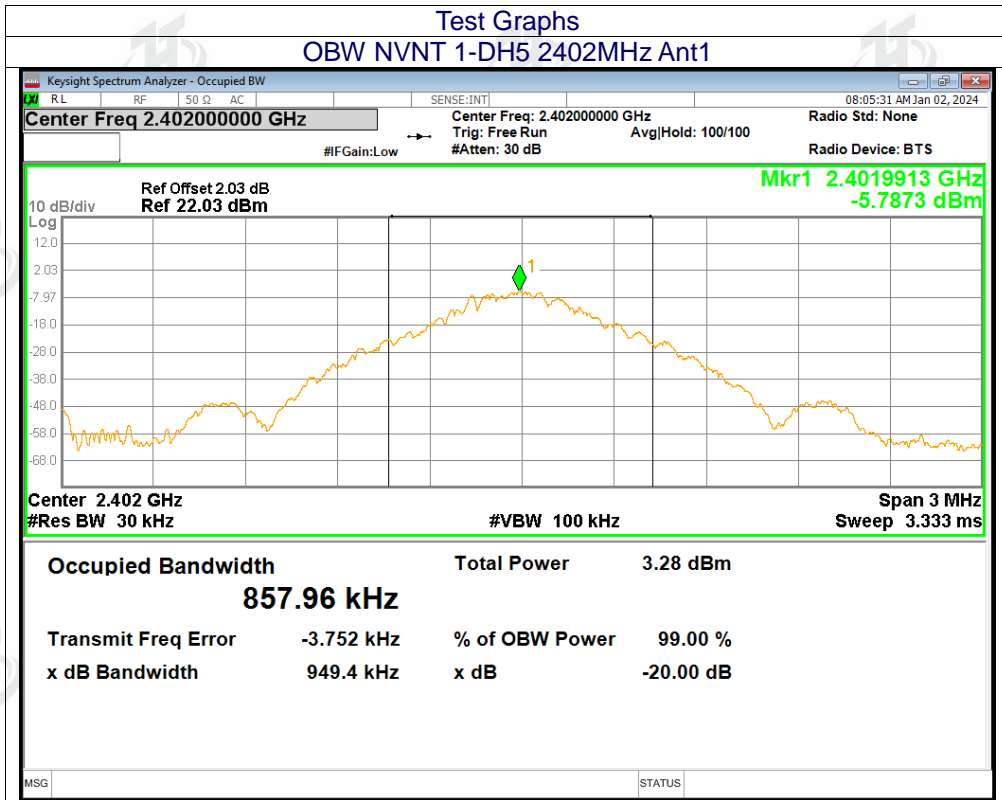

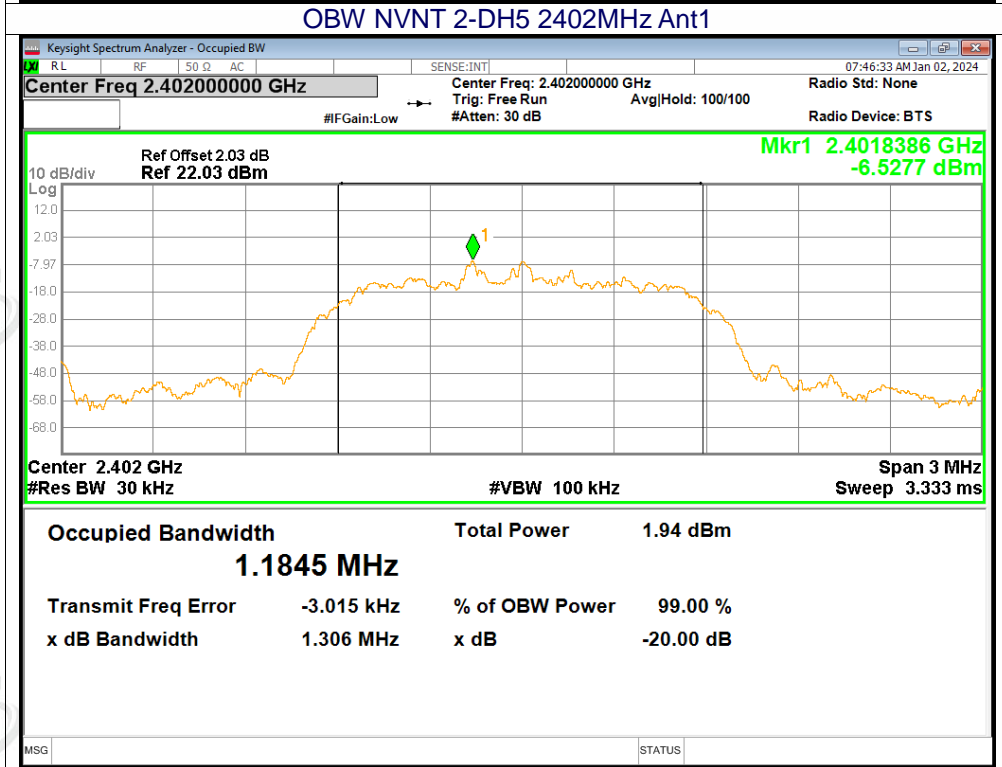
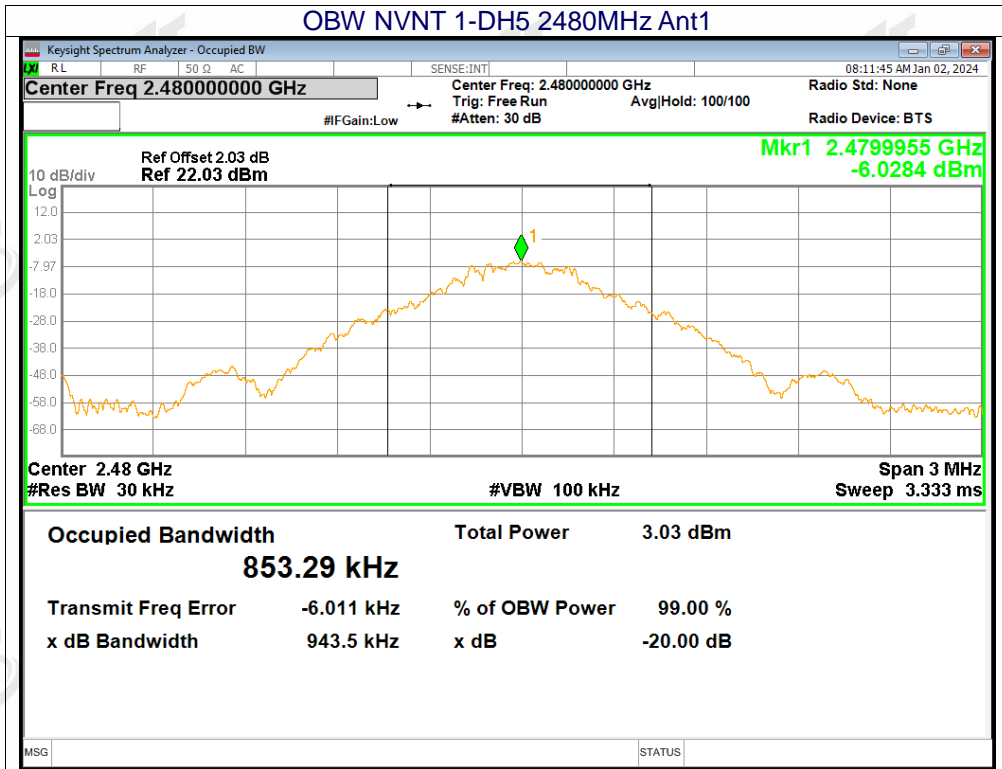

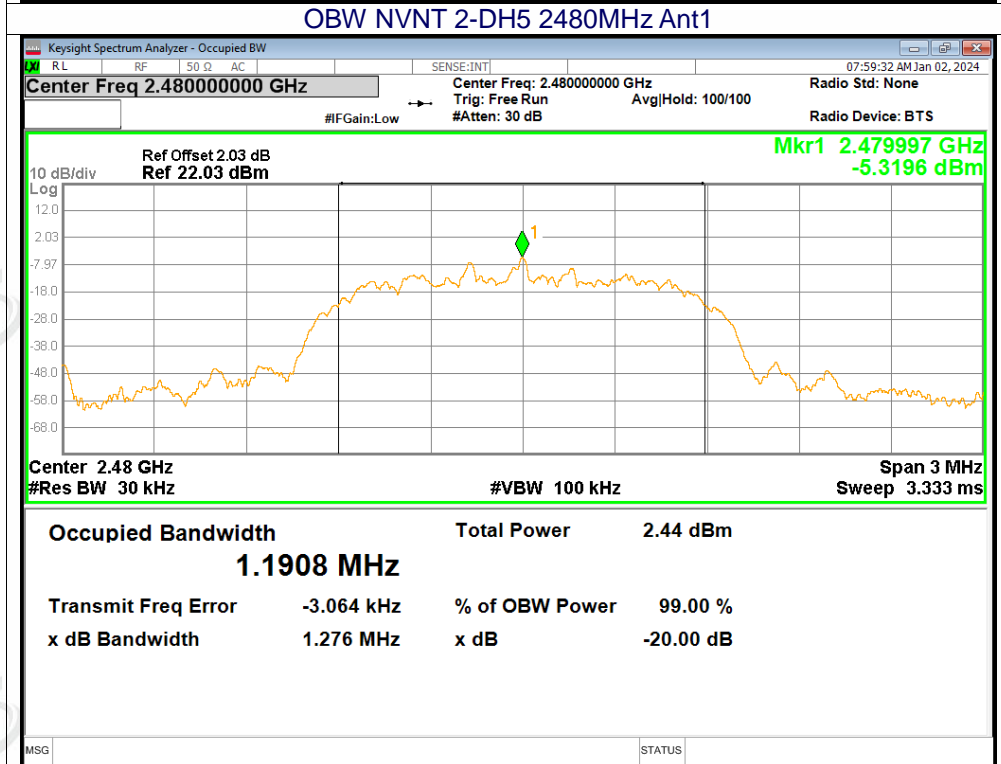
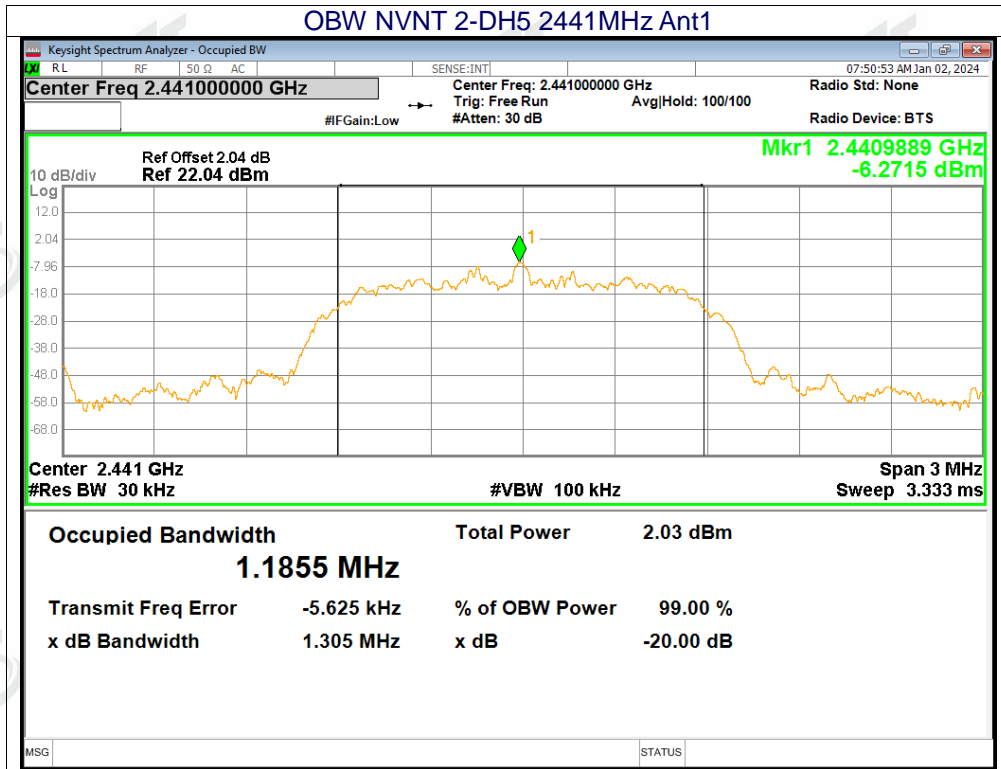

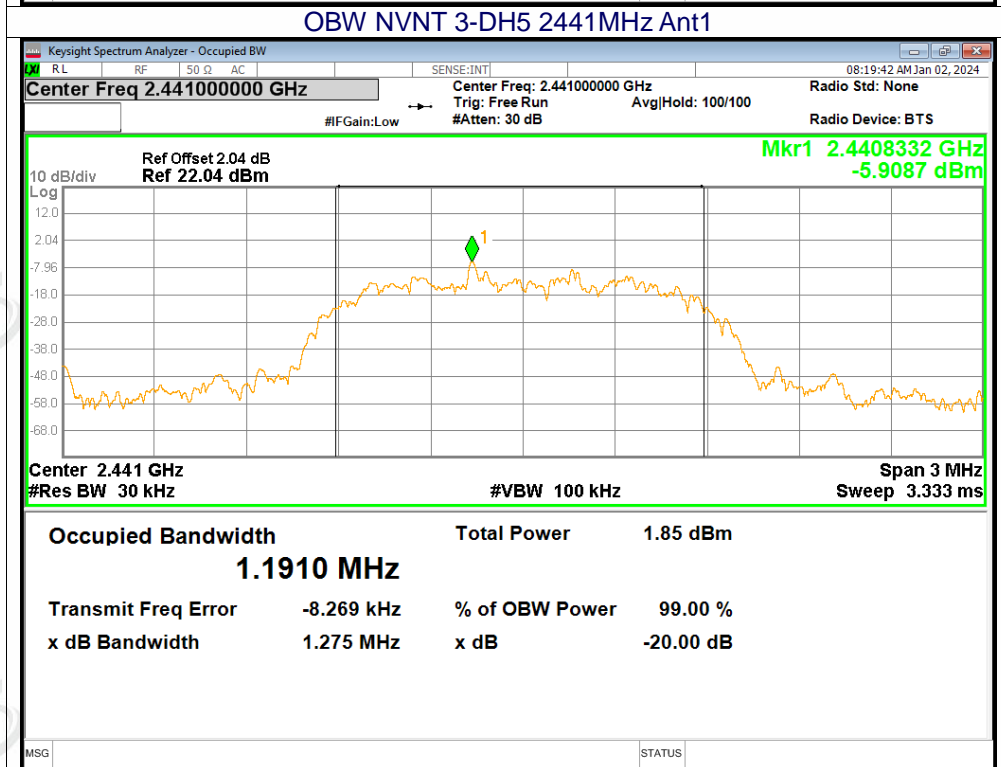
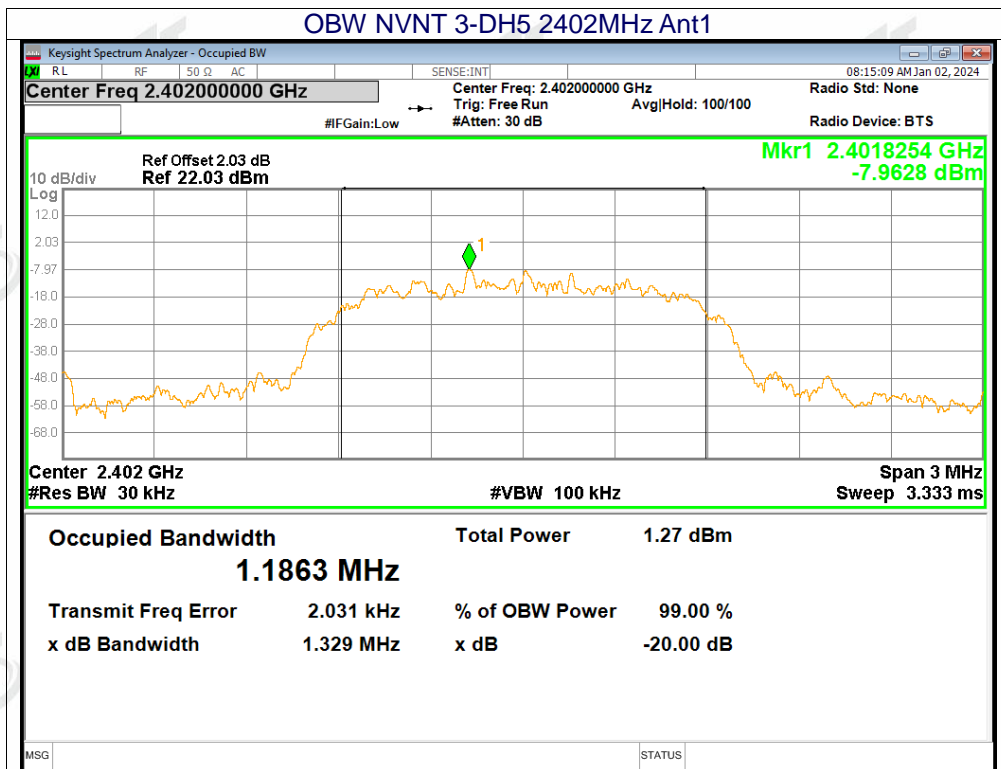

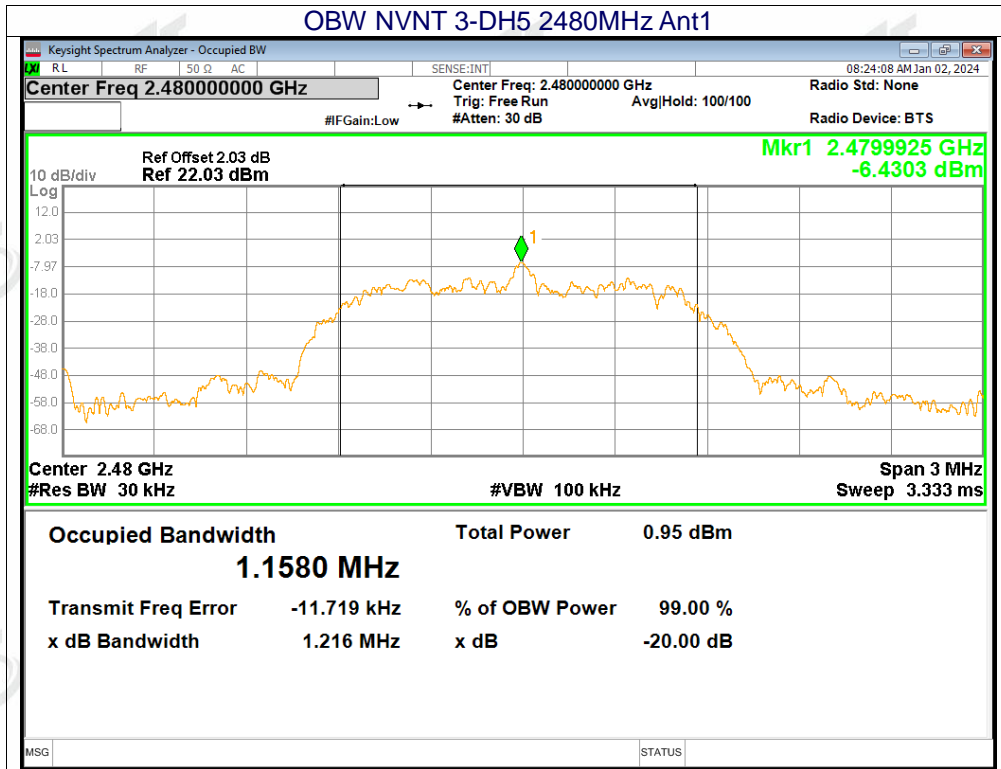



13.5 Carrier Frequencies Separation

Mode	Hopping Freq1 (MHz)	Hopping Freq2 (MHz)	HFS (MHz)	Limit (MHz)	Verdict
1-DH5	2401.958	2403.012	1.054	0.631	Pass
1-DH5	2441.06	2441.978	0.918	0.625	Pass
1-DH5	2478.986	2479.99	1.004	0.629	Pass
1-DH5	2478.966	2479.99	1.024	0.618	Pass
2-DH5	2401.83	2402.996	1.166	0.849	Pass
2-DH5	2440.988	2442.142	1.154	0.895	Pass
2-DH5	2479.004	2479.87	0.866	0.843	Pass
3-DH5	2401.844	2402.998	1.154	0.869	Pass
3-DH5	2440.816	2442.008	1.192	0.85	Pass
3-DH5	2479.176	2480.188	1.012	0.849	Pass

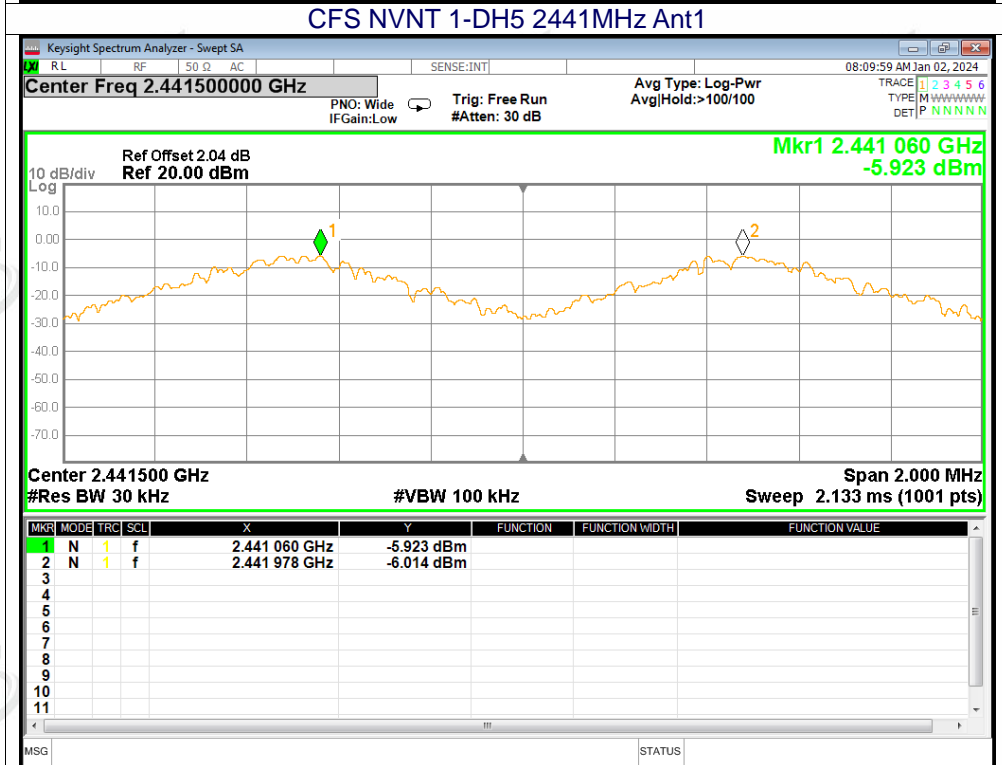
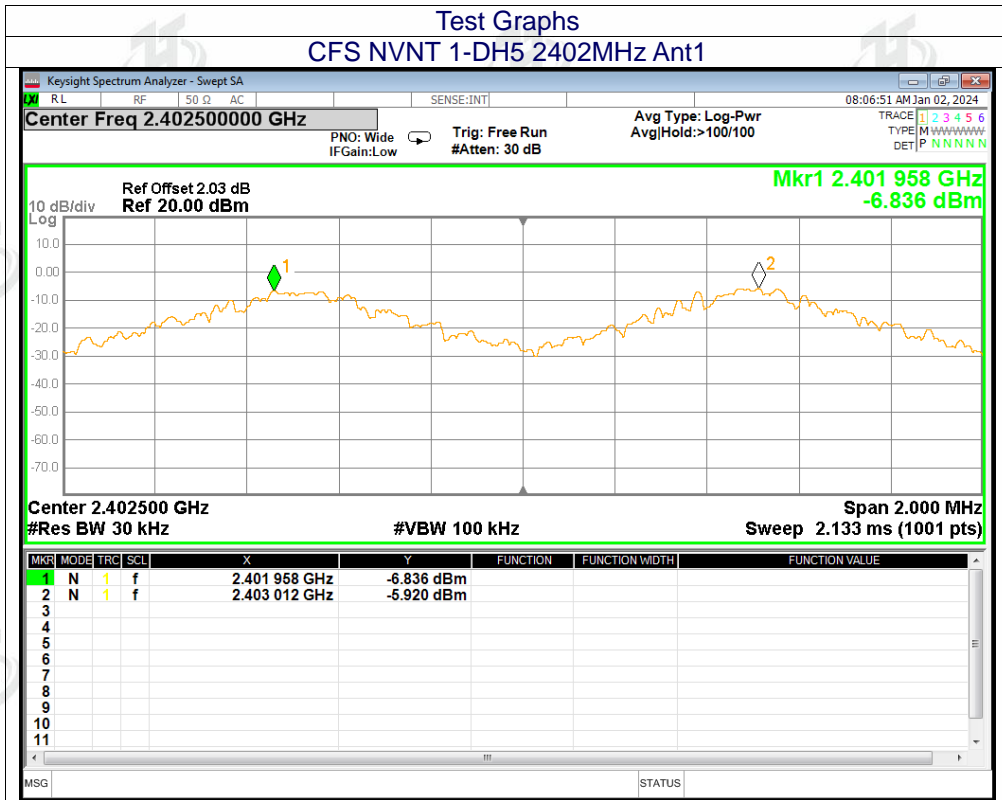

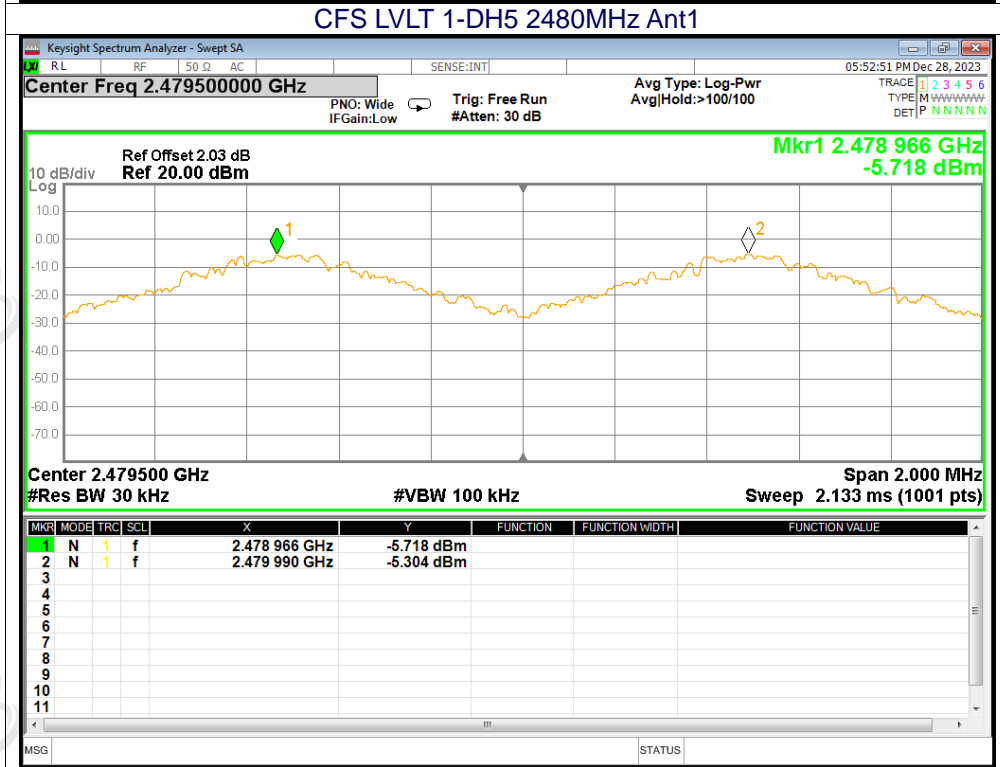
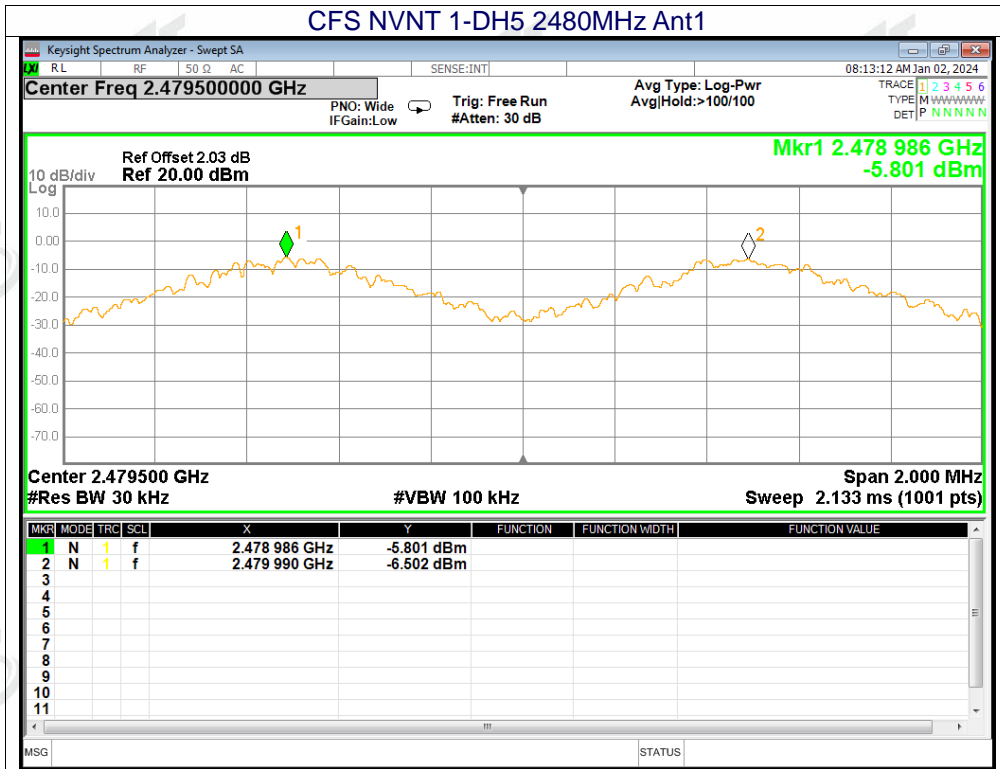

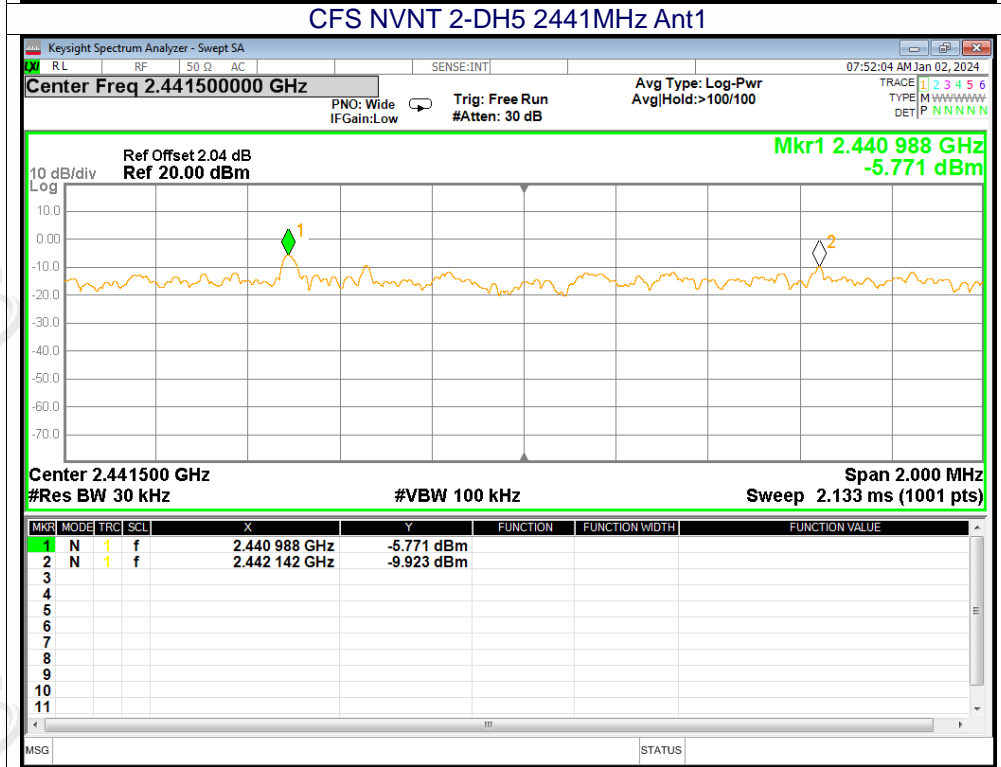
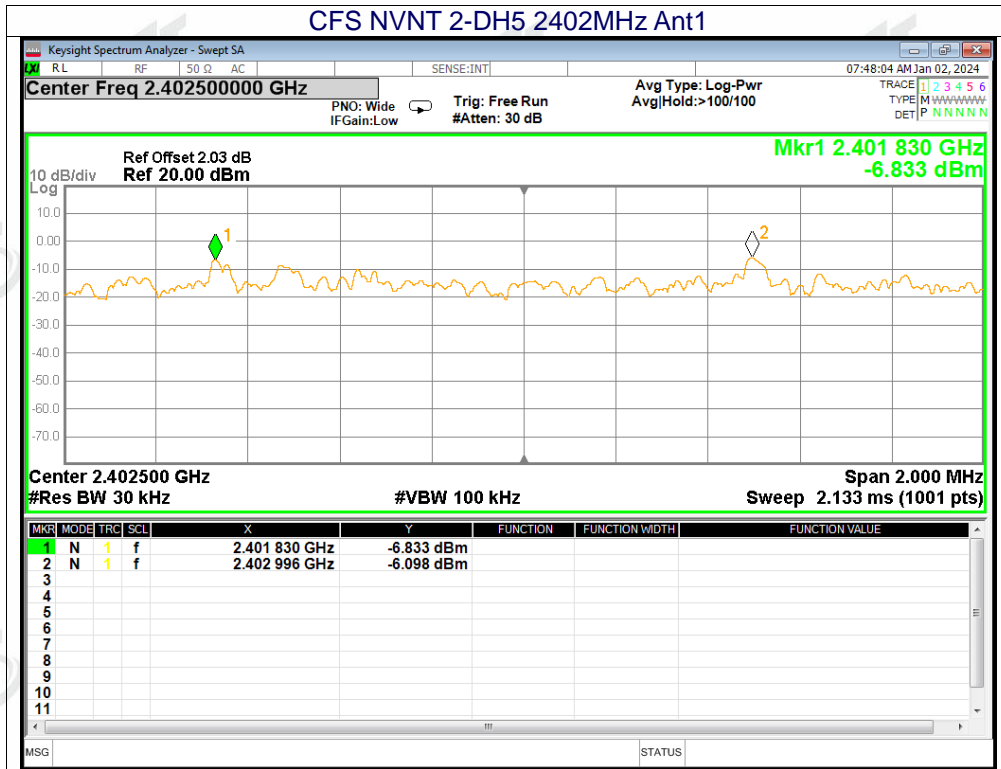

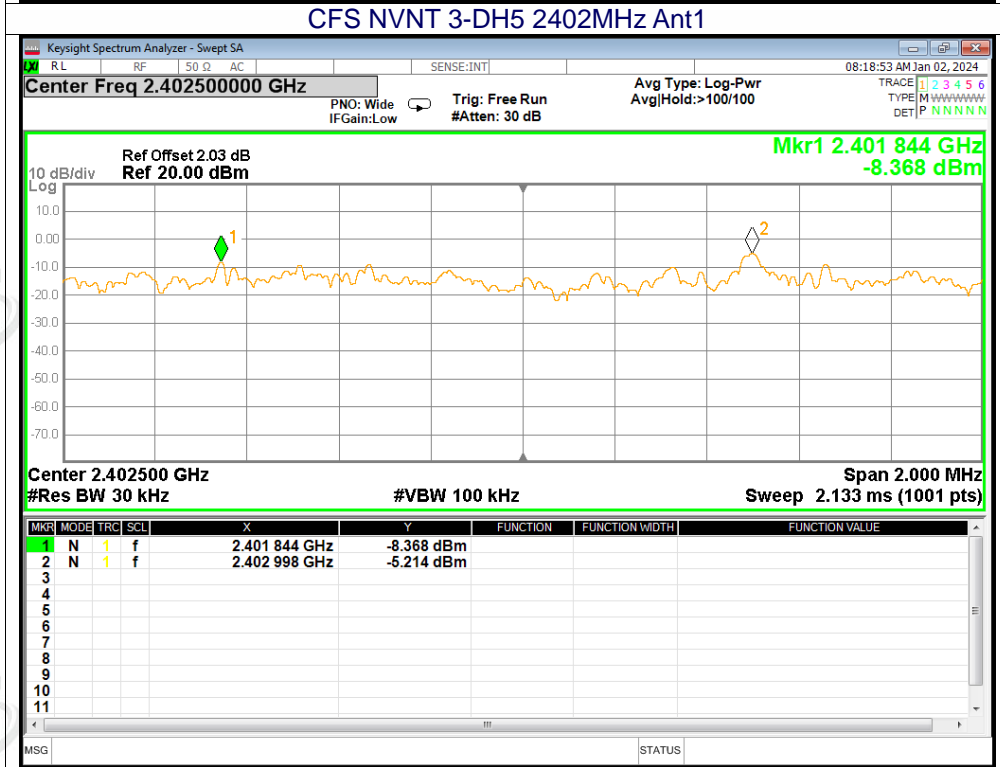
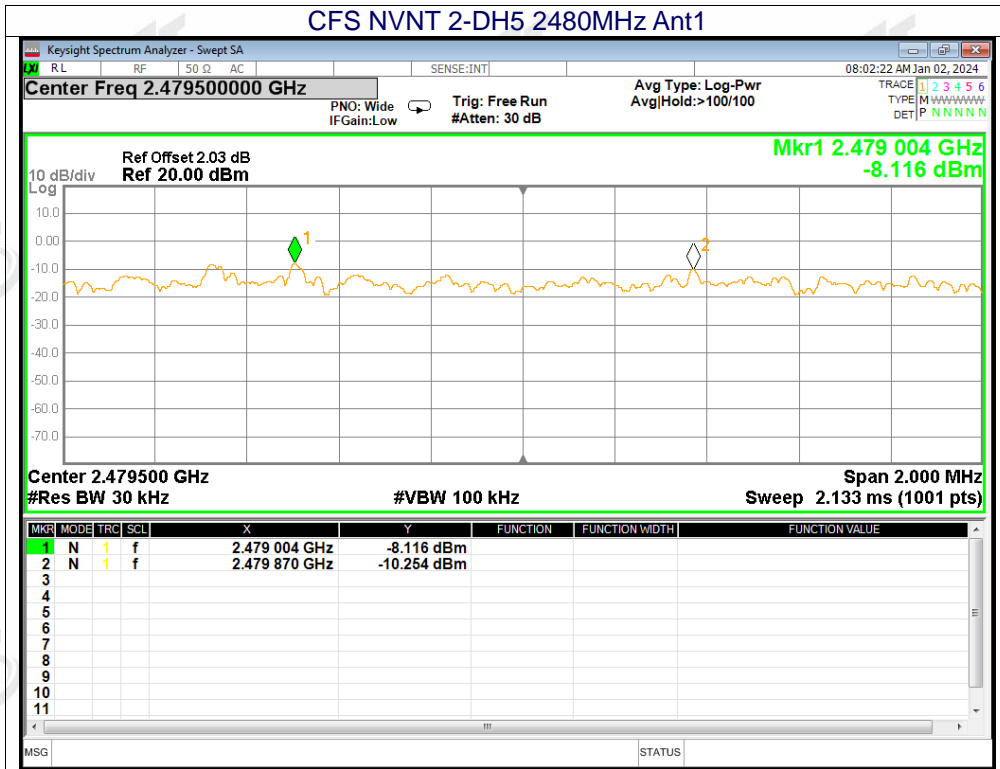

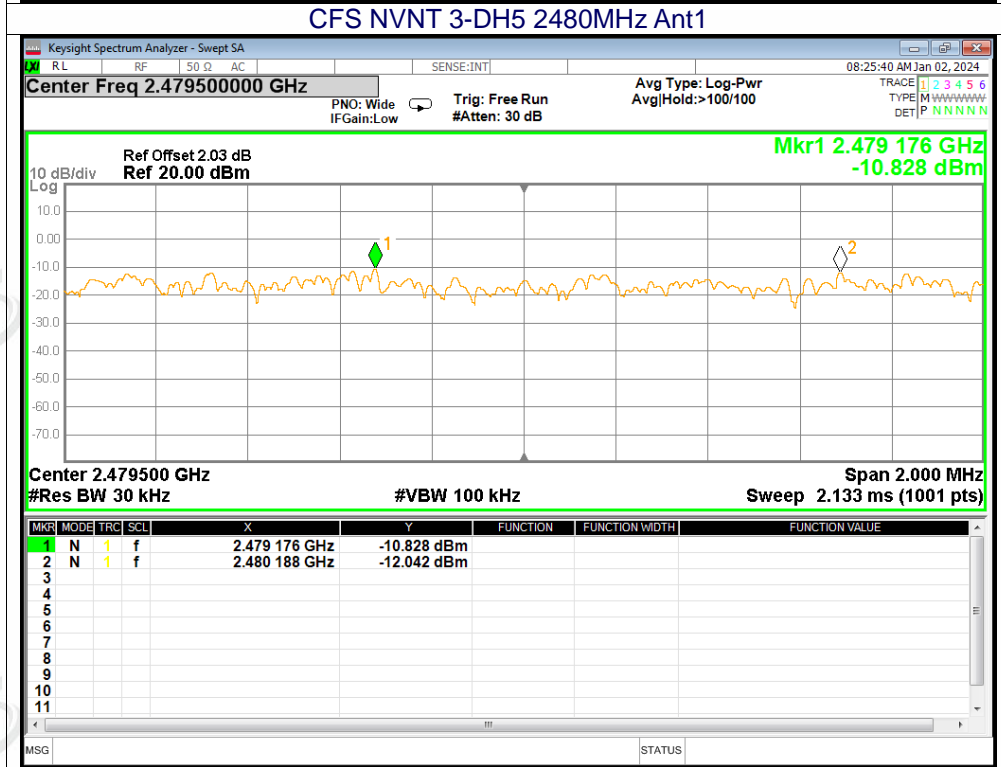
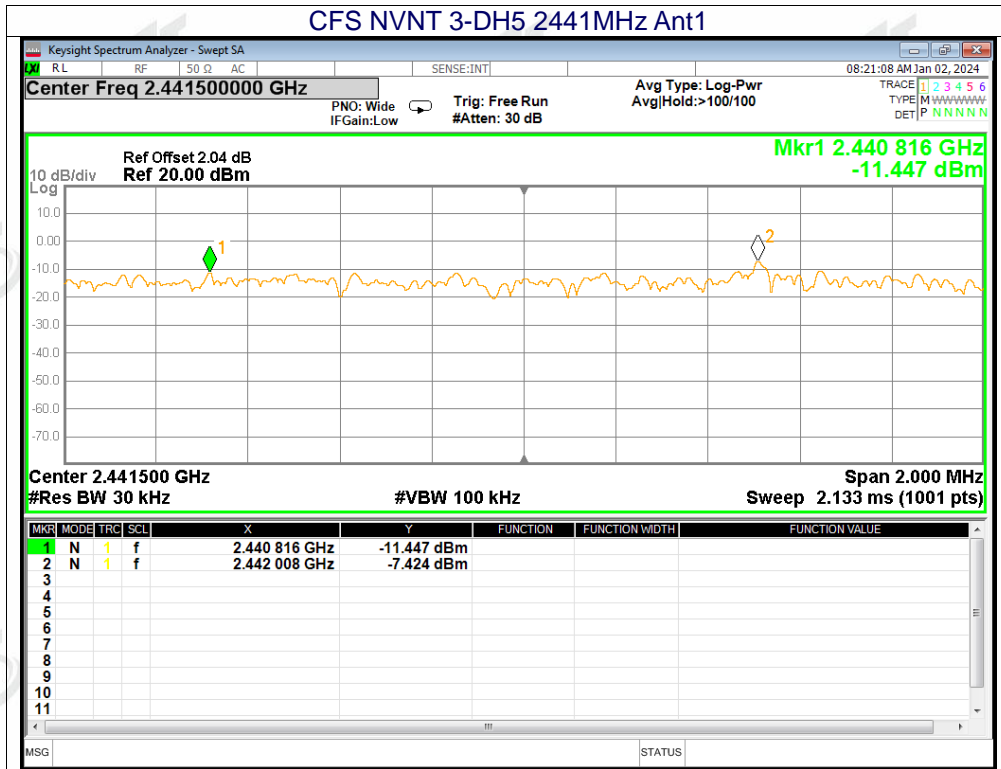



ZHONGHAN

13.6 Number of Hopping Channel

Mode	Hopping Number	Limit	Verdict
1-DH5	79	15	Pass
2-DH5	79	15	Pass
3-DH5	79	15	Pass

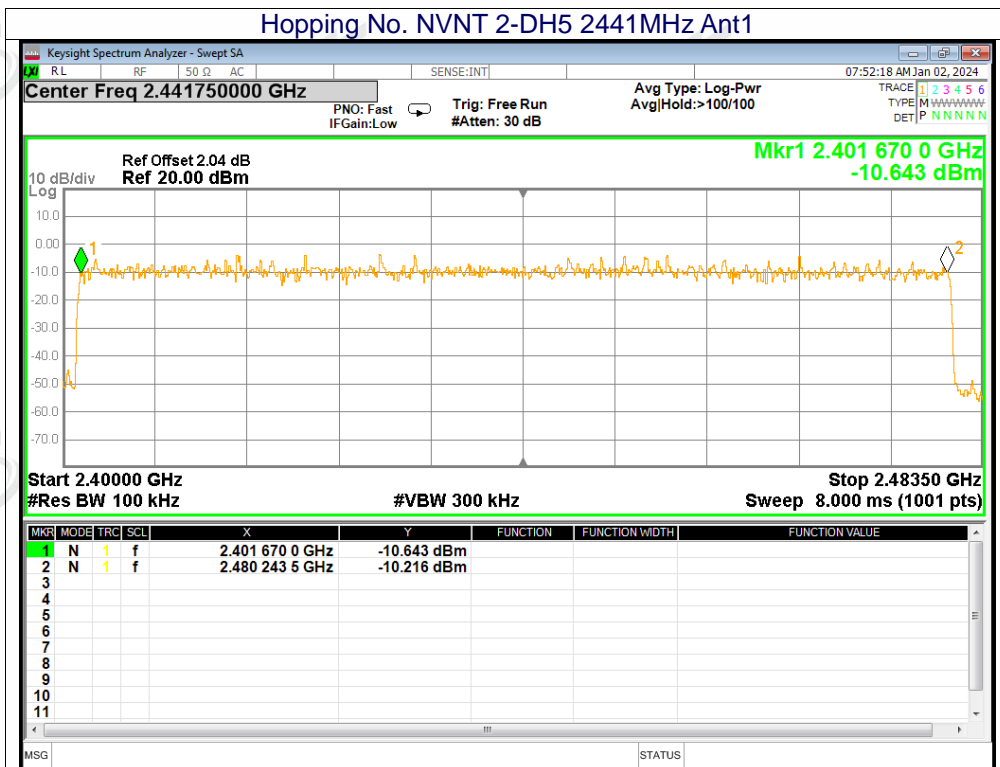
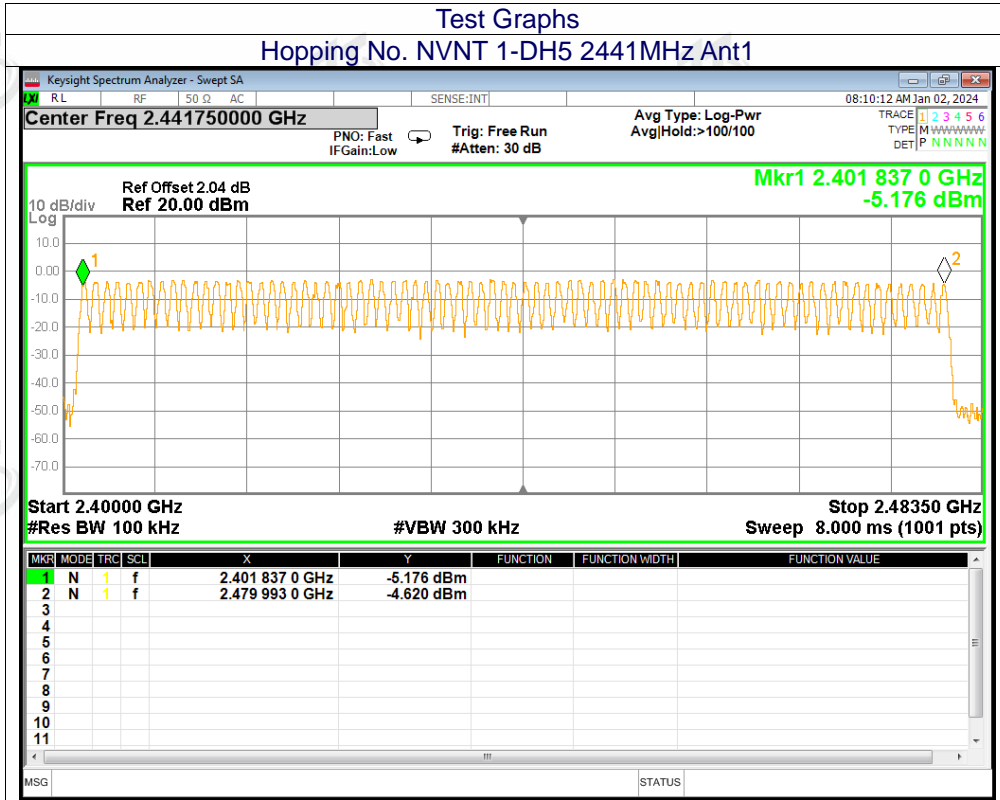



ZHONGHAN

13.7 Band Edge

Mode	Frequency (MHz)	Max Value (dBc)	Limit (dBc)	Verdict
1-DH5	2402	-39.93	-20	Pass
1-DH5	2480	-42.44	-20	Pass
2-DH5	2402	-40.92	-20	Pass
2-DH5	2480	-46.49	-20	Pass
3-DH5	2402	-40.47	-20	Pass
3-DH5	2480	-45	-20	Pass

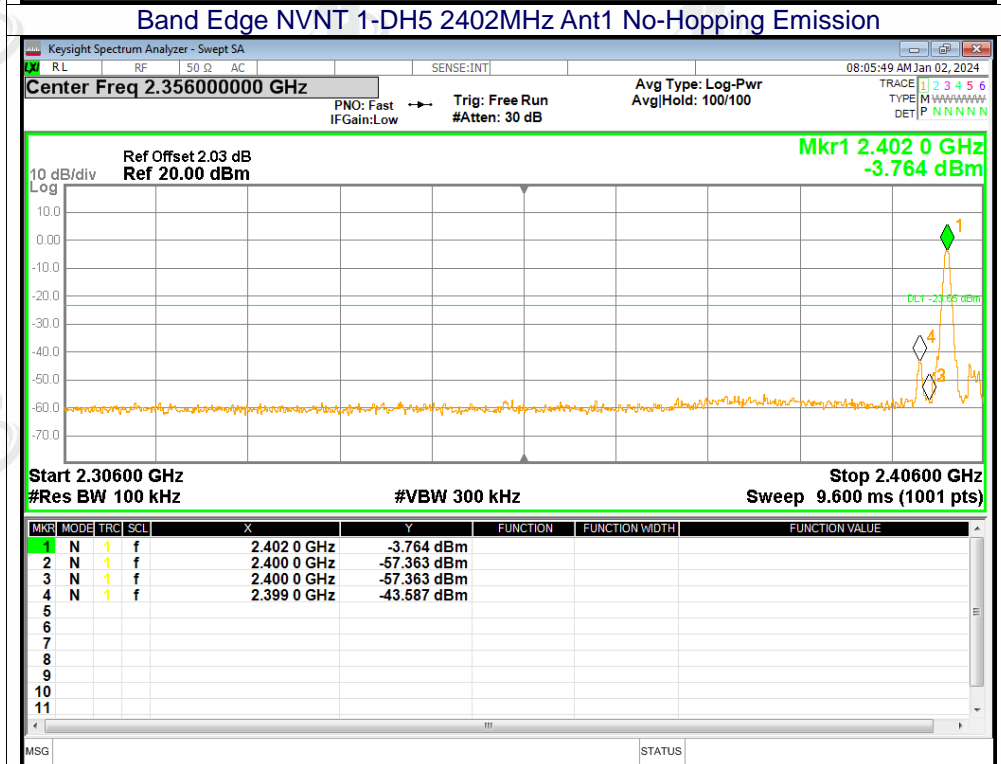
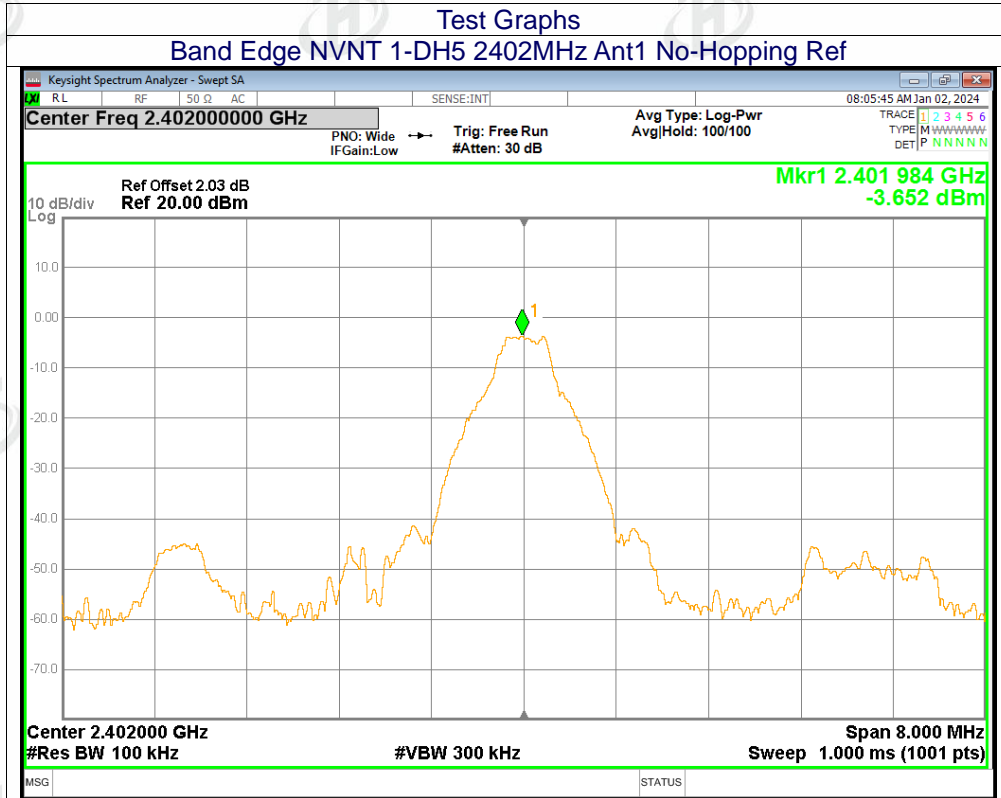

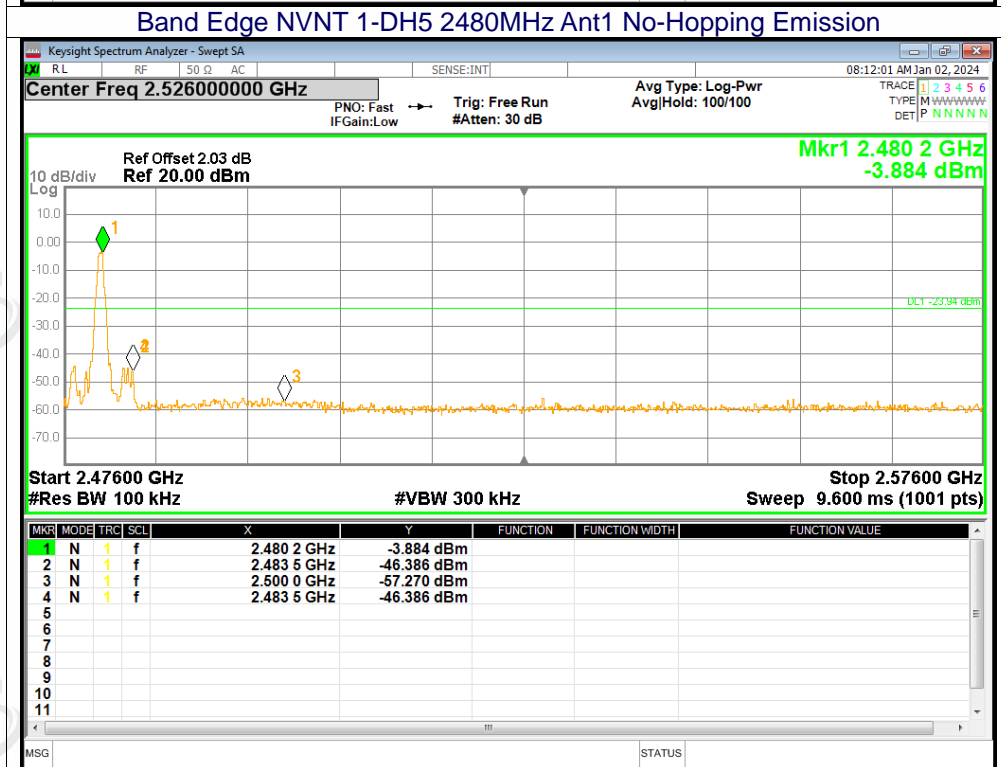
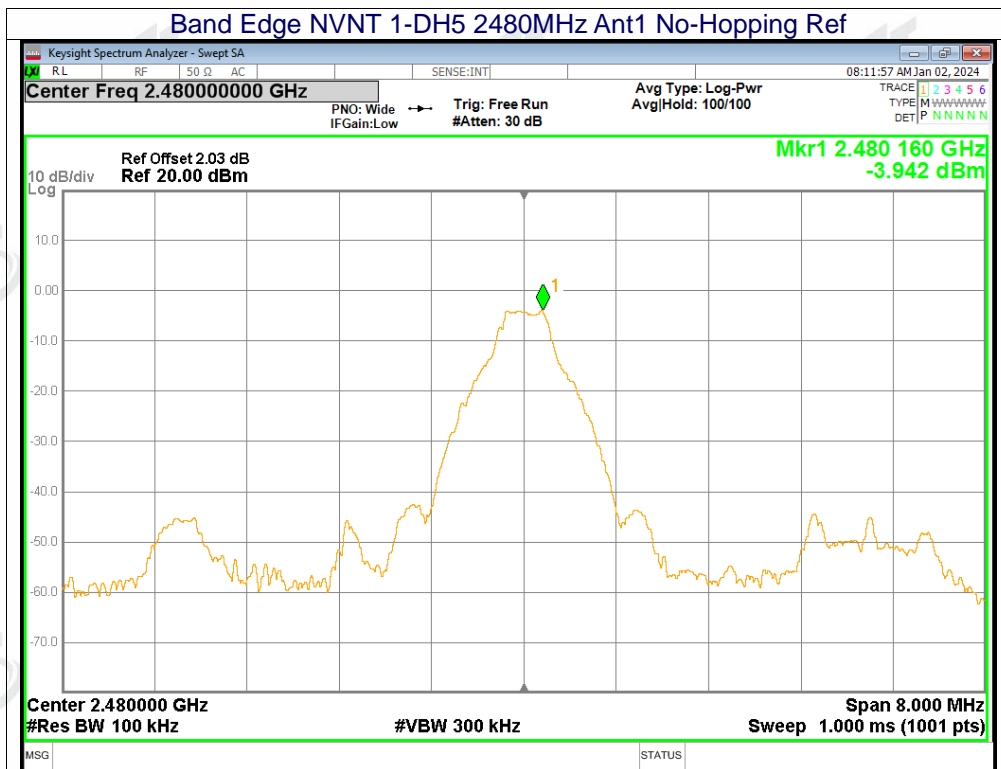

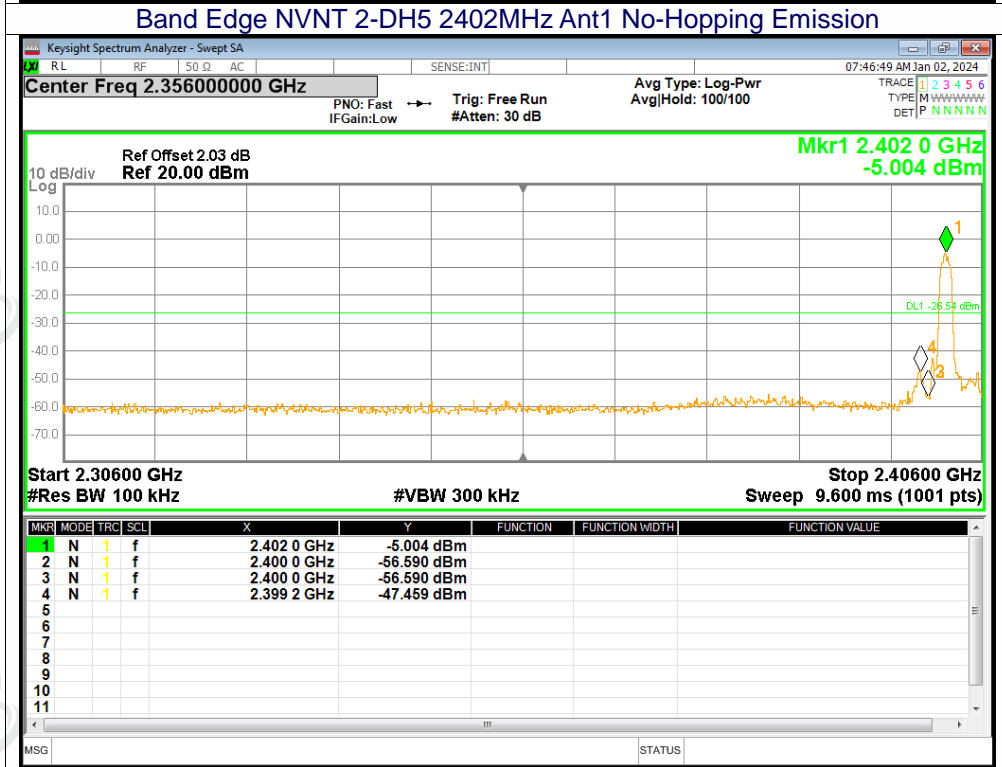
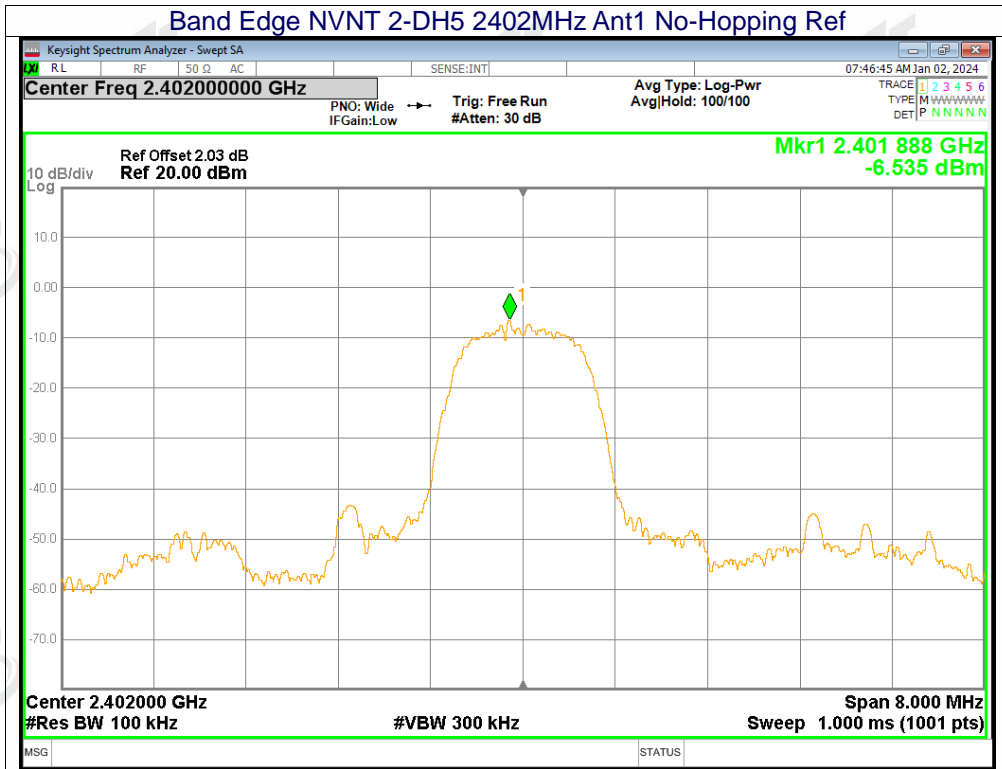

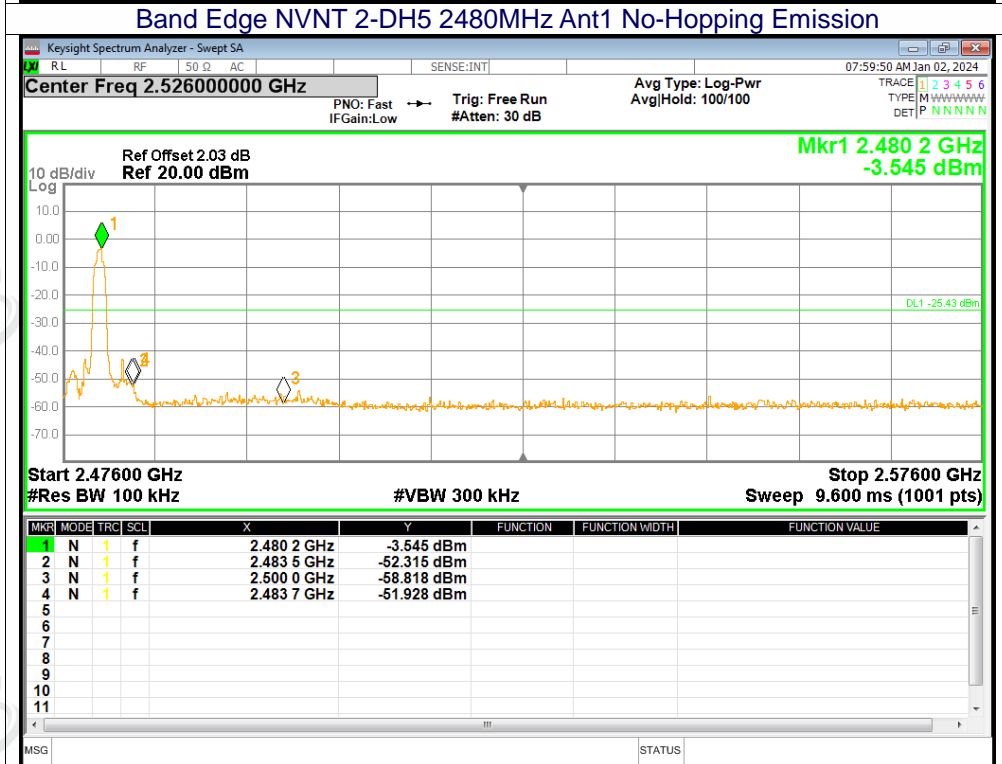
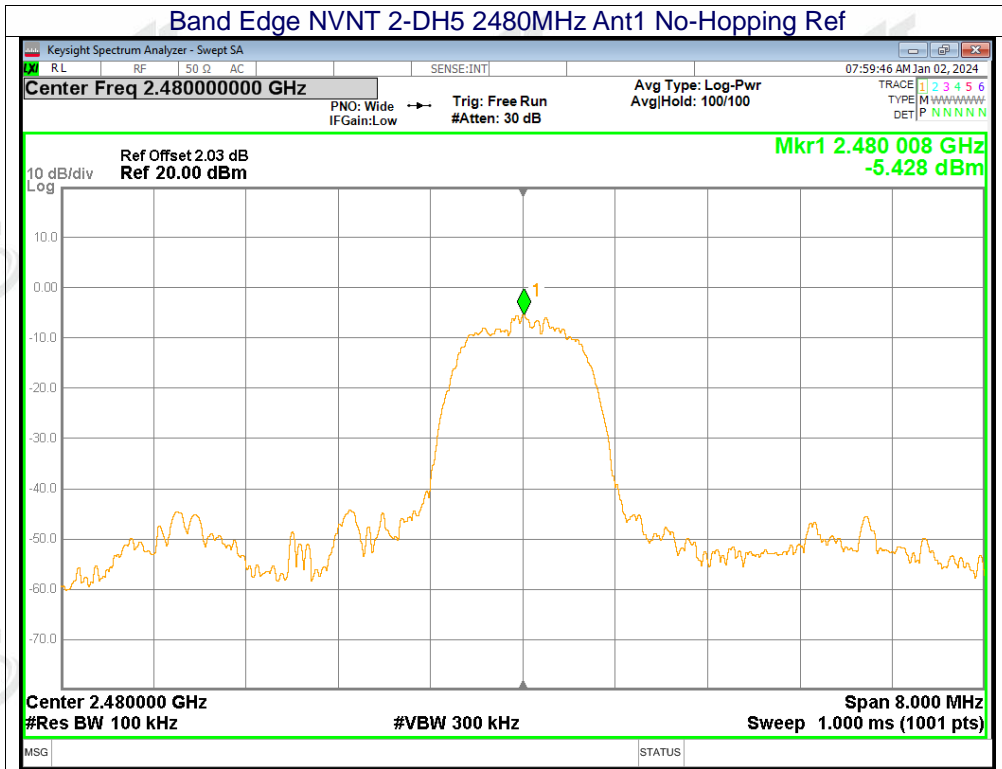

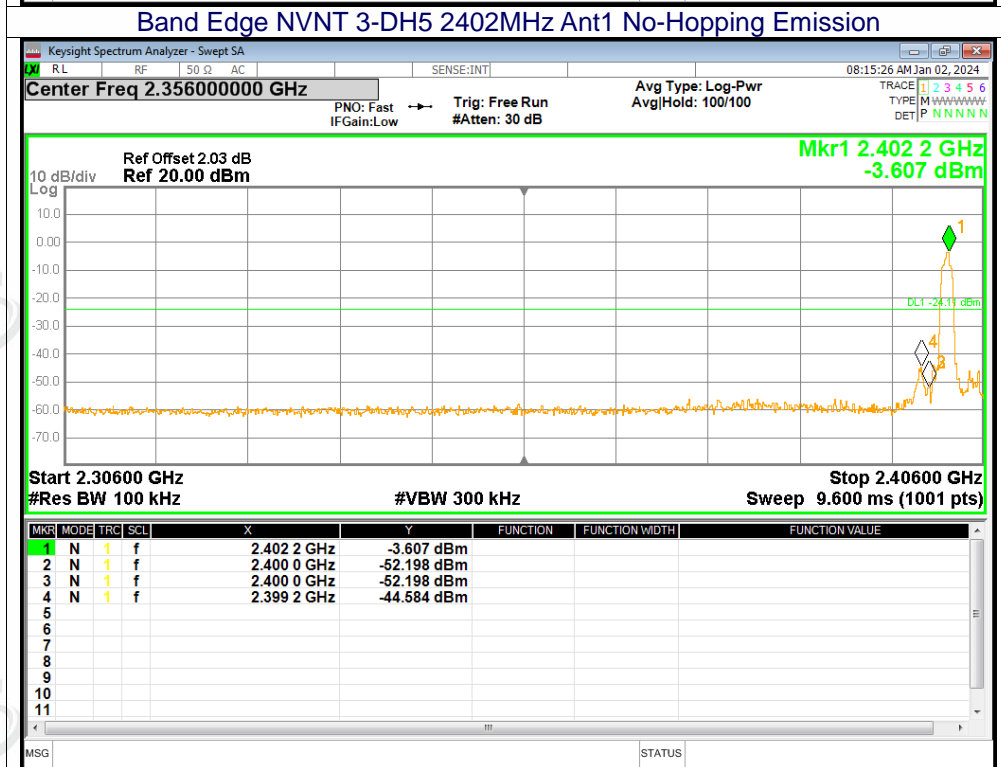
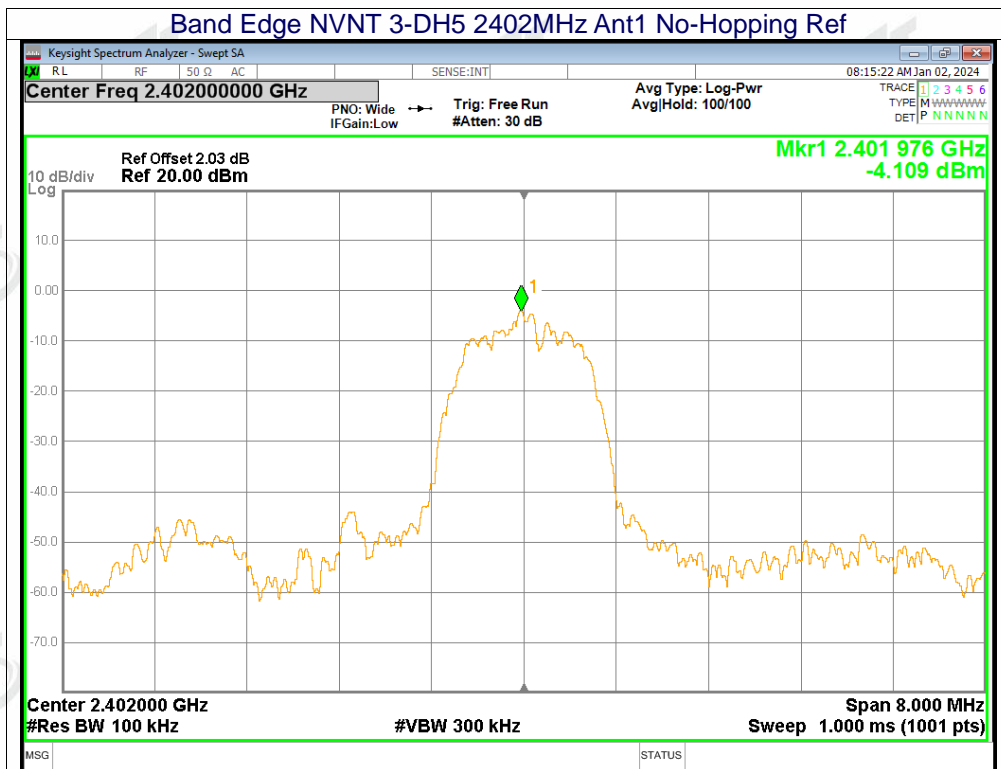

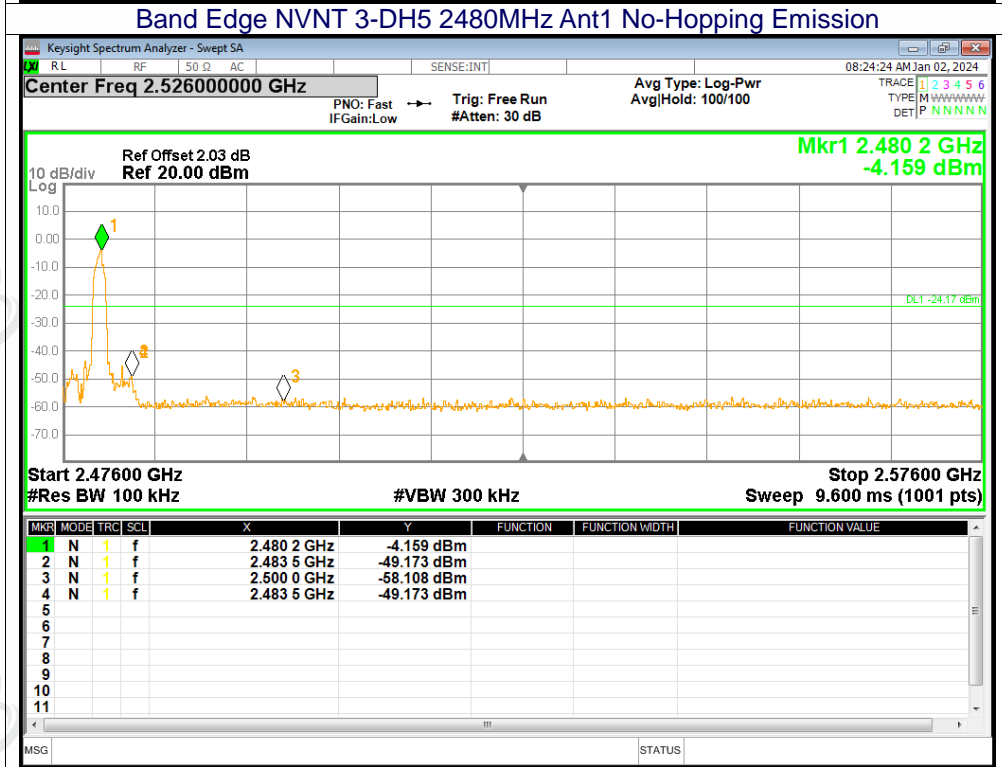
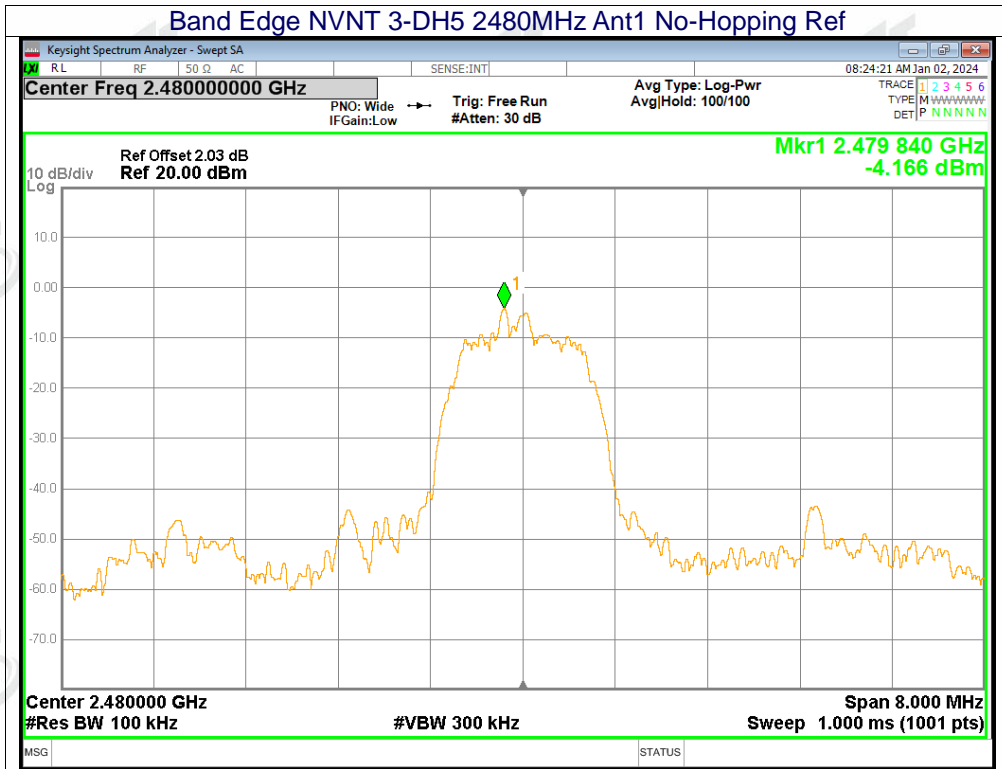



13.8 Band Edge(Hopping)

Mode	Frequency (MHz)	Max Value (dBc)	Limit (dBc)	Verdict
1-DH5	2402	-51.55	-20	Pass
1-DH5	2480	-44.26	-20	Pass
1-DH5	2480	-40.46	-20	Pass
2-DH5	2402	-51.37	-20	Pass
2-DH5	2480	-47.91	-20	Pass
3-DH5	2402	-52.12	-20	Pass
3-DH5	2480	-47.88	-20	Pass

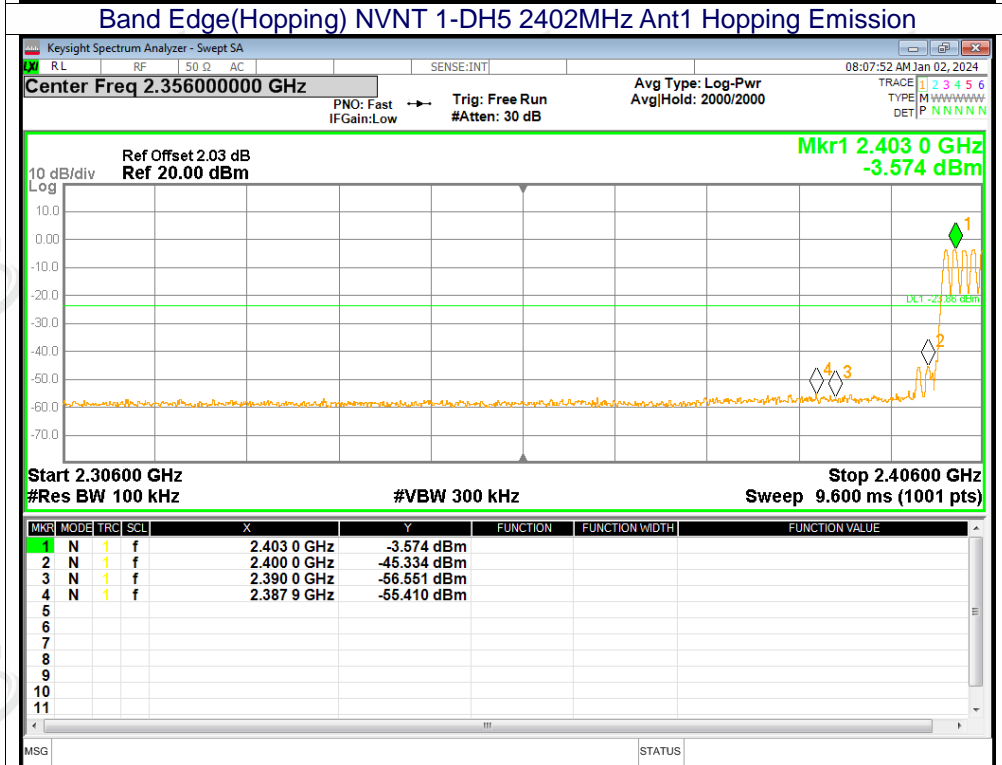
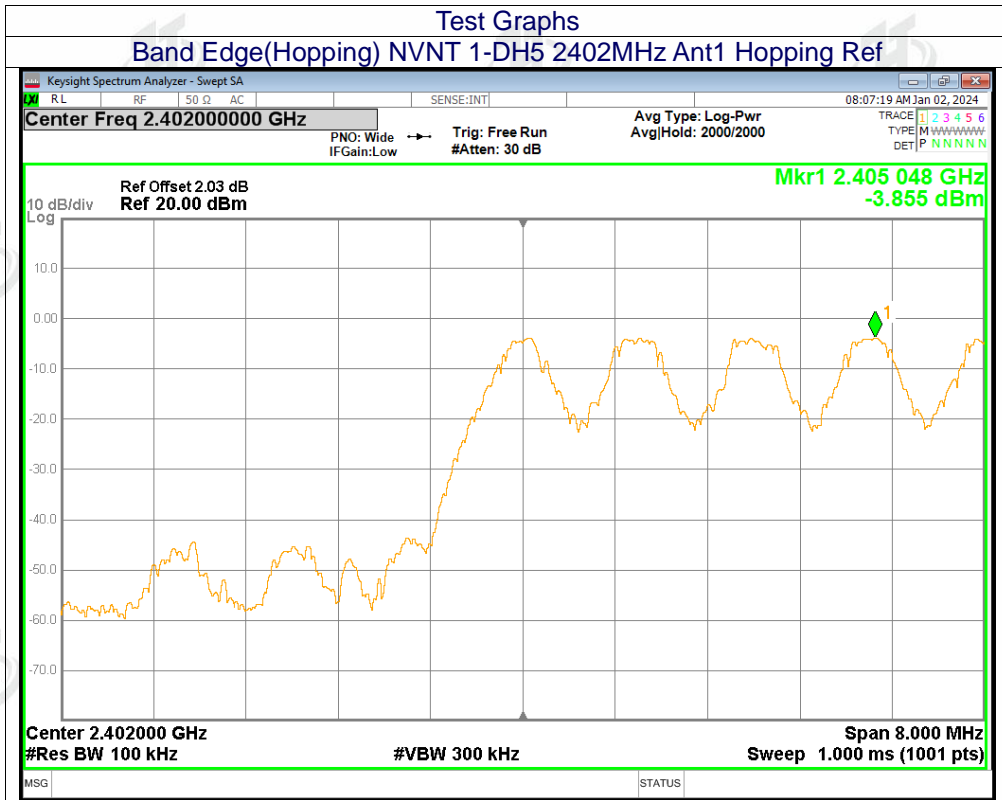

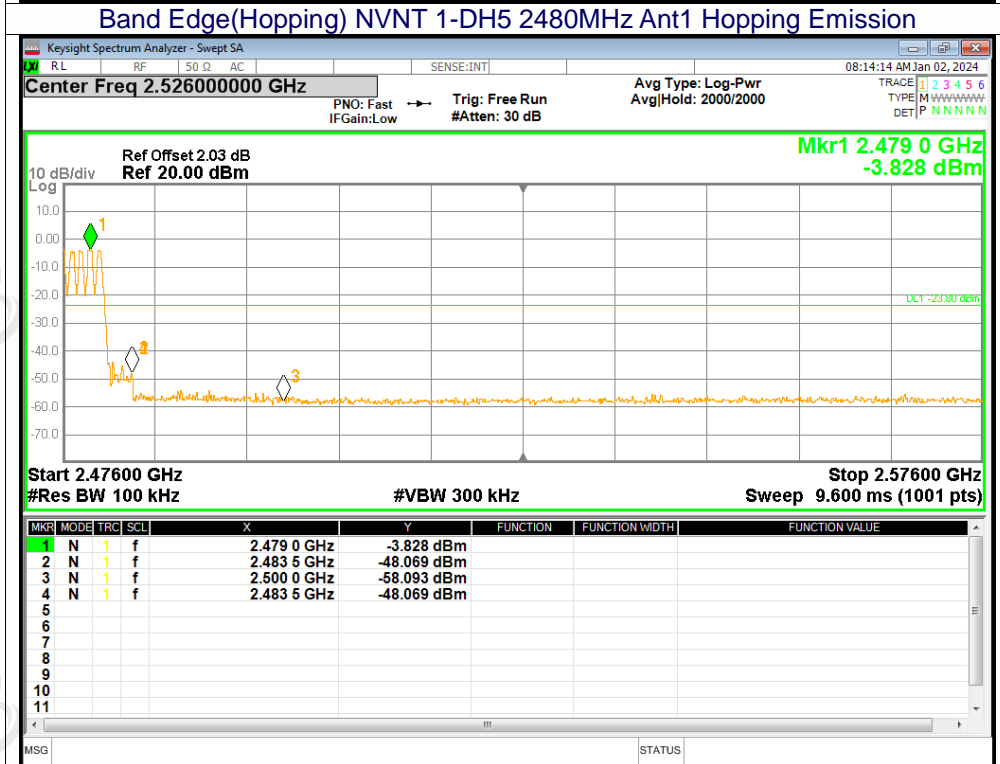
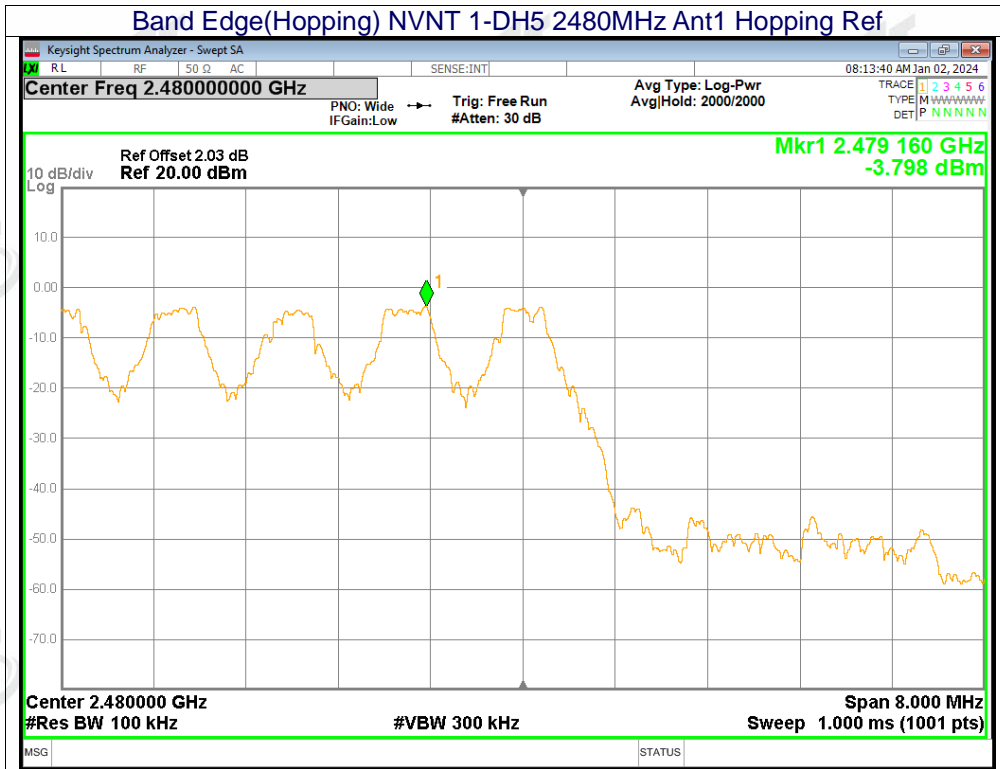

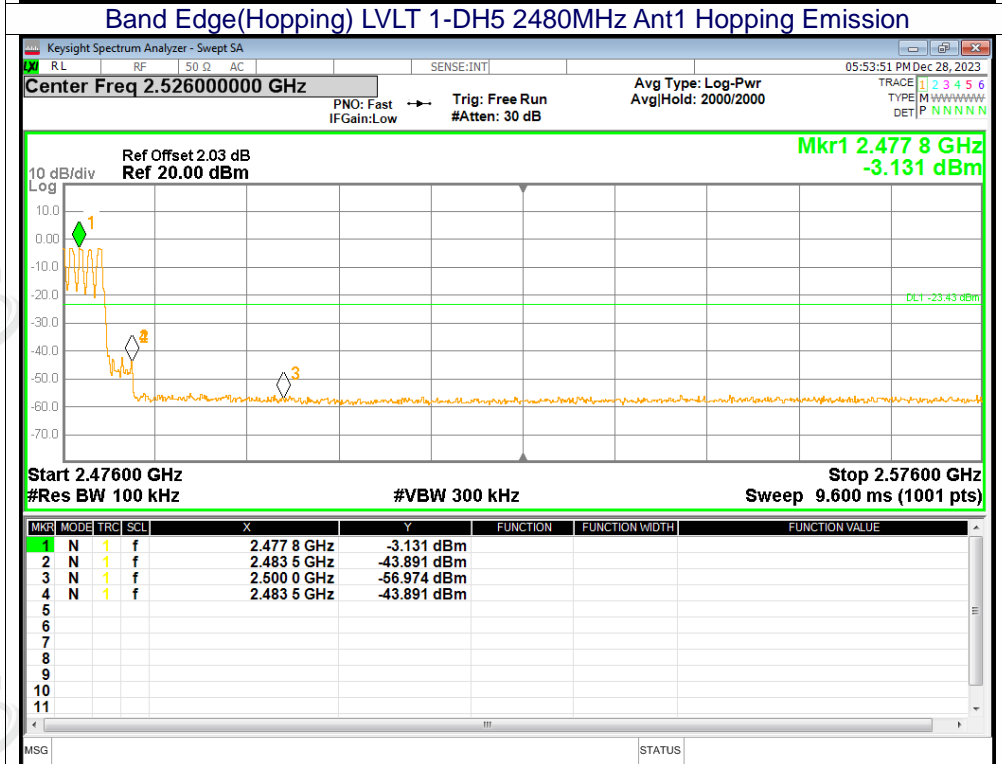
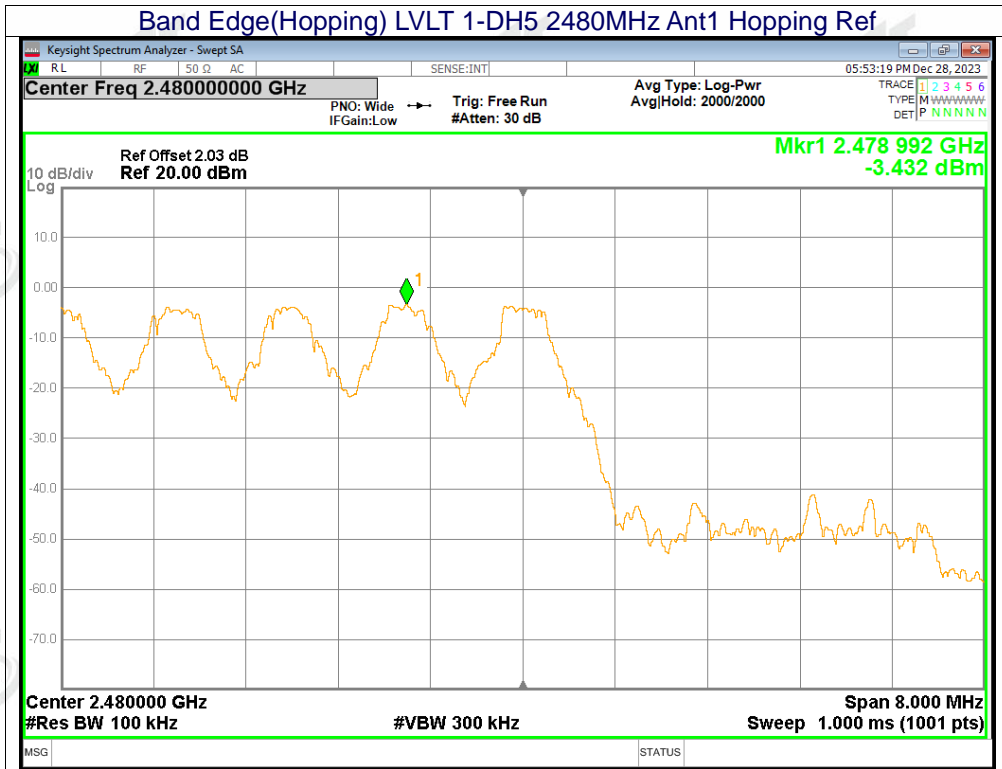

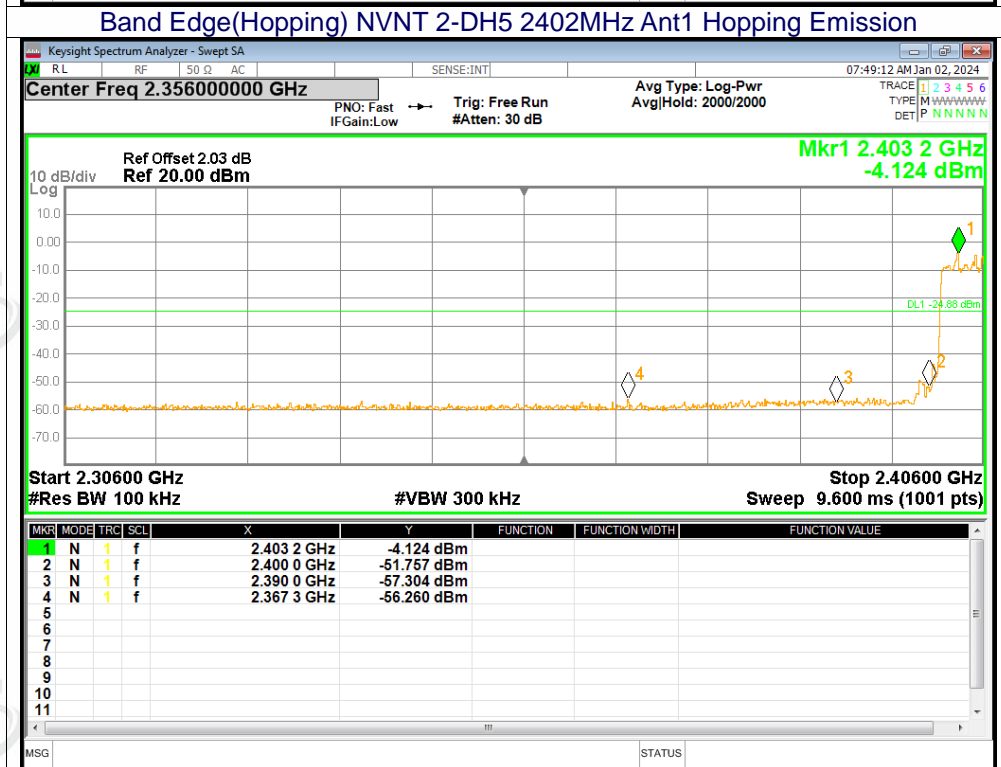
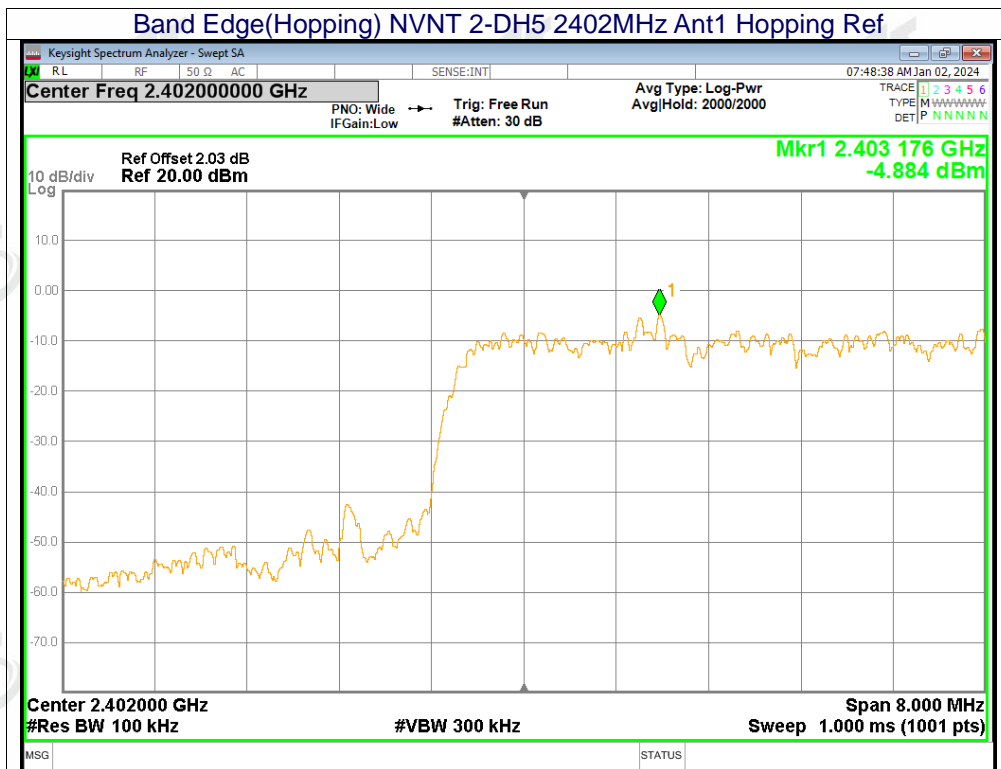

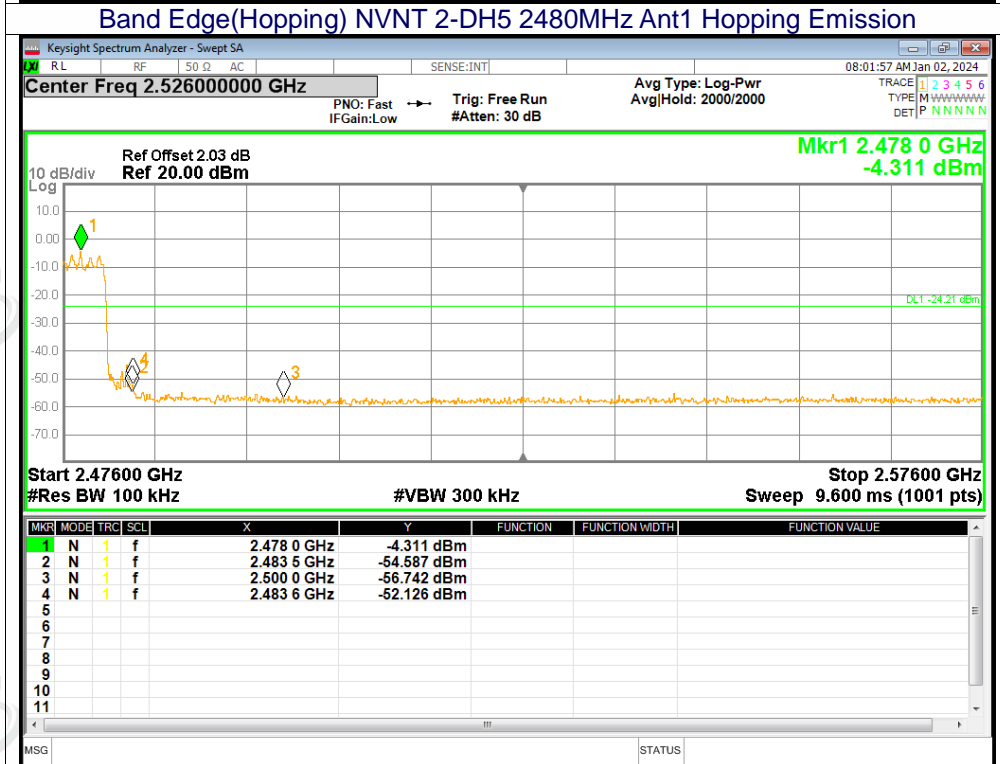
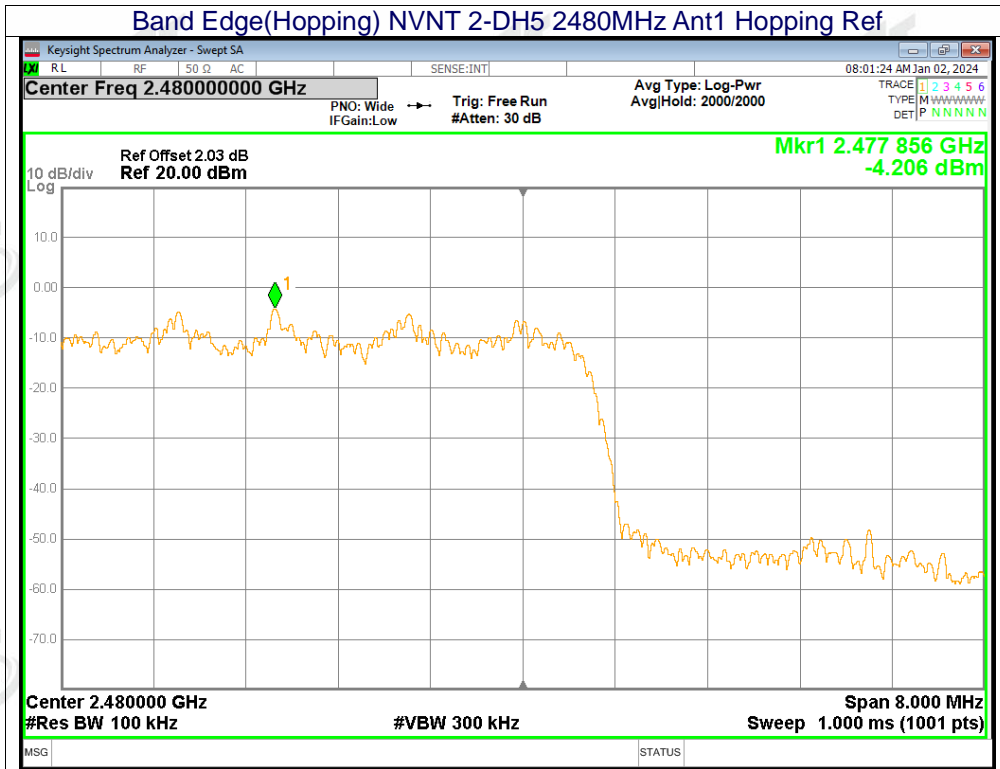

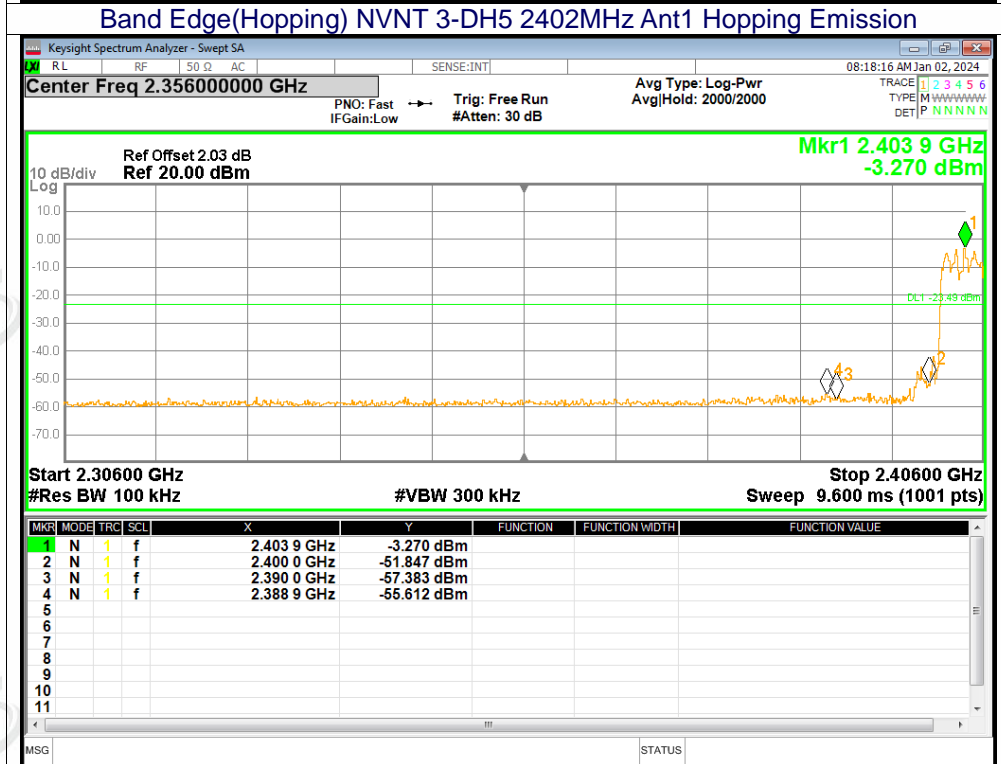
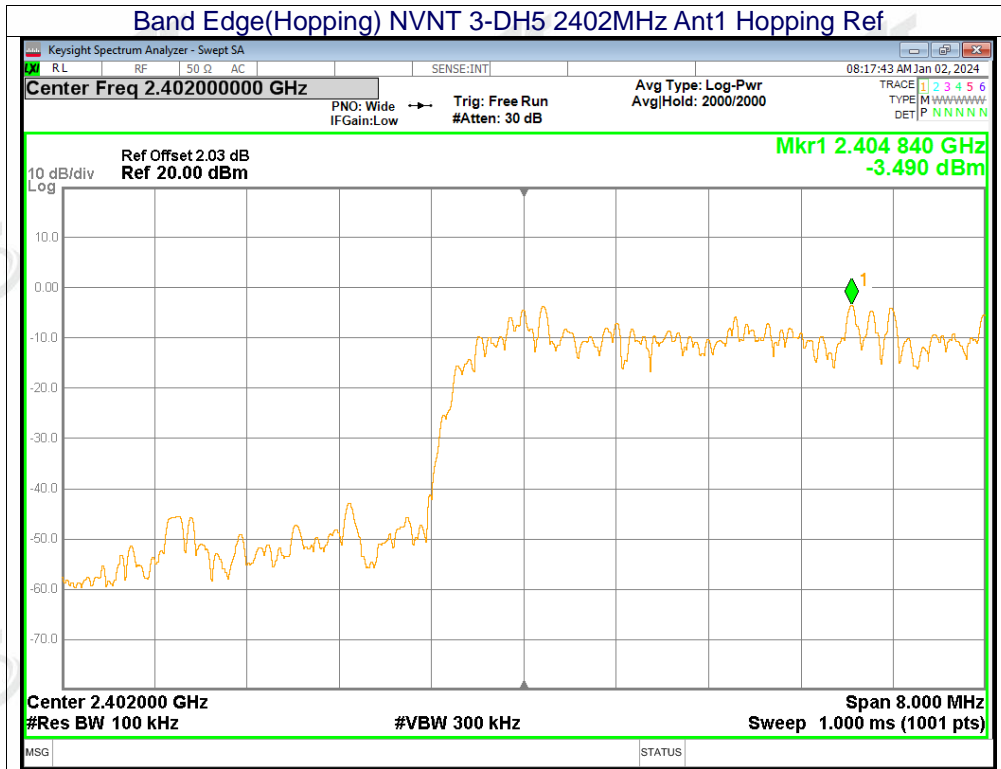

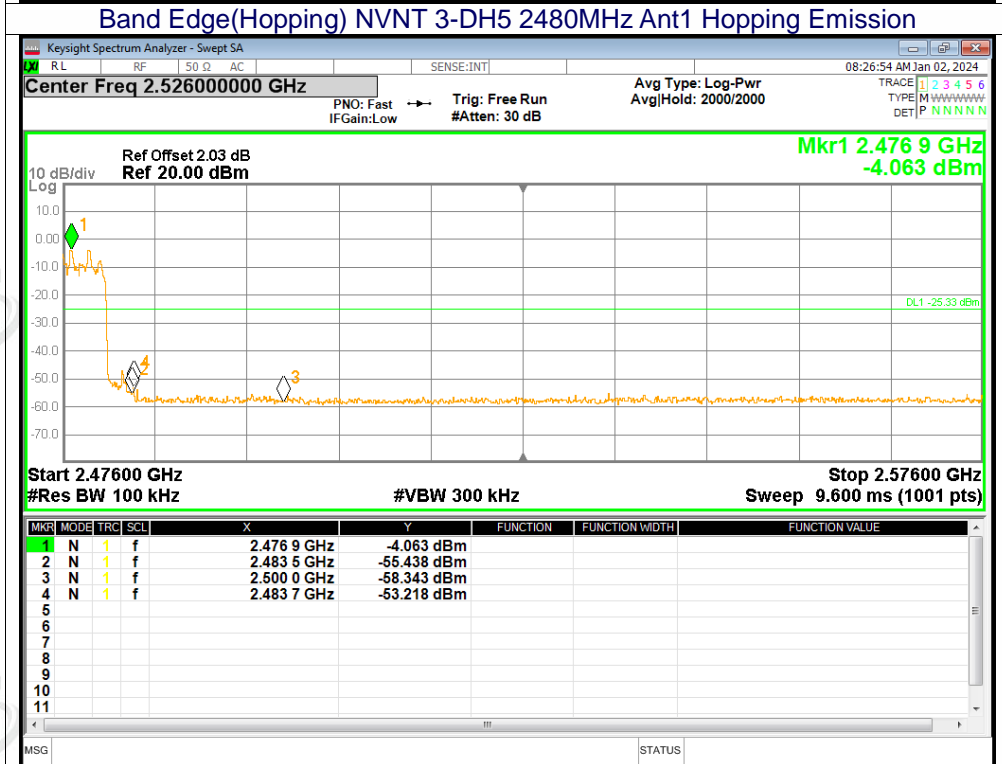
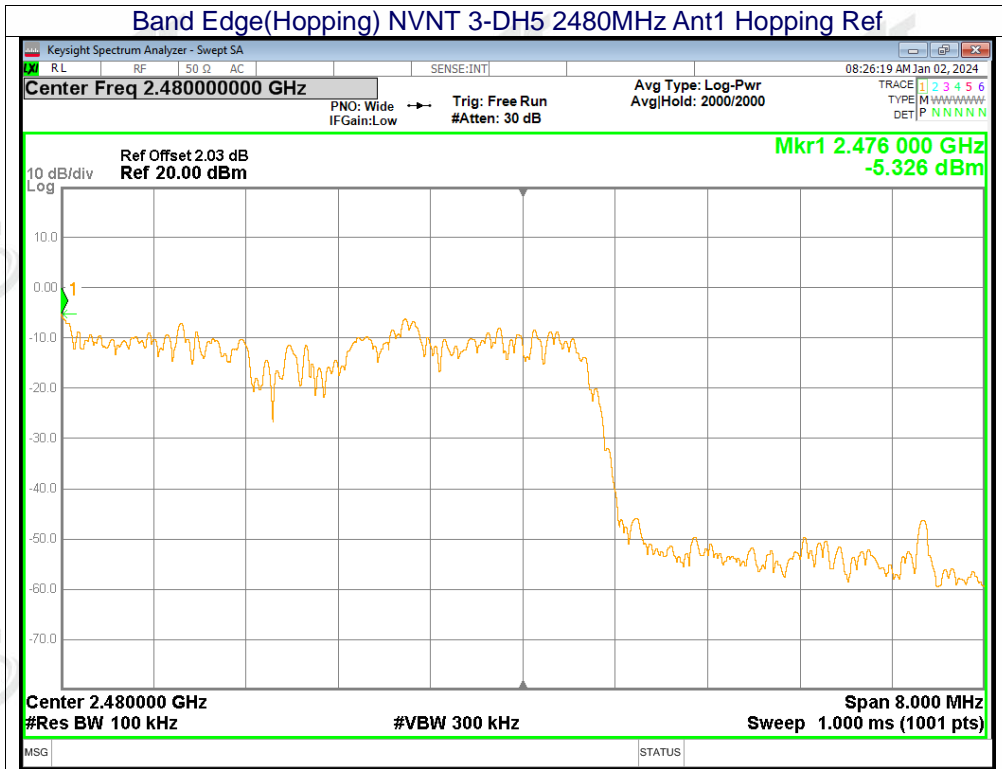



13.9 Conducted RF Spurious Emission

Mode	Frequency (MHz)	Max Value (dBc)	Limit (dBc)	Verdict
1-DH5	2402	-40.74	-20	Pass
1-DH5	2441	-42.32	-20	Pass
1-DH5	2480	-41.5	-20	Pass
1-DH5	2480	-43.13	-20	Pass
2-DH5	2402	-41.2	-20	Pass
2-DH5	2441	-27.63	-20	Pass
2-DH5	2480	-42.32	-20	Pass
3-DH5	2402	-40.4	-20	Pass
3-DH5	2441	-43.41	-20	Pass
3-DH5	2480	-41.37	-20	Pass

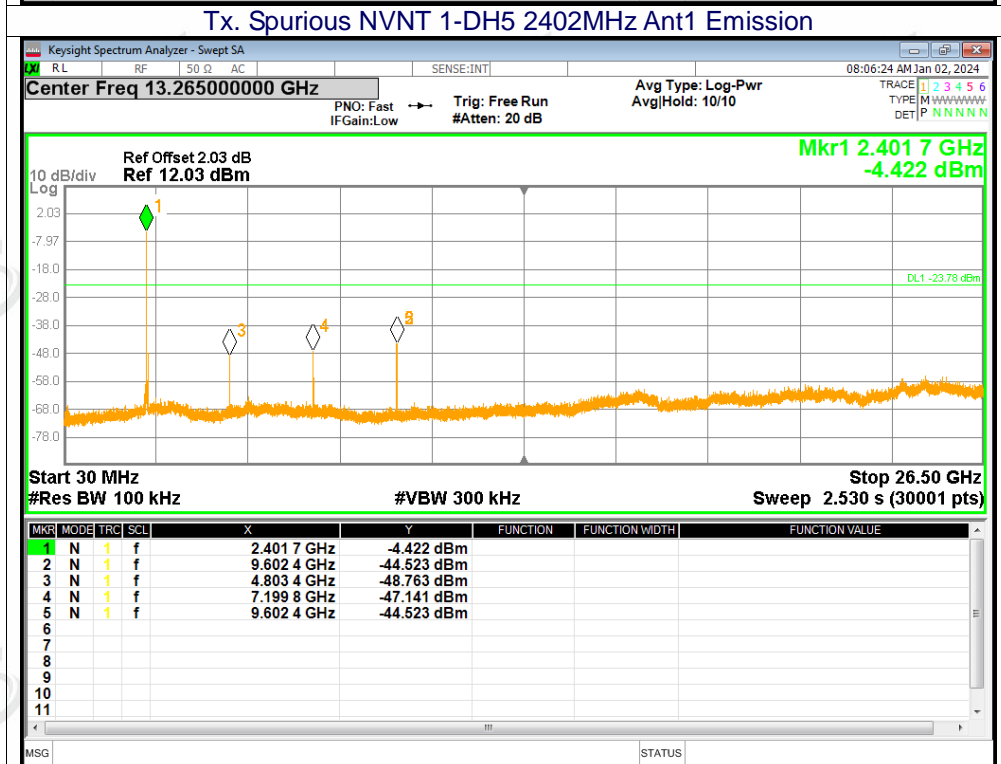
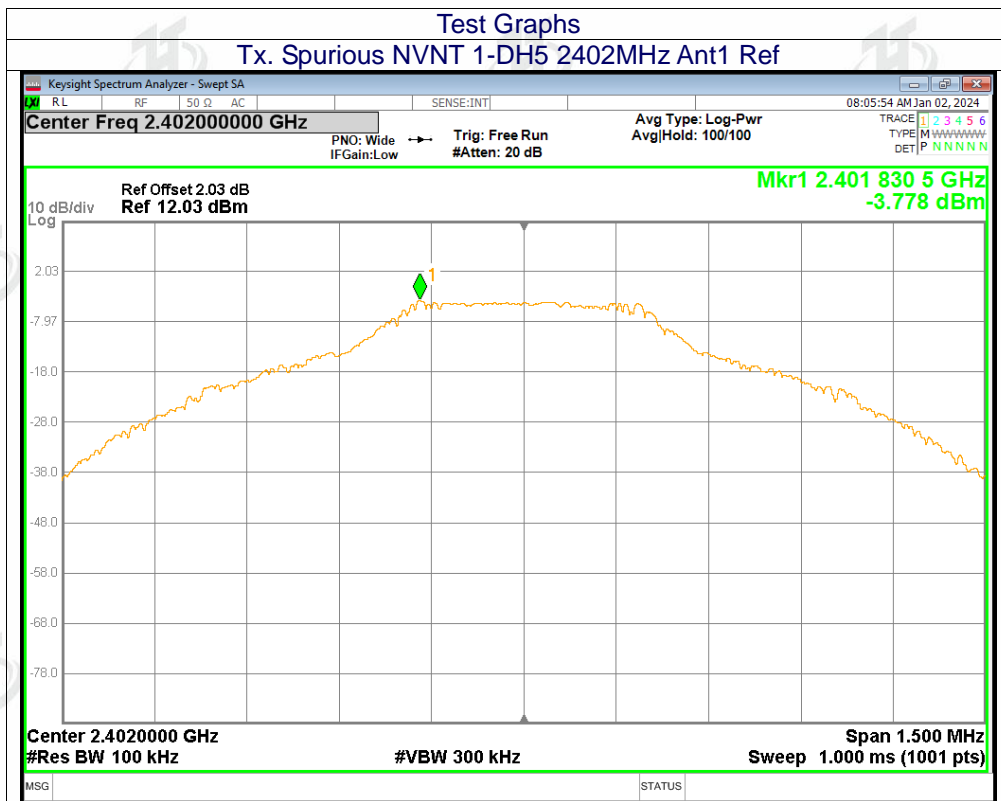

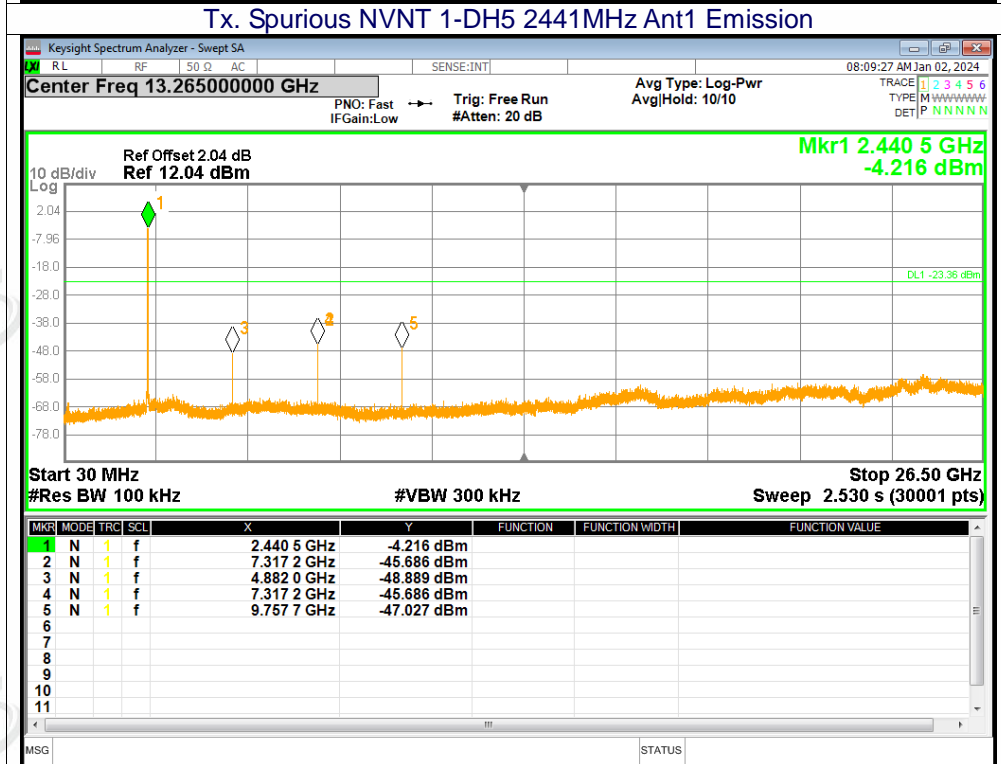
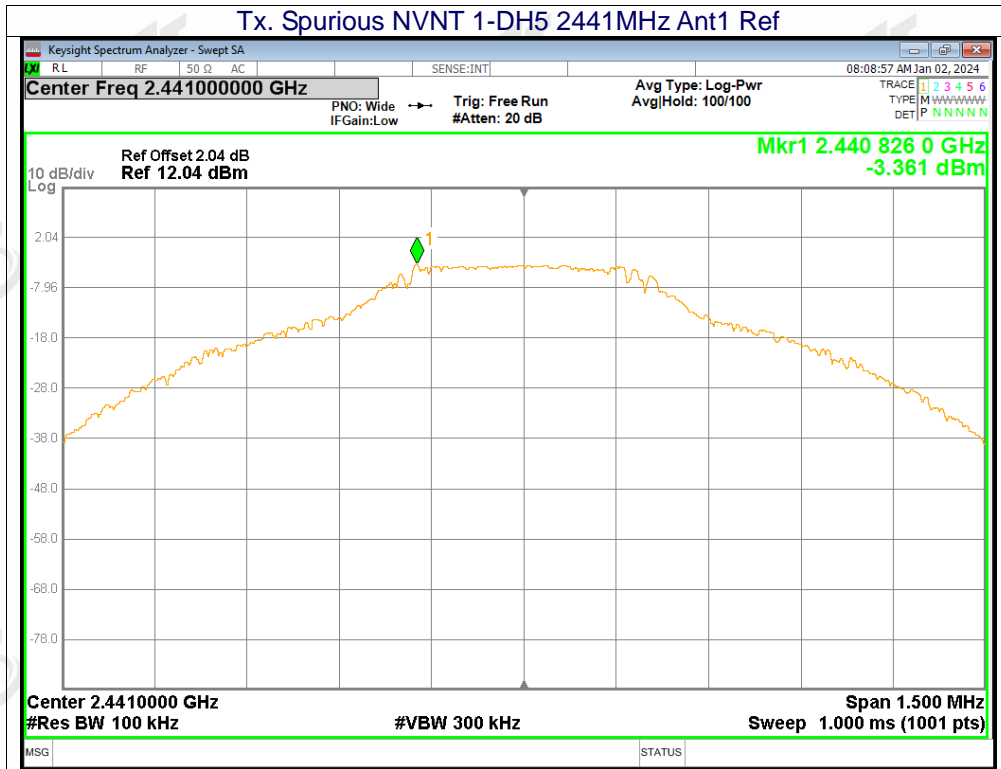

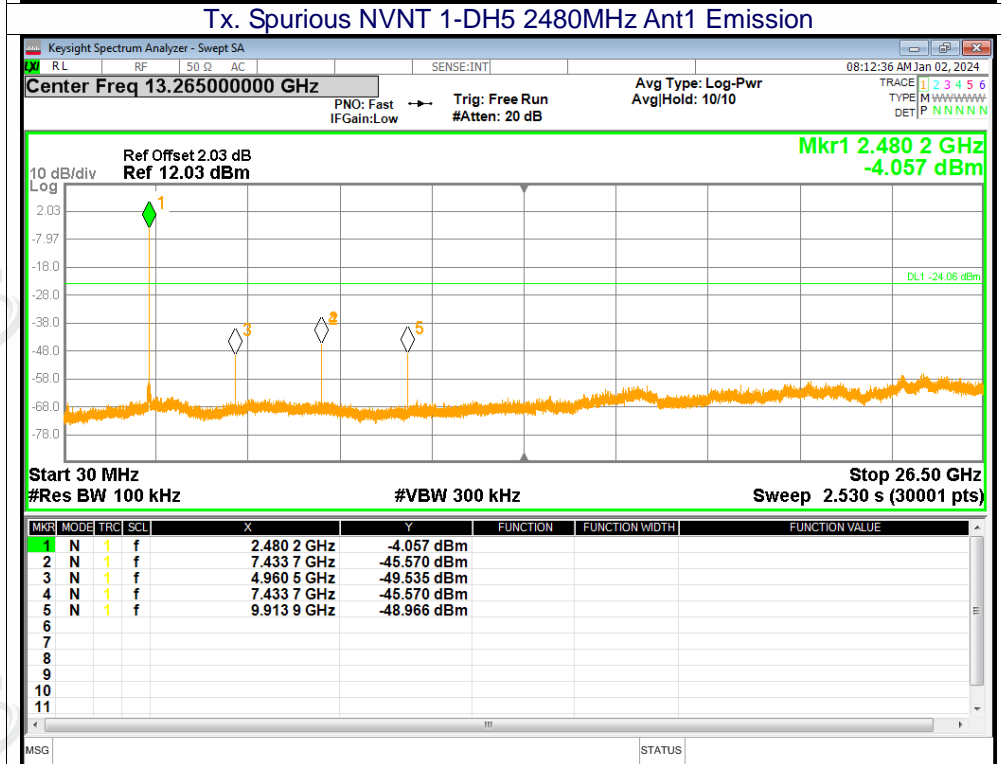
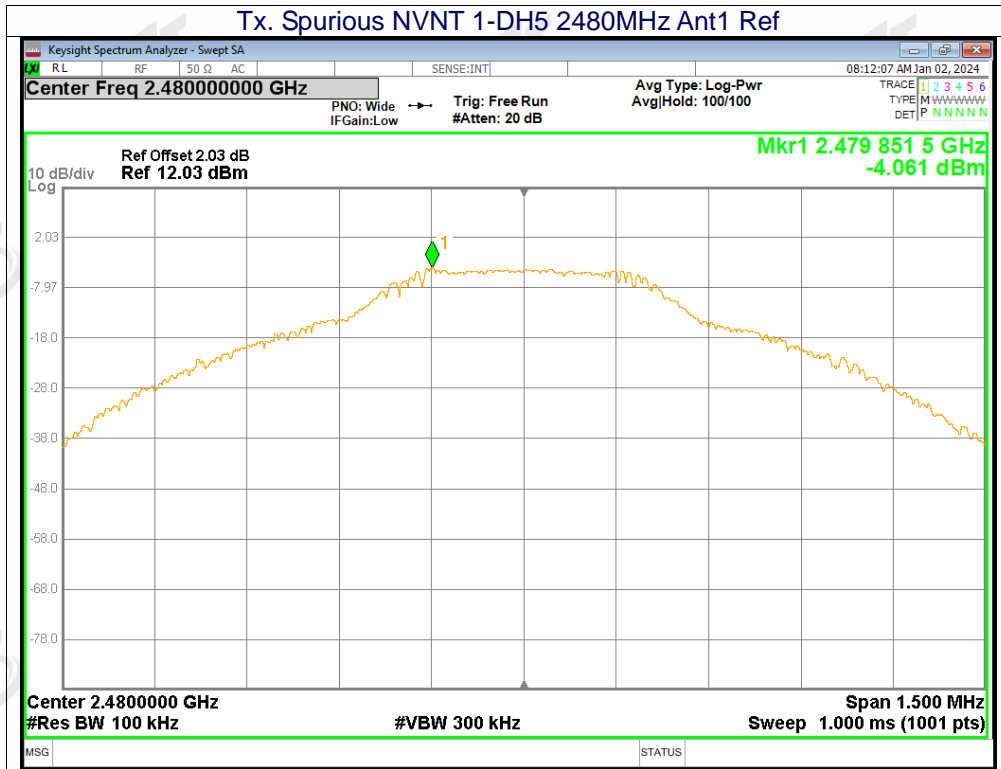

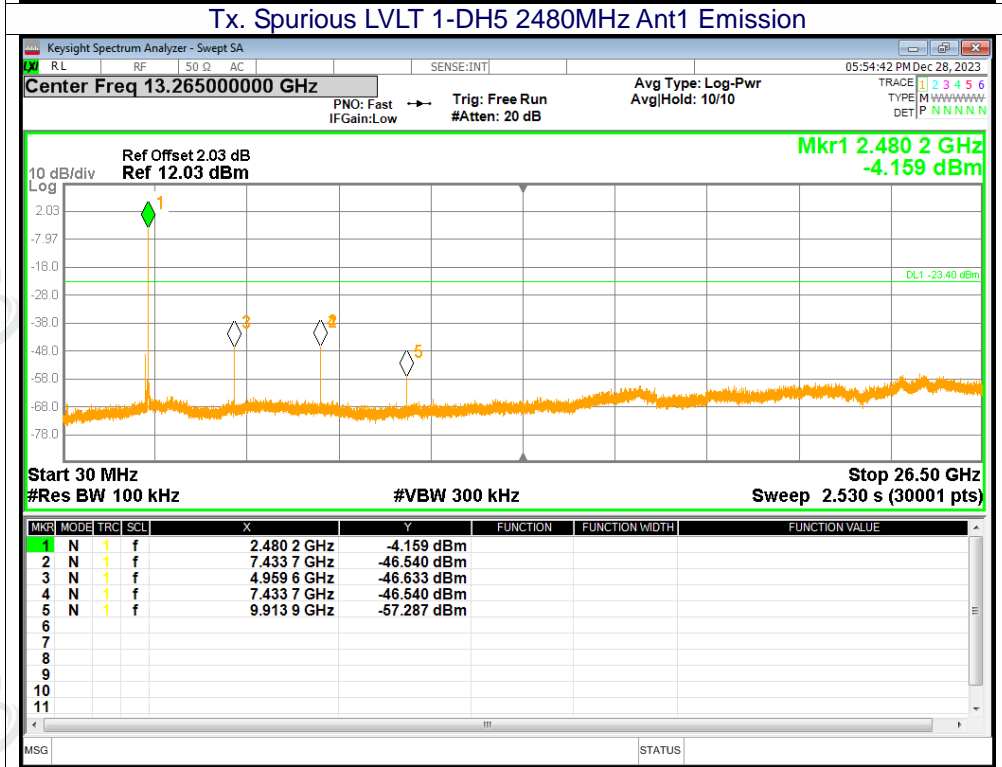
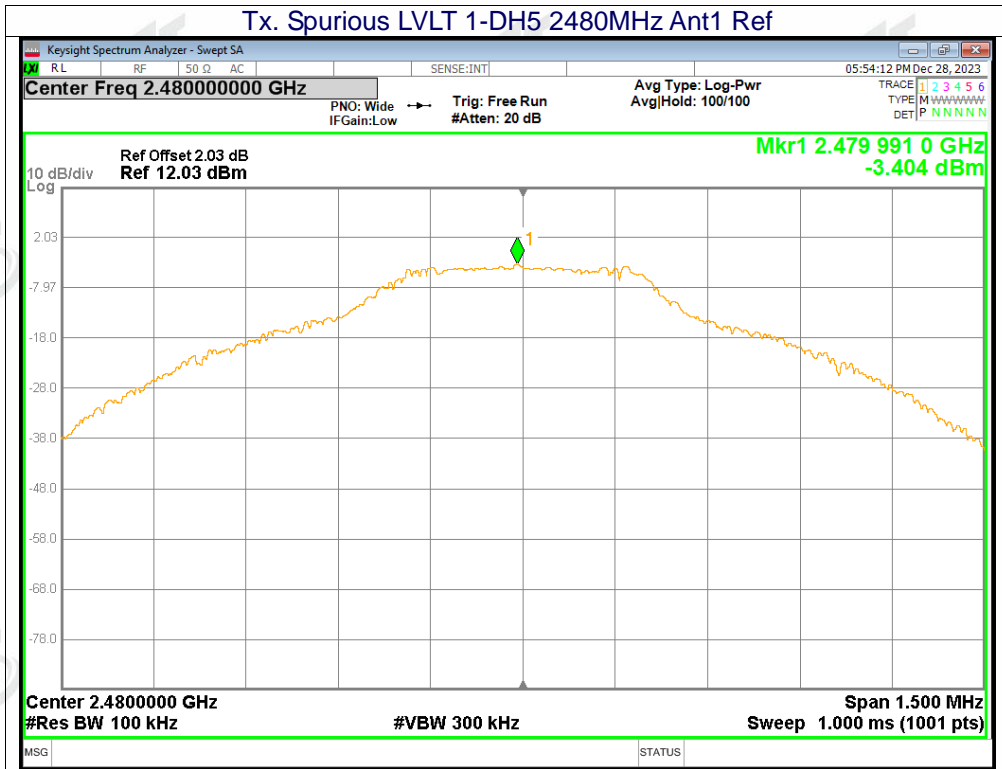

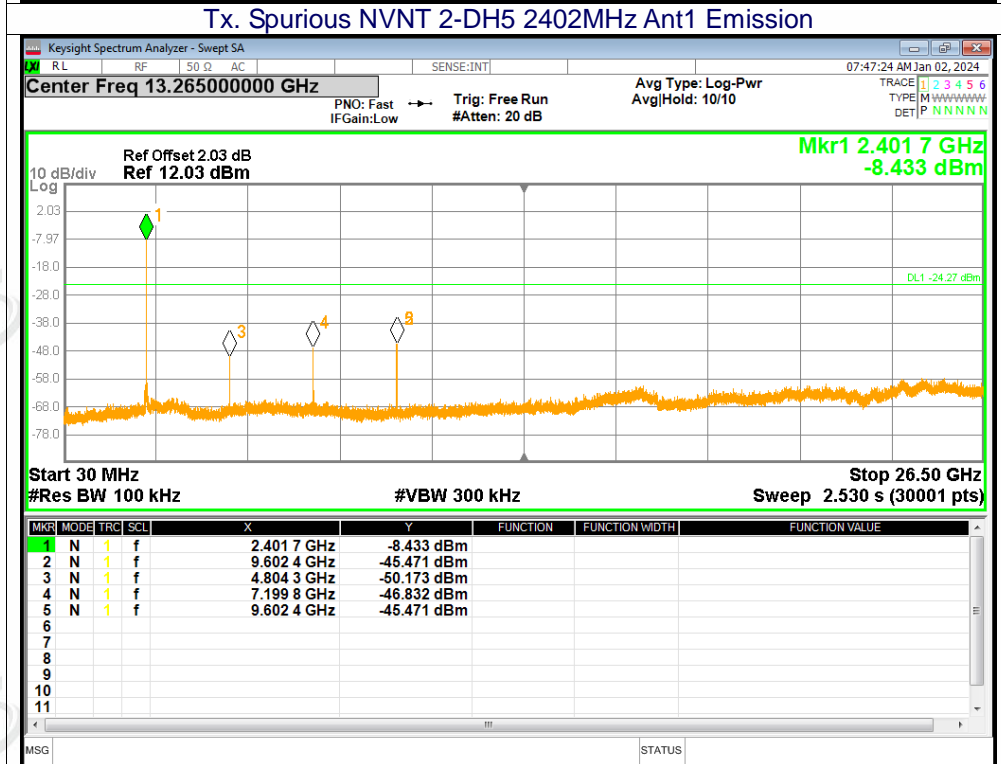
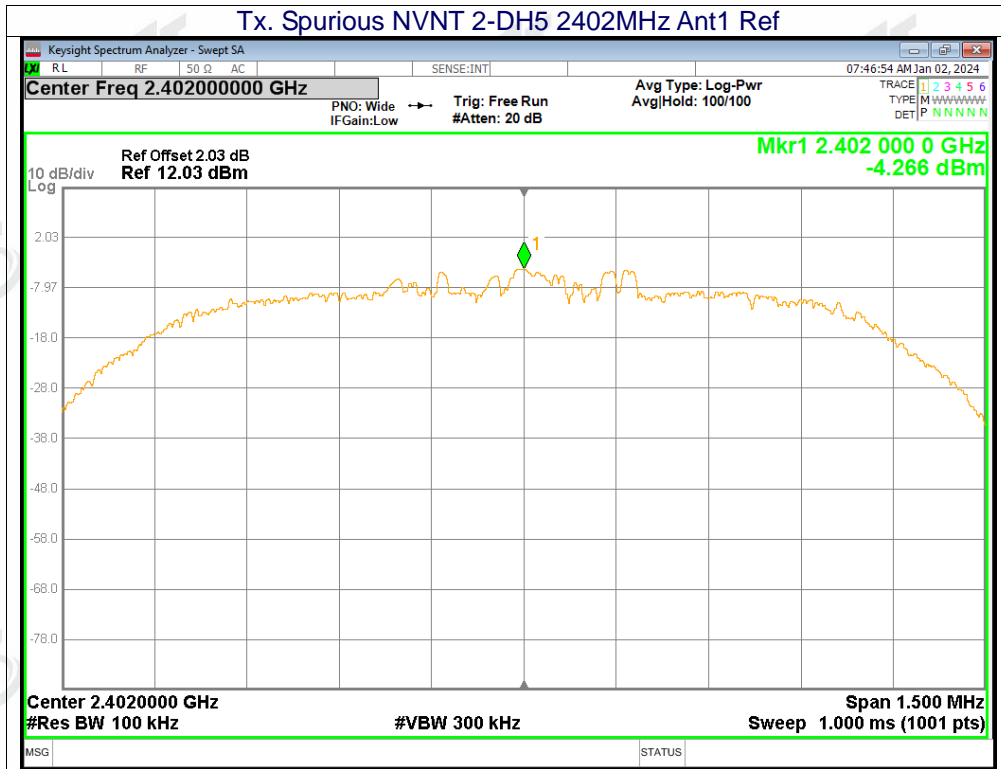

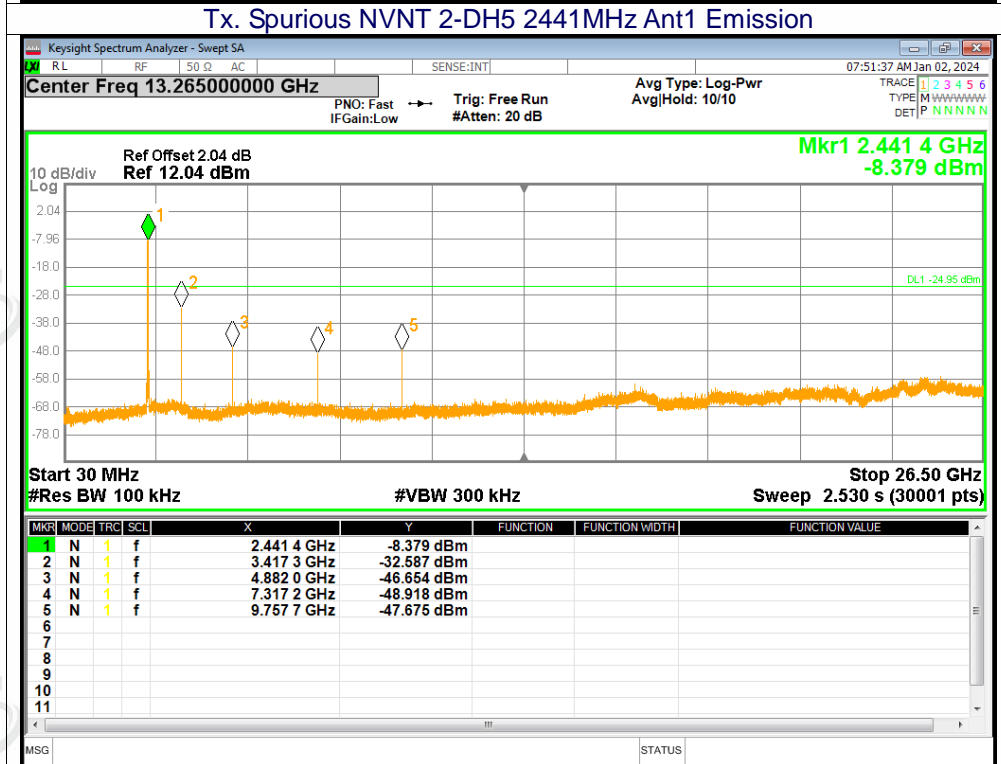
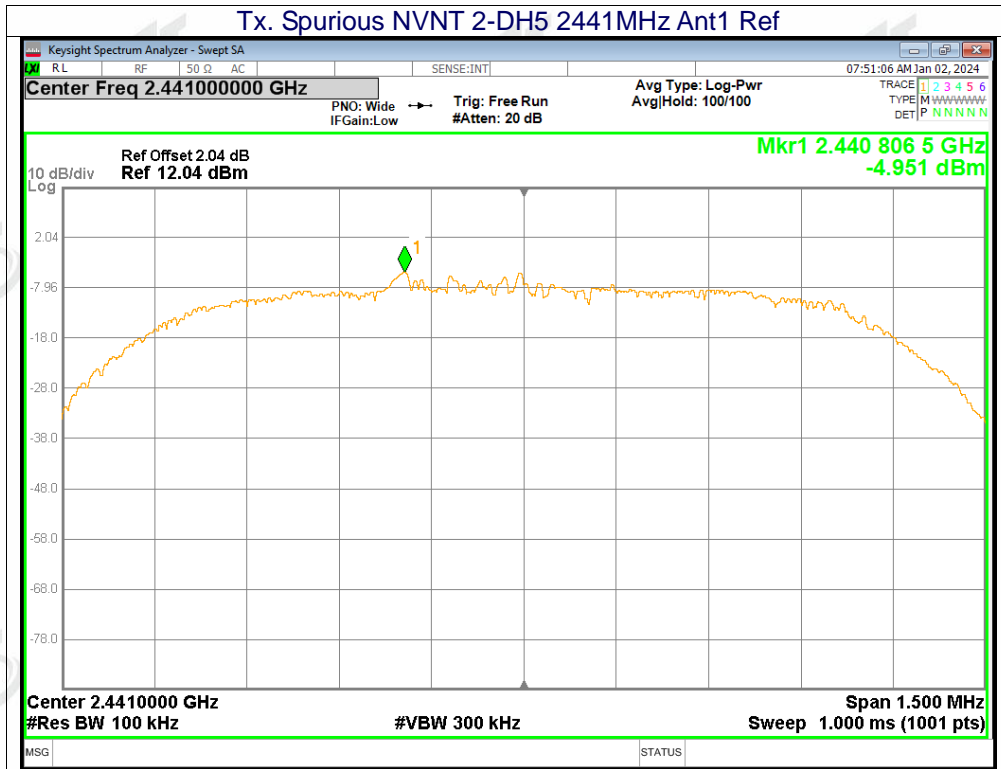

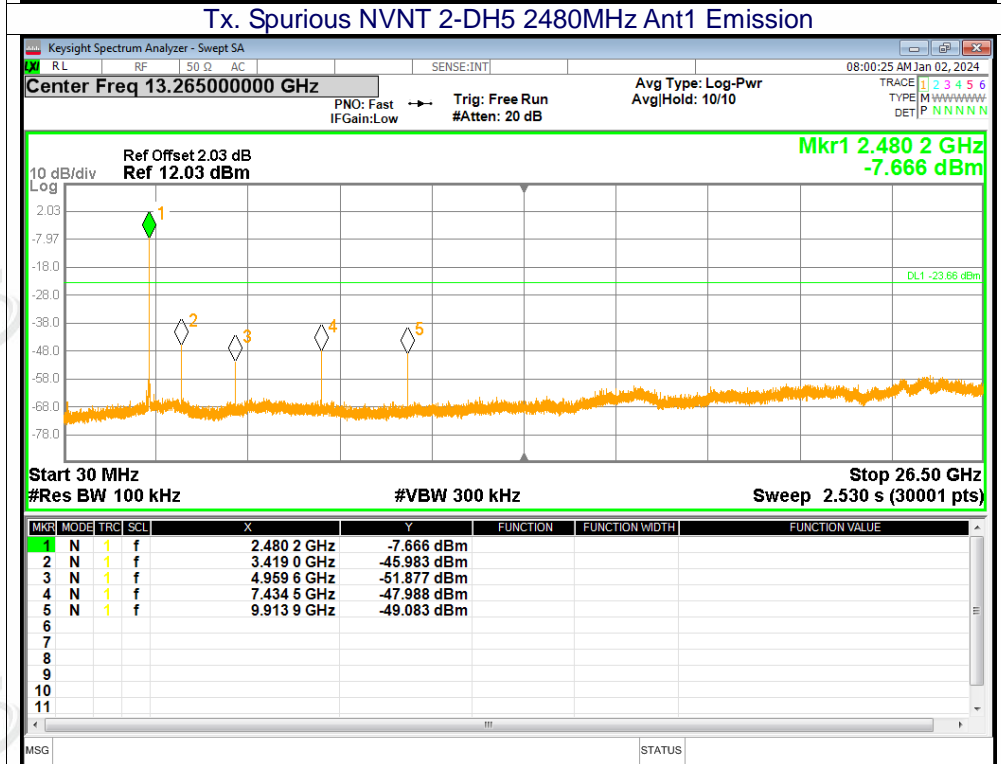
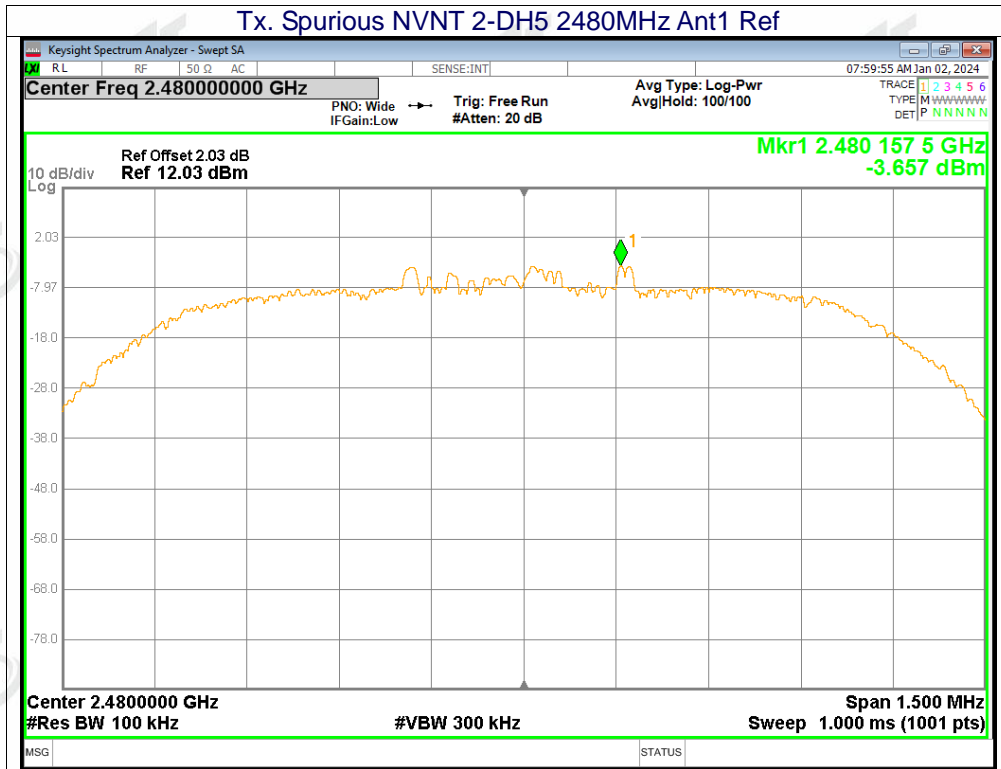

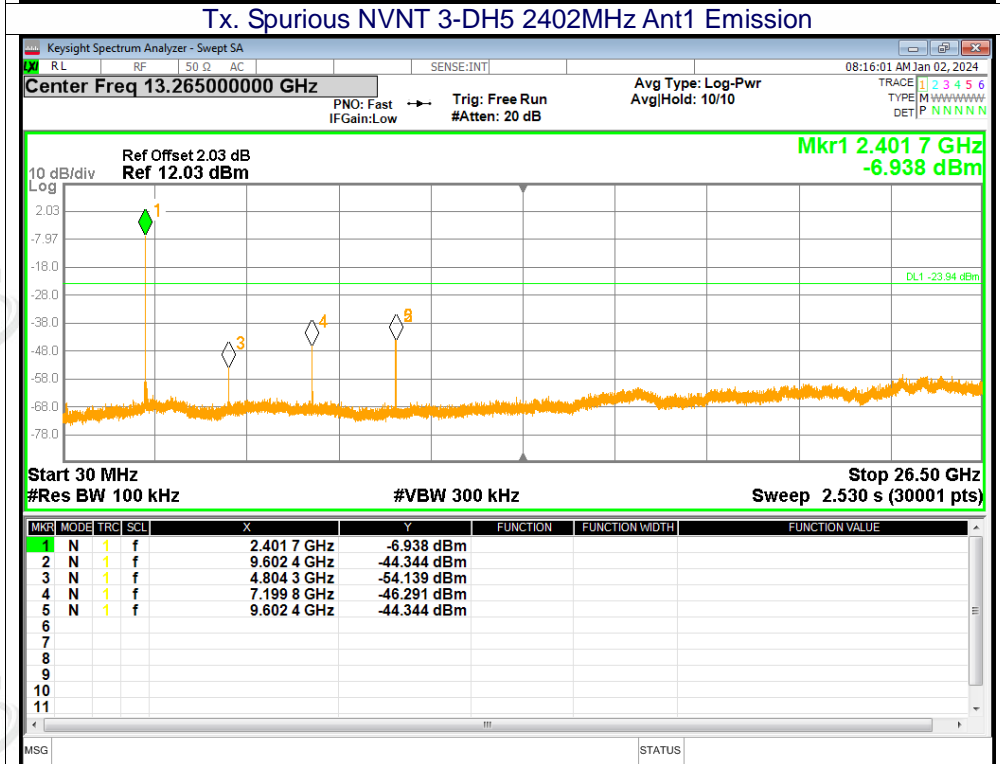
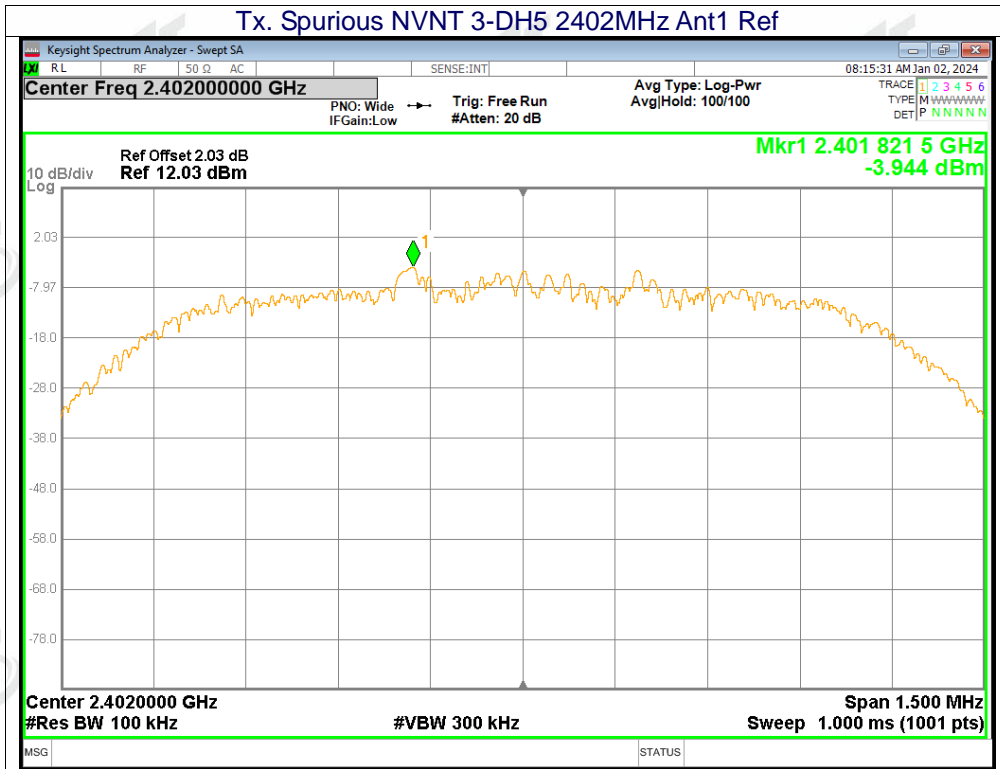

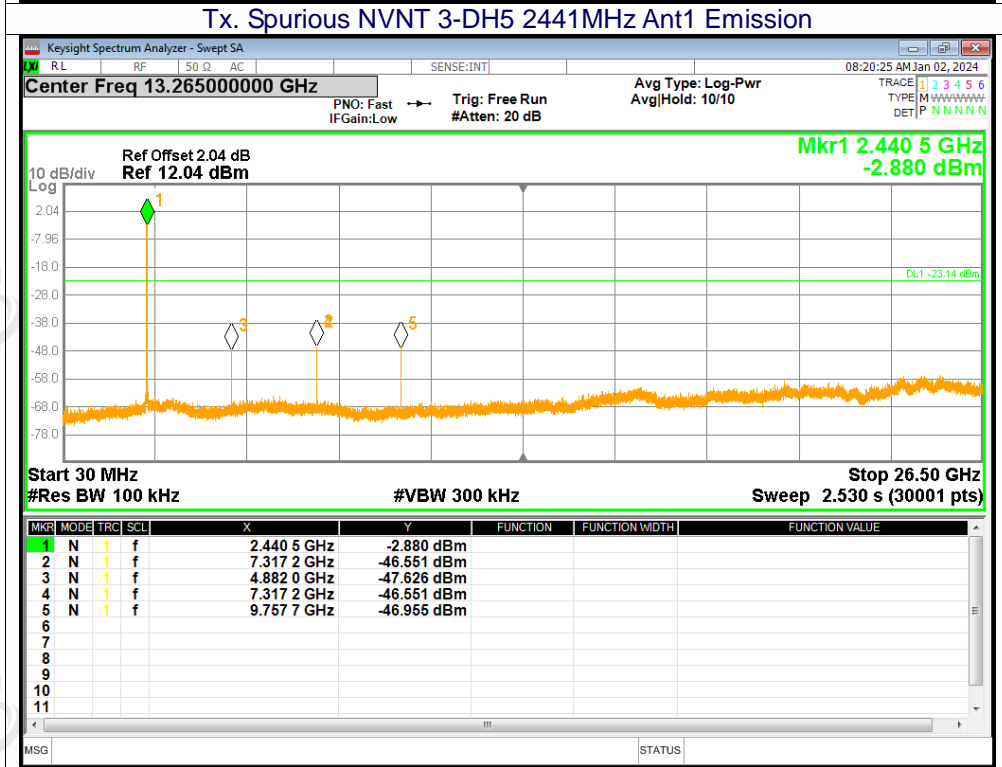
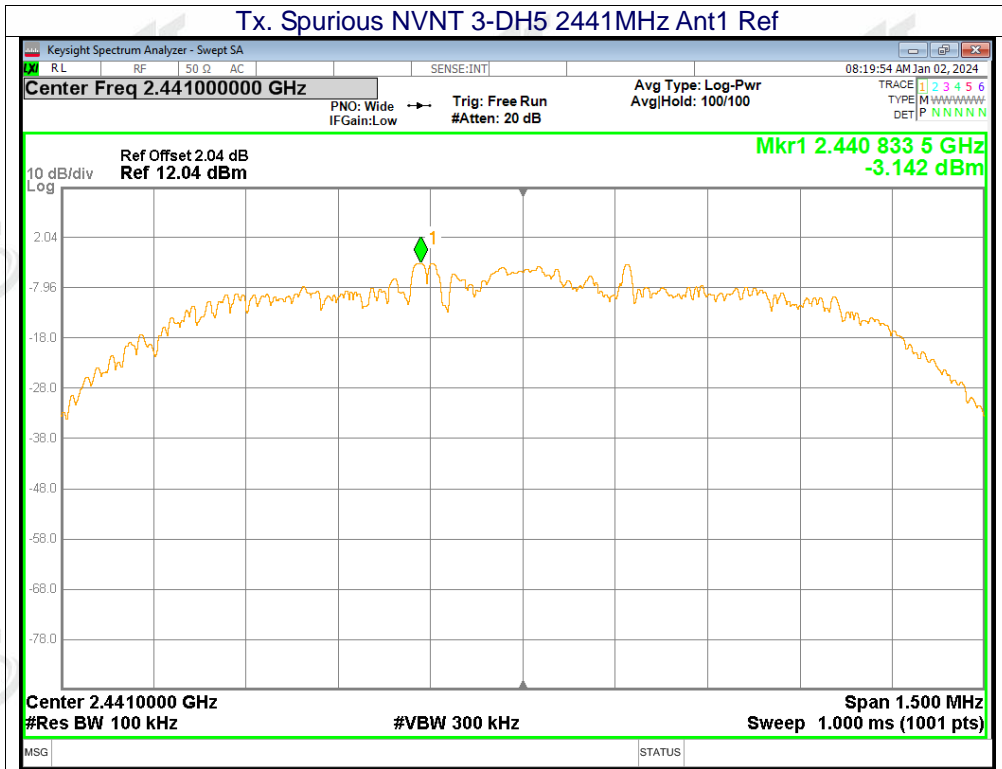

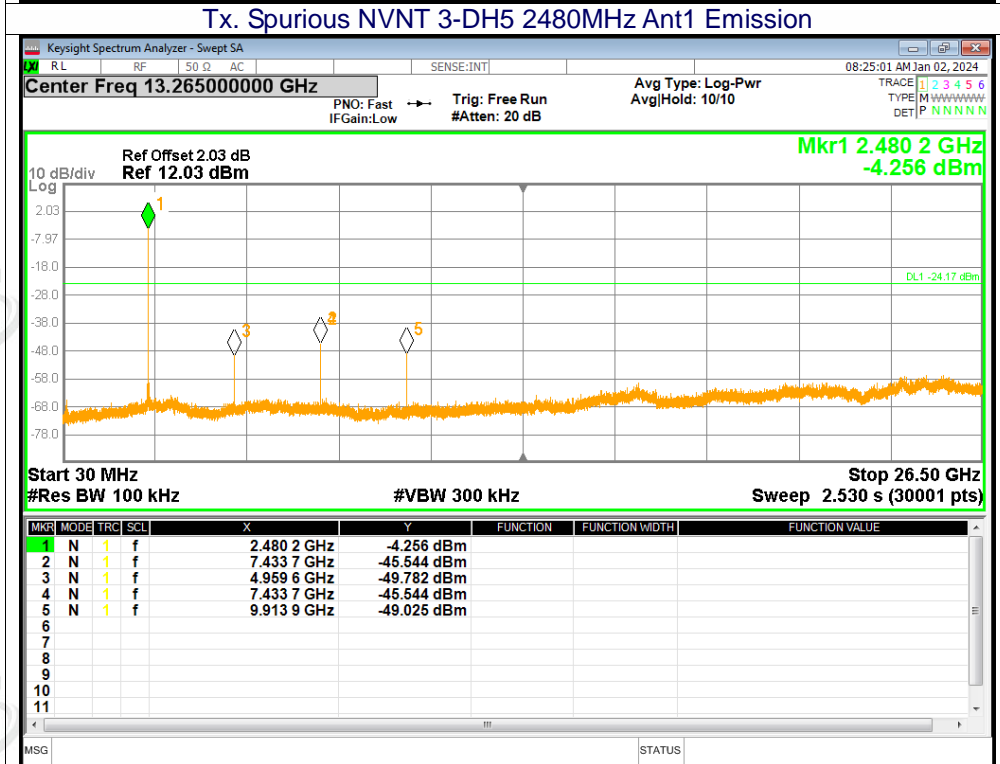
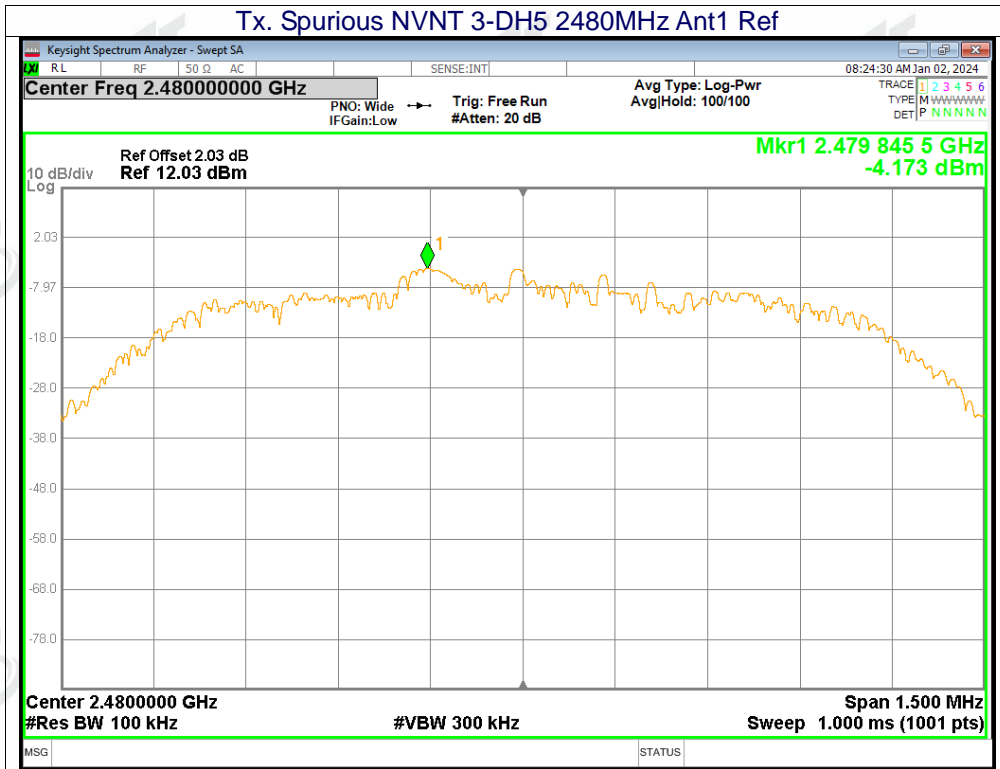



14. Test Setup Photo

Reference to the appendix I for details.

15. EUT Constructional Details

Reference to the appendix II for details.

***** END OF REPORT *****