

TEST REPORT

Report No.: SHE23020075-02AE

Date: 2023-03-13

Page 1 of 47

Applicant : DewertOkin Technology Group Co., Ltd.
Address of Applicant : Room 247, Floor 6, Jiaxing Photovoltaic Science and Innovation Park, 1288 Kanghe Road Xiuzhou District, Jiaxing City, Zhejiang Province China

Product Name : REMOTE CONTROL
Brand Name : N/A
Model No. : RF61
Sample acquisition Method : Sent by Client
Sample No. : E23020075-02#02
E23020075-02#03
FCC ID : 2AVJ8-RF61
ISED Number : 25804-RF61

Standards : FCC CFR47 Part 15, Subpart C Section 15.249
RSS-Gen (Issue 5, Amd.2-Feb 2021)
RSS-210 (Issue 10, Amendment-Apr 2020)

Date of Receipt : 2023-02-23
Date of Test : 2023-02-24 ~ 2023-03-12
Date of Issue : 2023-03-13

Remark:

This report details the results of the testing carried out on one sample, the results contained in this report do not relate to other samples of the same product. The manufacturer should ensure that all products in series production are in conformity with the product sample detailed in this report.

Prepared by: Erik Yang
(Erik Yang)

Reviewed by: Jennifer Zhou
(Jennifer Zhou)

Approved by: Guoyou Chi
(Authorized signatory: Guoyou Chi)

TEST REPORT

Report No.: SHE23020075-02AE

Date: 2023-03-13

Page 2 of 47

Contents

1	GENERAL INFORMATION	3
1.1	TESTING LABORATORY.....	3
1.2	DETAILS OF APPLICATION	3
1.3	DETAILS OF EUT	3
1.4	TEST METHODOLOGY.....	5
1.5	TEST SUMMARY.....	5
2	TEST CONDITION	6
2.1	ENVIRONMENTAL CONDITIONS	6
2.2	EQUIPMENT LIST	6
2.3	MEASUREMENT UNCERTAINTY.....	6
3	TEST SET-UP AND OPERATION MODES.....	7
3.1	DETAILS OF TEST MODE	7
3.2	SPECIAL ACCESSORIES AND AUXILIARY EQUIPMENT.....	7
3.3	SUPPORT SOFTWARE.....	7
3.4	TEST SETUP DIAGRAM	8
4	TEST RESULTS	9
4.1	TRANSMITTER REQUIREMENT & TEST SUITES.....	9
4.1.1	<i>Antenna Requirement</i>	9
4.1.2	<i>Radiated Emission</i>	10
4.1.3	<i>Band Edge</i>	35
4.1.4	<i>20dB Bandwidth and 99% Bandwidth</i>	39
5	APPENDIXES	42
5.1	PHOTOGRAPHS OF THE SAMPLE.....	42
5.2	SET-UP FOR SPURIOUS EMISSIONS BELOW 1GHZ.....	47
5.3	SET-UP FOR SPURIOUS EMISSIONS ABOVE 1GHZ.....	47

TEST REPORT

Report No.: SHE23020075-02AE

Date: 2023-03-13

Page 3 of 47

1 General Information

1.1 Testing Laboratory

ISED CAB identifier #	CN0081
Company Name	ICAS Testing Technology Service (Shanghai) Co., Ltd.
Address	No.1298 Pingan Rd, Minhang District, Shanghai, China
Telephone	0086 21-51682999
Fax	0086 21-54711112
Homepage	www.icasiso.com

1.2 Details of Application

Applicant Company Name	DewertOkin Technology Group Co., Ltd.
Address	Room 247, Floor 6, Jiaxing Photovoltaic Science and Innovation Park, 1288 Kanghe Road Xiuzhou District, Jiaxing City, Zhejiang Province China
Contact Person	Mia Ye
Telephone	+86-573-82281072
Email	Mia.Ye@refinedchina.com
Manufacturer Company Name	DewertOkin Technology Group Co., Ltd.
Address	Room 247, Floor 6, Jiaxing Photovoltaic Science and Innovation Park, 1288 Kanghe Road Xiuzhou District, Jiaxing City, Zhejiang Province China
Factory Company Name	DewertOkin Technology Group Co., Ltd.
Address	No.1507, Taoyuan Road, Gaozhao Street, Xiuzhou District, Jiaxing City, Zhejiang Province, China.

1.3 Details of EUT

Product Name	REMOTE CONTROL
Brand Name	N/A
Test Model No.	RF61
FCC ID	2AVJ8-RF61
ISED Number	25804-RF61
Operation Frequency	2403MHz ~ 2480MHz
Maximum Field Strength	81.99dBuV/m(peak)@3m
Number of Channels	78
Modulation Type	GFSK
Antenna Type	PCB Antenna
Antenna Gain	1.225dBi
Extreme Temperature Range	-10°C ~ +40°C
Test Voltage	DC 3V supply by battery(2*AAA battery)
Hardware Version	R6.210.00.2422AA

TEST REPORT

Report No.: SHE23020075-02AE

Date: 2023-03-13

Page 4 of 47

Software Version	V1.0
Test SW Version	BL410_R; BL410_E
RF power setting in TEST SW	Enter the fixed frequency mode by pressing the key_Default power

Note:

1. The above information was declared by the manufacture.
2. For more details, please refer to the User's manual of the EUT.

Channel List

Channel	Frequency	Channel	Frequency	Channel	Frequency
1	2.403GHz	28	2.430GHz	55	2.457GHz
2	2.404GHz	29	2.431GHz	56	2.458GHz
3	2.405GHz	30	2.432GHz	57	2.459GHz
4	2.406GHz	31	2.433GHz	58	2.460GHz
5	2.407GHz	32	2.434GHz	59	2.461GHz
6	2.408GHz	33	2.435GHz	60	2.462GHz
7	2.409GHz	34	2.436GHz	61	2.463GHz
8	2.410GHz	35	2.437GHz	62	2.464GHz
9	2.411GHz	36	2.438GHz	63	2.465GHz
10	2.412GHz	37	2.439GHz	64	2.466GHz
11	2.413GHz	38	2.440GHz	65	2.467GHz
12	2.414GHz	39	2.441GHz	66	2.468GHz
13	2.415GHz	40	2.442GHz	67	2.469GHz
14	2.416GHz	41	2.443GHz	68	2.470GHz
15	2.417GHz	42	2.444GHz	69	2.471GHz
16	2.418GHz	43	2.445GHz	70	2.472GHz
17	2.419GHz	44	2.446GHz	71	2.473GHz
18	2.420GHz	45	2.447GHz	72	2.474GHz
19	2.421GHz	46	2.448GHz	73	2.475GHz
20	2.422GHz	47	2.449GHz	74	2.476GHz
21	2.423GHz	48	2.450GHz	75	2.477GHz
22	2.424GHz	49	2.451GHz	76	2.478GHz
23	2.425GHz	50	2.452GHz	77	2.479GHz
24	2.426GHz	51	2.453GHz	78	2.480GHz
25	2.427GHz	52	2.454GHz		
26	2.428GHz	53	2.455GHz		
27	2.429GHz	54	2.456GHz		

TEST REPORT

Report No.: SHE23020075-02AE

Date: 2023-03-13

Page 5 of 47

1.4 Test Methodology

47 CFR Part 15, Subpart C	Telecommunication-Radio Frequency Devices-Intentional Radiators
RSS-Gen (Issue 5, Amd.2-Feb 2021)	General Requirements for Compliance of Radio Apparatus
RSS-210 (Issue 10, Amendment-Apr 2020)	Licence-Exempt Radio Apparatus: Category I Equipment
ANSI C63.10-2013	American National Standard for Testing Unlicensed Wireless Devices

Note(s):

All test items were verified and recorded according to the standards and without any addition/deviation/exclusion during the test.

1.5 Test Summary

Test Item	FCC Rules	ISED Rules	Result
Antenna Requirement	Part 15.203	RSS-GEN 6.8	PASS
Radiated Emission	FCC Part 15.249(a),15.209	RSS-210 B.10(a) RSS-GEN 8.9	PASS
Band Edge	FCC Part 15.249(d),15.209	RSS-210 B.10(b) RSS-GEN 8.10	PASS
20dB Bandwidth and 99% Bandwidth	FCC Part 15.215(c)	RSS-GEN 6.7	PASS
Conducted Emission on AC Mains	FCC Part 15.207(a)	RSS-Gen 8.8	N/A ^{note}

Note(s): The EUT is powered by battery (2*AAA battery)

TEST REPORT

Report No.: SHE23020075-02AE

Date: 2023-03-13

Page 6 of 47

2 Test Condition

2.1 Environmental conditions

Temperature (°C)	18-25
Humidity (%RH)	40-65
Barometric Pressure (mbar)	960-1060

2.2 Equipment List

Name of Equipment	Manufacturer	Model	Serial No.	Cal. Date	Cal. Due
Spectrum Analyzer	Keysight	N9020B	MY59260184	2022-08-02	2023-08-01
Spectrum Analyzer	Rohde & Schwarz	FSV40N	101450	2022-06-10	2023-06-09
Signal Generator	Rohde & Schwarz	SMR27	100184	2022-08-02	2023-08-01
EMI Test Receiver	Rohde & Schwarz	ESR 7	101911	2022-06-10	2023-06-09
Broadband Antenna	SCHWARZBECK	VULB9163	9163-1037	2021-06-08	2023-06-07
Horn Antenna	SCHWARZBECK	BBHA9120D	9120D-1775	2021-06-08	2023-06-07
Loop Antenna	SCHWARZBECK	FMZB 1513	/	2022-06-10	2023-06-09
Broadband Preamplifier	SCHWARZBECK	BBV 9718	346	2022-06-10	2023-06-09
EMC chamber 9*6*6 (L*W*H)	CHANGNING	966	N/A	2022-06-10	2023-06-09
Test Software	BL	BL410_E	Version:1.0.0.117	N/A	N/A
Test Software	BL	BL410_R	Version:2.1.1.409	N/A	N/A

2.3 Measurement Uncertainty

The uncertainty is calculated using the methods suggested in the "Guide to the Expression of Uncertainty in measurement" (GUM) published by CISPR and ANSI. The reported uncertainty of measurement $y \pm U$, where expanded uncertainty U is based on a standard uncertainty multiplied by a coverage factor of $k=2$, providing a level of confidence of approximately 95.45%.

Parameter	Uncertainty	
Antenna Port Conducted Emission	< 1GHz	± 1.5 dB
	> 1GHz	± 1.5 dB
Radiated Emission	9KHz – 30MHz	± 3.42 dB
	30 MHz – 1GHz	± 5.00 dB
	> 1GHz	± 4.88 dB
Occupied Channel Bandwidth	± 5 %	

TEST REPORT

Report No.: SHE23020075-02AE

Date: 2023-03-13

Page 7 of 47

3 Test Set-up and Operation Modes

3.1 Details of Test Mode

Enter the fixed frequency mode by pressing the key was control EUT work in continuous transmitter and receiver mode.

Select test channel as below:

Channel	Frequency
The lowest channel(CH1)	2403MHz
The middle channel(CH40)	2442MHz
The Highest channel(CH78)	2480MHz

The basic operation modes are:

- A. Transmitting
 - i. Low Channel
 - ii. Middle Channel
 - iii. High Channel

3.2 Special Accessories and Auxiliary Equipment

Description	Manufacturer	Model No.	Serial No.
N/A	N/A	N/A	N/A

3.3 Support Software

Description	Manufacturer	Software Name
N/A	N/A	N/A

TEST REPORT

Report No.: SHE23020075-02AE

Date: 2023-03-13

Page 8 of 47

3.4 Test Setup Diagram

Diagram of Measurement Configuration for Radiation Test

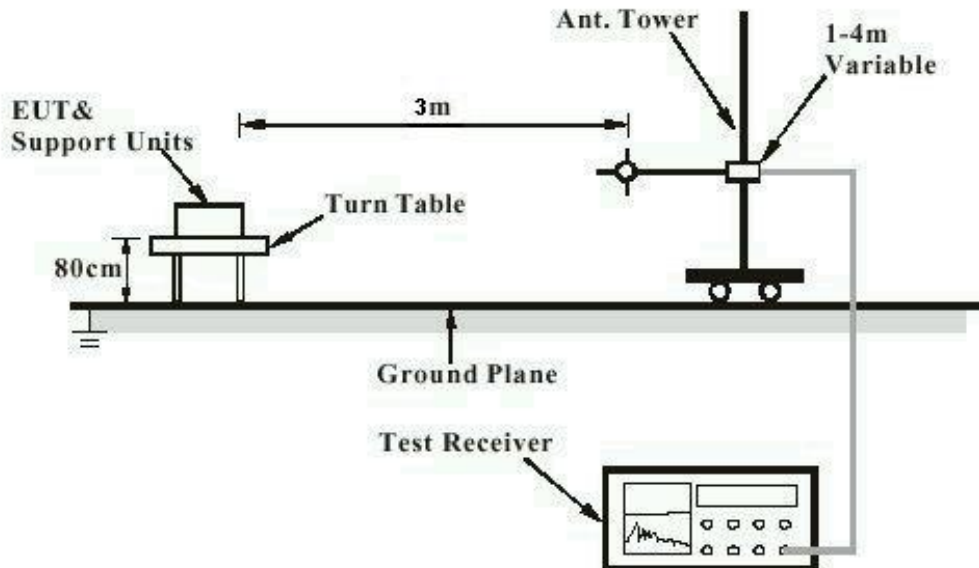

Note: Measurements above 1GHz are done with a table height of 1.5m. In addition, there is RF absorbing material on the floor of the test site for above 1GHz measurement.

Diagram of Measurement Configuration for Transmitter Test

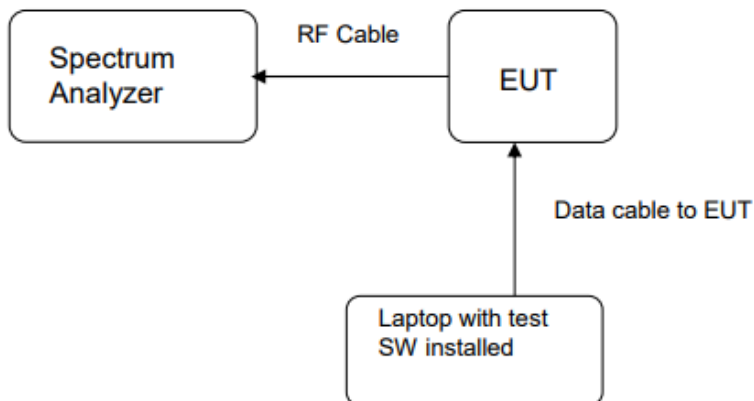

TEST REPORT

Report No.: SHE23020075-02AE

Date: 2023-03-13

Page 9 of 47

4 Test Results

4.1 Transmitter Requirement & Test Suites

4.1.1 Antenna Requirement

RESULT:

PASS

Test standard	: Part 15.203, RSS-GEN 6.8
Requirement	: An intentional radiator shall be designed to ensure that no antenna other than that furnished by the responsible party shall be used with the device. The use of a permanently attached antenna or of an antenna that uses a unique coupling to the intentional radiator shall be considered sufficient to comply with the provisions of this section. The manufacturer may design the unit so that a broken antenna can be replaced by the user, but the use of a standard antenna jack or electrical connector is prohibited.

According to the manufacturer declaration, the EUT has an antenna with a directional gain of 1.225dBi. The antenna is pcb antenna with no possibility of replacement with a non-approved antenna by the end-user.

Therefore, the EUT is considered to comply with this provision.

TEST REPORT

Report No.: SHE23020075-02AE

Date: 2023-03-13

Page 10 of 47

4.1.2 Radiated Emission

RESULT:

PASS

Test standard : FCC Part 15.249(a), 15.209
RSS-210 B.10(a), RSS-GEN 8.9

Requirement : ANSI C63.10-2013

Kind of test site : 3m Semi-Anechoic Chamber

Test setup

Test Channel : Low/Middle/High

Operation Mode : A.i/ii/iii

Ambient temperature : 22.5°C

Relative humidity : 48%

Notes

1. For 9 kHz ~ 30 MHz, the amplitude of spurious emissions that are attenuated by more than 20dB below the permissible. The value has no need to be reported.
2. The spurious above 18GHz is noise only and 20dB below the limit. The value has no need to be reported.
3. The EUT was pretested with 3 orientations placed on the table for the radiated emission measurement –X, Y, and Z-plane. The X-plane results were found as the worst case and were shown in this report.

TEST REPORT

Report No.: SHE23020075-02AE

Date: 2023-03-13

Page 11 of 47

Figure 1: Test plots of Field strength of fundamental, 2403MHz, Horizontal polarization

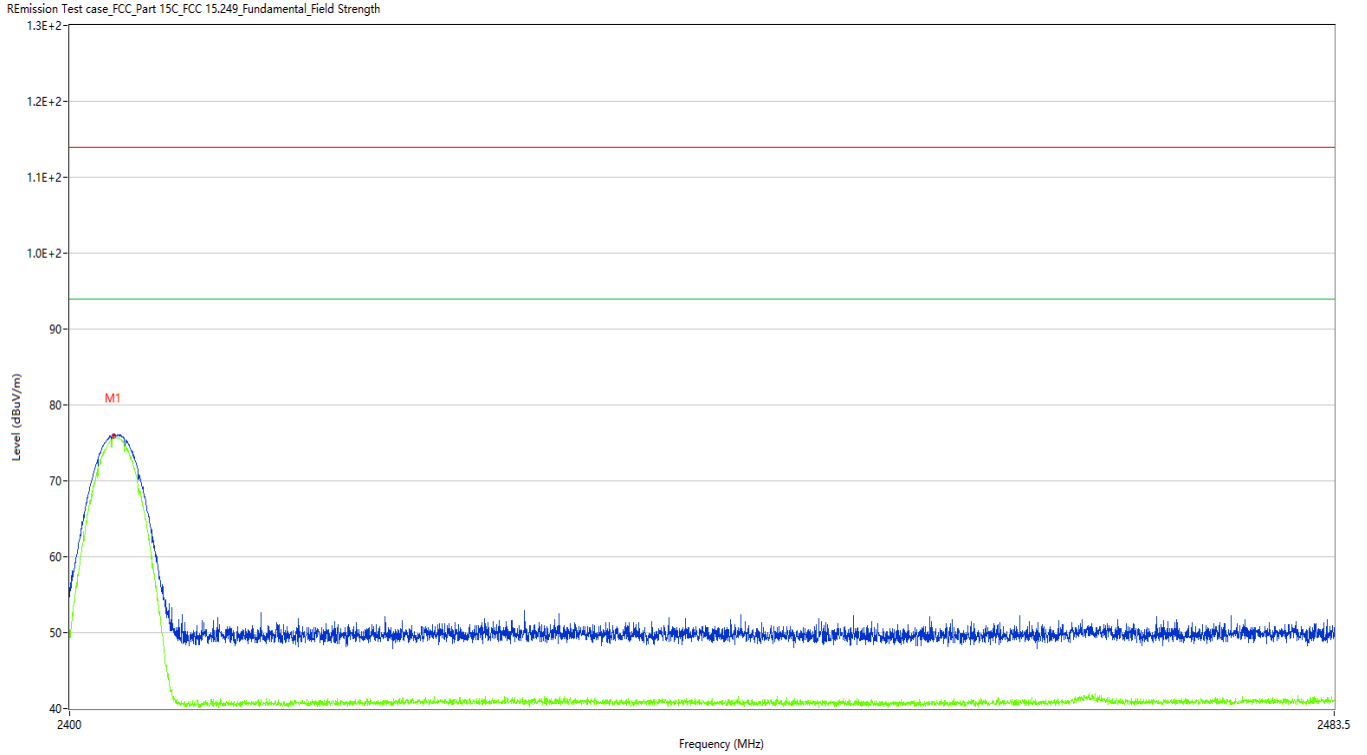

No.	Frequency (MHz)	Results (dBuV/m)	Factor (dB)	Limit (dBuV/m)	Margin (dB)	Detector	Table (Degree)	Height (cm)	Antenna	Verdict
1	2402.881	75.96	-9.82	114.0	38.04	Peak	251.10	100	Horizontal	Pass
1**	2402.881	75.58	-9.82	94.0	18.42	AV	251.10	100	Horizontal	Pass

TEST REPORT

Report No.: SHE23020075-02AE

Date: 2023-03-13

Page 12 of 47

Figure 2: Test plots of Field strength of fundamental, 2403MHz, Vertical polarization

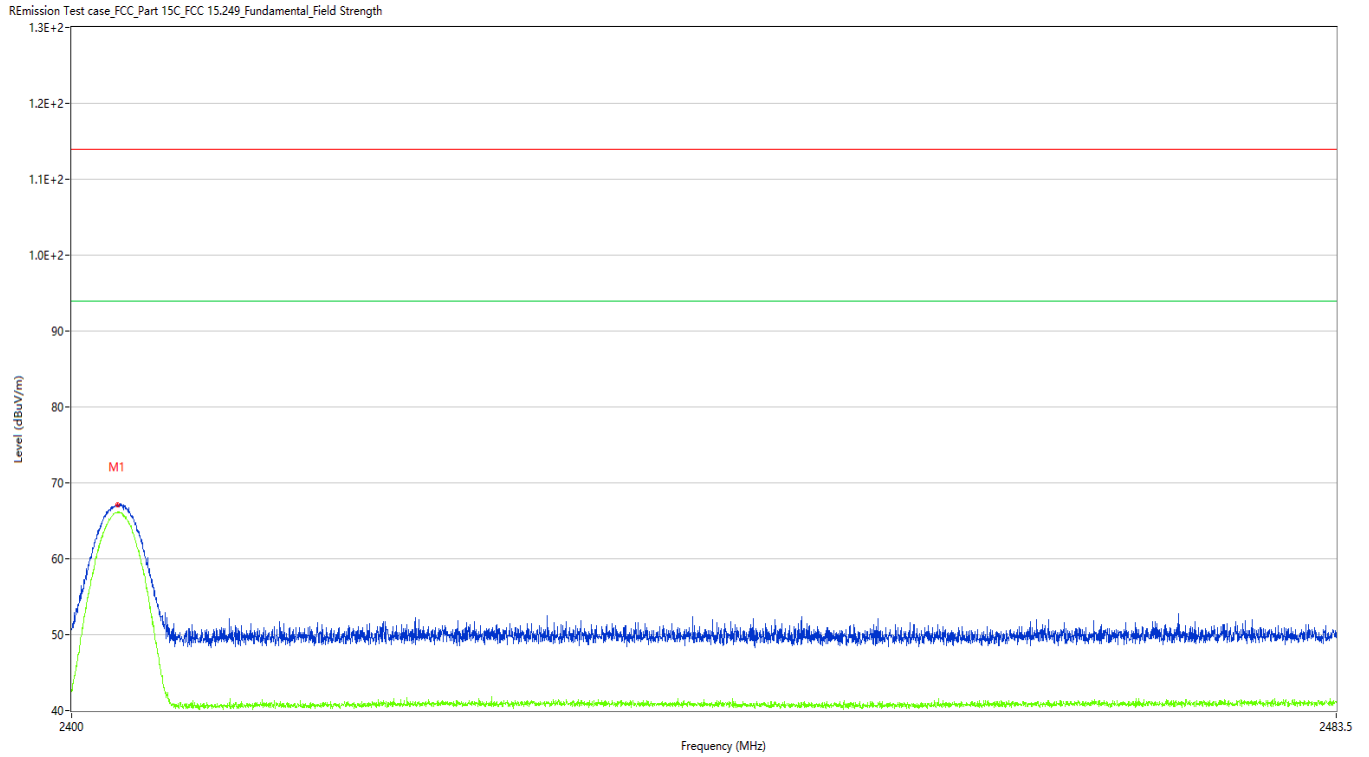

No.	Frequency (MHz)	Results (dBuV/m)	Factor (dB)	Limit (dBuV/m)	Margin (dB)	Detector	Table (Degree)	Height (cm)	Antenna	Verdict
1	2402.985	67.09	-9.82	114.0	46.91	Peak	172.20	100	Vertical	Pass
1**	2402.985	66.16	-9.82	94.0	27.84	AV	172.20	100	Vertical	Pass

TEST REPORT

Report No.: SHE23020075-02AE

Date: 2023-03-13

Page 13 of 47

Figure 3: Test plots of Field strength of fundamental, 2442MHz, Horizontal polarization

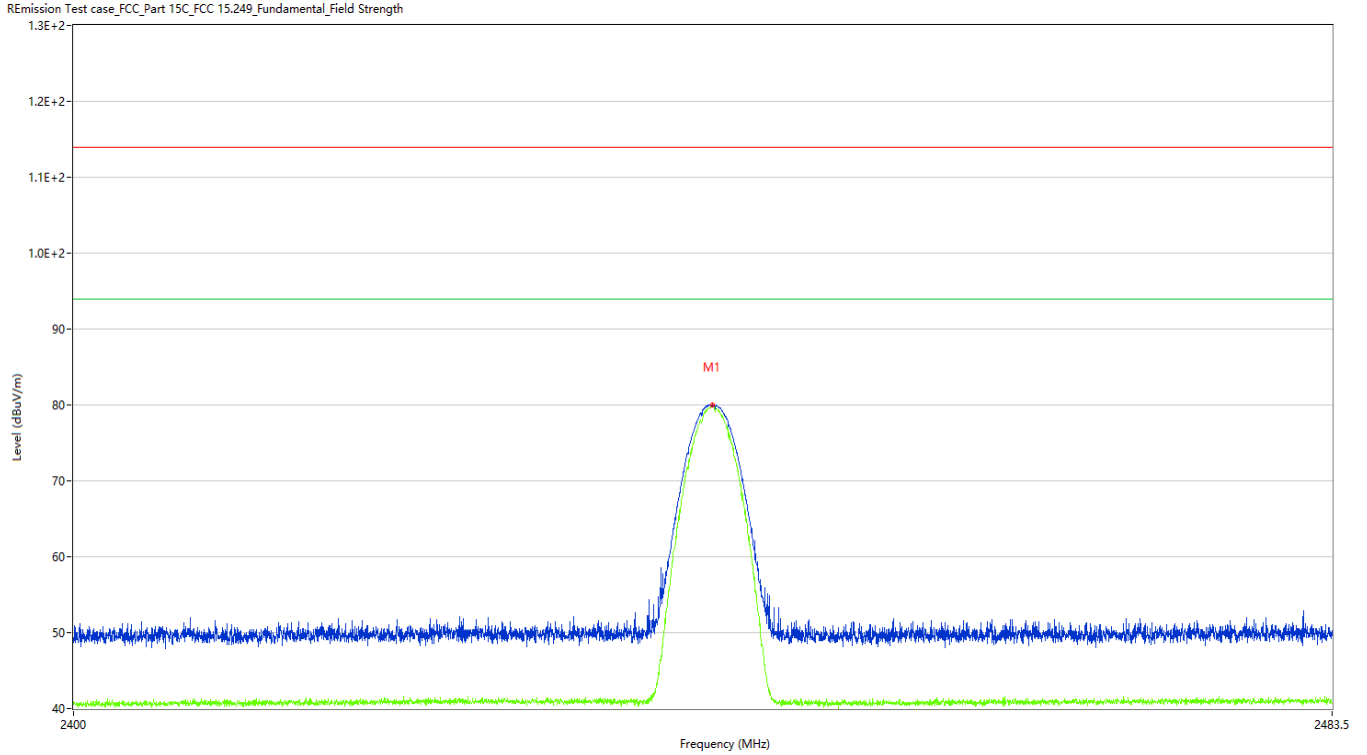

No.	Frequency (MHz)	Results (dBuV/m)	Factor (dB)	Limit (dBuV/m)	Margin (dB)	Detector	Table (Degree)	Height (cm)	Antenna	Verdict
1	2442.063	80.03	-9.62	114.0	33.97	Peak	209.80	100	Horizontal	Pass
1**	2442.063	79.72	-9.62	94.0	14.28	AV	209.80	100	Horizontal	Pass

TEST REPORT

Report No.: SHE23020075-02AE

Date: 2023-03-13

Page 14 of 47

Figure 4: Test plots of Field strength of fundamental, 2442MHz, Vertical polarization

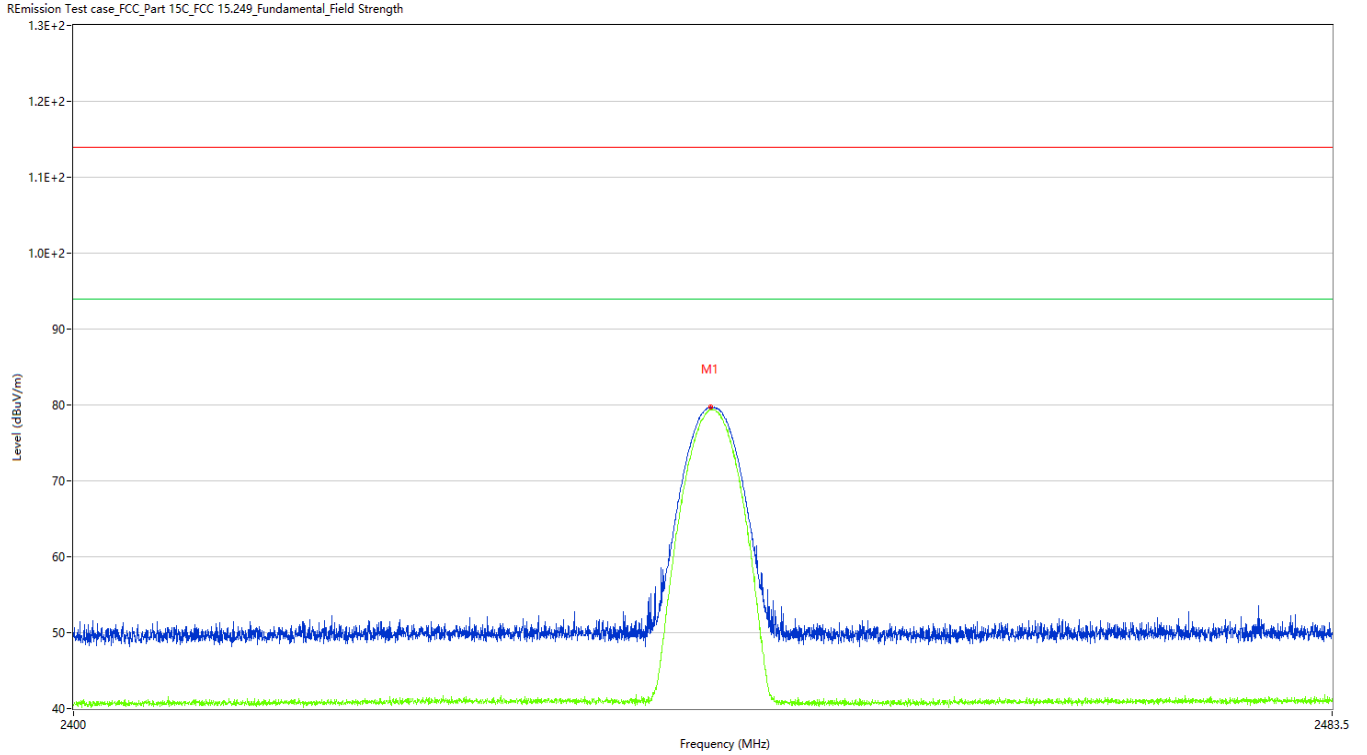

No.	Frequency (MHz)	Results (dBuV/m)	Factor (dB)	Limit (dBuV/m)	Margin (dB)	Detector	Table (Degree)	Height (cm)	Antenna	Verdict
1	2441.938	79.73	-9.61	114.0	34.27	Peak	160.70	100	Vertical	Pass
1**	2441.938	79.39	-9.61	94.0	14.61	AV	160.70	100	Vertical	Pass

TEST REPORT

Report No.: SHE23020075-02AE

Date: 2023-03-13

Page 15 of 47

Figure 5: Test plots of Field strength of fundamental, 2480MHz, Horizontal polarization

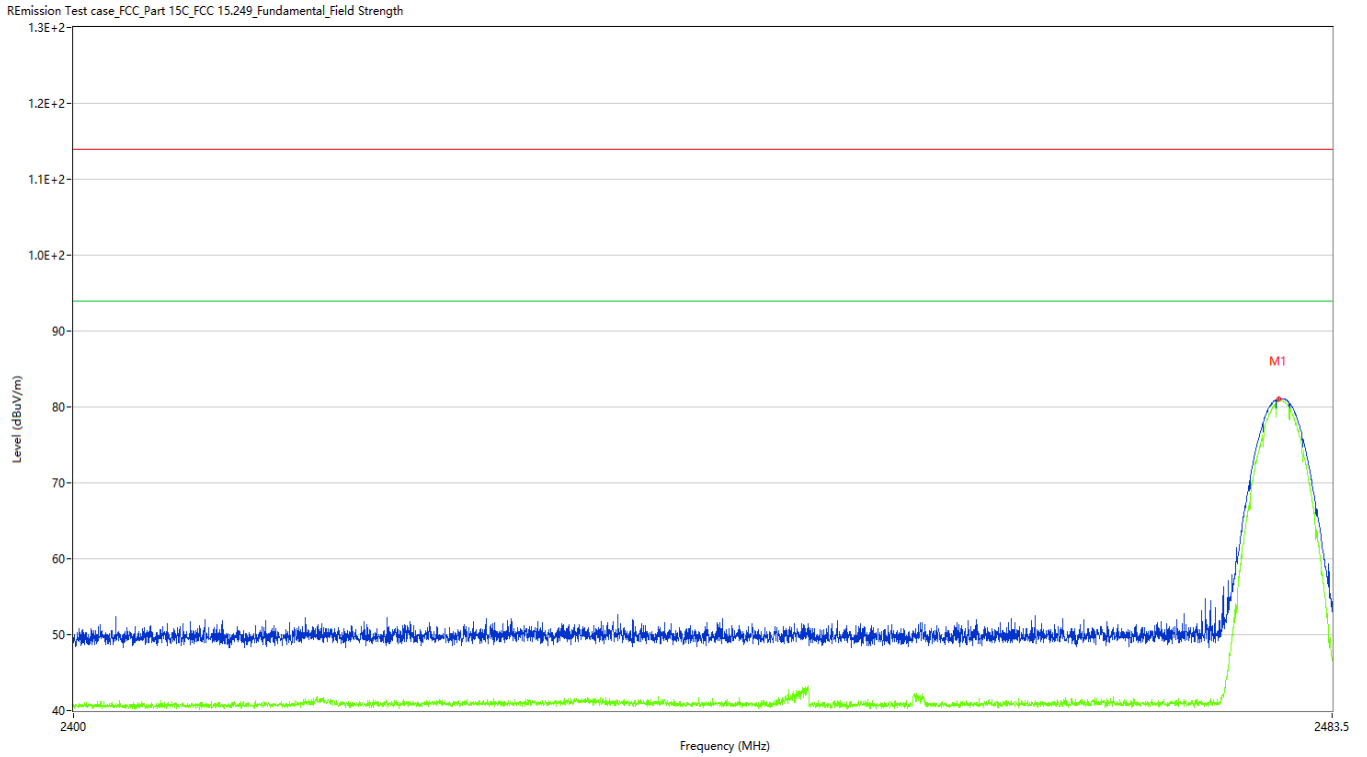

No.	Frequency (MHz)	Results (dBuV/m)	Factor (dB)	Limit (dBuV/m)	Margin (dB)	Detector	Table (Degree)	Height (cm)	Antenna	Verdict
1	2479.889	81.09	-9.48	114.0	32.91	Peak	234.10	100	Horizontal	Pass
1**	2479.889	80.75	-9.48	94.0	13.25	AV	234.10	100	Horizontal	Pass

TEST REPORT

Report No.: SHE23020075-02AE

Date: 2023-03-13

Page 16 of 47

Figure 6: Test plots of Field strength of fundamental, 2480MHz, Vertical polarization

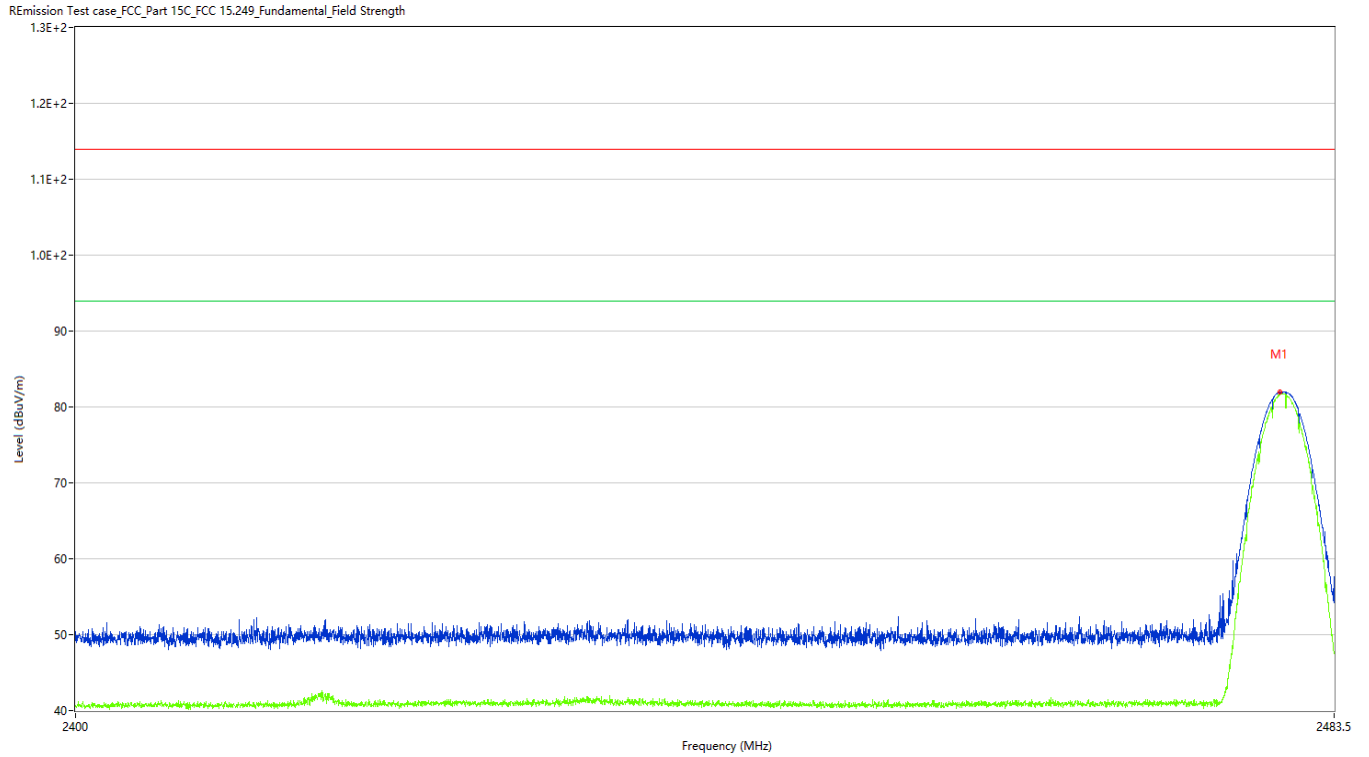

No.	Frequency (MHz)	Results (dBuV/m)	Factor (dB)	Limit (dBuV/m)	Margin (dB)	Detector	Table (Degree)	Height (cm)	Antenna	Verdict
1	2479.868	81.99	-9.48	114.0	32.01	Peak	186.70	100	Vertical	Pass
1**	2479.868	81.63	-9.48	94.0	12.37	AV	186.70	100	Vertical	Pass

TEST REPORT

Report No.: SHE23020075-02AE

Date: 2023-03-13

Page 17 of 47

Figure 7: Test plots of Field strength of harmonics, 2403MHz, 30MHz-1GHz, Horizontal polarization

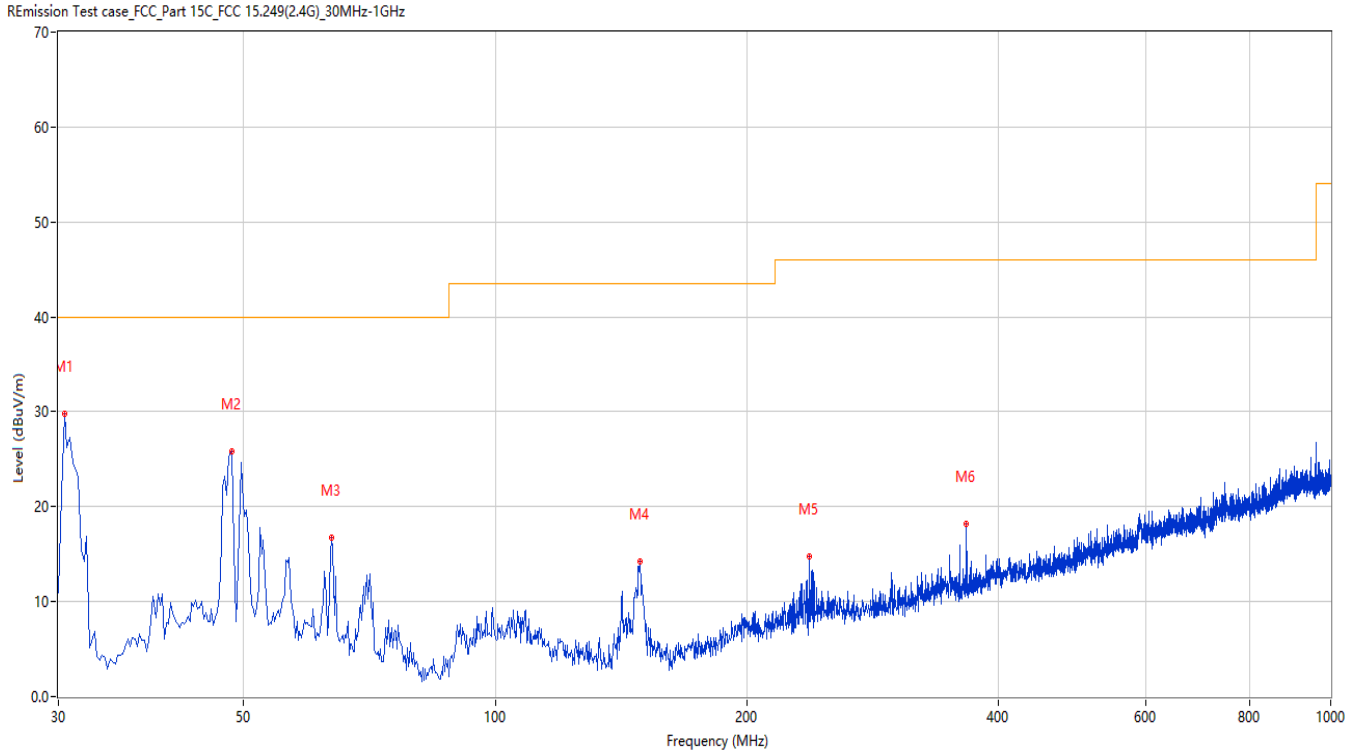

No.	Frequency (MHz)	Results (dBuV/m)	Factor (dB)	Limit (dBuV/m)	Margin (dB)	Detector	Table (Degree)	Height (cm)	Antenna	Verdict
1	30.485	29.86	-29.66	40.0	10.14	Peak	108.90	100	Horizontal	Pass
2	48.425	25.86	-25.08	40.0	14.14	Peak	72.70	100	Horizontal	Pass
3	63.699	16.73	-27.26	40.0	23.27	Peak	186.10	100	Horizontal	Pass
4	149.038	14.19	-29.97	43.5	29.31	Peak	128.90	100	Horizontal	Pass
5	237.771	14.81	-25.36	46.0	31.19	Peak	91.90	100	Horizontal	Pass
6	366.506	18.19	-21.94	46.0	27.81	Peak	54.50	100	Horizontal	Pass

TEST REPORT

Report No.: SHE23020075-02AE

Date: 2023-03-13

Page 18 of 47

Figure 8: Test plots of Field strength of harmonics, 2403MHz, 30MHz-1GHz, Vertical polarization

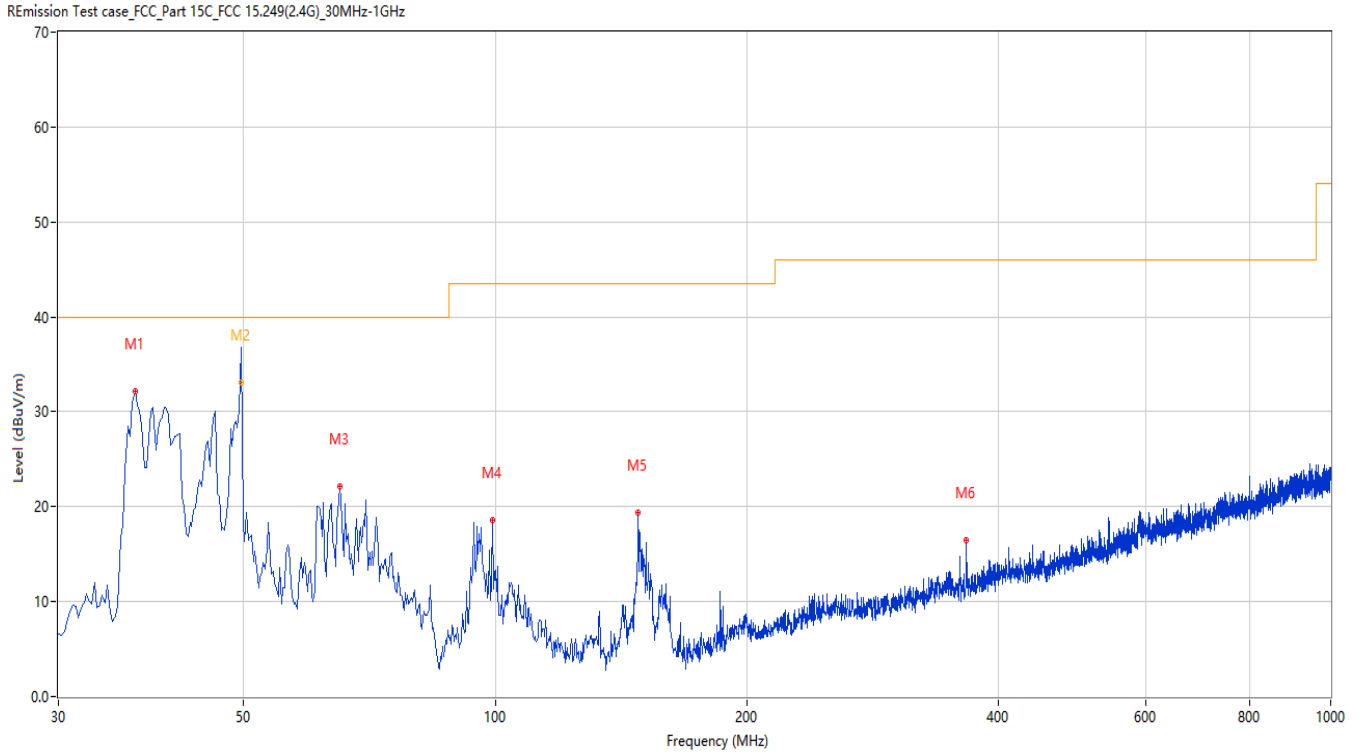

No.	Frequency (MHz)	Results (dBuV/m)	Factor (dB)	Limit (dBuV/m)	Margin (dB)	Detector	Table (Degree)	Height (cm)	Antenna	Verdict
1	37.031	32.23	-27.37	40.0	7.77	Peak	117.00	100	Vertical	Pass
2	49.716	38.30	-25.03	40.0	1.70	Peak	336.90	102	Vertical	Pass
2*	49.716	33.15	-25.03	40.0	6.85	QP	336.90	102	Vertical	Pass
3	65.154	22.14	-27.70	40.0	17.86	Peak	190.50	100	Vertical	Pass
4	99.338	18.58	-26.69	43.5	24.92	Peak	333.20	100	Vertical	Pass
5	148.310	19.39	-29.98	43.5	24.11	Peak	113.60	100	Vertical	Pass
6	366.506	16.51	-21.94	46.0	29.49	Peak	342.50	100	Vertical	Pass

TEST REPORT

Report No.: SHE23020075-02AE

Date: 2023-03-13

Page 19 of 47

Figure 9: Test plots of Field strength of harmonics, 2403MHz, 1GHz-7GHz, Horizontal polarization

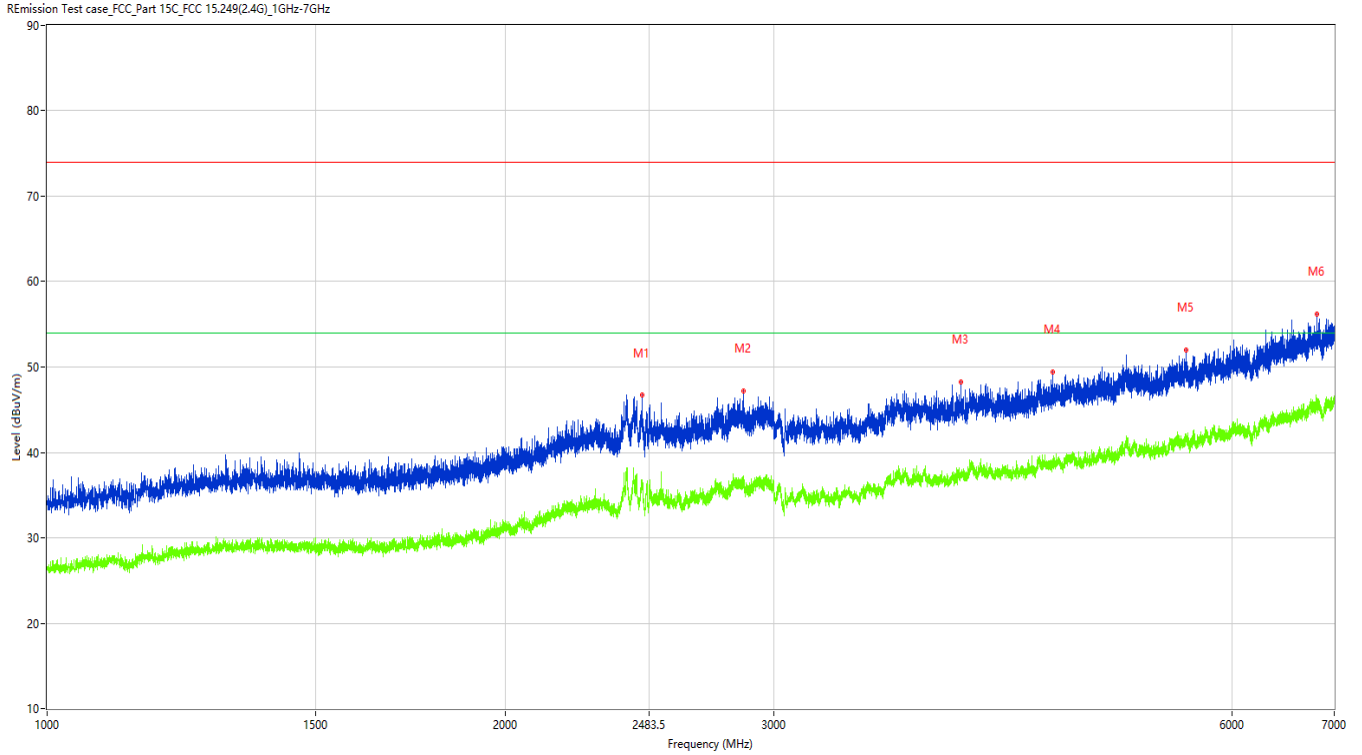

No.	Frequency (MHz)	Results (dBuV/m)	Factor (dB)	Limit (dBuV/m)	Margin (dB)	Detector	Table (Degree)	Height (cm)	Antenna	Verdict
1	2458.250	46.69	-5.49	74.0	27.31	Peak	41.30	100	Horizontal	Pass
1**	2458.250	36.24	-5.49	54.0	17.76	AV	41.30	100	Horizontal	Pass
2	2865.250	47.24	-3.80	74.0	26.76	Peak	13.20	100	Horizontal	Pass
2**	2865.250	37.07	-3.80	54.0	16.93	AV	13.20	100	Horizontal	Pass
3	3981.500	48.27	-1.30	74.0	25.73	Peak	0.00	100	Horizontal	Pass
3**	3981.500	37.09	-1.30	54.0	16.91	AV	0.00	100	Horizontal	Pass
4	4576.000	49.39	-0.71	74.0	24.61	Peak	225.40	100	Horizontal	Pass
4**	4576.000	38.90	-0.71	54.0	15.10	AV	225.40	100	Horizontal	Pass
5	5599.000	52.03	1.59	74.0	21.97	Peak	169.50	100	Horizontal	Pass
5**	5599.000	41.87	1.59	54.0	12.13	AV	169.50	100	Horizontal	Pass
6	6820.000	56.21	5.11	74.0	17.79	Peak	62.90	100	Horizontal	Pass
6**	6820.000	45.73	5.11	54.0	8.27	AV	62.90	100	Horizontal	Pass

TEST REPORT

Report No.: SHE23020075-02AE

Date: 2023-03-13

Page 20 of 47

Figure 10: Test plots of Field strength of harmonics, 2403MHz, 1GHz-7GHz, Vertical polarization

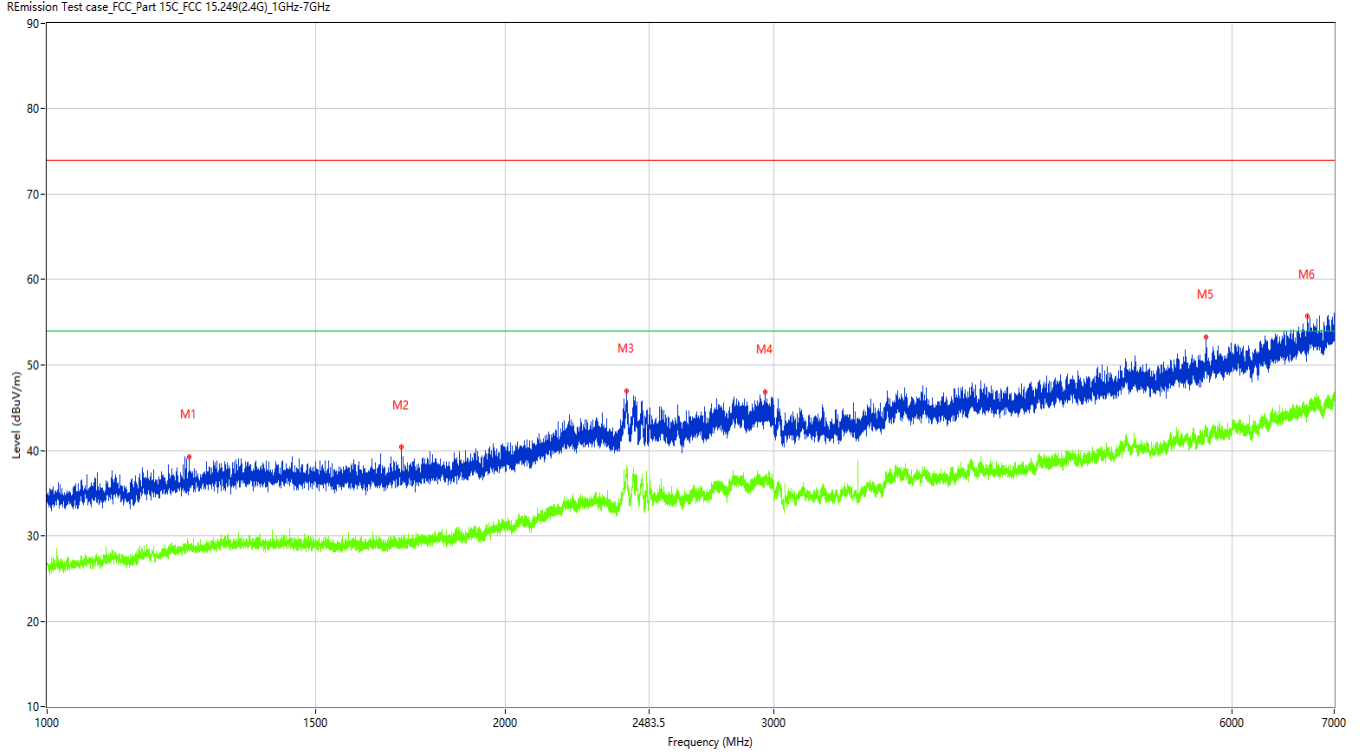

No.	Frequency (MHz)	Results (dBuV/m)	Factor (dB)	Limit (dBuV/m)	Margin (dB)	Detector	Table (Degree)	Height (cm)	Antenna	Verdict
1	1239.500	39.21	-13.19	74.0	34.79	Peak	230.90	100	Vertical	Pass
1**	1239.500	28.39	-13.19	54.0	25.61	AV	230.90	100	Vertical	Pass
2	1709.250	40.36	-12.78	74.0	33.64	Peak	204.00	100	Vertical	Pass
2**	1709.250	29.92	-12.78	54.0	24.08	AV	204.00	100	Vertical	Pass
3	2400.250	47.00	-4.41	74.0	27.00	Peak	0.50	100	Vertical	Pass
3**	2400.250	38.15	-4.41	54.0	15.85	AV	0.50	100	Vertical	Pass
4	2961.000	46.87	-3.41	74.0	27.13	Peak	21.10	100	Vertical	Pass
4**	2961.000	36.17	-3.41	54.0	17.83	AV	21.10	100	Vertical	Pass
5	5770.500	53.30	2.29	74.0	20.70	Peak	0.00	100	Vertical	Pass
5**	5770.500	41.74	2.29	54.0	12.26	AV	0.00	100	Vertical	Pass
6	6724.000	55.74	4.57	74.0	18.26	Peak	221.70	100	Vertical	Pass
6**	6724.000	44.77	4.57	54.0	9.23	AV	221.70	100	Vertical	Pass

TEST REPORT

Report No.: SHE23020075-02AE

Date: 2023-03-13

Page 21 of 47

Figure 11: Test plots of Field strength of harmonics, 2403MHz, 7GHz-18GHz, Horizontal polarization

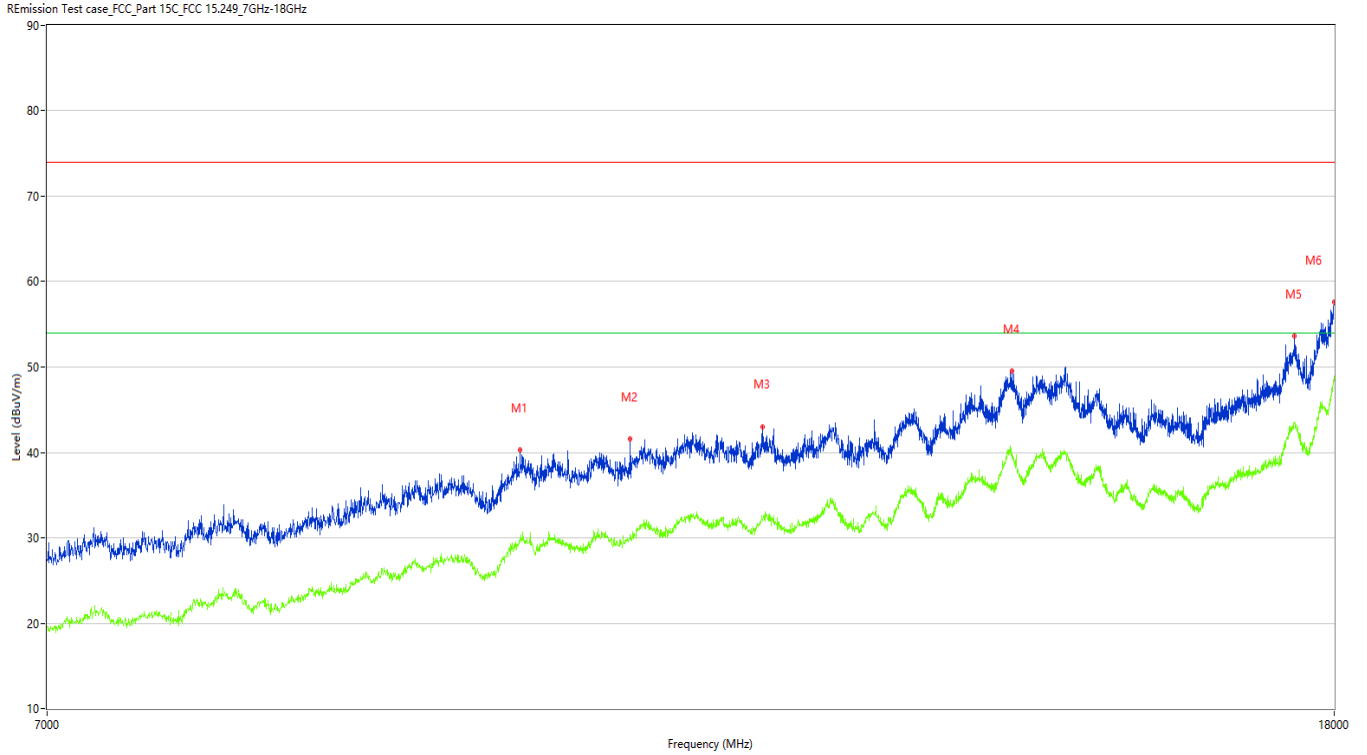

No.	Frequency (MHz)	Results (dBuV/m)	Factor (dB)	Limit (dBuV/m)	Margin (dB)	Detector	Table (Degree)	Height (cm)	Antenna	Verdict
1	9904.000	40.27	9.76	74.0	33.73	Peak	115.50	100	Horizontal	Pass
1**	9904.000	29.48	9.76	54.0	24.52	AV	115.50	100	Horizontal	Pass
2	10737.250	41.53	10.09	74.0	32.47	Peak	292.20	100	Horizontal	Pass
2**	10737.250	30.37	10.09	54.0	23.63	AV	292.20	100	Horizontal	Pass
3	11834.500	42.92	11.56	74.0	31.08	Peak	73.10	100	Horizontal	Pass
3**	11834.500	32.11	11.56	54.0	21.89	AV	73.10	100	Horizontal	Pass
4	14207.750	49.50	19.32	74.0	24.50	Peak	20.60	100	Horizontal	Pass
4**	14207.750	39.92	19.32	54.0	14.08	AV	20.60	100	Horizontal	Pass
5	17480.249	53.61	21.45	74.0	20.39	Peak	86.40	100	Horizontal	Pass
5**	17480.249	43.46	21.45	54.0	10.54	AV	86.40	100	Horizontal	Pass
6	17994.500	57.55	27.58	74.0	16.45	Peak	211.00	100	Horizontal	Pass
6**	17994.500	48.41	27.58	54.0	5.59	AV	211.00	100	Horizontal	Pass

TEST REPORT

Report No.: SHE23020075-02AE

Date: 2023-03-13

Page 22 of 47

Figure 12: Test plots of Field strength of harmonics, 2403MHz, 7GHz-18GHz, Vertical polarization

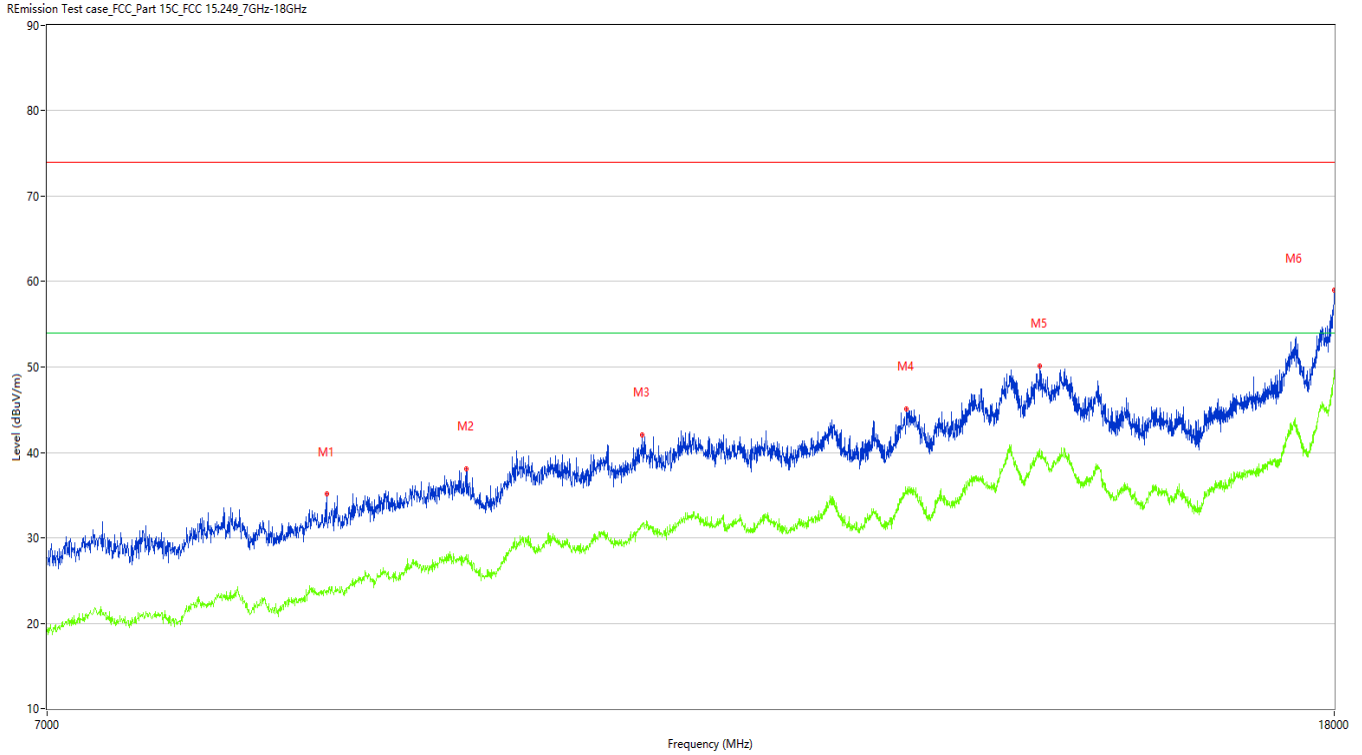

No.	Frequency (MHz)	Results (dBuV/m)	Factor (dB)	Limit (dBuV/m)	Margin (dB)	Detector	Table (Degree)	Height (cm)	Antenna	Verdict
1	8595.000	35.19	4.34	74.0	38.81	Peak	215.30	100	Vertical	Pass
1**	8595.000	23.33	4.34	54.0	30.67	AV	215.30	100	Vertical	Pass
2	9519.000	38.03	8.05	74.0	35.97	Peak	171.70	100	Vertical	Pass
2**	9519.000	27.42	8.05	54.0	26.58	AV	171.70	100	Vertical	Pass
3	10833.500	42.04	10.95	74.0	31.96	Peak	171.70	100	Vertical	Pass
3**	10833.500	31.70	10.95	54.0	22.30	AV	171.70	100	Vertical	Pass
4	13149.000	45.13	13.97	74.0	28.87	Peak	215.30	100	Vertical	Pass
4**	13149.000	35.48	13.97	54.0	18.52	AV	215.30	100	Vertical	Pass
5	14504.750	50.17	17.67	74.0	23.83	Peak	121.10	100	Vertical	Pass
5**	14504.750	40.06	17.67	54.0	13.94	AV	121.10	100	Vertical	Pass
6	17997.251	59.01	27.75	74.0	14.99	Peak	215.30	100	Vertical	Pass
6**	17997.251	49.61	27.75	54.0	4.39	AV	215.30	100	Vertical	Pass

TEST REPORT

Report No.: SHE23020075-02AE

Date: 2023-03-13

Page 23 of 47

Figure 13: Test plots of Field strength of harmonics, 2442MHz, 30MHz-1GHz, Horizontal polarization

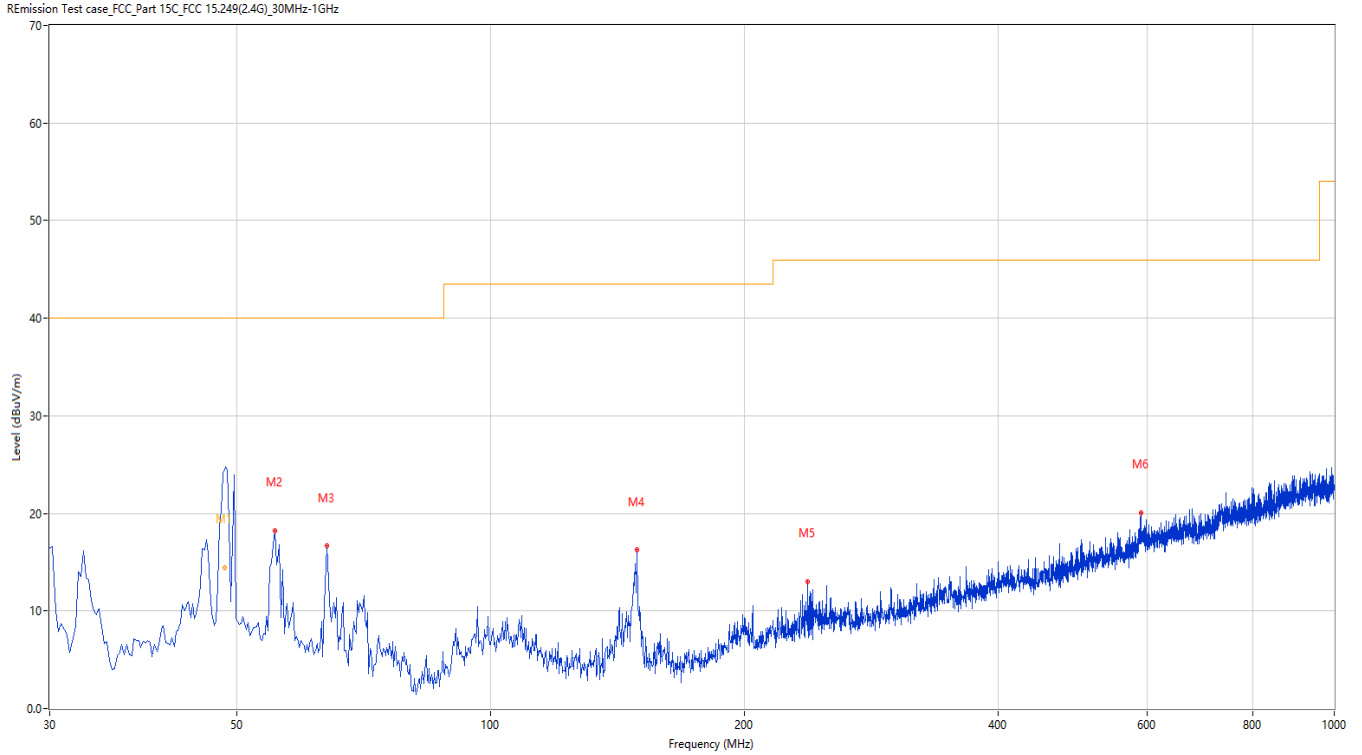

No.	Frequency (MHz)	Results (dBuV/m)	Factor (dB)	Limit (dBuV/m)	Margin (dB)	Detector	Table (Degree)	Height (cm)	Antenna	Verdict
1	48.357	26.34	-25.08	40.0	13.66	Peak	108.90	196	Horizontal	Pass
1*	48.357	14.39	-25.08	40.0	25.61	QP	108.90	196	Horizontal	Pass
2	55.456	18.22	-25.46	40.0	21.78	Peak	283.70	100	Horizontal	Pass
3	63.942	16.71	-27.34	40.0	23.29	Peak	254.90	100	Horizontal	Pass
4	149.038	16.23	-29.97	43.5	27.27	Peak	85.10	100	Horizontal	Pass
5	237.771	13.01	-25.36	46.0	32.99	Peak	69.80	100	Horizontal	Pass
6	589.550	20.03	-15.82	46.0	25.97	Peak	1.60	100	Horizontal	Pass

TEST REPORT

Report No.: SHE23020075-02AE

Date: 2023-03-13

Page 24 of 47

Figure 14: Test plots of Field strength of harmonics, 2442MHz, 30MHz-1GHz, Vertical polarization

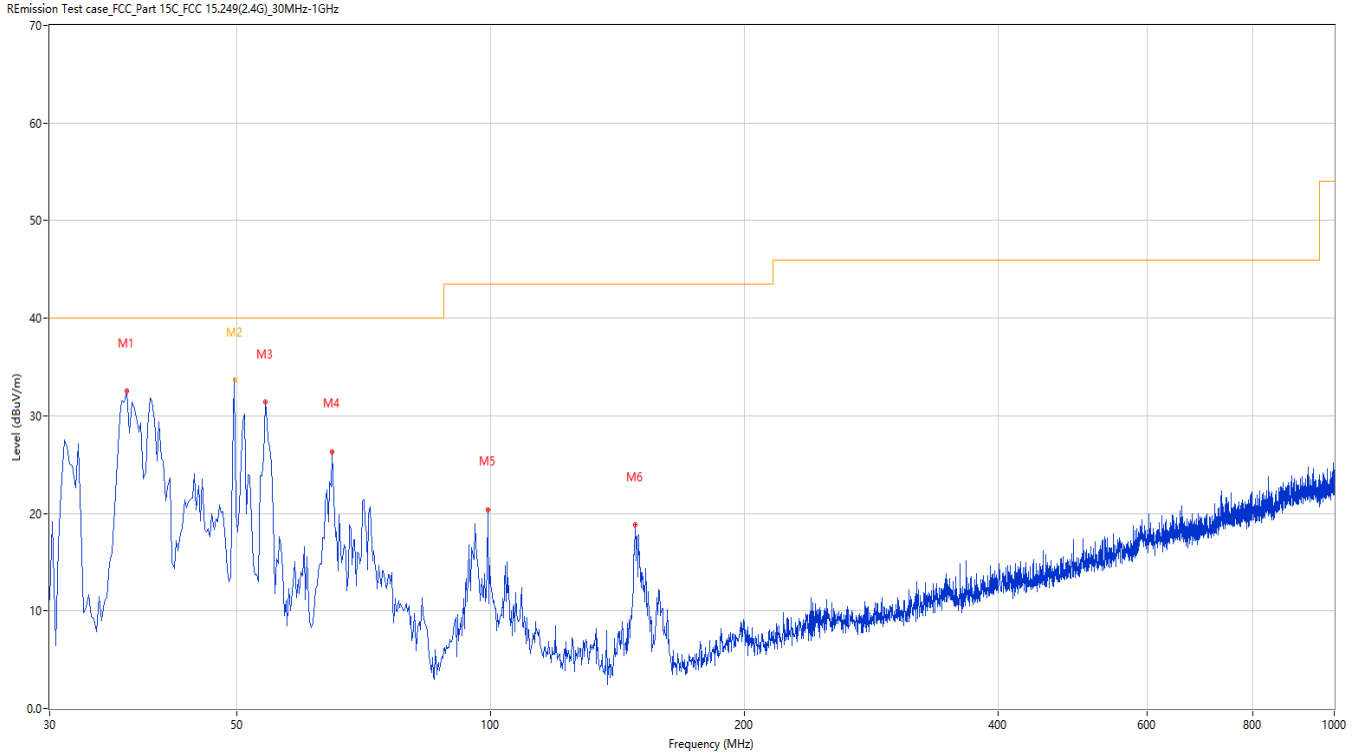

No.	Frequency (MHz)	Results (dBuV/m)	Factor (dB)	Limit (dBuV/m)	Margin (dB)	Detector	Table (Degree)	Height (cm)	Antenna	Verdict
1	37.031	32.49	-27.37	40.0	7.51	Peak	54.60	100	Vertical	Pass
2	49.720	39.31	-25.03	40.0	0.69	Peak	357.50	100	Vertical	Pass
2*	49.720	33.62	-25.03	40.0	6.38	QP	357.50	100	Vertical	Pass
3	54.002	31.41	-25.28	40.0	8.59	Peak	342.60	100	Vertical	Pass
4	64.911	26.29	-27.62	40.0	13.71	Peak	37.60	100	Vertical	Pass
5	99.338	20.38	-26.69	43.5	23.12	Peak	62.00	100	Vertical	Pass
6	148.310	18.79	-29.98	43.5	24.71	Peak	151.80	100	Vertical	Pass

TEST REPORT

Report No.: SHE23020075-02AE

Date: 2023-03-13

Page 25 of 47

Figure 15: Test plots of Field strength of harmonics, 2442MHz, 1GHz-7GHz, Horizontal polarization

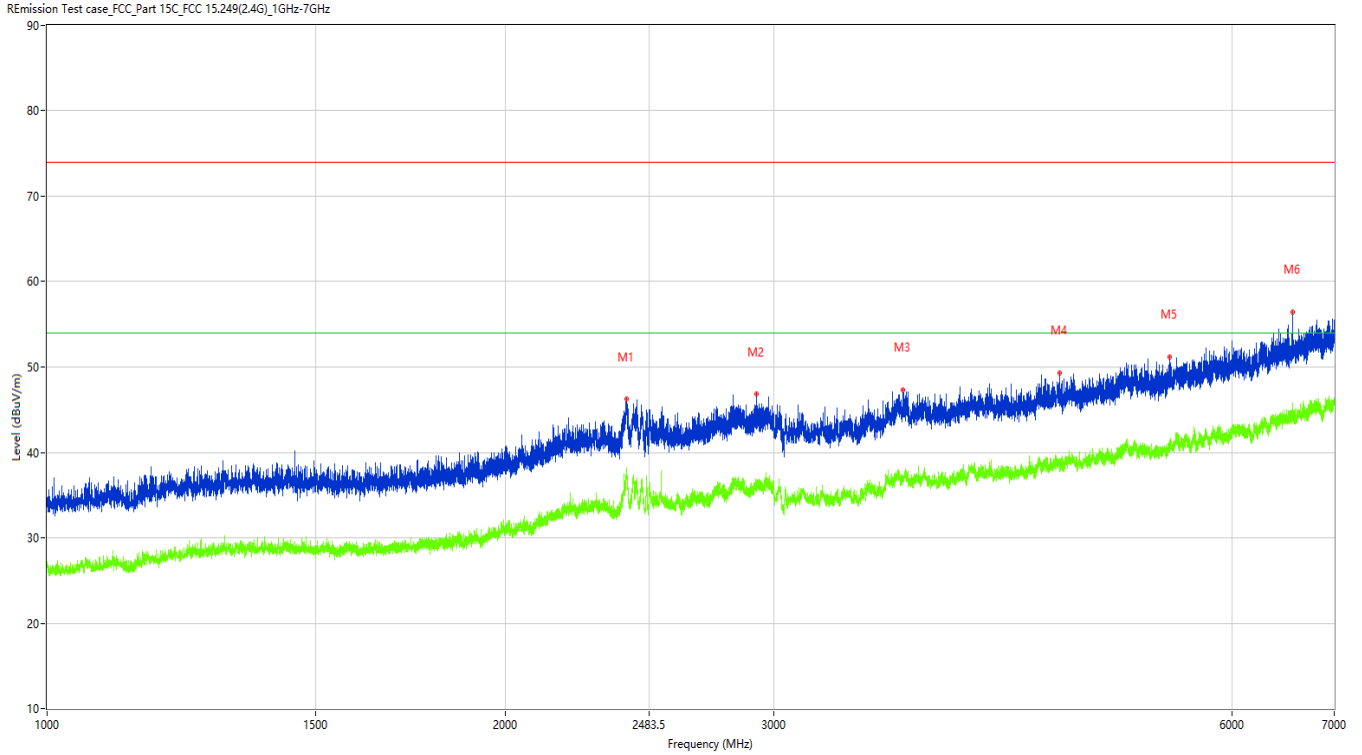

No.	Frequency (MHz)	Results (dBuV/m)	Factor (dB)	Limit (dBuV/m)	Margin (dB)	Detector	Table (Degree)	Height (cm)	Antenna	Verdict
1	2402.000	46.20	-4.45	74.0	27.80	Peak	49.00	100	Horizontal	Pass
1**	2402.000	37.32	-4.45	54.0	16.68	AV	49.00	100	Horizontal	Pass
2	2922.500	46.80	-4.17	74.0	27.20	Peak	360.00	100	Horizontal	Pass
2**	2922.500	36.14	-4.17	54.0	17.86	AV	360.00	100	Horizontal	Pass
3	3647.500	47.34	-1.55	74.0	26.66	Peak	133.60	100	Horizontal	Pass
3**	3647.500	36.87	-1.55	54.0	17.13	AV	133.60	100	Horizontal	Pass
4	4619.000	49.30	-0.48	74.0	24.70	Peak	145.30	100	Horizontal	Pass
4**	4619.000	39.13	-0.48	54.0	14.87	AV	145.30	100	Horizontal	Pass
5	5461.000	51.17	0.99	74.0	22.83	Peak	261.80	100	Horizontal	Pass
5**	5461.000	41.28	0.99	54.0	12.72	AV	261.80	100	Horizontal	Pass
6	6569.500	56.43	4.22	74.0	17.57	Peak	145.30	100	Horizontal	Pass
6**	6569.500	45.79	4.22	54.0	8.21	AV	145.30	100	Horizontal	Pass

TEST REPORT

Report No.: SHE23020075-02AE

Date: 2023-03-13

Page 26 of 47

Figure 16: Test plots of Field strength of harmonics, 2442MHz, 1GHz-7GHz, Vertical polarization

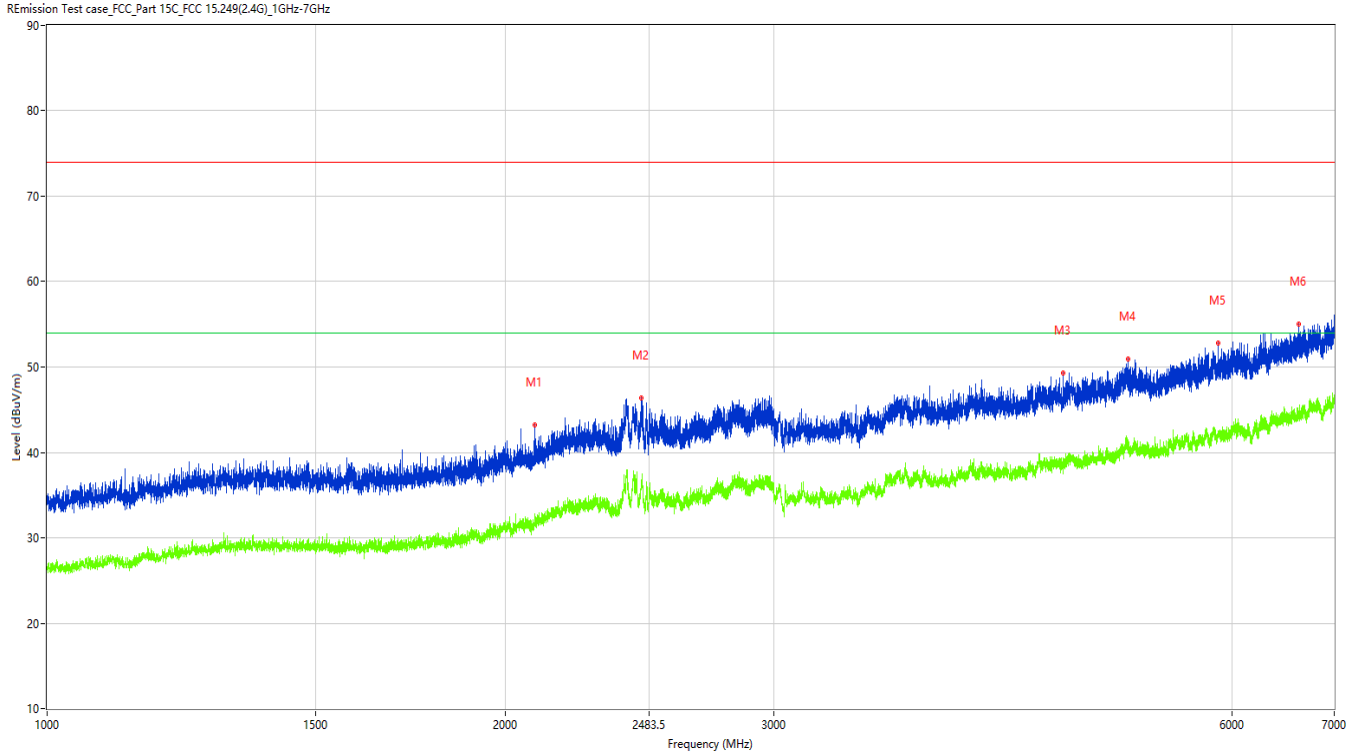

No.	Frequency (MHz)	Results (dBuV/m)	Factor (dB)	Limit (dBuV/m)	Margin (dB)	Detector	Table (Degree)	Height (cm)	Antenna	Verdict
1	2090.500	43.23	-9.38	74.0	30.77	Peak	3.30	100	Vertical	Pass
1**	2090.500	32.85	-9.38	54.0	21.15	AV	3.30	100	Vertical	Pass
2	2455.000	46.43	-5.45	74.0	27.57	Peak	357.70	100	Vertical	Pass
2**	2455.000	36.42	-5.45	54.0	17.58	AV	357.70	100	Vertical	Pass
3	4645.000	49.31	-0.37	74.0	24.69	Peak	84.90	100	Vertical	Pass
3**	4645.000	38.75	-0.37	54.0	15.25	AV	84.90	100	Vertical	Pass
4	5124.500	50.91	1.24	74.0	23.09	Peak	206.00	100	Vertical	Pass
4**	5124.500	40.48	1.24	54.0	13.52	AV	206.00	100	Vertical	Pass
5	5874.500	52.86	2.22	74.0	21.14	Peak	177.50	100	Vertical	Pass
5**	5874.500	41.70	2.22	54.0	12.30	AV	177.50	100	Vertical	Pass
6	6638.000	55.06	4.49	74.0	18.94	Peak	297.10	100	Vertical	Pass
6**	6638.000	44.19	4.49	54.0	9.81	AV	297.10	100	Vertical	Pass

TEST REPORT

Report No.: SHE23020075-02AE

Date: 2023-03-13

Page 27 of 47

Figure 17: Test plots of Field strength of harmonics, 2442MHz, 7GHz-18GHz, Horizontal polarization

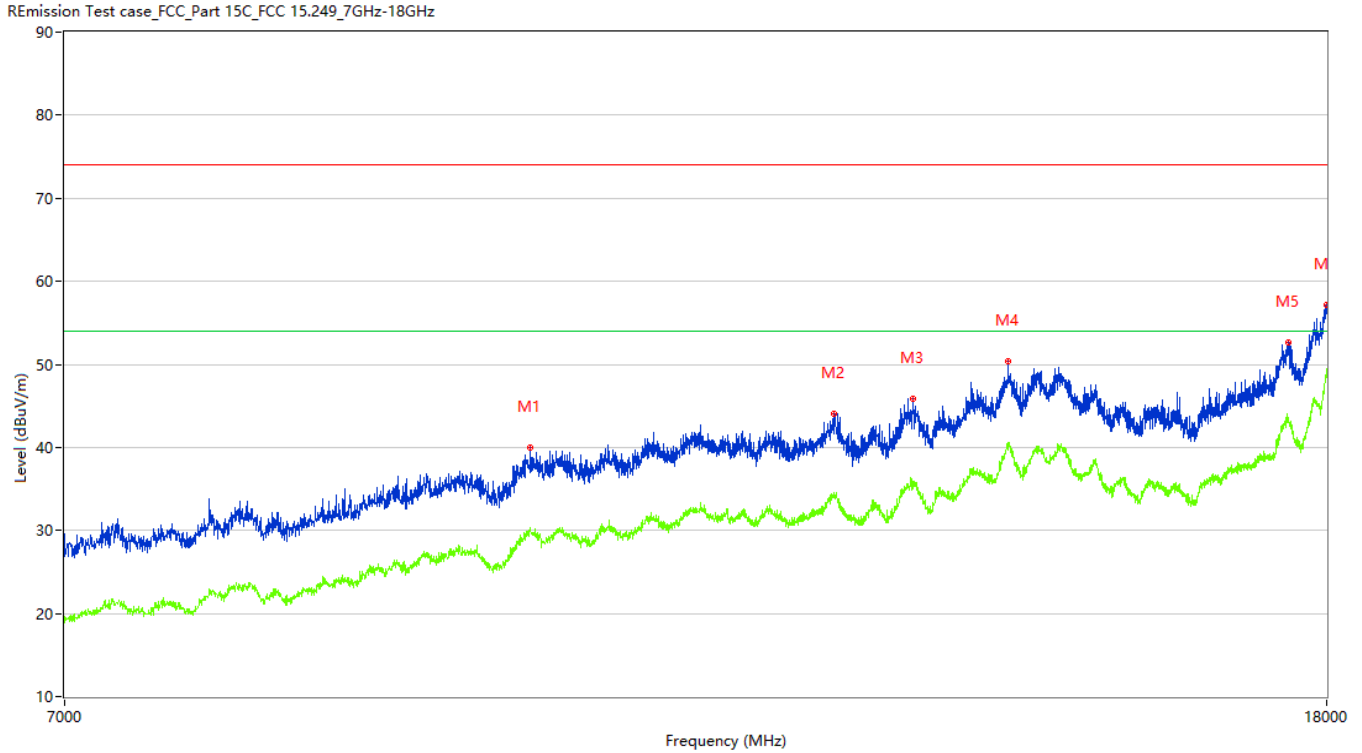

No.	Frequency (MHz)	Results (dBuV/m)	Factor (dB)	Limit (dBuV/m)	Margin (dB)	Detector	Table (Degree)	Height (cm)	Antenna	Verdict
1	9917.750	39.93	9.92	74.0	34.07	Peak	360.00	100	Horizontal	Pass
1**	9917.750	30.08	9.92	54.0	23.92	AV	360.00	100	Horizontal	Pass
2	12447.750	44.05	12.49	74.0	29.95	Peak	36.20	100	Horizontal	Pass
2**	12447.750	34.49	12.49	54.0	19.51	AV	36.20	100	Horizontal	Pass
3	13206.750	45.89	14.11	74.0	28.11	Peak	303.10	100	Horizontal	Pass
3**	13206.750	35.83	14.11	54.0	18.17	AV	303.10	100	Horizontal	Pass
4	14180.250	50.31	19.52	74.0	23.69	Peak	150.20	100	Horizontal	Pass
4**	14180.250	39.64	19.52	54.0	14.36	AV	150.20	100	Horizontal	Pass
5	17491.249	52.56	21.40	74.0	21.44	Peak	199.00	100	Horizontal	Pass
5**	17491.249	43.11	21.40	54.0	10.89	AV	199.00	100	Horizontal	Pass
6	17994.500	57.18	27.58	74.0	16.82	Peak	150.20	100	Horizontal	Pass
6**	17994.500	48.75	27.58	54.0	5.25	AV	150.20	100	Horizontal	Pass

TEST REPORT

Report No.: SHE23020075-02AE

Date: 2023-03-13

Page 28 of 47

Figure 18: Test plots of Field strength of harmonics, 2442MHz, 7GHz-18GHz, Vertical polarization

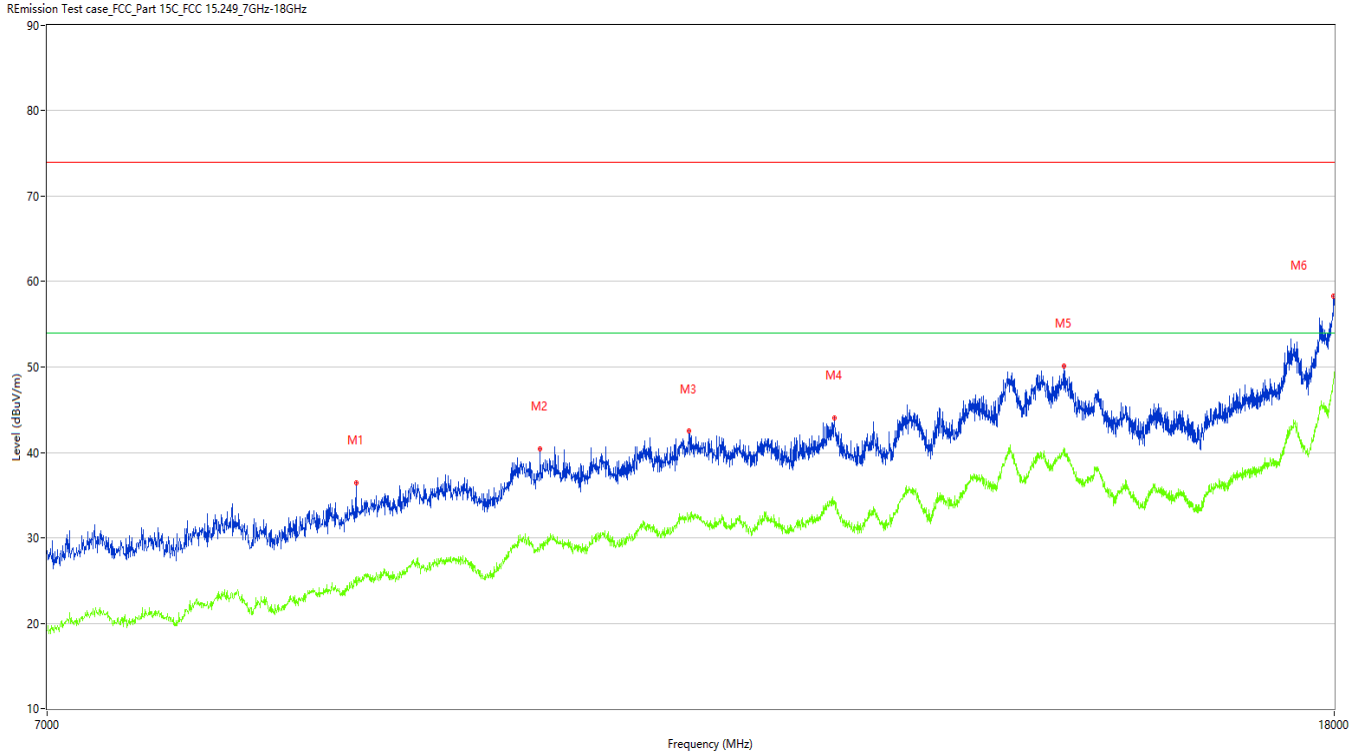

No.	Frequency (MHz)	Results (dBuV/m)	Factor (dB)	Limit (dBuV/m)	Margin (dB)	Detector	Table (Degree)	Height (cm)	Antenna	Verdict
1	8782.000	36.46	4.91	74.0	37.54	Peak	217.60	100	Vertical	Pass
1**	8782.000	25.46	4.91	54.0	28.54	AV	217.60	100	Vertical	Pass
2	10052.500	40.43	9.23	74.0	33.57	Peak	68.60	100	Vertical	Pass
2**	10052.500	29.28	9.23	54.0	24.72	AV	68.60	100	Vertical	Pass
3	11207.500	42.51	11.35	74.0	31.49	Peak	42.10	100	Vertical	Pass
3**	11207.500	32.54	11.35	54.0	21.46	AV	42.10	100	Vertical	Pass
4	12472.500	44.01	12.40	74.0	29.99	Peak	0.00	100	Vertical	Pass
4**	12472.500	34.30	12.40	54.0	19.70	AV	0.00	100	Vertical	Pass
5	14757.750	50.12	18.80	74.0	23.88	Peak	123.00	100	Vertical	Pass
5**	14757.750	40.48	18.80	54.0	13.52	AV	123.00	100	Vertical	Pass
6	17991.750	58.27	27.41	74.0	15.73	Peak	68.60	100	Vertical	Pass
6**	17991.750	48.53	27.41	54.0	5.47	AV	68.60	100	Vertical	Pass

TEST REPORT

Report No.: SHE23020075-02AE

Date: 2023-03-13

Page 29 of 47

Figure 19: Test plots of Field strength of harmonics, 2480MHz, 30MHz-1GHz, Horizontal polarization

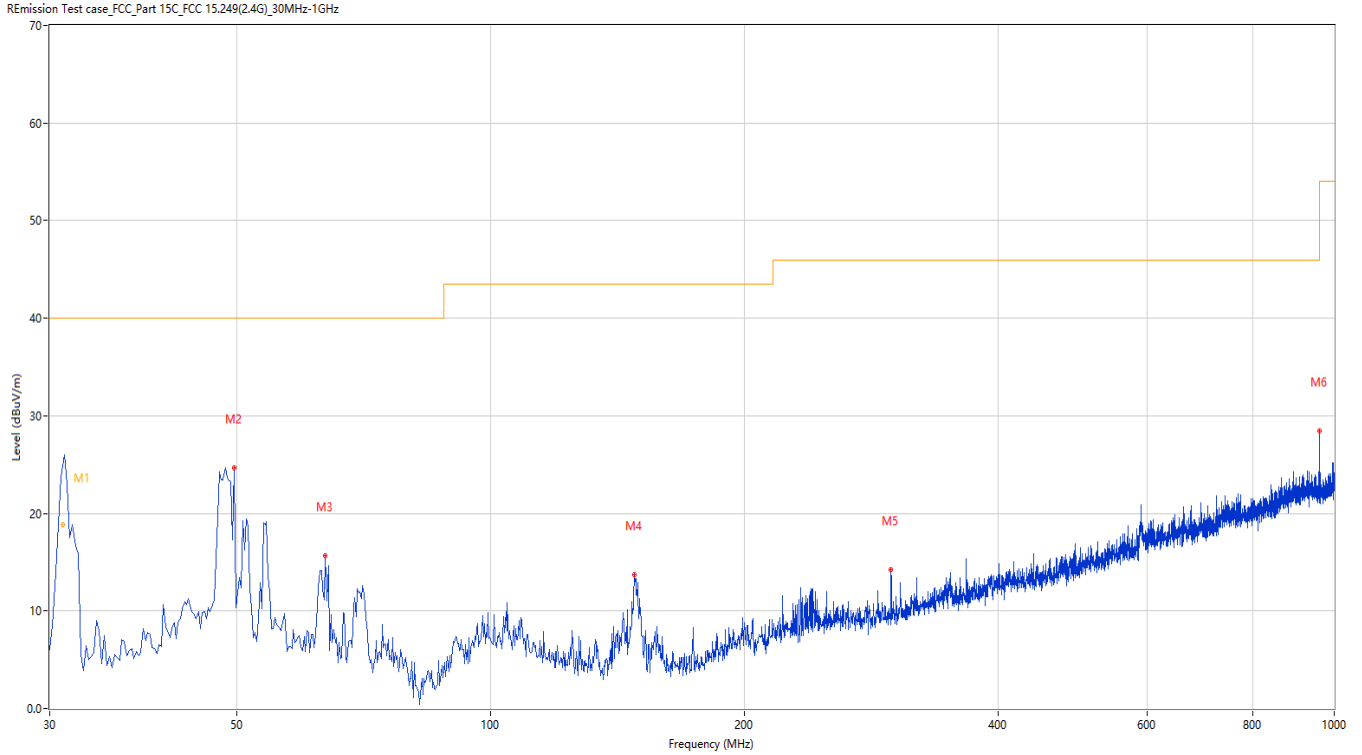

No.	Frequency (MHz)	Results (dBuV/m)	Factor (dB)	Limit (dBuV/m)	Margin (dB)	Detector	Table (Degree)	Height (cm)	Antenna	Verdict
1	31.076	30.24	-29.43	40.0	9.76	Peak	82.60	136	Horizontal	Pass
1*	31.076	18.80	-29.43	40.0	21.20	QP	82.60	136	Horizontal	Pass
2	49.638	24.69	-25.03	40.0	15.31	Peak	87.20	100	Horizontal	Pass
3	63.699	15.64	-27.26	40.0	24.36	Peak	228.80	100	Horizontal	Pass
4	148.068	13.70	-29.98	43.5	29.80	Peak	290.10	100	Horizontal	Pass
5	298.138	14.26	-23.82	46.0	31.74	Peak	43.60	100	Horizontal	Pass
6	959.755	28.46	-9.31	46.0	17.54	Peak	168.10	100	Horizontal	Pass
7	30.000	6.08	-29.82	40.0	33.92	Peak	183.90	100	Horizontal	Pass

TEST REPORT

Report No.: SHE23020075-02AE

Date: 2023-03-13

Page 30 of 47

Figure 20: Test plots of Field strength of harmonics, 2480MHz, 30MHz-1GHz, Vertical polarization

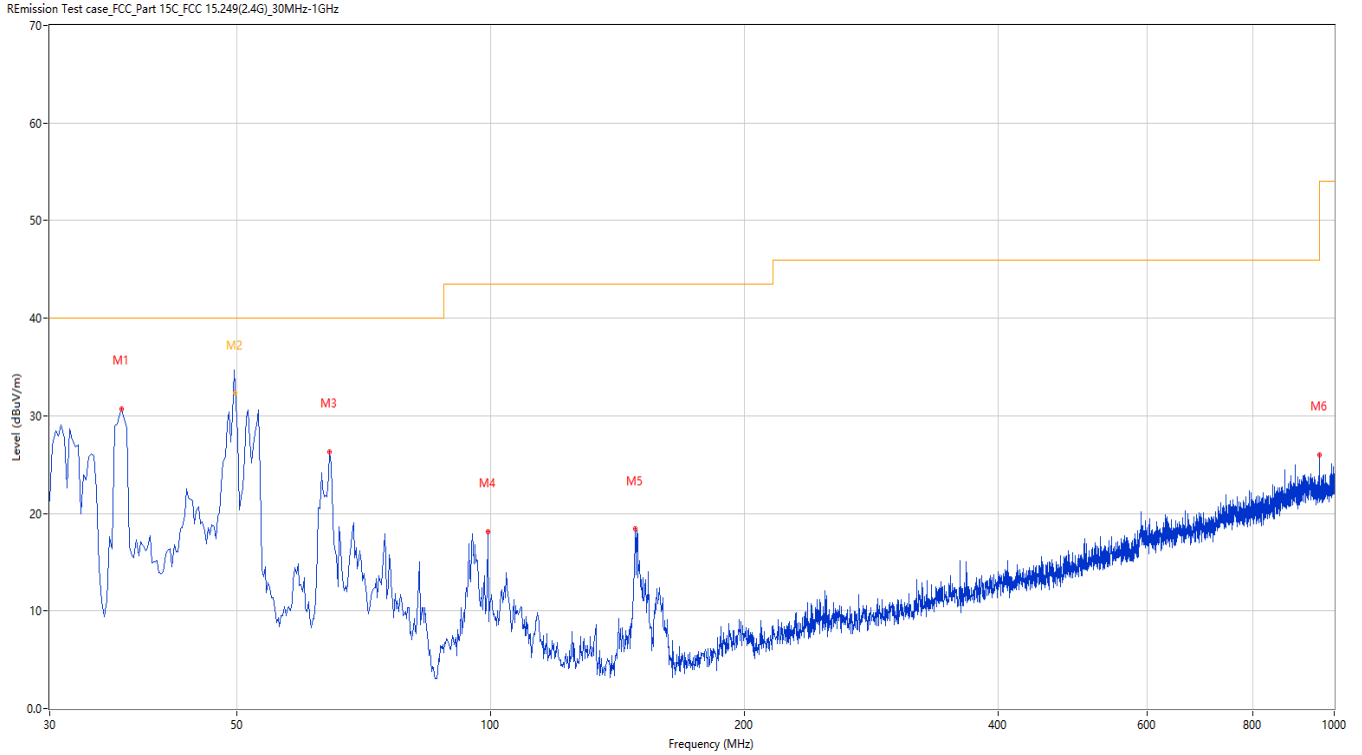

No.	Frequency (MHz)	Results (dBuV/m)	Factor (dB)	Limit (dBuV/m)	Margin (dB)	Detector	Table (Degree)	Height (cm)	Antenna	Verdict
1	36.546	30.74	-27.53	40.0	9.26	Peak	29.50	100	Vertical	Pass
2	49.723	37.51	-25.03	40.0	2.49	Peak	277.60	139	Vertical	Pass
2*	49.723	32.37	-25.03	40.0	7.63	QP	277.60	139	Vertical	Pass
3	64.426	26.28	-27.48	40.0	13.72	Peak	5.10	100	Vertical	Pass
4	99.338	18.14	-26.69	43.5	25.36	Peak	119.30	100	Vertical	Pass
5	148.310	18.37	-29.98	43.5	25.13	Peak	106.70	100	Vertical	Pass
6	959.513	26.00	-9.31	46.0	20.00	Peak	290.00	100	Vertical	Pass

TEST REPORT

Report No.: SHE23020075-02AE

Date: 2023-03-13

Page 31 of 47

Figure 21: Test plots of Field strength of harmonics, 2480MHz, 1GHz-7GHz, Horizontal polarization

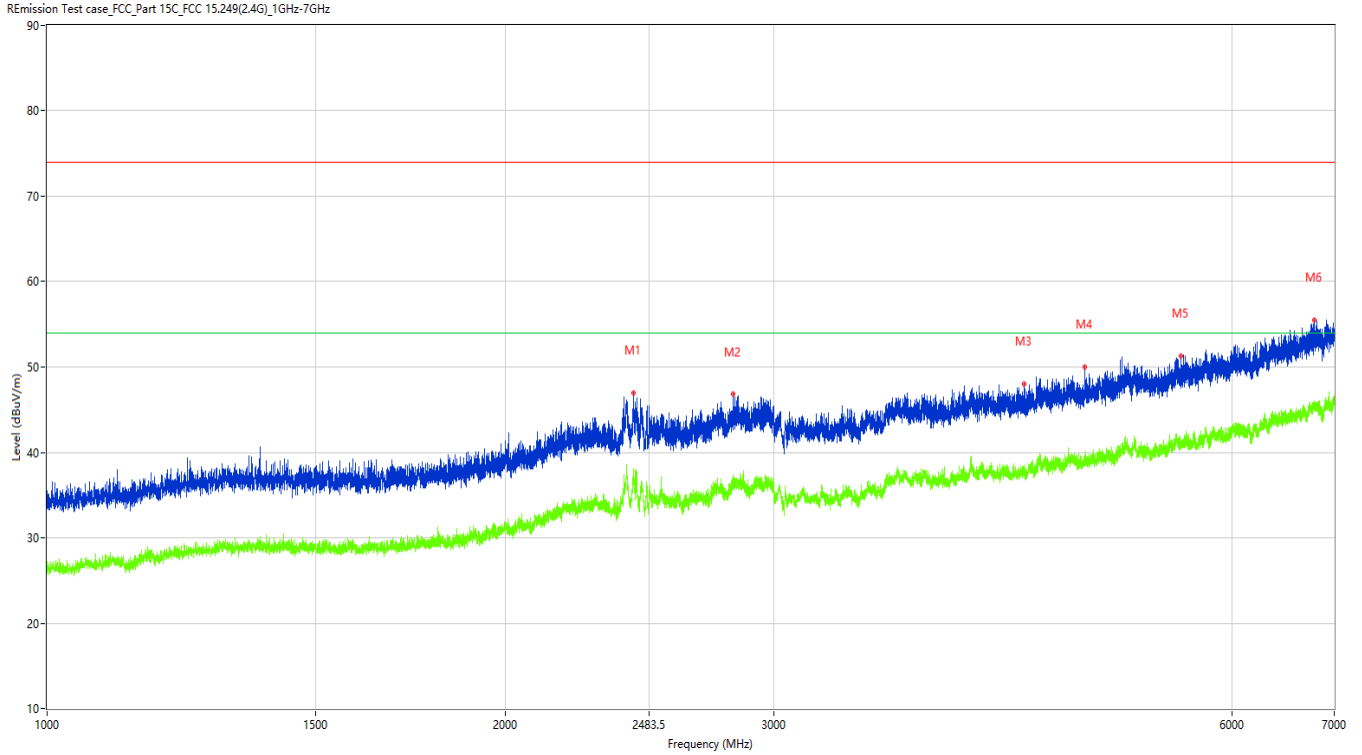

No.	Frequency (MHz)	Results (dBuV/m)	Factor (dB)	Limit (dBuV/m)	Margin (dB)	Detector	Table (Degree)	Height (cm)	Antenna	Verdict
1	2428.000	46.97	-4.92	74.0	27.03	Peak	45.20	100	Horizontal	Pass
1**	2428.000	36.62	-4.92	54.0	17.38	AV	45.20	100	Horizontal	Pass
2	2822.000	46.80	-4.28	74.0	27.20	Peak	320.70	100	Horizontal	Pass
2**	2822.000	35.66	-4.28	54.0	18.34	AV	320.70	100	Horizontal	Pass
3	4378.000	48.00	-1.58	74.0	26.00	Peak	129.00	100	Horizontal	Pass
3**	4378.000	37.46	-1.58	54.0	16.54	AV	129.00	100	Horizontal	Pass
4	4799.500	49.95	-0.60	74.0	24.05	Peak	303.80	100	Horizontal	Pass
4**	4799.500	39.75	-0.60	54.0	14.25	AV	303.80	100	Horizontal	Pass
5	5549.500	51.30	1.30	74.0	22.70	Peak	260.80	100	Horizontal	Pass
5**	5549.500	40.97	1.30	54.0	13.03	AV	260.80	100	Horizontal	Pass
6	6794.000	55.55	5.18	74.0	18.45	Peak	114.50	100	Horizontal	Pass
6**	6794.000	45.88	5.18	54.0	8.12	AV	114.50	100	Horizontal	Pass

TEST REPORT

Report No.: SHE23020075-02AE

Date: 2023-03-13

Page 32 of 47

Figure 22: Test plots of Field strength of harmonics, 2480MHz, 1GHz-7GHz, Vertical polarization

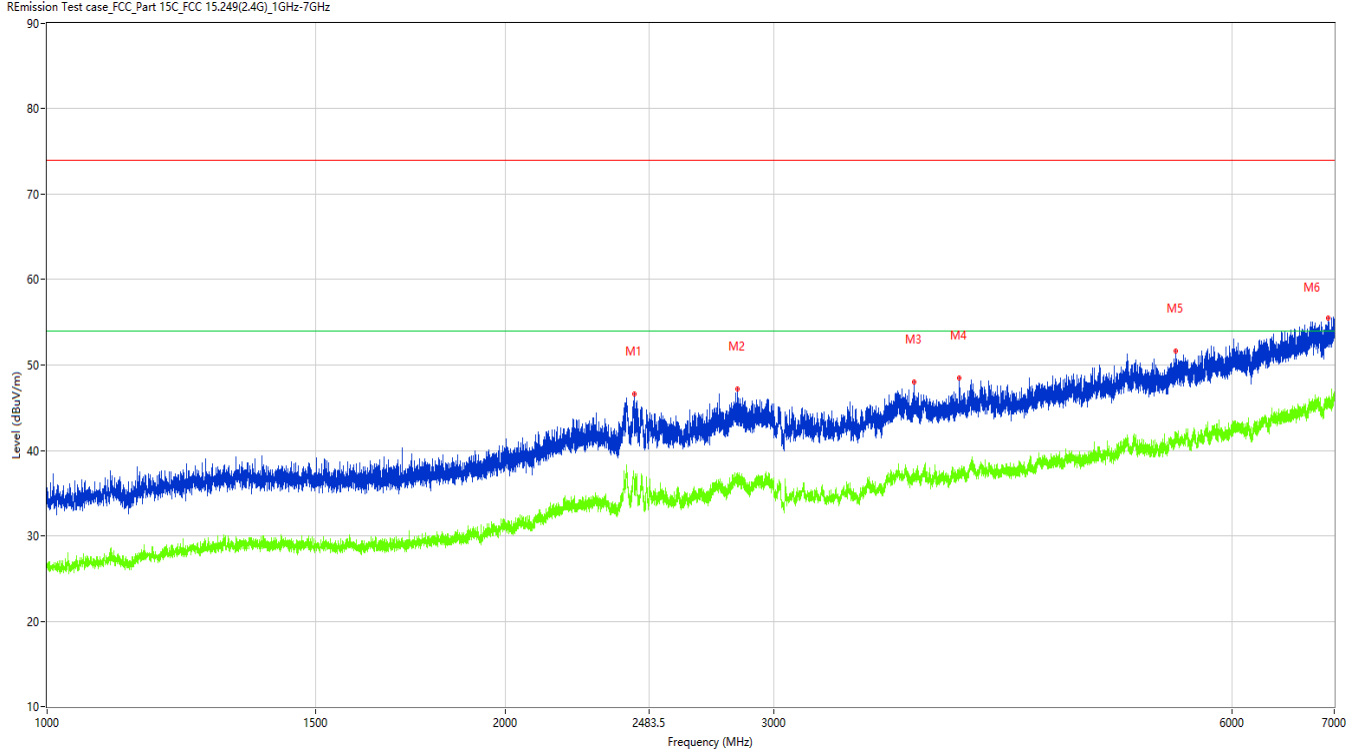

No.	Frequency (MHz)	Results (dBuV/m)	Factor (dB)	Limit (dBuV/m)	Margin (dB)	Detector	Table (Degree)	Height (cm)	Antenna	Verdict
1	2428.500	46.60	-4.92	74.0	27.40	Peak	219.50	100	Vertical	Pass
1**	2428.500	36.59	-4.92	54.0	17.41	AV	219.50	100	Vertical	Pass
2	2840.500	47.20	-3.89	74.0	26.80	Peak	234.90	100	Vertical	Pass
2**	2840.500	36.44	-3.89	54.0	17.56	AV	234.90	100	Vertical	Pass
3	3707.000	47.98	-2.08	74.0	26.02	Peak	191.10	100	Vertical	Pass
3**	3707.000	36.83	-2.08	54.0	17.17	AV	191.10	100	Vertical	Pass
4	3972.500	48.52	-1.35	74.0	25.48	Peak	86.10	100	Vertical	Pass
4**	3972.500	37.07	-1.35	54.0	16.93	AV	86.10	100	Vertical	Pass
5	5507.500	51.65	1.54	74.0	22.35	Peak	294.60	100	Vertical	Pass
5**	5507.500	40.80	1.54	54.0	13.20	AV	294.60	100	Vertical	Pass
6	6940.000	55.46	5.14	74.0	18.54	Peak	294.60	100	Vertical	Pass
6**	6940.000	45.36	5.14	54.0	8.64	AV	294.60	100	Vertical	Pass

TEST REPORT

Report No.: SHE23020075-02AE

Date: 2023-03-13

Page 33 of 47

Figure 23: Test plots of Field strength of harmonics, 2480MHz, 7GHz-18GHz, Horizontal polarization

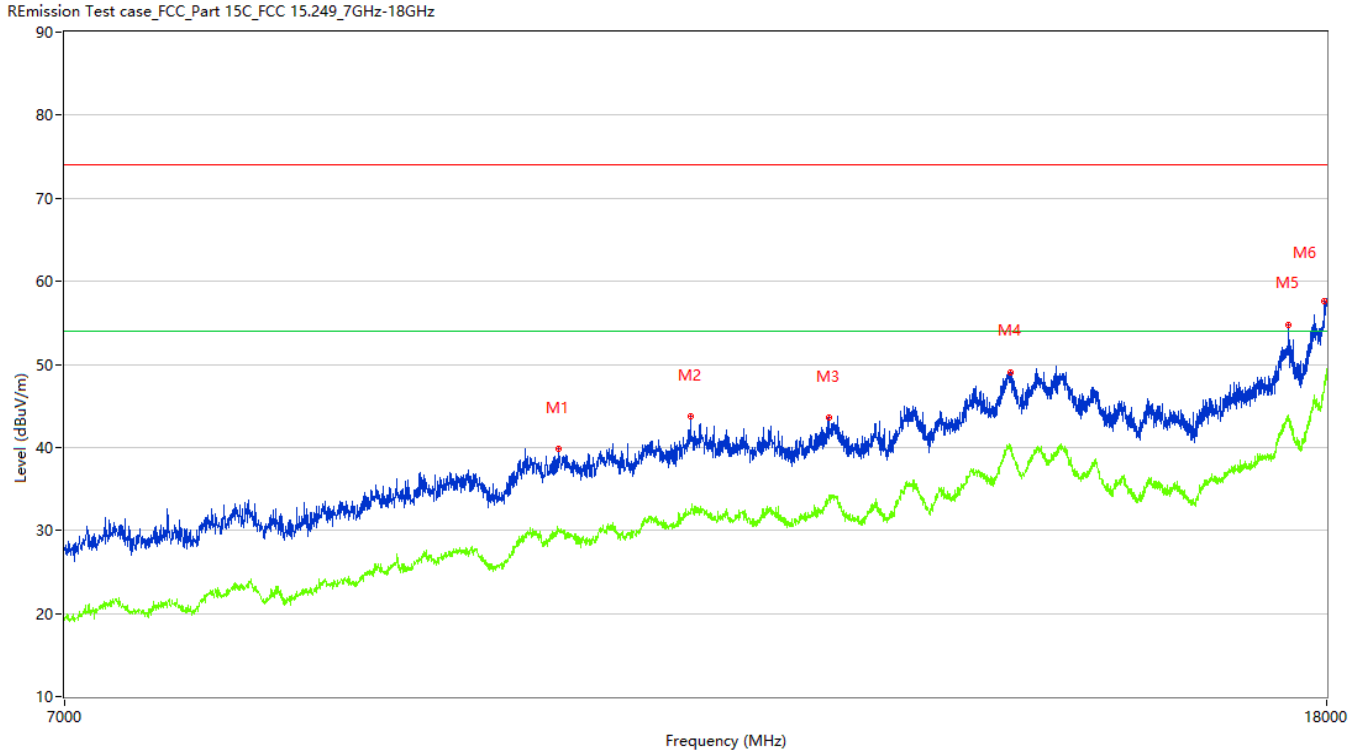

No.	Frequency (MHz)	Results (dBuV/m)	Factor (dB)	Limit (dBuV/m)	Margin (dB)	Detector	Table (Degree)	Height (cm)	Antenna	Verdict
1	10135.000	39.83	9.37	74.0	34.17	Peak	224.50	100	Horizontal	Pass
1**	10135.000	30.14	9.37	54.0	23.86	AV	224.50	100	Horizontal	Pass
2	11180.000	43.72	11.09	74.0	30.28	Peak	197.00	100	Horizontal	Pass
2**	11180.000	32.27	11.09	54.0	21.73	AV	197.00	100	Horizontal	Pass
3	12401.000	43.58	12.26	74.0	30.42	Peak	39.90	100	Horizontal	Pass
3**	12401.000	33.82	12.26	54.0	20.18	AV	39.90	100	Horizontal	Pass
4	14213.250	49.01	19.19	74.0	24.99	Peak	274.90	100	Horizontal	Pass
4**	14213.250	39.51	19.19	54.0	14.49	AV	274.90	100	Horizontal	Pass
5	17491.249	54.73	21.40	74.0	19.27	Peak	224.50	100	Horizontal	Pass
5**	17491.249	43.28	21.40	54.0	10.72	AV	224.50	100	Horizontal	Pass
6	17964.249	57.66	25.72	74.0	16.34	Peak	360.00	100	Horizontal	Pass
6**	17964.249	47.67	25.72	54.0	6.33	AV	360.00	100	Horizontal	Pass

TEST REPORT

Report No.: SHE23020075-02AE

Date: 2023-03-13

Page 34 of 47

Figure 24: Test plots of Field strength of harmonics, 2480MHz, 7GHz-18GHz, Vertical polarization

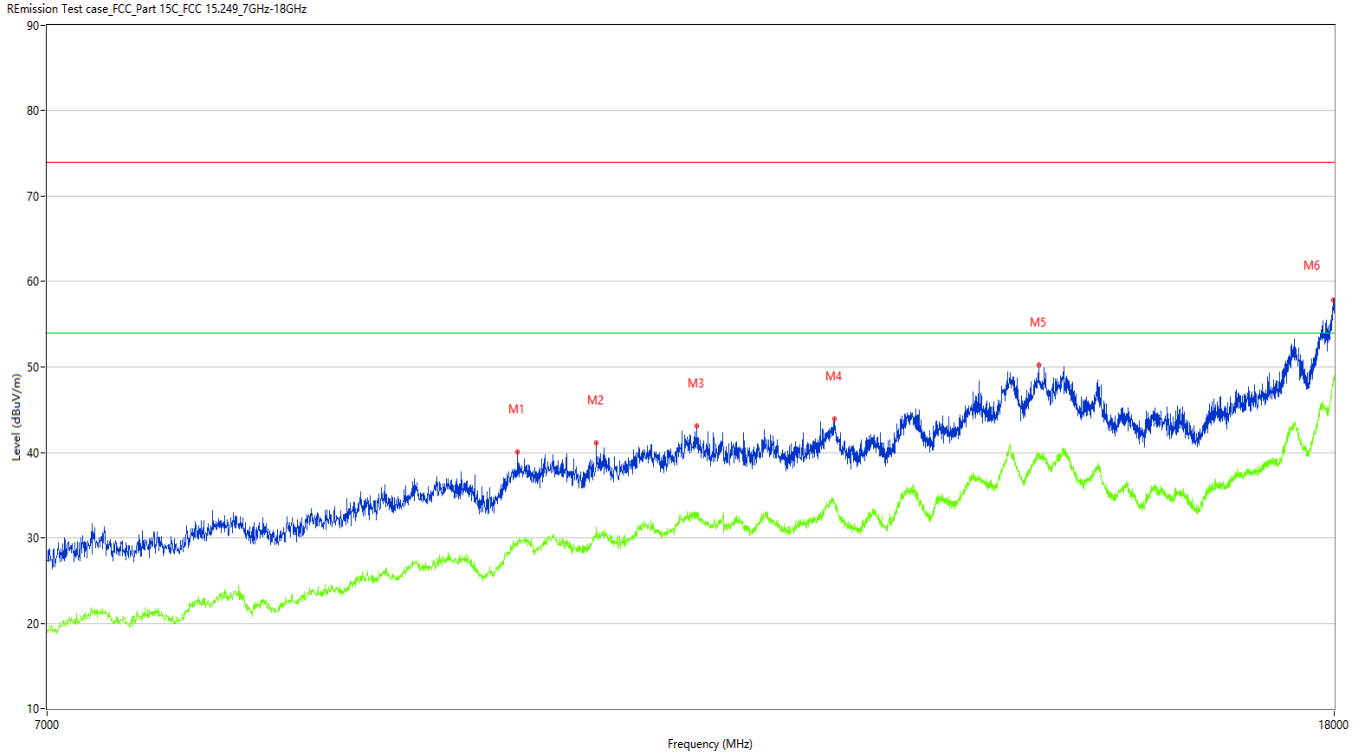

No.	Frequency (MHz)	Results (dBuV/m)	Factor (dB)	Limit (dBuV/m)	Margin (dB)	Detector	Table (Degree)	Height (cm)	Antenna	Verdict
1	9887.500	40.04	9.49	74.0	33.96	Peak	41.50	100	Vertical	Pass
1**	9887.500	29.66	9.49	54.0	24.34	AV	41.50	100	Vertical	Pass
2	10473.250	41.13	9.72	74.0	32.87	Peak	174.70	100	Vertical	Pass
2**	10473.250	31.23	9.72	54.0	22.77	AV	174.70	100	Vertical	Pass
3	11276.250	43.13	12.23	74.0	30.87	Peak	360.00	100	Vertical	Pass
3**	11276.250	32.89	12.23	54.0	21.11	AV	360.00	100	Vertical	Pass
4	12472.500	43.96	12.40	74.0	30.04	Peak	41.50	100	Vertical	Pass
4**	12472.500	34.00	12.40	54.0	20.00	AV	41.50	100	Vertical	Pass
5	14493.750	50.26	17.75	74.0	23.74	Peak	41.50	100	Vertical	Pass
5**	14493.750	39.32	17.75	54.0	14.68	AV	41.50	100	Vertical	Pass
6	17986.251	57.80	27.07	74.0	16.20	Peak	174.70	100	Vertical	Pass
6**	17986.251	48.48	27.07	54.0	5.52	AV	174.70	100	Vertical	Pass

TEST REPORT

Report No.: SHE23020075-02AE

Date: 2023-03-13

Page 35 of 47

4.1.3 Band Edge

RESULT:

PASS

Test standard : FCC Part 15.249(d), 15.209
RSS-210 B.10(b), RSS-GEN 8.10

Requirement : ANSI C63.10-2013

Kind of test site : 3m Semi-Anechoic Chamber

Test setup

Test Channel : Low/High

Operation Mode : A.i/iii

Ambient temperature : 22.5°C

Relative humidity : 48%

Figure 25: Test plots of Band Edge, 2403MHz, Horizontal polarization

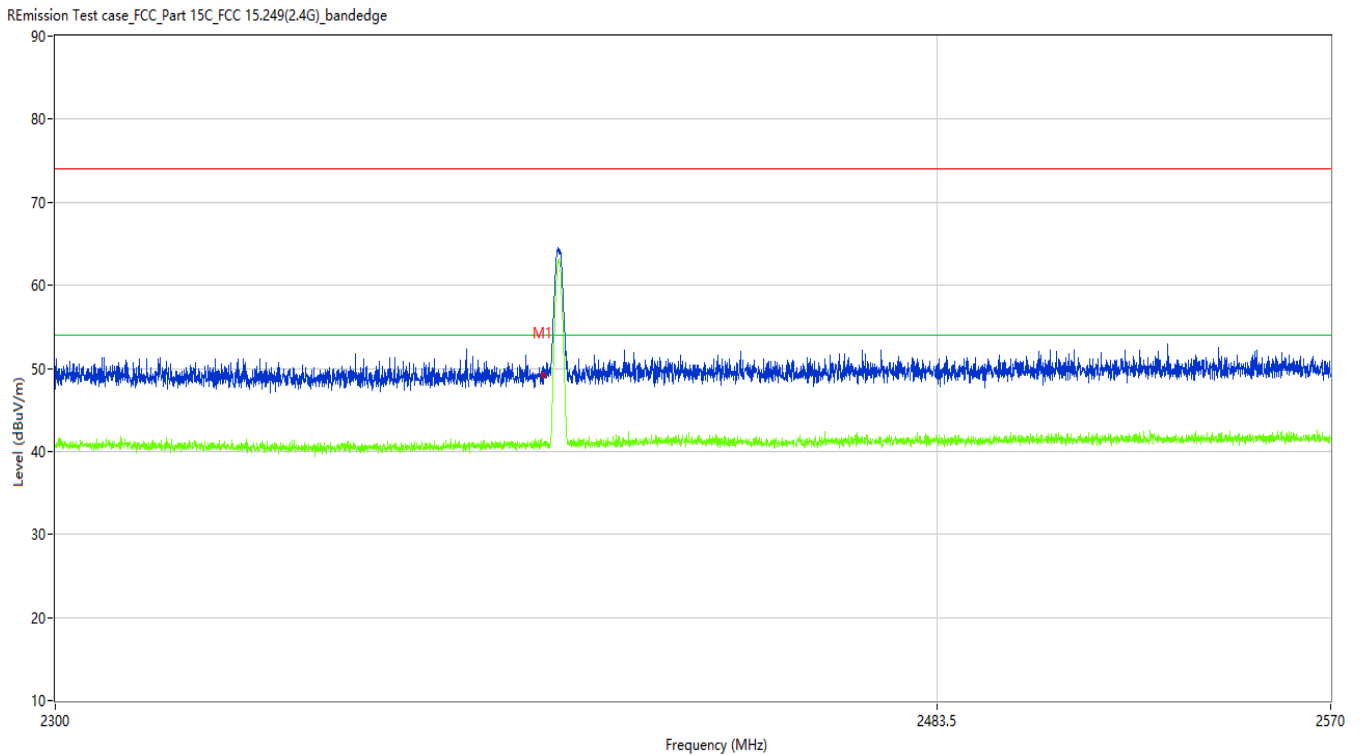

No.	Frequency (MHz)	Results (dBuV/m)	Factor (dB)	Limit (dBuV/m)	Margin (dB)	Detector	Table (Degree)	Height (cm)	Antenna	Verdict
1	2400.000	49.26	-9.87	74.0	24.74	Peak	230.65	100	Horizontal	Pass
1**	2400.000	41.23	-9.87	54.0	12.77	AV	230.65	100	Horizontal	Pass

TEST REPORT

Report No.: SHE23020075-02AE

Date: 2023-03-13

Page 36 of 47

Figure 26: Test plots of Band Edge, 2403MHz, Vertical polarization

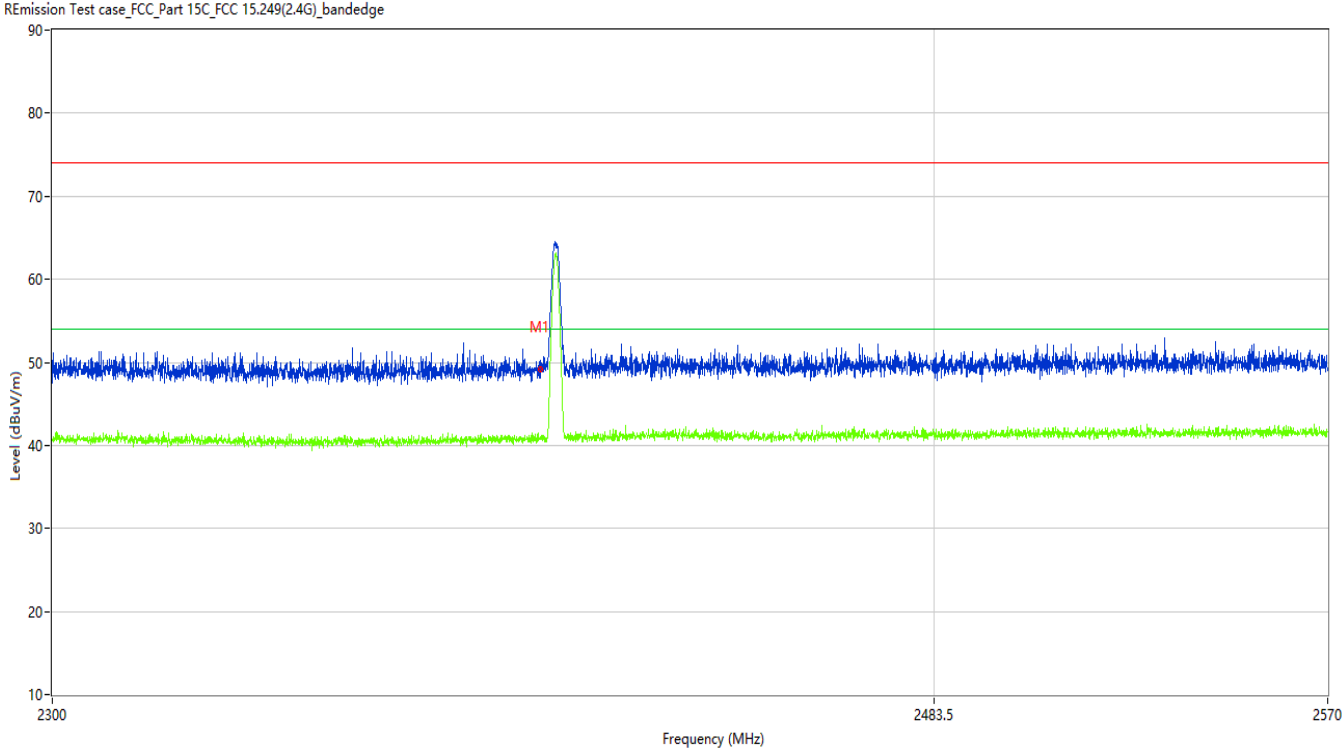

No.	Frequency (MHz)	Results (dBuV/m)	Factor (dB)	Limit (dBuV/m)	Margin (dB)	Detector	Table (Degree)	Height (cm)	Antenna	Verdict
1	2400.000	49.24	-9.87	74.0	24.76	Peak	230.65	100	Vertical	Pass
1**	2400.000	41.18	-9.87	54.0	12.82	AV	230.65	100	Vertical	Pass

TEST REPORT

Report No.: SHE23020075-02AE

Date: 2023-03-13

Page 37 of 47

Figure 27: Test plots of Band Edge, 2480MHz, Horizontal polarization

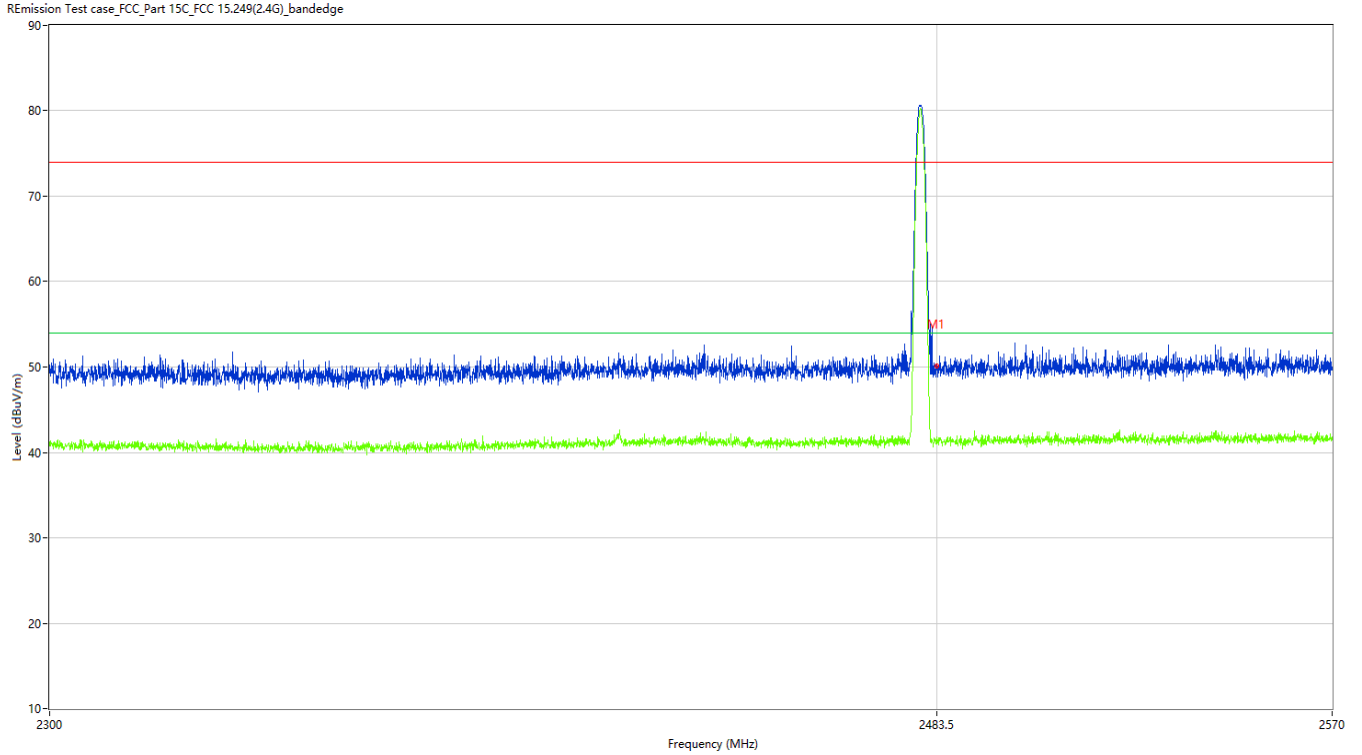

No.	Frequency (MHz)	Results (dBuV/m)	Factor (dB)	Limit (dBuV/m)	Margin (dB)	Detector	Table (Degree)	Height (cm)	Antenna	Verdict
1	2483.500	49.96	-9.51	74.0	24.04	Peak	219.80	100	Horizontal	Pass
1**	2483.500	41.67	-9.51	54.0	12.33	AV	219.80	100	Horizontal	Pass

TEST REPORT

Report No.: SHE23020075-02AE

Date: 2023-03-13

Page 38 of 47

Figure 28: Test plots of Band Edge, 2480MHz, Vertical polarization

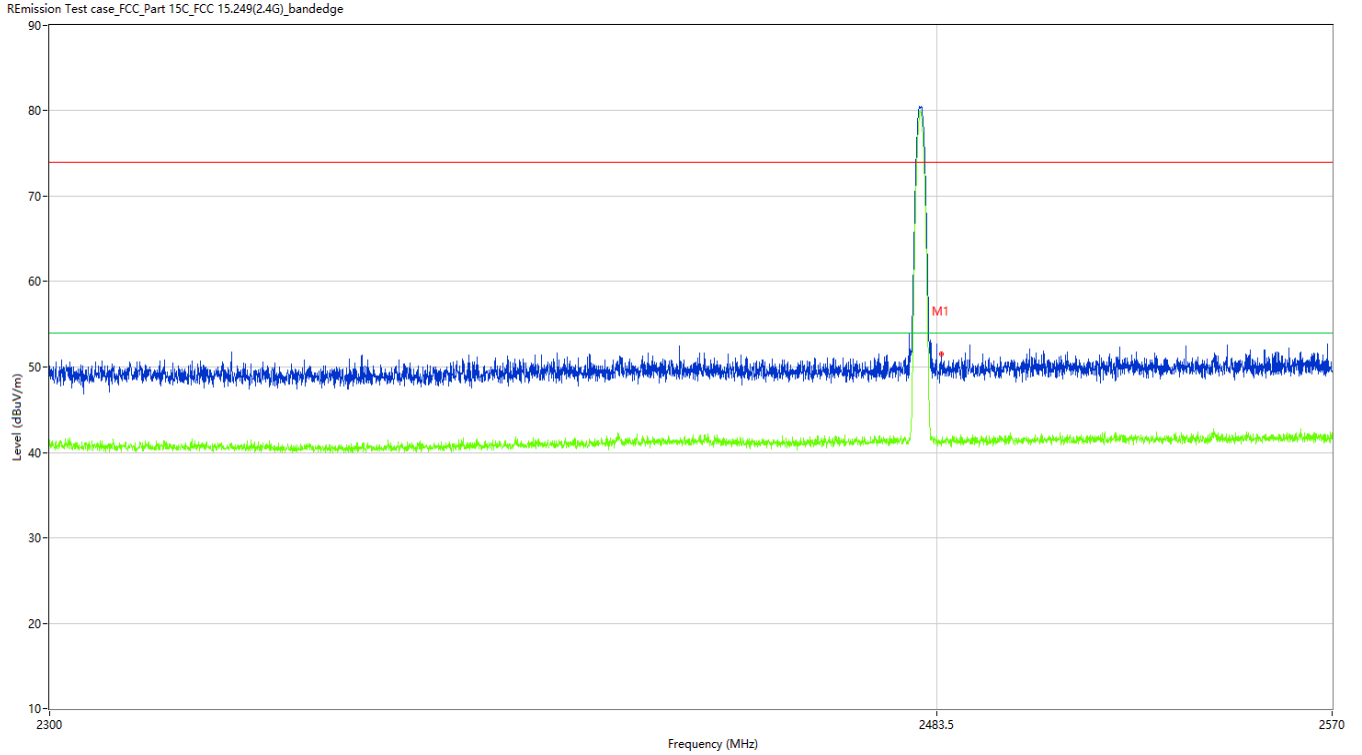

No.	Frequency (MHz)	Results (dBuV/m)	Factor (dB)	Limit (dBuV/m)	Margin (dB)	Detector	Table (Degree)	Height (cm)	Antenna	Verdict
1	2483.500	51.26	-9.51	74.0	22.74	Peak	193.11	100	Vertical	Pass
1**	2483.500	41.61	-9.51	54.0	12.39	AV	193.11	100	Vertical	Pass

TEST REPORT

Report No.: SHE23020075-02AE

Date: 2023-03-13

Page 39 of 47

4.1.4 20dB Bandwidth and 99% Bandwidth

RESULT:

PASS

Test standard : FCC Part 15.215(c), RSS-GEN 6.7

Requirement : ANSI C63.10-2013

Kind of test site : Shielded room

Test setup

Test Channel : Low/Middle/High

Operation Mode : A.i/ii/iii

Ambient temperature : 22.8°C

Relative humidity : 50%

Table 1: 20dB Bandwidth and 99% Bandwidth

Test Mode	Test Channel (MHz)	20dB Bandwidth (MHz)	99% Bandwidth (MHz)
GFSK	2403	1.038	0.974
	2442	0.988	0.902
	2480	0.973	0.940

TEST REPORT

Report No.: SHE23020075-02AE

Date: 2023-03-13

Page 40 of 47

Figure 29: The plots of 20dB Bandwidth and 99% Bandwidth, 2403MHz

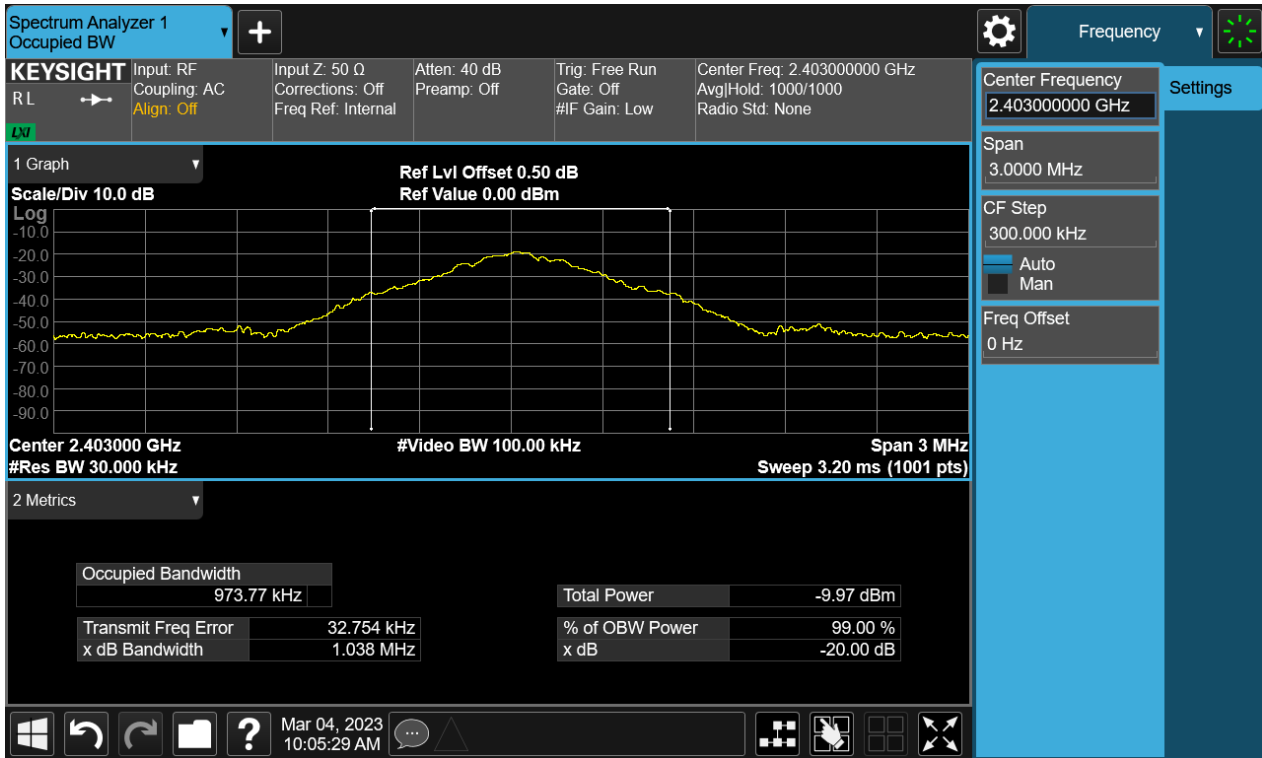

Figure 30: The plots of 20dB Bandwidth and 99% Bandwidth, 2442MHz



TEST REPORT

Report No.: SHE23020075-02AE

Date: 2023-03-13

Page 41 of 47

Figure 31: The plots of 20dB Bandwidth and 99% Bandwidth, 2480MHz

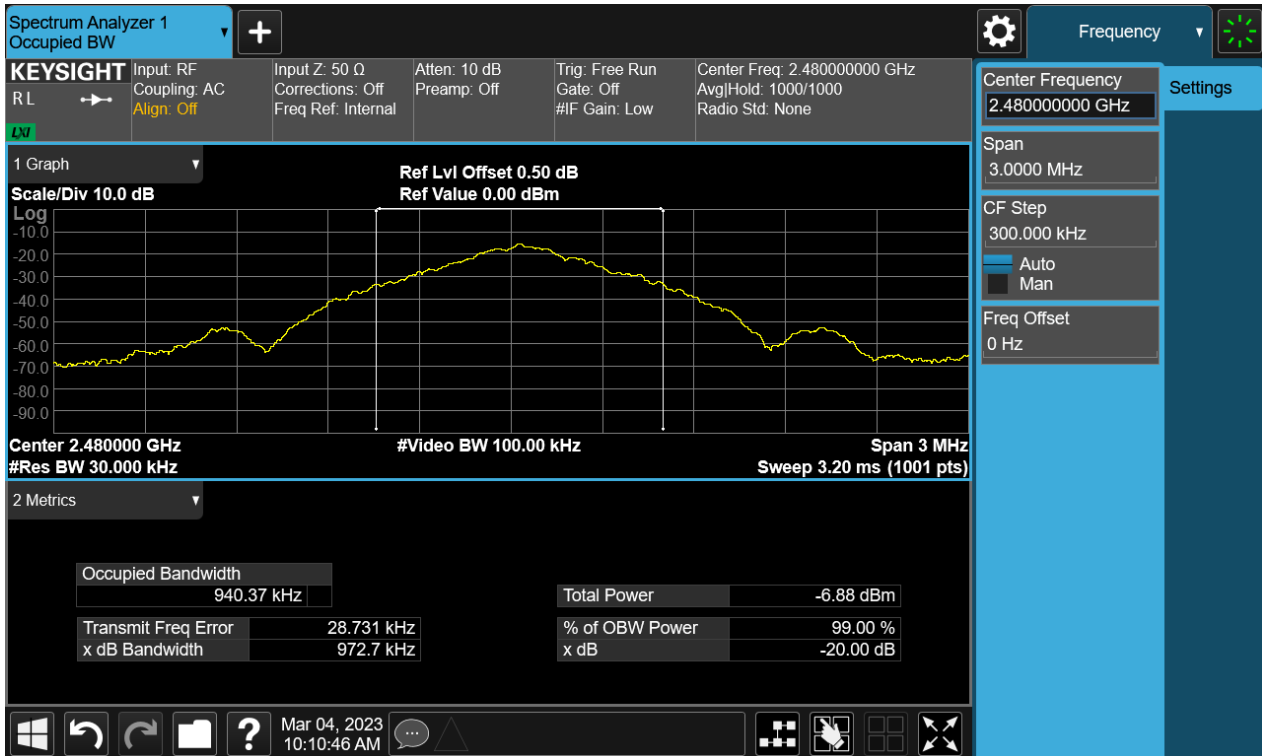

TEST REPORT

Report No.: SHE23020075-02AE

Date: 2023-03-13

Page 42 of 47

5 Appendixes

5.1 Photographs of the Sample

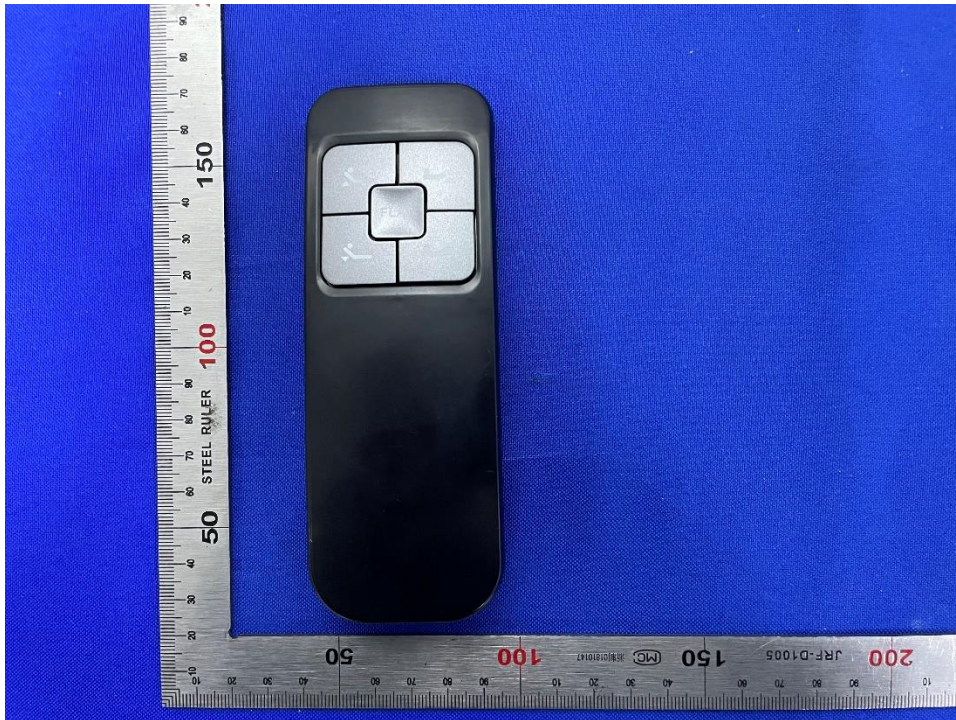

Front of the sample



Back of the sample

TEST REPORT

Report No.:

SHE23020075-02AE

Date:

2023-03-13

Page 43 of 47



Left of the sample



Right of the sample

TEST REPORT

Report No.:

SHE23020075-02AE

Date:

2023-03-13

Page 44 of 47



Top of the sample



Bottom of the sample

TEST REPORT

Report No.:

SHE23020075-02AE

Date:

2023-03-13

Page 45 of 47



Open of the sample

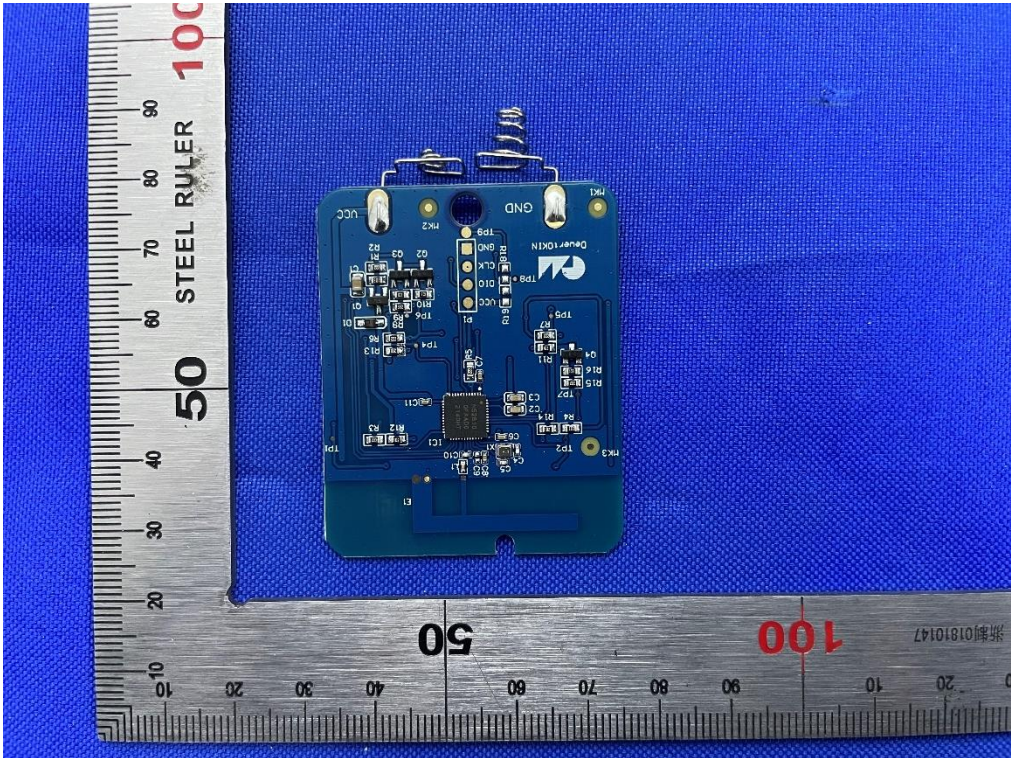

Internal-1 of the sample

TEST REPORT

Report No.:

SHE23020075-02AE

Date:

2023-03-13

Page 46 of 47

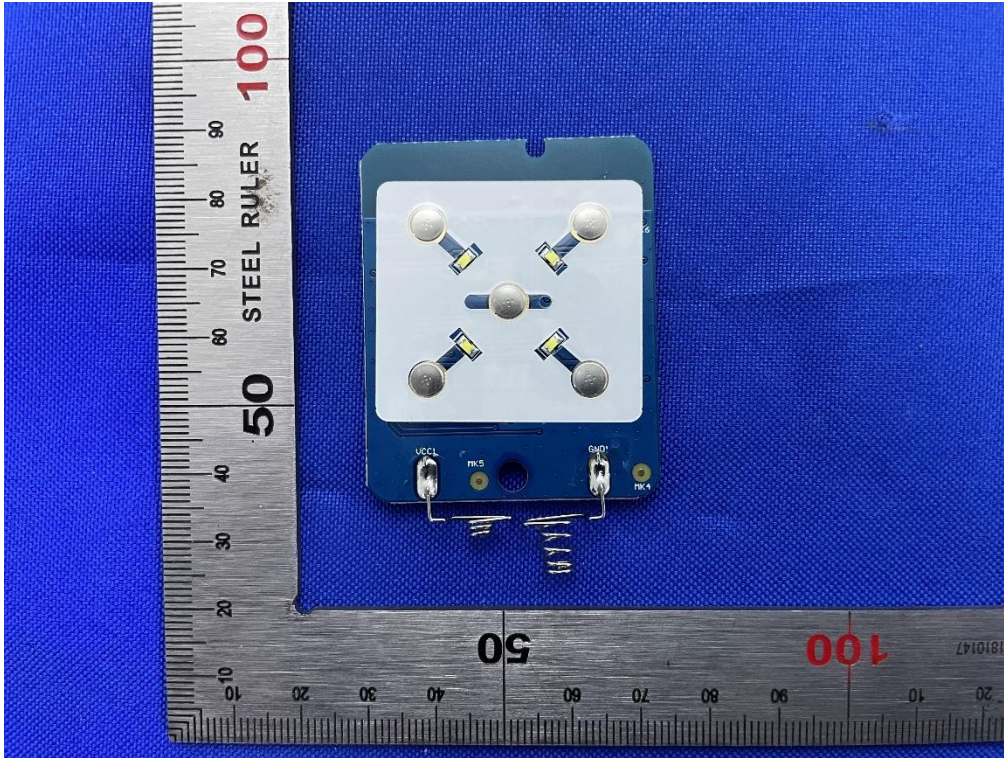

Internal-2 of the sample

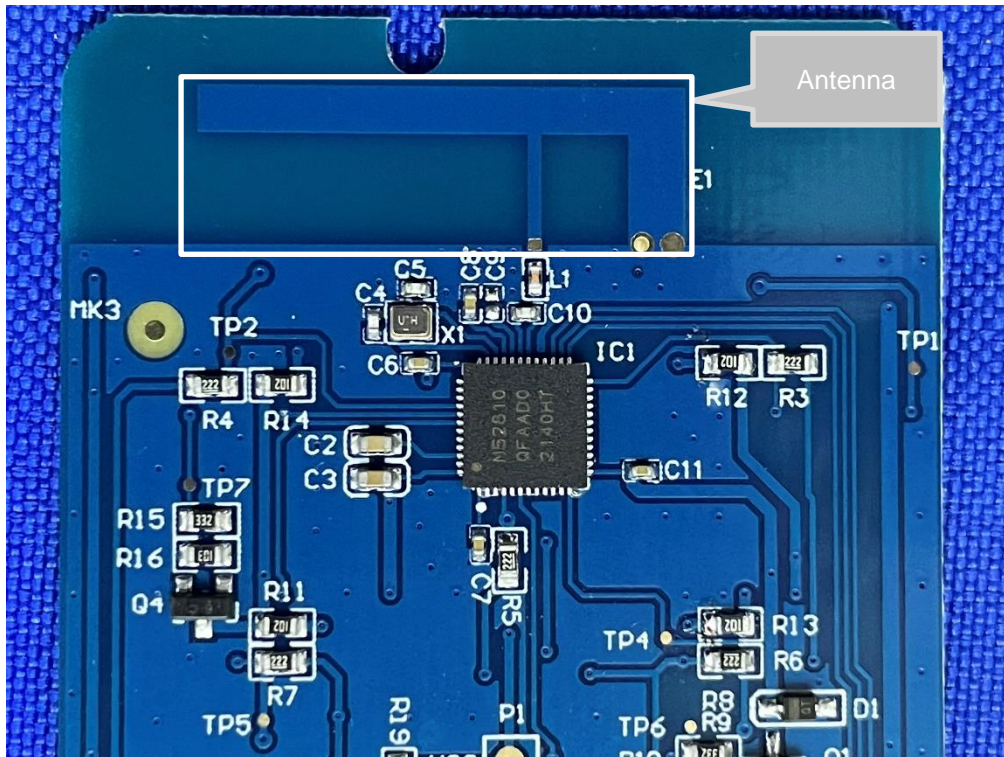

Antenna position of the sample

TEST REPORT

Report No.: SHE23020075-02AE

Date: 2023-03-13

Page 47 of 47

5.2 Set-up for Spurious Emissions below 1GHz

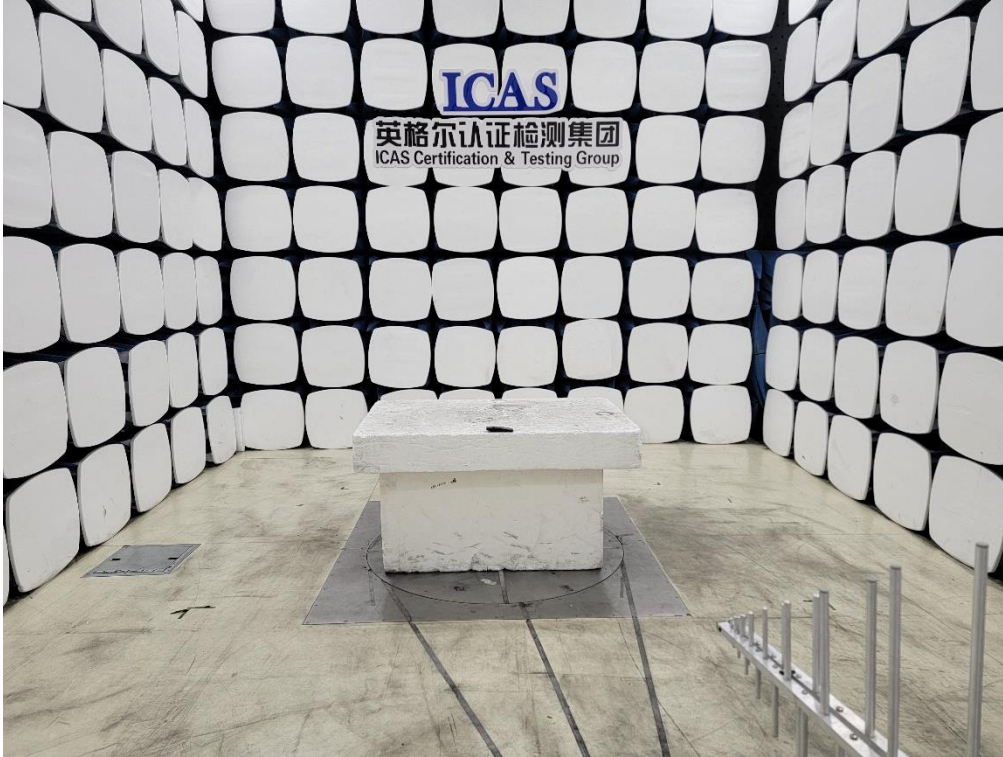

5.3 Set-up for Spurious Emissions above 1GHz

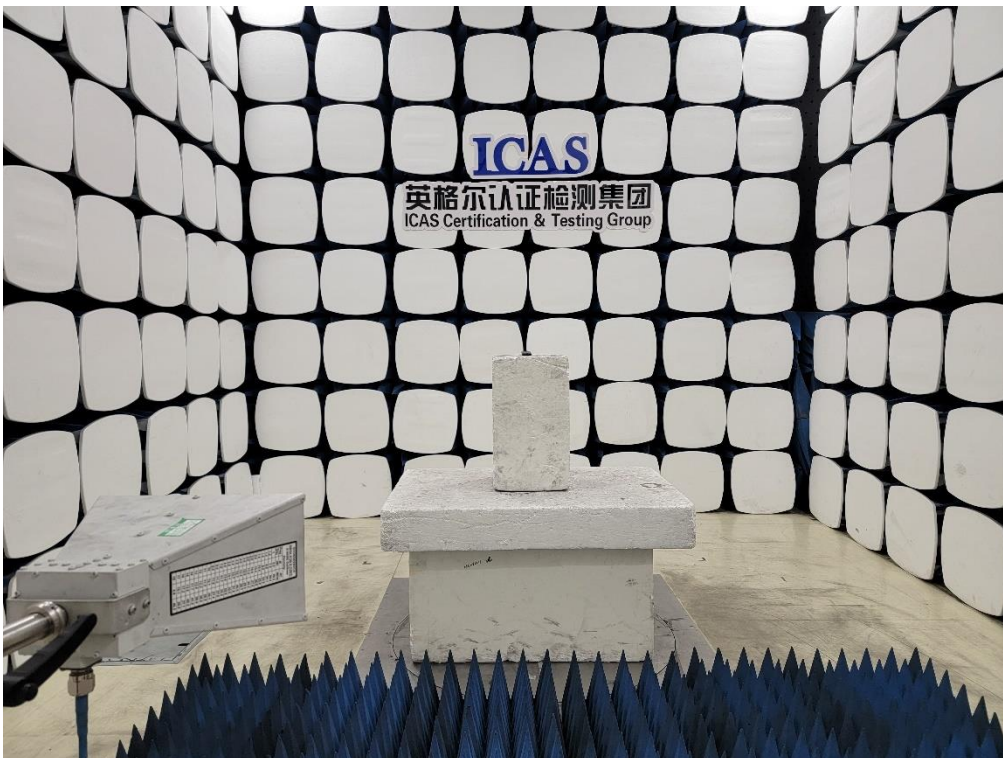

End of the report