

**FCC Part 15.249**  
**RSS-GEN ISSUE 5 February 2021 Amendment 2**  
**RSS-210, ISSUE 10, April 2020 Amendment**

**TEST REPORT**

For

**DewertOkin Technology Group Co., Ltd.**

Room 247, Floor 6, Jiaxing Photovoltaic Science and Innovation Park, 1288 Kanghe  
Road, Xiuzhou District, Jiaxing City, Zhejiang Province, China

**FCC ID: 2AVJ8-FP0808**  
**IC: 25804-FP0808**

<b>Report Type:</b> Original Report	<b>Product Name:</b> Offline voice
<b>Report Producer :</b> <u>Allen Cheng</u>	
<b>Report Number :</b> <u>RLK221019002RF01</u>	
<b>Report Date :</b> <u>2022-11-14</u>	
<b>Reviewed By :</b> <u>Andy Shih</u> <i>Andy Shih</i>	
<b>Prepared By:</b> Bay Area Compliance Laboratories Corp. (Linkou Laboratory) No. 6, Wende 2Rd., Guishan Dist., Taoyuan City 33382, Taiwan (R.O.C.) Tel: +886 (3)3961072 Fax: +886 (3) 3961027 www.bacl.com.tw	

### Revision History

Revision	No.	Report Number	Issue Date	Description	Author/ Revised by
0.0	RLK221019002	RLK221019002RF01	2022-11-14	Original Report	Allen Cheng

## TABLE OF CONTENTS

<b>1</b>	<b>General Information.....</b>	<b>5</b>
1.1	Product Description for Equipment under Test (EUT) .....	5
1.2	Objective .....	6
1.3	Related Submittal(s)/Grant(s).....	6
1.4	Test Methodology.....	6
1.5	Statement .....	6
1.6	Measurement Uncertainty .....	7
1.7	Environmental Conditions.....	7
1.8	Test Facility.....	7
<b>2</b>	<b>System Test Configuration.....</b>	<b>8</b>
2.1	Description of Test Configuration.....	8
2.2	Equipment Modifications .....	8
2.3	EUT Exercise Software .....	8
2.4	Support Equipment List and Details.....	8
2.5	External Cable List and Details.....	8
2.6	Block Diagram of Test Setup .....	9
<b>3</b>	<b>Summary of Test Results .....</b>	<b>11</b>
<b>4</b>	<b>Test Equipment List and Details .....</b>	<b>12</b>
<b>5</b>	<b>FCC §1.1307(b)(3)(i) – RF EXPOSURE.....</b>	<b>13</b>
5.1	Applicable Standard .....	13
5.2	RF Exposure Evaluation Result.....	14
<b>6</b>	<b>RSS-102 § 2.5.2 – EXEMPTION LIMITS FROM ROUTINE EVALUATION - RF EXPOSURE EVALUATION .....</b>	<b>15</b>
6.1	Applicable Standard .....	15
6.2	RF Exposure Evaluation Result.....	15
<b>7</b>	<b>FCC §15.203 &amp; RSS-GEN CLAUSE 6.8 – Antenna Requirements.....</b>	<b>16</b>
7.1	Applicable Standard .....	16
7.2	Antenna Information .....	16
<b>8</b>	<b>FCC §15.207(a) &amp; RSS-GEN CLAUSE 8.8 – AC Line Conducted Emissions .....</b>	<b>17</b>
8.1	Applicable Standard .....	17
8.2	EUT Setup .....	17
8.3	EMI Test Receiver Setup .....	18
8.4	Test Procedure.....	18
8.5	Factor & Over Limit.....	18
8.6	Test Results .....	19
<b>9</b>	<b>FCC §15.209, §15.205 , §15.249 &amp; RSS-210 ANNEX B.10, RSS-GEN CLAUSE 8.10 - Radiated Emissions.....</b>	<b>21</b>
9.1	Applicable Standard .....	21
9.2	EUT Setup .....	22
9.3	EMI Test Receiver & Spectrum Analyzer Setup.....	22
9.4	Test Procedure.....	23
9.5	Factor & Over Limit.....	23
9.6	Test Results Summary.....	23
9.7	Test Results .....	24

**10 FCC §15.215(c) & RSS-GEN CLAUSE 6.7 – 20 dB Bandwidth Testing and 99%**

**OCCUPIED BANDWIDTH .....27**

10.1 Applicable Standard .....27

10.2 Test Procedure.....28

10.3 Test Results .....28

# 1 General Information

## 1.1 Product Description for Equipment under Test (EUT)

Manufacturer	DewertOkin Technology Group Co., Ltd.
	Room 247, Floor 6, Jiaying Photovoltaic Science and Innovation Park, 1288 Kanghe Road, Xiuzhou District, Jiaying City, Zhejiang Province, China
Brand Name	OKIN
Product (Equipment)	Offline voice
Main Model Name (HVIN)	FP.08.08.01
Frequency Range	2403 ~ 2480 MHz
Modulation Technique	FSK
Power Operation	5Vdc from USB
Received Date	2022/10/20
Date of Test	2022/10/20 ~ 2022/10/24

*\*All measurement and test data in this report was gathered from production sample serial number:*

*RLK221019002-01 (Assigned by BACL, Linkou Laboratory).*

## **1.2 Objective**

This report is prepared on behalf of *DewertOkin Technology Group Co., Ltd.* in accordance with Part 2-Subpart J, and Part 15-Subparts A and C of the Federal Communication Commission's rules, and RSS-210, Issue 10, April 2020 of the Innovation, Science and Economic Development Canada, and RSS-Gen Issue 5, February 2021 Amendment 2, General Requirements for Compliance of Radio Apparatus.

## **1.3 Related Submittal(s)/Grant(s)**

N/A.

## **1.4 Test Methodology**

All measurements contained in this report were conducted with ANSI C63.10-2013, American National Standard of Procedures for Compliance Testing of Unlicensed Wireless Devices, and RSS-210, Issue 10, April 2020 Amendment of the Innovation, Science and Economic Development Canada, and RSS-Gen Issue 5, February 2021 Amendment 2, General Requirements for Compliance of Radio Apparatus.

## **1.5 Statement**

Decision Rule: No, (The test results do not include MU judgment)

It may not be duplicated or used in part without prior written consent from Bay Area Compliance Laboratories Corp. (Linkou Laboratory).

Any unauthorized alteration, forgery or falsification of the content or appearance of this document is unlawful and offenders may be prosecuted to the fullest extent of the law.

Unless otherwise stated the results shown in this test report refer only to the sample(s) tested.

The determination of the test results does not require consideration of the uncertainty of the measurement, unless the assessment is required by customer agreement, regulation or standard document specification.

Bay Area Compliance Laboratories Corp. (Linkou Laboratory) is not responsible for the authenticity of the information provided by the applicant that affects the test results.

## 1.6 Measurement Uncertainty

Parameter		Uncertainty
Emissions Bandwidth		+/- 0.94 MHz
Unwanted Emissions, conducted		+/- 0.77 dBm
Emissions, radiated	30 MHz~1GHz	+/- 5.48 dB
	1 GHz~18 GHz	+/- 5.53 dB
	18 GHz~40 GHz	+/- 4.45 dB
Temperature		+/- 1.27 °C
Humidity		+/- 3 %

## 1.7 Environmental Conditions

Test Site	Test Date	Temperature (°C)	Relative Humidity (%)	ATM Pressure (hPa)	Test Engineer
AC Line Conducted Emissions	2022/10/20	22.3	68	1010	Allen Cheng
Radiation Spurious Emissions	2022/10/24	20.0	41	1010	Alex Huang
Emission Bandwidth	2022/10/20	19.8	59	1010	Allen Cheng

## 1.8 Test Facility

The Test site used by Bay Area Compliance Laboratories Corp. (Linkou Laboratory) to collect test data is located on

No.6, Wende 2Rd., Guishan Dist., Taoyuan City 33382, Taiwan (R.O.C.).

Bay Area Compliance Laboratories Corp. (Linkou Laboratory) is accredited to ISO 17025 by Taiwan Accreditation Foundation (TAF code: 3546) and the FCC designation No.TW3546 under the Mutual Recognition Agreement (MRA) in FCC Test.

The lab has been recognized by Innovation, Science and Economic Development Canada to test to Canadian radio equipment requirements, the CAB identifier: TW3546.

## 2 System Test Configuration

### 2.1 Description of Test Configuration

The device employs 78 Channels as below table:

Channel	Frequency (MHz)	Channel	Frequency (MHz)
1	2403	40	2442
2	2404	...	...
...	...	...	...
38	2440	77	2479
39	2441	78	2480

Tested with channel 1, 40 and 78.

### 2.2 Equipment Modifications

No modification was made to the EUT.

### 2.3 EUT Exercise Software

Use the buttons to switch test channels.

Test Frequency	Low	Middle	High
Power Level Setting	Default	Default	Default

The system was configured for testing in an engineering mode, which was provided by manufacturer.

The engineering mode was configured the system transmitting with maximum power.

### 2.4 Support Equipment List and Details

Description	Manufacturer	Model Number	S/N
Adaptor	Huawei	HW-050100C01	B66517G1M04336

### 2.5 External Cable List and Details

Description	Length	From	To
USB Cable	1.5 m	EUT	Adapter



## 2.6 Block Diagram of Test Setup

See test photographs attached in setup photos for the actual connections between EUT and support equipment.

### Radiation:

Below 1GHz:

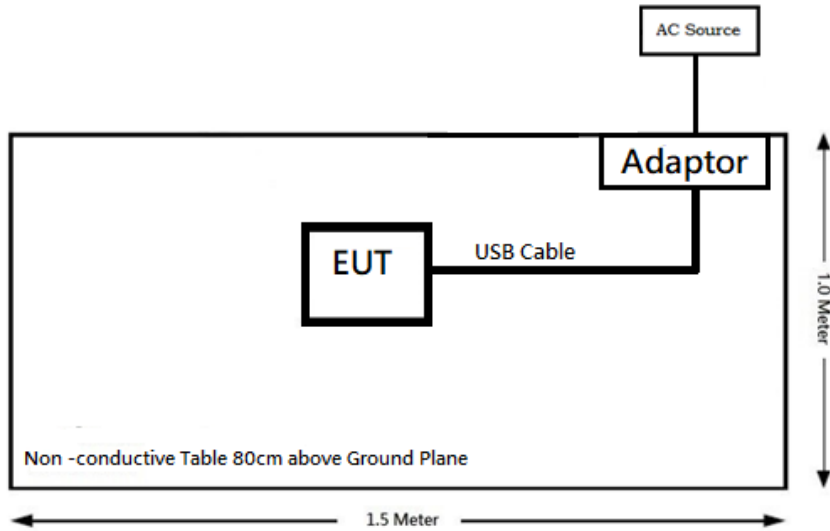

Above 1GHz:

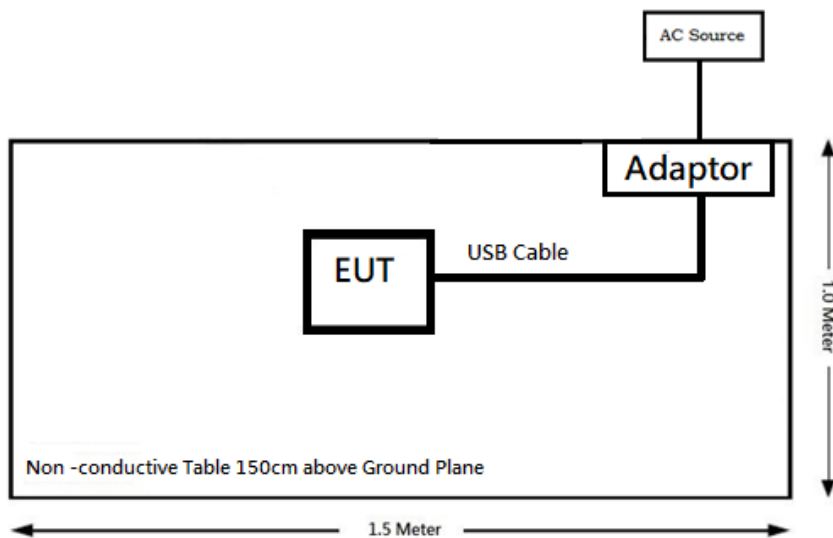

**Conduction:**

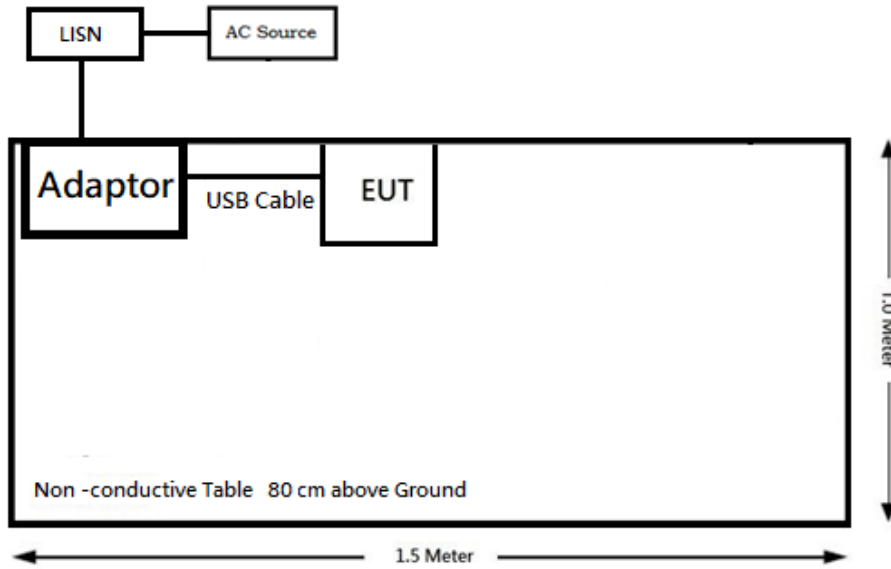

### 3 Summary of Test Results

FCC Rules	Description of Test	Results
§1.1307(b)(3)(i)	RF Exposure	Compliance
§RSS-102 Clause 2.5.2	Exemption Limits From Routine Evaluation- RF Exposure Evaluation	Compliance
§15.203 RSS-GEN Clause 6.8	Antenna Requirement	Compliance
§15.207 (a) RSS-Gen Clause 8.8	AC Line Conducted Emissions	Compliance
§15.205, §15.209, §15.249 RSS-210 Annex B.10 RSS-Gen Clause 8.10	Radiated Emissions	Compliance
§15.215 (c) RSS-Gen Clause 6.7	20 dB Emission Bandwidth 99% Occupied Bandwidth	Compliance

## 4 Test Equipment List and Details

Description	Manufacturer	Model	Serial Number	Calibration Date	Calibration Due Date
AC Line Conduction Room (CON-A)					
Two-Line-V- Network	Rohde & Schwarz	ENV216	100010	2022/09/06	2023/09/05
EMI Test Receiver	Rohde & Schwarz	ESR3	102430	2022/04/28	2023/04/27
Pulse Limiter	SCHWARZBECK	VTSD 9561-F	00432	2022/08/31	2023/08/30
RF Cable	EMCI	EMCCFD300- BM-BM-8000	180526	2022/08/16	2023/08/15
Software	AUDIX	E3 V9	E3LK-03	N.C.R	N.C.R
Radiation 3M Room (966-A)					
Bilog Antenna with 6 dB Attenuator	SUNOL SCIENCES & EMCI	JB3 & N-6-06	A111513 & AT-N0668	2022/4/11	2023/4/10
Horn Antenna	ETS-Lindgren	3115	109141	2022/7/13	2023/7/12
Horn Antenna	ETS-Lindgren	3160-09	123852	2022/7/15	2023/7/14
Preamplifier	A.H. Systems	PAM-1840VH	174	2022/3/23	2023/3/22
Preamplifier with 1W input limiter	A.H. Systems	PAM-0118P	470	2022/3/23	2023/3/22
ESR EMI Test Receiver	Rohde & Schwarz	ESR3	102448	2022/3/18	2023/3/17
Spectrum Analyzer	Rohde & Schwarz	FSV40	1321.3008K40 -101940-YY	2021/12/15	2022/12/14
Microcoax Cable	UTIFLEX	W6103	LKTE381	2022/6/30	2023/6/29
Microflex Cable	EMCI	EMC106-SM- SM-2000	180515	2022/8/5	2023/8/4
Microflex Cable	UTIFLEX	UFA210A-1- 3149-300300	MFR 64639 232490-001	2022/8/5	2023/8/4
Software	AUDIX	E3 V9	E3LK-01	N.C.R	N.C.R
Conducted Room					
Spectrum Analyzer	Rohde & Schwarz	FSV40	1321.3008K40 -101938-Gt	2022/12/07	2022/12/06
Cable	MTJ	MT40S	620620- MT40S-100	2021/12/22	2022/12/21
Power Sensor	KEYSIGHT	U2021XA	MY54080011	2022/09/01	2023/08/31

**\*Statement of Traceability:** BACL Corp. attests that all of the calibrations on the equipment items listed above were traceable to the SI System of Units via the R.O.C. Center for Measurement Standards of the Electronics Testing Center, Taiwan (ETC) or to another internationally recognized National Metrology Institute (NMI), and were compliant with the current Taiwan Accreditation Foundation (TAF) requirements

## 5 FCC §1.1307(b)(3)(i) – RF EXPOSURE

### 5.1 Applicable Standard

According to subpart 15.247(i) and subpart §1.1307(b)(3)(i), systems operating under the provisions of this section shall be operated in a manner that ensures that the public is not exposed to radio frequency energy level in excess of the Commission’s guidelines.

For single RF sources (*i.e.*, any single fixed RF source, mobile device, or portable device, as defined in paragraph (b)(2) of this section): A single RF source is exempt if:

(A) The available maximum time-averaged power is no more than 1 mW, regardless of separation distance. This exemption may not be used in conjunction with other exemption criteria other than those in paragraph (b)(3)(ii)(A) of this section. Medical implant devices may only use this exemption and that in paragraph (b)(3)(ii)(A);

(B) Or the available maximum time-averaged power or effective radiated power (ERP), whichever is greater, is less than or equal to the threshold  $P_{th}$  (mW) described in the following formula. This method shall only be used at separation distances (cm) from 0.5 centimeters to 40 centimeters and at frequencies from 0.3 GHz to 6 GHz (inclusive).  $P_{th}$  is given by:

$$P_{th} \text{ (mW)} = \begin{cases} ERP_{20 \text{ cm}}(d/20 \text{ cm})^x & d \leq 20 \text{ cm} \\ ERP_{20 \text{ cm}} & 20 \text{ cm} < d \leq 40 \text{ cm} \end{cases}$$

Where

$$x = -\log_{10} \left( \frac{60}{ERP_{20 \text{ cm}} \sqrt{f}} \right) \text{ and } f \text{ is in GHz;}$$

and

$$ERP_{20 \text{ cm}} \text{ (mW)} = \begin{cases} 2040f & 0.3 \text{ GHz} \leq f < 1.5 \text{ GHz} \\ 3060 & 1.5 \text{ GHz} \leq f \leq 6 \text{ GHz} \end{cases}$$

(C) Or using Table 1 and the minimum separation distance (R in meters) from the body of a nearby person for the frequency (f in MHz) at which the source operates, the ERP (watts) is no more than the calculated value prescribed for that frequency. For the exemption in Table 1 to apply, R must be at least  $\lambda/2\pi$ , where  $\lambda$  is the free-space operating wavelength in meters. If the ERP of a single RF source is not easily obtained, then the available maximum time-averaged power may be used in lieu of ERP if the physical dimensions of the radiating structure(s) do not exceed the electrical length of  $\lambda/4$  or if the antenna gain is less than that of a half-wave dipole (1.64 linear value).

Table 1 to § 1.1307(b)(3)(i)(C) - Single RF Sources Subject to Routine Environmental Evaluation

RF Source frequency (MHz)	Threshold ERP (watts)
0.3-1.34	1,920 R <sup>2</sup> .
1.34-30	3,450 R <sup>2</sup> /f <sup>2</sup> .
30-300	3.83 R <sup>2</sup> .
300-1,500	0.0128 R <sup>2</sup> f.
1,500-100,000	19.2R <sup>2</sup> .

### 5.2 RF Exposure Evaluation Result

Calculate the EIRP from the radiated field strength in the far field using Equation

$$EIRP = E_{Meas} + 20 \log(d_{Meas}) - 104.7$$

$$EIRP = 78.34 \text{ dB}\mu\text{V/m} - 95.2 = -16.86 \text{ dBm}$$

$$EIRP \text{ Tune-up power} = -16.5 \text{ dBm}$$

#### Project info

Band	Freq (MHz)	EIRP Tune-up power (dBm)	Distances (mm)	EIRP Tune-up power (mW)	ERP (dBm)	ERP (mW)
SRD 2.4G	2480	-16.5	200	0.02	-18.65	0.01

#### Option A

The available maximum time-averaged power is no more than 1 mW

Band	Freq (MHz)	Result Option A
SRD 2.4G	2480	exempt

§ 1.1307(b)(3)(i)(A) method is applicable.

**Result:** The device meets the exemption requirement.

## 6 RSS-102 § 2.5.2 – EXEMPTION LIMITS FROM ROUTINE EVALUATION - RF EXPOSURE EVALUATION

### 6.1 Applicable Standard

RF exposure evaluation is required if the separation distance between the user and/or bystander and the device's radiating element is greater than 20 cm, except when the device operates as follows:

- below 20 MHz and the source-based, time-averaged maximum e.i.r.p. of the device is equal to or less than 1 W (adjusted for tune-up tolerance);
- at or above 20 MHz and below 48 MHz and the source-based, time-averaged maximum e.i.r.p. of the device is equal to or less than  $4.49/f^{0.5}$  W (adjusted for tune-up tolerance), where  $f$  is in MHz;
- at or above 48 MHz and below 300 MHz and the source-based, time-averaged maximum e.i.r.p. of the device is equal to or less than 0.6 W (adjusted for tune-up tolerance);
- at or above 300 MHz and below 6 GHz and the source-based, time-averaged maximum e.i.r.p. of the device is equal to or less than  $1.31 \times 10^{-2} f^{0.6834}$  W (adjusted for tune-up tolerance), where  $f$  is in MHz;
- at or above 6 GHz and the source-based, time-averaged maximum e.i.r.p. of the device is equal to or less than 5 W (adjusted for tune-up tolerance).

In these cases, the information contained in the RF exposure technical brief may be limited to information that demonstrates how the e.i.r.p. was derived.

### 6.2 RF Exposure Evaluation Result

$$\text{EIRP} = E_{\text{Meas}} + 20 \log(d_{\text{Meas}}) - 104.7$$

$$\text{EIRP} = 78.34 \text{ dB}\mu\text{V/m} - 95.2 = -16.86 \text{ dBm}$$

$$\text{EIRP Tune-up power} = -16.5 \text{ dBm} = 0.02 \text{ mW}$$

Exemption from Routine Evaluation Limit is:

$$1.31 \times 10^{-2} f^{0.6834} = 1.31 \times 10^{-2} \times 2403^{0.6834} = 2.68 \text{ W} > 0.02 \text{ mW}$$

**Result:** The device meets the exemption requirement.

## 7 FCC §15.203 & RSS-GEN CLAUSE 6.8 – Antenna Requirements

### 7.1 Applicable Standard

For intentional device, according to §15.203, an intentional radiator shall be designed to ensure that no antenna other than that furnished by the responsible party shall be used.

According to RSS-Gen §6.8, The applicant for equipment certification shall provide a list of all antenna types that may be used with the transmitter, where applicable (i.e. for transmitters with detachable antenna), indicating the maximum permissible antenna gain (in dBi) and the required impedance for each antenna. The test report shall demonstrate the compliance of the transmitter with the limit for maximum equivalent isotropically radiated power (e.i.r.p.) specified in the applicable RSS, when the transmitter is equipped with any antenna type, selected from this list.

For expediting the testing, measurements may be performed using only the antenna with highest gain of each combination of transmitter and antenna type, with the transmitter output power set at the maximum level. However, the transmitter shall comply with the applicable requirements under all operational conditions and when in combination with any type of antenna from the list provided in the test report (and in the notice to be included in the user manual, provided below).

When measurements at the antenna port are used to determine the RF output power, the effective gain of the device's antenna shall be stated, based on a measurement or on data from the antenna's manufacturer. The test report shall state the RF power, output power setting and spurious emission measurements with each antenna type that is used with the transmitter being tested. For licence-exempt equipment with detachable antennas, the user manual shall also contain the following notice in a conspicuous location:

This radio transmitter [enter the device's ISED certification number] has been approved by Innovation, Science and Economic Development Canada to operate with the antenna types listed below, with the maximum permissible gain indicated. Antenna types not included in this list that have a gain greater than the maximum gain indicated for any type listed are strictly prohibited for use with this device.

Immediately following the above notice, the manufacturer shall provide a list of all antenna types which can be used with the transmitter, indicating the maximum permissible antenna gain (in dBi) and the required impedance for each antenna type.

### 7.2 Antenna Information

Model	Type	Antenna Gain	Input impedance
N/A	PIFA Antenna	1 dBi	50Ω

**Result:** Compliance.



## 8 FCC §15.207(a) & RSS-GEN CLAUSE 8.8 – AC Line Conducted Emissions

### 8.1 Applicable Standard

According to §15.207 for an intentional radiator that is designed to be connected to the public utility (AC) power line, the radio frequency voltage that is conducted back onto the AC power line on any frequency or frequencies within the band 150 kHz to 30 MHz shall not exceed the limits in the following table, as measured using a 50 μH/50 ohms line impedance stabilization network (LISN). Compliance with the provisions of this paragraph shall be based on the measurement of the radio frequency voltage between each power line and ground at the power terminal. The lower limit applies at the boundary between the frequencies ranges.

Unless stated otherwise in the applicable RSS, for radio apparatus that are designed to be connected to the public utility AC power network, the radio frequency voltage that is conducted back onto the AC power line on any frequency or frequencies within the range 150 kHz to 30 MHz shall not exceed the limits in table 4, as measured using a 50 μH / 50 Ω line impedance stabilization network. This requirement applies for the radio frequency voltage measured between each power line and the ground terminal of each AC power-line mains cable of the EUT.

For an EUT that connects to the AC power lines indirectly, through another device, the requirement for compliance with the limits in table 4 shall apply at the terminals of the AC power-line mains cable of a representative support device, while it provides power to the EUT. The lower limit applies at the boundary between the frequency ranges. The device used to power the EUT shall be representative of typical applications.

Frequency of Emission (MHz)	Conducted Limit (dBuV)	
	Quasi-Peak	Average
0.15-0.5	66 to 56 <sup>Note 1</sup>	56 to 46 <sup>Note 1</sup>
0.5-5	56	46
5-30	60	50

Note 1: Decreases with the logarithm of the frequency.

### 8.2 EUT Setup

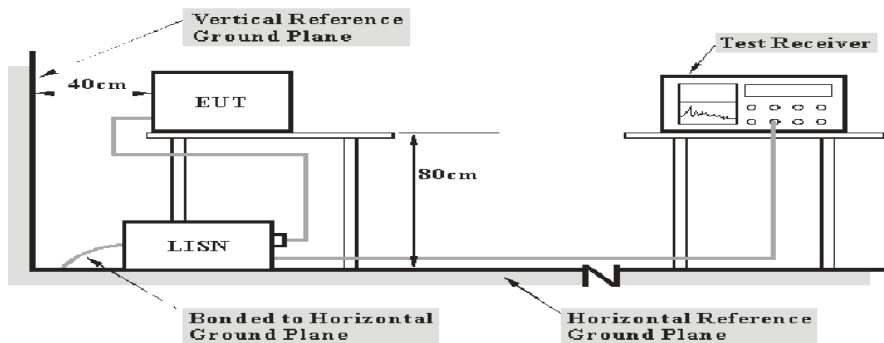

- Note: 1. Support units were connected to second LISN.  
 2. Both of LISNs (AMN) 80 cm from EUT and at the least 80 cm from other units and other metal planes support units.

The setup of EUT is according with per ANSI C63.10-2013 measurement procedure. The specification used was with the FCC Part 15.207 and RSS-GEN limits.

### 8.3 EMI Test Receiver Setup

The EMI test receiver was set to investigate the spectrum from 150kHz to 30MHz.

During the conducted emission test, the EMI test receiver was set with the following configurations

Frequency Range	IF B/W
150kHz – 30MHz	9kHz

### 8.4 Test Procedure

During the conducted emission test, the adapter was connected to the outlet of the LISN.

Maximizing procedure was performed on the six (6) highest emissions of the EUT.

All data was recorded in the Quasi-peak and average detection mode.

### 8.5 Factor & Over Limit

The factor is calculated by adding LISN/ISN VDF (Voltage Division Factor), Cable Loss and Transient Limiter Attenuation. The basic equation is as follows:

$$\text{Factor} = \text{LISN VDF} + \text{Cable Loss} + \text{Transient Limiter Attenuation}$$

The “Over Limit” column of the following data tables indicates the degree of compliance with the applicable limit line. For example, an over limit of -7 dB means the emission is 7 dB below the limit line. The equation for Over Limit calculation is as follows:

$$\text{Over Limit} = \text{Level} - \text{Limit Line}$$

### 8.6 Test Results

Test Mode: Transmitting

Main: AC120 V, 60 Hz, Line

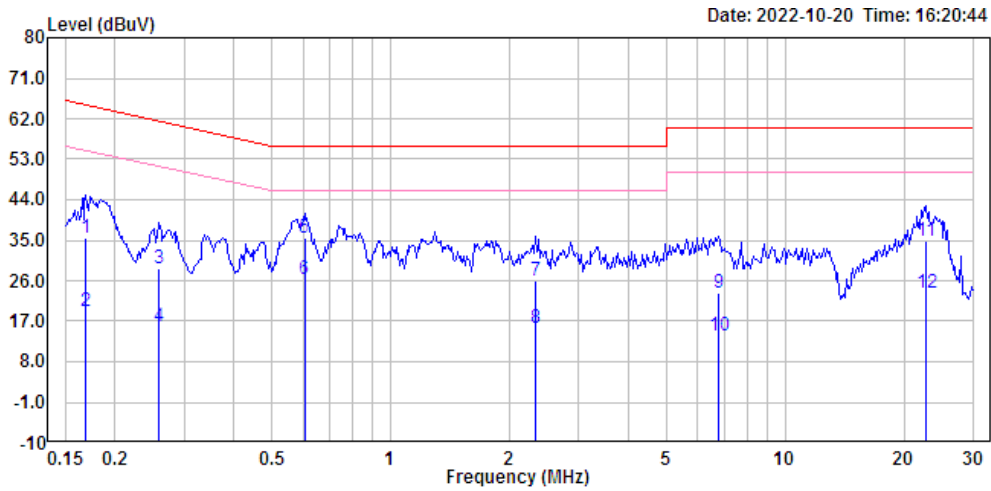

Date: 2022-10-20 Time: 16:20:44

Site : Conduction  
 Condition: Line  
 Job No : RLK221019002  
 Company : DewertOkin Technology Group Co., Ltd.  
 Mode : SRD  
 Power : 120V/60Hz  
 Note : FP.08.08.01  
 Temp.(°C)/Hum.(%RH): 22.3/68  
 Test engineer : Allen

	Read	Limit	Over				
Freq	Level	Level	Factor	Line	Limit	Remark	
MHz	dBuV	dBuV	dB	dBuV	dB		
1	0.169	15.50	35.34	19.84	65.01	-29.67	QP
2	0.169	-0.57	19.27	19.84	55.01	-35.74	Average
3	0.258	8.71	28.56	19.85	61.50	-32.94	QP
4	0.258	-4.17	15.68	19.85	51.50	-35.82	Average
5 *	0.605	15.73	35.61	19.88	56.00	-20.39	QP
6 *	0.605	6.57	26.45	19.88	46.00	-19.55	Average
7	2.325	5.91	25.84	19.93	56.00	-30.16	QP
8	2.325	-4.56	15.37	19.93	46.00	-30.63	Average
9	6.762	3.43	23.45	20.02	60.00	-36.55	QP
10	6.762	-6.16	13.86	20.02	50.00	-36.14	Average
11	22.699	14.66	34.91	20.25	60.00	-25.09	QP
12	22.699	3.02	23.27	20.25	50.00	-26.73	Average

Note:  
 Level = Read Level + Factor  
 Over Limit = Level - Limit Line  
 Factor = (LISN, ISN, PLC or current probe) Factor + Cable Loss + Attenuator

Main: AC120 V, 60 Hz, Neutral

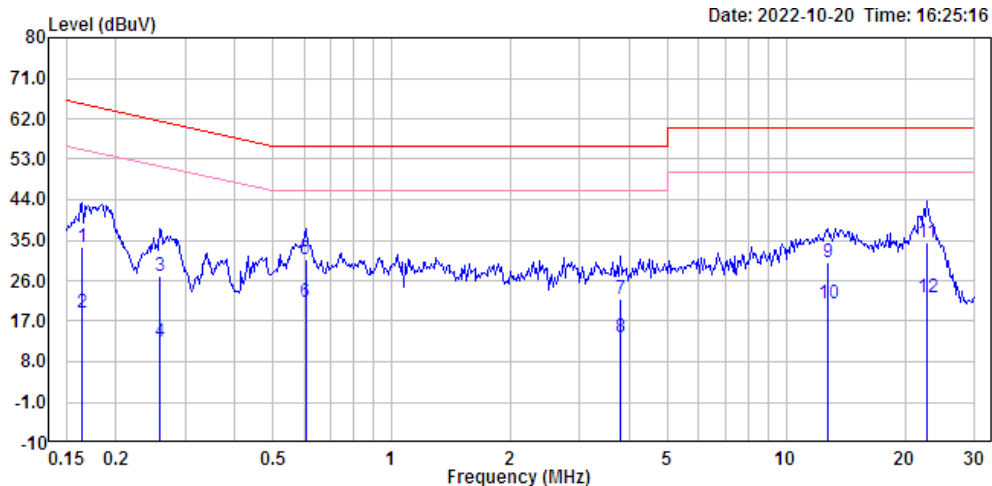

Site : Conduction  
 Condition: Neutral  
 Job No : RLK221019002  
 Company : DewertOkin Technology Group Co., Ltd.  
 Mode : SRD  
 Power : 120V/60Hz  
 Note : FP.08.08.01  
 Temp.(°C)/Hum.(%RH): 22.3/68  
 Test engineer : Allen

	Read Freq	Read Level	Level	Factor	Limit Line	Over Limit	Remark
	MHz	dBuV	dBuV	dB	dBuV	dB	
1	0.164	13.61	33.45	19.84	65.27	-31.82	QP
2	0.164	-0.99	18.85	19.84	55.27	-36.42	Average
3	0.258	7.28	27.13	19.85	61.50	-34.37	QP
4	0.258	-7.45	12.40	19.85	51.50	-39.10	Average
5 *	0.605	10.81	30.69	19.88	56.00	-25.31	QP
6 *	0.605	1.26	21.14	19.88	46.00	-24.86	Average
7	3.810	1.91	21.87	19.96	56.00	-34.13	QP
8	3.810	-6.41	13.55	19.96	46.00	-32.45	Average
9	12.790	9.88	30.04	20.16	60.00	-29.96	QP
10	12.790	0.81	20.97	20.16	50.00	-29.03	Average
11	22.699	14.14	34.46	20.32	60.00	-25.54	QP
12	22.699	1.85	22.17	20.32	50.00	-27.83	Average

Note:  
 Level = Read Level + Factor  
 Over Limit = Level - Limit Line  
 Factor = (LISN, ISN, PLC or current probe) Factor + Cable Loss + Attenuator

## 9 FCC §15.209, §15.205 , §15.249 & RSS-210 ANNEX B.10, RSS-GEN CLAUSE 8.10 - Radiated Emissions

### 9.1 Applicable Standard

As per FCC§15.249 (a), except as provided in paragraph (b) of this section, the field strength of emissions from intentional radiators operated within these frequency bands shall comply with the following:

Fundamental frequency	Field strength of fundamental (millivolts/meter)	Field strength of harmonics (microvolts/meter)
920-928 MHz	50	500
2400-2483.5 MHz	50	500
5725-5875 MHz	50	500
24.0-24.25 GHz	250	2500

As per FCC§15.249 (c), Field strength limits are specified at a distance of 3 meters.

(d) Emissions radiated outside of the specified frequency bands, except for harmonics, shall be attenuated by at least 50 dB below the level of the fundamental or to the general radiated emission limits in §15.209, whichever is the lesser attenuation.

According to RSS-210 Issue 10 Clause Annex B B.10 (a): The field strength of fundamental and harmonic emissions, measured at 3 m, shall not exceed 50 mV/m and 0.5 mV/m respectively.

According to RSS-210 Issue 10 Clause Annex B B.10 (b): Emissions radiated outside of the specified frequency bands, except for harmonic emissions, shall be attenuated by at least 50 dB below the level of the fundamental emissions or to the general field strength limits listed in RSS-GEN Issue 5, whichever is less stringent.

Field strength limits at various frequencies		
Fundamental frequency	Field strength (mV/m)	
	Fundamental emissions	Harmonic emissions
920-928 MHz	50	0.5
2400-2483.5 MHz	50	0.5
5725-5875 MHz	50	0.5
24.0-24.25 GHz	250	2.5

As per RSS-210 Issue 10 Clause Annex B B.10, Field strength limits are specified at a distance of 3 meters.

### 9.2 EUT Setup

Below 1 GHz:

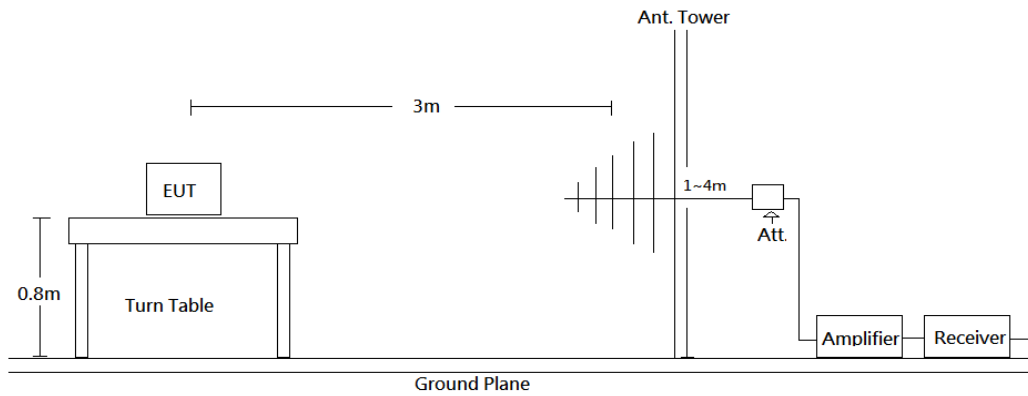

Above 1 GHz:

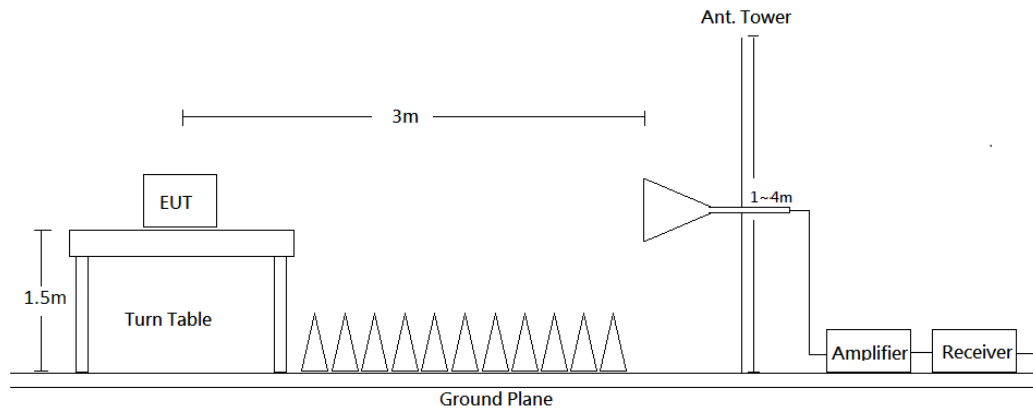

Radiated emission tests were performed in the 3 meters chamber test site, using the setup accordance with the ANSI C63.10-2013. The specification used was the FCC 15.205, FCC 15.209, FCC 15.249 and RSS-GEN, RSS-210 limits.

### 9.3 EMI Test Receiver & Spectrum Analyzer Setup

The system was investigated from 30 MHz to 26.5 GHz. During the radiated emission test, the EMI test receiver was set with the following configurations:

Frequency Range	RBW	VBW	Measurement method
30-1000 MHz	120 kHz	300 kHz	QP
Above 1 GHz	1 MHz	3 MHz	PK
Above 1 GHz	1 MHz	10 Hz	AVG

## 9.4 Test Procedure

Maximizing procedure was performed on the highest emissions to ensure that the EUT complied with all installation combinations.

All data was recorded in the Quasi-peak detector mode from 30 MHz to 1 GHz and PK and average detector modes for frequencies above 1 GHz.

## 9.5 Factor & Over Limit

The Factor is calculated by adding the Antenna Factor and Cable Loss, and Amplifier Gain from the Meter Reading. The basic equation is as follows:

$$\text{Factor} = \text{Antenna Factor} + \text{Cable Loss} + \text{Amplifier Gain}$$

The “Over Limit” column of the following data tables indicates the degree of compliance with the applicable limit line. For example, The Over Limit of -7 dB means the emission is 7 dB below the limit line. The equation for margin calculation is as follows:

$$\text{Over Limit} = \text{Level} - \text{Limit Line}$$

## 9.6 Test Results Summary

According to the data in the following table, the EUT complied with the FCC 15.205, FCC 15.209, FCC 15.249 and RSS-210, RSS-Gen.

### 9.7 Test Results

Test Mode: Transmitting

(Pre-scan with three orthogonal axis, and worse case as Z axis.)

(worst case is Low channel)

30MHz-1GHz:

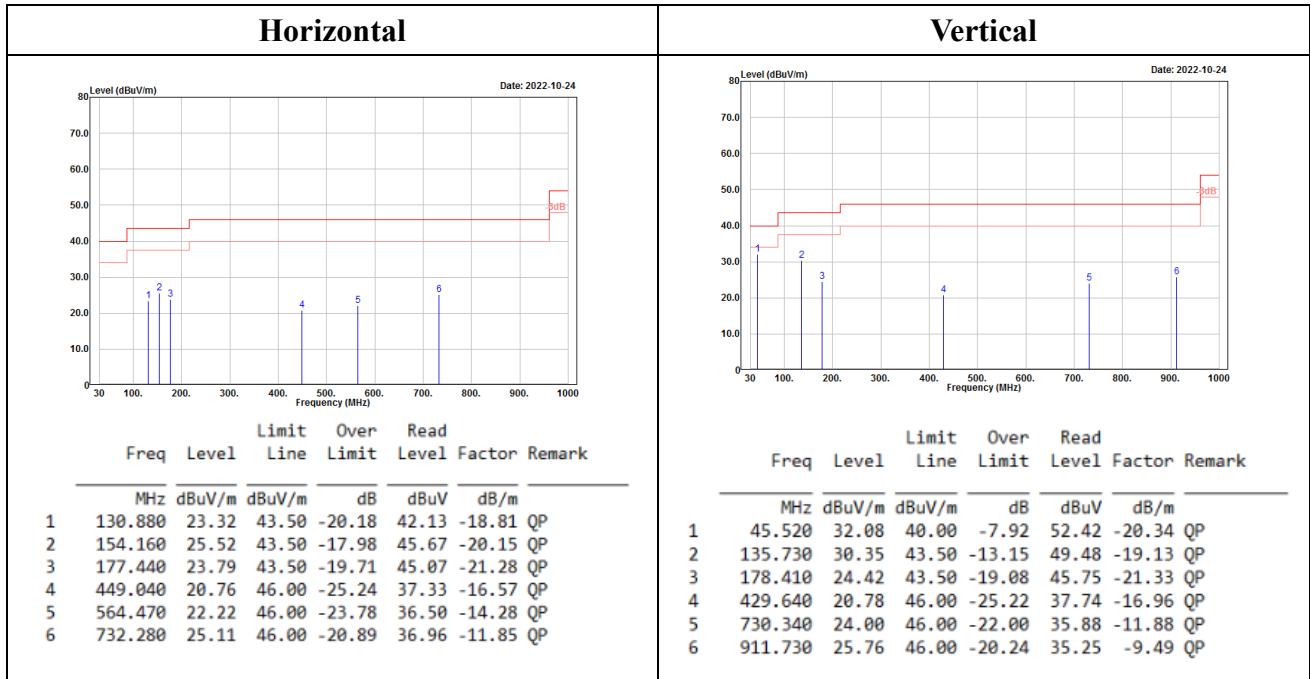

Level = Read Level + Factor

Over Limit = Level - Limit Line

Factor = Antenna Factor + Cable Loss - Amplifier Gain

Spurious emissions more than 20 dB below the limit were not reported.



Fundamental:

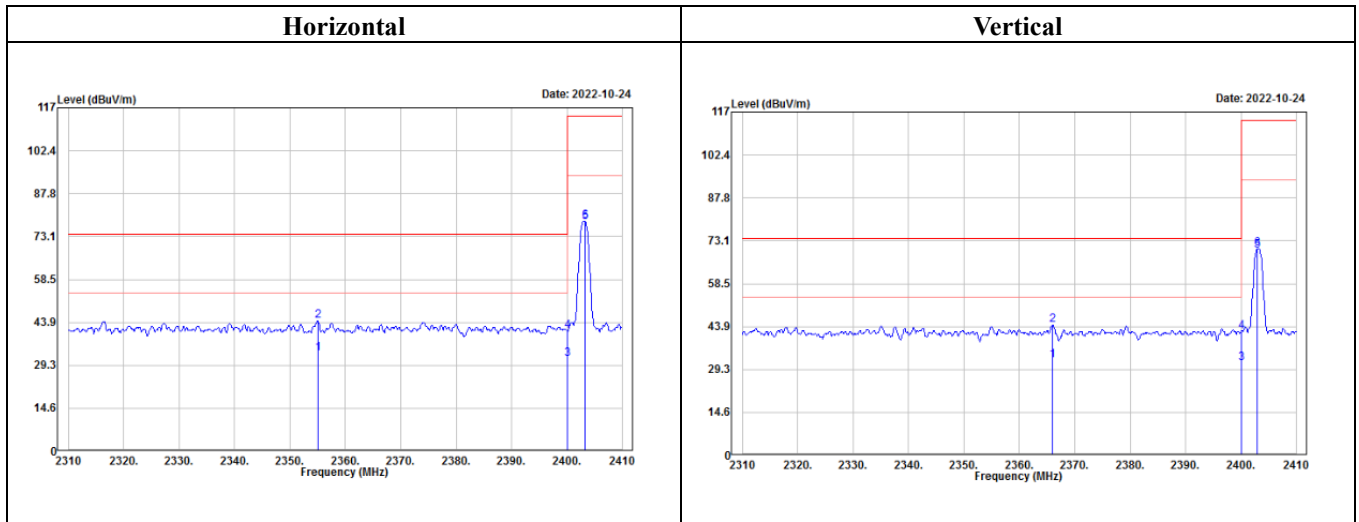

1GHz-18GHz:

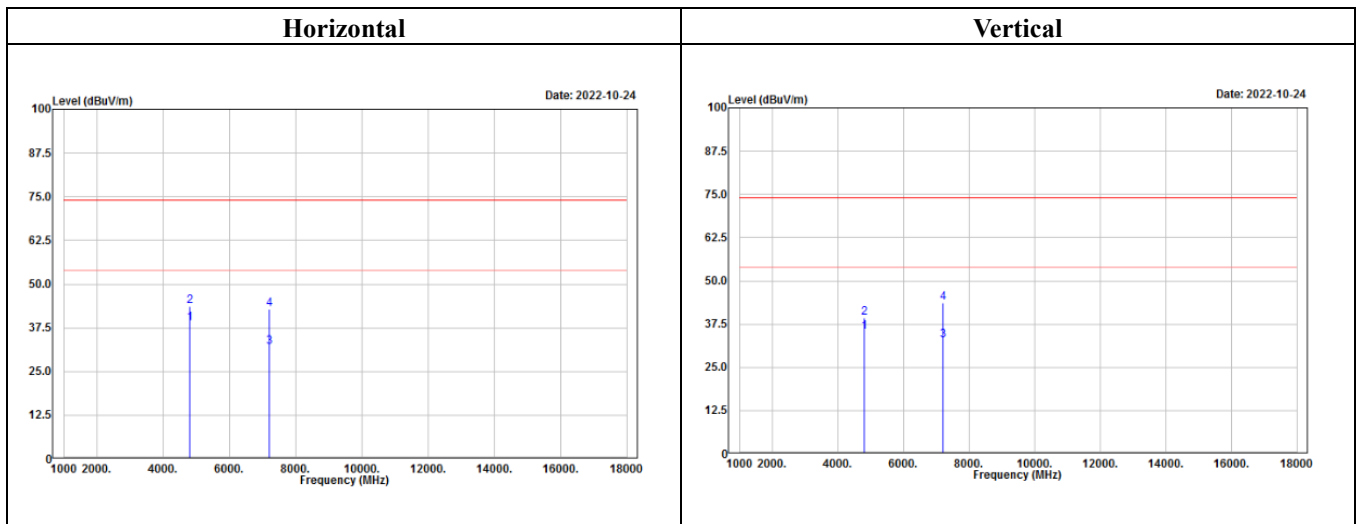

18GHz-26.5GHz:

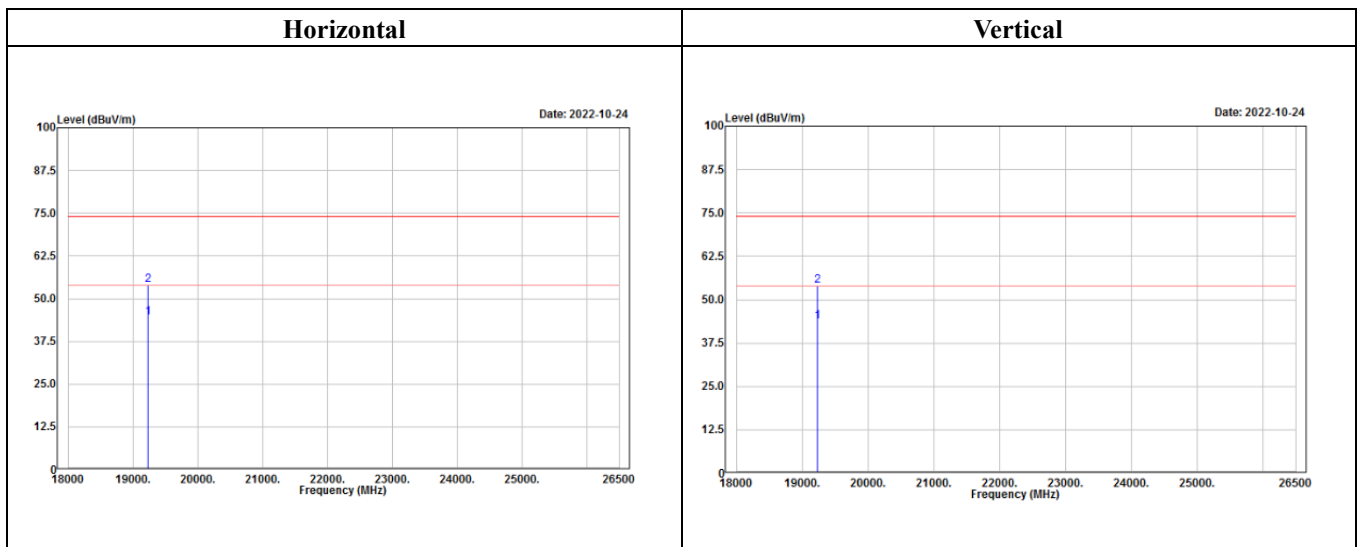

**Above 1GHz**

Low channel															
Horizontal							Vertical								
Freq	Level	Limit Line	Over Limit	Read Level	Factor	Remark	Freq	Level	Limit Line	Over Limit	Read Level	Factor	Remark		
MHz	dBuV/m	dBuV/m	dB	dBuV	dB/m		MHz	dBuV/m	dBuV/m	dB	dBuV	dB/m			
1	2355.000	33.41	54.00	-20.59	42.83	-9.42	Average	1	2366.000	32.31	54.00	-21.69	41.69	-9.38	Average
2	2355.000	44.26	74.00	-29.74	53.68	-9.42	Peak	2	2366.000	44.45	74.00	-29.55	53.83	-9.38	Peak
3	2400.000	31.46	54.00	-22.54	40.71	-9.25	Average	3	2400.000	31.48	54.00	-22.52	40.73	-9.25	Average
4	2400.000	41.03	74.00	-32.97	50.28	-9.25	Peak	4	2400.000	42.24	74.00	-31.76	51.49	-9.25	Peak
5	2403.300	77.87	94.00	-16.13	87.10	-9.23	Average	5	2403.000	69.73	94.00	-24.27	78.96	-9.23	Average
6	2403.300	78.34	114.00	-35.66	87.57	-9.23	Peak	6	2403.000	70.41	114.00	-43.59	79.64	-9.23	Peak
1	4806.000	38.62	54.00	-15.38	41.02	-2.40	Average	1	4806.000	35.16	54.00	-18.84	37.56	-2.40	Average
2	4806.000	43.56	74.00	-30.44	45.96	-2.40	Peak	2	4806.000	39.33	74.00	-34.67	41.73	-2.40	Peak
3	7209.000	31.91	54.00	-22.09	29.01	2.90	Average	3	7209.000	32.75	54.00	-21.25	29.85	2.90	Average
4	7209.000	42.78	74.00	-31.22	39.88	2.90	Peak	4	7209.000	43.71	74.00	-30.29	40.81	2.90	Peak
Middle channel															
Horizontal							Vertical								
Freq	Level	Limit Line	Over Limit	Read Level	Factor	Remark	Freq	Level	Limit Line	Over Limit	Read Level	Factor	Remark		
MHz	dBuV/m	dBuV/m	dB	dBuV	dB/m		MHz	dBuV/m	dBuV/m	dB	dBuV	dB/m			
1	2442.000	77.53	94.00	-16.47	86.61	-9.08	Average	1	2442.000	74.28	94.00	-19.72	83.36	-9.08	Average
2	2442.000	77.97	114.00	-36.03	87.05	-9.08	Peak	2	2442.000	74.81	114.00	-39.19	83.89	-9.08	Peak
1	4884.000	38.95	54.00	-15.05	41.14	-2.19	Average	1	4884.000	36.68	54.00	-17.32	38.87	-2.19	Average
2	4884.000	44.21	74.00	-29.79	46.40	-2.19	Peak	2	4884.000	40.56	74.00	-33.44	42.75	-2.19	Peak
3	7326.000	32.93	54.00	-21.07	29.65	3.28	Average	3	7326.000	32.85	54.00	-21.15	29.57	3.28	Average
4	7326.000	44.12	74.00	-29.88	40.84	3.28	Peak	4	7326.000	44.87	74.00	-29.13	41.59	3.28	Peak
High channel															
Horizontal							Vertical								
Freq	Level	Limit Line	Over Limit	Read Level	Factor	Remark	Freq	Level	Limit Line	Over Limit	Read Level	Factor	Remark		
MHz	dBuV/m	dBuV/m	dB	dBuV	dB/m		MHz	dBuV/m	dBuV/m	dB	dBuV	dB/m			
1	2480.000	75.86	94.00	-18.14	84.79	-8.93	Average	1	2480.000	67.00	94.00	-27.00	75.93	-8.93	Average
2	2480.000	76.46	114.00	-37.54	85.39	-8.93	Peak	2	2480.000	73.07	114.00	-40.93	82.00	-8.93	Peak
3	2489.200	32.15	54.00	-21.85	41.04	-8.89	Average	3	2494.480	32.22	54.00	-21.78	41.09	-8.87	Average
4	2489.200	44.46	74.00	-29.54	53.35	-8.89	Peak	4	2494.480	44.84	74.00	-29.16	53.71	-8.87	Peak
1	4960.000	40.32	54.00	-13.68	42.29	-1.97	Average	1	4960.000	35.09	54.00	-18.91	37.06	-1.97	Average
2	4960.000	45.04	74.00	-28.96	47.01	-1.97	Peak	2	4960.000	41.76	74.00	-32.24	43.73	-1.97	Peak
3	7440.000	32.42	54.00	-21.58	28.85	3.57	Average	3	7440.000	33.20	54.00	-20.80	29.63	3.57	Average
4	7440.000	44.09	74.00	-29.91	40.52	3.57	Peak	4	7440.000	44.53	74.00	-29.47	40.96	3.57	Peak

Level = Read Level + Factor

Over Limit = Level - Limit Line

Factor = Antenna Factor + Cable Loss - Amplifier Gain

Spurious emissions more than 20 dB below the limit were not reported.

## **10 FCC §15.215(c) & RSS-GEN CLAUSE 6.7 – 20 dB Bandwidth Testing and 99% OCCUPIED BANDWIDTH**

### **10.1 Applicable Standard**

Intentional radiators operating under the alternative provisions to the general emission limits, as contained in §15.217 through 15.257 and in Subpart E of this part, must be designed to ensure that the 20 dB bandwidth of the emission, or whatever bandwidth may otherwise be specified in the specific rule section under which the equipment operates, is contained within the frequency band designated in the rule section under which the equipment is operated.

According to RSS-Gen Clause 6.7:

The occupied bandwidth or the “99% emission bandwidth” is defined as the frequency range between two points, one above and the other below the carrier frequency, within which 99% of the total transmitted power of the fundamental transmitted emission is contained. The occupied bandwidth shall be reported for all equipment in addition to the specified bandwidth required in the applicable RSSs.

In some cases, the “x dB bandwidth” is required, which is defined as the frequency range between two points, one at the lowest frequency below and one at the highest frequency above the carrier frequency, at which the maximum power level of the transmitted emission is attenuated x dB below the maximum inband power level of the modulated signal, where the two points are on the outskirts of the in-band emission.

The following conditions shall be observed for measuring the occupied bandwidth and x dB bandwidth: The transmitter shall be operated at its maximum carrier power measured under normal test conditions.

The span of the spectrum analyzer shall be set large enough to capture all products of the modulation process, including the emission skirts, around the carrier frequency, but small enough to avoid having other emissions (e.g. on adjacent channels) within the span. The detector of the spectrum analyzer shall be set to “Sample” .

However, a peak, or peak hold,

may be used in place of the sampling detector since this usually produces a wider bandwidth than the actual bandwidth (worst-case measurement). Use of a peak hold (or “Max Hold”) may be necessary to determine the occupied / x dB bandwidth if the device is not transmitting continuously.

The resolution bandwidth (RBW) shall be in the range of 1% to 5% of the actual occupied / x dB bandwidth and the video bandwidth (VBW) shall not be smaller than three times the RBW value. Video averaging is not permitted.

Note: It may be necessary to repeat the measurement a few times until the RBW and VBW are in compliance with the above requirement.

## 10.2 Test Procedure

20dB bandwidth test:

1. Check the calibration of the measuring instrument using either an internal calibrator or a known signal from an external generator.
2. Position the EUT without connection to measurement instrument. Turn on the EUT and connect it to measurement instrument. Then set it to any one convenient frequency within its operating range. Set a reference level on the measuring instrument equal to the highest peak value.
3. Measure the frequency difference of two frequencies that were attenuated 20 dB from the reference level. Record the frequency difference as the emission bandwidth.
4. Repeat above procedures until all frequencies measured were complete.

For the 99% emission bandwidth, the trace data points are recovered and directly summed in linear power level terms. The recovered amplitude data points, beginning at the lowest frequency, are placed in a running sum until 0.5% of the total is reached, and that frequency recorded. The process is repeated for the highest frequency data points (starting at the highest frequency, at the right side of the span, and going down in frequency). This frequency is then recorded. The difference between the two recorded frequencies is the occupied bandwidth (or the 99% emission bandwidth).

## 10.3 Test Results

Channel	Frequency (MHz)	20 dB Emission Bandwidth (MHz)	99% Occupied Bandwidth (MHz)
Low	2403	1.14	0.95
Middle	2442	1.13	0.93
High	2480	1.14	0.94

Please refer to the following plots

**20 dB Emission Bandwidth**

**Low Channel**

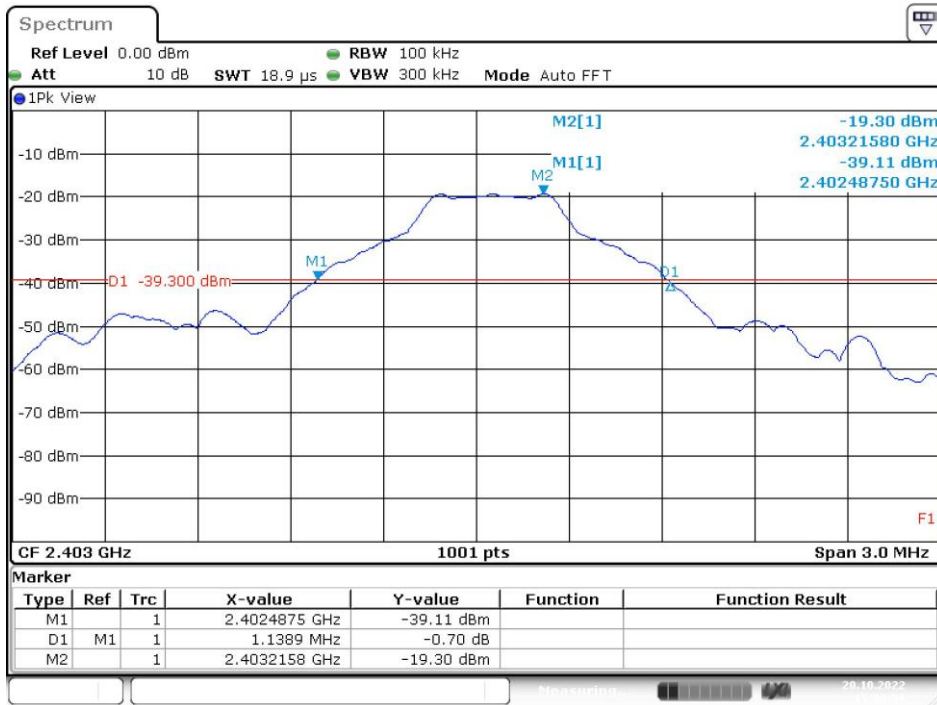

Date: 20.OCT.2022 15:00:59

**Middle Channel**

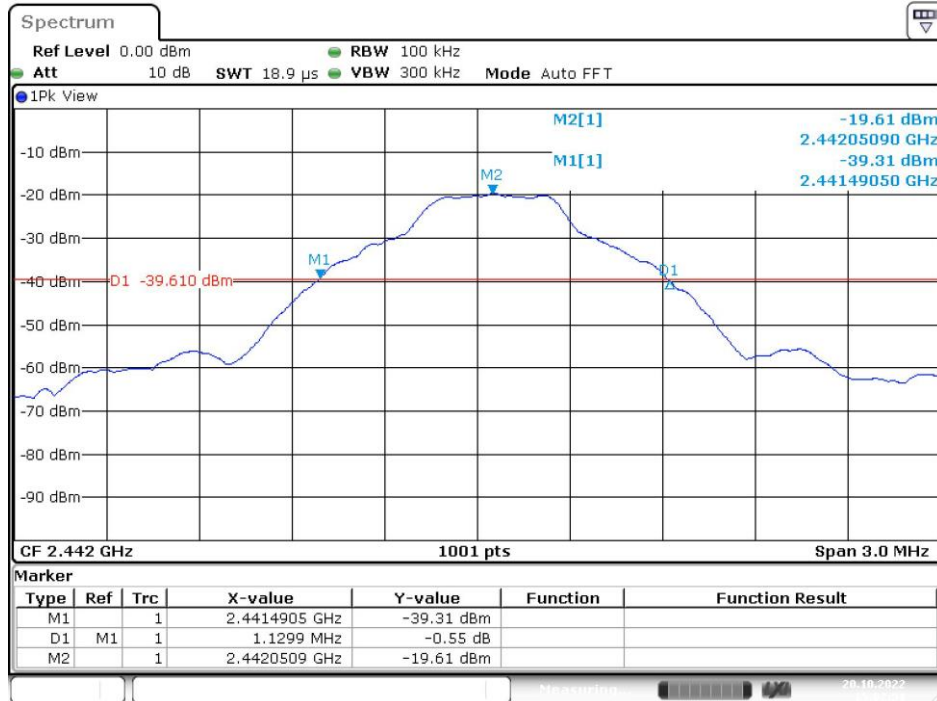

Date: 20.OCT.2022 15:02:51

### High Channel

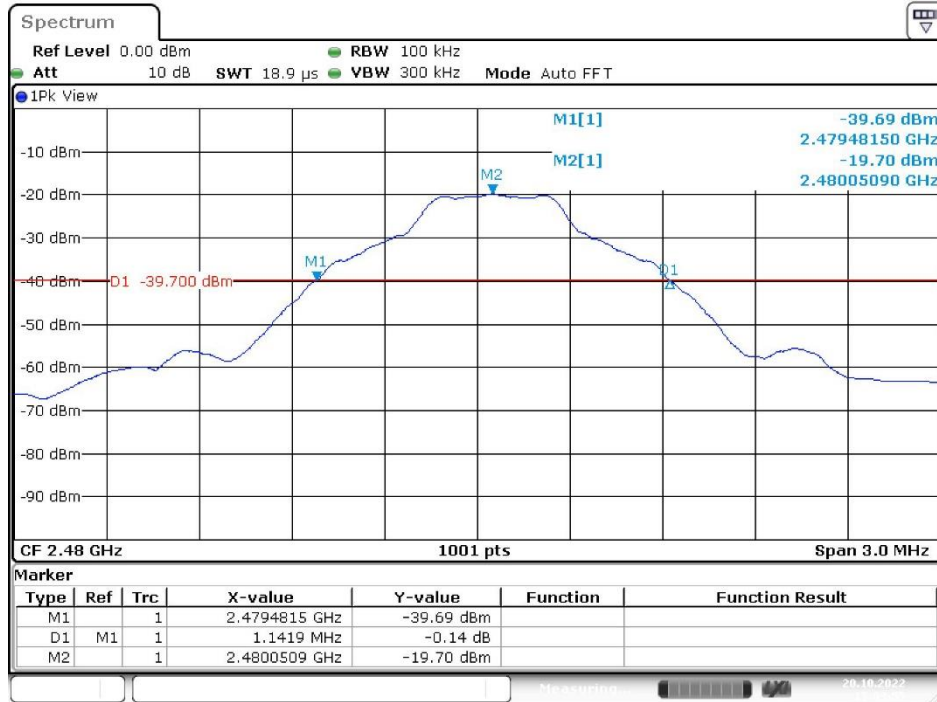

### 99% Occupied Bandwidth

### Low Channel

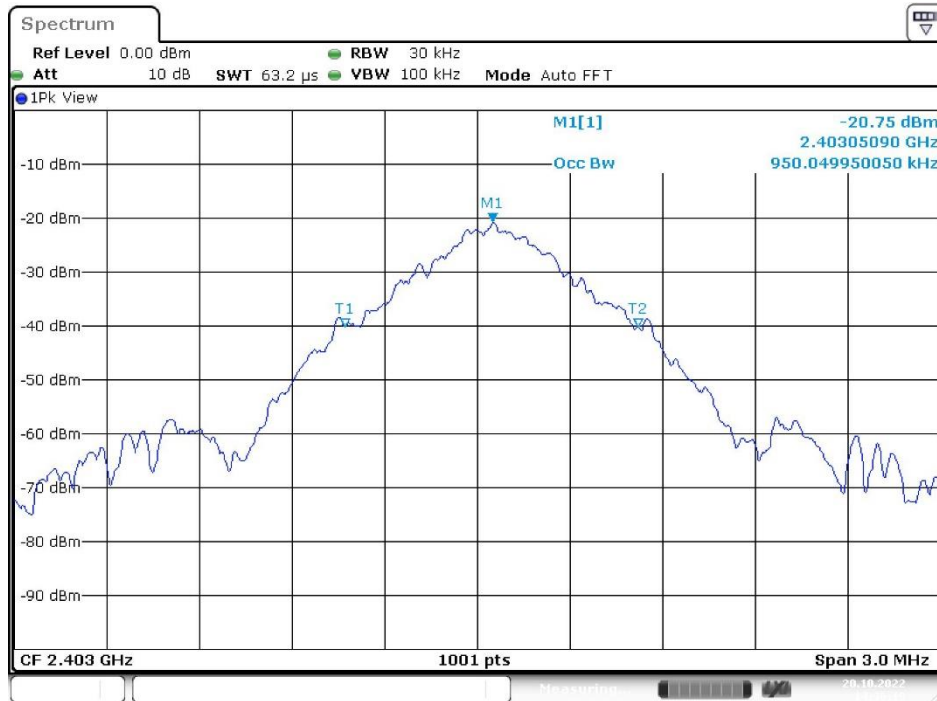

### Middle Channel

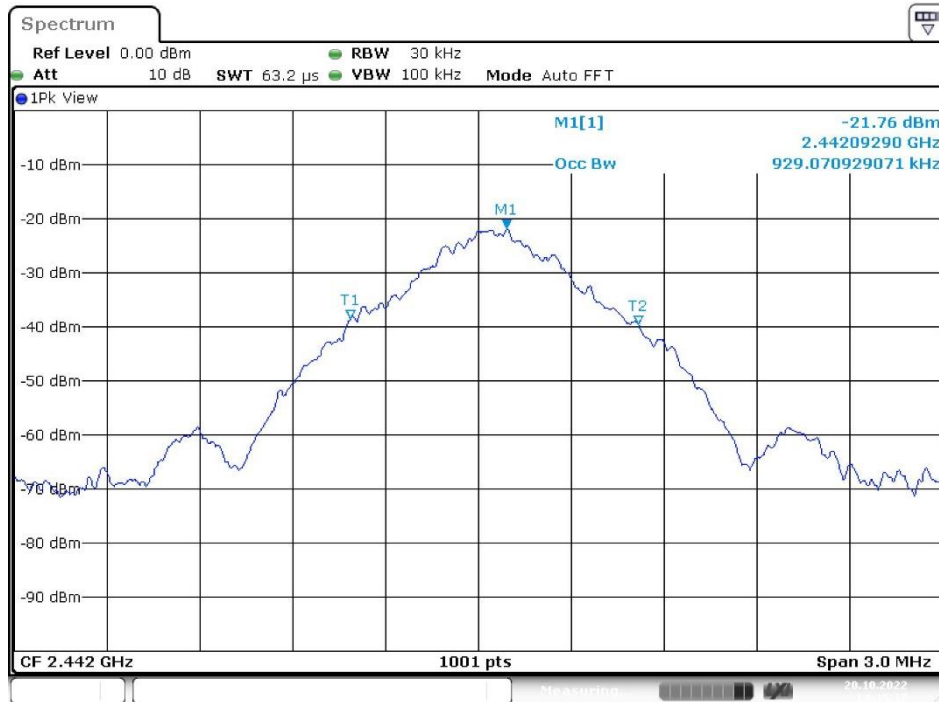

Date: 20.OCT.2022 14:45:17

### High Channel

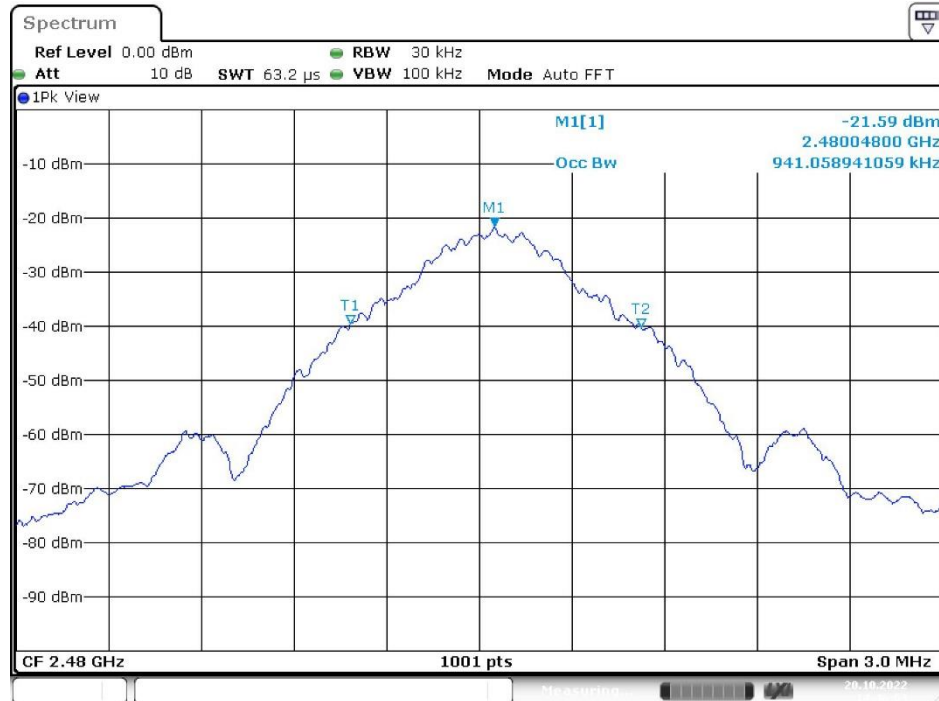

Date: 20.OCT.2022 14:46:03

\*\*\*\*\* END OF REPORT \*\*\*\*\*