

FCC Part 15.249
RSS-GEN ISSUE 5 February 2021 AMENDMENT 2
RSS-210, ISSUE 10, April 2020 AMENDMENT
TEST REPORT

For

DewertOkin Technology Group Co., Ltd.

Room 247, Floor 6, Jiaxing Photovoltaic Science and Innovation Park, 1288 Kanghe Road, Xiuzhou District, Jiaxing City, Zhejiang Province, China

FCC ID: 2AVJ8-CB2454
IC: 25804-CB2454

Report Type:
Original Report

Product Type:
CONTROL BOX

Report Producer : Eva Kao

Report Number : RXZ220331005RF01

Report Date : 2022-05-31

Reviewed By: Andy Shih *Andy Shih*

Prepared By: Bay Area Compliance Laboratories Corp.

(New Taipei Laboratory)

70, Lane 169, Sec. 2, Datong Road, Xizhi Dist.,

New Taipei City 22183, Taiwan, R.O.C.

Tel: +886 (2) 2647 6898

Fax: +886 (2) 2647 6895

www.bacl.com.tw

Revision History

Revision	No.	Report Number	Issue Date	Description	Author/ Revised by
0.0	RXZ220331005	RXZ220331005RF01	2022-05-31	Original Report	Eva Kao

TABLE OF CONTENTS

1	General Information.....	5
1.1	Product Description for Equipment under Test (EUT)	5
1.2	Objective	6
1.3	Related Submittal(s)/Grant(s).....	6
1.4	Test Methodology.....	6
1.5	Statement	6
1.6	Measurement Uncertainty	7
1.7	Environmental Conditions.....	7
1.8	Test Facility.....	7
2	System Test Configuration.....	8
2.1	Description of Test Configuration.....	8
2.2	Equipment Modifications	8
2.3	EUT Exercise Software	8
2.4	Support Equipment List and Details.....	8
2.5	External Cable List and Details.....	9
2.6	Block Diagram of Test Setup	9
3	Summary of Test Results	11
4	Test Equipment List and Details	12
5	RSS-102 § 2.5.2 – EXEMPTION LIMITS FROM ROUTINE EVALUATION - RF EXPOSURE EVALUATION	13
5.1	Applicable Standard	13
5.2	RF Exposure Evaluation Result.....	13
6	FCC §15.203 & RSS-GEN CLAUSE 6.8 – Antenna Requirements.....	14
6.1	Applicable Standard	14
6.2	Antenna Information	14
7	FCC §15.207(a) & RSS-GEN CLAUSE 8.8 – AC Line Conducted Emissions.....	15
7.1	Applicable Standard	15
7.2	EUT Setup	15
7.3	EMI Test Receiver Setup	16
7.4	Test Procedure.....	16
7.5	Corrected Factor & Margin Calculation.....	16
7.6	Test Results	17
8	FCC §15.209, §15.205 , §15.249 & RSS-210 ANNEX B.10, RSS-GEN CLAUSE 8.10 - Radiated Emissions.....	20
8.1	Applicable Standard	20
8.2	EUT Setup	21
8.3	EMI Test Receiver & Spectrum Analyzer Setup.....	21
8.4	Test Procedure.....	22
8.5	Corrected Factor & Margin Calculation.....	22
8.6	Test Results Summary.....	22
8.7	Test Results	23
9	FCC §15.215(c) & RSS-GEN CLAUSE 6.7 – 20 dB Bandwidth Testing and 99% OCCUPIED BANDWIDTH	28
9.1	Applicable Standard	28

9.2 Test Procedure29
9.3 Test Results29

1 General Information

1.1 Product Description for Equipment under Test (EUT)

Manufacturer	DewertOkin Technology Group Co., Ltd.
	Room 247, Floor 6, Jiaying Photovoltaic Science and Innovation Park, 1288 Kanghe Road, Xiuzhou District, Jiaying City, Zhejiang Province, China
Brand Name	DEWERT OKIN
Product (Equipment)	CONTROL BOX
Main Model Name (HVIN)	CB2454
Frequency Range	2403-2480 MHz
Antenna Specification	PIFA Antenna / 1 dBi
Power Operation	29Vdc, 1.5A
Received Date	Apr. 08, 2022
Date of Test	Apr. 18, 2022 ~ May 24, 2022

**All measurement and test data in this report was gathered from production sample serial number: RXZ220331005-01 (Assigned by BACL, New Taipei Laboratory).*

1.2 Objective

This report is prepared on behalf of *DewertOkin Technology Group Co., Ltd.* in accordance with Part 2-Subpart J, and Part 15-Subparts A and C of the Federal Communication Commission's rules, and RSS-210, Issue 10, April 2020 Amendment of the Innovation, Science and Economic Development Canada, and RSS-Gen Issue 5, February 2021 Amendment 2, General Requirements for Compliance of Radio Apparatus.

1.3 Related Submittal(s)/Grant(s)

N/A.

1.4 Test Methodology

All measurements contained in this report were conducted with ANSI C63.10-2013, American National Standard of Procedures for Compliance Testing of Unlicensed Wireless Devices, and RSS-210, Issue 10, April 2020 Amendment of the Innovation, Science and Economic Development Canada, and RSS-Gen Issue 5, February 2021 Amendment 2, General Requirements for Compliance of Radio Apparatus.

1.5 Statement

Decision Rule: No, (The test results do not include MU judgment)

It may not be duplicated or used in part without prior written consent from Bay Area Compliance Laboratories Corp. (New Taipei Laboratory).

Any unauthorized alteration, forgery or falsification of the content or appearance of this document is unlawful and offenders may be prosecuted to the fullest extent of the law.

Unless otherwise stated the results shown in this test report refer only to the sample(s) tested.

The determination of the test results does not require consideration of the uncertainty of the measurement, unless the assessment is required by customer agreement, regulation or standard document specification.

Bay Area Compliance Laboratories Corp. (New Taipei Laboratory) is not responsible for the authenticity of the information provided by the applicant that affects the test results.

1.6 Measurement Uncertainty

Parameter		Uncertainty
Emissions Bandwidth		+/- 0.35 MHz
Unwanted Emissions, conducted		+/- 1.69 dBm
Emissions, radiated	30 MHz~1GHz	+/- 5.22 dB
	1 GHz~18 GHz	+/- 6.12 dB
	18 GHz~40 GHz	+/- 4.99 dB
Temperature		+/- 1.27 °C
Humidity		+/- 3 %

1.7 Environmental Conditions

Test Site	Test Date	Temperature (°C)	Relative Humidity (%)	ATM Pressure (hPa)	Test Engineer
Radiation Spurious Emissions	2022/4/18~2022/5/18	21.5~22.5	68~70	1010	Nike Wu
AC Line Conducted Emissions	2022/5/24	24.5	70	1010	Andy Chang
Emission Bandwidth	2022/5/24	24.5	50	1010	Boris Kao

1.8 Test Facility

The Test site used by Bay Area Compliance Laboratories Corp. (New Taipei Laboratory) to collect test data is located on

☒70, Lane 169, Sec. 2, Datong Road, Xizhi Dist., New Taipei City 22183, Taiwan, R.O.C.

Bay Area Compliance Laboratories Corp. (New Taipei Laboratory) is accredited to ISO 17025 by Taiwan Accreditation Foundation (TAF code: 3732) and the FCC designation No.TW3732 under the Mutual Recognition Agreement (MRA) in FCC Test.

The lab has been recognized by Innovation, Science and Economic Development Canada to test to Canadian radio equipment requirements, the CAB identifier: TW3732.

2 System Test Configuration

2.1 Description of Test Configuration

The device employs 78 Channels as below table:

Channel	Frequency (MHz)	Channel	Frequency (MHz)
1	2403	40	2442
2	2404
...
38	2440	77	2479
39	2441	78	2480

Tested with channel 1, 40 and 78.

2.2 Equipment Modifications

No modification was made to the EUT.

2.3 EUT Exercise Software

The test software was used “nRFgo Studio”

Test Frequency	Low	Mid	High
Power Level Setting	Default	Default	Default

The system was configured for testing in an engineering mode, which was provided by manufacturer.

The engineering mode was configured the system transmitting with maximum power.

2.4 Support Equipment List and Details

Description	Manufacturer	Model Number	S/N
Power Supply	OKIN	02-290020	RBDB18604794
Control Box	OKIN	WFCB0301	N/A
USB Outlet	OKIN	JLDK.44.01.01	Q22013714 00039
LED	N/A	N/A	N/A
USB Load	N/A	50W5ΩJ	N/A
DC Motor*5	OKIN	ALPHADRIVE 5 ADZ5	Q022617 0194
DC Motor*4	OKIN	N/A	N/A
NB	DELL	E6410	8N7PXN1

2.5 External Cable List and Details

Description	Length	From	To
Power Cable	1.8m	EUT	Power Supply
8-Pin Data Cable	0.8m	EUT	Control Box
6-Pin Data Cable	1.5m	EUT	USB Outlet
4-Pin Data Cable	0.5m	EUT	LED
RJ-11 Cable	4m	EUT	NB
5-Pin DIN Cable*5	1m	EUT	DC Motor*5
2-Pin Data Cable*4	1.5m	EUT	DC Motor*4

2.6 Block Diagram of Test Setup

See test photographs attached in setup photos for the actual connections between EUT and support equipment.

Radiation:

Below 1GHz:

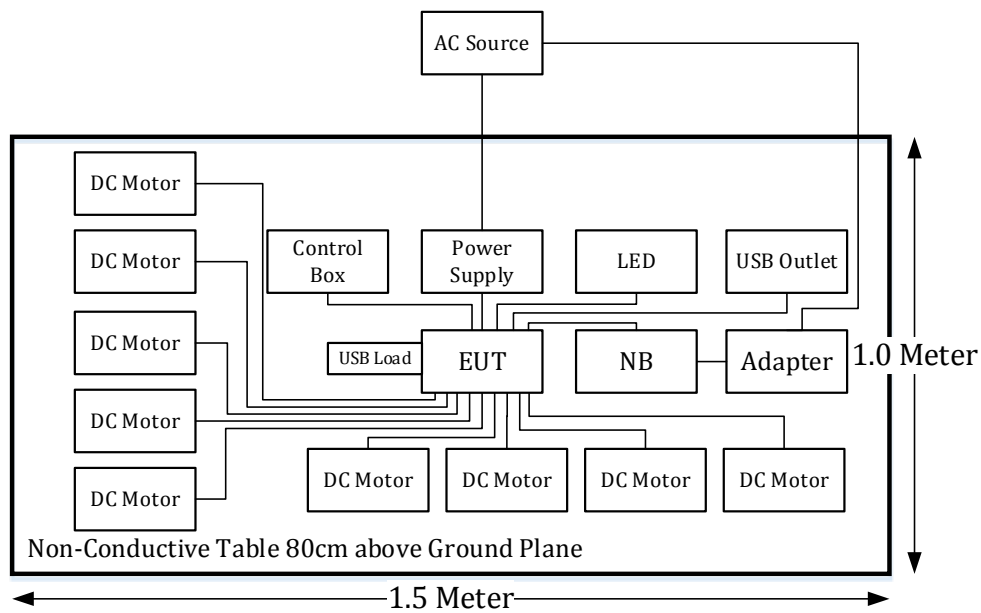

Above 1GHz:

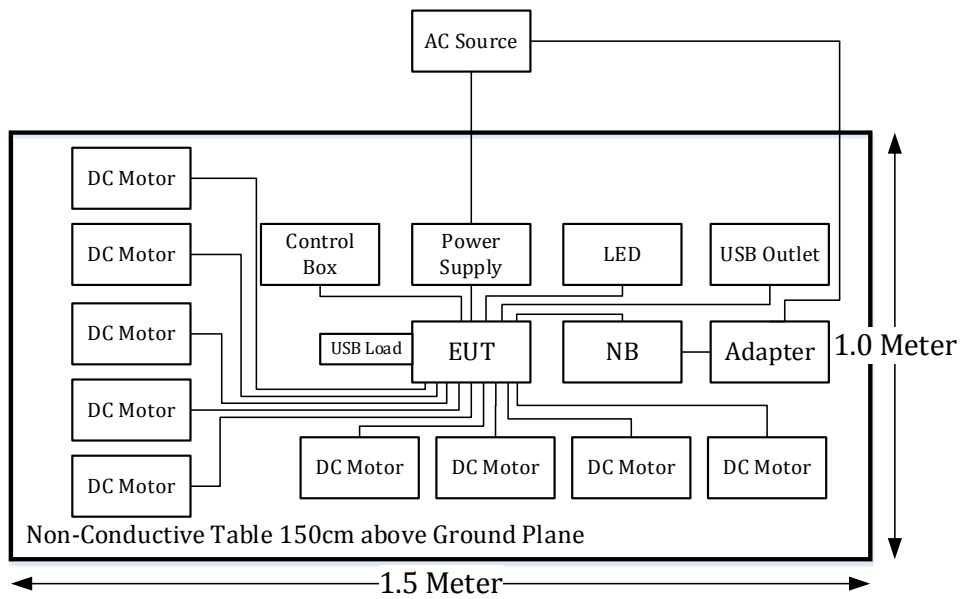

Conduction:

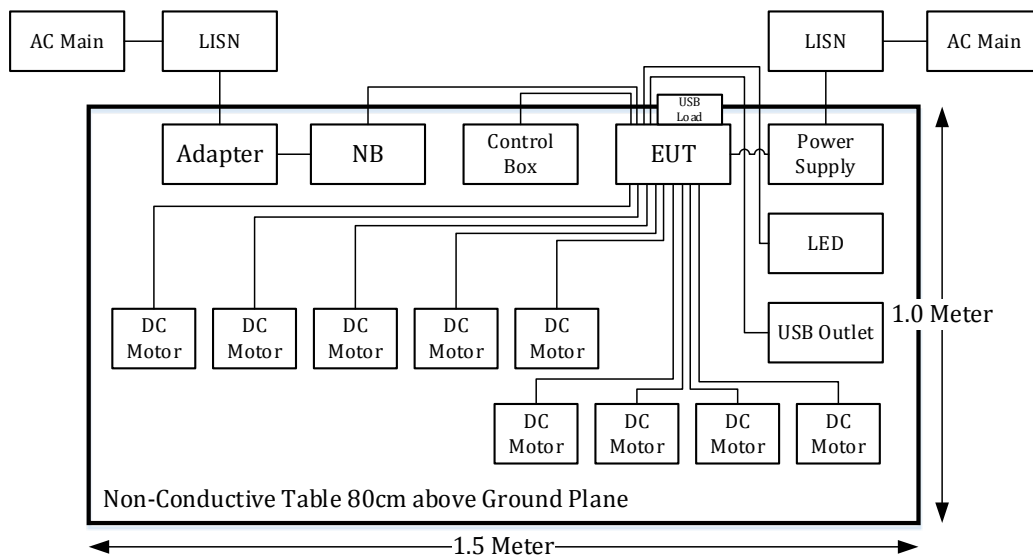

3 Summary of Test Results

FCC Rules	Description of Test	Results
§RSS-102 Clause 2.5.2	Exemption Limits From Routine Evaluation- RF Exposure Evaluation	Compliance
§15.203 RSS-GEN Clause 6.8	Antenna Requirement	Compliance
§15.207 (a) RSS-Gen Clause 8.8	AC Line Conducted Emissions	Compliance
§15.205, §15.209, §15.249 RSS-210 Annex B.10 RSS-Gen Clause 8.10	Radiated Emissions	Compliance
§15.215 (c) RSS-Gen Clause 6.7	20 dB Emission Bandwidth 99% Occupied Bandwidth	Compliance

4 Test Equipment List and Details

Description	Manufacturer	Model	Serial Number	Calibration Date	Calibration Due Date
AC Line Conduction Room (CON-A)					
LISN	Rohde & Schwarz	ENV216	101612	2022/1/14	2023/1/13
LISN	Rohde & Schwarz	ENV216	101248	2021/6/8	2022/6/7
EMI Test Receiver	Rohde & Schwarz	ESW8	100947	2021/7/23	2022/7/22
Pulse Limiter	Rohde & Schwarz	ESH3Z2	TXZEM104	2021/7/29	2022/7/28
RF Cable	EMEC	EM-CB5D	1	2021/6/11	2022/6/10
Software	AUDIX	E3	V9.150826k	N.C.R	N.C.R
Radiation 3M Room (966-A)					
Bilog Antenna with 6 dB Attenuator	SUNOL SCIENCES & MINI-CIRCUITS	JB6/UNAT-6+	A050115/1554_2_01	2022/2/14	2023/2/13
Horn Antenna	EMCO	3115	9809-5583	2021/9/1	2022/8/31
Horn Antenna	ETS-Lindgren	3116	62638	2021/8/11	2022/8/10
Preamplifier	Sonoma	310N	130602	2021/6/8	2022/6/7
Preamplifier	A.H. system Inc.	PAM-0118P	466	2021/11/4	2022/11/3
Microwave Preamplifier	EM Electronics Corporation	EM18G40G	60656	2021/12/27	2022/12/26
Spectrum Analyzer	Rohde & Schwarz	FSV40	101435	2022/1/13	2023/1/12
EMI Test Receiver	Rohde & Schwarz	ESR7	101419	2021/11/9	2022/11/8
Micro flex Cable	UTIFLEX	UFB197C-1-2362-70U-70U	225757-001	2022/1/24	2023/1/23
Coaxial Cable	COMMATE	PEWC	8Dr	2021/12/24	2022/12/23
Coaxial Cable	UTIFLEX	UFB311A-Q-1440-300300	220490-006	2022/1/24	2023/1/23
Coaxial Cable	JUNFLON	J12J102248-00-B-5	AUG-07-15-044	2021/12/24	2022/12/23
Cable	EMC	EMC105-SM-SM-10000	201003	2022/1/24	2023/1/23
Coaxial Cable	ROSNOL	K1K50-UP0264-K1K50-450CM	160309-1	2022/1/24	2023/1/23
Coaxial Cable	ROSNOL	K1K50-UP0264-K1K50-50CM	15120-1	2022/1/18	2023/1/17
Software	Farad	EZ_EMCC	BACL-03A1	N.C.R	N.C.R
Conducted Room					
Spectrum Analyzer	Rohde & Schwarz	FSV40	101140	2022/2/18	2023/2/17
Cable	UTIFLEX	UFA210A	9435	2021/10/5	2022/10/4

***Statement of Traceability:** BACL Corp. attests that all of the calibrations on the equipment items listed above were traceable to the SI System of Units via the R.O.C. Center for Measurement Standards of the Electronics Testing Center, Taiwan (ETC) or to another internationally recognized National Metrology Institute (NMI), and were compliant with the current Taiwan Accreditation Foundation (TAF) requirements

5 RSS-102 § 2.5.2 – EXEMPTION LIMITS FROM ROUTINE EVALUATION - RF EXPOSURE EVALUATION

5.1 Applicable Standard

RF exposure evaluation is required if the separation distance between the user and/or bystander and the device's radiating element is greater than 20 cm, except when the device operates as follows:

- below 20 MHz and the source-based, time-averaged maximum e.i.r.p. of the device is equal to or less than 1 W (adjusted for tune-up tolerance);
- at or above 20 MHz and below 48 MHz and the source-based, time-averaged maximum e.i.r.p. of the device is equal to or less than $4.49/f^{0.5}$ W (adjusted for tune-up tolerance), where f is in MHz;
- at or above 48 MHz and below 300 MHz and the source-based, time-averaged maximum e.i.r.p. of the device is equal to or less than 0.6 W (adjusted for tune-up tolerance);
- at or above 300 MHz and below 6 GHz and the source-based, time-averaged maximum e.i.r.p. of the device is equal to or less than $1.31 \times 10^{-2} f^{0.6834}$ W (adjusted for tune-up tolerance), where f is in MHz;
- at or above 6 GHz and the source-based, time-averaged maximum e.i.r.p. of the device is equal to or less than 5 W (adjusted for tune-up tolerance).

In these cases, the information contained in the RF exposure technical brief may be limited to information that demonstrates how the e.i.r.p. was derived.

5.2 RF Exposure Evaluation Result

$$\text{EIRP} = 94.61 \text{ dB}\mu\text{V/m} - 95.2 = -0.59 \text{ dBm}$$

$$\text{Tune-up power} = -0.5 \text{ dBm} = 0.89 \text{ mW}$$

Exemption from Routine Evaluation Limit is:

$$1.31 \times 10^{-2} f^{0.6834} = 1.31 \times 10^{-2} \times 2403^{0.6834} = 2.67 \text{ W} > 0.89 \text{ mW}$$

Result: The device meets the exemption requirement.

6 FCC §15.203 & RSS-GEN CLAUSE 6.8 – Antenna Requirements

6.1 Applicable Standard

For intentional device, according to §15.203, an intentional radiator shall be designed to ensure that no antenna other than that furnished by the responsible party shall be used.

According to RSS-Gen §6.8, The applicant for equipment certification shall provide a list of all antenna types that may be used with the transmitter, where applicable (i.e. for transmitters with detachable antenna), indicating the maximum permissible antenna gain (in dBi) and the required impedance for each antenna. The test report shall demonstrate the compliance of the transmitter with the limit for maximum equivalent isotropically radiated power (e.i.r.p.) specified in the applicable RSS, when the transmitter is equipped with any antenna type, selected from this list.

For expediting the testing, measurements may be performed using only the antenna with highest gain of each combination of transmitter and antenna type, with the transmitter output power set at the maximum level. However, the transmitter shall comply with the applicable requirements under all operational conditions and when in combination with any type of antenna from the list provided in the test report (and in the notice to be included in the user manual, provided below).

When measurements at the antenna port are used to determine the RF output power, the effective gain of the device's antenna shall be stated, based on a measurement or on data from the antenna's manufacturer. The test report shall state the RF power, output power setting and spurious emission measurements with each antenna type that is used with the transmitter being tested. For licence-exempt equipment with detachable antennas, the user manual shall also contain the following notice in a conspicuous location:

This radio transmitter [enter the device's ISED certification number] has been approved by Innovation, Science and Economic Development Canada to operate with the antenna types listed below, with the maximum permissible gain indicated. Antenna types not included in this list that have a gain greater than the maximum gain indicated for any type listed are strictly prohibited for use with this device.

Immediately following the above notice, the manufacturer shall provide a list of all antenna types which can be used with the transmitter, indicating the maximum permissible antenna gain (in dBi) and the required impedance for each antenna type.

6.2 Antenna Information

Type	Antenna Gain	Input impedance
PIFA Antenna	1.0 dBi	50Ω

Result: Compliance.

7 FCC §15.207(a) & RSS-GEN CLAUSE 8.8 – AC Line Conducted Emissions

7.1 Applicable Standard

According to §15.207r an intentional radiator that is designed to be connected to the public utility (AC) power line, the radio frequency voltage that is conducted back onto the AC power line on any frequency or frequencies within the band 150 kHz to 30 MHz shall not exceed the limits in the following table, as measured using a 50 μ H/50 ohms line impedance stabilization network (LISN). Compliance with the provisions of this paragraph shall be based on the measurement of the radio frequency voltage between each power line and ground at the power terminal. The lower limit applies at the boundary between the frequencies ranges.

Frequency of Emission (MHz)	Conducted Limit (dBuV)	
	Quasi-Peak	Average
0.15-0.5	66 to 56 ^{Note 1}	56 to 46 ^{Note 1}
0.5-5	56	46
5-30	60	50

Note 1: Decreases with the logarithm of the frequency.

7.2 EUT Setup

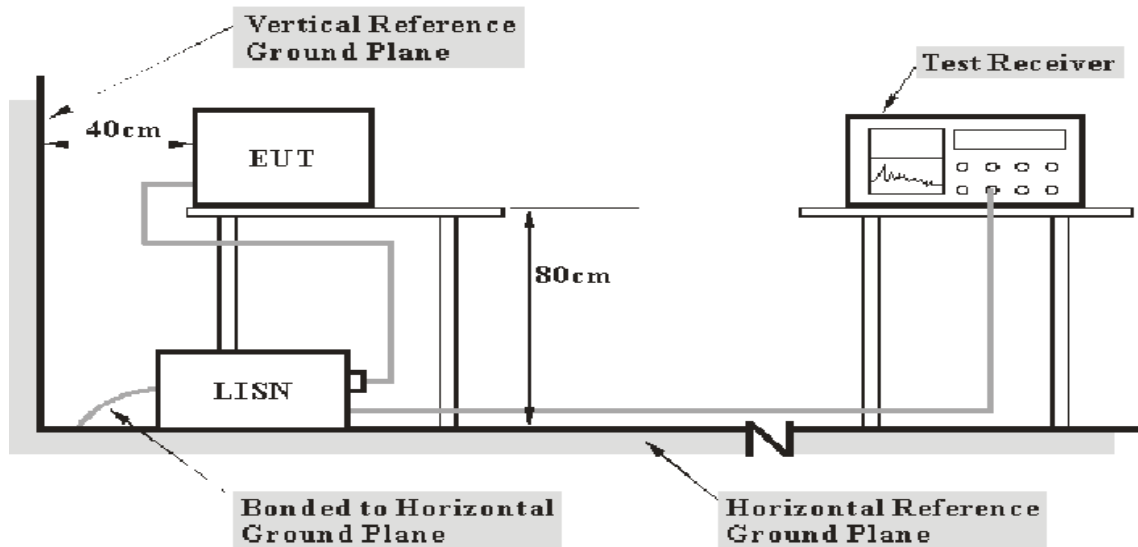

- Note: 1. Support units were connected to second LISN.
 2. Both of LISNs (AMN) 80 cm from EUT and at the least 80 cm from other units and other metal planes support units.

The setup of EUT is according with per ANSI C63.10-2013 measurement procedure. The specification used was with the FCC Part 15.207 limits.

7.3 EMI Test Receiver Setup

The EMI test receiver was set to investigate the spectrum from 150kHz to 30MHz.

During the conducted emission test, the EMI test receiver was set with the following configurations

Frequency Range	IF B/W
150kHz – 30MHz	9kHz

7.4 Test Procedure

During the conducted emission test, the adapter was connected to the outlet of the LISN.

Maximizing procedure was performed on the six (6) highest emissions of the EUT.

All data was recorded in the Quasi-peak and average detection mode.

7.5 Corrected Factor & Margin Calculation

The factor is calculated by adding LISN/ISN VDF (Voltage Division Factor), Cable Loss and Transient Limiter Attenuation. The basic equation is as follows:

$$\text{Factor} = \text{LISN VDF} + \text{Cable Loss} + \text{Transient Limiter Attenuation}$$

The “Over Limit” column of the following data tables indicates the degree of compliance with the applicable limit. For example, an over limit of -7 dB means the emission is 7 dB below the limit. The equation for Over Limit calculation is as follows:

$$\text{Over Limit} = \text{Level} - \text{Limit Line}$$

7.6 Test Results

Test Mode: Transmitting

Job No.:	RXZ220331005	Phase.:	Line
Standard:	limit\RF\FCC Part 15.207-QP.csv	Power:	AC 120V/60Hz
Test item:	Conduction Test	Test By:	Andy.Cheng
Temp.(°C)/Hum.(%RH):	24.5 °C/70%	Description:	SRD

2022-05-24 10:24:00

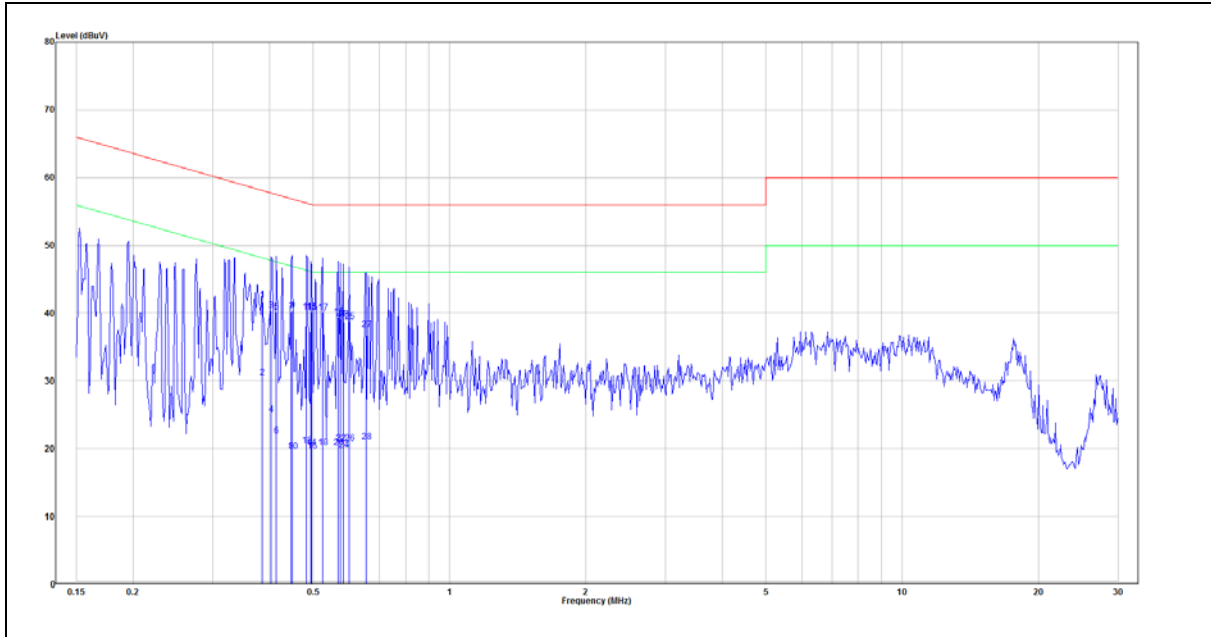

No.	Frequency (MHz)	Reading (dBuV)	Correct Factor(dB)	Result (dBuV)	Limit (dBuV)	Over limit (dB)	Remark	Phase
1	0.385	22.43	19.51	41.94	58.17	-16.23	QP	Line
2	0.385	11.00	19.51	30.51	48.17	-17.66	Average	Line
3	0.404	20.88	19.51	40.39	57.77	-17.38	QP	Line
4	0.404	5.52	19.51	25.03	47.77	-22.74	Average	Line
5	0.415	20.62	19.51	40.13	57.55	-17.42	QP	Line
6	0.415	2.35	19.51	21.86	47.55	-25.69	Average	Line
7	0.447	20.61	19.52	40.13	56.93	-16.80	QP	Line
8	0.447	0.11	19.52	19.63	46.93	-27.30	Average	Line
9	0.449	20.81	19.52	40.33	56.89	-16.56	QP	Line
10	0.449	0.03	19.52	19.55	46.89	-27.34	Average	Line
11	0.484	20.69	19.52	40.21	56.27	-16.06	QP	Line
12	0.484	0.97	19.52	20.49	46.27	-25.78	Average	Line
13	0.494	20.61	19.52	40.13	56.10	-15.97	QP	Line
14	0.494	0.58	19.52	20.10	46.10	-26.00	Average	Line

15	0.497	20.64	19.52	40.16	56.05	-15.89	QP	Line
16	0.497	0.05	19.52	19.57	46.05	-26.48	Average	Line
17	0.524	20.48	19.52	40.00	56.00	-16.00	QP	Line
18	0.524	0.56	19.52	20.08	46.00	-25.92	Average	Line
19	0.567	19.90	19.52	39.42	56.00	-16.58	QP	Line
20	0.567	0.66	19.52	20.18	46.00	-25.82	Average	Line
21	0.573	19.64	19.52	39.16	56.00	-16.84	QP	Line
22	0.573	1.27	19.52	20.79	46.00	-25.21	Average	Line
23	0.582	19.52	19.52	39.04	56.00	-16.96	QP	Line
24	0.582	0.28	19.52	19.80	46.00	-26.20	Average	Line
25	0.601	19.28	19.53	38.81	56.00	-17.19	QP	Line
26	0.601	1.26	19.53	20.79	46.00	-25.21	Average	Line
27	0.654	18.04	19.53	37.57	56.00	-18.43	QP	Line
28	0.654	1.45	19.53	20.98	46.00	-25.02	Average	Line

Note:

Level = Read Level + Factor

Over Limit = Level – Limit Line

Factor = (LISN, ISN, PLC or current probe) Factor + Cable Loss + Attenuator

Job No.:	RXZ220331005	Phase.:	Neutral
Standard:	limit\RF\FCC Part 15.207-QP.csv	Power:	AC 120V/60Hz
Test item:	Conduction Test	Test By:	Andy.Cheng
Temp.(°C)/Hum.(%RH):	24.5 °C/70%	Description:	SRD

2022-05-24 10:26:43

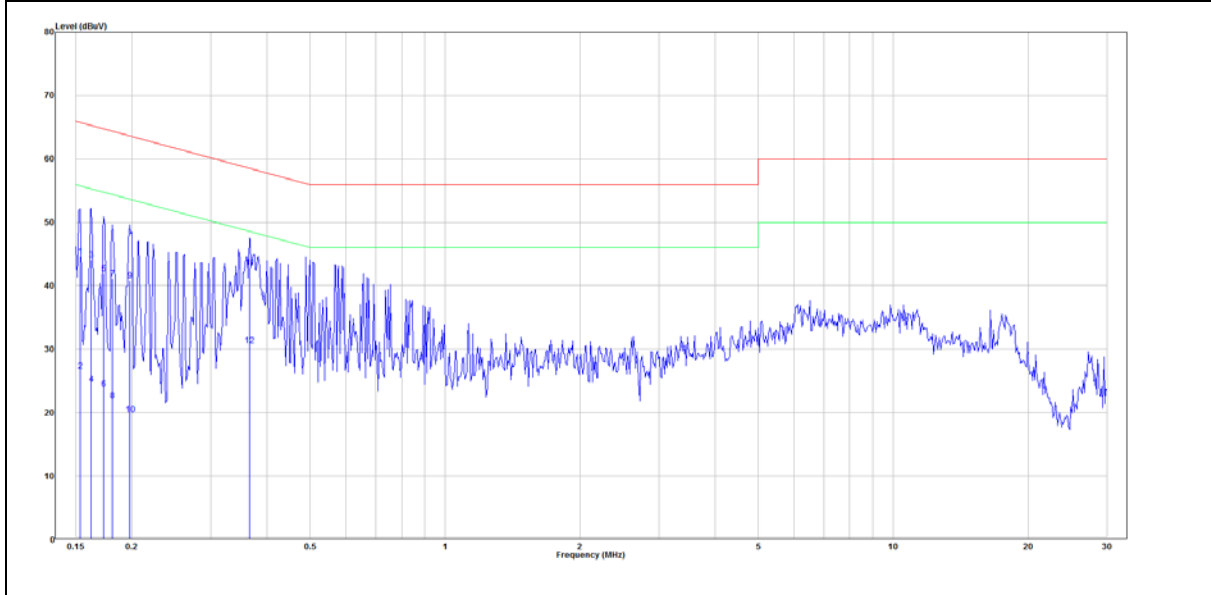

No.	Frequency (MHz)	Reading (dBuV)	Correct Factor(dB)	Result (dBuV)	Limit (dBuV)	Over limit (dB)	Remark	Phase
1	0.153	25.10	19.50	44.60	65.82	-21.22	QP	Neutral
2	0.153	7.04	19.50	26.54	55.82	-29.28	Average	Neutral
3	0.162	24.56	19.50	44.06	65.34	-21.28	QP	Neutral
4	0.162	5.04	19.50	24.54	55.34	-30.80	Average	Neutral
5	0.173	22.44	19.50	41.94	64.81	-22.87	QP	Neutral
6	0.173	4.25	19.50	23.75	54.81	-31.06	Average	Neutral
7	0.181	21.69	19.50	41.19	64.46	-23.27	QP	Neutral
8	0.181	2.35	19.50	21.85	54.46	-32.61	Average	Neutral
9	0.198	21.29	19.49	40.78	63.71	-22.93	QP	Neutral
10	0.198	0.16	19.49	19.65	53.71	-34.06	Average	Neutral
11	0.365	23.40	19.51	42.91	58.61	-15.70	QP	Neutral
12	0.365	11.04	19.51	30.55	48.61	-18.06	Average	Neutral

Note:

Level = Read Level + Factor

Over Limit = Level – Limit Line

Factor = (LISN, ISN, PLC or current probe) Factor + Cable Loss + Attenuator

8 FCC §15.209, §15.205 , §15.249 & RSS-210 ANNEX B.10, RSS-GEN CLAUSE 8.10 - Radiated Emissions

8.1 Applicable Standard

As per FCC§15.249 (a), except as provided in paragraph (b) of this section, the field strength of emissions from intentional radiators operated within these frequency bands shall comply with the following:

Fundamental frequency	Field strength of fundamental (millivolts/meter)	Field strength of harmonics (microvolts/meter)
920-928 MHz	50	500
2400-2483.5 MHz	50	500
5725-5875 MHz	50	500
24.0-24.25 GHz	250	2500

As per FCC§15.249 (c), Field strength limits are specified at a distance of 3 meters.

(d) Emissions radiated outside of the specified frequency bands, except for harmonics, shall be attenuated by at least 50 dB below the level of the fundamental or to the general radiated emission limits in §15.209, whichever is the lesser attenuation.

According to RSS-210 Issue 10 Clause Annex B B.10 (a): The field strength of fundamental and harmonic emissions, measured at 3 m, shall not exceed 50 mV/m and 0.5 mV/m respectively.

According to RSS-210 Issue 10 Clause Annex B B.10 (b): Emissions radiated outside of the specified frequency bands, except for harmonic emissions, shall be attenuated by at least 50 dB below the level of the fundamental emissions or to the general field strength limits listed in RSS-GEN Issue 5, whichever is less stringent.

Field strength limits at various frequencies		
Fundamental frequency	Field strength (mV/m)	
	Fundamental emissions	Harmonic emissions
920-928 MHz	50	0.5
2400-2483.5 MHz	50	0.5
5725-5875 MHz	50	0.5
24.0-24.25 GHz	250	2.5

As per RSS-210 Issue 10 Clause Annex B B.10, Field strength limits are specified at a distance of 3 meters.

8.2 EUT Setup

Below 1 GHz:

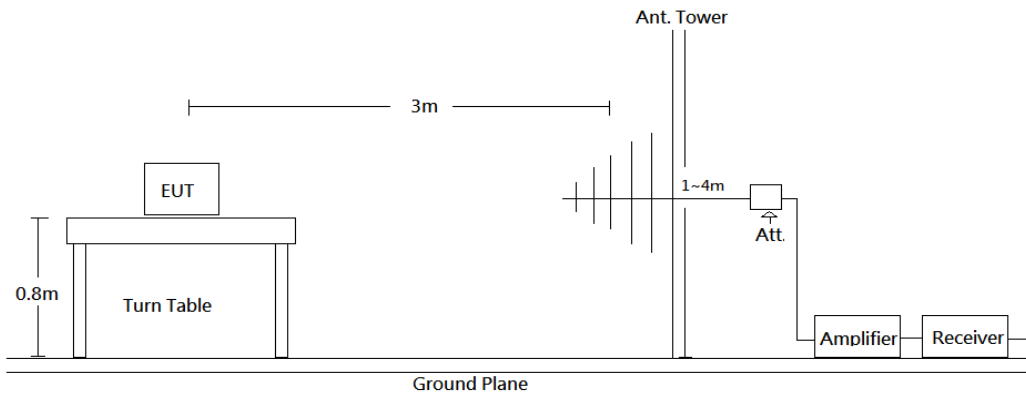

Above 1 GHz:

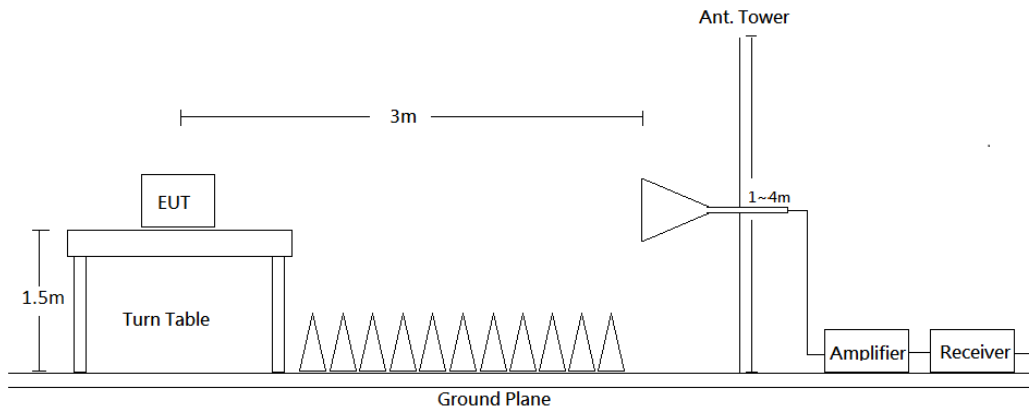

Radiated emission tests were performed in the 3 meters chamber test site, using the setup accordance with the ANSI C63.10-2013. The specification used was the FCC 15.205, FCC 15.209, FCC 15.249 and RSS-GEN, RSS-210 limits.

8.3 EMI Test Receiver & Spectrum Analyzer Setup

The system was investigated from 30 MHz to 26.5 GHz. During the radiated emission test, the EMI test receiver was set with the following configurations:

Frequency Range	RBW	VBW	Measurement method
30-1000 MHz	120 kHz	300 kHz	QP
Above 1 GHz	1 MHz	3 MHz	PK
Above 1 GHz	1 MHz	3 MHz	AVG

8.4 Test Procedure

Maximizing procedure was performed on the highest emissions to ensure that the EUT complied with all installation combinations.

All data was recorded in the Quasi-peak detector mode from 30 MHz to 1 GHz and PK and average detector modes for frequencies above 1 GHz.

8.5 Corrected Factor & Margin Calculation

The Correct Factor is calculated by adding the Antenna Factor and Cable Loss, and subtracting the Amplifier Gain from the Meter Reading. The basic equation is as follows:

$$\text{Correct Factor} = \text{Antenna Factor} + \text{Cable Loss} - \text{Amplifier Gain}$$

The “Margin” column of the following data tables indicates the degree of compliance with the applicable limit. For example, a margin of -7 dB means the emission is 7 dB below the limit. The equation for margin calculation is as follows:

$$\text{Margin} = \text{Result} - \text{Limit}$$

8.6 Test Results Summary

According to the data in the following table, the EUT complied with the FCC 15.205, FCC 15.209, FCC 15.249 and RSS-210, RSS-Gen.

8.7 Test Results

Test Mode: Transmitting

(Pre-scan with three orthogonal axis, and worse case as Z axis.)

Horizontal (worst case is Low channel)

Fundamental:

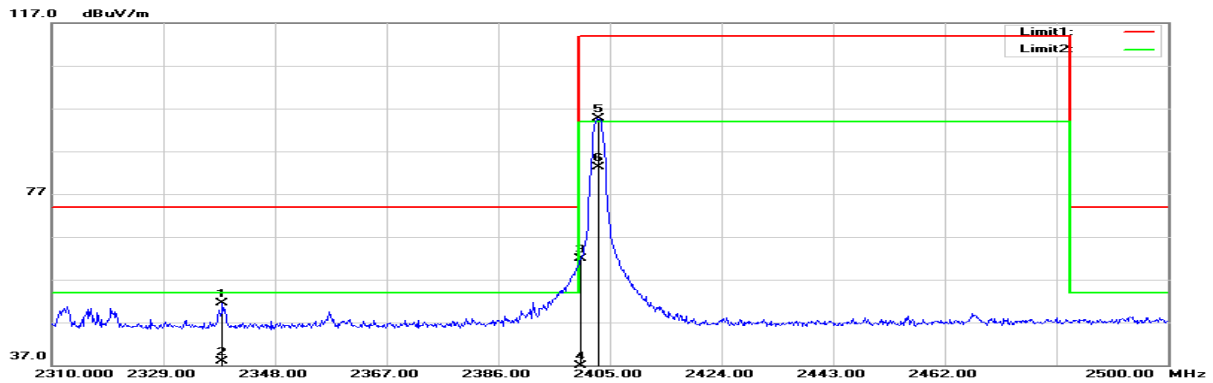

30MHz-1GHz:

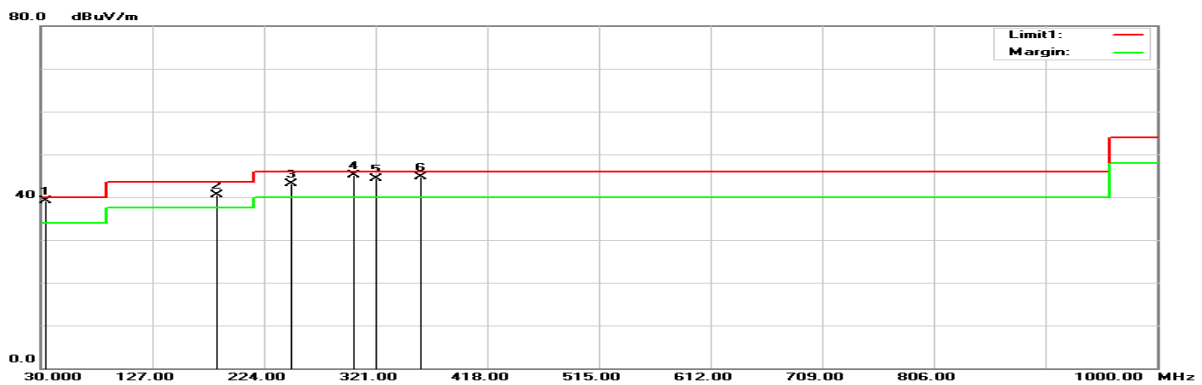

1GHz-18GHz:

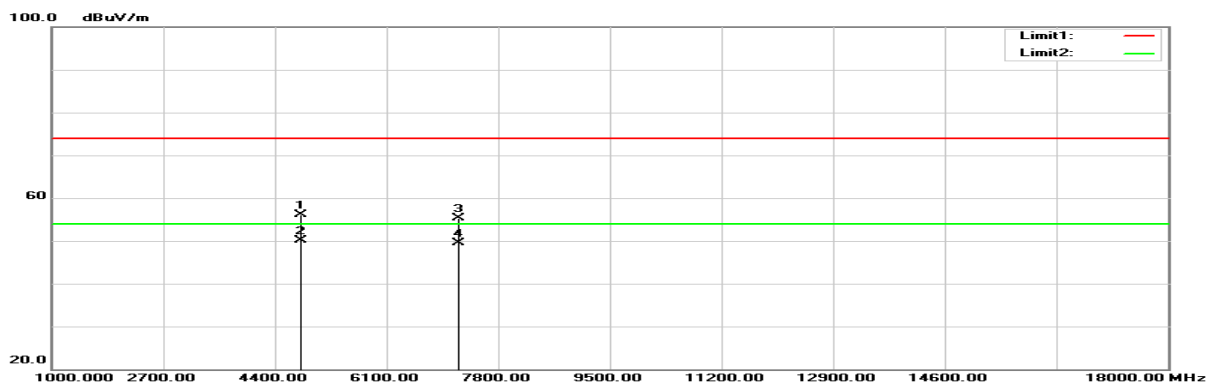

18GHz-26.5GHz:

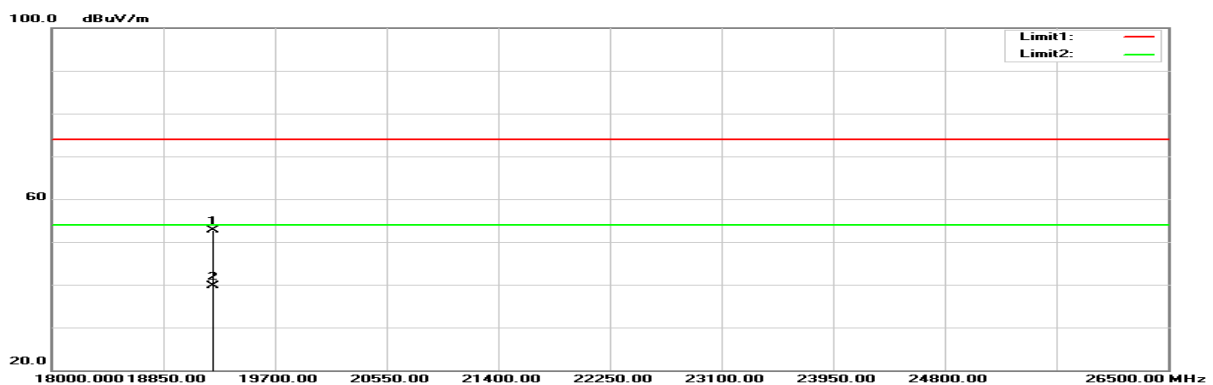

Vertical

Fundamental:

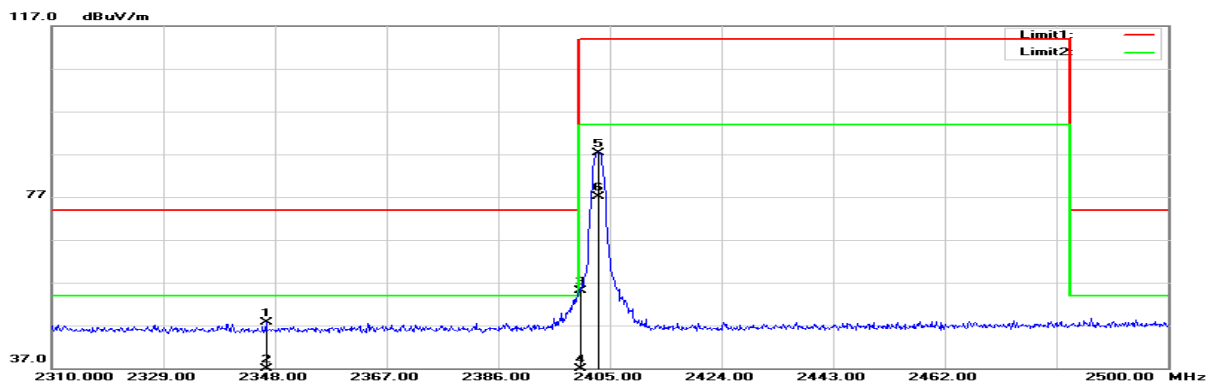

30MHz-1GHz:

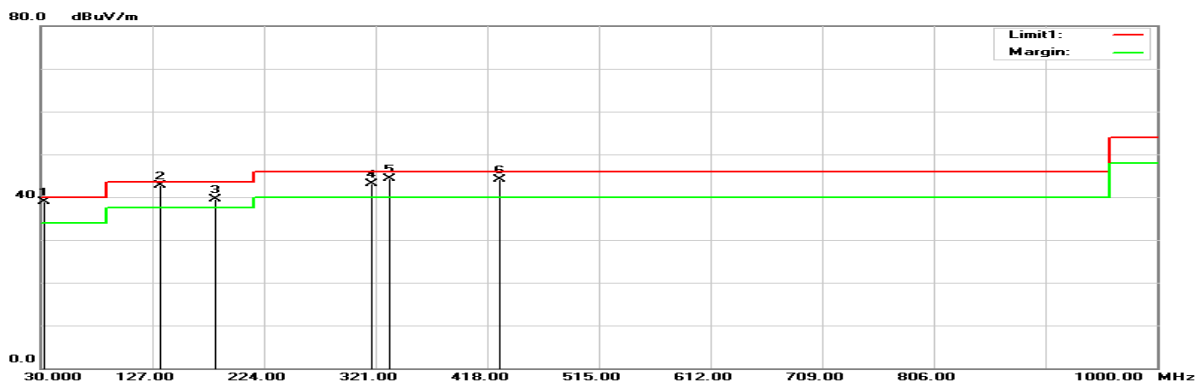

1GHz-18GHz:

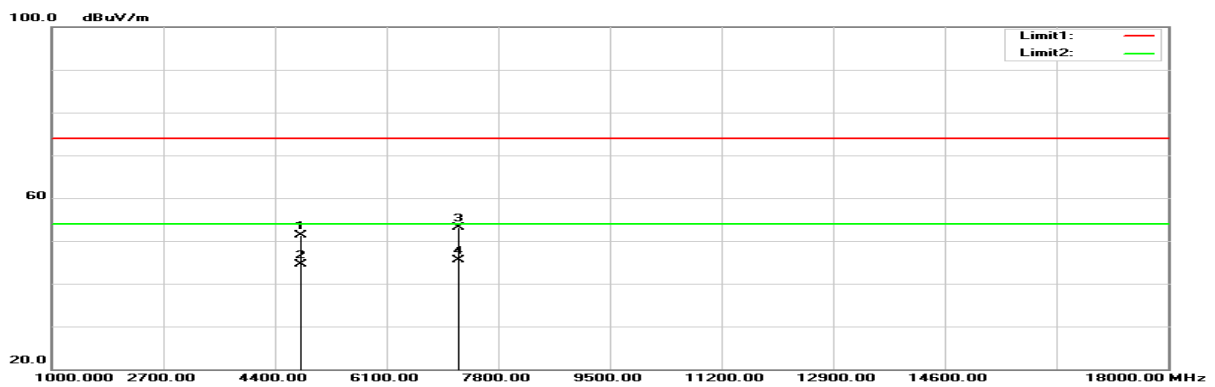

18GHz-26.5GHz:

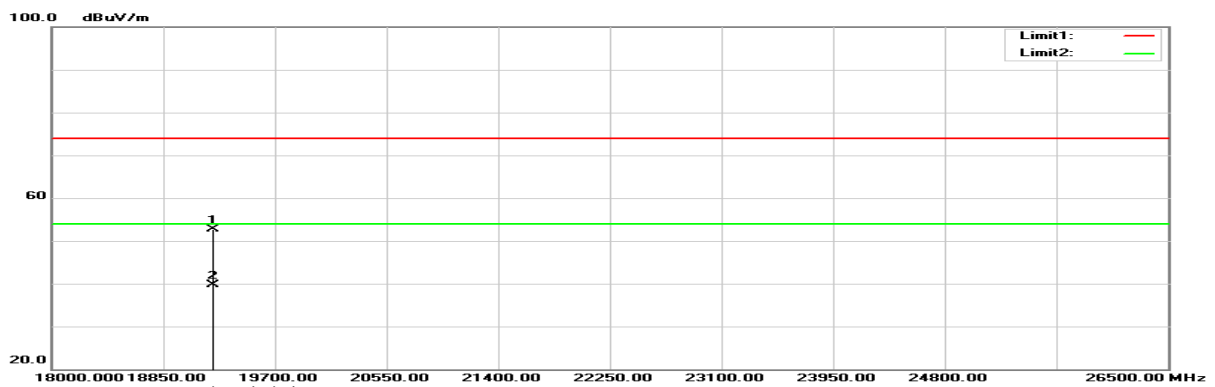

Below 1GHz**Horizontal**

No.	Frequency (MHz)	Reading (dBuV)	Correct Factor(dB/m)	Result (dBuV/m)	Limit (dBuV/m)	Margin (dB)	Height (cm)	Degree (°)	Remark
1	33.8800	44.10	-5.04	39.06	40.00	-0.94	100	0	QP
2	183.2600	51.22	-10.68	40.54	43.50	-2.96	100	134	QP
3	248.2500	52.88	-9.79	43.09	46.00	-2.91	100	114	QP
4	301.6000	52.48	-7.40	45.08	46.00	-0.92	100	11	QP
5	321.9700	51.26	-6.95	44.31	46.00	-1.69	100	176	QP
6	359.8000	50.56	-5.90	44.66	46.00	-1.34	100	109	QP

Vertical

No.	Frequency (MHz)	Reading (dBuV)	Correct Factor(dB/m)	Result (dBuV/m)	Limit (dBuV/m)	Margin (dB)	Height (cm)	Degree (°)	Remark
1	32.9100	43.60	-4.71	38.89	40.00	-1.11	100	201	QP
2	133.7900	51.20	-8.42	42.78	43.50	-0.72	100	67	QP
3	181.3200	50.16	-10.68	39.48	43.50	-4.02	100	178	QP
4	317.1200	50.15	-7.01	43.14	46.00	-2.86	100	90	QP
5	332.6400	51.10	-6.76	44.34	46.00	-1.66	100	213	QP
6	428.6700	48.12	-4.00	44.12	46.00	-1.88	100	183	QP

Result = Reading + Correct Factor

Margin = Result – Limit

Correct Factor = Antenna Factor + Cable Loss – Amplifier Gain

Spurious emissions more than 20 dB below the limit were not reported.

Above 1GHz

Horizontal

Frequency	Reading	Correct	Result	Limit	Margin	Height	Degree	Remark
(MHz)	(dBµV)	Factor(dB/m)	(dBµV/m)	(dBµV/m)	(dB)	(cm)	(°)	
Low channel								
2339.070	61.62	-10.10	51.52	74.00	-22.48	153	67	peak
2339.070	48.01	-10.10	37.91	54.00	-16.09	153	67	AVG
2400.000	71.59	-9.65	61.94	74.00	-12.06	153	67	peak
2400.000	45.42	-9.65	35.77	54.00	-18.23	153	67	AVG
2403.000	104.24	-9.63	94.61	114.00	-19.39	153	67	peak
2403.000	92.94	-9.63	83.31	94.00	-10.69	153	67	AVG
4806.000	58.88	-2.70	56.18	74.00	-17.82	113	340	peak
4806.000	52.90	-2.70	50.20	54.00	-3.80	113	340	AVG
7209.000	52.55	2.78	55.33	74.00	-18.67	116	295	peak
7209.000	46.82	2.78	49.60	54.00	-4.40	116	295	AVG
Middle channel								
2442.000	101.81	-9.37	92.44	114.00	-21.56	154	152	peak
2442.000	91.53	-9.37	82.16	94.00	-11.84	154	152	AVG
4884.000	59.21	-2.66	56.55	74.00	-17.45	100	351	peak
4884.000	53.52	-2.66	50.86	54.00	-3.14	100	351	AVG
7326.000	51.12	3.19	54.31	74.00	-19.69	147	72	peak
7326.000	44.18	3.19	47.37	54.00	-6.63	147	72	AVG
High channel								
2480.000	101.99	-8.93	93.06	114.00	-20.94	142	32	peak
2480.000	91.75	-8.93	82.82	94.00	-11.18	142	32	AVG
2494.310	57.38	-8.75	48.63	74.00	-25.37	142	32	peak
2494.310	43.25	-8.75	34.50	54.00	-19.50	142	32	AVG
4960.000	56.75	-2.44	54.31	74.00	-19.69	127	307	peak
4960.000	52.95	-2.44	50.51	54.00	-3.49	127	307	AVG
7440.000	51.45	3.56	55.01	74.00	-18.99	159	68	peak
7440.000	45.57	3.56	49.13	54.00	-4.87	159	68	AVG

Result = Reading + Correct Factor

Margin = Result – Limit

Correct Factor = Antenna Factor + Cable Loss – Amplifier Gain

Spurious emissions more than 20 dB below the limit were not reported.

Vertical

Frequency	Reading	Correct	Result	Limit	Margin	Height	Degree	Remark
(MHz)	(dB μ V)	Factor(dB/m)	(dB μ V/m)	(dB μ V/m)	(dB)	(cm)	($^{\circ}$)	
Low channel								
2346.480	57.71	-10.09	47.62	74.00	-26.38	100	195	peak
2346.480	43.37	-10.09	33.28	54.00	-20.72	100	195	AVG
2400.000	64.66	-9.65	55.01	74.00	-18.99	100	195	peak
2400.000	43.55	-9.65	33.90	54.00	-20.10	100	195	AVG
2403.000	96.99	-9.63	87.36	114.00	-26.64	100	195	peak
2403.000	86.72	-9.63	77.09	94.00	-16.91	100	195	AVG
4806.000	53.96	-2.70	51.26	74.00	-22.74	150	58	peak
4806.000	47.22	-2.70	44.52	54.00	-9.48	150	58	AVG
7209.000	50.23	2.78	53.01	74.00	-20.99	141	315	peak
7209.000	42.80	2.78	45.58	54.00	-8.42	141	315	AVG
Middle channel								
2442.000	91.81	-9.37	82.44	114.00	-31.56	156	218	peak
2442.000	81.38	-9.37	72.01	94.00	-21.99	156	218	AVG
4884.000	54.85	-2.66	52.19	74.00	-21.81	109	7	peak
4884.000	48.08	-2.66	45.42	54.00	-8.58	109	7	AVG
7326.000	50.94	3.19	54.13	74.00	-19.87	120	42	peak
7326.000	43.76	3.19	46.95	54.00	-7.05	120	42	AVG
High channel								
2480.000	91.92	-8.93	82.99	114.00	-31.01	143	217	peak
2480.000	81.59	-8.93	72.66	94.00	-21.34	143	217	AVG
2499.810	57.15	-8.67	48.48	74.00	-25.52	143	217	peak
2499.810	43.57	-8.67	34.90	54.00	-19.10	143	217	AVG
4960.000	52.36	-2.44	49.92	74.00	-24.08	135	226	peak
4960.000	45.90	-2.44	43.46	54.00	-10.54	135	226	AVG
7440.000	53.22	3.56	56.78	74.00	-17.22	107	13	peak
7440.000	47.92	3.56	51.48	54.00	-2.52	107	13	AVG

Result = Reading + Correct Factor

Margin = Result – Limit

Correct Factor = Antenna Factor + Cable Loss – Amplifier Gain

Spurious emissions more than 20 dB below the limit were not reported.

9 FCC §15.215(c) & RSS-GEN CLAUSE 6.7 – 20 dB Bandwidth Testing and 99% OCCUPIED BANDWIDTH

9.1 Applicable Standard

Intentional radiators operating under the alternative provisions to the general emission limits, as contained in § 15.217 through 15.257 and in Subpart E of this part, must be designed to ensure that the 20 dB bandwidth of the emission, or whatever bandwidth may otherwise be specified in the specific rule section under which the equipment operates, is contained within the frequency band designated in the rule section under which the equipment is operated.

According to RSS-Gen Clause 6.7:

The occupied bandwidth or the “99% emission bandwidth” is defined as the frequency range between two points, one above and the other below the carrier frequency, within which 99% of the total transmitted power of the fundamental transmitted emission is contained. The occupied bandwidth shall be reported for all equipment in addition to the specified bandwidth required in the applicable RSSs.

In some cases, the “x dB bandwidth” is required, which is defined as the frequency range between two points, one at the lowest frequency below and one at the highest frequency above the carrier frequency, at which the maximum power level of the transmitted emission is attenuated x dB below the maximum inband power level of the modulated signal, where the two points are on the outskirts of the in-band emission.

The following conditions shall be observed for measuring the occupied bandwidth and x dB bandwidth: The transmitter shall be operated at its maximum carrier power measured under normal test conditions.

The span of the spectrum analyzer shall be set large enough to capture all products of the modulation process, including the emission skirts, around the carrier frequency, but small enough to avoid having other emissions (e.g. on adjacent channels) within the span. The detector of the spectrum analyzer shall be set to “Sample” .

However, a peak, or peak hold,

may be used in place of the sampling detector since this usually produces a wider bandwidth than the actual bandwidth (worst-case measurement). Use of a peak hold (or “Max Hold”) may be necessary to determine the occupied / x dB bandwidth if the device is not transmitting continuously.

The resolution bandwidth (RBW) shall be in the range of 1% to 5% of the actual occupied / x dB bandwidth and the video bandwidth (VBW) shall not be smaller than three times the RBW value. Video averaging is not permitted.

Note: It may be necessary to repeat the measurement a few times until the RBW and VBW are in compliance with the above requirement.

9.2 Test Procedure

20dB bandwidth test:

1. Check the calibration of the measuring instrument using either an internal calibrator or a known signal from an external generator.
2. Position the EUT without connection to measurement instrument. Turn on the EUT and connect it to measurement instrument. Then set it to any one convenient frequency within its operating range. Set a reference level on the measuring instrument equal to the highest peak value.
3. Measure the frequency difference of two frequencies that were attenuated 20 dB from the reference level. Record the frequency difference as the emission bandwidth.
4. Repeat above procedures until all frequencies measured were complete.

For the 99% emission bandwidth, the trace data points are recovered and directly summed in linear power level terms. The recovered amplitude data points, beginning at the lowest frequency, are placed in a running sum until 0.5% of the total is reached, and that frequency recorded. The process is repeated for the highest frequency data points (starting at the highest frequency, at the right side of the span, and going down in frequency). This frequency is then recorded. The difference between the two recorded frequencies is the occupied bandwidth (or the 99% emission bandwidth).

9.3 Test Results

Channel	Frequency (MHz)	20 dB Emission Bandwidth (MHz)	99% Occupied Bandwidth (MHz)
Low	2403	0.93	0.91
Middle	2442	0.94	0.91
High	2480	0.93	0.92

Please refer to the following plots

20 dB Emission Bandwidth

Low Channel

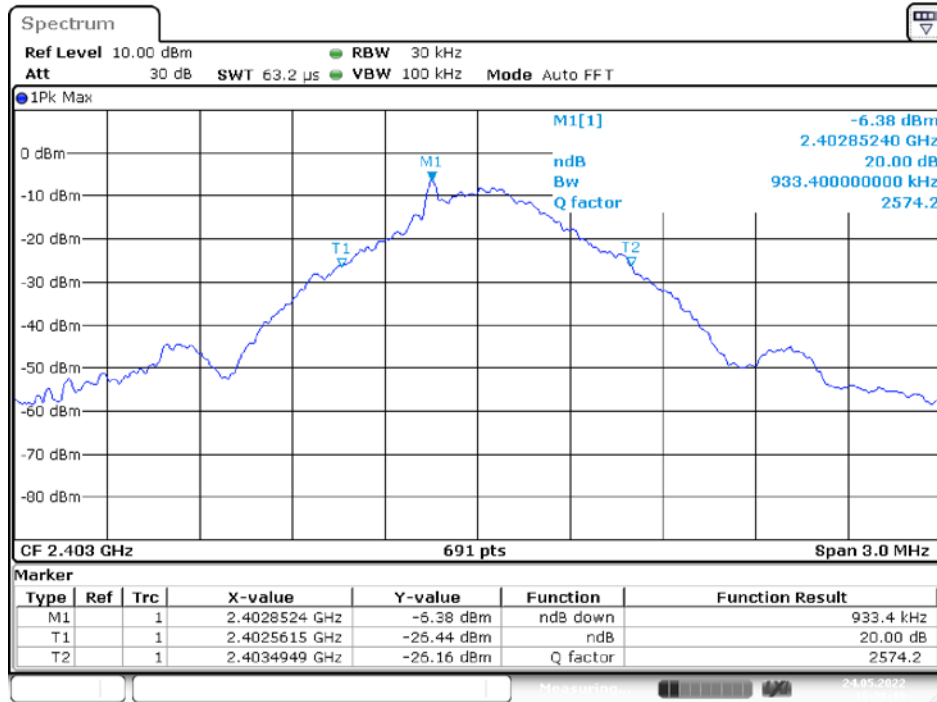

Date: 24.MAY.2022 16:38:19

Middle Channel

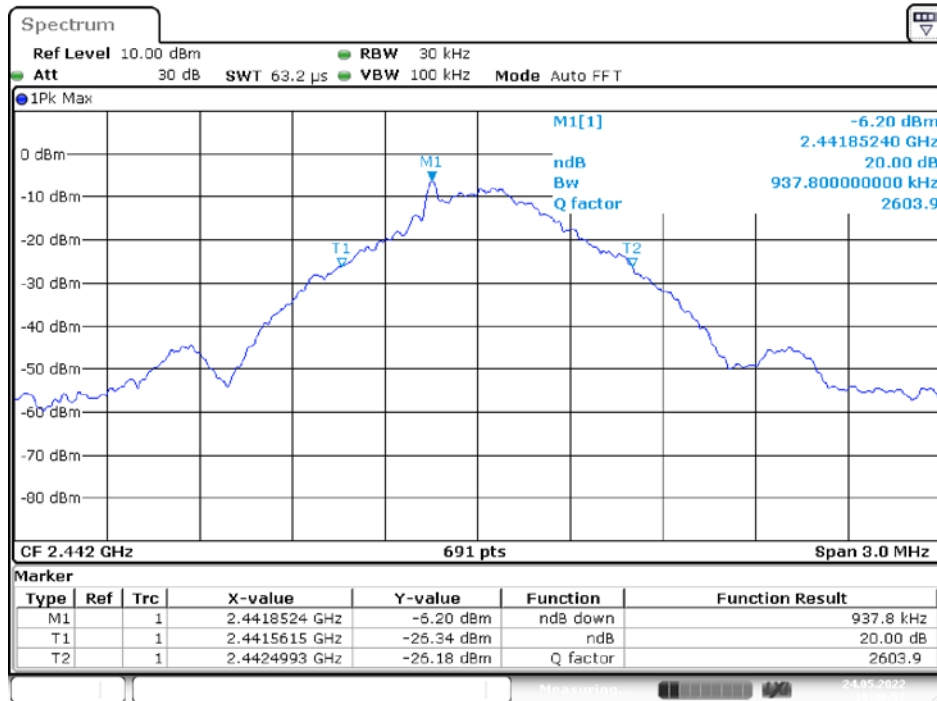

Date: 24.MAY.2022 16:48:58

High Channel

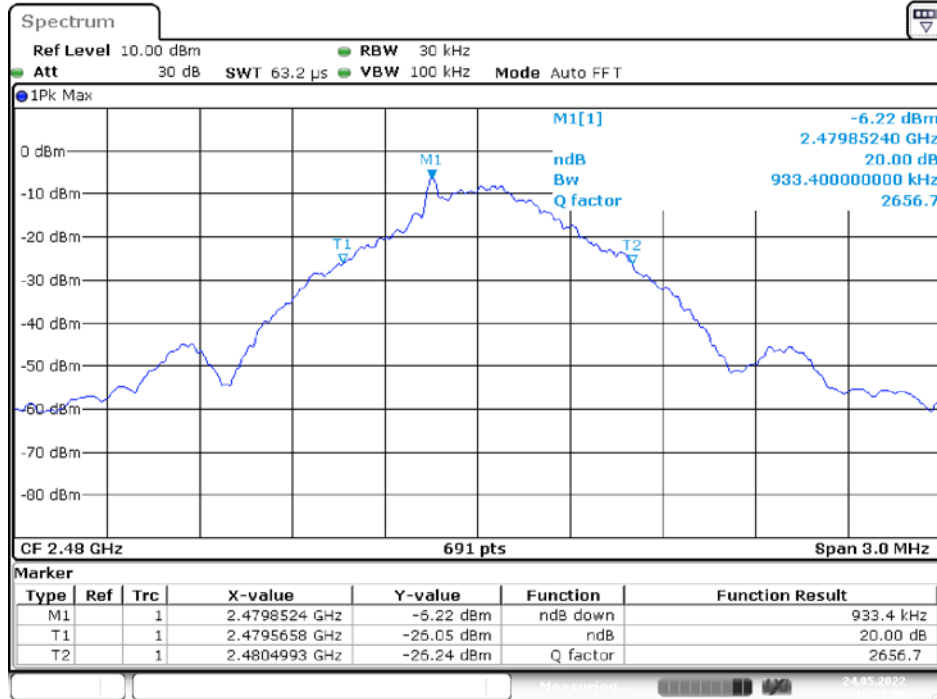

Date: 24.MAY.2022 16:51:06

99% Occupied Bandwidth

Low Channel

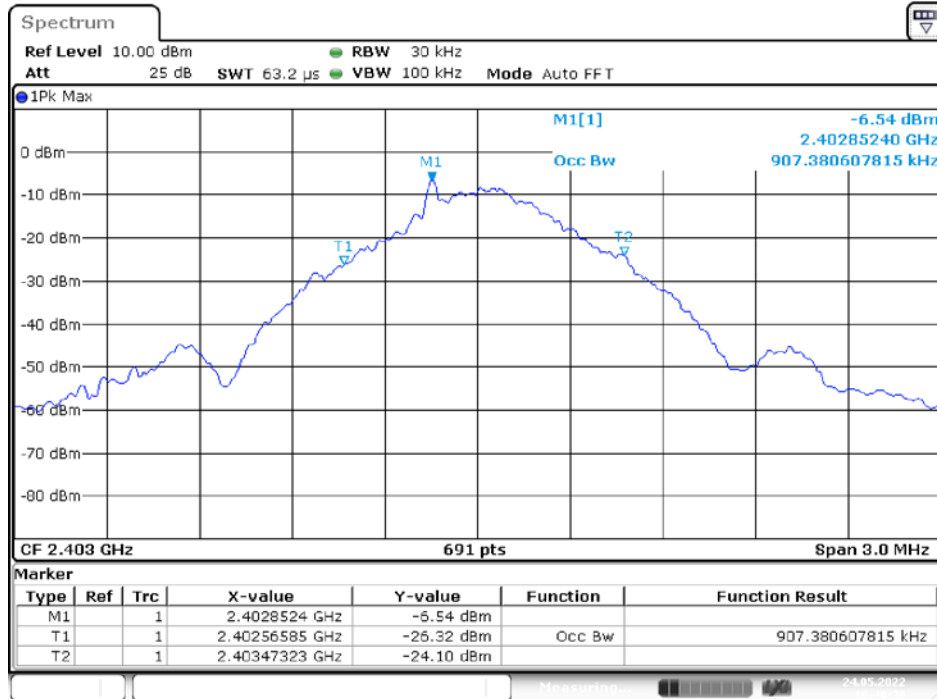

Date: 24.MAY.2022 16:40:38

Middle Channel

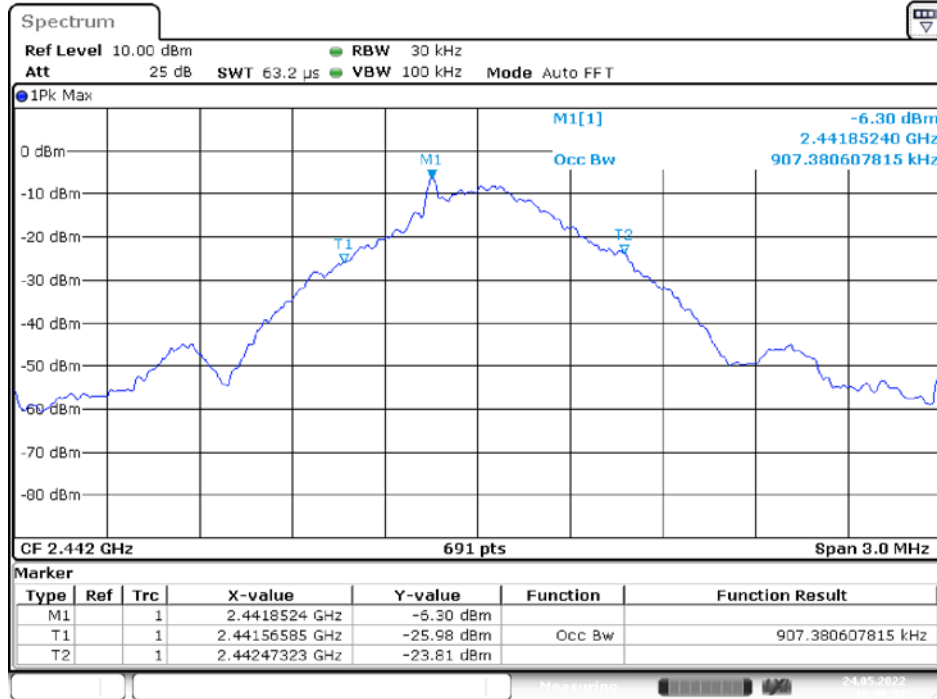

Date: 24.MAY.2022 16:46:52

High Channel

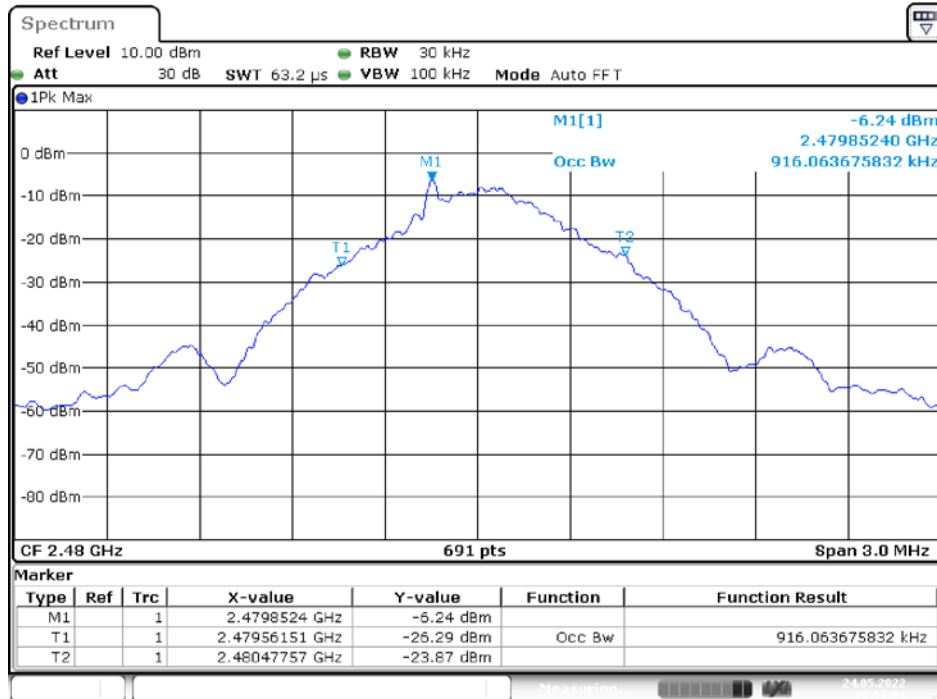

Date: 24.MAY.2022 16:51:51

***** END OF REPORT *****