



EMC TEST REPORT

Applicant UAB Voltas IT
FCC ID 2AVJ4-OBDELEVEN2
Product MOD500
Brand OBDeleven
Model OBDeleven 2
Marketing OBDeleven 2
Report No. R1910A0621-E1V1
Issue Date January 14, 2020

TA Technology (Shanghai) Co., Ltd. tested the above equipment in accordance with the requirements in **FCC Code CFR47 Part15B (2019)/ ANSI C63.4 (2014)**. The test results show that the equipment tested is capable of demonstrating compliance with the requirements as documented in this report.

Wei Liu

Guangchang Fan

Performed by: Wei Liu/ Manager

Approved by: Guangchang Fan/ Director

TA Technology (Shanghai) Co., Ltd.

No.145, Jintang Rd, Tangzhen Industry Park, Pudong Shanghai, China

TEL: +86-021-50791141/2/3

FAX: +86-021-50791141/2/3-8000



Table of Contents

1	Test Laboratory.....	4
1.1	Notes of the Test Report.....	4
1.2.	Test facility.....	4
1.3	Testing Location.....	4
2	General Description of Equipment under Test.....	5
2.1	Applicant and Manufacturer Information.....	5
2.2	General information.....	5
2.3	Applied Standards.....	6
2.4	Test Mode.....	7
3	Test Case Results.....	8
3.1	Radiated Emission.....	8
3.2	Conducted Emission.....	13
4	Main Test Instruments.....	17



Summary of measurement results

Number	Test Case	Clause in FCC Rules	Conclusion
1	Radiated Emission	FCC Part15.109, ANSI C63.4-2014	PASS
2	Conducted Emission	FCC Part15.107, ANSI C63.4-2014	PASS
Test Date: December 27, 2019~January 6, 2020			
Note: All indications of Pass/Fail in this report are opinions expressed by TA Technology (Shanghai) Co., Ltd. based on interpretations and/or observations of test results. Measurement Uncertainties were not taken into account and are published for informational purposes only.			

Note: This revised report (Report No.: R1910A0621-E1V1) supersedes and replaces the previously issued report (Report No.: R1910A0621-E1). Please discard or destroy the previously issued report and dispose of it accordingly.

1 Test Laboratory

1.1 Notes of the Test Report

This report shall not be reproduced in full or partial, without the written approval of **TA technology (shanghai) co., Ltd.** The results documented in this report apply only to the tested sample, under the conditions and modes of operation as described herein .Measurement Uncertainties were not taken into account and are published for informational purposes only. This report is written to support regulatory compliance of the applicable standards stated above.

1.2. Test facility

FCC (Designation number: CN1179, Test Firm Registration Number: 446626)

TA Technology (Shanghai) Co., Ltd. has been listed on the US Federal Communications Commission list of test facilities recognized to perform electromagnetic emissions measurements.

A2LA (Certificate Number: 3857.01)

TA Technology (Shanghai) Co., Ltd. has been listed by American Association for Laboratory Accreditation to perform electromagnetic emission measurement.

1.3 Testing Location

Company: TA Technology (Shanghai) Co., Ltd.
Address: No.145, Jintang Rd, Tangzhen Industry Park, Pudong Shanghai, China
City: Shanghai
Post code: 201201
Country: P. R. China
Contact: Xu Kai
Telephone: +86-021-50791141/2/3
Fax: +86-021-50791141/2/3-8000
Website: <http://www.ta-shanghai.com>
E-mail: xukai@ta-shanghai.com

2 General Description of Equipment under Test

2.1 Applicant and Manufacturer Information

Applicant	UAB Voltas IT
Applicant address	Inovacijų g. 3, Biruliskiu vil. Kaunas, Lithuania
Manufacturer	UAB TELTONIKA
Manufacturer address	Liepkalnio 132A, Vilnius, Lithuania

2.2 General information

EUT Description			
Device Type:	Fixed Device		
Model:	OBDeleven 2		
SN:	AA000036213		
HW Version:	MOD500_21		
SW Version:	0.15.0 (FW ver: GEN2V6)		
Antenna Type:	Internal Antenna		
Frequency:	Band	Tx (MHz)	Rx (MHz)
	Bluetooth:	2402 ~ 2480	2402 ~ 2480
Modulation:	Bluetooth v4.1 LE: GFSK		
Note: The EUT is sent from the applicant to TA and the information of the EUT is declared by the applicant.			



2.3 Applied Standards

According to the specifications of the manufacturer, it must comply with the requirements of the following standards:

Test standards

FCC Code CFR47 Part15B (2019)

ANSI C63.4 (2014)



2.4 Test Mode

Test Mode	
Mode 1	EUT with PC Power Supply + Bluetooth on
Mode 2	External Power Supply + EUT + Bluetooth on

During the test, the preliminary test was performed in all modes, mode 2 are selected as the worst condition. The test data of the worst-case condition was recorded in this report.

3 Test Case Results

3.1 Radiated Emission

Ambient condition

Temperature	Relative humidity	Pressure
24°C~26°C	45%~50%	102.5kPa

Methods of Measurement

The EUT is placed on a non-metallic table 0.8m above the horizontal metal reference ground plane. The distance between EUT and receive antenna should be 3 meters. During the test, the EUT was operating in its typical mode. The test method is according to ANSI C63.4-2014. Sweep the whole frequency band through the range from 30MHz to the 5th harmonic of the carrier. During the test, the height of receive antenna shall be moved from 1 to 4 meters, and the antenna shall be performed under horizontal and vertical polarization. The turn table shall be rotated from 0 to 360 degrees for detecting the maximum of radiated signal level.

The data of cable loss and antenna factor has been calibrated in full testing frequency range before the testing. During the test, the EUT is worked at maximum output power.

Set the spectrum analyzer in the following:

Below 1GHz:

RBW=100 kHz / VBW=300 kHz / Sweep=AUTO

Above 1GHz:

(a) PEAK Detector: RBW=1MHz / VBW=3MHz / Sweep=AUTO

(b) AVERAGE Detector: RBW=1MHz / VBW=3MHz / Sweep=AUTO

The radiated emission was measured in the following position: EUT stand-up position (Z axis), lie-down position (X, Y axis). The worst emission was found in lie-down position (X axis) and the worst case was recorded.

Test Setup

Below 1GHz

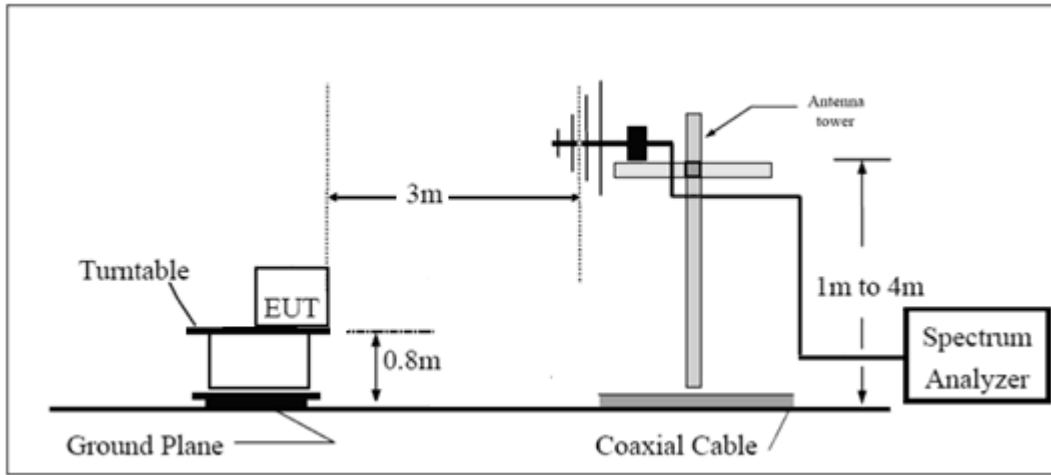

Above 1GHz

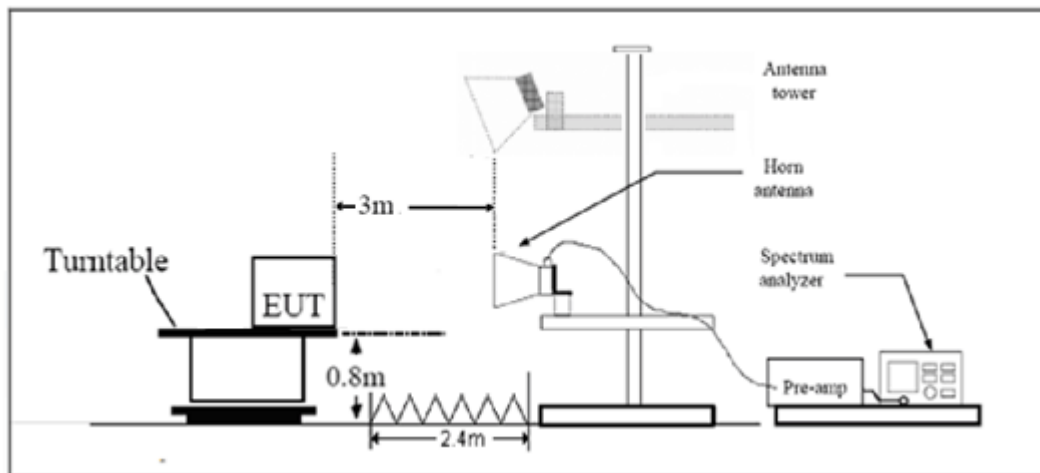

Note: Area side:2.4mX3.6m

Antenna Tower meets ANSI C63.4 requirements for measurements above 1 GHz by keeping the antenna aimed at the EUT during the antenna's ascent/ descent along the antenna mast.

Limits

Frequency (MHz)	Field Strength (dB μ V/m)	Detector
30 -88	40.0	Quasi-peak
88-216	43.5	Quasi-peak
216 – 960	46.0	Quasi-peak
960-1000	54.0	Quasi-peak
1000-5 th harmonic of the highest frequency or 40GHz, which is lower	54 74	Average Peak

Measurement Uncertainty

The assessed measurement uncertainty to ensure 95% confidence level for the normal distribution is with the coverage factor $k = 1.96$.

Frequency	Uncertainty
30MHz~200MHz	4.02 dB
200MHz~1000MHz	3.28 dB
1GHz~18GHz	3.70 dB

Test Results

Sweep the whole frequency band through the range from 30MHz to the 5th harmonic of the carrier, the Emissions in the frequency band 18GHz- 26.5 GHz is more than 20dB below the limit are not reported.

The following graphs display the maximum values of horizontal and vertical by software.
For above 1GHz, Blue trace uses the peak detection, Green trace uses the average detection.

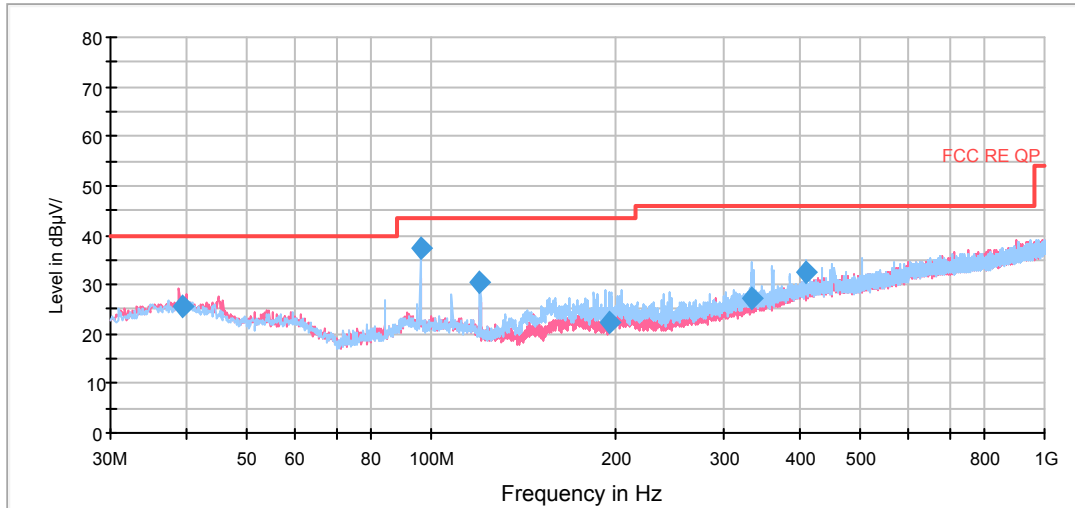

Radiated Emission from 30MHz to 1GHz

Frequency (MHz)	Quasi-Peak (dBuV/m)	Height (cm)	Polarization	Azimuth (deg)	Correct Factor (dB)	Margin (dB)	Limit (dBuV/m)
39.211250	25.4	100.0	V	227.0	16.9	14.6	40.0
96.041250	37.3	200.0	H	300.0	13.1	6.2	43.5
120.010000	30.3	200.0	H	300.0	11.4	13.2	43.5
195.425000	22.4	100.0	H	288.0	11.8	21.1	43.5
332.483750	27.4	100.0	H	49.0	16.7	18.6	46.0
408.100000	32.4	100.0	H	331.0	19.7	13.6	46.0

- Remark: 1. Correction Factor = Antenna factor+ Insertion loss(cable loss+amplifier gain)**
2. Margin = Limit – Quasi-Peak

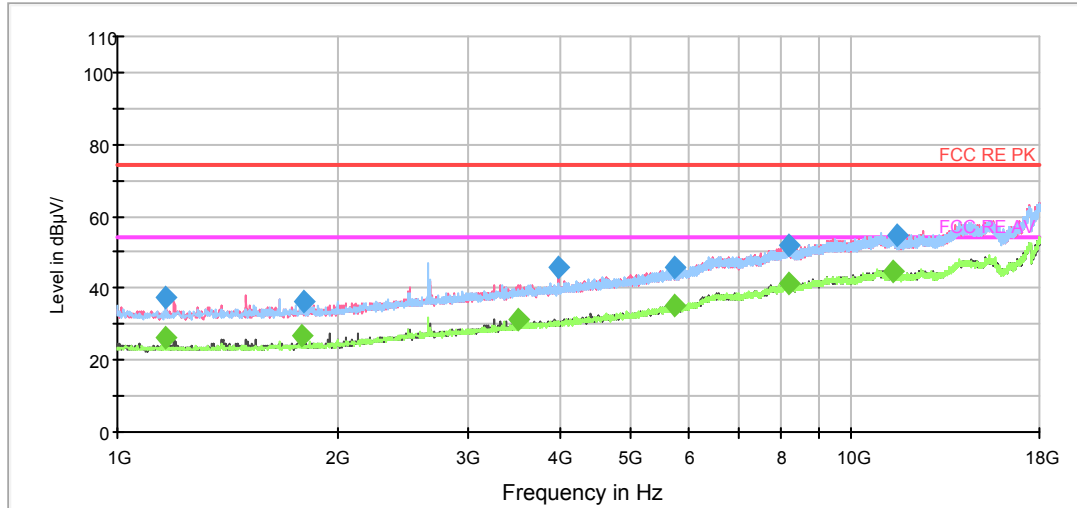

Radiated Emission from 1GHz to 18GHz

Frequency (MHz)	Peak (dBuV/m)	Height (cm)	Polarization	Azimuth (deg)	Correct Factor (dB)	Margin (dB)	Limit (dBuV/m)
1163.625000	37.5	100.0	V	340.0	-11.3	36.5	74.0
1792.625000	36.4	100.0	V	260.0	-9.4	37.6	74.0
3981.375000	45.7	100.0	V	331.0	-2.8	28.3	74.0
5736.625000	45.5	100.0	H	20.0	1.5	28.5	74.0
8182.500000	52.1	100.0	H	13.0	8.6	21.9	74.0
11529.375000	55.0	100.0	H	40.0	13.3	19.0	74.0

Frequency (MHz)	Average (dBuV/m)	Height (cm)	Polarization	Azimuth (deg)	Correct Factor (dB)	Margin (dB)	Limit (dBuV/m)
1165.750000	26.4	100.0	V	340.0	-11.3	27.6	54.0
1784.125000	26.5	100.0	V	223.0	-9.4	27.5	54.0
3511.750000	31.5	100.0	H	136.0	-3.8	22.5	54.0
5738.750000	35.0	100.0	H	1.0	1.5	19.0	54.0
8193.125000	41.6	200.0	H	0.0	8.6	12.4	54.0
11391.250000	44.9	100.0	H	29.0	13.6	9.1	54.0

3.2 Conducted Emission

Ambient condition

Temperature	Relative humidity	Pressure
24°C ~26°C	50%~55%	102.5kPa

Methods of Measurement

The EUT is placed on a non-metallic table of 80cm height above the horizontal metal reference ground plane. During the test, the EUT was operating in its typical mode. The test method is according to ANSI C63.4-2014. Connect the AC power line of the EUT to the L.I.S.N. Use EMI receiver to detect the average and Quasi-peak value. RBW is set to 9 kHz, VBW is set to 30kHz. The measurement result should include both L line and N line.

During the test, EUT is connected to a laptop via a USB cable in the case of Transfer Data mode. The EUT is used as the peripheral equipment of the PC. The data is transferred from EUT to PC; PC is connected to server via a long LAN cable.

Test Setup

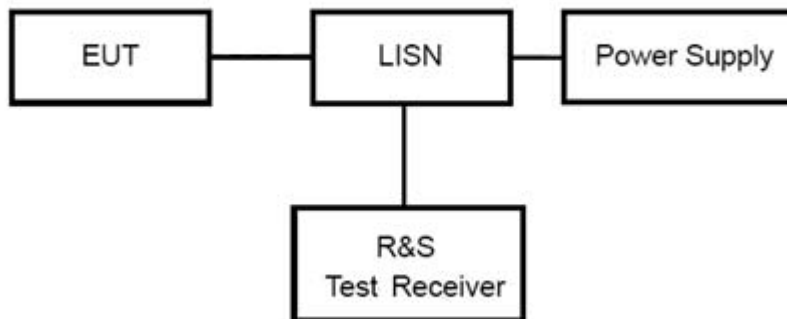

Note: Power Supply is AC Power source and it is used to change the voltage 120V/60Hz.

Limits

Frequency (MHz)	Conducted Limits(dBμV)	
	Quasi-peak	Average
0.15 - 0.5	66 to 56 *	56 to 46 *
0.5 - 5	56	46
5 - 30	60	50

*: Decreases with the logarithm of the frequency.



Measurement Uncertainty

The assessed measurement uncertainty to ensure 95% confidence level for the normal distribution is with the coverage factor $k = 1.96$. $U = 2.57$ dB.

Test Results

Following plots, Blue trace uses the peak detection; Green trace uses the average detection.

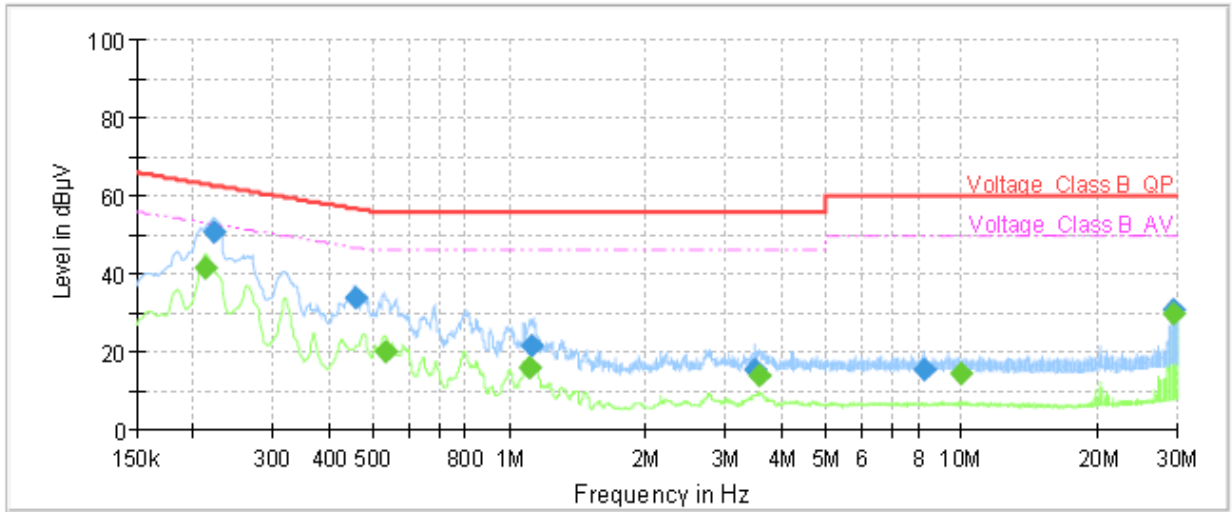

Frequency (MHz)	QuasiPeak (dBµV)	Average (dBµV)	Limit (dBµV)	Margin (dB)	Meas. Time (ms)	Bandwidth (kHz)	Line	Filter	Corr. (dB)
0.21	---	41.71	53.09	11.38	1000.0	9.000	L1	ON	19
0.22	50.81	---	62.74	11.93	1000.0	9.000	L1	ON	19
0.46	34.02	---	56.77	22.75	1000.0	9.000	L1	ON	19
0.53	---	19.86	46.00	26.14	1000.0	9.000	L1	ON	19
1.11	---	15.88	46.00	30.12	1000.0	9.000	L1	ON	19
1.12	21.57	---	56.00	34.43	1000.0	9.000	L1	ON	19
3.50	15.34	---	56.00	40.66	1000.0	9.000	L1	ON	19
3.58	---	13.91	46.00	32.09	1000.0	9.000	L1	ON	19
8.22	15.54	---	60.00	44.46	1000.0	9.000	L1	ON	19
9.94	---	14.31	50.00	35.69	1000.0	9.000	L1	ON	19
29.24	---	29.78	50.00	20.22	1000.0	9.000	L1	ON	20
29.24	30.89	---	60.00	29.11	1000.0	9.000	L1	ON	20

Remark: Correct factor=cable loss + LISN factor

L line

Conducted Emission from 150 KHz to 30 MHz

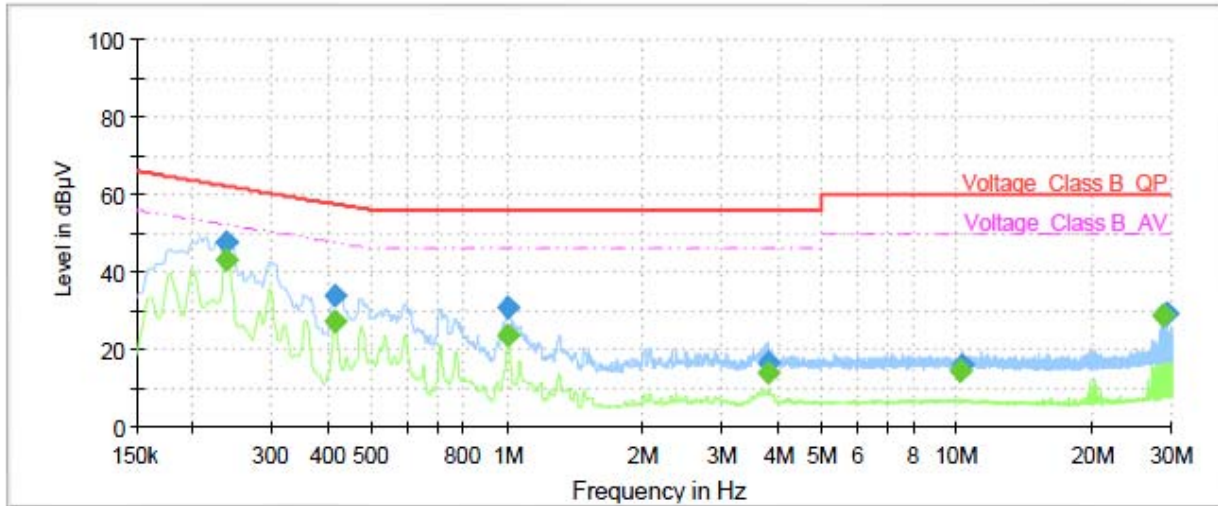

Frequency (MHz)	QuasiPeak (dBµV)	Average (dBµV)	Limit (dBµV)	Margin (dB)	Meas. Time (ms)	Bandwidth (kHz)	Line	Filter	Corr. (dB)
0.24	---	42.89	52.17	9.28	1000.0	9.000	N	ON	19
0.24	47.78	---	62.17	14.39	1000.0	9.000	N	ON	19
0.42	---	27.41	47.54	20.13	1000.0	9.000	N	ON	19
0.42	33.65	---	57.54	23.89	1000.0	9.000	N	ON	19
1.00	30.56	---	56.00	25.44	1000.0	9.000	N	ON	19
1.01	---	23.75	46.00	22.25	1000.0	9.000	N	ON	19
3.80	---	14.04	46.00	31.96	1000.0	9.000	N	ON	19
3.82	16.65	---	56.00	39.35	1000.0	9.000	N	ON	19
10.19	---	14.23	50.00	35.77	1000.0	9.000	N	ON	19
10.29	15.75	---	60.00	44.25	1000.0	9.000	N	ON	19
28.69	---	28.69	50.00	21.31	1000.0	9.000	N	ON	20
29.24	29.15	---	60.00	30.85	1000.0	9.000	N	ON	20

Remark: Correct factor=cable loss + LISN factor

N line

Conducted Emission from 150 KHz to 30 MHz

4 Main Test Instruments

Name	Manufacturer	Type	Serial Number	Calibration Date	Expiration Time
Spectrum Analyzer	R&S	FSV40	15195-01-00	2019-05-19	2020-05-18
EMI Test Receiver	R&S	ESCI	100948	2019-05-19	2020-05-18
Trilog Antenna	SCHWARZBECK	VULB 9163	9163-201	2017-11-18	2020-11-17
Horn Antenna	R&S	HF907	100126	2018-07-07	2020-07-06
Standard Gain Horn	ETS-Lindgren	3160-09	00102643	2018-06-20	2020-06-19
EMI Test Receiver	R&S	ESR	101667	2019-05-19	2020-05-18
LISN	R&S	ENV216	101171	2019-12-15	2020-12-14
Bore Sight Antenna mast	ETS	2171B	00058752	/	/
Test software	EMC32	R&S	9.26.0	/	/

*****END OF REPORT *****