



Report No.:

TW2309162-03

Applicant:

SHENZHEN JINGWEIXIAN TECHNOLOGY CO., LTD

Product:

Cutting Plotter

Model No.:

MINI XR, MAGIC FROG, MINI 13, MINI ZV1, MINI ZV2, MINI ZV3, MINI ZV1-B, MINI ZV2-B, MINI ZV3-B, DC MINI 1, DC MINI 2, DC MINI 3, DCM 1, DCM 2, DCM 3

Trademark:

SKYCUT

Test Standards:

FCC Part 15.247

Test result:

It is herewith confirmed and found to comply with the requirements set up by ANSI C63.10, FCC Part 15.247 for the evaluation of electromagnetic compatibility

Approved By

A handwritten signature in black ink that reads 'Terry Tang'.

Terry Tang

Manager

Dated:

October 13, 2023

**Results appearing herein relate only to the sample tested**

**The technical reports is issued errors and omissions exempt and is subject to withdrawal at**

**SHENZHEN TIMEWAY TESTING LABORATORIES**

Zone C, 1st Floor, Block B, Jun Xiang Da Building, Zhongshan Park Road West, Tong Le Village, Nanshan District, Shenzhen, China

Tel (755) 83448688, Fax (755) 83442996, E-Mail:info@timeway-lab.com

TEST REPORT



### **Special Statement:**

The testing quality ability of our laboratory meet with "Quality Law of People's Republic of China" Clause 19.

The testing quality system of our laboratory meet with ISO/IEC-17025 requirements, which is approved by CNAS. This approval result is accepted by MRA of APLAC.

Our test facility is recognized, certified, or accredited by the following organizations:

#### **CNAS-LAB Code: L2292**

The EMC Laboratory has been assessed and in compliance with CNAS-CL01 accreditation criteria for testing Laboratories (identical to ISO/IEC 17025:2017 General Requirements) for the Competence of testing Laboratories.

#### **FCC-Registration No.: 744189**

The EMC Laboratory has been registered and fully described in a report filed with the (FCC) Federal Communications commission. The acceptance letter from the FCC is maintained in our files. Registration No.: 744189.

#### **Industry Canada (IC) —Registration No.:5205A**

The EMC Laboratory has been registered by Certification and Engineering Bureau of Industry Canada for radio equipment testing with Registration No.: 5205A.

#### **A2LA (Certification Number:5013.01)**

The EMC Laboratory has been accredited by the American Association for Laboratory Accreditation (A2LA). Certification Number:5013.01

The report refers only to the sample tested and does not apply to the bulk.

This report is issued in confidence to the client and it will be strictly treated as such by the SHENZHEN TIMEWAY TESTING LABORATORIES. It may not be reproduced rather in its entirety or in part and it may not be used for adverting. The client to whom the report is issued may, however, show or send it . or a certified copy there of prepared by the SHENZHEN TIMEWAY TESTING LABORATORIES. to his customer. Supplier or others persons directly concerned. SHENZHEN TIMEWAY TESTING LABORATORIES. will not, without the consent of the client enter into any discussion of correspondence with any third party concerning the contents of the report.

In the event of the improper use of the report. The SHENZHEN TIMEWAY TESTING LABORATORIES. reserves the rights to withdraw it and to adopt any other remedies which may be appropriate.



Test Report Conclusion

Content

<b>1.0</b>	<b>General Details</b> .....	4
1.1	Test Lab Details.....	4
1.2	Applicant Details.....	4
1.3	Description of EUT .....	4
1.4	Submitted Sample.....	4
1.5	Test Duration.....	4
1.6	Test Uncertainty.....	4
1.7	Test By.....	5
<b>2.0</b>	<b>List of Measurement Equipment</b> .....	6
<b>3.0</b>	<b>Technical Details</b> .....	7
3.1	Summary of Test Results.....	7
3.2	Test Standards.....	7
<b>4.0</b>	<b>EUT Modification</b> .....	7
<b>5.0</b>	<b>Power Line Conducted Emission Test</b> .....	8
5.1	Schematics of the Test.....	8
5.2	Test Method and Test Procedure.....	8
5.3	Configuration of the EUT.....	8
<b>5.4</b>	<b>EUT Operating Condition</b> .....	9
<b>5.5</b>	<b>Conducted Emission Limit</b> .....	9
<b>5.6</b>	<b>Test Result</b> .....	9
<b>6.0</b>	<b>Radiated Emission test</b> .....	12
6.1	Test Method and Test Procedure.....	12
6.2	Configuration of the EUT.....	13
6.3	EUT Operation Condition.....	13
6.4	Radiated Emission Limit.....	13
7.0	20dB Bandwidth .....	20
8.0	Maximum Output Power.....	26
9.0	Carrier Frequency Separation.....	33
10.0	Number of Hopping Channel.....	41
11.0	Time of Occupancy (Dwell Time).....	45
12.0	Out of Band Measurement.....	56
13.0	Antenna Requirement.....	84
14.0	FCC ID Label.....	85
15.0	Photo of Test Setup and EUT View.....	86

The report refers only to the sample tested and does not apply to the bulk.

This report is issued in confidence to the client and it will be strictly treated as such by the SHENZHEN TIMEWAY TESTING LABORATORIES. It may not be reproduced rather in its entirety or in part and it may not be used for advertising. The client to whom the report is issued may, however, show or send it, or a certified copy thereof prepared by the SHENZHEN TIMEWAY TESTING LABORATORIES, to his customer, Supplier or others persons directly concerned. SHENZHEN TIMEWAY TESTING LABORATORIES, will not, without the consent of the client enter into any discussion of correspondence with any third party concerning the contents of the report.

In the event of the improper use of the report. The SHENZHEN TIMEWAY TESTING LABORATORIES, reserves the rights to withdraw it and to adopt any other remedies which may be appropriate.



## 1.0 General Details

### 1.1 Test Lab Details

Name: SHENZHEN TIMEWAY TESTING LABORATORIES.  
Address: Zone C, 1st Floor, Block B, Jun Xiang Da Building, Zhongshan Park Road West, Tong Le Village, Nanshan District, Shenzhen, China  
Telephone: (755) 83448688  
Fax: (755) 83442996

### 1.2 Applicant Details

Applicant: SHENZHEN JINGWEIXIAN TECHNOLOGY CO., LTD  
Address: Building C, XinHang Technology Park, No.229, Qingshui Road, WulianCommunity, Longgang Street, Longgang District, Shenzhen, 518116, China  
Telephone: --  
Fax: --

### 1.3 Description of EUT

Product: Cutting Plotter  
Manufacturer: SHENZHEN JINGWEIXIAN TECHNOLOGY CO., LTD  
Address: Building C, XinHang Technology Park, No.229, Qingshui Road, WulianCommunity, Longgang Street, Longgang District, Shenzhen, 518116, China  
Trademark: N/A  
Model Number: MINI XR  
Additional Model Number: MAGIC FROG, MINI 13, MINI ZV1, MINI ZV2, MINI ZV3, MINI ZV1-B, MINI ZV2-B, MINI ZV3-B, DC MINI 1, DC MINI 2, DC MINI 3, DCM 1, DCM 2, DCM 3  
Hardware Version: VF22.0301  
Software Version: V23.0821  
Serial No.: DX13490032020088F  
Type of Modulation: GFSK,  $\pi/4$ DQPSK, 8DPSK for Bluetooth  
Frequency range: 2402-2480MHz for Bluetooth  
Channel Spacing: 1MHz for Bluetooth  
Frequency Selection: By software  
Channel Number: 79 channels for Bluetooth  
Antenna: PCB Antenna. The gain of the antennas is -0.1dBi (Get from the antenna specification provided the manufacturer)  
Input Voltage: DC24V, 1.5A  
Power Supply: Model: FJ-SW7292401500N  
Input: 100-240V~, 50/60Hz, 1.5A MAX; Output: DC24V, 1.5A36W

### 1.4 Submitted Sample: 6 Samples

The report refers only to the sample tested and does not apply to the bulk.

This report is issued in confidence to the client and it will be strictly treated as such by the SHENZHEN TIMEWAY TESTING LABORATORIES. It may not be reproduced rather in its entirety or in part and it may not be used for advertising. The client to whom the report is issued may, however, show or send it or a certified copy thereof prepared by the SHENZHEN TIMEWAY TESTING LABORATORIES to his customer. Supplier or others persons directly concerned. SHENZHEN TIMEWAY TESTING LABORATORIES will not, without the consent of the client enter into any discussion of correspondence with any third party concerning the contents of the report.

In the event of the improper use of the report. The SHENZHEN TIMEWAY TESTING LABORATORIES reserves the rights to withdraw it and to adopt any other remedies which may be appropriate.



1.5 Test Duration

2023-09-14 to 2023-10-13

1.6 Test Uncertainty

Conducted Emissions Uncertainty =3.6dB

Radiated Emissions below 1GHz Uncertainty =4.7dB

Radiated Emissions above 1GHz Uncertainty =6.0dB

Conducted Power Uncertainty =6.0dB

Occupied Channel Bandwidth Uncertainty =5%

Note: The measurement uncertainty is for coverage factor of  $k=2$  and a level of confidence of 95%.

1.7 Test Engineer

The sample tested by

*Andy Xing*

Print Name: Andy Xing

The report refers only to the sample tested and does not apply to the bulk.

This report is issued in confidence to the client and it will be strictly treated as such by the SHENZHEN TIMEWAY TESTING LABORATORIES. It may not be reproduced rather in its entirety or in part and it may not be used for advertising. The client to whom the report is issued may, however, show or send it or a certified copy thereof prepared by the SHENZHEN TIMEWAY TESTING LABORATORIES to his customer. Supplier or others persons directly concerned. SHENZHEN TIMEWAY TESTING LABORATORIES will not, without the consent of the client enter into any discussion of correspondence with any third party concerning the contents of the report.

In the event of the improper use of the report. The SHENZHEN TIMEWAY TESTING LABORATORIES reserves the rights to withdraw it and to adopt any other remedies which may be appropriate.



<b>2.0 Test Equipment</b>					
Instrument Type	Manufacturer	Model	Serial No.	Date of Cal.	Due Date
ESPI Test Receiver	R&S	ESPI 3	100379	2023-07-14	2024-07-13
LISN	R&S	EZH3-Z5	100294	2023-07-14	2024-07-13
LISN	R&S	EZH3-Z5	100253	2023-07-14	2024-07-13
Impuls-Begrenzer	R&S	ESH3-Z2	100281	2023-07-14	2024-07-13
Loop Antenna	EMCO	6507	00078608	2022-07-18	2025-07-17
Spectrum	R&S	FSIQ26	100292	2023-07-14	2024-07-13
Horn Antenna	A-INFO	LB-180400-KF	J211060660	2022-07-18	2025-07-17
Horn Antenna	R&S	BBHA 9120D	9120D-631	2022-07-18	2024-07-17
Power meter	Anritsu	ML2487A	6K00003613	2023-07-14	2024-07-13
Power sensor	Anritsu	MA2491A	32263	2023-07-14	2024-07-13
Bilog Antenna	Schwarebeck	VULB9163	9163/340	2022-07-18	2025-07-17
9*6*6 Anechoic	--	--	N/A	2022-07-26	2025-07-25
EMI Test Receiver	RS	ESVB	826156/011	2023-07-14	2024-07-13
EMI Test Receiver	RS	ESCS 30	834115/006	2023-07-14	2024-07-13
Spectrum	HP/Agilent	E4407B	MY50441392	2023-07-14	2024-07-13
Spectrum	RS	FSP	1164.4391.38	2023-07-14	2024-07-13
RF Cable	Zhengdi	ZT26-NJ-NJ-8M/FA	--	2023-07-14	2024-07-13
RF Cable	Zhengdi	7m	--	2023-07-14	2024-07-13
Pre-Amplifier	Schwarebeck	BBV9743	#218	2023-07-14	2024-07-13
Pre-Amplifier	HP/Agilent	8449B	3008A00160	2023-07-14	2024-07-13
LISN	SCHAFFNER	NNB42	00012	2023-07-14	2024-07-13
ESPI Test Receiver	R&S	ESPI 3	100379	2023-07-14	2024-07-13
LISN	R&S	EZH3-Z5	100294	2023-07-14	2024-07-13

## 2.2 Automation Test Software

### For Conducted Emission Test

Name	Version
EZ-EMC	Ver.EMC-CON 3A1.1

### For Radiated Emissions

Name	Version
EMI Test Software BL410-EV18.91	V18.905
EMI Test Software BL410-EV18.806 High Frequency	V18.06

The report refers only to the sample tested and does not apply to the bulk.

This report is issued in confidence to the client and it will be strictly treated as such by the SHENZHEN TIMEWAY TESTING LABORATORIES. It may not be reproduced rather in its entirety or in part and it may not be used for advertising. The client to whom the report is issued may, however, show or send it . or a certified copy thereof prepared by the SHENZHEN TIMEWAY TESTING LABORATORIES. to his customer. Supplier or others persons directly concerned. SHENZHEN TIMEWAY TESTING LABORATORIES. will not, without the consent of the client enter into any discussion of correspondence with any third party concerning the contents of the report.

In the event of the improper use of the report. The SHENZHEN TIMEWAY TESTING LABORATORIES. reserves the rights to withdraw it and to adopt any other remedies which may be appropriate.



**3.0 Technical Details**

**3.1 Summary of test results**

<b>The EUT has been tested according to the following specifications:</b>			
<b>Requirement</b>	<b>CFR 47 Section</b>	<b>Result</b>	<b>Notes</b>
<b>Antenna Requirement</b>	<b>15.203, 15.247(b)(4)</b>	<b>Pass</b>	<b>Complies</b>
<b>Maximum Peak Out Power</b>	<b>15.247 (b)(1), (4)</b>	<b>Pass</b>	<b>Complies</b>
<b>Carrier Frequency Separation</b>	<b>15.247(a)(1)</b>	<b>Pass</b>	<b>Complies</b>
<b>20dB Channel Bandwidth</b>	<b>15.247 (a)(1)</b>	<b>Pass</b>	<b>Complies</b>
<b>Number of Hopping Channels</b>	<b>15.247(a)(iii), 15.247(b)(1)</b>	<b>Pass</b>	<b>Complies</b>
<b>Time of Occupancy (Dwell Time)</b>	<b>15.247(a)(iii)</b>	<b>Pass</b>	<b>Complies</b>
<b>Spurious Emission, Band Edge, and Restricted bands</b>	<b>15.247(d),15.205(a), 15.209 (a),15.109</b>	<b>Pass</b>	<b>Complies</b>
<b>Conducted Emissions</b>	<b>15.207(a), 15.107</b>	<b>Pass</b>	<b>Complies</b>
<b>RF Exposure</b>	<b>15.247(i), 1.1307(b)(1)</b>	<b>Pass</b>	<b>Complies</b>

**3.2 Test Standards**

**FCC Part 15 Subpart & Subpart C, Paragraph 15.247**

**4.0 EUT Modification**

**No modification by SHENZHEN TIMEWAY TESTING LABORATORIES.**

The report refers only to the sample tested and does not apply to the bulk.  
 This report is issued in confidence to the client and it will be strictly treated as such by the SHENZHEN TIMEWAY TESTING LABORATORIES. It may not be reproduced rather in its entirety or in part and it may not be used for advertising. The client to whom the report is issued may, however, show or send it or a certified copy thereof prepared by the SHENZHEN TIMEWAY TESTING LABORATORIES to his customer. Supplier or others persons directly concerned. SHENZHEN TIMEWAY TESTING LABORATORIES will not, without the consent of the client enter into any discussion of correspondence with any third party concerning the contents of the report.  
 In the event of the improper use of the report. The SHENZHEN TIMEWAY TESTING LABORATORIES reserves the rights to withdraw it and to adopt any other remedies which may be appropriate.



**5. Power Line Conducted Emission Test**

5.1 Schematics of the test

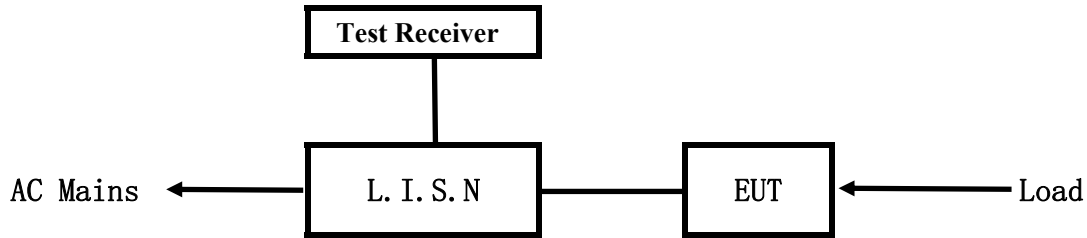

EUT: Equipment Under Test

5.2 Test Method and test Procedure

The EUT was tested according to ANSI C63.10-2013. The Frequency spectrum From 0.15MHz to 30MHz was investigated. The LISN used was 50ohm/50uH as specified by section 5.1 of ANSI C63.10-2013.  
 Test Voltage: 120V~ 60Hz

Block diagram of Test setup

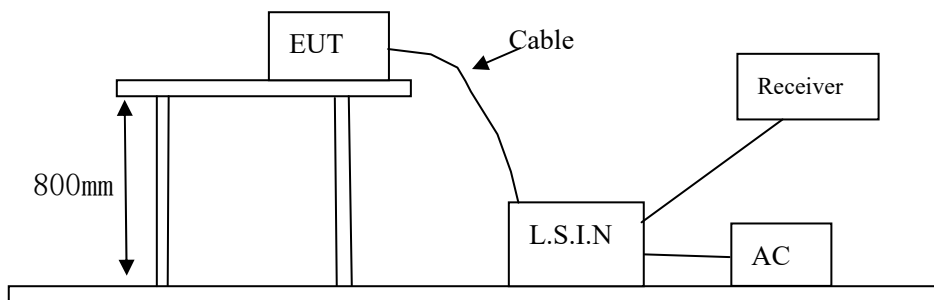

5.3 Configuration of the EUT

The EUT was configured according to ANSI C63.10-2013. All interface ports were connected to the appropriate peripherals. All peripherals and cables are listed below.

A. EUT

Device	Manufacturer	Model	FCC ID
--------	--------------	-------	--------

The report refers only to the sample tested and does not apply to the bulk.  
 This report is issued in confidence to the client and it will be strictly treated as such by the SHENZHEN TIMEWAY TESTING LABORATORIES. It may not be reproduced rather in its entirety or in part and it may not be used for advertizing. The client to whom the report is issued may, however, show or send it . or a certified copy there of prepared by the SHENZHEN TIMEWAY TESTING LABORATORIES. to his customer. Supplier or others persons directly concerned. SHENZHEN TIMEWAY TESTING LABORATORIES. will not, without the consent of the client enter into any discussion of correspondence with any third party concerning the contents of the report.  
 In the event of the improper use of the report. The SHENZHEN TIMEWAY TESTING LABORATORIES. reserves the rights to withdraw it and to adopt any other remedies which may be appropriate.





Cutting Plotter	SHENZHEN JINGWEIXIAN TECHNOLOGY CO., LTD	MINI XR, MAGIC FROG, MINI 13, MINI ZV1, MINI ZV2, MINI ZV3, MINI ZV1-B, MINI ZV2-B, MINI ZV3-B, DC MINI 1, DC MINI 2, DC MINI 3, DCM 1, DCM 2, DCM 3	2AVGR-MINIXR
-----------------	---	---	--------------

B. Internal Device

Device	Manufacturer	Model	Rating

C. Peripherals

Device	Manufacturer	Model	Rating
N/A			

5.4 EUT Operating Condition

Operating condition is according to ANSI C63.10-2013.

A Setup the EUT and simulators as shown on follow

B Enable AF signal and confirm EUT active to normal condition

5.5 Power line conducted Emission Limit according to Paragraph 15.207

Frequency (MHz)	Limits (dB $\mu$ V)	
	Quasi-peak Level	Average Level
0.15 ~ 0.50	66.0~56.0*	56.0~46.0*
0.50 ~ 5.00	56.0	46.0
5.00 ~ 30.00	60.0	50.0

- Notes: 1. \*Decreasing linearly with logarithm of frequency.  
 2. The tighter limit shall apply at the transition frequencies

5.6 Test Results

The frequency spectrum from 0.15MHz to 30MHz was investigated. All reading are quasi-peak values with a resolution bandwidth of 9kHz.

The report refers only to the sample tested and does not apply to the bulk.  
 This report is issued in confidence to the client and it will be strictly treated as such by the SHENZHEN TIMEWAY TESTING LABORATORIES. It may not be reproduced rather in its entirety or in part and it may not be used for adverting. The client to whom the report is issued may, however, show or send it . or a certified copy there of prepared by the SHENZHEN TIMEWAY TESTING LABORATORIES. to his customer. Supplier or others persons directly concerned. SHENZHEN TIMEWAY TESTING LABORATORIES. will not, without the consent of the client enter into any discussion of correspondence with any third party concerning the contents of the report.  
 In the event of the improper use of the report. The SHENZHEN TIMEWAY TESTING LABORATORIES. reserves the rights to withdraw it and to adopt any other remedies which may be appropriate.



**A: Conducted Emission on Live Terminal (150kHz to 30MHz)**

**EUT Operating Environment**

Temperature: 26°C Humidity: 65%RH Atmospheric Pressure: 101 kPa

**EUT set Condition: Keep Bluetooth Transmitting**

**Results: Pass**

Please refer to following diagram for individual

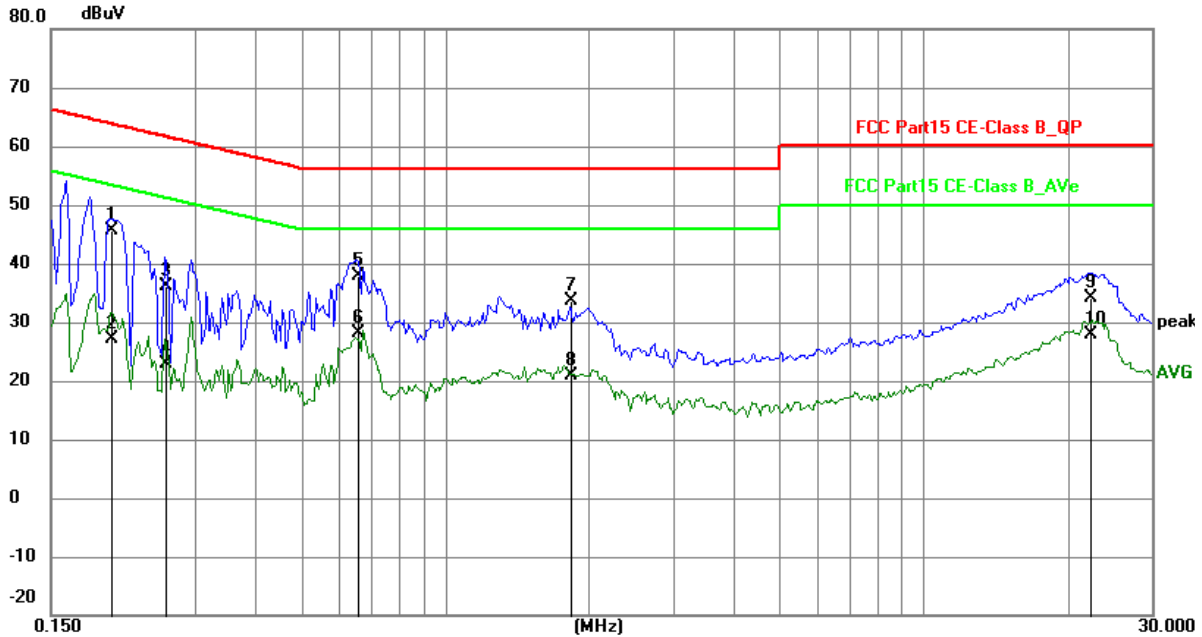

No.	Frequency (MHz)	Reading (dBuV)	Factor (dB)	Level (dBuV)	Limit (dBuV)	Margin (dB)	Detector	P/F
1	0.2007	35.87	9.75	45.62	63.58	-17.96	QP	P
2	0.2007	17.26	9.75	27.01	53.58	-26.57	AVG	P
3	0.2592	26.35	9.75	36.10	61.46	-25.36	QP	P
4	0.2592	13.20	9.75	22.95	51.46	-28.51	AVG	P
5	0.6570	28.20	9.78	37.98	56.00	-18.02	QP	P
6	0.6570	18.35	9.78	28.13	46.00	-17.87	AVG	P
7	1.8270	23.76	9.80	33.56	56.00	-22.44	QP	P
8	1.8270	11.06	9.80	20.86	46.00	-25.14	AVG	P
9	22.1801	23.28	10.82	34.10	60.00	-25.90	QP	P
10	22.1801	16.98	10.82	27.80	50.00	-22.20	AVG	P

The report refers only to the sample tested and does not apply to the bulk.  
 This report is issued in confidence to the client and it will be strictly treated as such by the SHENZHEN TIMEWAY TESTING LABORATORIES. It may not be reproduced rather in its entirety or in part and it may not be used for advertising. The client to whom the report is issued may, however, show or send it, or a certified copy thereof prepared by the SHENZHEN TIMEWAY TESTING LABORATORIES, to his customer. Supplier or others persons directly concerned. SHENZHEN TIMEWAY TESTING LABORATORIES, will not, without the consent of the client enter into any discussion of correspondence with any third party concerning the contents of the report.  
 In the event of the improper use of the report. The SHENZHEN TIMEWAY TESTING LABORATORIES, reserves the rights to withdraw it and to adopt any other remedies which may be appropriate.



**B: Conducted Emission on Neutral Terminal (150kHz to 30MHz)**

**EUT Operating Environment**

Temperature: 26°C Humidity: 65%RH Atmospheric Pressure: 101 kPa

**EUT set Condition: Keep Bluetooth Transmitting**

**Results: Pass**

Please refer to following diagram for individual

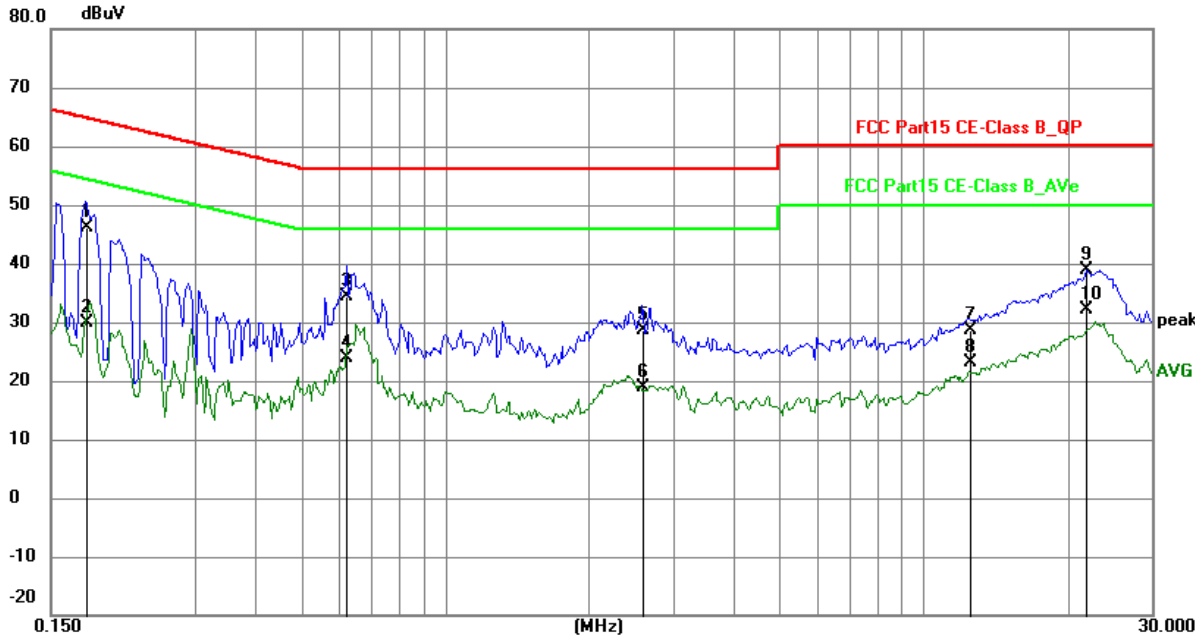

No.	Frequency (MHz)	Reading (dBuV)	Factor (dB)	Level (dBuV)	Limit (dBuV)	Margin (dB)	Detector	P/F
1	0.1773	36.47	9.77	46.24	64.61	-18.37	QP	P
2	0.1773	20.06	9.77	29.83	54.61	-24.78	AVG	P
3	0.6219	24.57	9.78	34.35	56.00	-21.65	QP	P
4	0.6219	14.13	9.78	23.91	46.00	-22.09	AVG	P
5	2.5875	18.74	9.83	28.57	56.00	-27.43	QP	P
6	2.5875	9.17	9.83	19.00	46.00	-27.00	AVG	P
7	12.4575	18.30	10.27	28.57	60.00	-31.43	QP	P
8	12.4575	12.94	10.27	23.21	50.00	-26.79	AVG	P
9	21.9423	27.97	10.80	38.77	60.00	-21.23	QP	P
10	21.9423	21.37	10.80	32.17	50.00	-17.83	AVG	P

The report refers only to the sample tested and does not apply to the bulk.  
 This report is issued in confidence to the client and it will be strictly treated as such by the SHENZHEN TIMEWAY TESTING LABORATORIES. It may not be reproduced rather in its entirety or in part and it may not be used for advertising. The client to whom the report is issued may, however, show or send it, or a certified copy thereof prepared by the SHENZHEN TIMEWAY TESTING LABORATORIES, to his customer. Supplier or others persons directly concerned. SHENZHEN TIMEWAY TESTING LABORATORIES, will not, without the consent of the client enter into any discussion of correspondence with any third party concerning the contents of the report.  
 In the event of the improper use of the report. The SHENZHEN TIMEWAY TESTING LABORATORIES, reserves the rights to withdraw it and to adopt any other remedies which may be appropriate.



## 6 Radiated Emission Test

### 6.1 Test Method and test Procedure:

- (1) The EUT was tested according to ANSI C63.10-2013. The radiated test was performed at Timeway EMC Laboratory. This site is on file with the FCC laboratory division, Registration No. 744189
- (2) The EUT, peripherals were put on the turntable which table size is 1m x 1.5 m, table high 0.8 m. All set up is according to ANSI C63.10-2013.
- (3) The frequency spectrum from 30 MHz to 25GHz was investigated. All readings from 30 MHz to 1 GHz are quasi-peak values with a resolution bandwidth of 120 kHz. For measurement above 1GHz, peak values with RBW=VBW=1MHz and PK detector. AV value with RBW=1MHz, VBW=10Hz and PK detector. Measurements were made at 3 meters.
- (4) The antenna high is varied from 1 m to 4 m high to find the maximum emission for each frequency.
- (5) Maximizing procedure was performed on the six (6) highest emissions to ensure EUT compliance is with all installation combinations. All data was recorded in the peak detection mode. Quasi-peak readings was performed only when an emission was found to be marginal (within -4 dB of specification limit), and are distinguished with a "QP" in the data table.
- (6) The antenna polarization: Vertical polarization and Horizontal polarization.

### Block diagram of Test setup

For radiated emissions from 9kHz to 30MHz

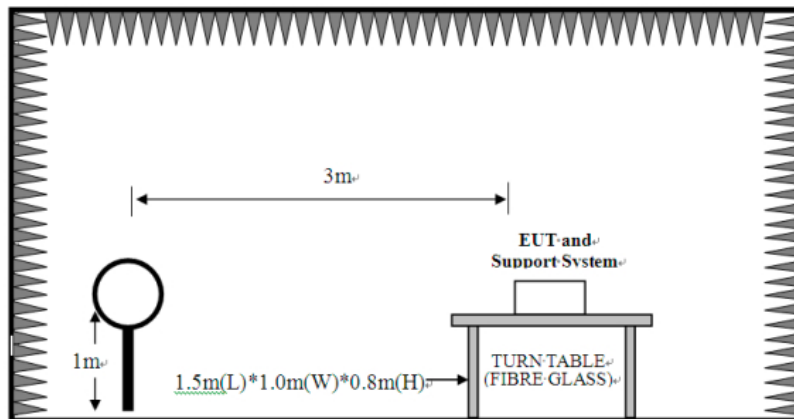

The report refers only to the sample tested and does not apply to the bulk.

This report is issued in confidence to the client and it will be strictly treated as such by the SHENZHEN TIMEWAY TESTING LABORATORIES. It may not be reproduced rather in its entirety or in part and it may not be used for advertising. The client to whom the report is issued may, however, show or send it, or a certified copy thereof prepared by the SHENZHEN TIMEWAY TESTING LABORATORIES, to his customer. Supplier or others persons directly concerned. SHENZHEN TIMEWAY TESTING LABORATORIES, will not, without the consent of the client enter into any discussion of correspondence with any third party concerning the contents of the report.

In the event of the improper use of the report. The SHENZHEN TIMEWAY TESTING LABORATORIES, reserves the rights to withdraw it and to adopt any other remedies which may be appropriate.



For radiated emissions from 30MHz to1GHz

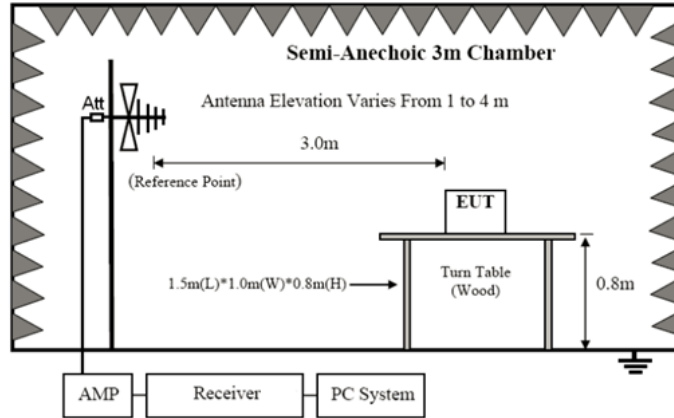

For radiated emissions above 1GHz

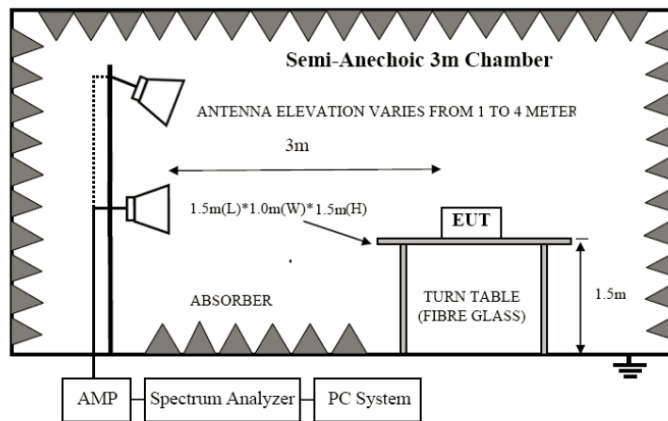

## 6.2 Configuration of the EUT

Same as section 5.3 of this report

## 6.3 EUT Operating Condition

Same as section 5.4 of this report.

## 6.4 Radiated Emission Limit

All emission from a digital device, including any network of conductors and apparatus connected thereto, shall not exceed the level of field strength specified below:

The report refers only to the sample tested and does not apply to the bulk.

This report is issued in confidence to the client and it will be strictly treated as such by the SHENZHEN TIMEWAY TESTING LABORATORIES. It may not be reproduced rather in its entirety or in part and it may not be used for advertising. The client to whom the report is issued may, however, show or send it, or a certified copy thereof, to the SHENZHEN TIMEWAY TESTING LABORATORIES, to his customer, Supplier or others persons directly concerned. SHENZHEN TIMEWAY TESTING LABORATORIES, will not, without the consent of the client enter into any discussion of correspondence with any third party concerning the contents of the report.

In the event of the improper use of the report, The SHENZHEN TIMEWAY TESTING LABORATORIES, reserves the rights to withdraw it and to adopt any other remedies which may be appropriate.



**Frequencies in restricted band are complied to limit on Paragraph 15.209**

Frequency Range (MHz)	Distance (m)	Field strength (dB $\mu$ V/m)
30-88	3	40.0
88-216	3	43.5
216-960	3	46.0
Above 960	3	54.0

- Note:
1. RF Voltage (dBuV) = 20 log RF Voltage (uV)
  2. In the Above Table, the higher limit applies at the band edges.
  3. Distance refers to the distance in meters between the measuring instrument antenna and the EUT
  4. GFSK modulation was the worst case

The report refers only to the sample tested and does not apply to the bulk.  
This report is issued in confidence to the client and it will be strictly treated as such by the SHENZHEN TIMEWAY TESTING LABORATORIES. It may not be reproduced rather in its entirety or in part and it may not be used for advertising. The client to whom the report is issued may, however, show or send it . or a certified copy there of prepared by the SHENZHEN TIMEWAY TESTING LABORATORIES. to his customer. Supplier or others persons directly concerned. SHENZHEN TIMEWAY TESTING LABORATORIES. will not, without the consent of the client enter into any discussion of correspondence with any third party concerning the contents of the report.  
In the event of the improper use of the report. The SHENZHEN TIMEWAY TESTING LABORATORIES. reserves the rights to withdraw it and to adopt any other remedies which may be appropriate.



**Test result**

**General Radiated Emission Data and Harmonics Radiated Emission Data**

**Radiated Emission In Horizontal/Vertical (30MHz----1000MHz)**

EUT set Condition: Keep Bluetooth Transmitting

**Results: Pass**

The report refers only to the sample tested and does not apply to the bulk.

This report is issued in confidence to the client and it will be strictly treated as such by the SHENZHEN TIMEWAY TESTING LABORATORIES. It may not be reproduced rather in its entirety or in part and it may not be used for advertising. The client to whom the report is issued may, however, show or send it or a certified copy thereof prepared by the SHENZHEN TIMEWAY TESTING LABORATORIES to his customer. Supplier or others persons directly concerned. SHENZHEN TIMEWAY TESTING LABORATORIES will not, without the consent of the client enter into any discussion of correspondence with any third party concerning the contents of the report.

In the event of the improper use of the report. The SHENZHEN TIMEWAY TESTING LABORATORIES reserves the rights to withdraw it and to adopt any other remedies which may be appropriate.



Test Figure:

H

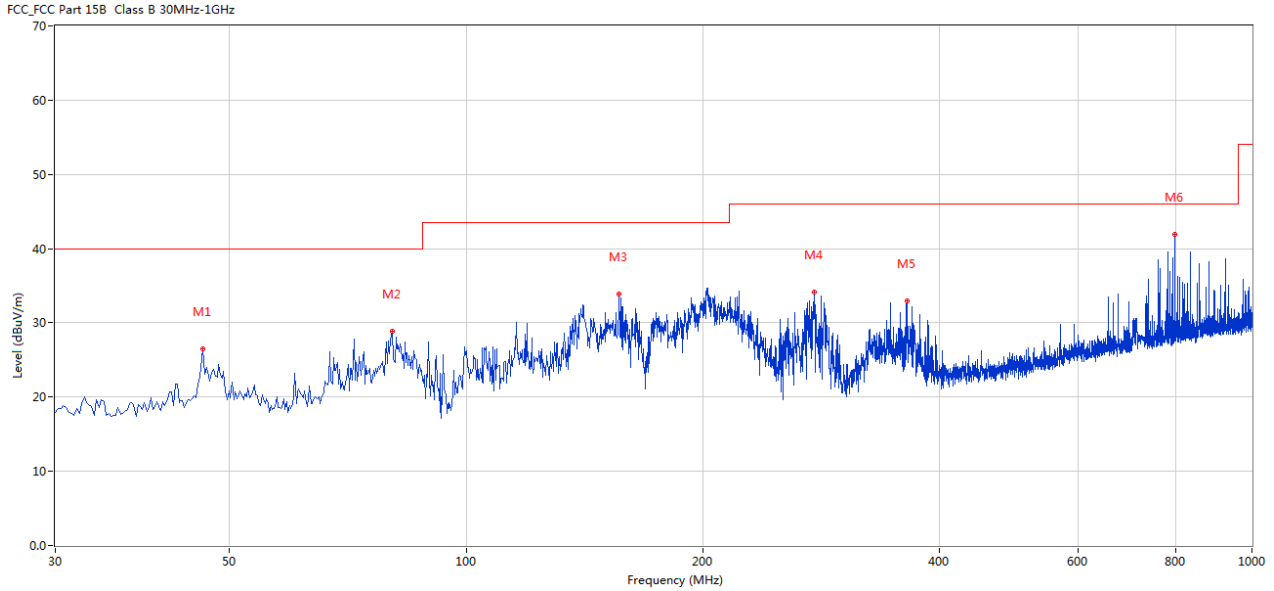

No.	Frequency (MHz)	Results (dBuV/m)	Factor (dB)	Limit (dBuV/m)	Margin (dB)	Detector	Table (Degree)	Height (cm)	Antenna	Verdict
1	46.243	26.46	-11.41	40.0	13.54	Peak	308.00	100	Horizontal	Pass
2	80.427	28.83	-17.37	40.0	11.17	Peak	339.00	100	Horizontal	Pass
3	156.553	33.90	-16.60	43.5	9.60	Peak	335.00	100	Horizontal	Pass
4	277.531	34.16	-11.54	46.0	11.84	Peak	345.00	100	Horizontal	Pass
5	363.597	32.97	-9.56	46.0	13.03	Peak	344.00	100	Horizontal	Pass
6	796.836	41.96	-3.06	46.0	4.04	Peak	281.00	100	Horizontal	Pass

The report refers only to the sample tested and does not apply to the bulk.

This report is issued in confidence to the client and it will be strictly treated as such by the SHENZHEN TIMEWAY TESTING LABORATORIES. It may not be reproduced rather in its entirety or in part and it may not be used for advertising. The client to whom the report is issued may, however, show or send it or a certified copy thereof prepared by the SHENZHEN TIMEWAY TESTING LABORATORIES to his customer. Supplier or others persons directly concerned. SHENZHEN TIMEWAY TESTING LABORATORIES will not, without the consent of the client enter into any discussion of correspondence with any third party concerning the contents of the report.

In the event of the improper use of the report. The SHENZHEN TIMEWAY TESTING LABORATORIES reserves the rights to withdraw it and to adopt any other remedies which may be appropriate.





Test Figure:

V

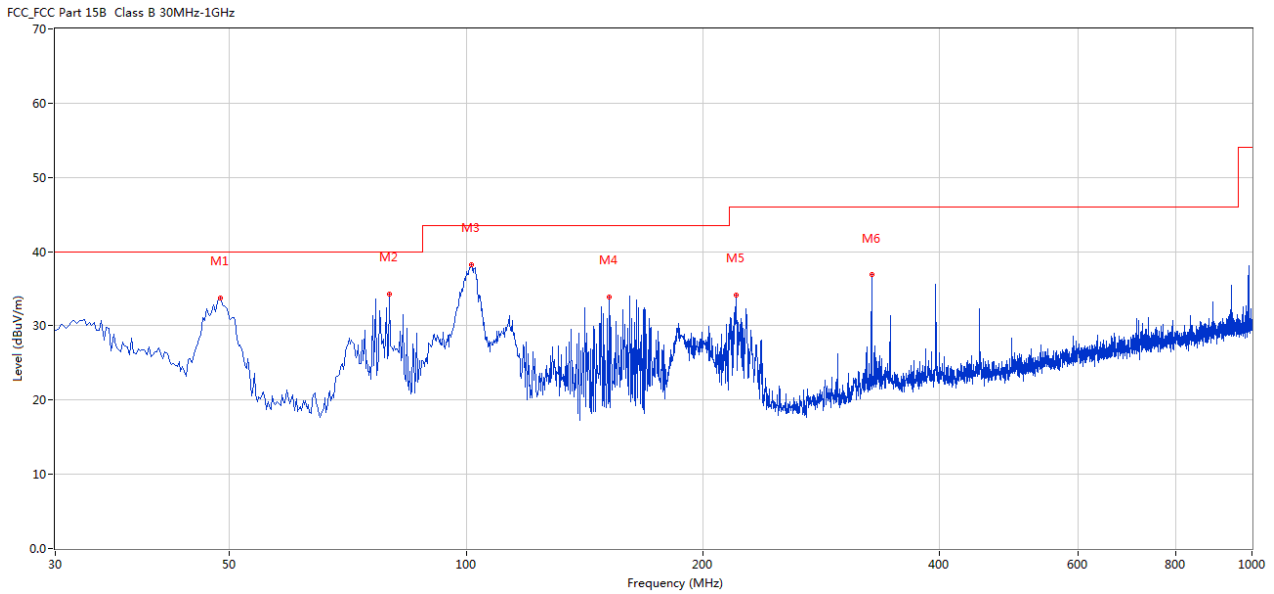

No.	Frequency (MHz)	Results (dBuV/m)	Factor (dB)	Limit (dBuV/m)	Margin (dB)	Detector	Table (Degree)	Height (cm)	Antenna	Verdict
1	48.668	33.77	-11.22	40.0	6.23	Peak	357.00	100	Vertical	Pass
2	79.943	34.23	-17.44	40.0	5.77	Peak	195.00	100	Vertical	Pass
3	101.520	38.20	-13.44	43.5	5.30	Peak	93.00	100	Vertical	Pass
4	151.947	33.91	-16.93	43.5	9.59	Peak	44.00	100	Vertical	Pass
5	220.800	34.21	-13.29	46.0	11.79	Peak	16.00	100	Vertical	Pass
6	327.958	36.85	-10.32	46.0	9.15	Peak	2.00	100	Vertical	Pass

The report refers only to the sample tested and does not apply to the bulk.

This report is issued in confidence to the client and it will be strictly treated as such by the SHENZHEN TIMEWAY TESTING LABORATORIES. It may not be reproduced rather in its entirety or in part and it may not be used for advertising. The client to whom the report is issued may, however, show or send it . or a certified copy there of prepared by the SHENZHEN TIMEWAY TESTING LABORATORIES. to his customer. Supplier or others persons directly concerned. SHENZHEN TIMEWAY TESTING LABORATORIES. will not, without the consent of the client enter into any discussion of correspondence with any third party concerning the contents of the report.

In the event of the improper use of the report. The SHENZHEN TIMEWAY TESTING LABORATORIES. reserves the rights to withdraw it and to adopt any other remedies which may be appropriate.



**Operation Mode: Transmitting under Low Channel (2402MHz)**

Frequency (MHz)	Level@3m (dB $\mu$ V/m)	Antenna Polarity	Limit@3m (dB $\mu$ V/m)
4804	50.3 (PK)	H	74(Peak)/ 54(AV)
4804	45.6 (PK)	V	74(Peak)/ 54(AV)
7206	--	H/V	74(Peak)/ 54(AV)
9608	--	H/V	74(Peak)/ 54(AV)
12010	--	H/V	74(Peak)/ 54(AV)
14412	--	H/V	74(Peak)/ 54(AV)
16814	--	H/V	74(Peak)/ 54(AV)
19216	--	H/V	74(Peak)/ 54(AV)
21618	--	H/V	74(Peak)/ 54(AV)
24020	--	H/V	74(Peak)/ 54(AV)

- Note: 1. Level = Reading + AF + Cable - Preamp + Filter - Dist, Margin = Level - Limit  
2. Remark “---” means that the emissions level is too low to be measured  
3. The PK measurement level less than the AV limit

**Operation Mode: Transmitting g under Middle Channel (2441MHz)**

Frequency (MHz)	Level@3m (dB $\mu$ V/m)	Antenna Polarity	Limit@3m (dB $\mu$ V/m)
4882	49.1 (PK)	H	74(Peak)/ 54(AV)
4882	44.3 (PK)	V	74(Peak)/ 54(AV)
7323	--	H/V	74(Peak)/ 54(AV)
9764	--	H/V	74(Peak)/ 54(AV)
12205	--	H/V	74(Peak)/ 54(AV)
14646	--	H/V	74(Peak)/ 54(AV)
17087	--	H/V	74(Peak)/ 54(AV)
19528	--	H/V	74(Peak)/ 54(AV)
21969	--	H/V	74(Peak)/ 54(AV)
24410	--	H/V	74(Peak)/ 54(AV)

- Note: 1. Level = Reading + AF + Cable - Preamp + Filter - Dist, Margin = Level - Limit  
2. Remark “---” means that the emissions level is too low to be measured  
3. The PK measurement level less than the AV limit

The report refers only to the sample tested and does not apply to the bulk.

This report is issued in confidence to the client and it will be strictly treated as such by the SHENZHEN TIMEWAY TESTING LABORATORIES. It may not be reproduced rather in its entirety or in part and it may not be used for advertising. The client to whom the report is issued may, however, show or send it . or a certified copy there of prepared by the SHENZHEN TIMEWAY TESTING LABORATORIES. to his customer. Supplier or others persons directly concerned. SHENZHEN TIMEWAY TESTING LABORATORIES. will not, without the consent of the client enter into any discussion of correspondence with any third party concerning the contents of the report.

In the event of the improper use of the report. The SHENZHEN TIMEWAY TESTING LABORATORIES. reserves the rights to withdraw it and to adopt any other remedies which may be appropriate.



**Operation Mode: Transmitting under High Channel (2480MHz)**

Frequency (MHz)	Level@3m (dB $\mu$ V/m)	Antenna Polarity	Limit@3m (dB $\mu$ V/m)
4960	49.6 (PK)	H	74(Peak)/ 54(AV)
4960	44.7 (PK)	V	74(Peak)/ 54(AV)
7440	--	H/V	74(Peak)/ 54(AV)
9920	--	H/V	74(Peak)/ 54(AV)
12400	--	H/V	74(Peak)/ 54(AV)
14880	--	H/V	74(Peak)/ 54(AV)
17360	--	H/V	74(Peak)/ 54(AV)
19840	--	H/V	74(Peak)/ 54(AV)
22320	--	H/V	74(Peak)/ 54(AV)
24800	--	H/V	74(Peak)/ 54(AV)

- Note: 1. Level = Reading + AF + Cable - Preamp + Filter - Dist, Margin = Level - Limit  
 2. Remark “---” means that the emissions level is too low to be measured  
 3. The PK measurement level less than the AV limit

The report refers only to the sample tested and does not apply to the bulk.  
 This report is issued in confidence to the client and it will be strictly treated as such by the SHENZHEN TIMEWAY TESTING LABORATORIES. It may not be reproduced rather in its entirety or in part and it may not be used for advertising. The client to whom the report is issued may, however, show or send it . or a certified copy there of prepared by the SHENZHEN TIMEWAY TESTING LABORATORIES. to his customer. Supplier or others persons directly concerned. SHENZHEN TIMEWAY TESTING LABORATORIES. will not, without the consent of the client enter into any discussion of correspondence with any third party concerning the contents of the report.  
 In the event of the improper use of the report. The SHENZHEN TIMEWAY TESTING LABORATORIES. reserves the rights to withdraw it and to adopt any other remedies which may be appropriate.



## 7.0 20dB Bandwidth Measurement

### 7.1 Regulation

Intentional radiators operating under the alternative provisions to the general emission limits, as contained in §§ 15.217 through 15.257 and in Subpart E of this part, must be designed to ensure that the 20 dB bandwidth of the emission, or whatever bandwidth may otherwise be specified in the specific rule section under which the equipment operates, is contained within the frequency band designated in the rule section under which the equipment is operated.

### 7.2 Limits of 20dB Bandwidth Measurement

N/A

### 7.3 Test Procedure.

1. Check the calibration of the measuring instrument (spectrum analyzer) using either an internal calibrator or a known signal from an external generator.
2. Set the spectrum analyzer as follows: Span =2MHz, RBW =30 kHz, VBW=100 kHz, Sweep = auto Detector function = peak, Trace = max hold
3. Measure the highest amplitude appearing on spectral display and record the level to calculate results. 6. Repeat above procedures until all frequencies measured were complete.

### 7.4 Test Result

Condition	Mode	Frequency (MHz)	Antenna	-20 dB Bandwidth (MHz)	Limit -20 dB Bandwidth (MHz)	Verdict
NVNT	1-DH5	2402	Ant1	0.86	--	Pass
		2441		0.859	--	Pass
		2480		0.873	--	Pass
	2-DH5	2402		1.222	--	Pass
		2441		1.232	--	Pass
		2480		1.233	--	Pass
	3-DH5	2402		1.215	--	Pass
		2441		1.205	--	Pass
		2480		1.233	--	Pass

The report refers only to the sample tested and does not apply to the bulk.

This report is issued in confidence to the client and it will be strictly treated as such by the SHENZHEN TIMEWAY TESTING LABORATORIES. It may not be reproduced rather in its entirety or in part and it may not be used for advertising. The client to whom the report is issued may, however, show or send it . or a certified copy there of prepared by the SHENZHEN TIMEWAY TESTING LABORATORIES. to his customer. Supplier or others persons directly concerned. SHENZHEN TIMEWAY TESTING LABORATORIES. will not, without the consent of the client enter into any discussion of correspondence with any third party concerning the contents of the report.

In the event of the improper use of the report. The SHENZHEN TIMEWAY TESTING LABORATORIES. reserves the rights to withdraw it and to adopt any other remedies which may be appropriate.

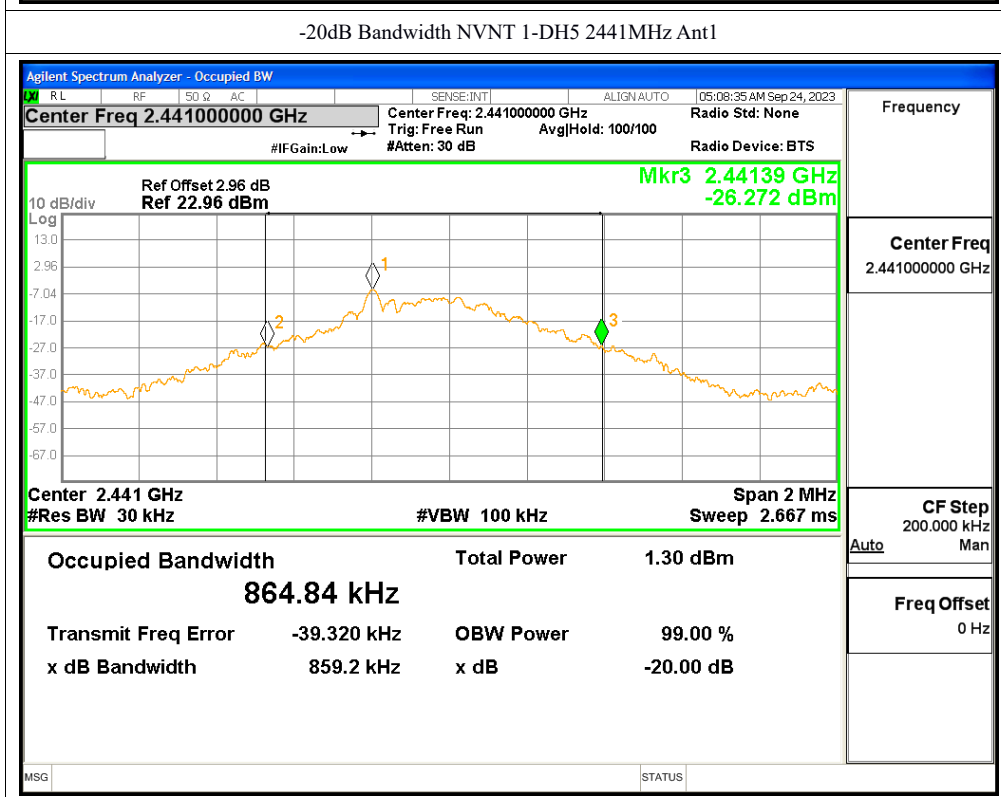
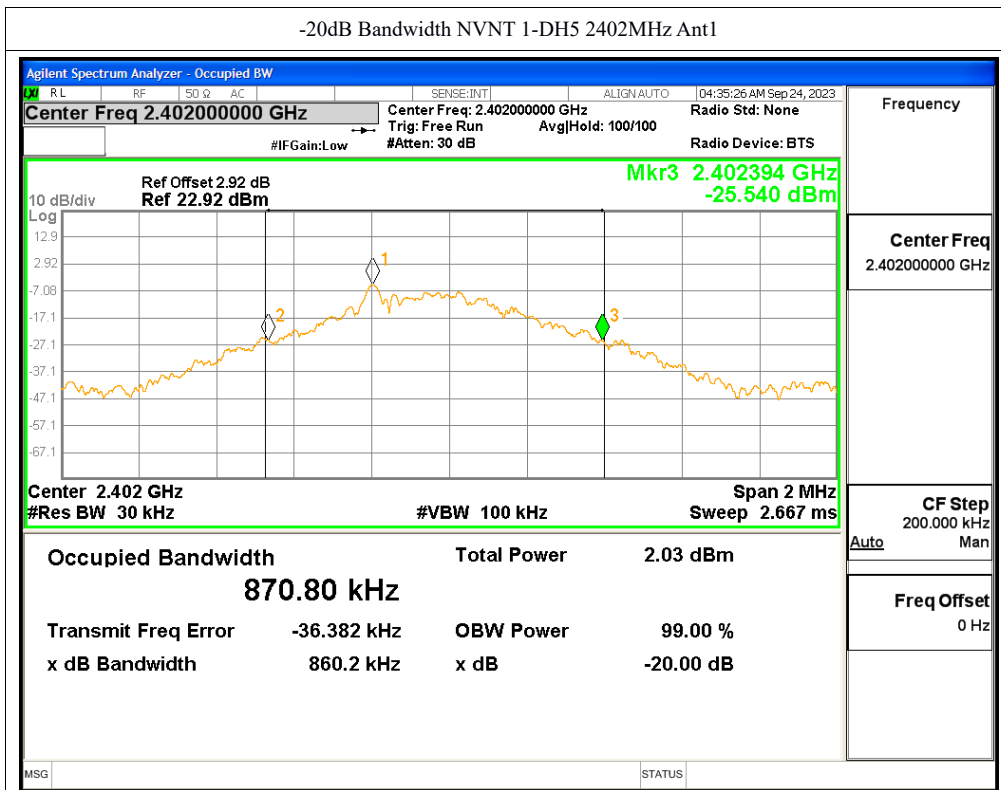

The report refers only to the sample tested and does not apply to the bulk.

This report is issued in confidence to the client and it will be strictly treated as such by the SHENZHEN TIMEWAY TESTING LABORATORIES. It may not be reproduced rather in its entirety or in part and it may not be used for advertising. The client to whom the report is issued may, however, show or send it, or a certified copy thereof prepared by the SHENZHEN TIMEWAY TESTING LABORATORIES, to his customer, Supplier or others persons directly concerned. SHENZHEN TIMEWAY TESTING LABORATORIES, will not, without the consent of the client enter into any discussion of correspondence with any third party concerning the contents of the report.

In the event of the improper use of the report, The SHENZHEN TIMEWAY TESTING LABORATORIES, reserves the rights to withdraw it and to adopt any other remedies which may be appropriate.

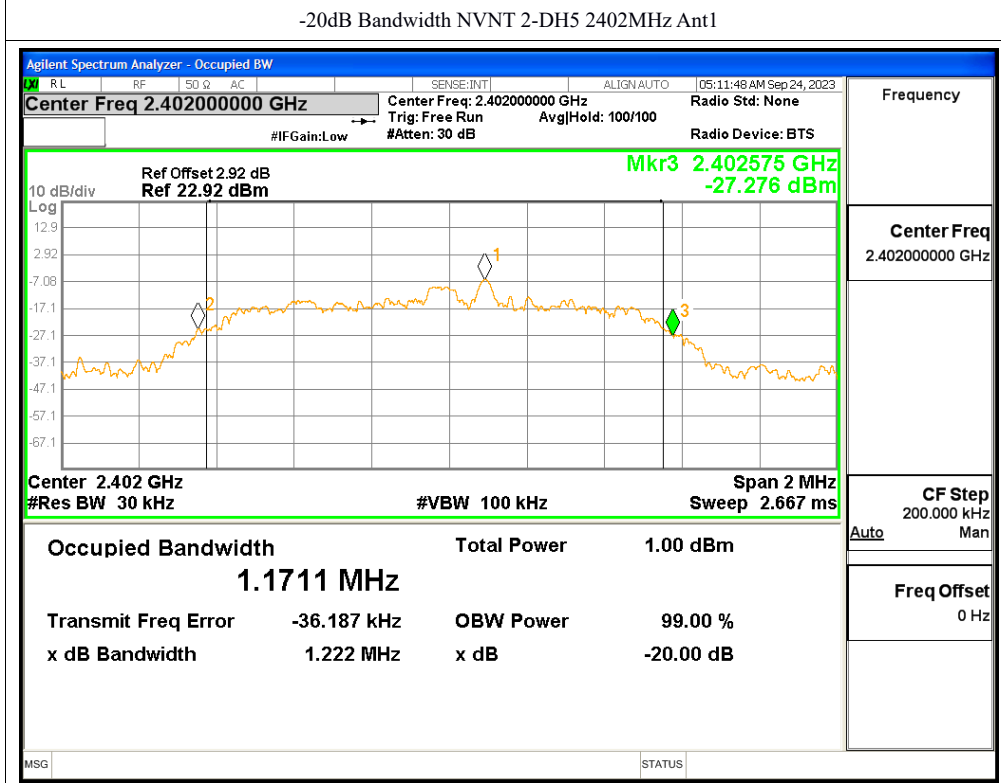
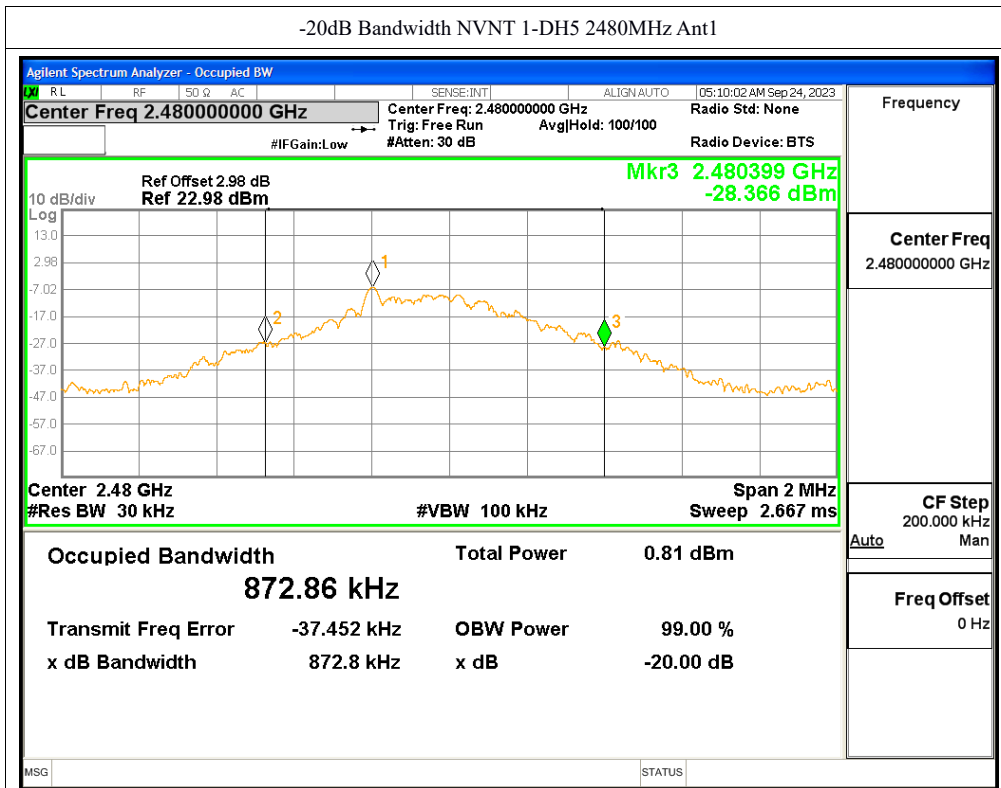

The report refers only to the sample tested and does not apply to the bulk. This report is issued in confidence to the client and it will be strictly treated as such by the SHENZHEN TIMEWAY TESTING LABORATORIES. It may not be reproduced in its entirety or in part and it may not be used for advertising. The client to whom the report is issued may, however, show or send it, or a certified copy thereof, prepared by the SHENZHEN TIMEWAY TESTING LABORATORIES, to his customer, Supplier or others persons directly concerned. SHENZHEN TIMEWAY TESTING LABORATORIES, will not, without the consent of the client enter into any discussion of correspondence with any third party concerning the contents of the report. In the event of the improper use of the report, the SHENZHEN TIMEWAY TESTING LABORATORIES, reserves the rights to withdraw it and to adopt any other remedies which may be appropriate.

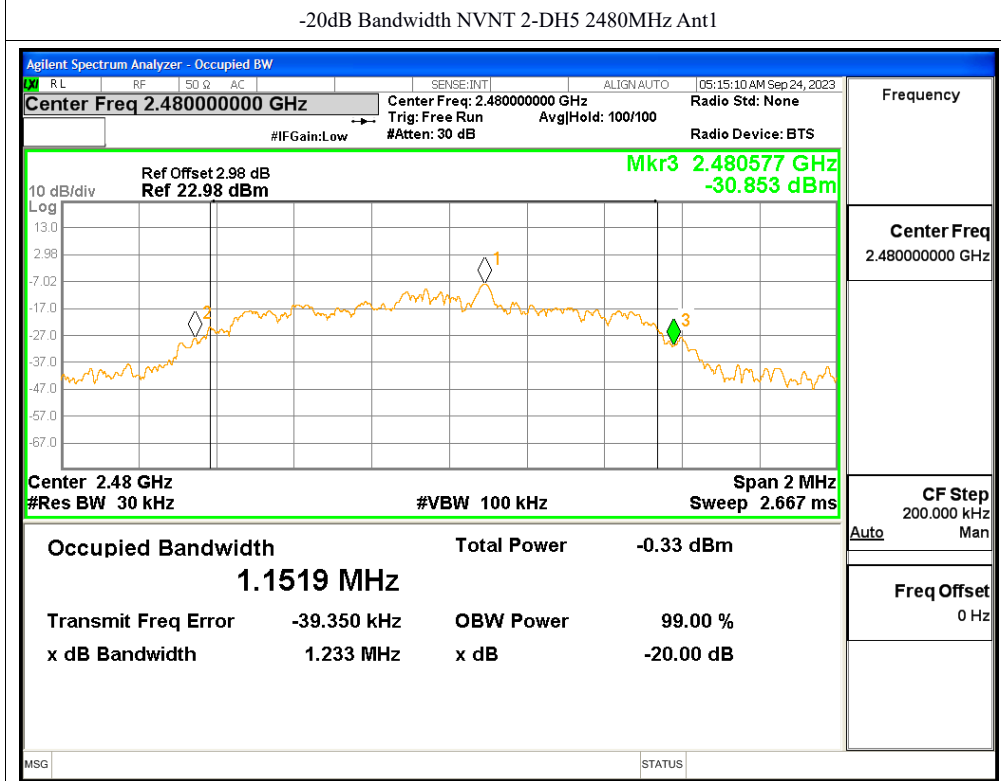
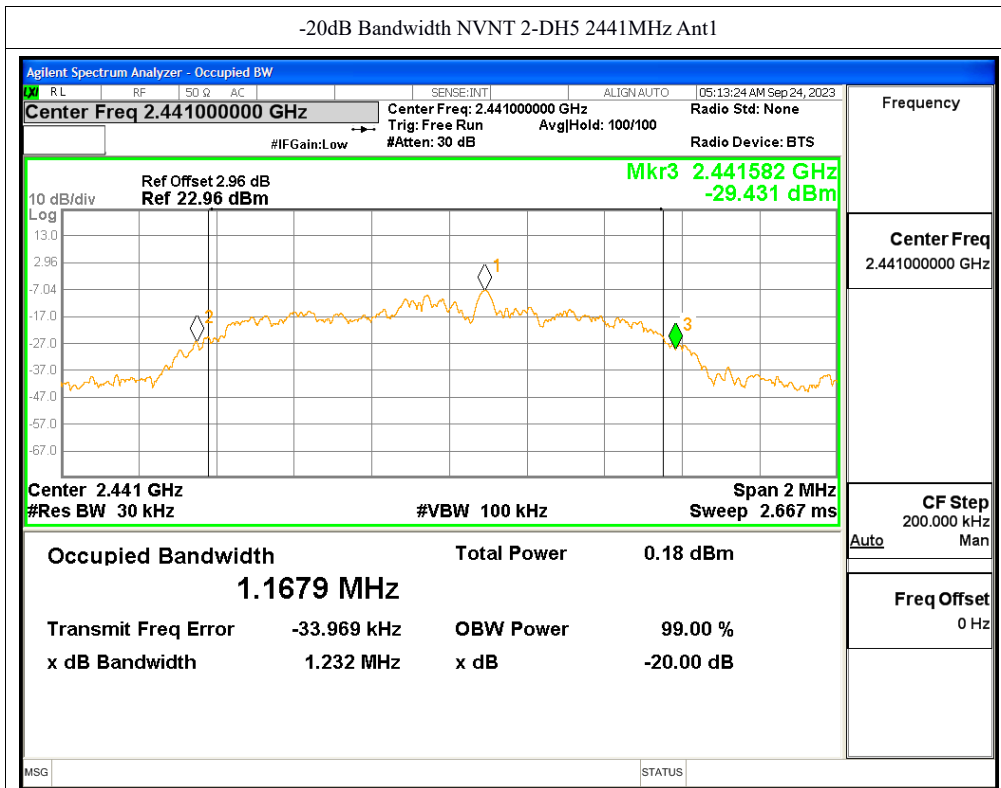

The report refers only to the sample tested and does not apply to the bulk.

This report is issued in confidence to the client and it will be strictly treated as such by the SHENZHEN TIMEWAY TESTING LABORATORIES. It may not be reproduced in its entirety or in part and it may not be used for advertising. The client to whom the report is issued may, however, show or send it, or a certified copy thereof, to his customer. Supplier or others persons directly concerned. SHENZHEN TIMEWAY TESTING LABORATORIES. will not, without the consent of the client enter into any discussion of correspondence with any third party concerning the contents of the report.

In the event of the improper use of the report. The SHENZHEN TIMEWAY TESTING LABORATORIES. reserves the rights to withdraw it and to adopt any other remedies which may be appropriate.

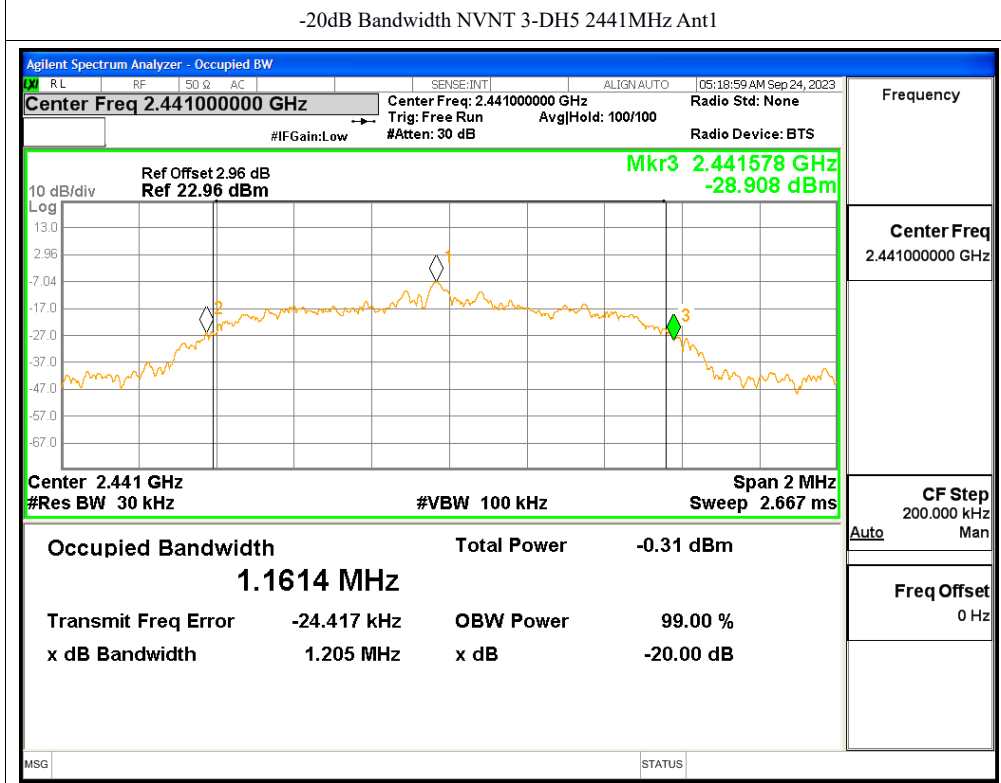
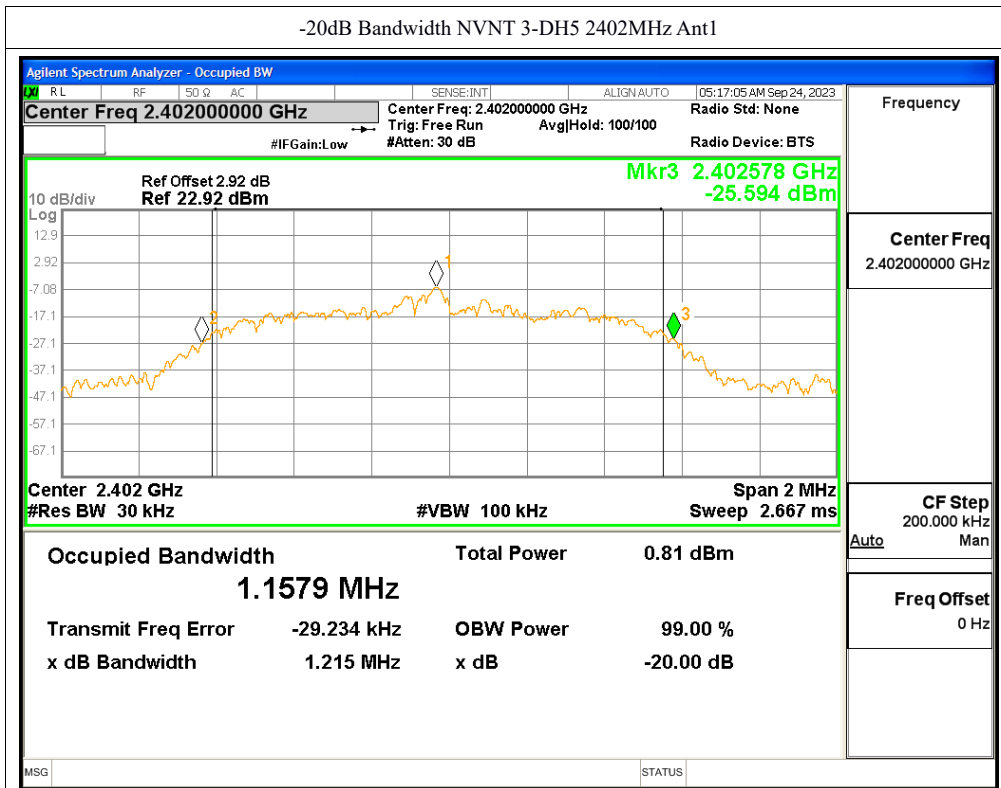

The report refers only to the sample tested and does not apply to the bulk.

This report is issued in confidence to the client and it will be strictly treated as such by the SHENZHEN TIMEWAY TESTING LABORATORIES. It may not be reproduced in its entirety or in part and it may not be used for advertising. The client to whom the report is issued may, however, show or send it, or a certified copy thereof prepared by the SHENZHEN TIMEWAY TESTING LABORATORIES, to his customer. Supplier or others persons directly concerned. SHENZHEN TIMEWAY TESTING LABORATORIES, will not, without the consent of the client enter into any discussion of correspondence with any third party concerning the contents of the report. In the event of the improper use of the report. The SHENZHEN TIMEWAY TESTING LABORATORIES, reserves the rights to withdraw it and to adopt any other remedies which may be appropriate.



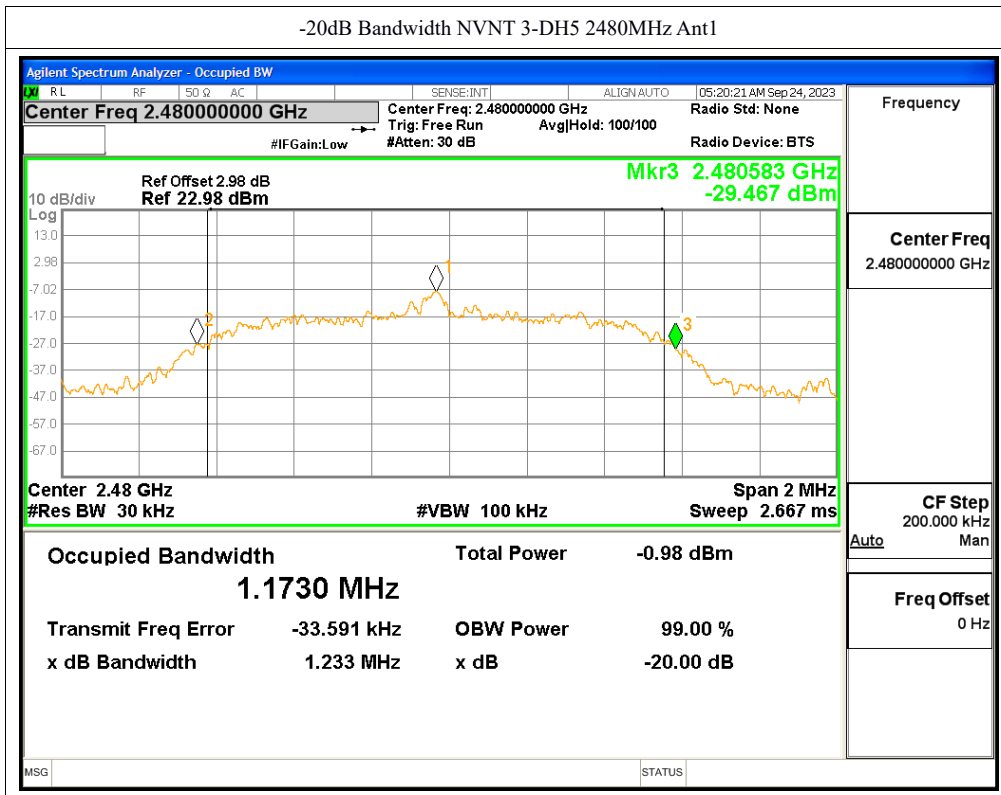

The report refers only to the sample tested and does not apply to the bulk.

This report is issued in confidence to the client and it will be strictly treated as such by the SHENZHEN TIMEWAY TESTING LABORATORIES. It may not be reproduced rather in its entirety or in part and it may not be used for advertising. The client to whom the report is issued may, however, show or send it or a certified copy thereof prepared by the SHENZHEN TIMEWAY TESTING LABORATORIES to his customer. Supplier or others persons directly concerned. SHENZHEN TIMEWAY TESTING LABORATORIES will not, without the consent of the client enter into any discussion of correspondence with any third party concerning the contents of the report.

In the event of the improper use of the report. The SHENZHEN TIMEWAY TESTING LABORATORIES reserves the rights to withdraw it and to adopt any other remedies which may be appropriate.



## **8. Maximum Output Power**

### **8.1 Regulation**

According to §15.247(b)(1), for frequency hopping systems operating in the 2400-2483.5 MHz band employing at least 75 non-overlapping hopping channels, and all frequency hopping systems in the 5725-5850 MHz band: 1 watt. For all other frequency hopping systems in the 2400-2483.5MHz band:0.125 watts. According to §15.247(b)(4), the conducted output power limit specified in paragraph (b) of this section is based on the use of antennas with directional gains that do not exceed 6 dBi. Except as shown in paragraph (c) of this section, if transmitting antennas of directional gain greater than 6 dBi are used, the conducted output power from the intentional radiator shall be reduced below the stated values in paragraphs (b)(1), (b)(2), and (b)(3) of this section, as appropriate, by the amount in dB that the directional gain of the antenna exceeds 6 dBi.

### **8.2 Limits of Maximum Output Power**

The Maximum Output Power Measurement is 30dBm or 21dBm.

### **8.3 Test Procedure**

1. Check the calibration of the measuring instrument (spectrum analyzer) using either an internal calibrator or a known signal from an external generator.
2. Set the spectrum analyzer as follows: Span = approximately 5 times the 20 dB bandwidth, centered on a hopping channel; VBW =6MHz, RBW=2MHz; Sweep = Auto; Detector function = PK; Trace = max hold
3. Measure the highest amplitude appearing on spectral display and record the level to calculate results.
4. Repeat above procedures until all frequencies measured were complete.

The report refers only to the sample tested and does not apply to the bulk.

This report is issued in confidence to the client and it will be strictly treated as such by the SHENZHEN TIMEWAY TESTING LABORATORIES. It may not be reproduced rather in its entirety or in part and it may not be used for advertising. The client to whom the report is issued may, however, show or send it . or a certified copy there of prepared by the SHENZHEN TIMEWAY TESTING LABORATORIES. to his customer. Supplier or others persons directly concerned. SHENZHEN TIMEWAY TESTING LABORATORIES. will not, without the consent of the client enter into any discussion of correspondence with any third party concerning the contents of the report.

In the event of the improper use of the report. The SHENZHEN TIMEWAY TESTING LABORATORIES. reserves the rights to withdraw it and to adopt any other remedies which may be appropriate.



**8.4 Test Results**

Condition	Mode	Frequency (MHz)	Antenna	Conducted Power (dBm)	Duty Factor (dB)	Total Power (dBm)	Limit (dBm)	Verdict
NVNT	1-DH5	2402	Ant1	-4.23	0	-4.23	30	Pass
		2441		-5.21	0	-5.21	30	Pass
		2480		-5.74	0	-5.74	30	Pass
	2-DH5	2402		-3.76	0	-3.76	21	Pass
		2441		-4.85	0	-4.85	21	Pass
		2480		-5.38	0	-5.38	21	Pass
	3-DH5	2402		-3.4	0	-3.4	21	Pass
		2441		-4.36	0	-4.36	21	Pass
		2480		-4.97	0	-4.97	21	Pass

Note: 1. the result basic equation calculation as follow:

$$\text{Max. Power Output} = \text{Power Reading} + \text{Cable loss} + \text{Attenuator}$$

2. The worse case was recorded
3. The **Peak** power was measured

The report refers only to the sample tested and does not apply to the bulk.

This report is issued in confidence to the client and it will be strictly treated as such by the SHENZHEN TIMEWAY TESTING LABORATORIES. It may not be reproduced rather in its entirety or in part and it may not be used for adverting. The client to whom the report is issued may, however, show or send it . or a certified copy there of prepared by the SHENZHEN TIMEWAY TESTING LABORATORIES. to his customer. Supplier or others persons directly concerned. SHENZHEN TIMEWAY TESTING LABORATORIES. will not, without the consent of the client enter into any discussion of correspondence with any third party concerning the contents of the report.

In the event of the improper use of the report. The SHENZHEN TIMEWAY TESTING LABORATORIES. reserves the rights to withdraw it and to adopt any other remedies which may be appropriate.

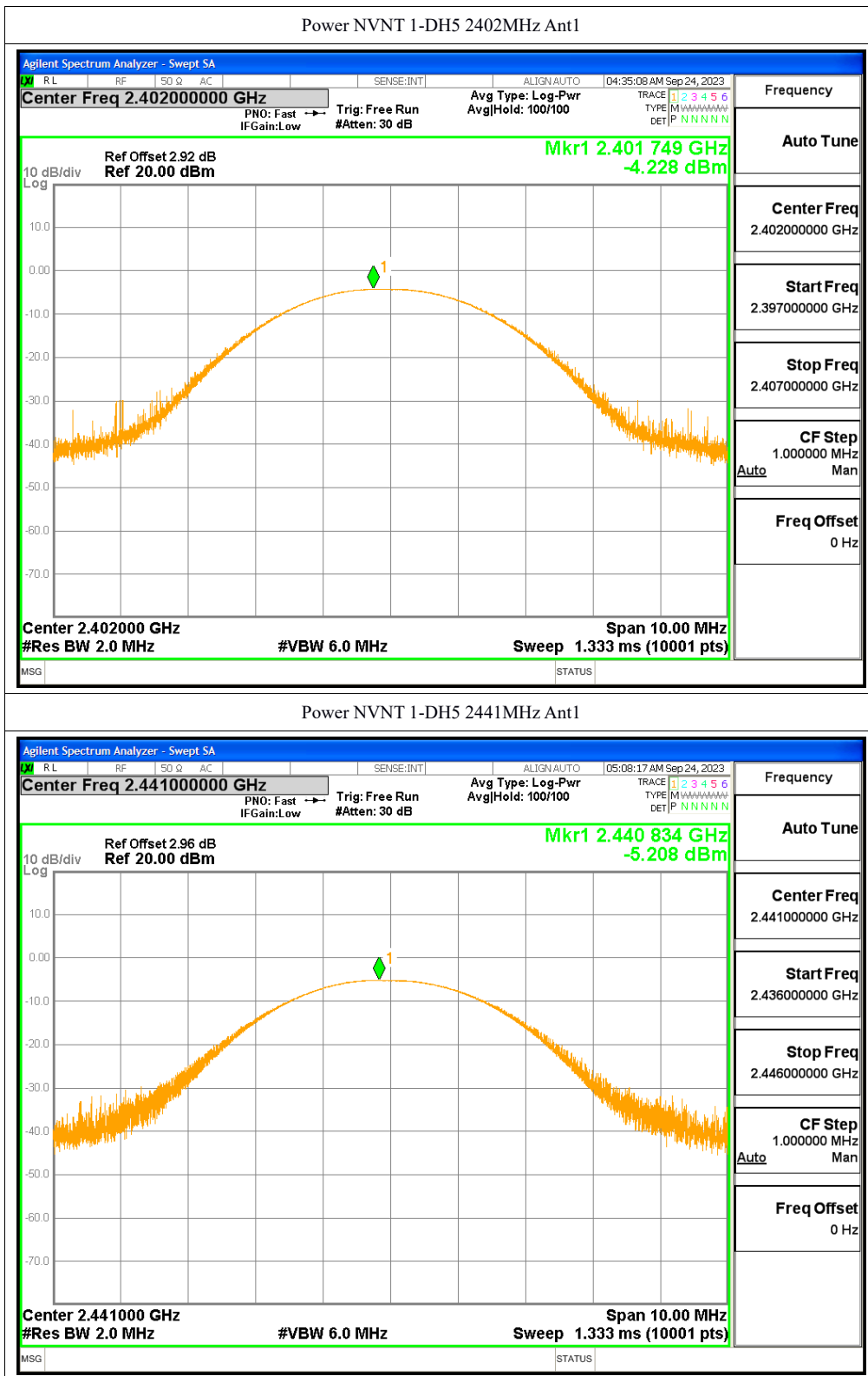

The report refers only to the sample tested and does not apply to the bulk.  
 This report is issued in confidence to the client and it will be strictly treated as such by the SHENZHEN TIMEWAY TESTING LABORATORIES. It may not be reproduced rather in its entirety or in part and it may not be used for advertising. The client to whom the report is issued may, however, show or send it, or a certified copy thereof prepared by the SHENZHEN TIMEWAY TESTING LABORATORIES, to his customer. Supplier or others persons directly concerned. SHENZHEN TIMEWAY TESTING LABORATORIES, will not, without the consent of the client enter into any discussion of correspondence with any third party concerning the contents of the report.  
 In the event of the improper use of the report. The SHENZHEN TIMEWAY TESTING LABORATORIES, reserves the rights to withdraw it and to adopt any other remedies which may be appropriate.

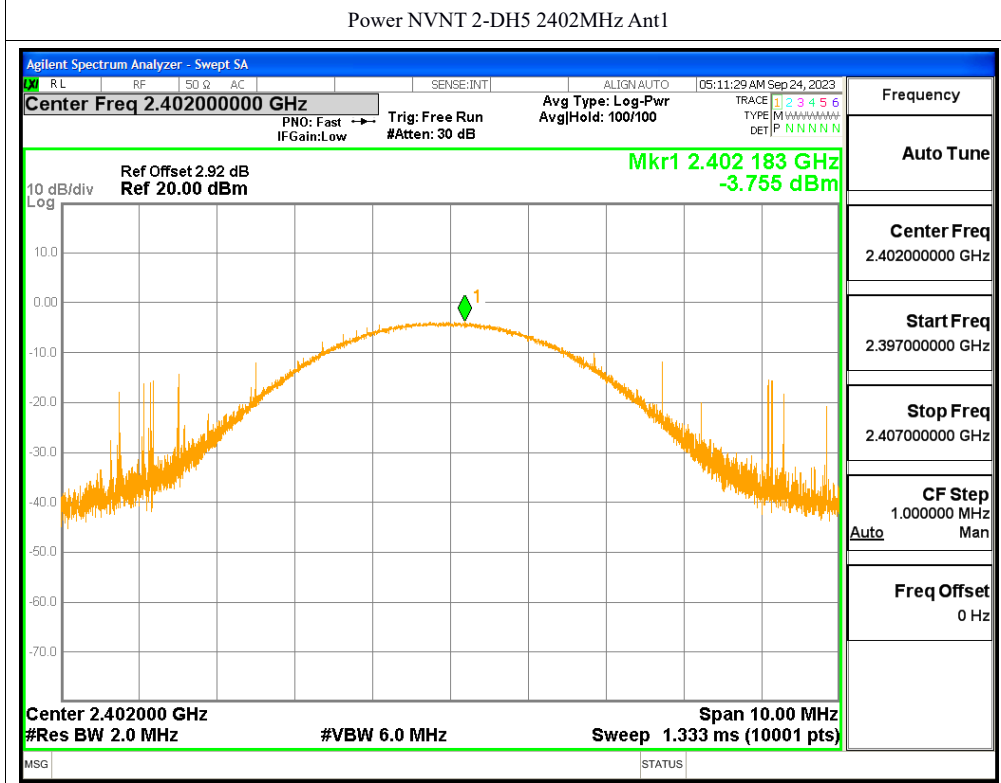
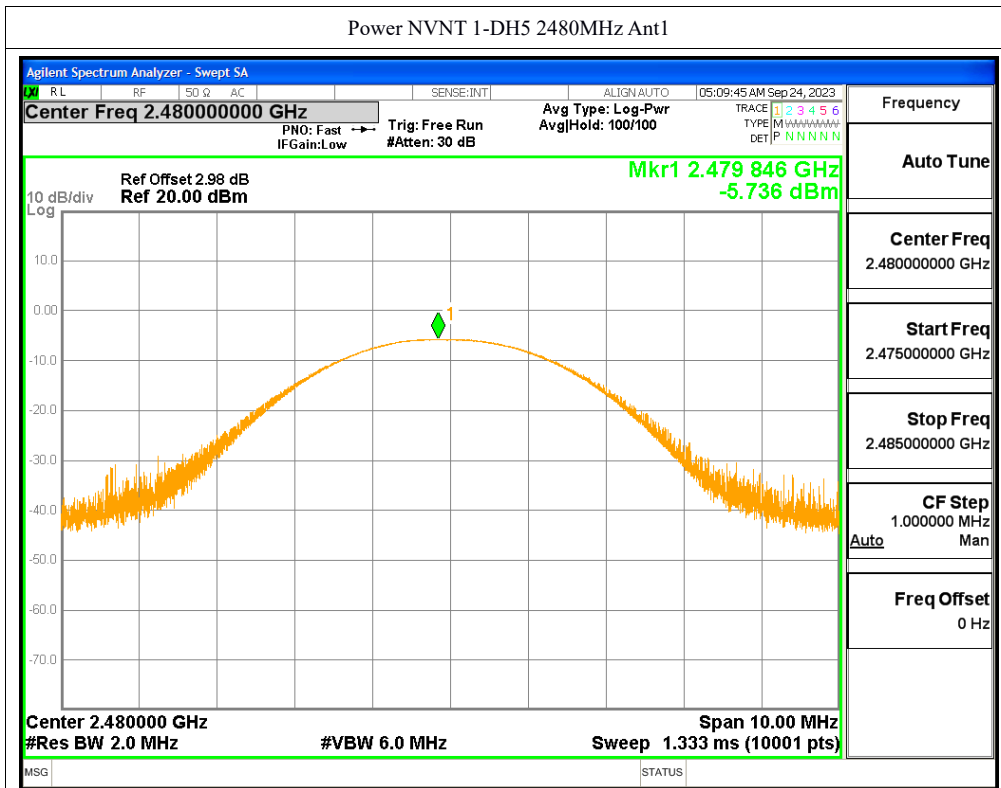

The report refers only to the sample tested and does not apply to the bulk. This report is issued in confidence to the client and it will be strictly treated as such by the SHENZHEN TIMEWAY TESTING LABORATORIES. It may not be reproduced rather in its entirety or in part and it may not be used for advertising. The client to whom the report is issued may, however, show or send it, or a certified copy thereof, prepared by the SHENZHEN TIMEWAY TESTING LABORATORIES, to his customer. Supplier or others persons directly concerned. SHENZHEN TIMEWAY TESTING LABORATORIES, will not, without the consent of the client enter into any discussion of correspondence with any third party concerning the contents of the report. In the event of the improper use of the report. The SHENZHEN TIMEWAY TESTING LABORATORIES, reserves the rights to withdraw it and to adopt any other remedies which may be appropriate.

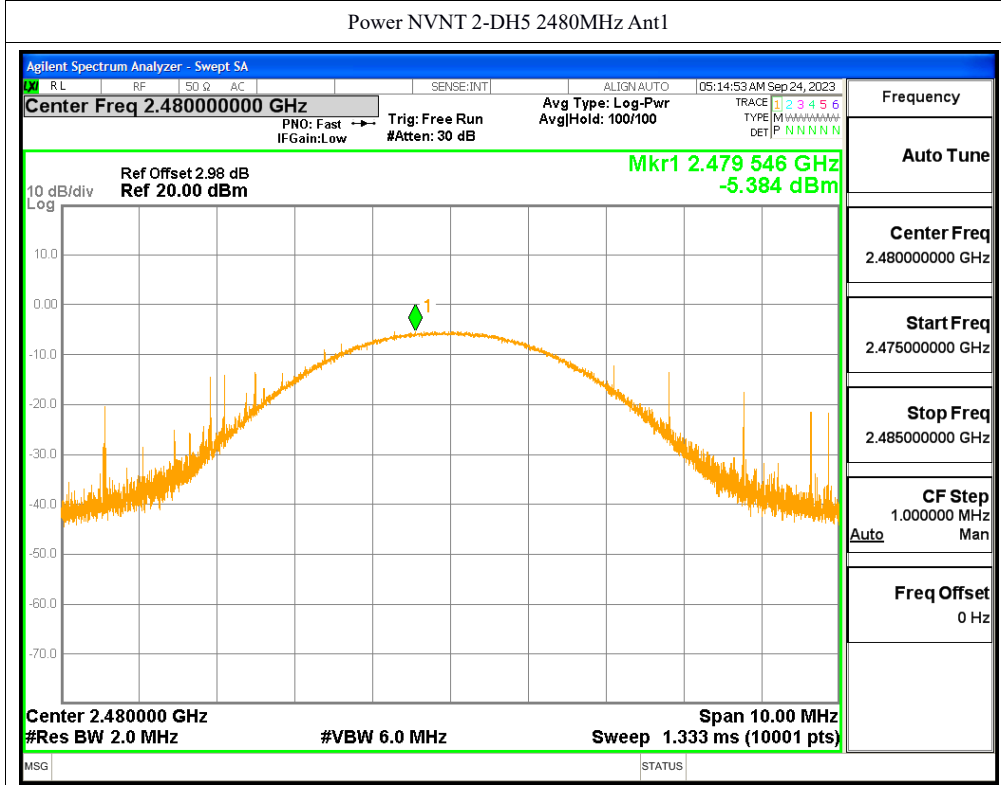
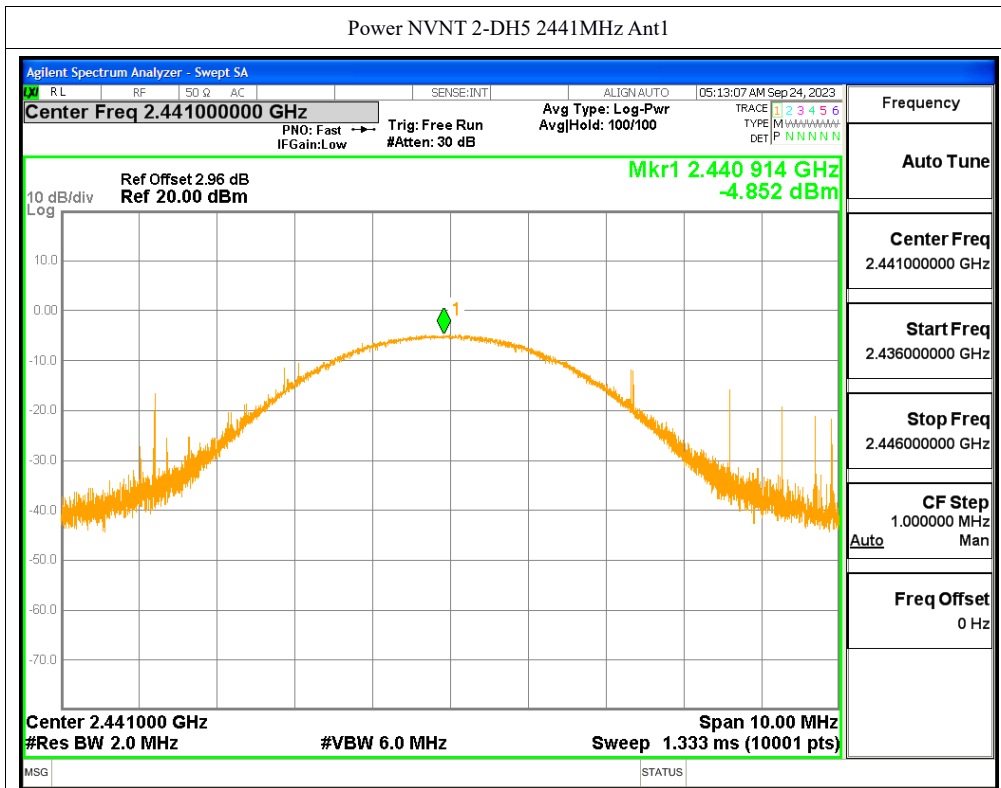

The report refers only to the sample tested and does not apply to the bulk.  
 This report is issued in confidence to the client and it will be strictly treated as such by the SHENZHEN TIMEWAY TESTING LABORATORIES. It may not be reproduced rather in its entirety or in part and it may not be used for advertising. The client to whom the report is issued may, however, show or send it, or a certified copy thereof, to his customer. Supplier or others persons directly concerned. SHENZHEN TIMEWAY TESTING LABORATORIES. will not, without the consent of the client enter into any discussion of correspondence with any third party concerning the contents of the report.  
 In the event of the improper use of the report. The SHENZHEN TIMEWAY TESTING LABORATORIES. reserves the rights to withdraw it and to adopt any other remedies which may be appropriate.

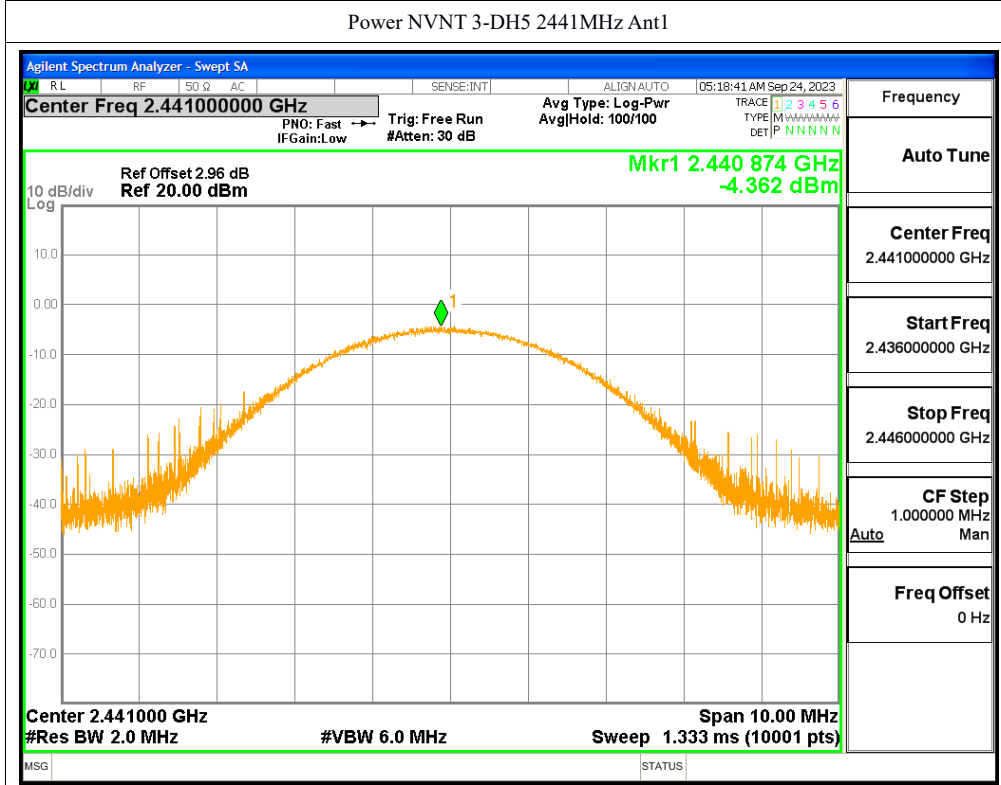
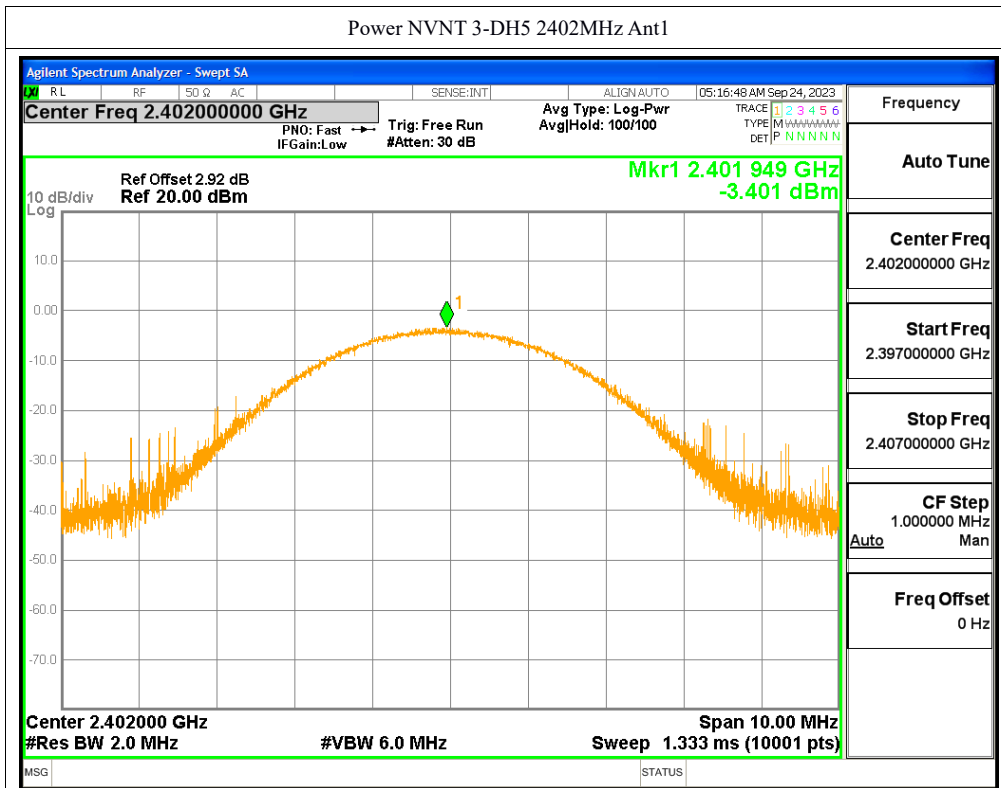

The report refers only to the sample tested and does not apply to the bulk. This report is issued in confidence to the client and it will be strictly treated as such by the SHENZHEN TIMEWAY TESTING LABORATORIES. It may not be reproduced rather in its entirety or in part and it may not be used for advertising. The client to whom the report is issued may, however, show or send it, or a certified copy thereof prepared by the SHENZHEN TIMEWAY TESTING LABORATORIES, to his customer. Supplier or others persons directly concerned. SHENZHEN TIMEWAY TESTING LABORATORIES, will not, without the consent of the client enter into any discussion of correspondence with any third party concerning the contents of the report. In the event of the improper use of the report. The SHENZHEN TIMEWAY TESTING LABORATORIES, reserves the rights to withdraw it and to adopt any other remedies which may be appropriate.

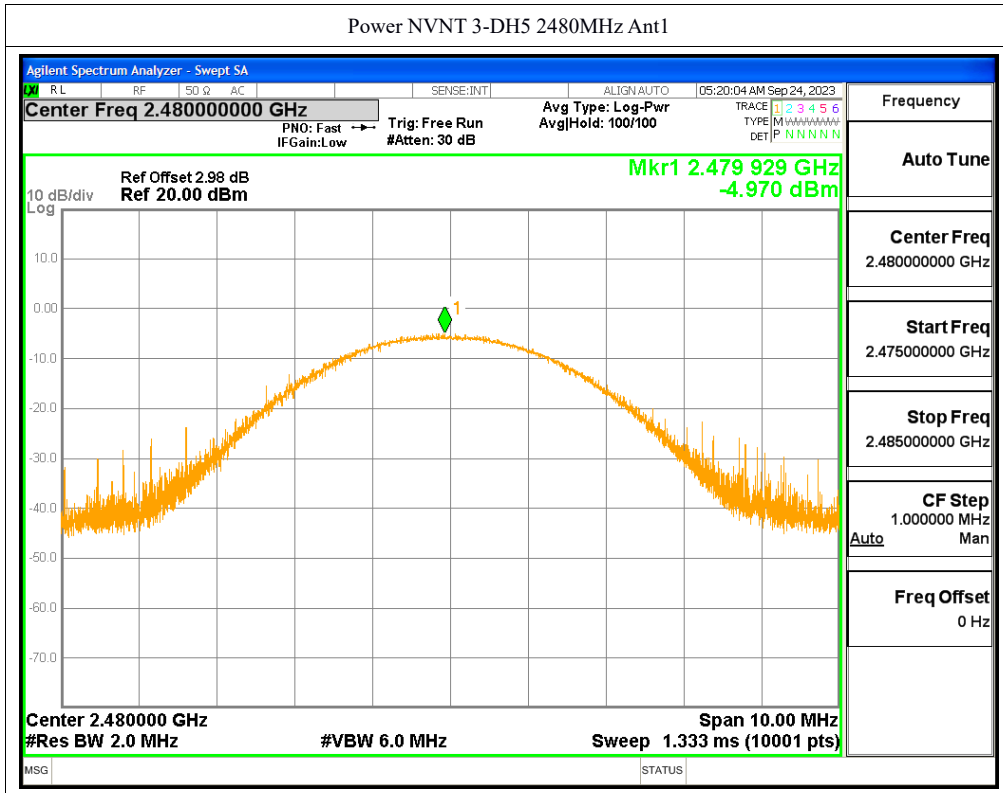

The report refers only to the sample tested and does not apply to the bulk.

This report is issued in confidence to the client and it will be strictly treated as such by the SHENZHEN TIMEWAY TESTING LABORATORIES. It may not be reproduced rather in its entirety or in part and it may not be used for advertising. The client to whom the report is issued may, however, show or send it, or a certified copy thereof prepared by the SHENZHEN TIMEWAY TESTING LABORATORIES, to his customer. Supplier or others persons directly concerned. SHENZHEN TIMEWAY TESTING LABORATORIES, will not, without the consent of the client enter into any discussion of correspondence with any third party concerning the contents of the report.

In the event of the improper use of the report. The SHENZHEN TIMEWAY TESTING LABORATORIES, reserves the rights to withdraw it and to adopt any other remedies which may be appropriate.





## 9. Carrier Frequency Separation

### 9.1 Regulation

According to §15.247(a)(1), frequency hopping systems shall have hopping channel carrier frequencies separated by a minimum of 25 kHz or the 20 dB bandwidth of the hopping channel, whichever is greater. Alternatively, frequency hopping systems operating in the 2400-2483.5 MHz band may have hopping channel carrier frequencies that are separated by 25 kHz or two-thirds of the 20 dB bandwidth of the hopping channel, whichever is greater, provided the systems operate with an output power no greater than 125 mW.

### 9.2 Limits of Carrier Frequency Separation

The Maximum Power Spectral Density Measurement is 25kHz or two-thirds of the 20dB bandwidth of the hopping Channel which is great.

### 9.3 Test Procedure

1. Check the calibration of the measuring instrument using either an internal calibrator or a known signal from an external generator.
2. Set the spectrum analyzer as follows: Span = wide enough to capture the peaks of two adjacent channels: Resolution (or IF) Bandwidth (RBW)  $\geq$  1% of the span; Video (or Average) Bandwidth (VBW)  $\geq$  RBW; Sweep = auto; Detector function = peak; Trace = max hold
3. Measure the separation between the peaks of the adjacent channels using the marker-delta function.
4. Repeat above procedures until all frequencies measured were complete.

The report refers only to the sample tested and does not apply to the bulk.

This report is issued in confidence to the client and it will be strictly treated as such by the SHENZHEN TIMEWAY TESTING LABORATORIES. It may not be reproduced rather in its entirety or in part and it may not be used for advertising. The client to whom the report is issued may, however, show or send it or a certified copy thereof prepared by the SHENZHEN TIMEWAY TESTING LABORATORIES to his customer. Supplier or others persons directly concerned. SHENZHEN TIMEWAY TESTING LABORATORIES will not, without the consent of the client enter into any discussion of correspondence with any third party concerning the contents of the report.

In the event of the improper use of the report. The SHENZHEN TIMEWAY TESTING LABORATORIES reserves the rights to withdraw it and to adopt any other remedies which may be appropriate.



#### 9.4 Test Result

Condition	Mode	Antenna	Hopping Freq1 (MHz)	Hopping Freq2 (MHz)	HFS (MHz)	Verdict
NVNT	1-DH5	Ant1	2401.804	2402.804	1	Pass
NVNT	1-DH5	Ant1	2440.804	2441.804	1	Pass
NVNT	1-DH5	Ant1	2478.802	2479.802	1	Pass
NVNT	2-DH5	Ant1	2402.094	2403.094	1	Pass
NVNT	2-DH5	Ant1	2441.092	2442.09	0.998	Pass
NVNT	2-DH5	Ant1	2479.092	2480.092	1	Pass
NVNT	3-DH5	Ant1	2401.968	2402.968	1	Pass
NVNT	3-DH5	Ant1	2440.968	2441.968	1	Pass
NVNT	3-DH5	Ant1	2478.968	2479.966	0.998	Pass

The report refers only to the sample tested and does not apply to the bulk.

This report is issued in confidence to the client and it will be strictly treated as such by the SHENZHEN TIMEWAY TESTING LABORATORIES. It may not be reproduced rather in its entirety or in part and it may not be used for advertising. The client to whom the report is issued may, however, show or send it or a certified copy thereof prepared by the SHENZHEN TIMEWAY TESTING LABORATORIES to his customer. Supplier or others persons directly concerned. SHENZHEN TIMEWAY TESTING LABORATORIES will not, without the consent of the client enter into any discussion of correspondence with any third party concerning the contents of the report.

In the event of the improper use of the report. The SHENZHEN TIMEWAY TESTING LABORATORIES reserves the rights to withdraw it and to adopt any other remedies which may be appropriate.

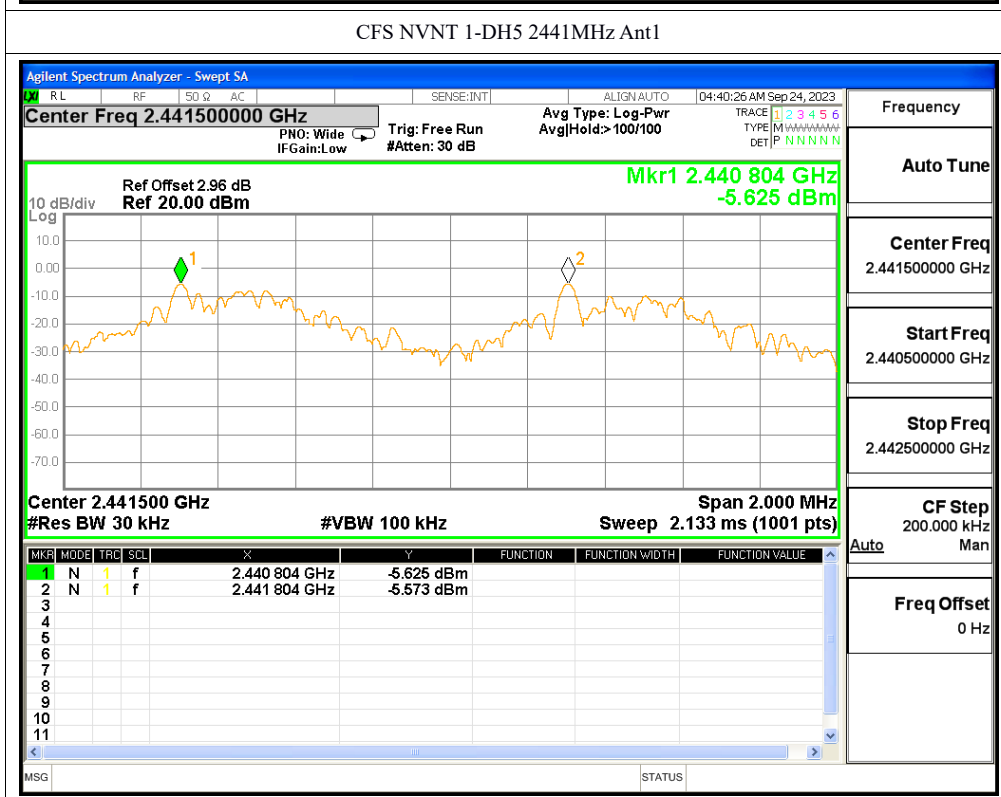
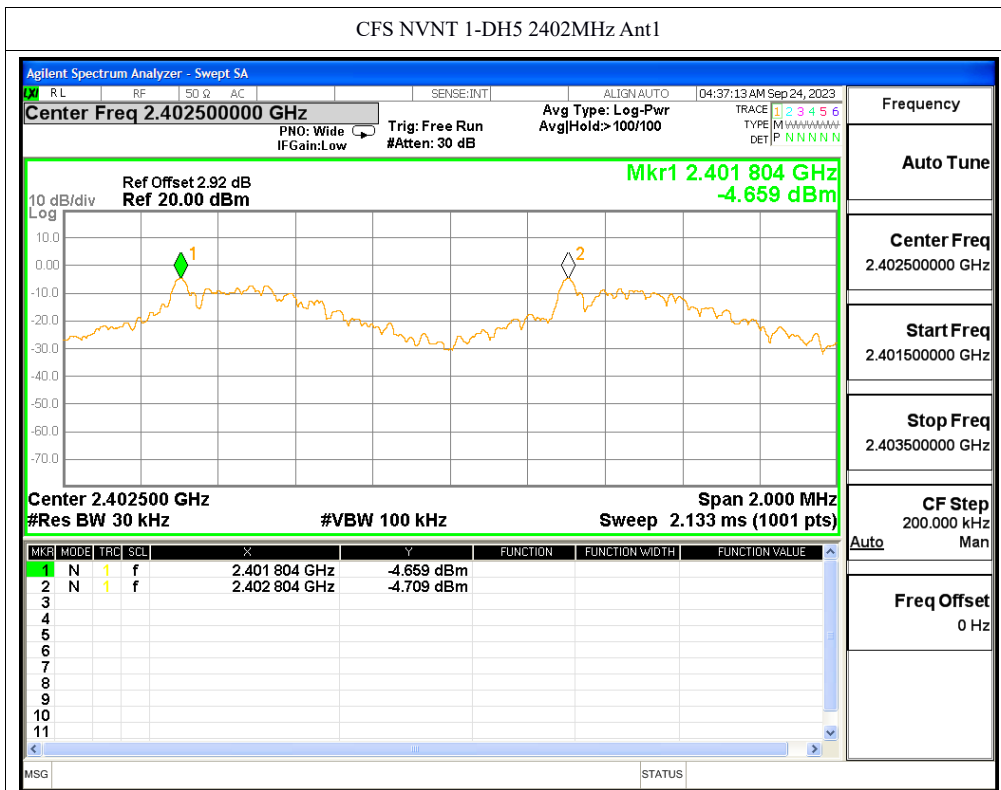

The report refers only to the sample tested and does not apply to the bulk.

This report is issued in confidence to the client and it will be strictly treated as such by the SHENZHEN TIMEWAY TESTING LABORATORIES. It may not be reproduced rather in its entirety or in part and it may not be used for advertising. The client to whom the report is issued may, however, show or send it, or a certified copy thereof prepared by the SHENZHEN TIMEWAY TESTING LABORATORIES, to his customer. Supplier or others persons directly concerned. SHENZHEN TIMEWAY TESTING LABORATORIES, will not, without the consent of the client enter into any discussion of correspondence with any third party concerning the contents of the report.

In the event of the improper use of the report. The SHENZHEN TIMEWAY TESTING LABORATORIES, reserves the rights to withdraw it and to adopt any other remedies which may be appropriate.

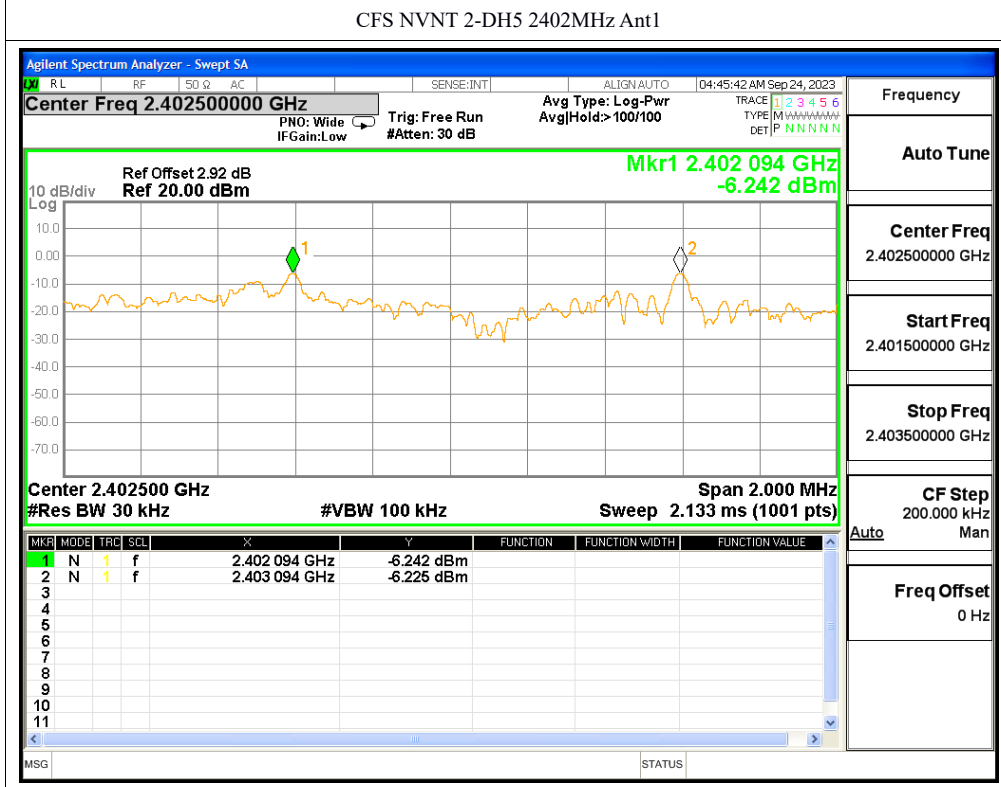
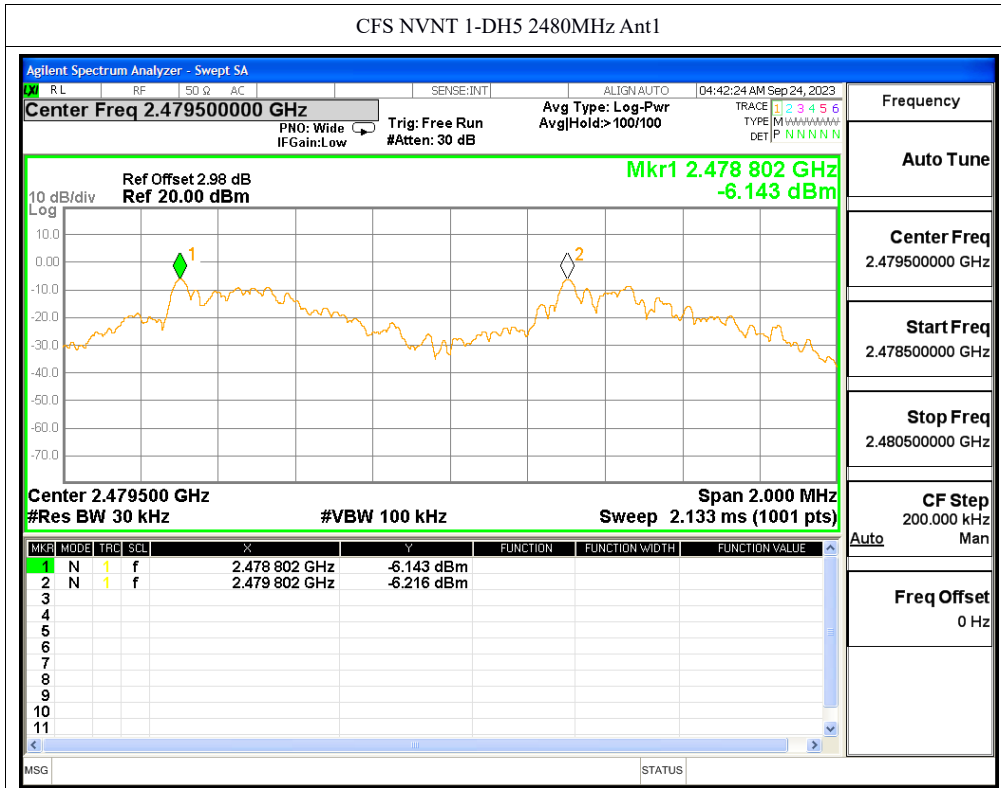

The report refers only to the sample tested and does not apply to the bulk.

This report is issued in confidence to the client and it will be strictly treated as such by the SHENZHEN TIMEWAY TESTING LABORATORIES. It may not be reproduced rather in its entirety or in part and it may not be used for advertising. The client to whom the report is issued may, however, show or send it, or a certified copy thereof prepared by the SHENZHEN TIMEWAY TESTING LABORATORIES, to his customer. Supplier or others persons directly concerned. SHENZHEN TIMEWAY TESTING LABORATORIES, will not, without the consent of the client enter into any discussion of correspondence with any third party concerning the contents of the report.

In the event of the improper use of the report. The SHENZHEN TIMEWAY TESTING LABORATORIES, reserves the rights to withdraw it and to adopt any other remedies which may be appropriate.

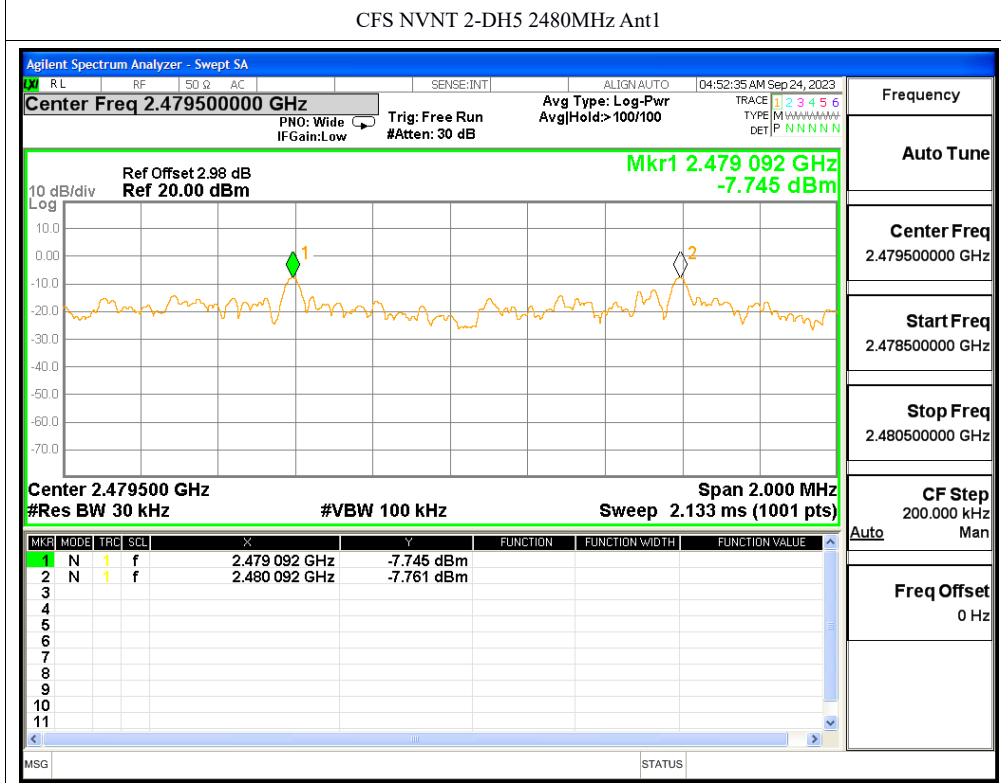
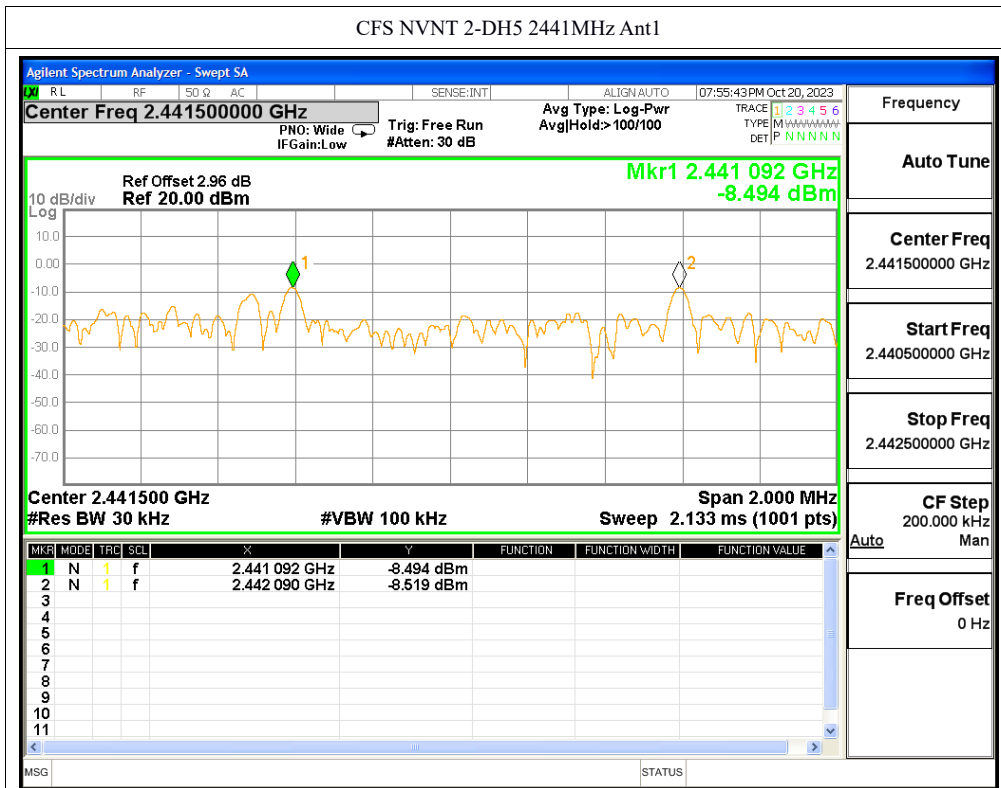

The report refers only to the sample tested and does not apply to the bulk.  
 This report is issued in confidence to the client and it will be strictly treated as such by the SHENZHEN TIMEWAY TESTING LABORATORIES. It may not be reproduced rather in its entirety or in part and it may not be used for advertising. The client to whom the report is issued may, however, show or send it, or a certified copy thereof prepared by the SHENZHEN TIMEWAY TESTING LABORATORIES, to his customer. Supplier or others persons directly concerned. SHENZHEN TIMEWAY TESTING LABORATORIES, will not, without the consent of the client enter into any discussion of correspondence with any third party concerning the contents of the report.  
 In the event of the improper use of the report. The SHENZHEN TIMEWAY TESTING LABORATORIES, reserves the rights to withdraw it and to adopt any other remedies which may be appropriate.

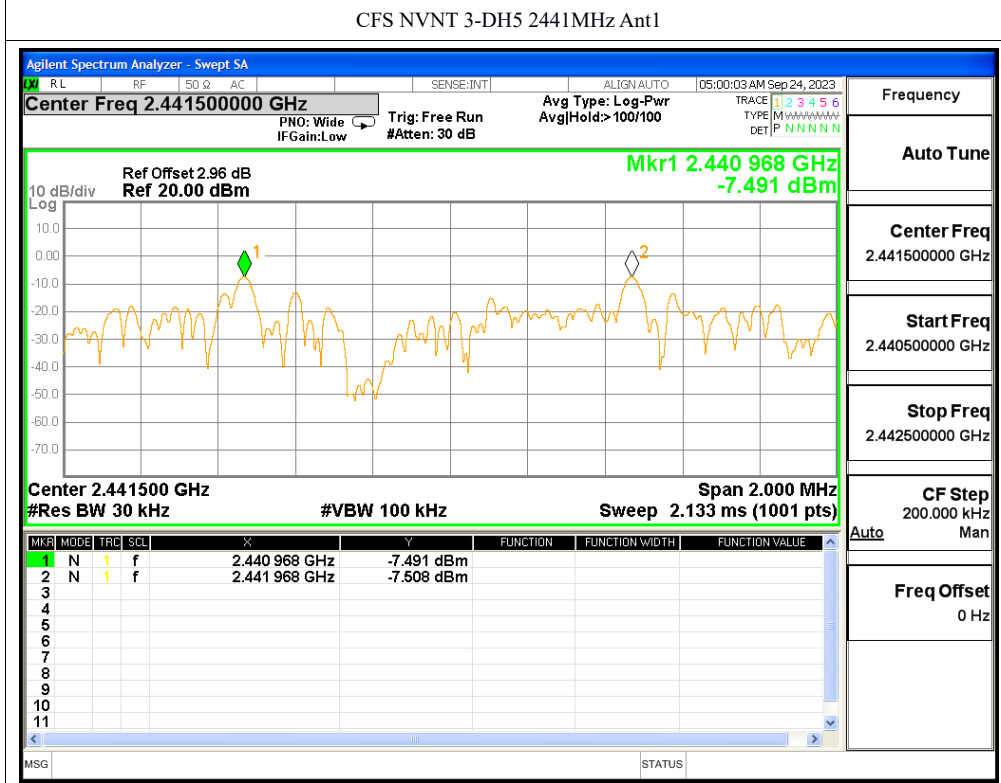
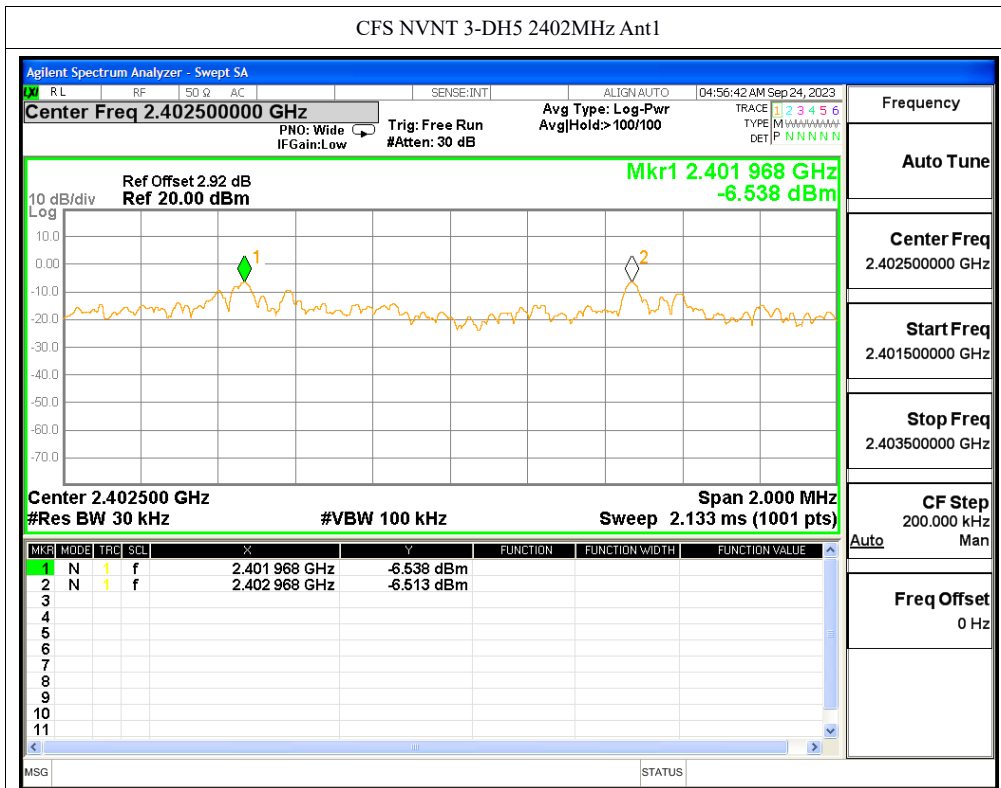

The report refers only to the sample tested and does not apply to the bulk.

This report is issued in confidence to the client and it will be strictly treated as such by the SHENZHEN TIMEWAY TESTING LABORATORIES. It may not be reproduced rather in its entirety or in part and it may not be used for advertising. The client to whom the report is issued may, however, show or send it, or a certified copy thereof prepared by the SHENZHEN TIMEWAY TESTING LABORATORIES, to his customer. Supplier or others persons directly concerned. SHENZHEN TIMEWAY TESTING LABORATORIES, will not, without the consent of the client enter into any discussion of correspondence with any third party concerning the contents of the report.

In the event of the improper use of the report. The SHENZHEN TIMEWAY TESTING LABORATORIES, reserves the rights to withdraw it and to adopt any other remedies which may be appropriate.

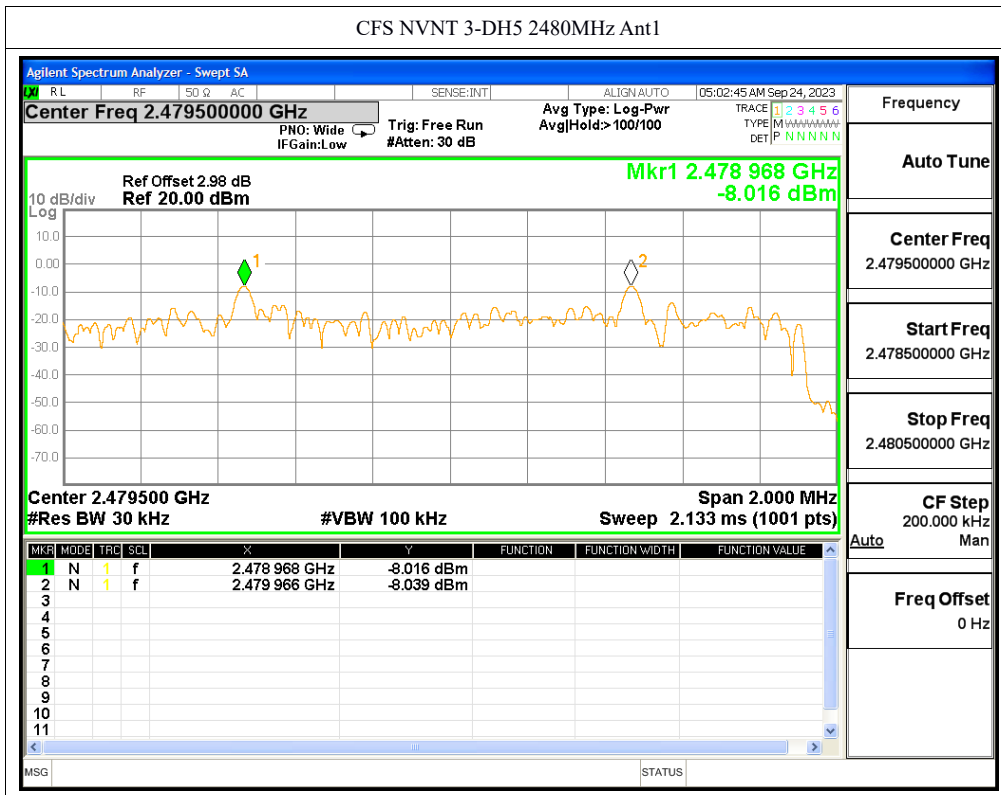

The report refers only to the sample tested and does not apply to the bulk.

This report is issued in confidence to the client and it will be strictly treated as such by the SHENZHEN TIMEWAY TESTING LABORATORIES. It may not be reproduced rather in its entirety or in part and it may not be used for advertising. The client to whom the report is issued may, however, show or send it, or a certified copy thereof prepared by the SHENZHEN TIMEWAY TESTING LABORATORIES, to his customer. Supplier or others persons directly concerned. SHENZHEN TIMEWAY TESTING LABORATORIES, will not, without the consent of the client enter into any discussion of correspondence with any third party concerning the contents of the report.

In the event of the improper use of the report. The SHENZHEN TIMEWAY TESTING LABORATORIES, reserves the rights to withdraw it and to adopt any other remedies which may be appropriate.



## **10. Number of Hopping Channels**

### **10.1 Regulation**

According to §15.247(a)(1)(iii), frequency hopping systems in the 2400-2483.5 MHz band shall use at least 15 channels. The average time of occupancy on any channel shall not be greater than 0.4 seconds within a period of 0.4 seconds multiplied by the number of hopping channels employed. Frequency hopping systems may avoid or suppress transmissions on a particular hopping frequency provided that a minimum of 15 channels are used. According to §15.247(b)(1), for frequency hopping systems operating in the 2400-2483.5 MHz band employing at least 75 non-overlapping hopping channels, and all frequency hopping systems in the 5725-5850 MHz band: 1 watt. For all other frequency hopping systems in the 2400-2483.5 MHz band: 0.125 watts.

### **10.2 Limits of Number of Hopping Channels**

The frequency hopping systems in the 2400-2483.5MHz band shall use at least 15 channels.

### **10.3 Test Procedure**

1. Check the calibration of the measuring instrument using either an internal calibrator or a known signal from an external generator.
2. Set the spectrum analyzer as follows: Span = the frequency band of operation; RBW=100 kHz, VBW=300 kHz; Sweep = auto; Detector function = peak; Trace = max hold
3. Record the number of hopping channels.

The report refers only to the sample tested and does not apply to the bulk.

This report is issued in confidence to the client and it will be strictly treated as such by the SHENZHEN TIMEWAY TESTING LABORATORIES. It may not be reproduced rather in its entirety or in part and it may not be used for advertising. The client to whom the report is issued may, however, show or send it . or a certified copy there of prepared by the SHENZHEN TIMEWAY TESTING LABORATORIES. to his customer. Supplier or others persons directly concerned. SHENZHEN TIMEWAY TESTING LABORATORIES. will not, without the consent of the client enter into any discussion of correspondence with any third party concerning the contents of the report.

In the event of the improper use of the report. The SHENZHEN TIMEWAY TESTING LABORATORIES. reserves the rights to withdraw it and to adopt any other remedies which may be appropriate.





#### 10.4 Test Result

##### Type of Modulation:

Condition	Mode	Antenna	Hopping Number	Limit	Verdict
NVNT	1-DH5	Ant1	79	15	Pass
	2-DH5			15	Pass
	3-DH5			15	Pass

The report refers only to the sample tested and does not apply to the bulk.

This report is issued in confidence to the client and it will be strictly treated as such by the SHENZHEN TIMEWAY TESTING LABORATORIES. It may not be reproduced rather in its entirety or in part and it may not be used for advertising. The client to whom the report is issued may, however, show or send it or a certified copy thereof prepared by the SHENZHEN TIMEWAY TESTING LABORATORIES to his customer. Supplier or others persons directly concerned. SHENZHEN TIMEWAY TESTING LABORATORIES will not, without the consent of the client enter into any discussion of correspondence with any third party concerning the contents of the report.

In the event of the improper use of the report. The SHENZHEN TIMEWAY TESTING LABORATORIES reserves the rights to withdraw it and to adopt any other remedies which may be appropriate.

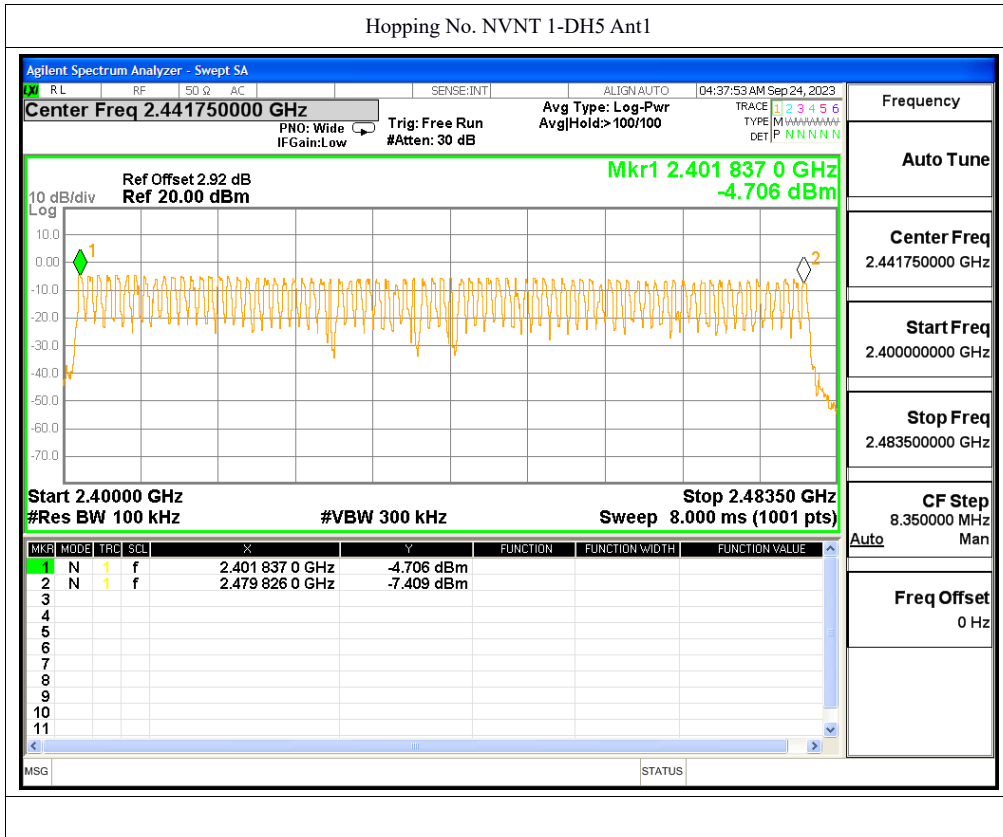

The report refers only to the sample tested and does not apply to the bulk.

This report is issued in confidence to the client and it will be strictly treated as such by the SHENZHEN TIMEWAY TESTING LABORATORIES. It may not be reproduced rather in its entirety or in part and it may not be used for advertising. The client to whom the report is issued may, however, show or send it to a certified copy thereof prepared by the SHENZHEN TIMEWAY TESTING LABORATORIES to his customer. Supplier or others persons directly concerned. SHENZHEN TIMEWAY TESTING LABORATORIES will not, without the consent of the client enter into any discussion of correspondence with any third party concerning the contents of the report.

In the event of the improper use of the report. The SHENZHEN TIMEWAY TESTING LABORATORIES reserves the rights to withdraw it and to adopt any other remedies which may be appropriate.

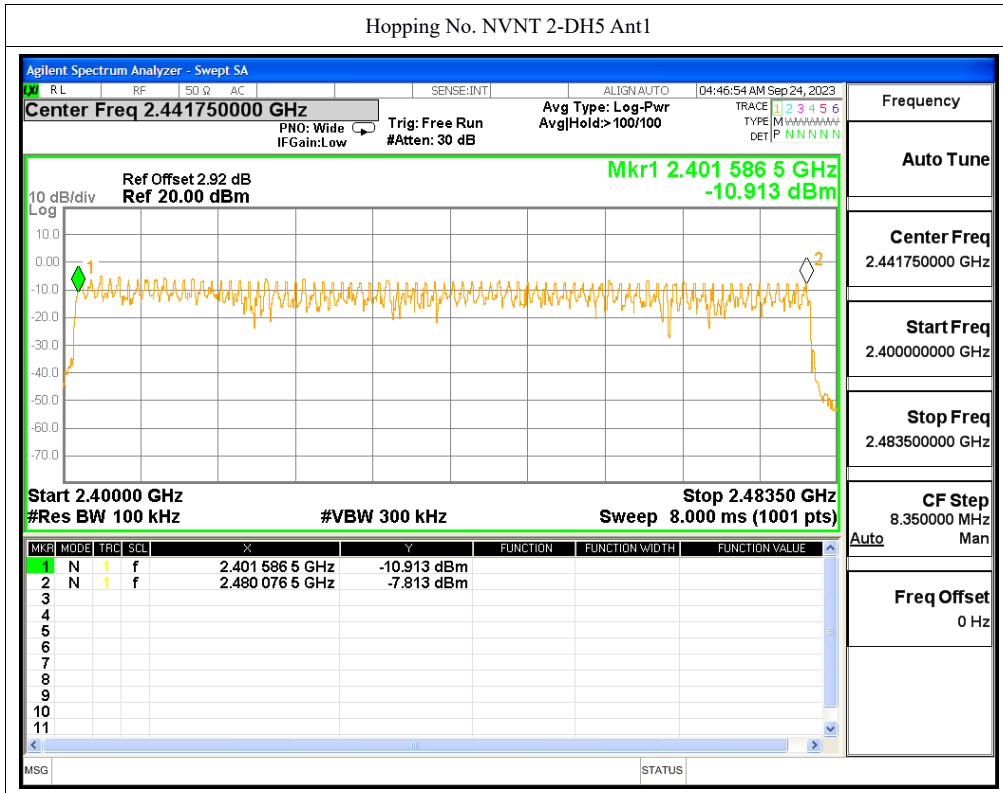

The report refers only to the sample tested and does not apply to the bulk.

This report is issued in confidence to the client and it will be strictly treated as such by the SHENZHEN TIMEWAY TESTING LABORATORIES. It may not be reproduced rather in its entirety or in part and it may not be used for advertising. The client to whom the report is issued may, however, show or send it or a certified copy thereof prepared by the SHENZHEN TIMEWAY TESTING LABORATORIES to his customer. Supplier or others persons directly concerned. SHENZHEN TIMEWAY TESTING LABORATORIES will not, without the consent of the client enter into any discussion of correspondence with any third party concerning the contents of the report.

In the event of the improper use of the report. The SHENZHEN TIMEWAY TESTING LABORATORIES reserves the rights to withdraw it and to adopt any other remedies which may be appropriate.

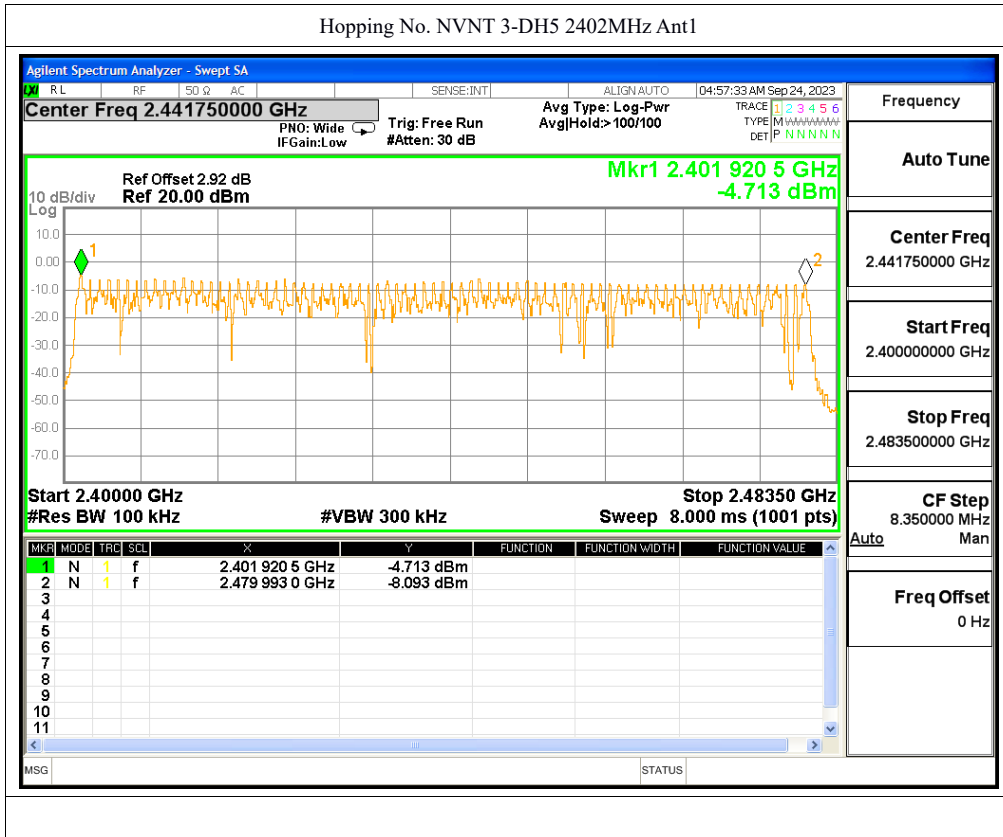

The report refers only to the sample tested and does not apply to the bulk.

This report is issued in confidence to the client and it will be strictly treated as such by the SHENZHEN TIMEWAY TESTING LABORATORIES. It may not be reproduced rather in its entirety or in part and it may not be used for advertising. The client to whom the report is issued may, however, show or send it or a certified copy thereof prepared by the SHENZHEN TIMEWAY TESTING LABORATORIES to his customer. Supplier or others persons directly concerned. SHENZHEN TIMEWAY TESTING LABORATORIES will not, without the consent of the client enter into any discussion of correspondence with any third party concerning the contents of the report.

In the event of the improper use of the report. The SHENZHEN TIMEWAY TESTING LABORATORIES reserves the rights to withdraw it and to adopt any other remedies which may be appropriate.



## **11. Time of Occupancy (Dwell Time)**

### **11.1 Regulation**

According to §15.247(a)(1)(iii), frequency hopping systems in the 2400-2483.5 MHz band shall use at least 15 channels. The average time of occupancy on any channel shall not be greater than 0.4 seconds within a period of 0.4 seconds multiplied by the number of hopping channels employed. Frequency hopping systems may avoid or suppress transmissions on a particular hopping frequency provided that a minimum of 15 channels are used.

### **11.2 Limits of Carrier Frequency Separation**

The average time of occupancy on any channel shall not be greater than 0.4 seconds within a period of 0.4 seconds multiplied by the number of hopping channels employed

### **11.3 Test Procedure**

1. Check the calibration of the measuring instrument using either an internal calibrator or a known signal from an external generator.
2. Set the spectrum analyzer as follows: Span = zero span, centered on a hopping channel; RBW = 1 MHz; VBW  $\geq$  RBW; Sweep = as necessary to capture the entire dwell time per hopping channel; Detector function = peak; Trace = max hold
3. Measure the dwell time using the marker-delta function.
4. Repeat above procedures until all frequencies measured were complete.
5. Repeat this test for different modes of operation (e.g., data rate, modulation format, etc.), if applicable.

The report refers only to the sample tested and does not apply to the bulk.

This report is issued in confidence to the client and it will be strictly treated as such by the SHENZHEN TIMEWAY TESTING LABORATORIES. It may not be reproduced rather in its entirety or in part and it may not be used for advertising. The client to whom the report is issued may, however, show or send it or a certified copy thereof prepared by the SHENZHEN TIMEWAY TESTING LABORATORIES to his customer. Supplier or others persons directly concerned. SHENZHEN TIMEWAY TESTING LABORATORIES will not, without the consent of the client enter into any discussion of correspondence with any third party concerning the contents of the report.

In the event of the improper use of the report. The SHENZHEN TIMEWAY TESTING LABORATORIES reserves the rights to withdraw it and to adopt any other remedies which may be appropriate.



**11.4 Test Result**

Condition	Mode	Frequency (MHz)	Antenna	Pulse Time (ms)	Total Dwell Time (ms)	Burst Count	Period Time (ms)	Limit (ms)	Verdict
NVNT	1-DH5	2402	Ant1	2.831	353.875	125	31600	400	Pass
		2441		2.833	101.988	36	31600	400	Pass
		2480		2.833	67.992	24	31600	400	Pass
	2-DH5	2402		2.893	318.23	110	31600	400	Pass
		2441		2.893	109.934	38	31600	400	Pass
		2480		2.885	83.665	29	31600	400	Pass
	3-DH5	2402		2.765	331.8	120	31600	400	Pass
		2441		2.76	80.04	29	31600	400	Pass
		2480		2.765	113.365	41	31600	400	Pass

Actual = Reading × (Hopping rate / Number of channels) × Test period, Test period = 0.4 [seconds / channel] × 79 [channel] = 31.6 [seconds] NOTE: The EUT makes worst case 1600 hops per second or 1 time slot has a length of 625µs with 79 channels.

A DH5 Packet needs 5 time slot for transmitting and 1 time slot for receiving. Then the EUT makes worst case 266.667 hops per second with 79 channels.

A DH3 Packet needs 3 time slot for transmitting and 1 time slot for receiving. Then the EUT makes worst case 400 hops per second with 79 channels.

A DH1 Packet needs 1 time slot for transmitting and 1 time slot for receiving. Then the EUT makes worst case 800 hops per second with 79 channels.

**Note: 1-DH5, 2-DH5, 3-DH5 were the worst cases**

The report refers only to the sample tested and does not apply to the bulk.  
 This report is issued in confidence to the client and it will be strictly treated as such by the SHENZHEN TIMEWAY TESTING LABORATORIES. It may not be reproduced rather in its entirety or in part and it may not be used for advertising. The client to whom the report is issued may, however, show or send it . or a certified copy there of prepared by the SHENZHEN TIMEWAY TESTING LABORATORIES. to his customer. Supplier or others persons directly concerned. SHENZHEN TIMEWAY TESTING LABORATORIES. will not, without the consent of the client enter into any discussion of correspondence with any third party concerning the contents of the report.  
 In the event of the improper use of the report. The SHENZHEN TIMEWAY TESTING LABORATORIES. reserves the rights to withdraw it and to adopt any other remedies which may be appropriate.

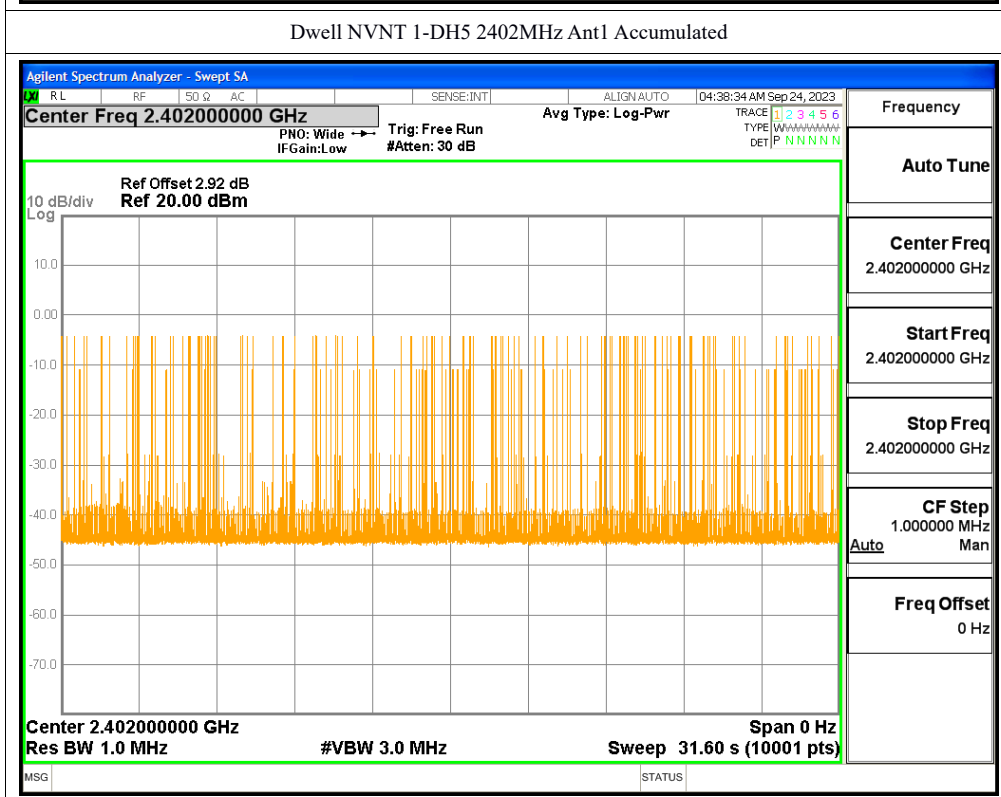
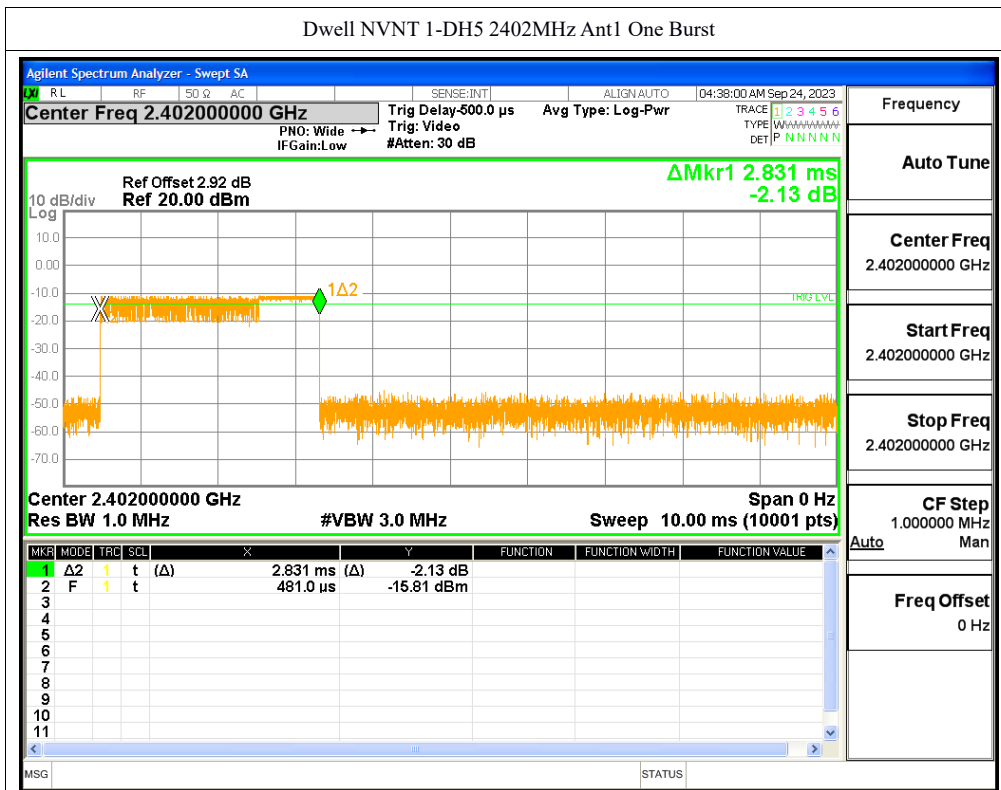

The report refers only to the sample tested and does not apply to the bulk.  
 This report is issued in confidence to the client and it will be strictly treated as such by the SHENZHEN TIMEWAY TESTING LABORATORIES. It may not be reproduced rather in its entirety or in part and it may not be used for advertising. The client to whom the report is issued may, however, show or send it, or a certified copy thereof prepared by the SHENZHEN TIMEWAY TESTING LABORATORIES, to his customer. Supplier or others persons directly concerned. SHENZHEN TIMEWAY TESTING LABORATORIES, will not, without the consent of the client enter into any discussion of correspondence with any third party concerning the contents of the report.  
 In the event of the improper use of the report. The SHENZHEN TIMEWAY TESTING LABORATORIES, reserves the rights to withdraw it and to adopt any other remedies which may be appropriate.

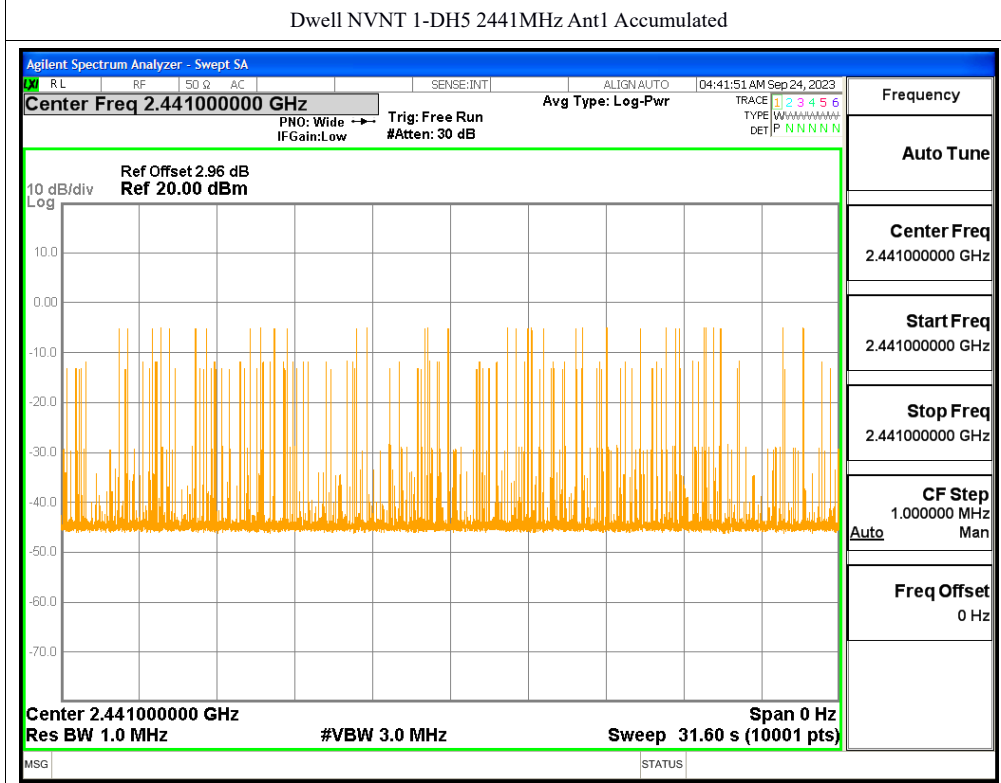
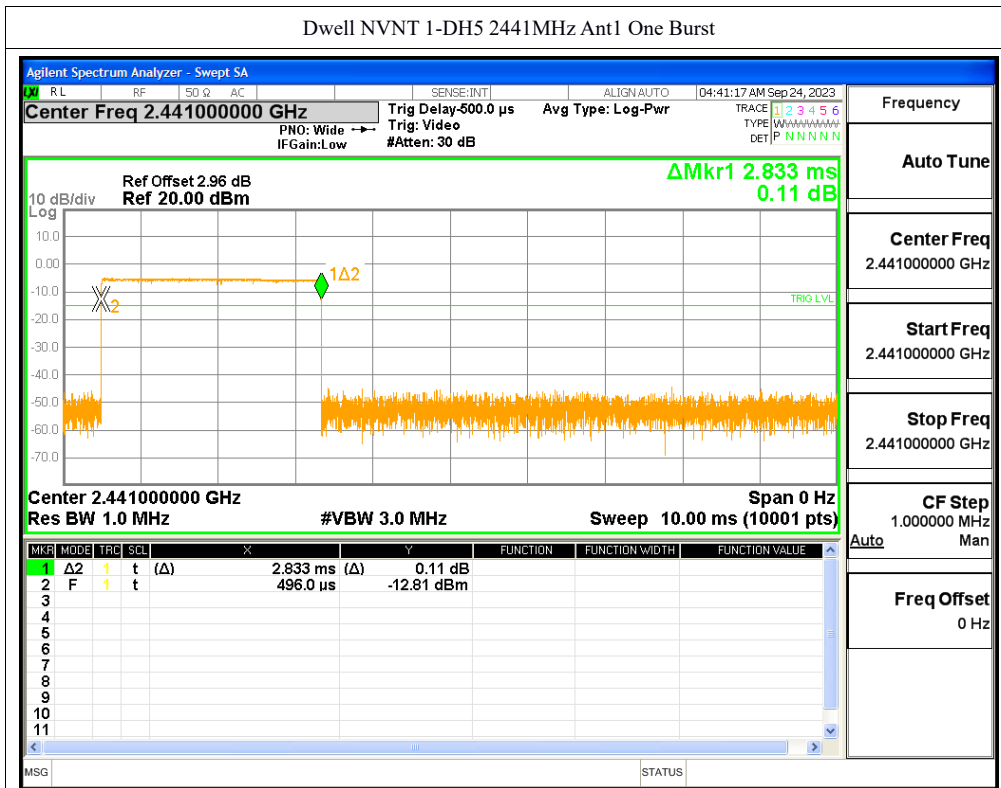

The report refers only to the sample tested and does not apply to the bulk. This report is issued in confidence to the client and it will be strictly treated as such by the SHENZHEN TIMEWAY TESTING LABORATORIES. It may not be reproduced rather in its entirety or in part and it may not be used for advertising. The client to whom the report is issued may, however, show or send it, or a certified copy thereof, to the SHENZHEN TIMEWAY TESTING LABORATORIES, to his customer. Supplier or others persons directly concerned. SHENZHEN TIMEWAY TESTING LABORATORIES, will not, without the consent of the client enter into any discussion of correspondence with any third party concerning the contents of the report. In the event of the improper use of the report. The SHENZHEN TIMEWAY TESTING LABORATORIES, reserves the rights to withdraw it and to adopt any other remedies which may be appropriate.



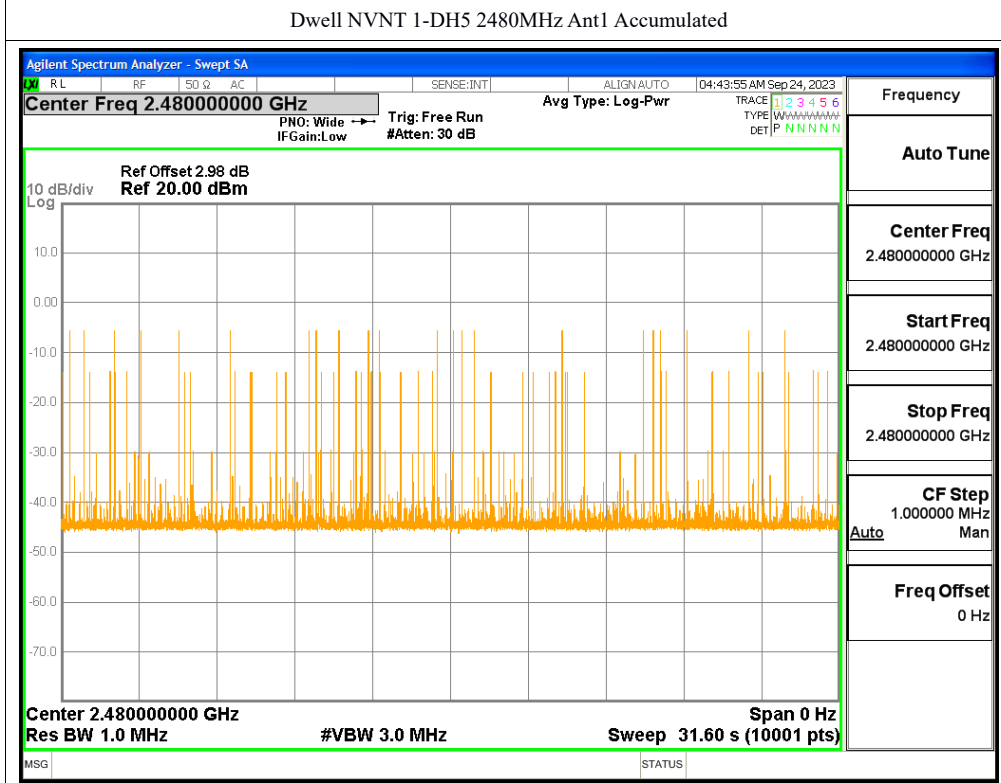
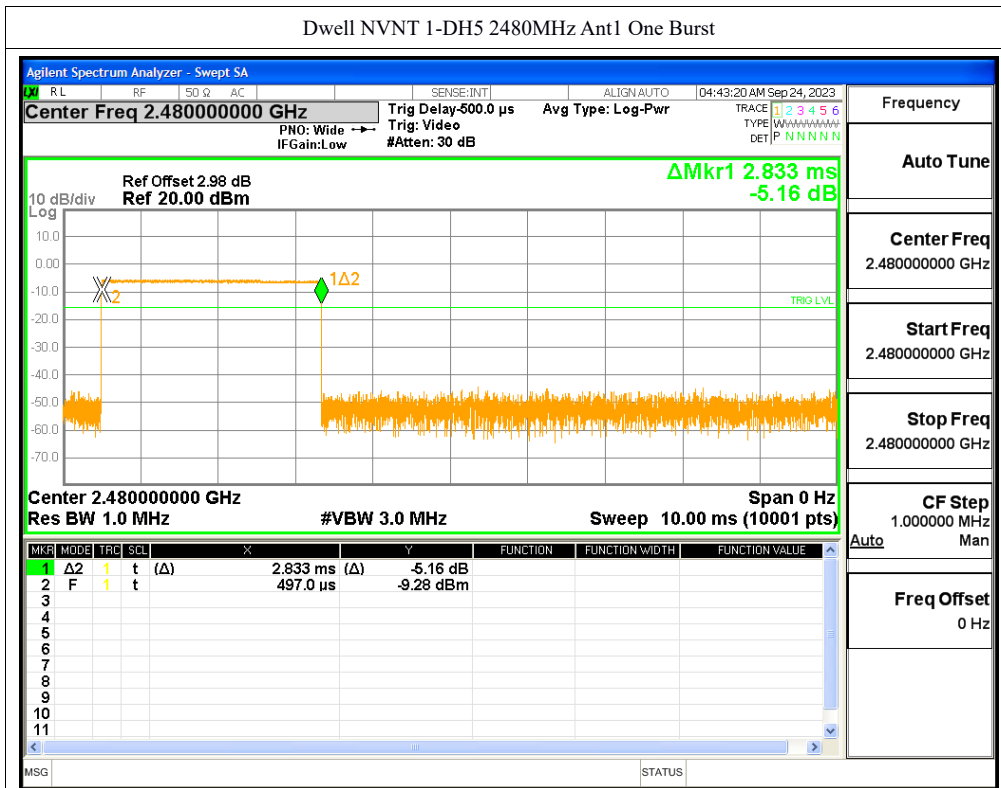

The report refers only to the sample tested and does not apply to the bulk. This report is issued in confidence to the client and it will be strictly treated as such by the SHENZHEN TIMEWAY TESTING LABORATORIES. It may not be reproduced rather in its entirety or in part and it may not be used for advertising. The client to whom the report is issued may, however, show or send it, or a certified copy thereof, to his customer. Supplier or others persons directly concerned. SHENZHEN TIMEWAY TESTING LABORATORIES will not, without the consent of the client enter into any discussion of correspondence with any third party concerning the contents of the report. In the event of the improper use of the report. The SHENZHEN TIMEWAY TESTING LABORATORIES reserves the rights to withdraw it and to adopt any other remedies which may be appropriate.

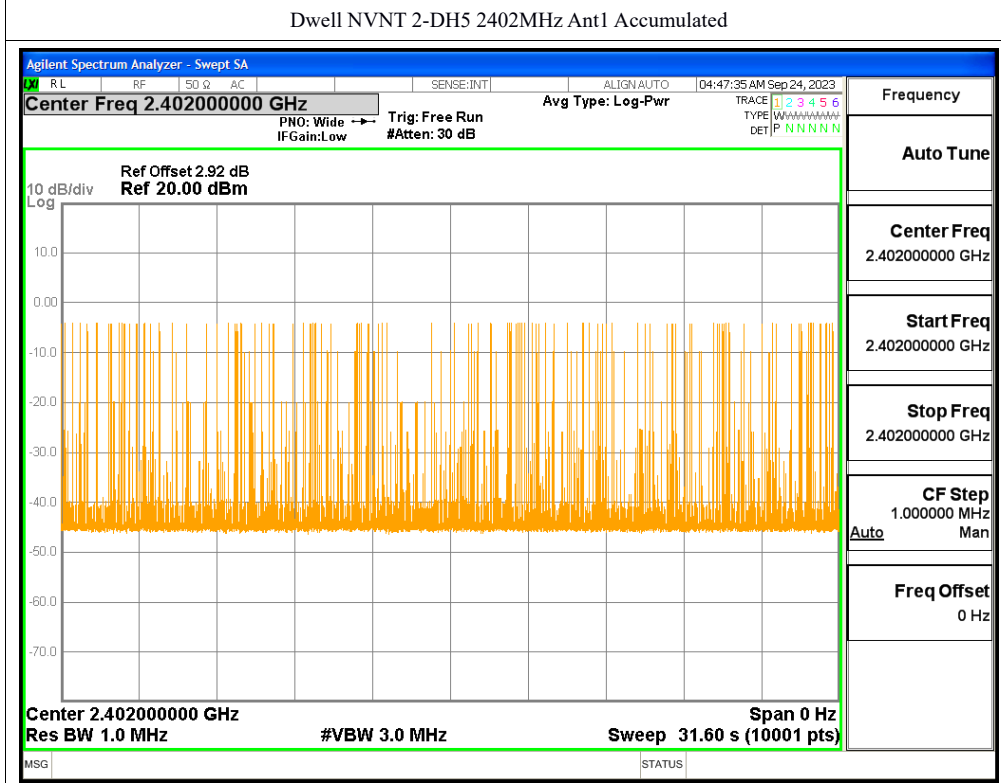
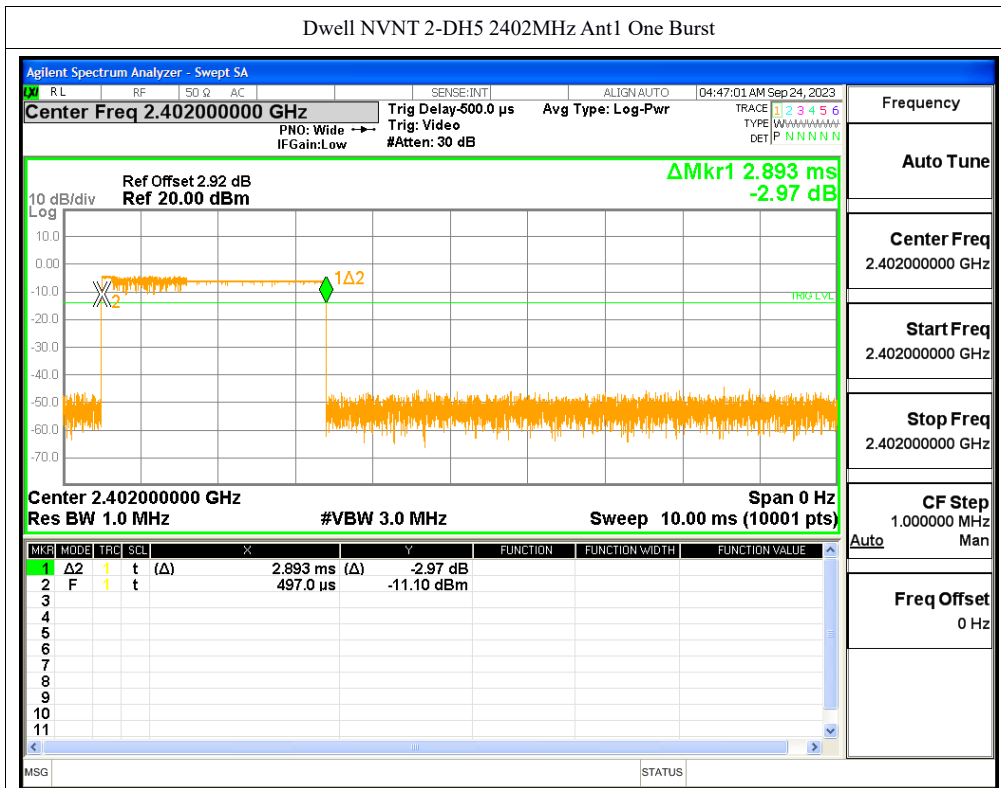

The report refers only to the sample tested and does not apply to the bulk. This report is issued in confidence to the client and it will be strictly treated as such by the SHENZHEN TIMEWAY TESTING LABORATORIES. It may not be reproduced rather in its entirety or in part and it may not be used for advertising. The client to whom the report is issued may, however, show or send it, or a certified copy thereof, prepared by the SHENZHEN TIMEWAY TESTING LABORATORIES, to his customer. Supplier or others persons directly concerned, SHENZHEN TIMEWAY TESTING LABORATORIES, will not, without the consent of the client enter into any discussion of correspondence with any third party concerning the contents of the report. In the event of the improper use of the report, the SHENZHEN TIMEWAY TESTING LABORATORIES, reserves the rights to withdraw it and to adopt any other remedies which may be appropriate.

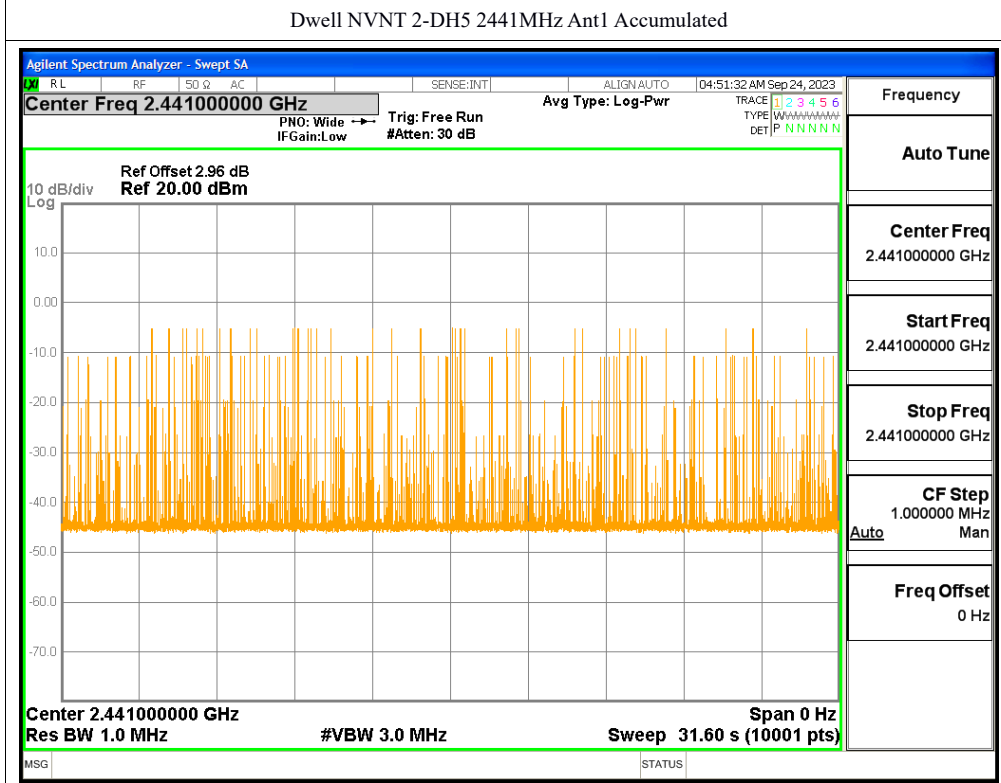
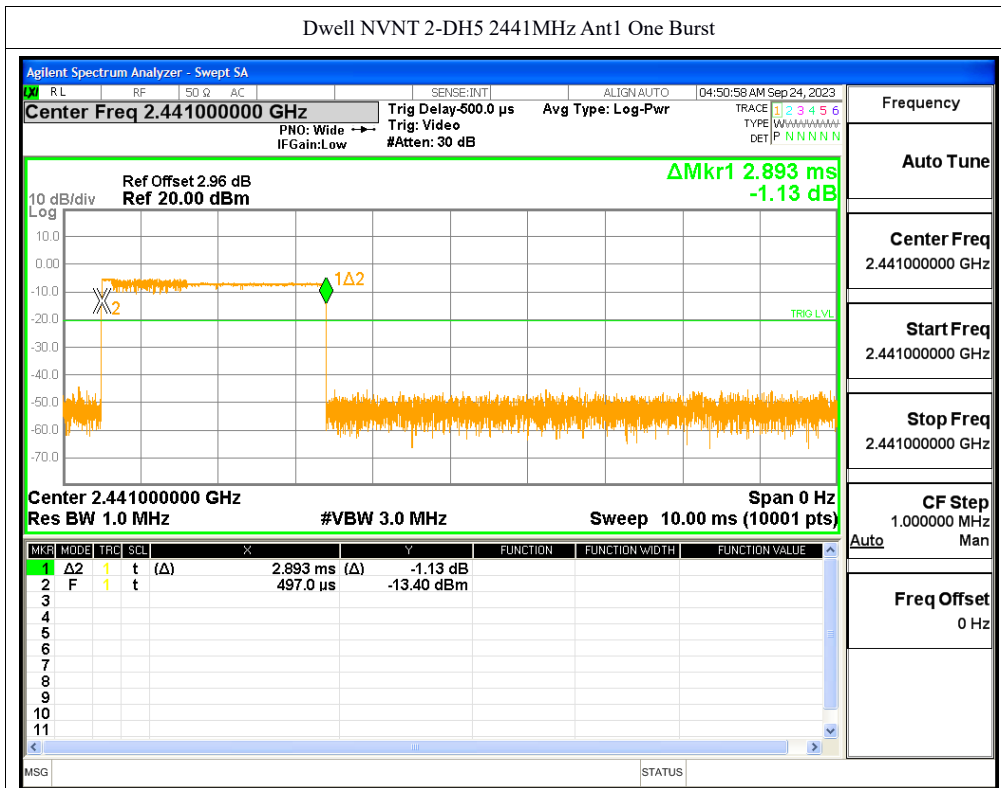

The report refers only to the sample tested and does not apply to the bulk. This report is issued in confidence to the client and it will be strictly treated as such by the SHENZHEN TIMEWAY TESTING LABORATORIES. It may not be reproduced rather in its entirety or in part and it may not be used for advertising. The client to whom the report is issued may, however, show or send it, or a certified copy thereof, to his customer. Supplier or others persons directly concerned. SHENZHEN TIMEWAY TESTING LABORATORIES. will not, without the consent of the client enter into any discussion of correspondence with any third party concerning the contents of the report. In the event of the improper use of the report. The SHENZHEN TIMEWAY TESTING LABORATORIES. reserves the rights to withdraw it and to adopt any other remedies which may be appropriate.

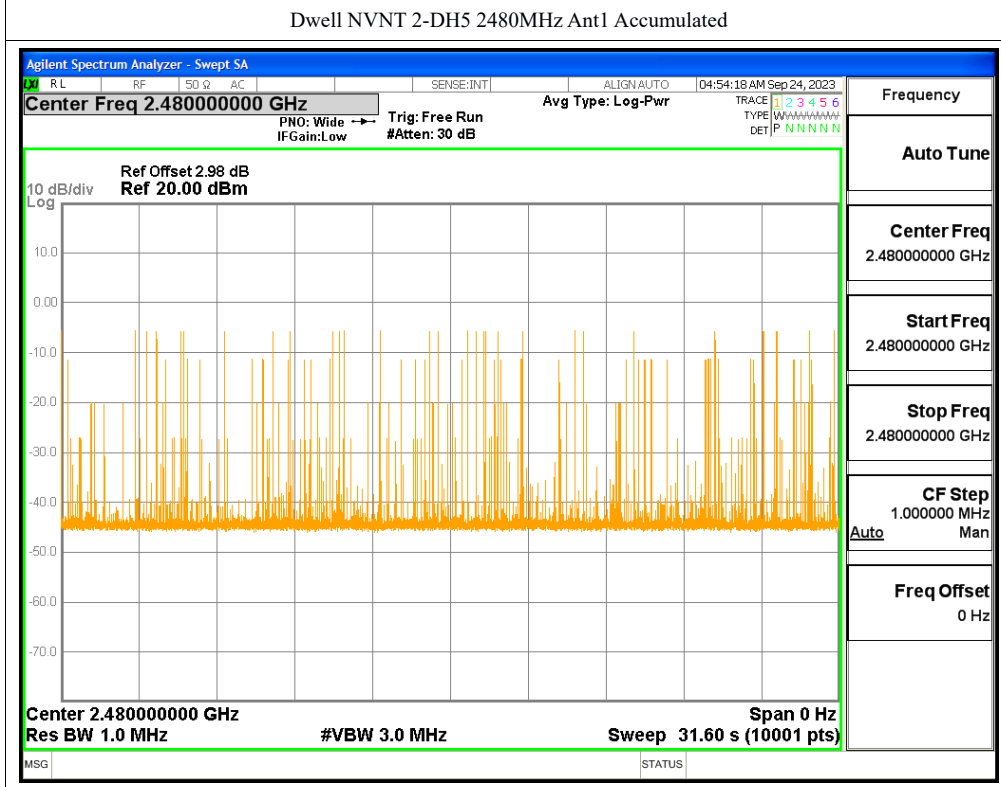
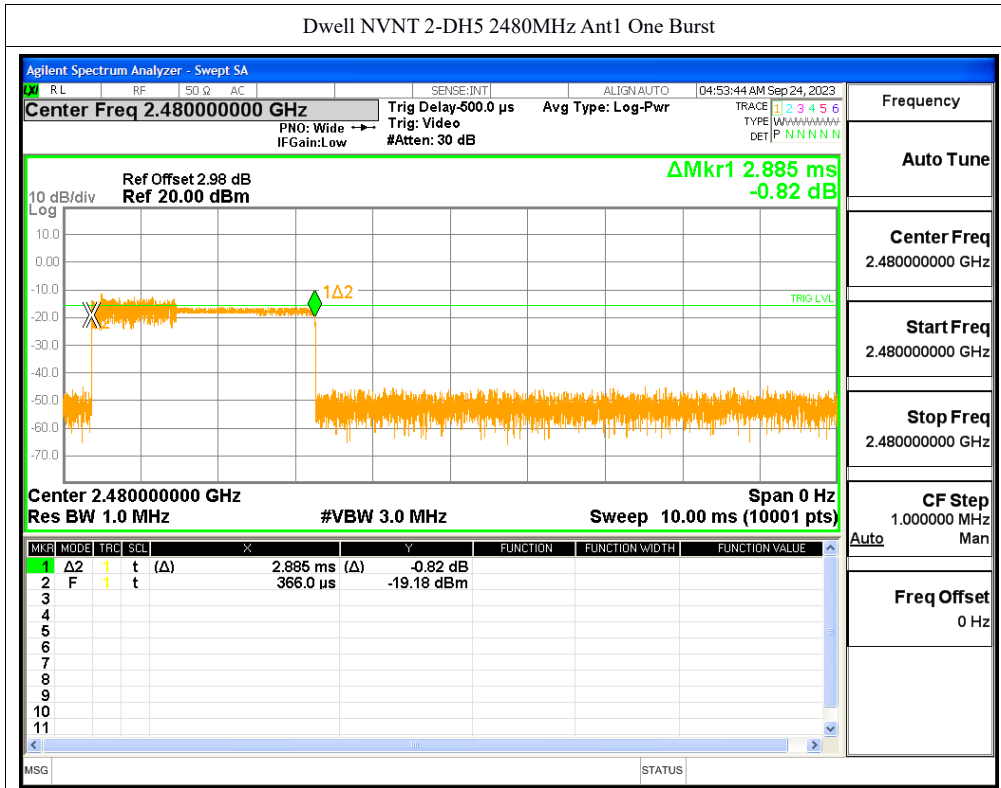

The report refers only to the sample tested and does not apply to the bulk. This report is issued in confidence to the client and it will be strictly treated as such by the SHENZHEN TIMEWAY TESTING LABORATORIES. It may not be reproduced rather in its entirety or in part and it may not be used for advertising. The client to whom the report is issued may, however, show or send it, or a certified copy thereof, prepared by the SHENZHEN TIMEWAY TESTING LABORATORIES, to his customer. Supplier or others persons directly concerned. SHENZHEN TIMEWAY TESTING LABORATORIES, will not, without the consent of the client enter into any discussion of correspondence with any third party concerning the contents of the report. In the event of the improper use of the report. The SHENZHEN TIMEWAY TESTING LABORATORIES, reserves the rights to withdraw it and to adopt any other remedies which may be appropriate.

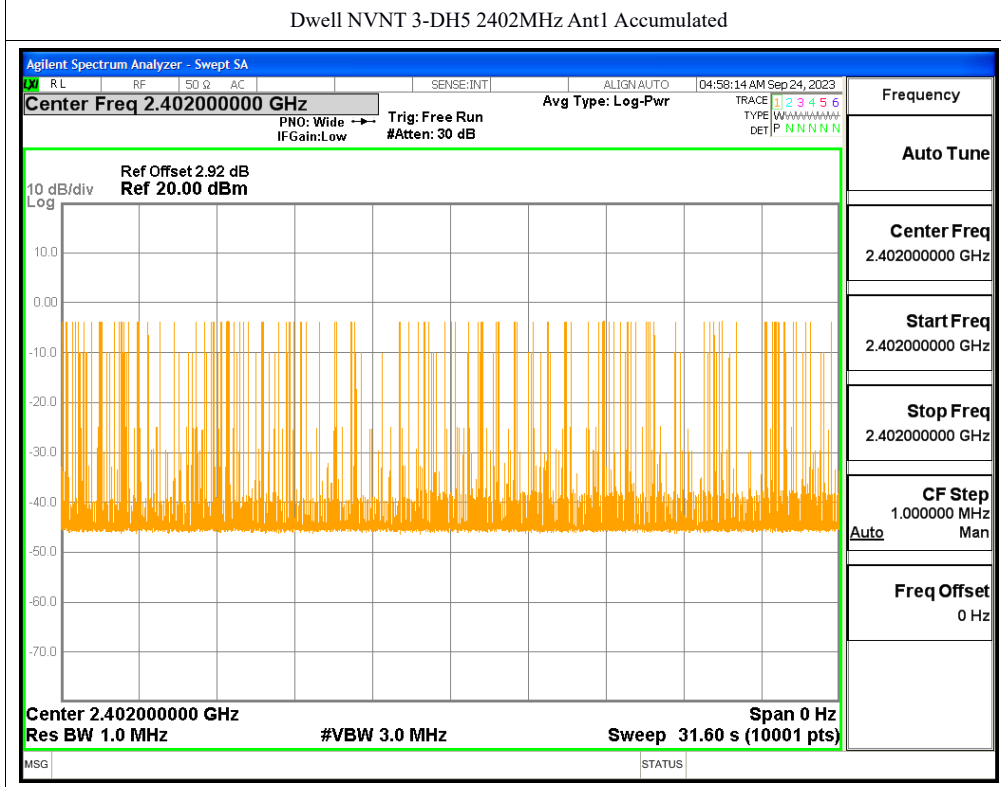
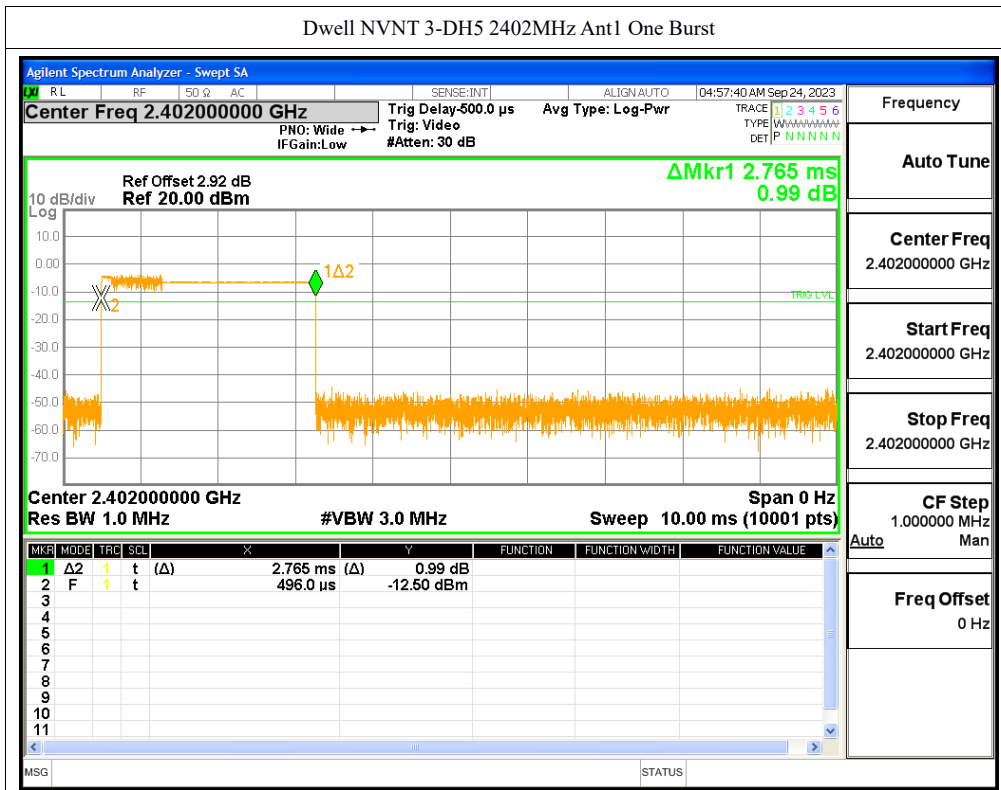

The report refers only to the sample tested and does not apply to the bulk.  
 This report is issued in confidence to the client and it will be strictly treated as such by the SHENZHEN TIMEWAY TESTING LABORATORIES. It may not be reproduced rather in its entirety or in part and it may not be used for advertising. The client to whom the report is issued may, however, show or send it, or a certified copy thereof, to the SHENZHEN TIMEWAY TESTING LABORATORIES, to his customer. Supplier or others persons directly concerned. SHENZHEN TIMEWAY TESTING LABORATORIES, will not, without the consent of the client enter into any discussion of correspondence with any third party concerning the contents of the report.  
 In the event of the improper use of the report. The SHENZHEN TIMEWAY TESTING LABORATORIES, reserves the rights to withdraw it and to adopt any other remedies which may be appropriate.

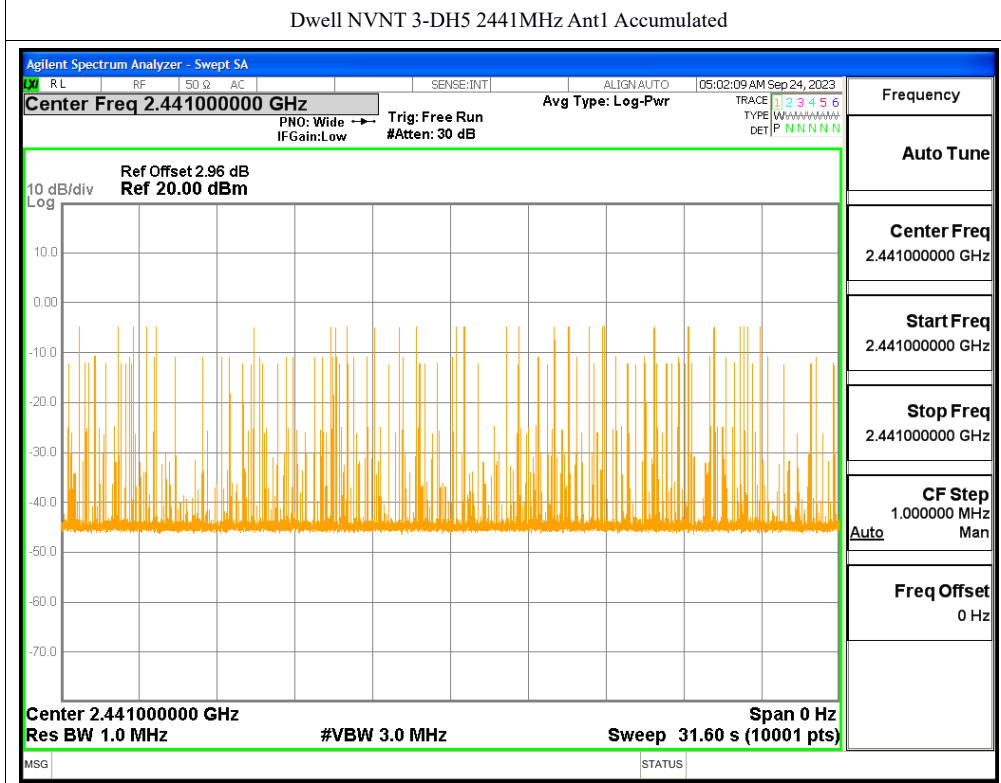
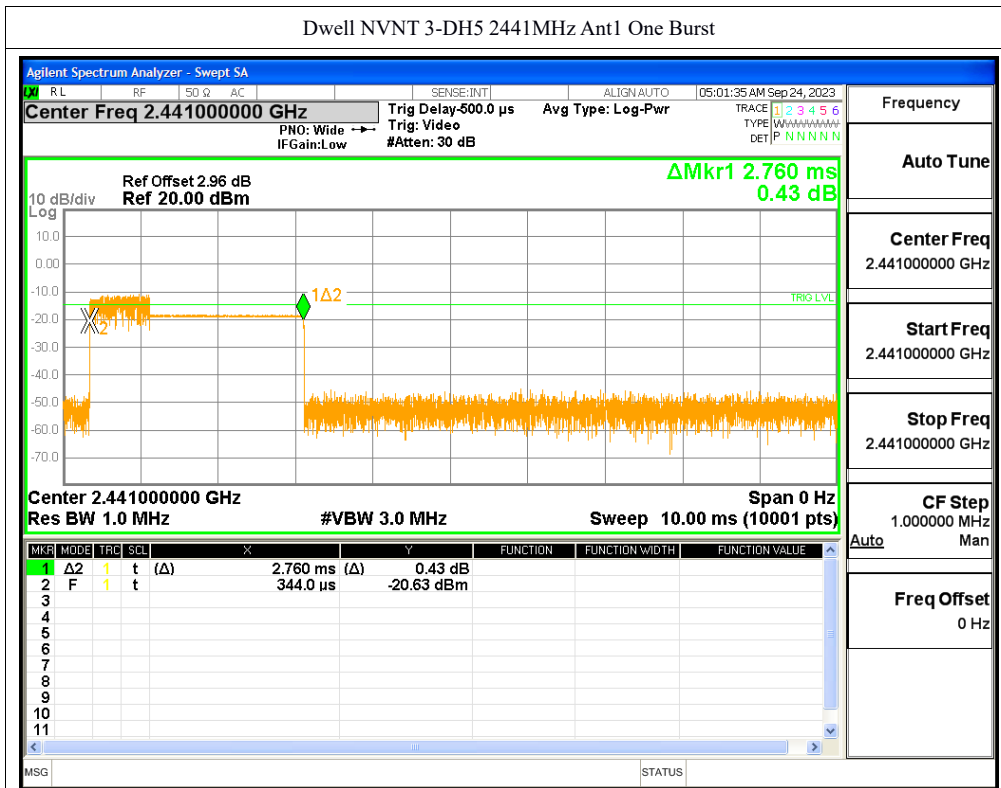

The report refers only to the sample tested and does not apply to the bulk. This report is issued in confidence to the client and it will be strictly treated as such by the SHENZHEN TIMEWAY TESTING LABORATORIES. It may not be reproduced rather in its entirety or in part and it may not be used for advertising. The client to whom the report is issued may, however, show or send it, or a certified copy thereof prepared by the SHENZHEN TIMEWAY TESTING LABORATORIES, to his customer. Supplier or others persons directly concerned. SHENZHEN TIMEWAY TESTING LABORATORIES, will not, without the consent of the client enter into any discussion of correspondence with any third party concerning the contents of the report. In the event of the improper use of the report. The SHENZHEN TIMEWAY TESTING LABORATORIES, reserves the rights to withdraw it and to adopt any other remedies which may be appropriate.

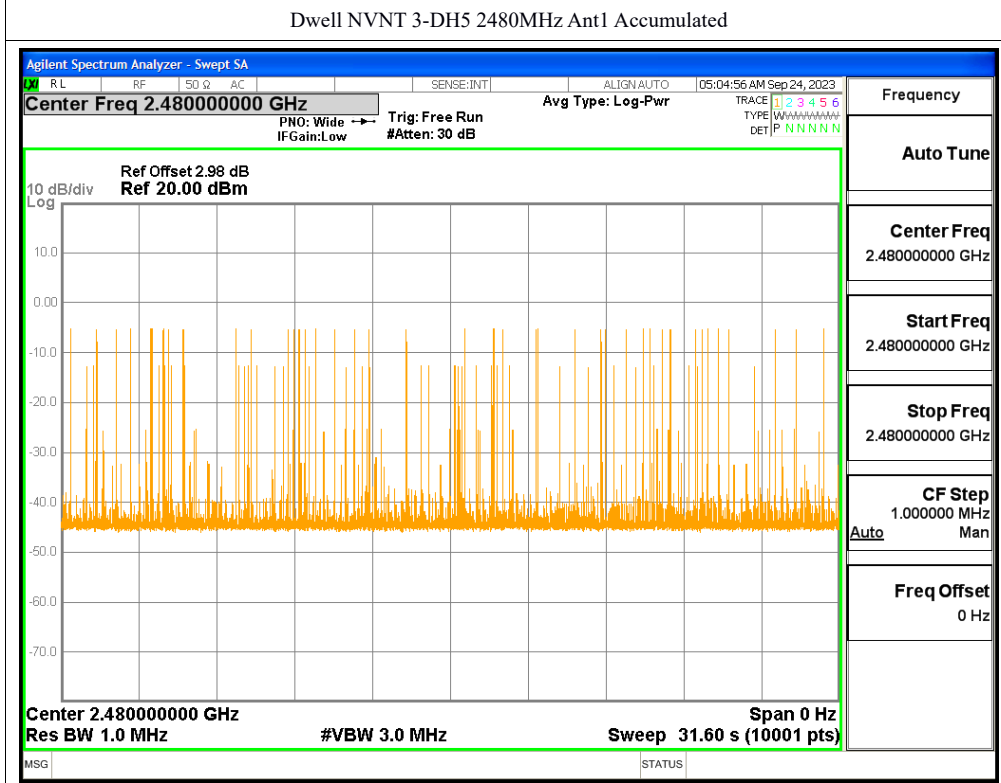
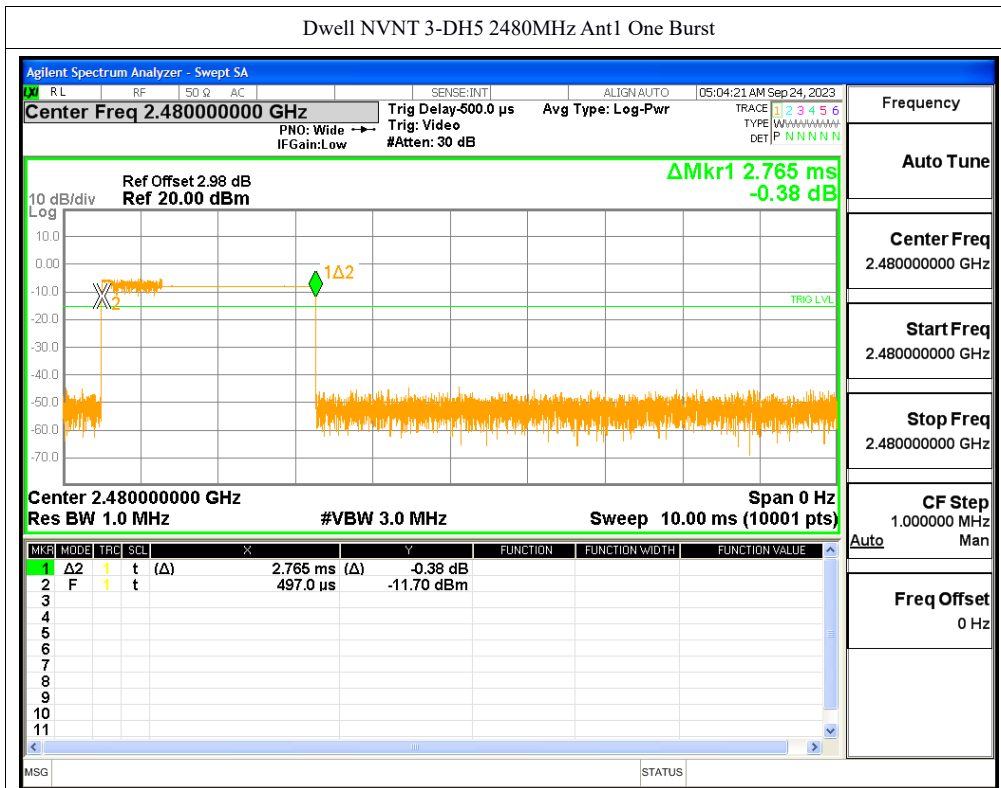

The report refers only to the sample tested and does not apply to the bulk.  
 This report is issued in confidence to the client and it will be strictly treated as such by the SHENZHEN TIMEWAY TESTING LABORATORIES. It may not be reproduced rather in its entirety or in part and it may not be used for advertising. The client to whom the report is issued may, however, show or send it, or a certified copy thereof, prepared by the SHENZHEN TIMEWAY TESTING LABORATORIES, to his customer. Supplier or others persons directly concerned. SHENZHEN TIMEWAY TESTING LABORATORIES, will not, without the consent of the client enter into any discussion of correspondence with any third party concerning the contents of the report.  
 In the event of the improper use of the report. The SHENZHEN TIMEWAY TESTING LABORATORIES, reserves the rights to withdraw it and to adopt any other remedies which may be appropriate.



## 12 Out of Band Measurement

### 12.1 Test Setup

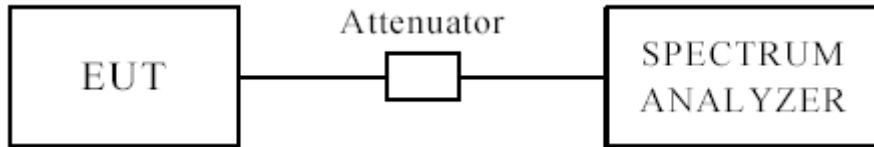

The restricted band requirement based on radiated emission test; please see the clause 6 for the test setup

### 12.2 Limits of Out of Band Emissions Measurement

1. Below  $-20\text{dB}$  of the highest emission level of operating band (in 100kHz Resolution Bandwidth).
2. Fall in the restricted bands listed in section 15.205. The maximum permitted average field strength is listed in section 15.209.

### 12.3 Test Procedure

For signals in the restricted bands above and below the 2.4-2.483GHz allocated band a measurement was made of radiated emission test. Peak values with  $\text{RBW}=\text{VBW}=1\text{MHz}$  and PK detector.

For bandage test, the spectrum set as follows:  $\text{RBW}=100\text{kHz}$ ,  $\text{VBW}=300\text{kHz}$ . A conducted measurement used

Note: 1. For band-edge measurement, the frequency from 30MHz-25GHz was tested. And It met the FCC rule.

The report refers only to the sample tested and does not apply to the bulk.

This report is issued in confidence to the client and it will be strictly treated as such by the SHENZHEN TIMEWAY TESTING LABORATORIES. It may not be reproduced rather in its entirety or in part and it may not be used for adverting. The client to whom the report is issued may, however, show or send it or a certified copy thereof prepared by the SHENZHEN TIMEWAY TESTING LABORATORIES to his customer. Supplier or others persons directly concerned. SHENZHEN TIMEWAY TESTING LABORATORIES will not, without the consent of the client enter into any discussion of correspondence with any third party concerning the contents of the report.

In the event of the improper use of the report. The SHENZHEN TIMEWAY TESTING LABORATORIES reserves the rights to withdraw it and to adopt any other remedies which may be appropriate.





**12.4 Band Edge Test Result**

Condition	Mode	Frequency (MHz)	Antenna	Hopping Mode	Max Value (dBc)	Limit (dBc)	Verdict
NVNT	1-DH5	2402	Ant1	No-Hopping	-38.52	-20	Pass
		2480		No-Hopping	-45.99	-20	Pass
	2-DH5	2402		No-Hopping	-27.18	-20	Pass
		2480		No-Hopping	-35.52	-20	Pass
	3-DH5	2402		No-Hopping	-34.99	-20	Pass
		2480		No-Hopping	-43.1	-20	Pass

The report refers only to the sample tested and does not apply to the bulk.

This report is issued in confidence to the client and it will be strictly treated as such by the SHENZHEN TIMEWAY TESTING LABORATORIES. It may not be reproduced rather in its entirety or in part and it may not be used for advertising. The client to whom the report is issued may, however, show or send it or a certified copy thereof prepared by the SHENZHEN TIMEWAY TESTING LABORATORIES to his customer. Supplier or others persons directly concerned. SHENZHEN TIMEWAY TESTING LABORATORIES will not, without the consent of the client enter into any discussion of correspondence with any third party concerning the contents of the report.

In the event of the improper use of the report. The SHENZHEN TIMEWAY TESTING LABORATORIES reserves the rights to withdraw it and to adopt any other remedies which may be appropriate.

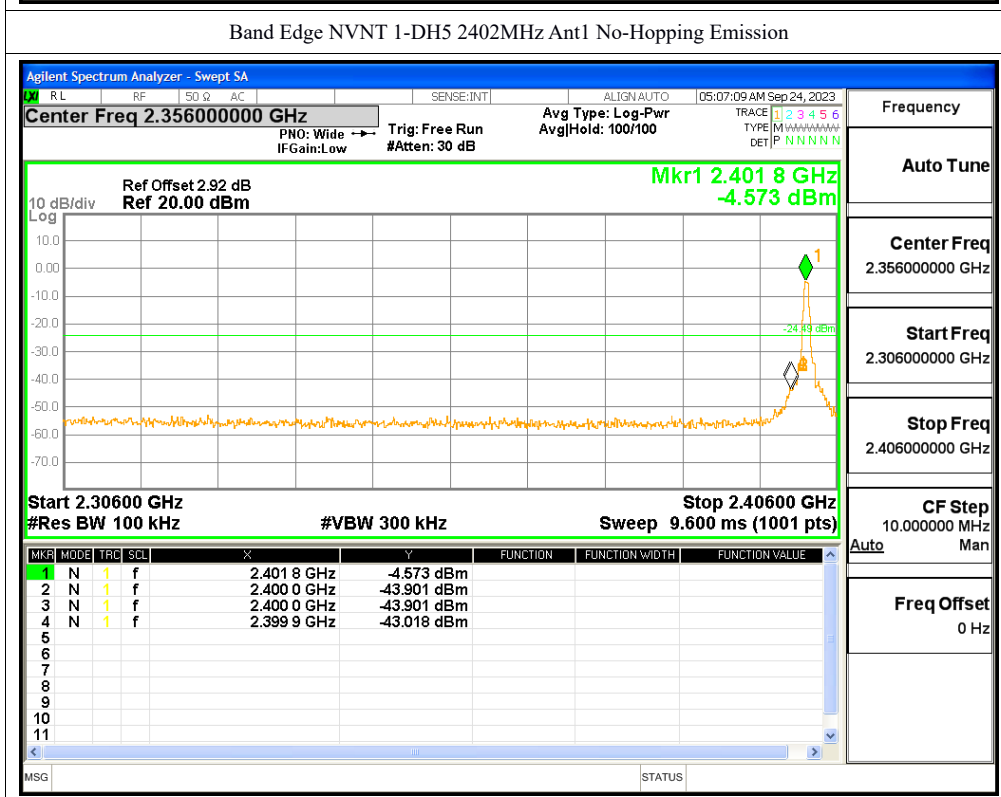
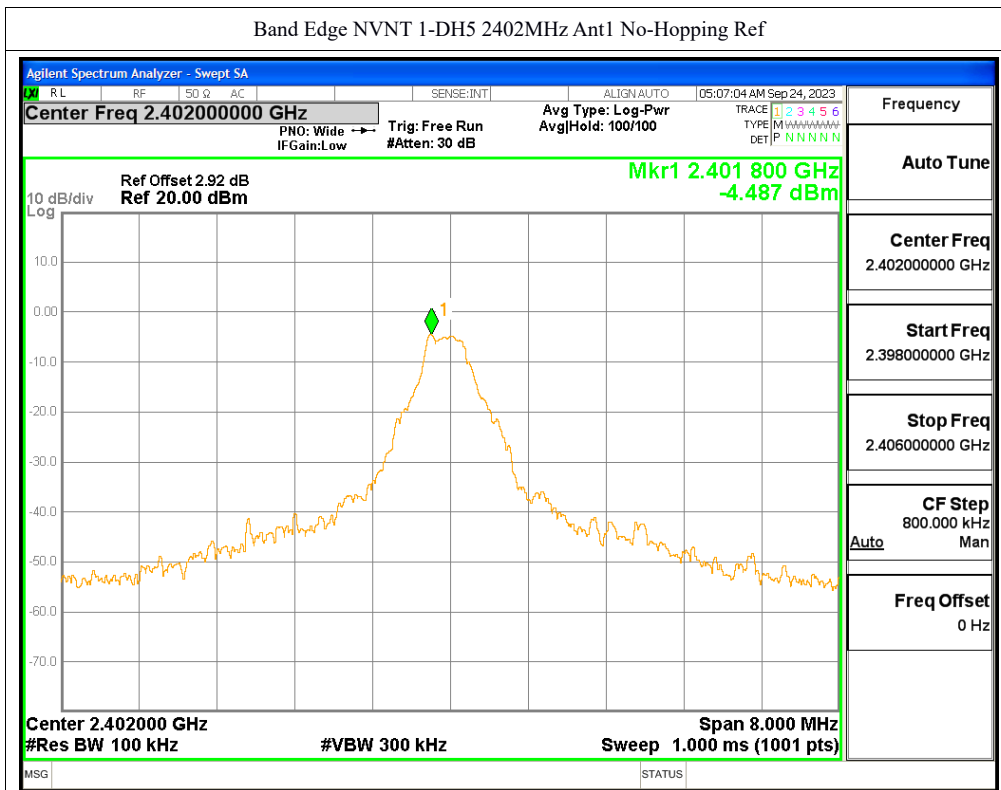

The report refers only to the sample tested and does not apply to the bulk. This report is issued in confidence to the client and it will be strictly treated as such by the SHENZHEN TIMEWAY TESTING LABORATORIES. It may not be reproduced rather in its entirety or in part and it may not be used for advertising. The client to whom the report is issued may, however, show or send it, or a certified copy thereof, to the SHENZHEN TIMEWAY TESTING LABORATORIES, to his customer. Supplier or others persons directly concerned. SHENZHEN TIMEWAY TESTING LABORATORIES, will not, without the consent of the client enter into any discussion of correspondence with any third party concerning the contents of the report. In the event of the improper use of the report. The SHENZHEN TIMEWAY TESTING LABORATORIES, reserves the rights to withdraw it and to adopt any other remedies which may be appropriate.

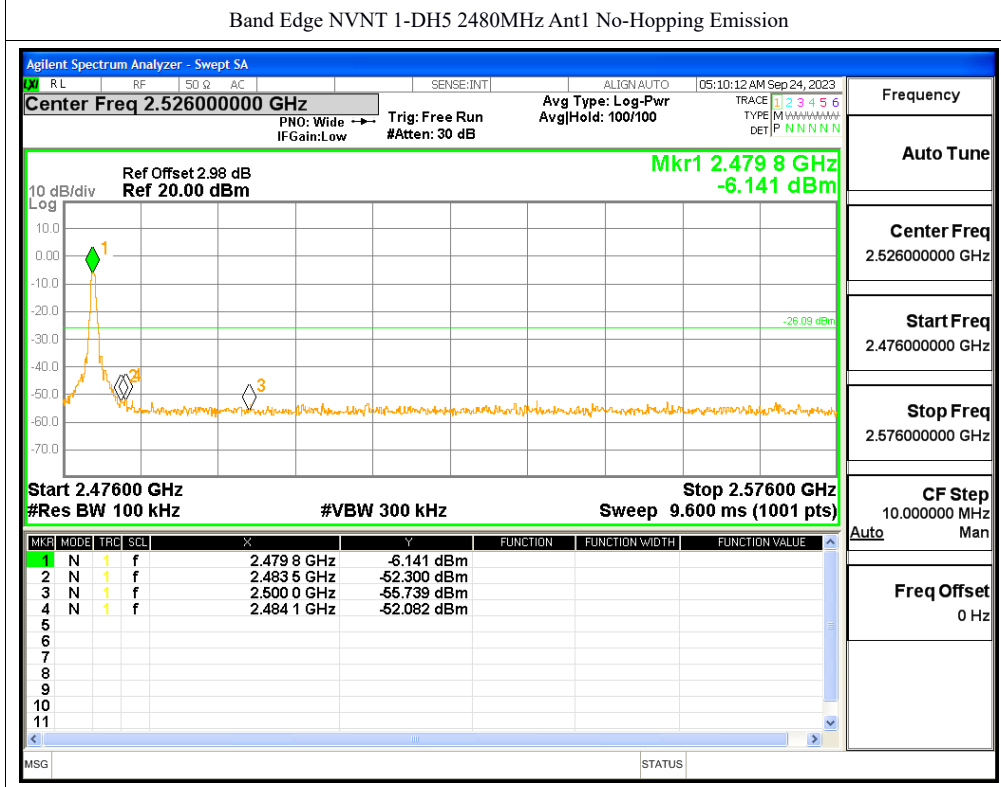
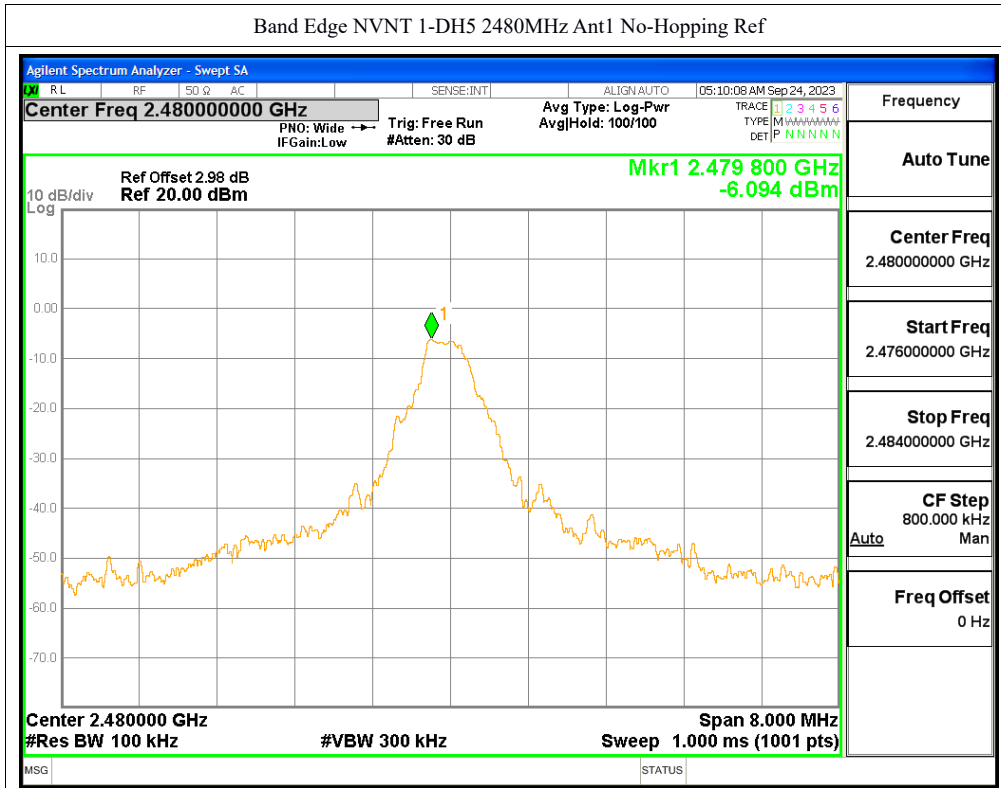

The report refers only to the sample tested and does not apply to the bulk.  
 This report is issued in confidence to the client and it will be strictly treated as such by the SHENZHEN TIMEWAY TESTING LABORATORIES. It may not be reproduced rather in its entirety or in part and it may not be used for advertising. The client to whom the report is issued may, however, show or send it, or a certified copy thereof prepared by the SHENZHEN TIMEWAY TESTING LABORATORIES, to his customer. Supplier or others persons directly concerned. SHENZHEN TIMEWAY TESTING LABORATORIES, will not, without the consent of the client enter into any discussion of correspondence with any third party concerning the contents of the report.  
 In the event of the improper use of the report. The SHENZHEN TIMEWAY TESTING LABORATORIES, reserves the rights to withdraw it and to adopt any other remedies which may be appropriate.

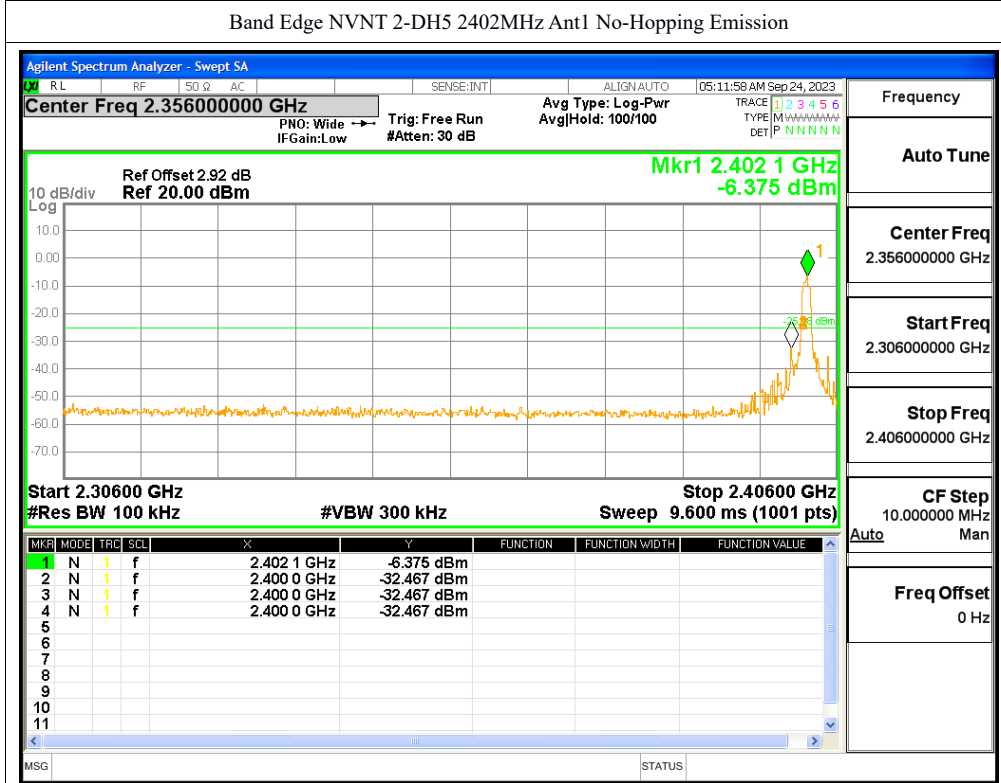
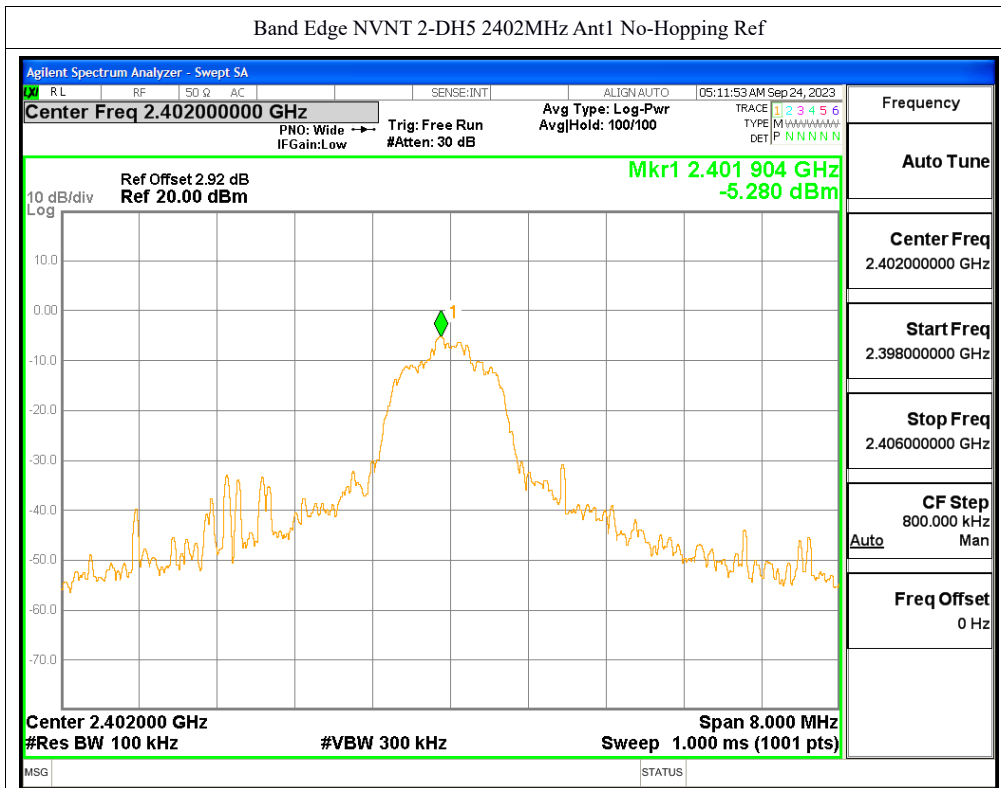

The report refers only to the sample tested and does not apply to the bulk. This report is issued in confidence to the client and it will be strictly treated as such by the SHENZHEN TIMEWAY TESTING LABORATORIES. It may not be reproduced rather in its entirety or in part and it may not be used for advertising. The client to whom the report is issued may, however, show or send it, or a certified copy thereof prepared by the SHENZHEN TIMEWAY TESTING LABORATORIES, to his customer. Supplier or others persons directly concerned. SHENZHEN TIMEWAY TESTING LABORATORIES, will not, without the consent of the client enter into any discussion of correspondence with any third party concerning the contents of the report. In the event of the improper use of the report. The SHENZHEN TIMEWAY TESTING LABORATORIES, reserves the rights to withdraw it and to adopt any other remedies which may be appropriate.

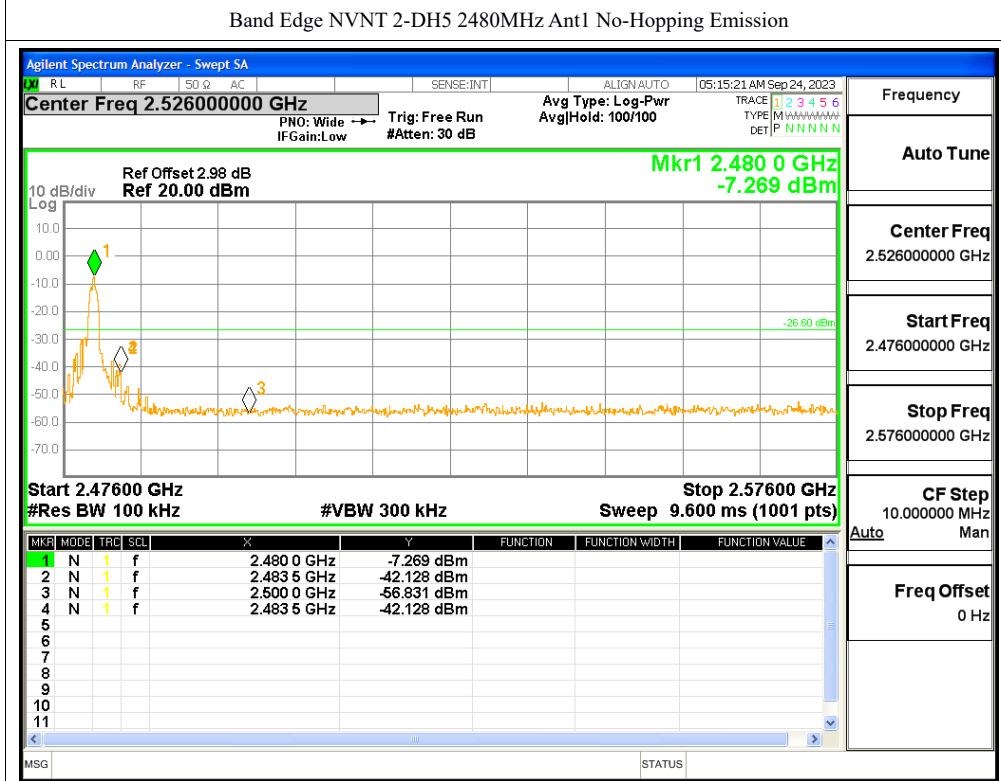
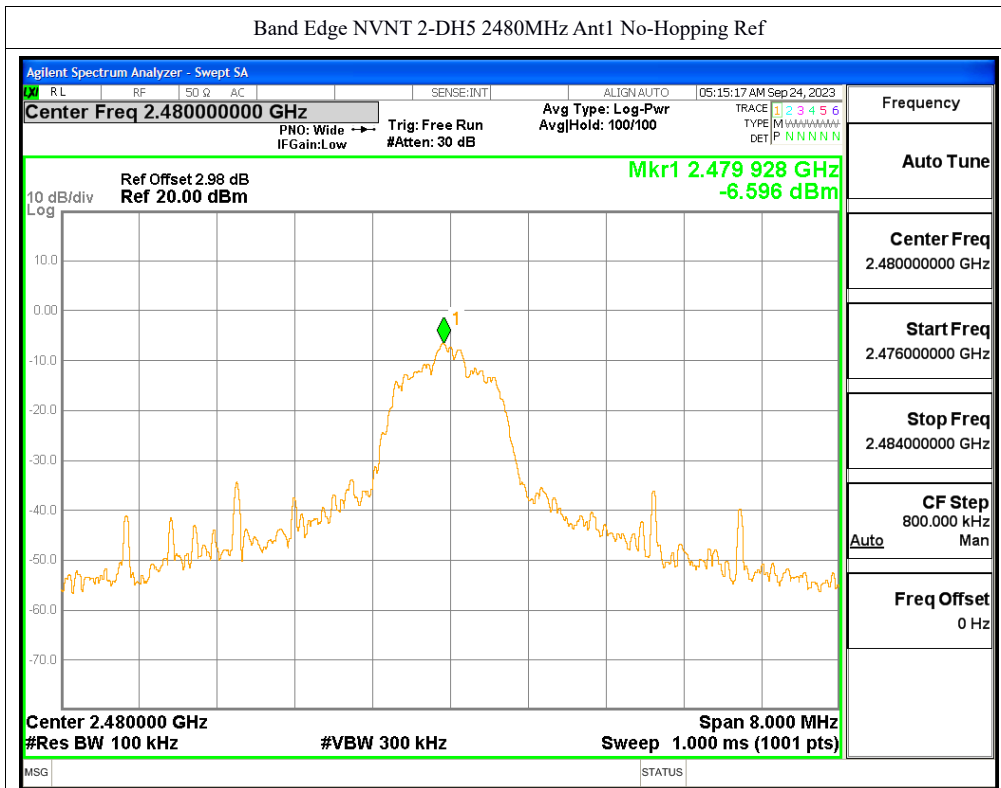

The report refers only to the sample tested and does not apply to the bulk.  
 This report is issued in confidence to the client and it will be strictly treated as such by the SHENZHEN TIMEWAY TESTING LABORATORIES. It may not be reproduced rather in its entirety or in part and it may not be used for advertising. The client to whom the report is issued may, however, show or send it, or a certified copy thereof prepared by the SHENZHEN TIMEWAY TESTING LABORATORIES, to his customer. Supplier or others persons directly concerned. SHENZHEN TIMEWAY TESTING LABORATORIES, will not, without the consent of the client enter into any discussion of correspondence with any third party concerning the contents of the report.  
 In the event of the improper use of the report. The SHENZHEN TIMEWAY TESTING LABORATORIES, reserves the rights to withdraw it and to adopt any other remedies which may be appropriate.

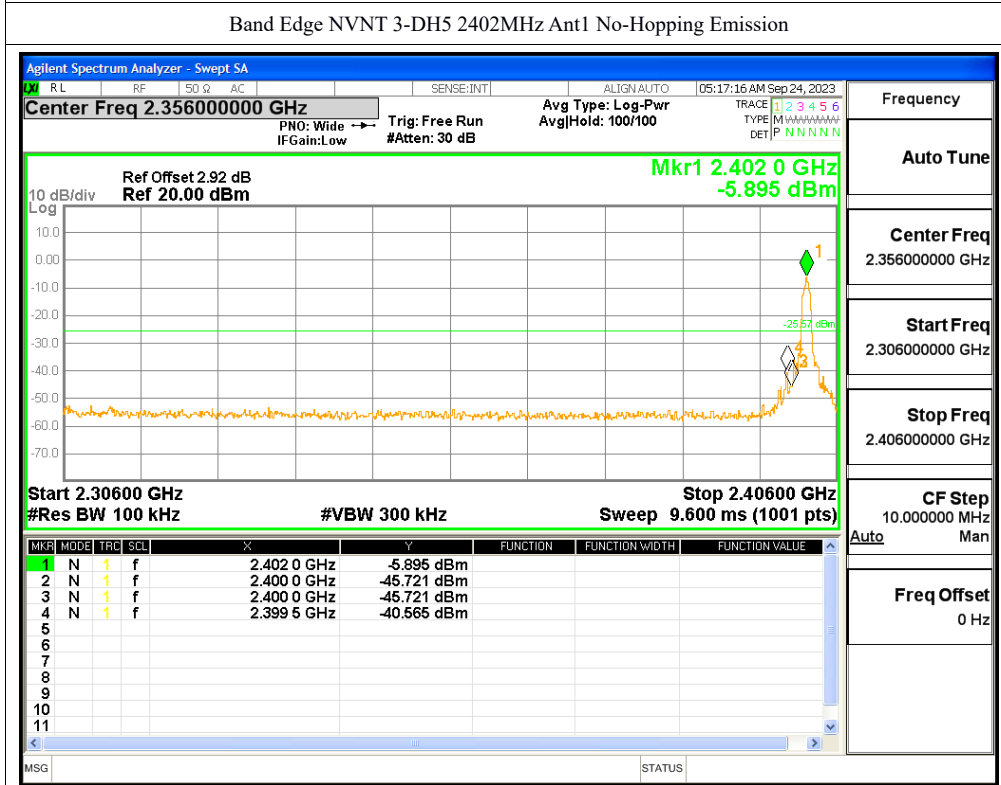
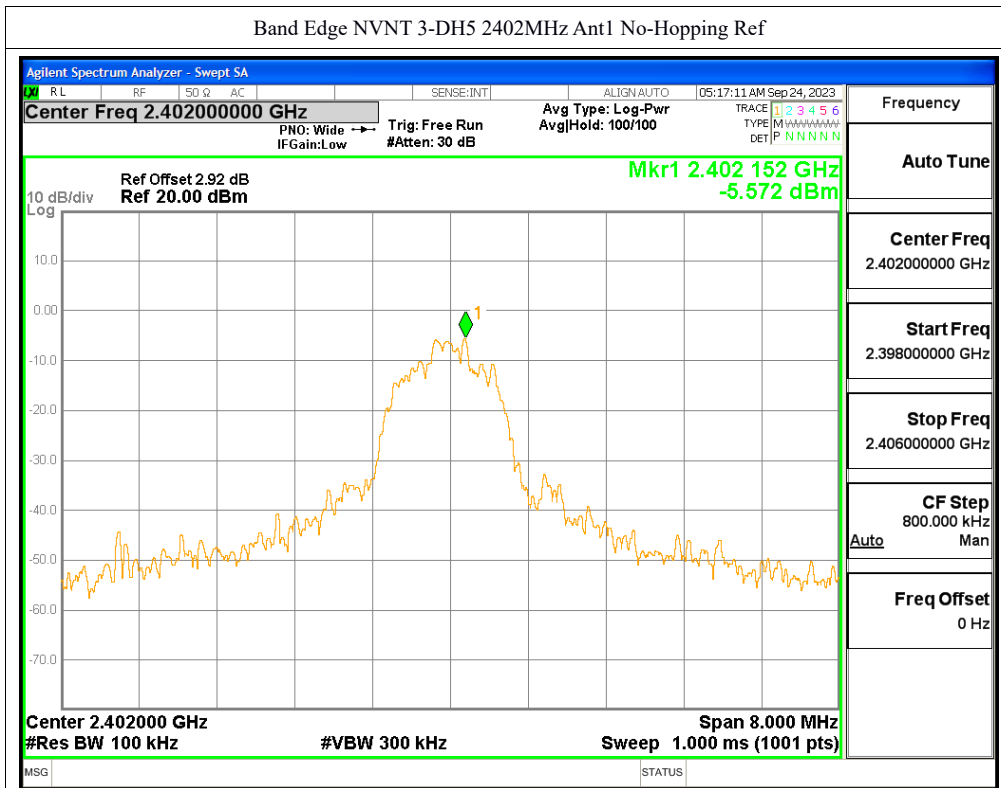

The report refers only to the sample tested and does not apply to the bulk.  
 This report is issued in confidence to the client and it will be strictly treated as such by the SHENZHEN TIMEWAY TESTING LABORATORIES. It may not be reproduced rather in its entirety or in part and it may not be used for advertising. The client to whom the report is issued may, however, show or send it, or a certified copy thereof prepared by the SHENZHEN TIMEWAY TESTING LABORATORIES, to his customer. Supplier or others persons directly concerned. SHENZHEN TIMEWAY TESTING LABORATORIES, will not, without the consent of the client enter into any discussion of correspondence with any third party concerning the contents of the report.  
 In the event of the improper use of the report. The SHENZHEN TIMEWAY TESTING LABORATORIES, reserves the rights to withdraw it and to adopt any other remedies which may be appropriate.

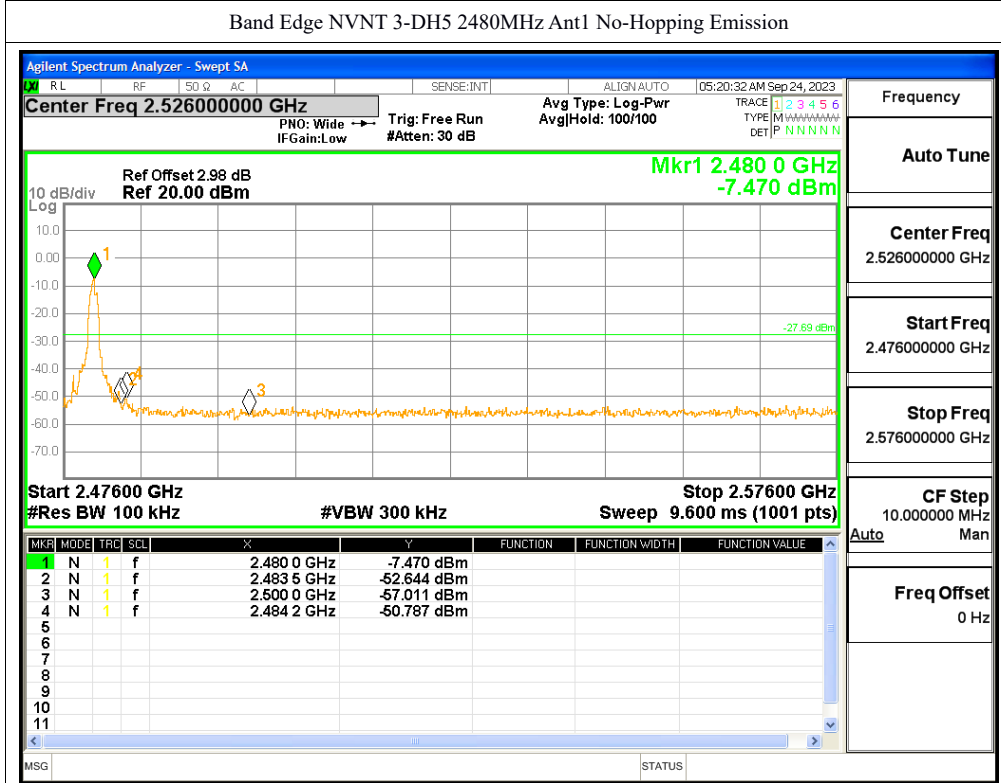
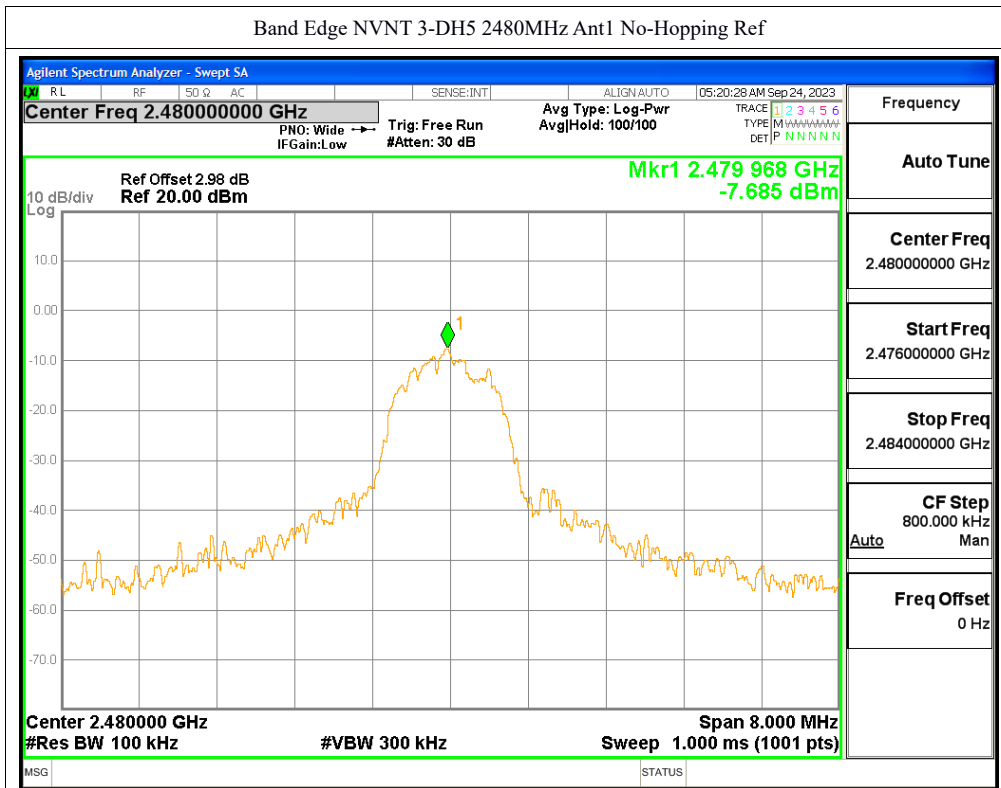

The report refers only to the sample tested and does not apply to the bulk.  
 This report is issued in confidence to the client and it will be strictly treated as such by the SHENZHEN TIMEWAY TESTING LABORATORIES. It may not be reproduced rather in its entirety or in part and it may not be used for advertising. The client to whom the report is issued may, however, show or send it, or a certified copy thereof prepared by the SHENZHEN TIMEWAY TESTING LABORATORIES, to his customer. Supplier or others persons directly concerned. SHENZHEN TIMEWAY TESTING LABORATORIES, will not, without the consent of the client enter into any discussion of correspondence with any third party concerning the contents of the report.  
 In the event of the improper use of the report. The SHENZHEN TIMEWAY TESTING LABORATORIES, reserves the rights to withdraw it and to adopt any other remedies which may be appropriate.



Condition	Mode	Frequency (MHz)	Antenna	Hopping Mode	Max Value (dBc)	Limit (dBc)	Verdict
NVNT	1-DH5	2402	Ant1	Hopping	-37.46	-20	Pass
		2480		Hopping	-45.76	-20	Pass
	2-DH5	2402		Hopping	-37.59	-20	Pass
		2480		Hopping	-43.95	-20	Pass
	3-DH5	2402		Hopping	-40.71	-20	Pass
		2480		Hopping	-44.81	-20	Pass

The report refers only to the sample tested and does not apply to the bulk.

This report is issued in confidence to the client and it will be strictly treated as such by the SHENZHEN TIMEWAY TESTING LABORATORIES. It may not be reproduced rather in its entirety or in part and it may not be used for advertising. The client to whom the report is issued may, however, show or send it or a certified copy thereof prepared by the SHENZHEN TIMEWAY TESTING LABORATORIES to his customer. Supplier or others persons directly concerned. SHENZHEN TIMEWAY TESTING LABORATORIES will not, without the consent of the client enter into any discussion of correspondence with any third party concerning the contents of the report.

In the event of the improper use of the report. The SHENZHEN TIMEWAY TESTING LABORATORIES reserves the rights to withdraw it and to adopt any other remedies which may be appropriate.



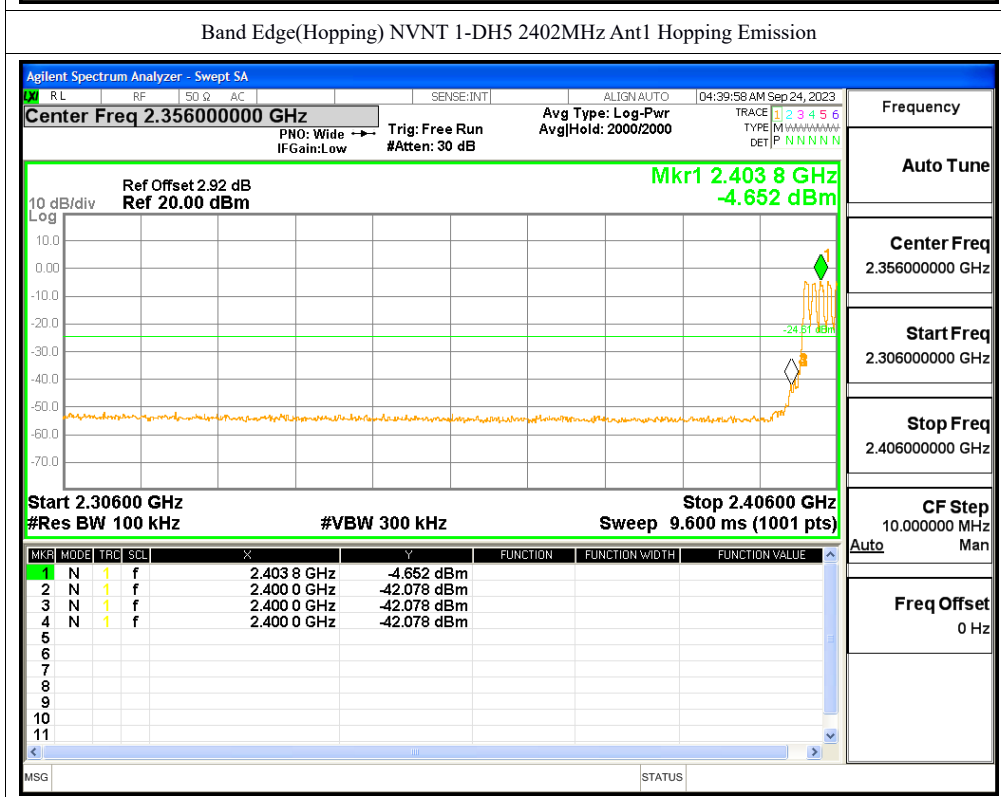
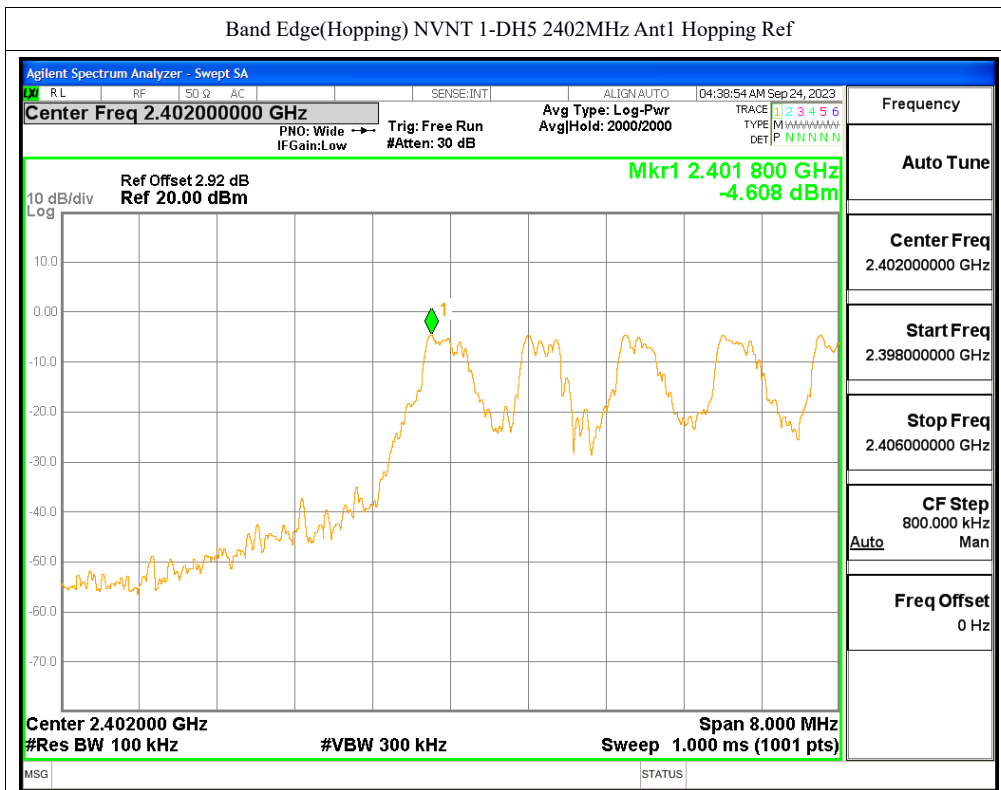

The report refers only to the sample tested and does not apply to the bulk.  
 This report is issued in confidence to the client and it will be strictly treated as such by the SHENZHEN TIMEWAY TESTING LABORATORIES. It may not be reproduced rather in its entirety or in part and it may not be used for advertising. The client to whom the report is issued may, however, show or send it, or a certified copy thereof prepared by the SHENZHEN TIMEWAY TESTING LABORATORIES, to his customer. Supplier or others persons directly concerned. SHENZHEN TIMEWAY TESTING LABORATORIES, will not, without the consent of the client enter into any discussion of correspondence with any third party concerning the contents of the report.  
 In the event of the improper use of the report. The SHENZHEN TIMEWAY TESTING LABORATORIES, reserves the rights to withdraw it and to adopt any other remedies which may be appropriate.

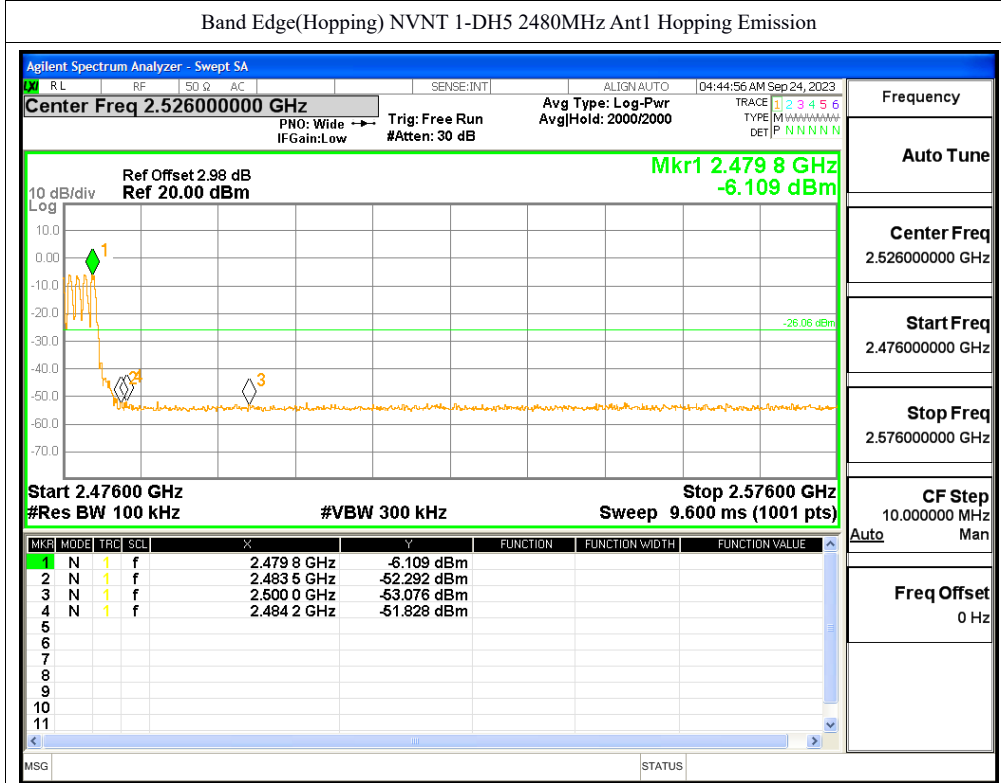
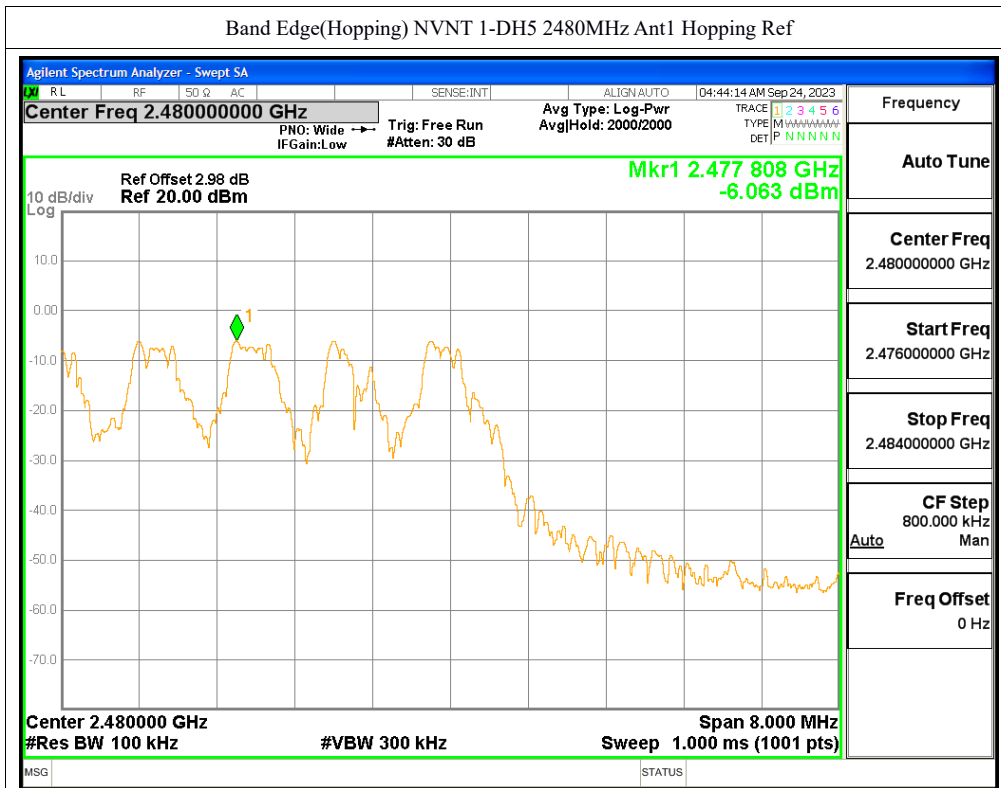

The report refers only to the sample tested and does not apply to the bulk.  
 This report is issued in confidence to the client and it will be strictly treated as such by the SHENZHEN TIMEWAY TESTING LABORATORIES. It may not be reproduced rather in its entirety or in part and it may not be used for advertising. The client to whom the report is issued may, however, show or send it, or a certified copy thereof prepared by the SHENZHEN TIMEWAY TESTING LABORATORIES, to his customer. Supplier or others persons directly concerned. SHENZHEN TIMEWAY TESTING LABORATORIES, will not, without the consent of the client enter into any discussion of correspondence with any third party concerning the contents of the report.  
 In the event of the improper use of the report. The SHENZHEN TIMEWAY TESTING LABORATORIES, reserves the rights to withdraw it and to adopt any other remedies which may be appropriate.

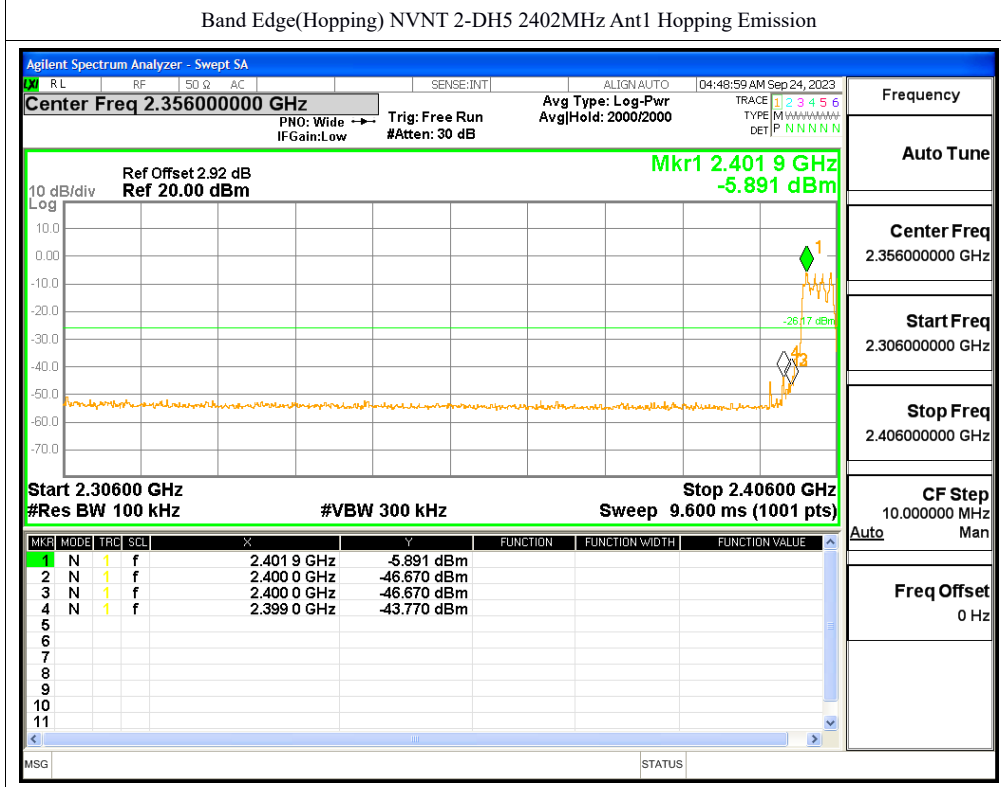
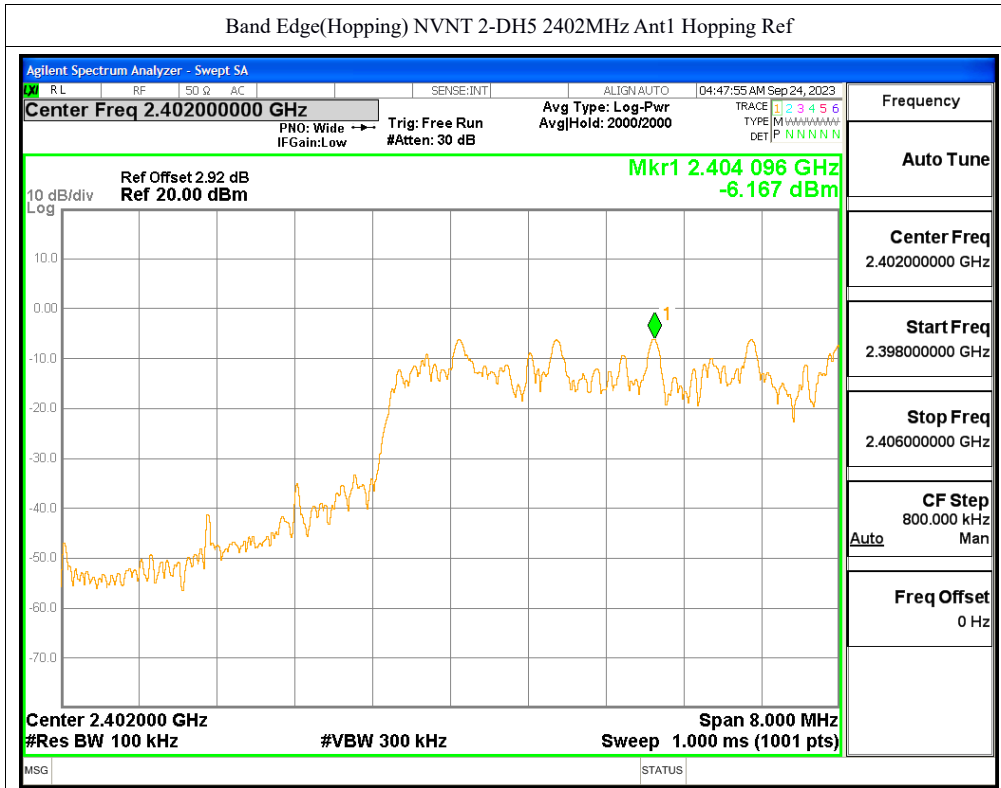

The report refers only to the sample tested and does not apply to the bulk.

This report is issued in confidence to the client and it will be strictly treated as such by the SHENZHEN TIMEWAY TESTING LABORATORIES. It may not be reproduced rather in its entirety or in part and it may not be used for advertising. The client to whom the report is issued may, however, show or send it, or a certified copy thereof prepared by the SHENZHEN TIMEWAY TESTING LABORATORIES, to his customer. Supplier or others persons directly concerned. SHENZHEN TIMEWAY TESTING LABORATORIES, will not, without the consent of the client enter into any discussion of correspondence with any third party concerning the contents of the report. In the event of the improper use of the report. The SHENZHEN TIMEWAY TESTING LABORATORIES, reserves the rights to withdraw it and to adopt any other remedies which may be appropriate.

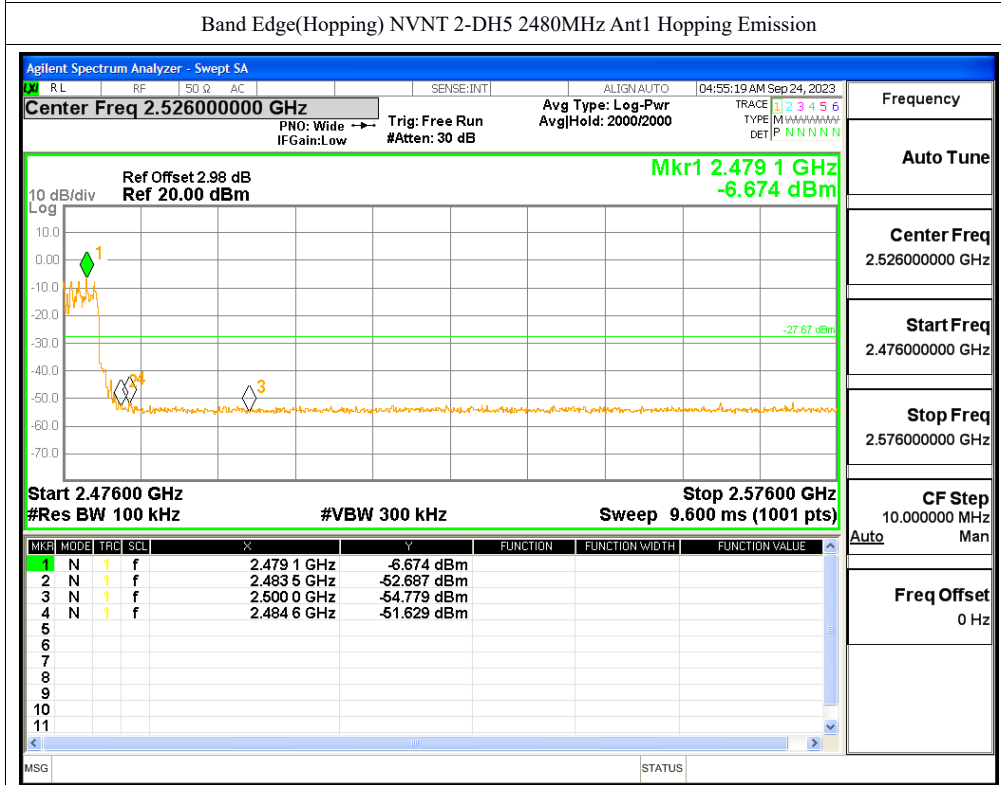
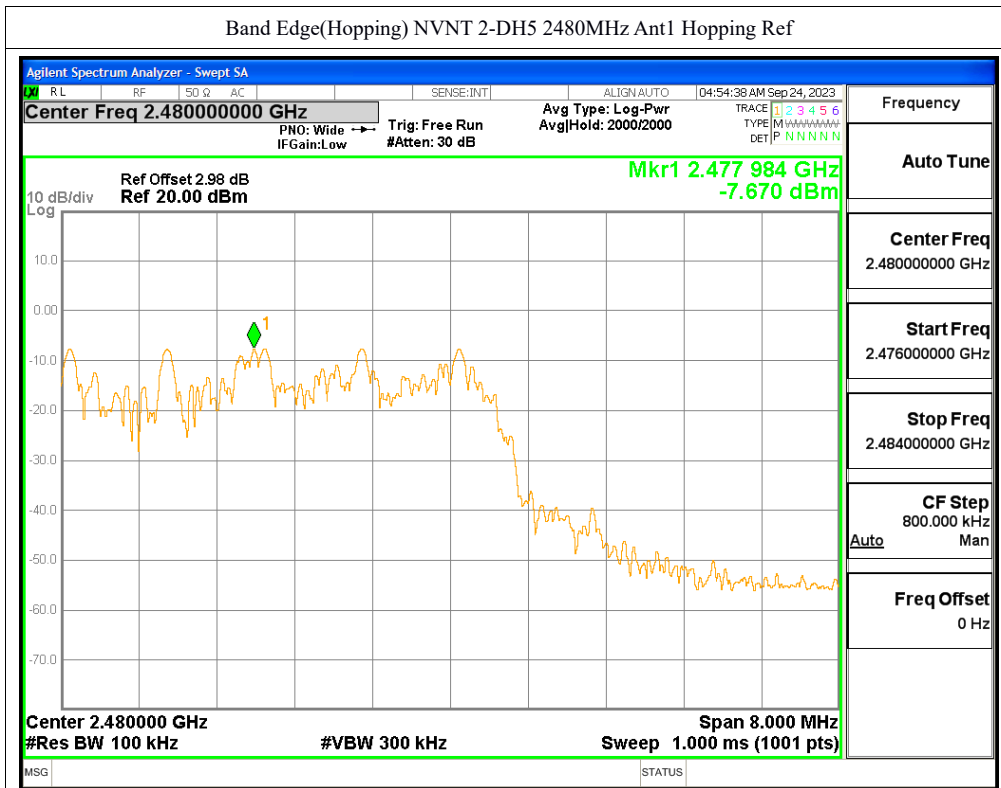

The report refers only to the sample tested and does not apply to the bulk.  
 This report is issued in confidence to the client and it will be strictly treated as such by the SHENZHEN TIMEWAY TESTING LABORATORIES. It may not be reproduced rather in its entirety or in part and it may not be used for advertising. The client to whom the report is issued may, however, show or send it, or a certified copy thereof prepared by the SHENZHEN TIMEWAY TESTING LABORATORIES, to his customer. Supplier or others persons directly concerned. SHENZHEN TIMEWAY TESTING LABORATORIES, will not, without the consent of the client enter into any discussion of correspondence with any third party concerning the contents of the report.  
 In the event of the improper use of the report. The SHENZHEN TIMEWAY TESTING LABORATORIES, reserves the rights to withdraw it and to adopt any other remedies which may be appropriate.

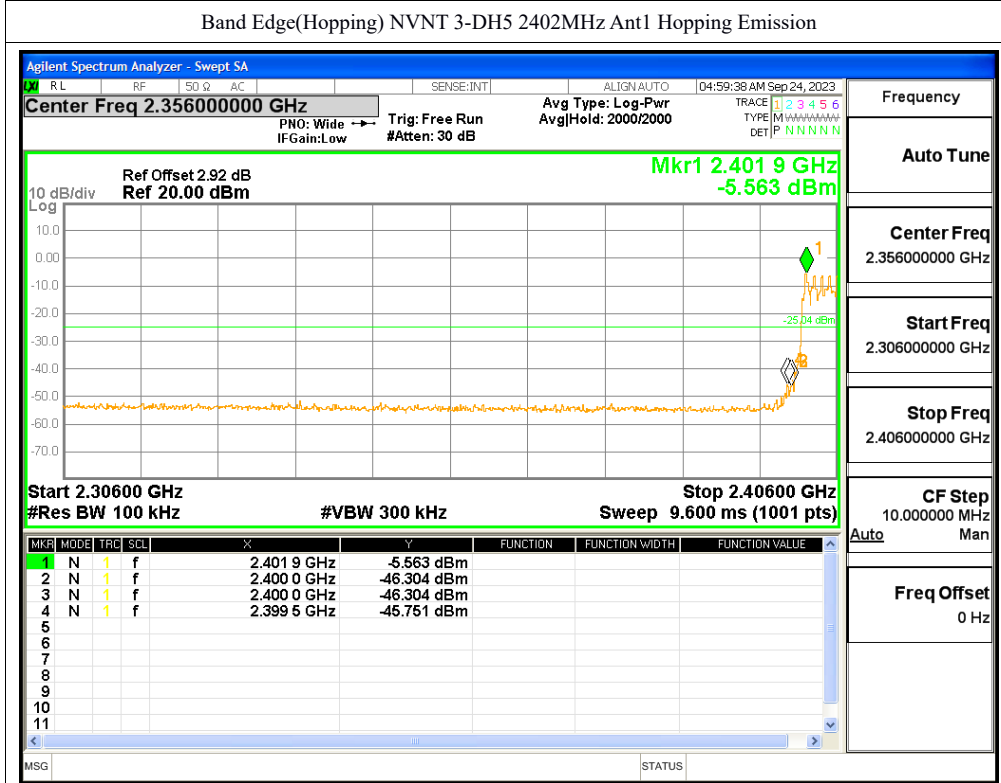
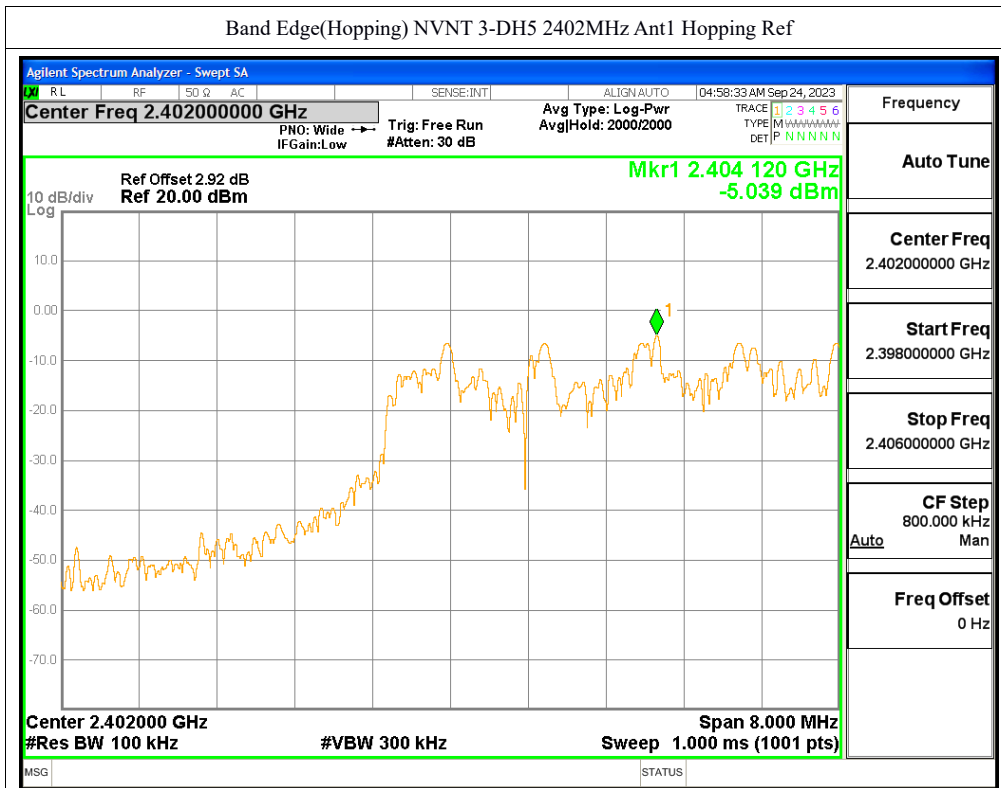

The report refers only to the sample tested and does not apply to the bulk.  
 This report is issued in confidence to the client and it will be strictly treated as such by the SHENZHEN TIMEWAY TESTING LABORATORIES. It may not be reproduced rather in its entirety or in part and it may not be used for advertising. The client to whom the report is issued may, however, show or send it, or a certified copy thereof prepared by the SHENZHEN TIMEWAY TESTING LABORATORIES, to his customer. Supplier or others persons directly concerned. SHENZHEN TIMEWAY TESTING LABORATORIES, will not, without the consent of the client enter into any discussion of correspondence with any third party concerning the contents of the report.  
 In the event of the improper use of the report. The SHENZHEN TIMEWAY TESTING LABORATORIES, reserves the rights to withdraw it and to adopt any other remedies which may be appropriate.

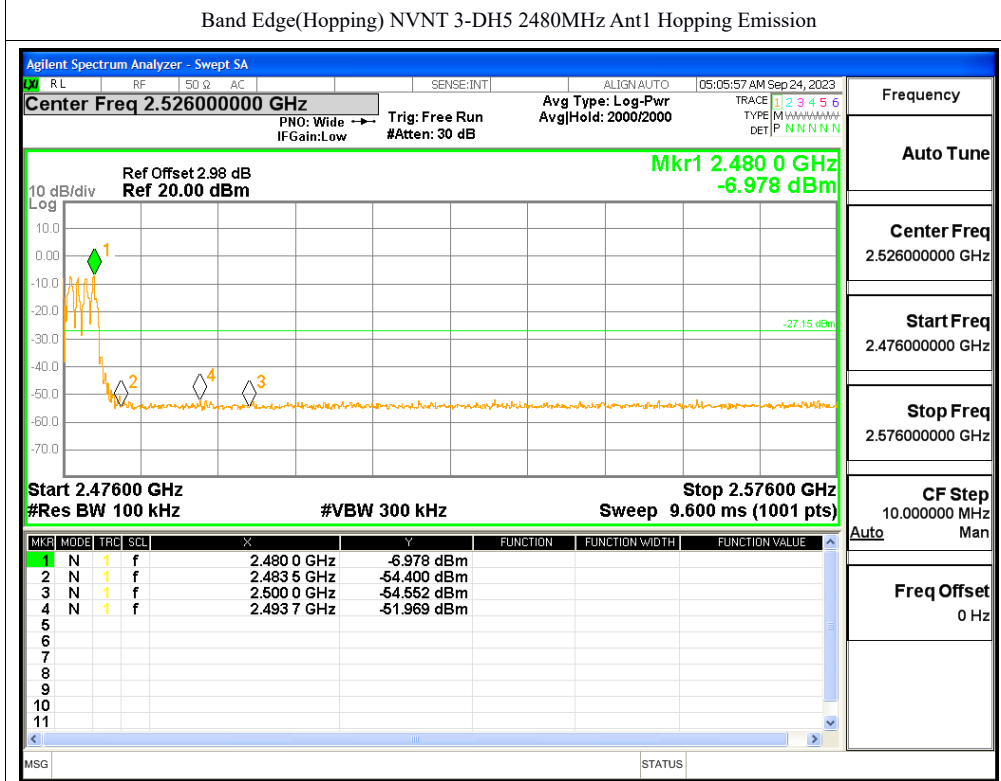
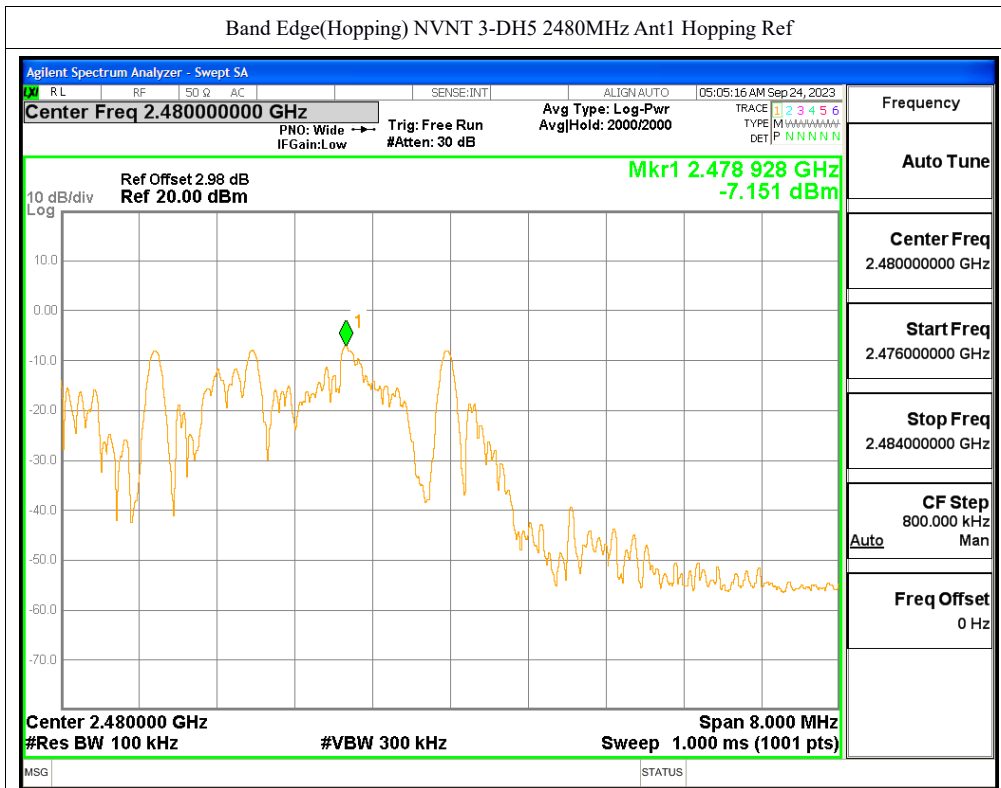

The report refers only to the sample tested and does not apply to the bulk.  
 This report is issued in confidence to the client and it will be strictly treated as such by the SHENZHEN TIMEWAY TESTING LABORATORIES. It may not be reproduced rather in its entirety or in part and it may not be used for advertising. The client to whom the report is issued may, however, show or send it, or a certified copy thereof prepared by the SHENZHEN TIMEWAY TESTING LABORATORIES, to his customer. Supplier or others persons directly concerned. SHENZHEN TIMEWAY TESTING LABORATORIES, will not, without the consent of the client enter into any discussion of correspondence with any third party concerning the contents of the report.  
 In the event of the improper use of the report. The SHENZHEN TIMEWAY TESTING LABORATORIES, reserves the rights to withdraw it and to adopt any other remedies which may be appropriate.



**Conducted Emissions at antenna port**

Condition	Mode	Frequency (MHz)	Antenna	Max Value (dBc)	Limit (dBc)	Verdict
NVNT	1-DH5	2402	Ant1	-32.87	-20	Pass
		2441		-33.01	-20	Pass
		2480		-30.98	-20	Pass
	2-DH5	2402		-32.93	-20	Pass
		2441		-32.07	-20	Pass
		2480		-30.12	-20	Pass
	3-DH5	2402		-33.22	-20	Pass
		2441		-31.99	-20	Pass
		2480		-30.31	-20	Pass

The report refers only to the sample tested and does not apply to the bulk.

This report is issued in confidence to the client and it will be strictly treated as such by the SHENZHEN TIMEWAY TESTING LABORATORIES. It may not be reproduced rather in its entirety or in part and it may not be used for advertising. The client to whom the report is issued may, however, show or send it . or a certified copy there of prepared by the SHENZHEN TIMEWAY TESTING LABORATORIES. to his customer. Supplier or others persons directly concerned. SHENZHEN TIMEWAY TESTING LABORATORIES. will not, without the consent of the client enter into any discussion of correspondence with any third party concerning the contents of the report.

In the event of the improper use of the report. The SHENZHEN TIMEWAY TESTING LABORATORIES. reserves the rights to withdraw it and to adopt any other remedies which may be appropriate.

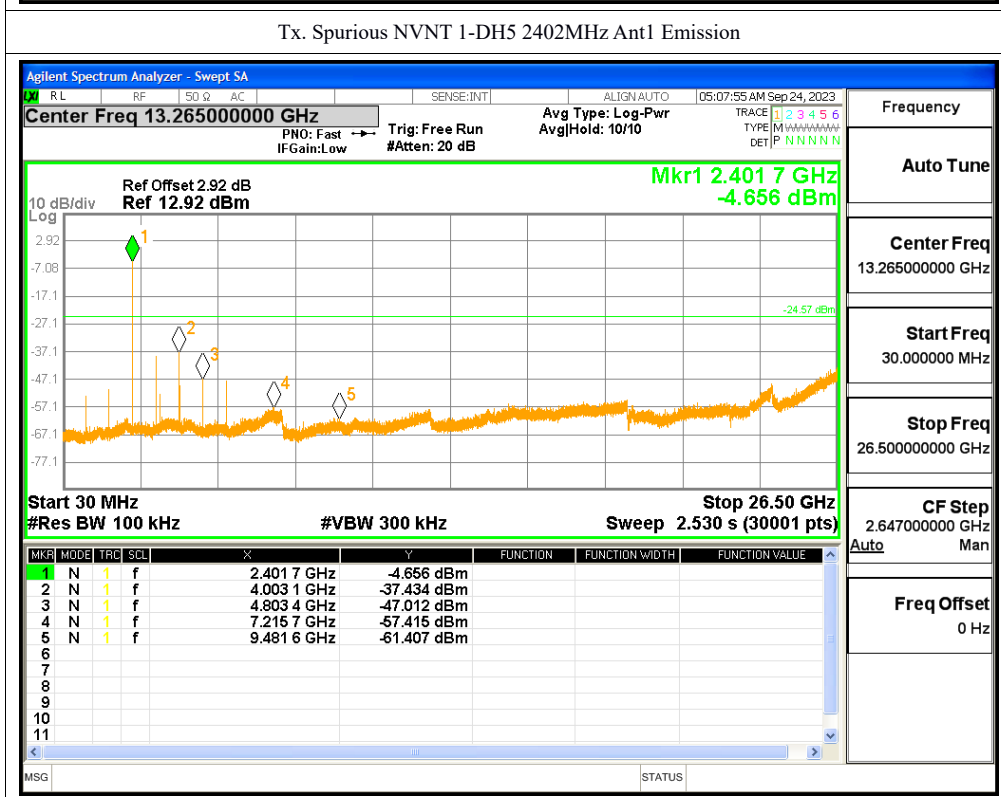
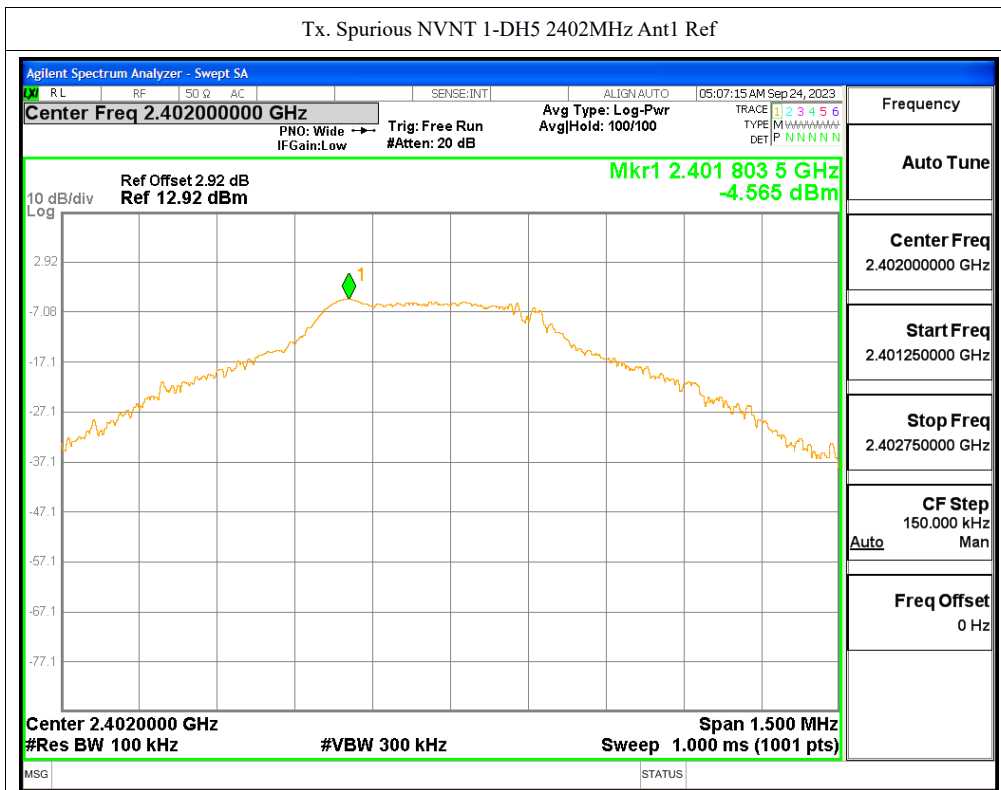

The report refers only to the sample tested and does not apply to the bulk.

This report is issued in confidence to the client and it will be strictly treated as such by the SHENZHEN TIMEWAY TESTING LABORATORIES. It may not be reproduced in its entirety or in part and it may not be used for advertising. The client to whom the report is issued may, however, show or send it, or a certified copy thereof, to the SHENZHEN TIMEWAY TESTING LABORATORIES, to his customer, Supplier or others persons directly concerned. SHENZHEN TIMEWAY TESTING LABORATORIES, will not, without the consent of the client enter into any discussion of correspondence with any third party concerning the contents of the report.

In the event of the improper use of the report, the SHENZHEN TIMEWAY TESTING LABORATORIES, reserves the rights to withdraw it and to adopt any other remedies which may be appropriate.



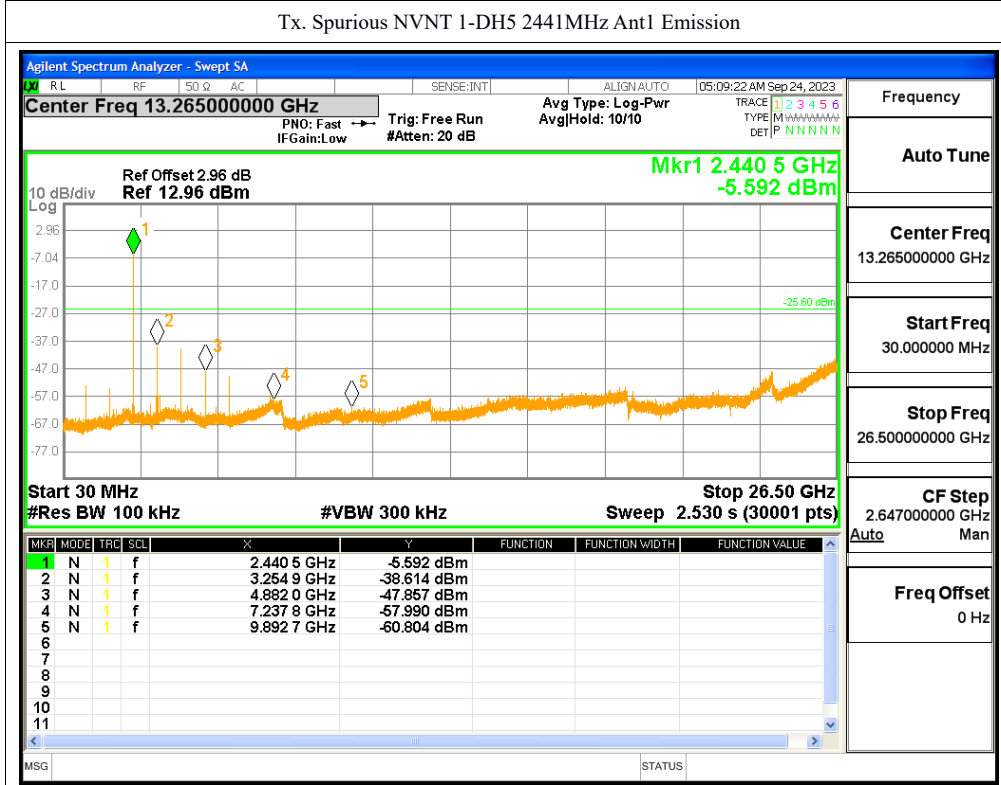
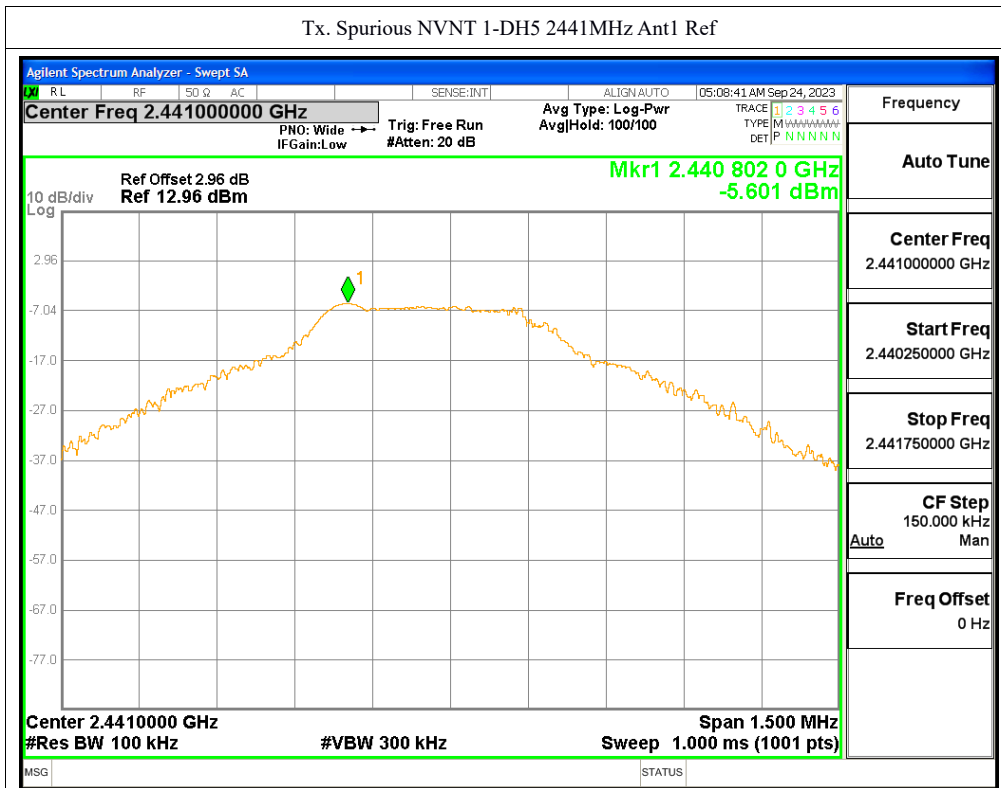

The report refers only to the sample tested and does not apply to the bulk.

This report is issued in confidence to the client and it will be strictly treated as such by the SHENZHEN TIMEWAY TESTING LABORATORIES. It may not be reproduced rather in its entirety or in part and it may not be used for advertising. The client to whom the report is issued may, however, show or send it, or a certified copy thereof prepared by the SHENZHEN TIMEWAY TESTING LABORATORIES, to his customer. Supplier or others persons directly concerned. SHENZHEN TIMEWAY TESTING LABORATORIES, will not, without the consent of the client enter into any discussion of correspondence with any third party concerning the contents of the report.

In the event of the improper use of the report. The SHENZHEN TIMEWAY TESTING LABORATORIES, reserves the rights to withdraw it and to adopt any other remedies which may be appropriate.

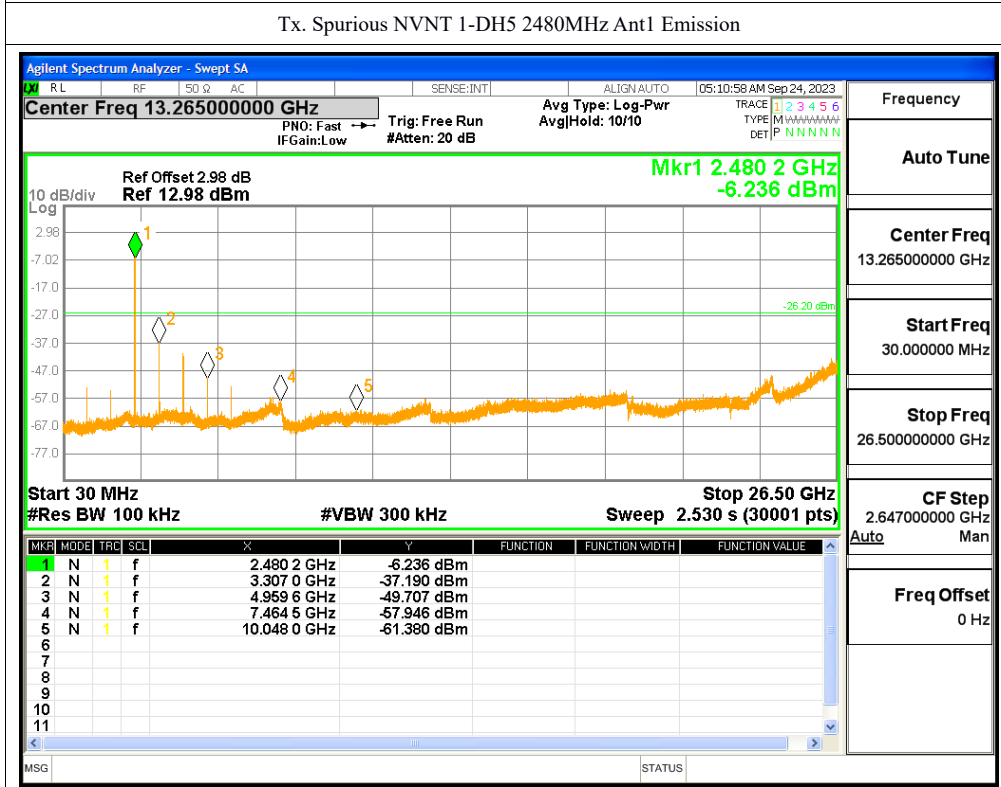
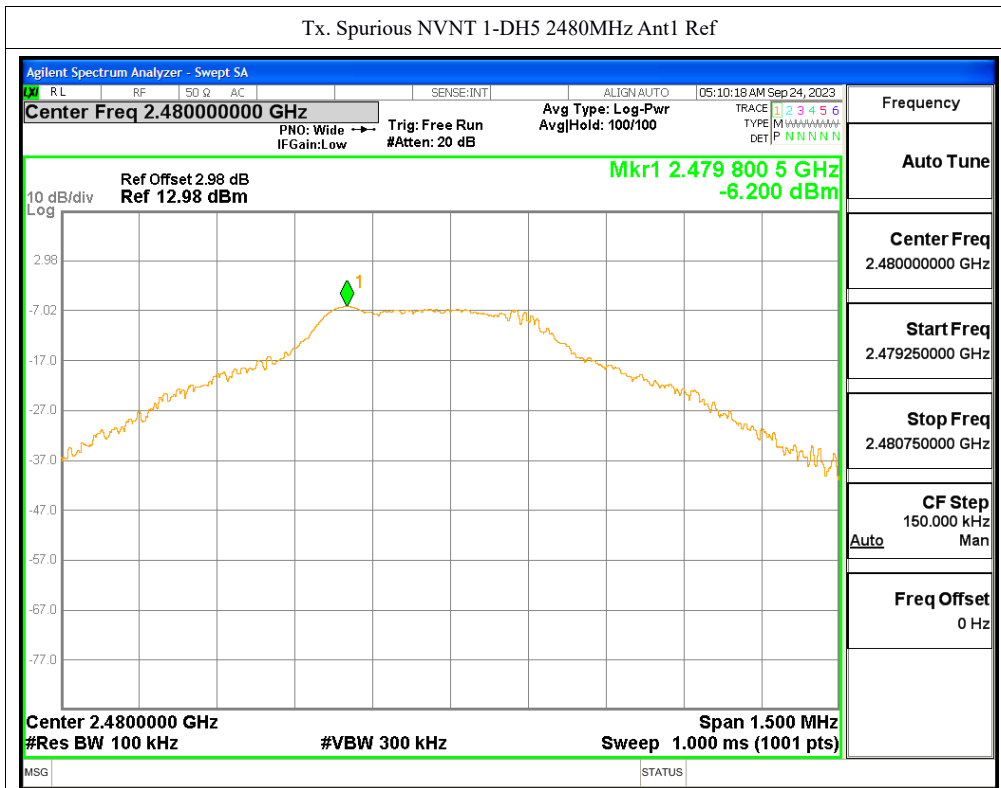

The report refers only to the sample tested and does not apply to the bulk.

This report is issued in confidence to the client and it will be strictly treated as such by the SHENZHEN TIMEWAY TESTING LABORATORIES. It may not be reproduced rather in its entirety or in part and it may not be used for advertising. The client to whom the report is issued may, however, show or send it, or a certified copy thereof prepared by the SHENZHEN TIMEWAY TESTING LABORATORIES, to his customer. Supplier or others persons directly concerned. SHENZHEN TIMEWAY TESTING LABORATORIES, will not, without the consent of the client enter into any discussion of correspondence with any third party concerning the contents of the report.

In the event of the improper use of the report. The SHENZHEN TIMEWAY TESTING LABORATORIES, reserves the rights to withdraw it and to adopt any other remedies which may be appropriate.

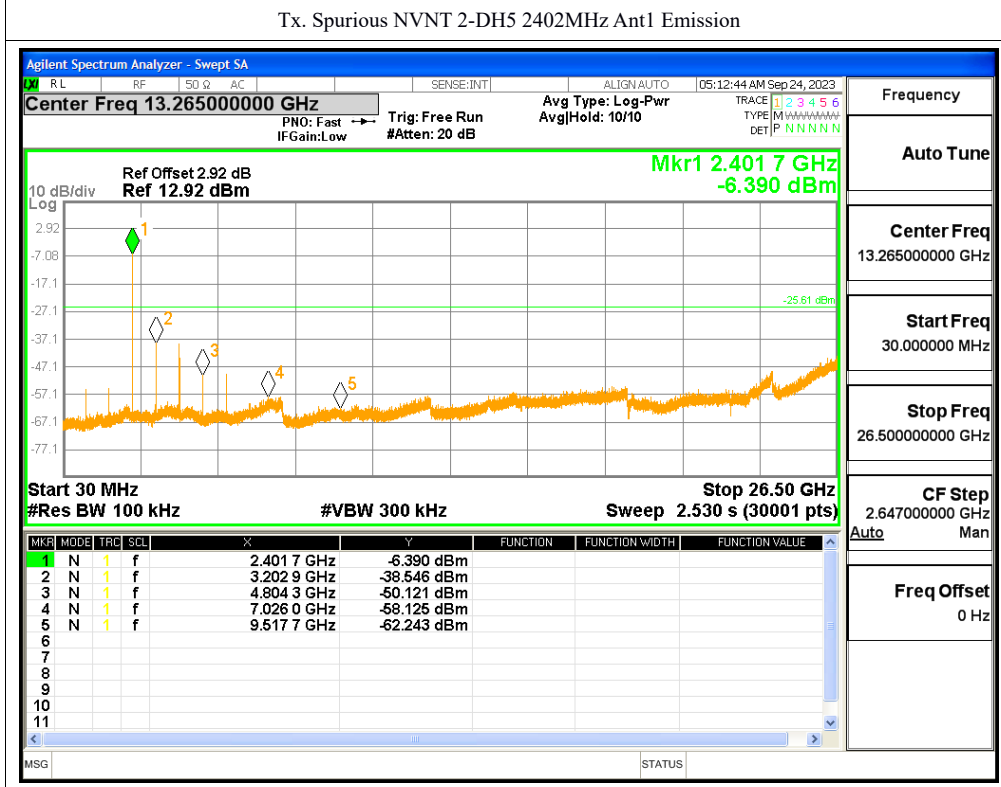
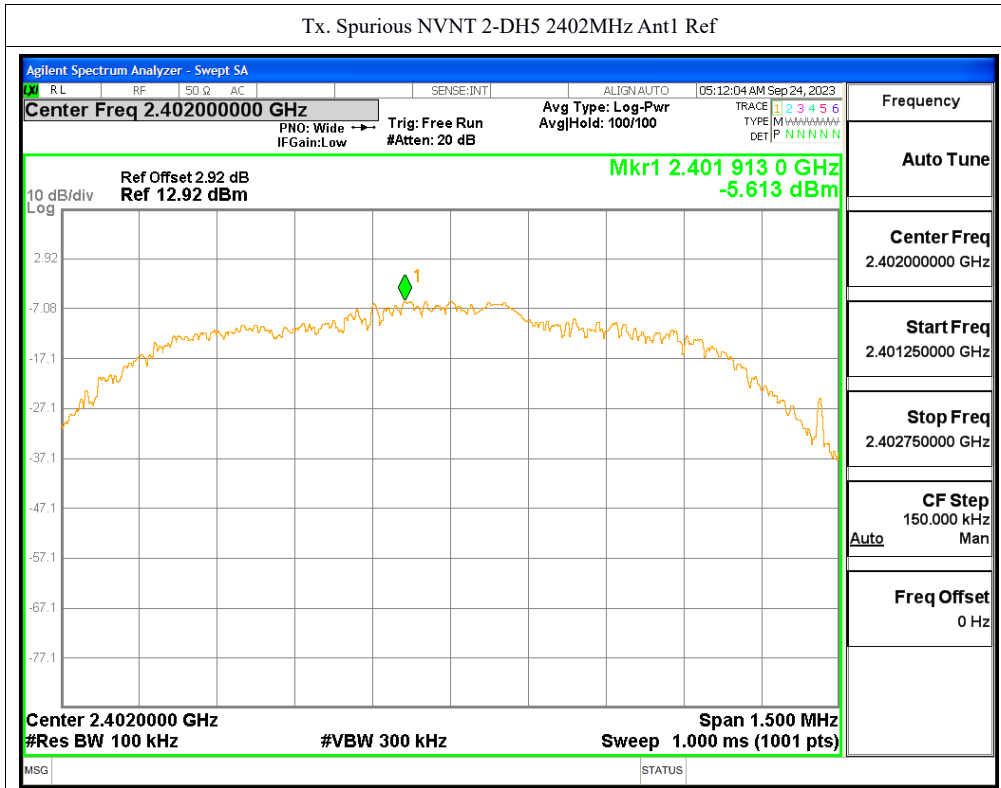

The report refers only to the sample tested and does not apply to the bulk.

This report is issued in confidence to the client and it will be strictly treated as such by the SHENZHEN TIMEWAY TESTING LABORATORIES. It may not be reproduced rather in its entirety or in part and it may not be used for advertising. The client to whom the report is issued may, however, show or send it, or a certified copy thereof prepared by the SHENZHEN TIMEWAY TESTING LABORATORIES, to his customer. Supplier or others persons directly concerned. SHENZHEN TIMEWAY TESTING LABORATORIES, will not, without the consent of the client enter into any discussion of correspondence with any third party concerning the contents of the report.

In the event of the improper use of the report. The SHENZHEN TIMEWAY TESTING LABORATORIES, reserves the rights to withdraw it and to adopt any other remedies which may be appropriate.

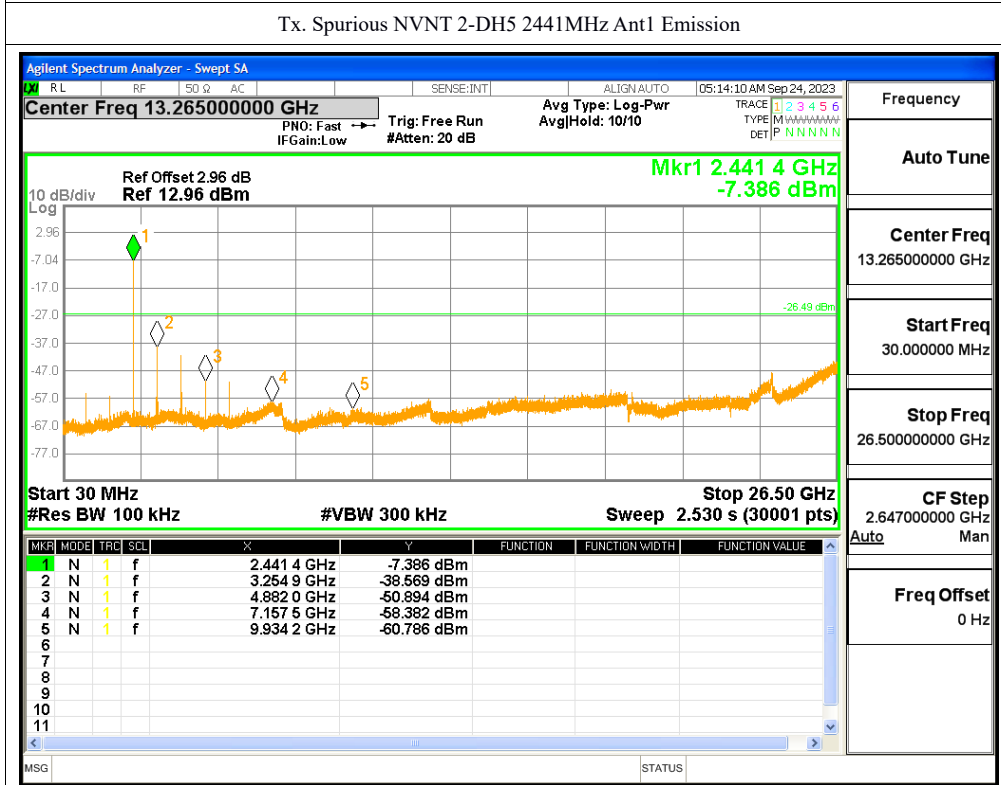
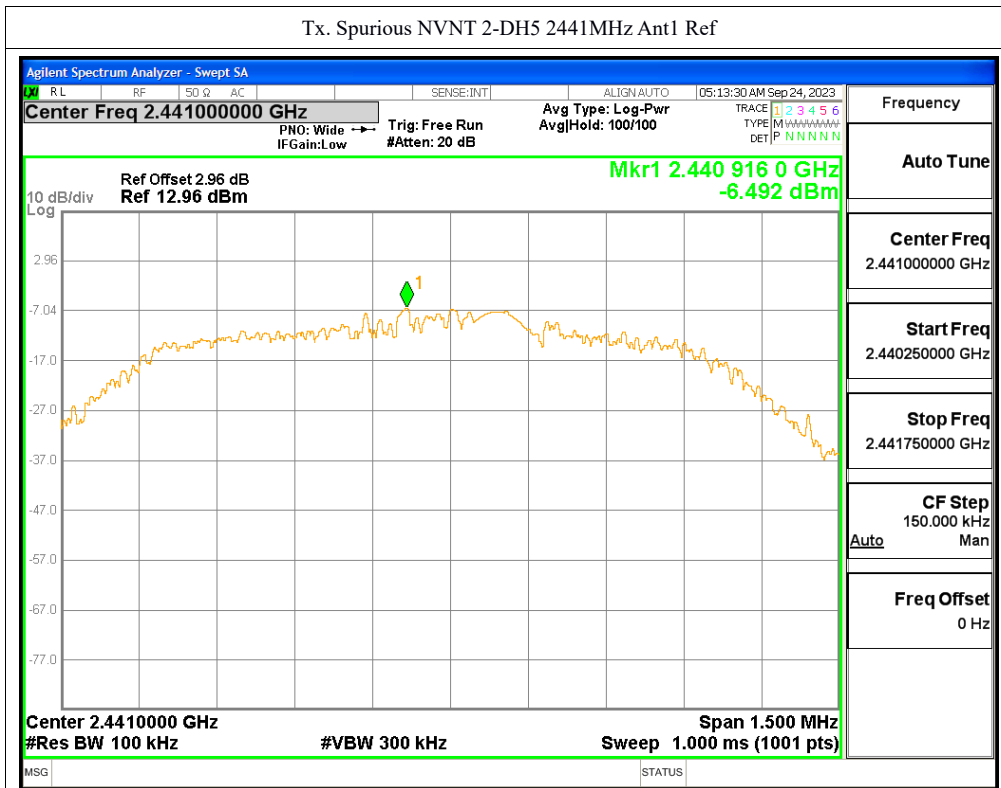

The report refers only to the sample tested and does not apply to the bulk.  
 This report is issued in confidence to the client and it will be strictly treated as such by the SHENZHEN TIMEWAY TESTING LABORATORIES. It may not be reproduced rather in its entirety or in part and it may not be used for advertising. The client to whom the report is issued may, however, show or send it, or a certified copy thereof prepared by the SHENZHEN TIMEWAY TESTING LABORATORIES, to his customer. Supplier or others persons directly concerned. SHENZHEN TIMEWAY TESTING LABORATORIES, will not, without the consent of the client enter into any discussion of correspondence with any third party concerning the contents of the report.  
 In the event of the improper use of the report. The SHENZHEN TIMEWAY TESTING LABORATORIES, reserves the rights to withdraw it and to adopt any other remedies which may be appropriate.

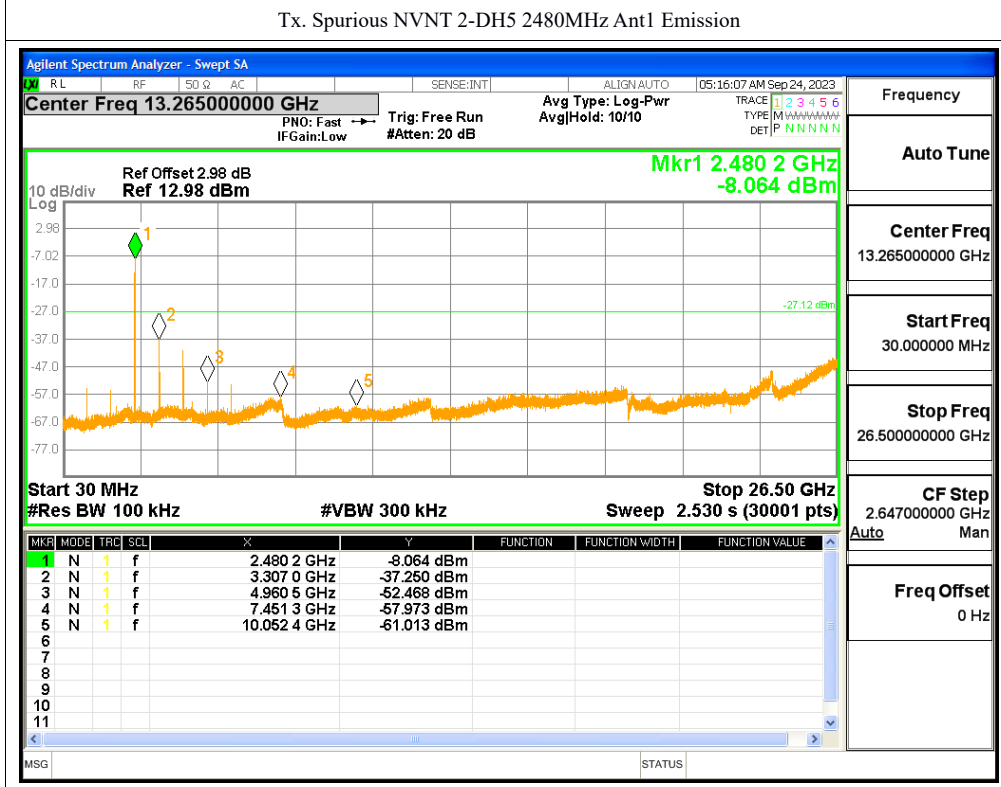
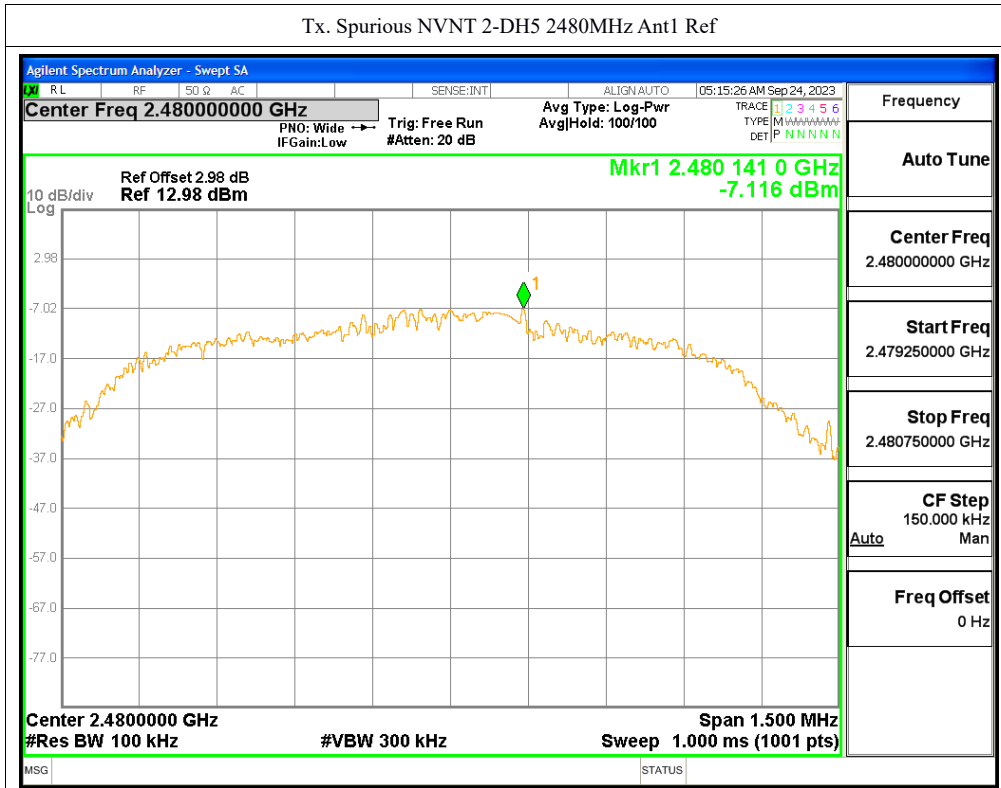

The report refers only to the sample tested and does not apply to the bulk.

This report is issued in confidence to the client and it will be strictly treated as such by the SHENZHEN TIMEWAY TESTING LABORATORIES. It may not be reproduced rather in its entirety or in part and it may not be used for advertising. The client to whom the report is issued may, however, show or send it, or a certified copy thereof prepared by the SHENZHEN TIMEWAY TESTING LABORATORIES, to his customer. Supplier or others persons directly concerned. SHENZHEN TIMEWAY TESTING LABORATORIES, will not, without the consent of the client enter into any discussion of correspondence with any third party concerning the contents of the report.

In the event of the improper use of the report. The SHENZHEN TIMEWAY TESTING LABORATORIES, reserves the rights to withdraw it and to adopt any other remedies which may be appropriate.

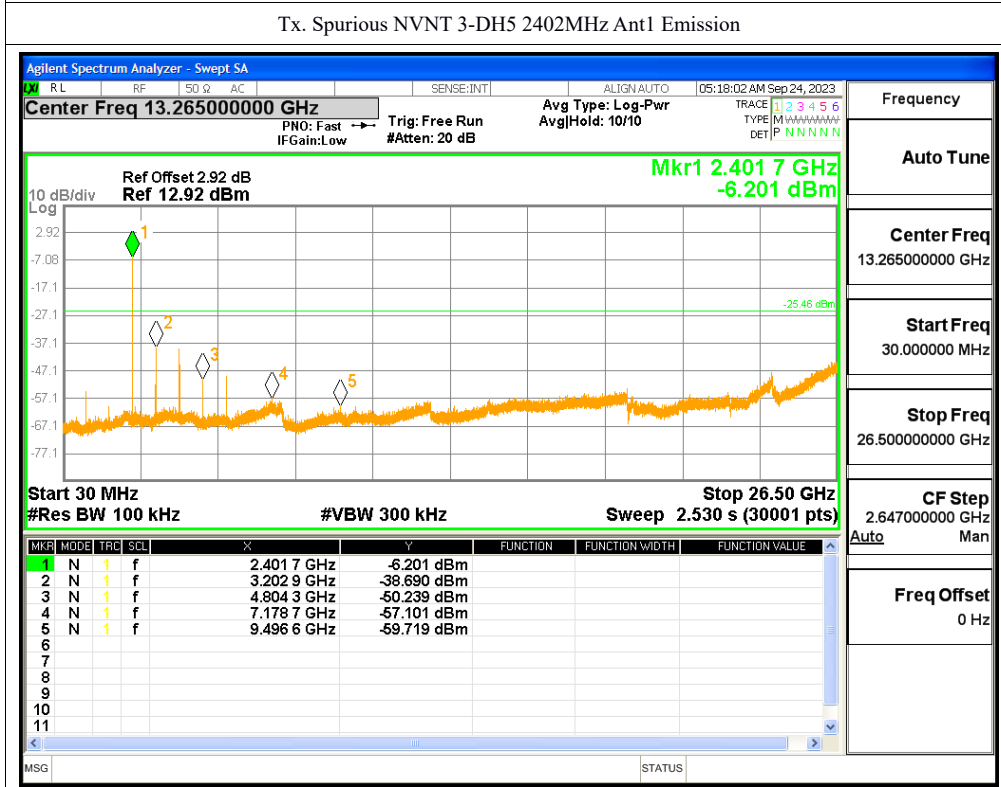
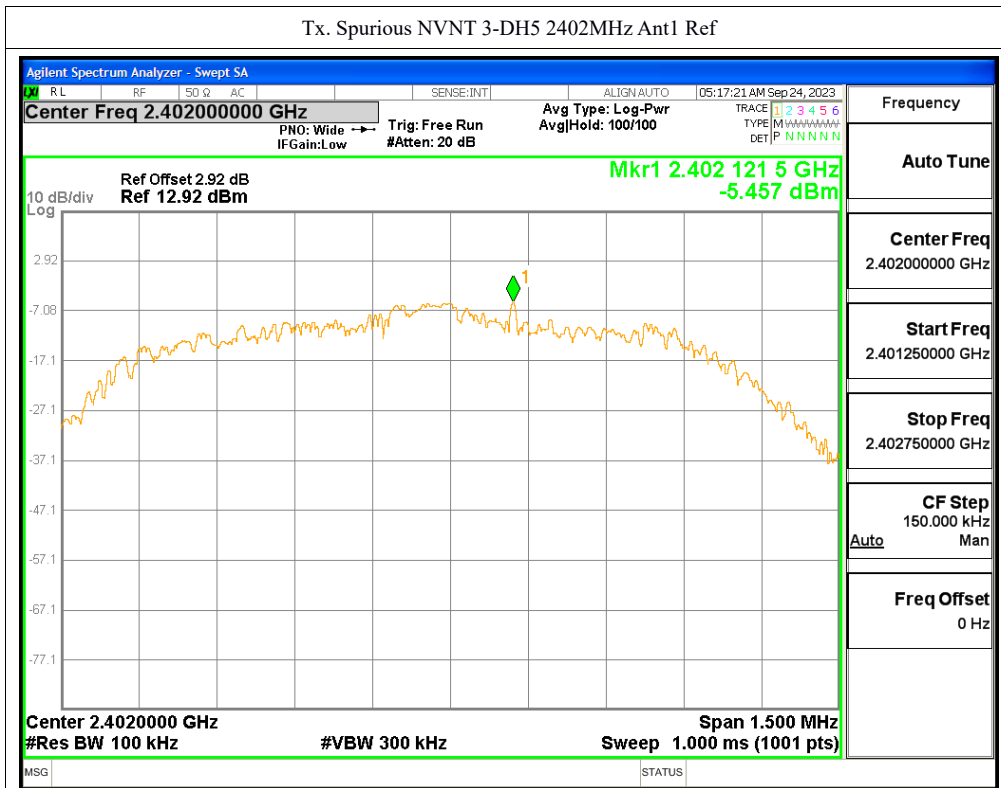

The report refers only to the sample tested and does not apply to the bulk.  
 This report is issued in confidence to the client and it will be strictly treated as such by the SHENZHEN TIMEWAY TESTING LABORATORIES. It may not be reproduced rather in its entirety or in part and it may not be used for advertising. The client to whom the report is issued may, however, show or send it, or a certified copy thereof prepared by the SHENZHEN TIMEWAY TESTING LABORATORIES, to his customer. Supplier or others persons directly concerned. SHENZHEN TIMEWAY TESTING LABORATORIES, will not, without the consent of the client enter into any discussion of correspondence with any third party concerning the contents of the report.  
 In the event of the improper use of the report. The SHENZHEN TIMEWAY TESTING LABORATORIES, reserves the rights to withdraw it and to adopt any other remedies which may be appropriate.

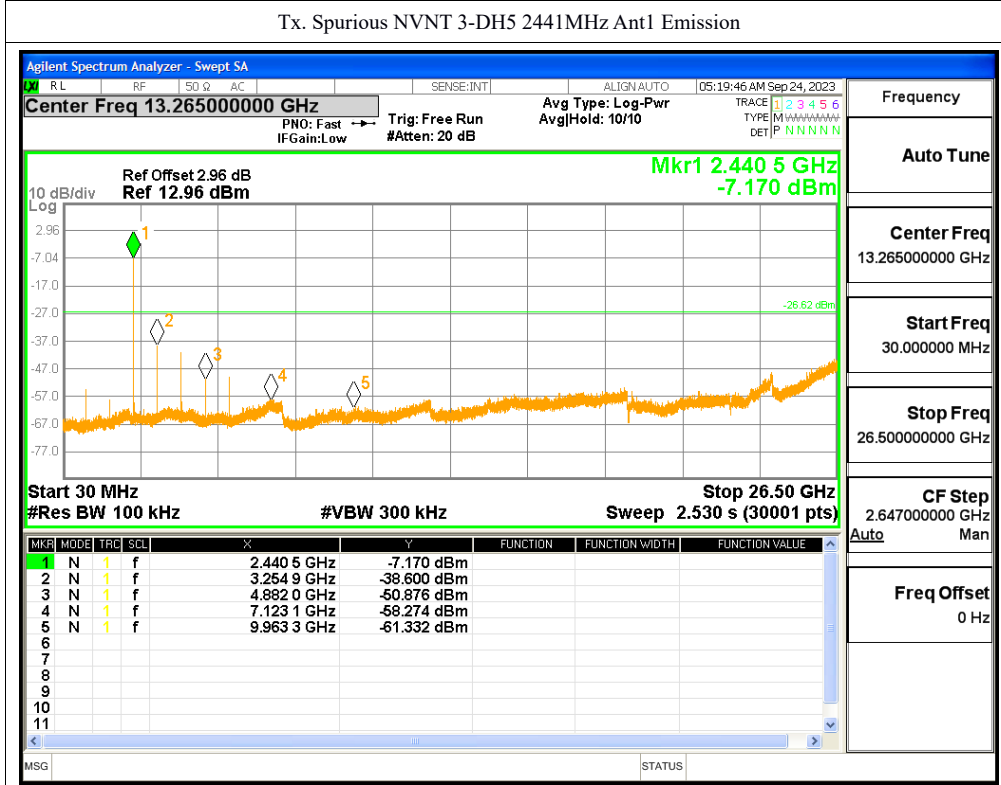
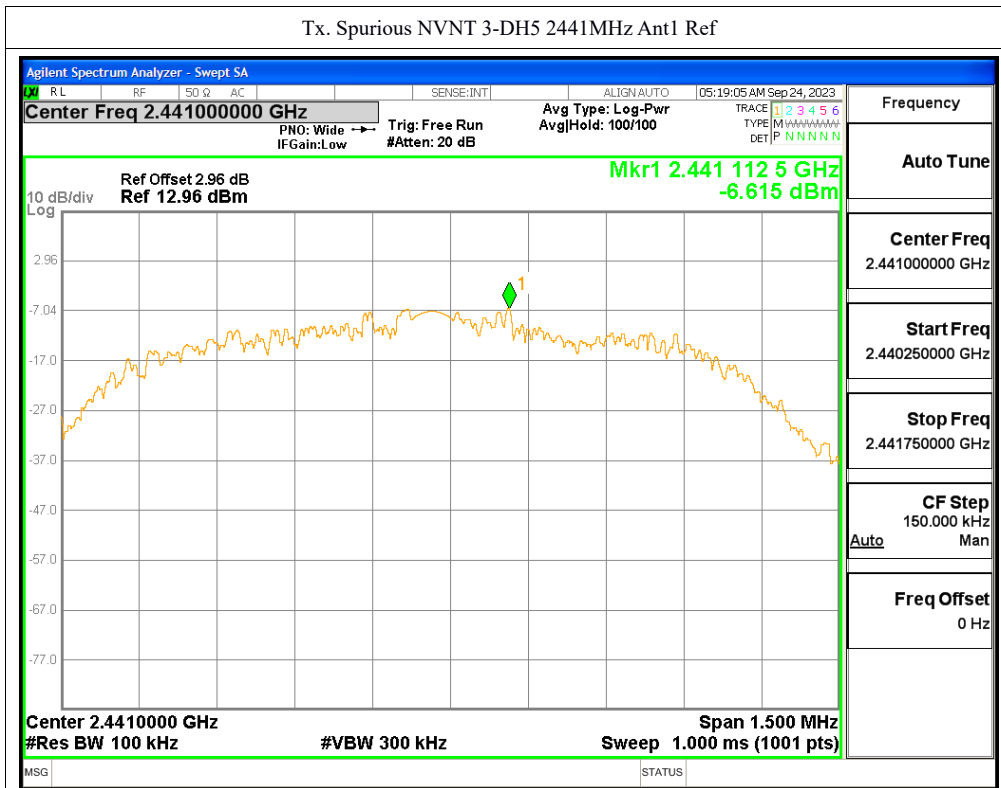

The report refers only to the sample tested and does not apply to the bulk.  
 This report is issued in confidence to the client and it will be strictly treated as such by the SHENZHEN TIMEWAY TESTING LABORATORIES. It may not be reproduced rather in its entirety or in part and it may not be used for advertising. The client to whom the report is issued may, however, show or send it, or a certified copy thereof prepared by the SHENZHEN TIMEWAY TESTING LABORATORIES, to his customer. Supplier or others persons directly concerned. SHENZHEN TIMEWAY TESTING LABORATORIES, will not, without the consent of the client enter into any discussion of correspondence with any third party concerning the contents of the report.  
 In the event of the improper use of the report. The SHENZHEN TIMEWAY TESTING LABORATORIES, reserves the rights to withdraw it and to adopt any other remedies which may be appropriate.



Tx. Spurious NVNT 3-DH5 2480MHz Ant1 Ref

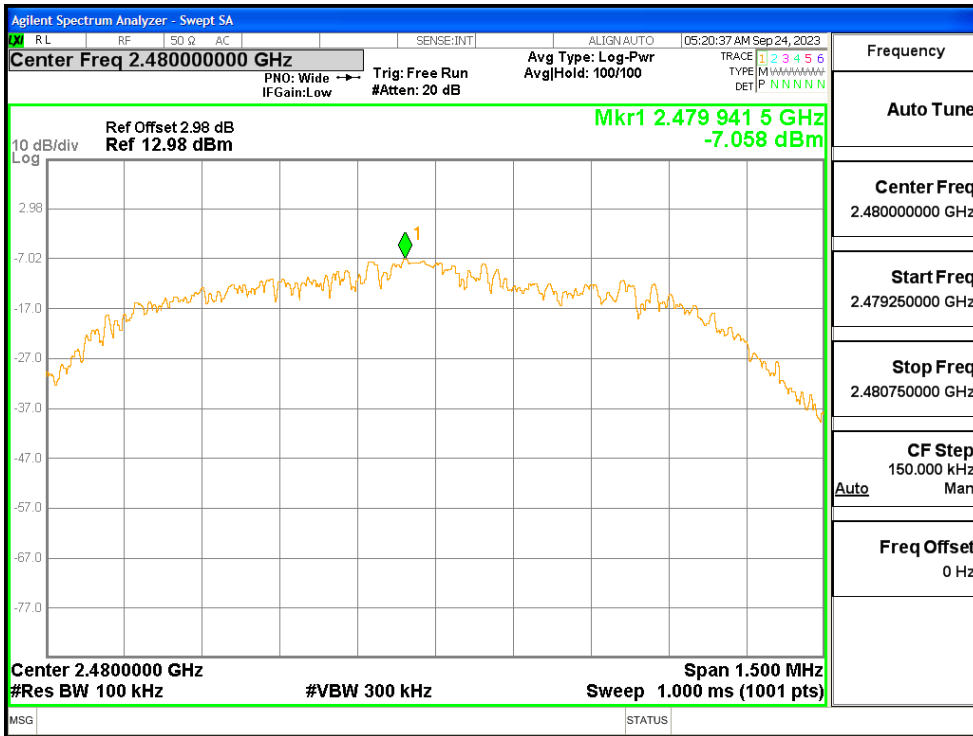

Tx. Spurious NVNT 3-DH5 2480MHz Ant1 Emission

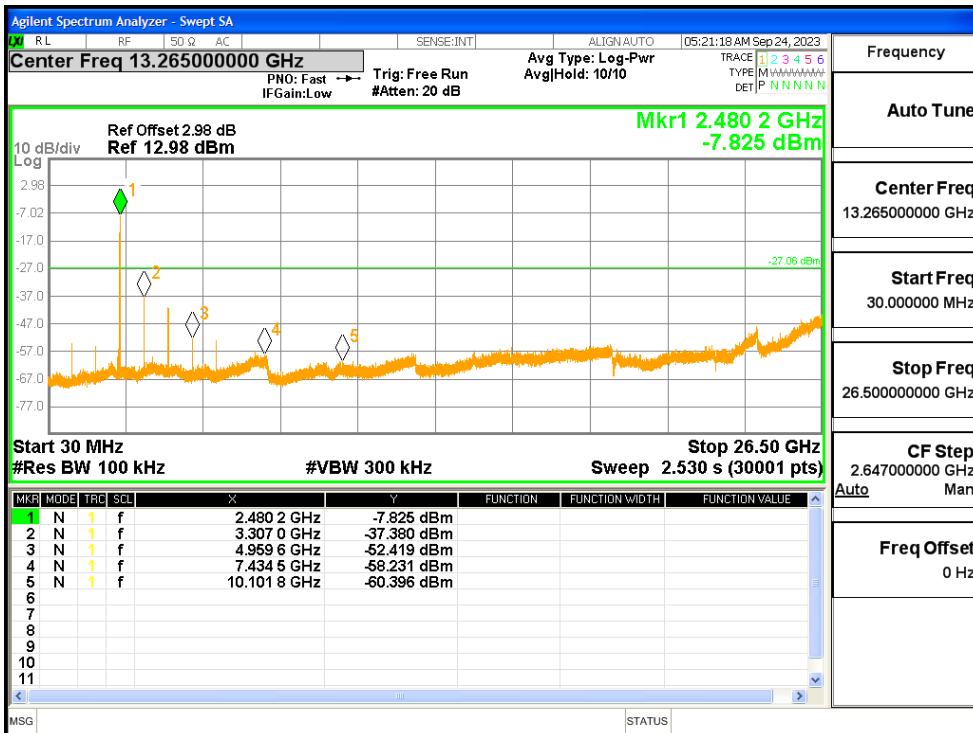

The report refers only to the sample tested and does not apply to the bulk.

This report is issued in confidence to the client and it will be strictly treated as such by the SHENZHEN TIMEWAY TESTING LABORATORIES. It may not be reproduced rather in its entirety or in part and it may not be used for advertising. The client to whom the report is issued may, however, show or send it, or a certified copy thereof prepared by the SHENZHEN TIMEWAY TESTING LABORATORIES, to his customer. Supplier or others persons directly concerned. SHENZHEN TIMEWAY TESTING LABORATORIES, will not, without the consent of the client enter into any discussion of correspondence with any third party concerning the contents of the report.

In the event of the improper use of the report. The SHENZHEN TIMEWAY TESTING LABORATORIES, reserves the rights to withdraw it and to adopt any other remedies which may be appropriate.





**12.5 Restricted band Measurement**

EUT	Cutting Plotter		Model	MINI XR
Mode	Keeping Transmitting		Test Voltage	120V~
Temperature	24 deg. C,		Humidity	56% RH
Test Result:	Pass		Detector	PK
GFSK Modulation, Low Channel, Horizontal				
2390	PK (dB $\mu$ V/m)	41.05	Limit	74(dB $\mu$ V/m)
	AV (dB $\mu$ V/m)	--		54(dB $\mu$ V/m)
GFSK Modulation, Low Channel, Vertical				
2390	PK (dB $\mu$ V/m)	38.53	Limit	74(dB $\mu$ V/m)
	AV (dB $\mu$ V/m)	--		54(dB $\mu$ V/m)

**12.5 Restricted band Measurement**

EUT	Cutting Plotter		Model	MINI XR
Mode	Keeping Transmitting		Test Voltage	120V~
Temperature	24 deg. C,		Humidity	56% RH
Test Result:	Pass		Detector	PK
GFSK Modulation, High Channel, Horizontal				
2483.5	PK (dB $\mu$ V/m)	40.63	Limit	74(dB $\mu$ V/m)
	AV (dB $\mu$ V/m)	--		54(dB $\mu$ V/m)
GFSK Modulation, High Channel, Vertical				
2483.5	PK (dB $\mu$ V/m)	38.29	Limit	74(dB $\mu$ V/m)
	AV (dB $\mu$ V/m)	--		54(dB $\mu$ V/m)

The report refers only to the sample tested and does not apply to the bulk.

This report is issued in confidence to the client and it will be strictly treated as such by the SHENZHEN TIMEWAY TESTING LABORATORIES. It may not be reproduced rather in its entirety or in part and it may not be used for advertising. The client to whom the report is issued may, however, show or send it or a certified copy thereof prepared by the SHENZHEN TIMEWAY TESTING LABORATORIES to his customer. Supplier or others persons directly concerned. SHENZHEN TIMEWAY TESTING LABORATORIES will not, without the consent of the client enter into any discussion of correspondence with any third party concerning the contents of the report.

In the event of the improper use of the report. The SHENZHEN TIMEWAY TESTING LABORATORIES reserves the rights to withdraw it and to adopt any other remedies which may be appropriate.



**12.5 Restricted band Measurement**

EUT	Cutting Plotter		Model	MINI XR
Mode	Keeping Transmitting		Test Voltage	120V~
Temperature	24 deg. C,		Humidity	56% RH
Test Result:	Pass		Detector	PK
π/4DQPSK, Low Channel, Horizontal				
2390	PK (dBμV/m)	40.85	Limit	74(dBμV/m)
	AV (dBμV/m)	--		54(dBμV/m)
π/4DQPSK, Low Channel Vertical				
2390	PK (dBμV/m)	39.23	Limit	74(dBμV/m)
	AV (dBμV/m)	--		54(dBμV/m)

**12.5 Restricted band Measurement**

EUT	Cutting Plotter		Model	MINI XR
Mode	Keeping Transmitting		Test Voltage	120V~
Temperature	24 deg. C,		Humidity	56% RH
Test Result:	Pass		Detector	PK
π/4DQPSK, High Channel, Horizontal				
2483.5	PK (dBμV/m)	40.27	Limit	74(dBμV/m)
	AV (dBμV/m)	--		54(dBμV/m)
π/4DQPSK, High Channel, Vertical				
2483.5	PK (dBμV/m)	38.76	Limit	74(dBμV/m)
	AV (dBμV/m)	--		54(dBμV/m)

The report refers only to the sample tested and does not apply to the bulk.  
 This report is issued in confidence to the client and it will be strictly treated as such by the SHENZHEN TIMEWAY TESTING LABORATORIES. It may not be reproduced rather in its entirety or in part and it may not be used for advertizing. The client to whom the report is issued may, however, show or send it . or a certified copy there of prepared by the SHENZHEN TIMEWAY TESTING LABORATORIES. to his customer. Supplier or others persons directly concerned. SHENZHEN TIMEWAY TESTING LABORATORIES. will not, without the consent of the client enter into any discussion of correspondence with any third party concerning the contents of the report.  
 In the event of the improper use of the report. The SHENZHEN TIMEWAY TESTING LABORATORIES. reserves the rights to withdraw it and to adopt any other remedies which may be appropriate.



**12.5 Restricted band Measurement**

EUT	Cutting Plotter		Model	MINI XR
Mode	Keeping Transmitting		Test Voltage	120V~
Temperature	24 deg. C,		Humidity	56% RH
Test Result:	Pass		Detector	PK
8DPSK modulation, Low Channel, Horizontal				
2390	PK (dB $\mu$ V/m)	40.86	Limit	74(dB $\mu$ V/m)
	AV (dB $\mu$ V/m)	--		54(dB $\mu$ V/m)
8DPSK modulation, Low Channel Vertical				
2390	PK (dB $\mu$ V/m)	40.11	Limit	74(dB $\mu$ V/m)
	AV (dB $\mu$ V/m)	--		54(dB $\mu$ V/m)

**12.5 Restricted band Measurement**

EUT	Cutting Plotter		Model	MINI XR
Mode	Keeping Transmitting		Test Voltage	120V~
Temperature	24 deg. C,		Humidity	56% RH
Test Result:	Pass		Detector	PK
8DPSK modulation, High Channel, Horizontal				
2483.5	PK (dB $\mu$ V/m)	40.38	Limit	74(dB $\mu$ V/m)
	AV (dB $\mu$ V/m)	--		54(dB $\mu$ V/m)
8DPSK modulation, High Channel, Vertical				
2483.5	PK (dB $\mu$ V/m)	38.52	Limit	74(dB $\mu$ V/m)
	AV (dB $\mu$ V/m)	--		54(dB $\mu$ V/m)

The report refers only to the sample tested and does not apply to the bulk.  
 This report is issued in confidence to the client and it will be strictly treated as such by the SHENZHEN TIMEWAY TESTING LABORATORIES. It may not be reproduced rather in its entirety or in part and it may not be used for advertising. The client to whom the report is issued may, however, show or send it . or a certified copy there of prepared by the SHENZHEN TIMEWAY TESTING LABORATORIES. to his customer. Supplier or others persons directly concerned. SHENZHEN TIMEWAY TESTING LABORATORIES. will not, without the consent of the client enter into any discussion of correspondence with any third party concerning the contents of the report.  
 In the event of the improper use of the report. The SHENZHEN TIMEWAY TESTING LABORATORIES. reserves the rights to withdraw it and to adopt any other remedies which may be appropriate.



## 13.0 Antenna Requirement

### 13.1 Standard Applicable

For intentional device, according to FCC 47 CFR Section 15.203, an intentional radiator shall be designed to ensure that no antenna other than that furnished by the responsible party shall be used with the device.

And according to FCC 47 CFR Section 15.247 (b), if transmitter antennas of directional gain greater than 6 dBi are used, the power shall be reduced by the amount in dB that the directional gain of the antenna exceeds 6 dBi.

### 13.2 Antenna Connected constructions

PCB antenna used. The gain of the antennas is -0.1dBi (Get from the antenna specification provided the manufacturer)

The report refers only to the sample tested and does not apply to the bulk.

This report is issued in confidence to the client and it will be strictly treated as such by the SHENZHEN TIMEWAY TESTING LABORATORIES. It may not be reproduced rather in its entirety or in part and it may not be used for advertising. The client to whom the report is issued may, however, show or send it or a certified copy thereof prepared by the SHENZHEN TIMEWAY TESTING LABORATORIES to his customer. Supplier or others persons directly concerned. SHENZHEN TIMEWAY TESTING LABORATORIES will not, without the consent of the client enter into any discussion of correspondence with any third party concerning the contents of the report.

In the event of the improper use of the report. The SHENZHEN TIMEWAY TESTING LABORATORIES reserves the rights to withdraw it and to adopt any other remedies which may be appropriate.



#### 14.0 FCC ID Label

##### FCC ID: 2AVGR-MINIXR

This device complies with Part 15 of the FCC Rules. Operation is subject to the following two conditions: (1) this device may not cause harmful interference, and (2) this device must accept any interference received, including interference that may cause undesired operation

The label must not be a stick-on paper label. The label on these products must be permanently affixed to the product and readily visible at the time of purchase and must last the expected lifetime of the equipment not be readily detachable.

##### Mark Location:



The report refers only to the sample tested and does not apply to the bulk.

This report is issued in confidence to the client and it will be strictly treated as such by the SHENZHEN TIMEWAY TESTING LABORATORIES. It may not be reproduced rather in its entirety or in part and it may not be used for advertising. The client to whom the report is issued may, however, show or send it, or a certified copy thereof prepared by the SHENZHEN TIMEWAY TESTING LABORATORIES, to his customer. Supplier or others persons directly concerned. SHENZHEN TIMEWAY TESTING LABORATORIES, will not, without the consent of the client enter into any discussion of correspondence with any third party concerning the contents of the report.

In the event of the improper use of the report. The SHENZHEN TIMEWAY TESTING LABORATORIES, reserves the rights to withdraw it and to adopt any other remedies which may be appropriate.



## 15.0 Photo of testing

Conducted Emission Test Setup:

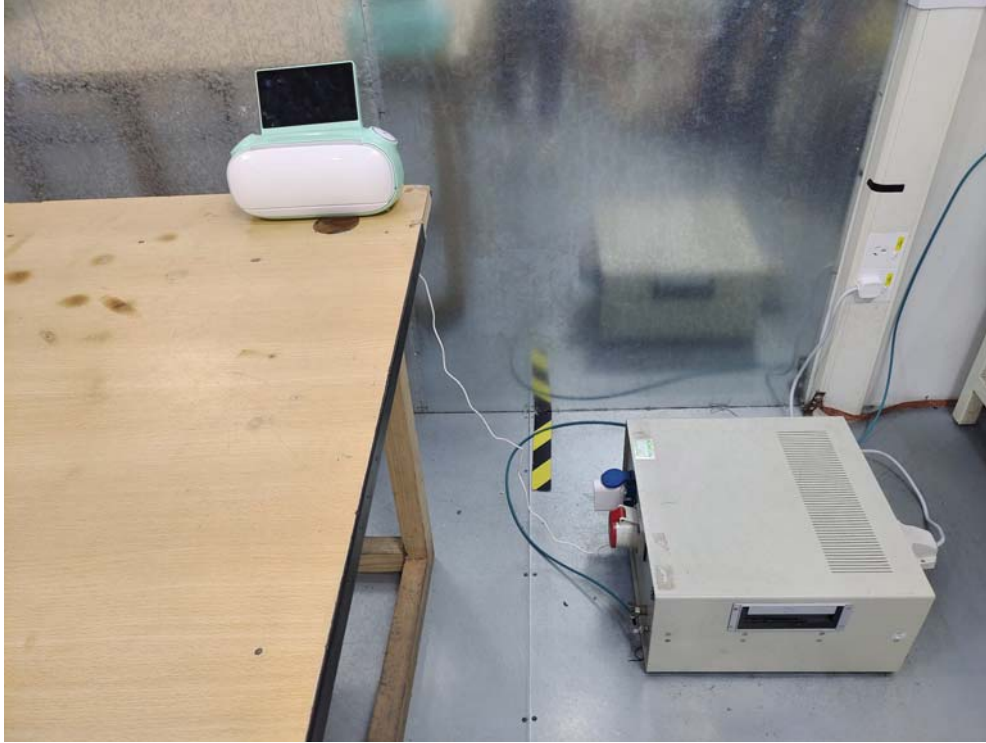

The report refers only to the sample tested and does not apply to the bulk.

This report is issued in confidence to the client and it will be strictly treated as such by the SHENZHEN TIMEWAY TESTING LABORATORIES. It may not be reproduced rather in its entirety or in part and it may not be used for advertising. The client to whom the report is issued may, however, show or send it or a certified copy thereof prepared by the SHENZHEN TIMEWAY TESTING LABORATORIES to his customer. Supplier or others persons directly concerned. SHENZHEN TIMEWAY TESTING LABORATORIES will not, without the consent of the client enter into any discussion of correspondence with any third party concerning the contents of the report.

In the event of the improper use of the report. The SHENZHEN TIMEWAY TESTING LABORATORIES reserves the rights to withdraw it and to adopt any other remedies which may be appropriate.



Radiated Emission Test Setup:

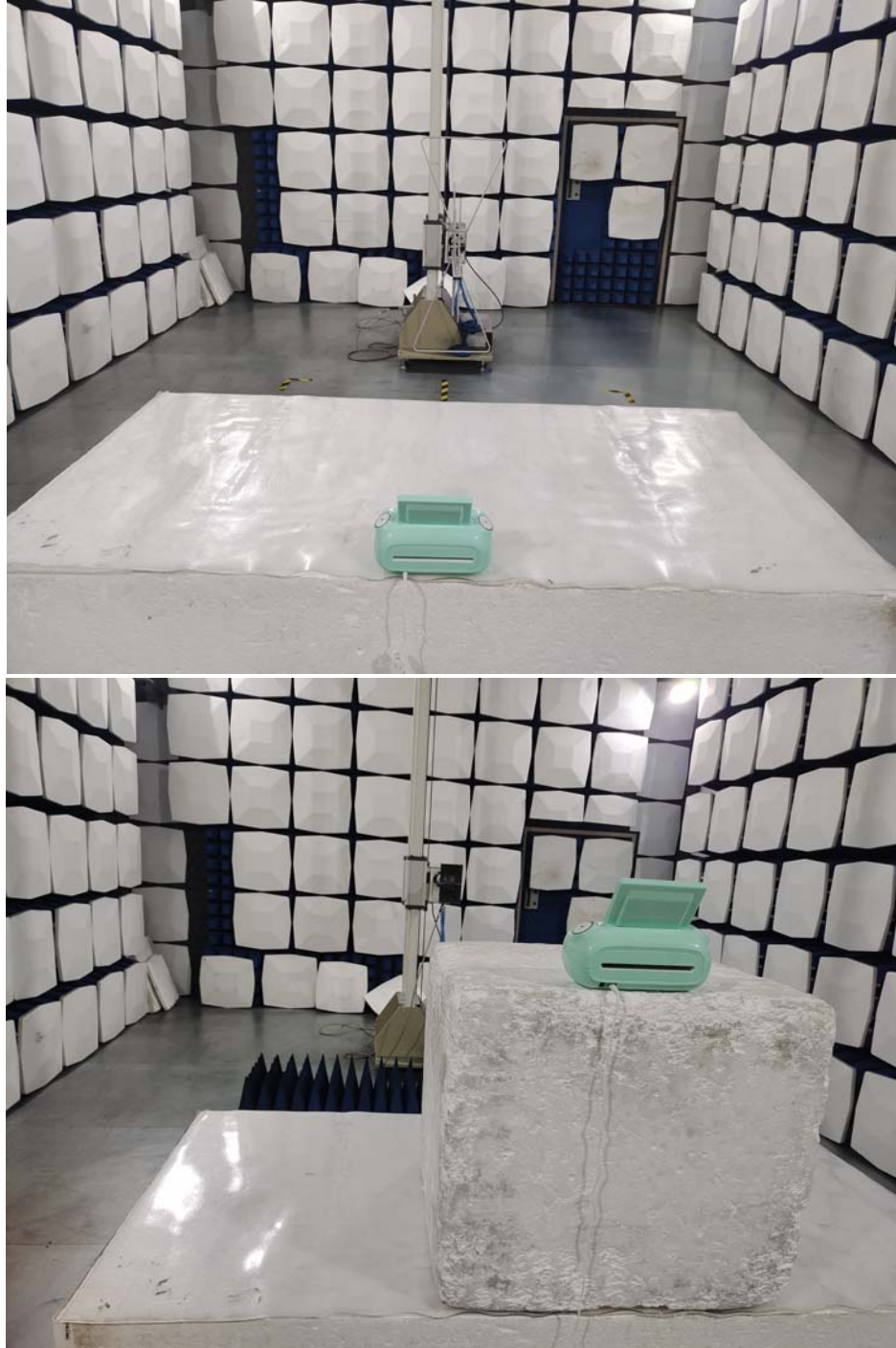

**Photographs – EUT**

Please refer test report TW2309162-01E

**End of Report**

The report refers only to the sample tested and does not apply to the bulk.

This report is issued in confidence to the client and it will be strictly treated as such by the SHENZHEN TIMEWAY TESTING LABORATORIES. It may not be reproduced rather in its entirety or in part and it may not be used for advertising. The client to whom the report is issued may, however, show or send it, or a certified copy thereof prepared by the SHENZHEN TIMEWAY TESTING LABORATORIES, to his customer. Supplier or others persons directly concerned. SHENZHEN TIMEWAY TESTING LABORATORIES, will not, without the consent of the client enter into any discussion of correspondence with any third party concerning the contents of the report. In the event of the improper use of the report. The SHENZHEN TIMEWAY TESTING LABORATORIES, reserves the rights to withdraw it and to adopt any other remedies which may be appropriate.